

Billboard

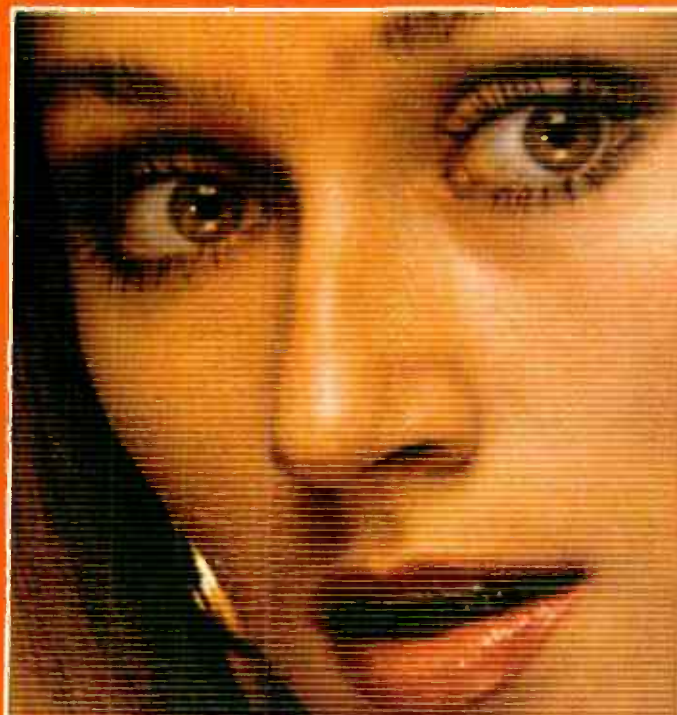

INTERNATIONAL
**AUDIO
VIDEO
TAPE**
DIRECTORY

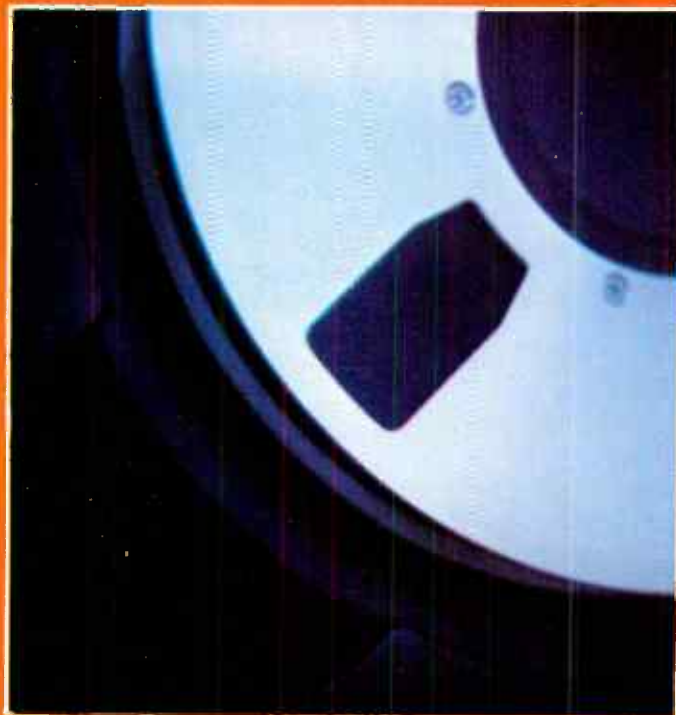

MAY 23, 1981

MAXELL HIGH GRADE VIDEOTAPE DELIVERS THE BEST PROFIT PICTURE.



Videotape customers are no longer just looking at cost.

Once they understand the value of our high grade VHS videotape, they're willing to pay the premium price.

Since Maxell *Epitaxial* HG has been on the market, it has generated impressive high profit business. Dealers have found that they can easily sell their customers up when they explain why the new lower recording speeds require this better grade tape.

At Maxell, we understand the importance of educating the consumer on the needs of today's new, more sophisticated hardware. When he understands why standard tape that performs well in the 2-hour mode doesn't perform as well in the 4 and 6-hour modes, the more he'll want to switch to high grade tape.

That's why we're offering dealers a comprehensive program on educating customers. This year

Maxell will be conducting sessions for your sales staff on how to communicate the advantages of buying Maxell high grade tape. We'll also help you build interest at point-of-purchase with exciting and informational in-store displays, merchandising aids and take-home brochures.

Right now Maxell is already offering the best profit picture in the videotape market.

Educate your customer and you can make that picture even brighter.

maxell
IT'S WORTH IT.

Maxell Corporation of America, 60 Oxford Drive, Mahanoch, N.J. 07074

Billboard

CONTENTS

Audio/Video/Tape Equipment	
Manufacturers & Importers	9
Pre-recorded Video Suppliers.....	19
Independent Video Producers	21
Accessories Manufacturers & Importers	23
Blank Loaded Tape & Accessories	
Wholesalers	28
Store Fixture Manufacturers & Importers.....	31
Tape Services	
1 Design & Artwork/Printing & Lithographing	33
2 Custom Duplicators/Packaging & Labeling	36
3 Duplicator/Marketers of 8-tr., Cassette & Open Reel	85
Tape Supplies	
4 Parts, Cartridge & Cassette, Manufacturers	43

5 Empty Cartridge, Cassette & Reel Manufacturers	44
6 Tape, Blank Loaded, Manufacturers	48
7 Tape, Bulk Raw, Manufacturers	52
8 Duplicating & Processing Equipment Manufacturers & Importers	54
9 Professional Tape Supplies Manufacturers & Importers	56
10 Packaging & Labeling Equipment Manufacturers & Importers	58
International	60
Australia	60
Belgium	61
Canada	61
France	63
German Federal Republic (West)	65
Italy	67
Japan	72
Mexico	73
Netherlands	74
Switzerland	75
United Kingdom	76

INTERNATIONAL AUDIO VIDEO TAPE DIRECTORY

THE HOME VIDEO EXPLOSION continues to fuel what now appears to be an almost insatiable consumer/industrial appetite for blank tape.

It's estimated that calendar 1980 saw blank videotape sales of near 15 million units. That translates into a retail sales figure in excess of \$300 million!

The 1981 projections envision blank videotape sales rising to 25 million units, up 70%, with the retail sales picture in excess of \$500 million, up over 50%.

On the pre-recorded videocassette side, sales were estimated at 2.5-3 million units in 1980. In 1981 the numbers are expected to measure twice that—5 million. Blank tape manufacturers should be able to keep pace with demand as most have foreseen the demand and have increased production capacity.

Naturally the upsurge in demand for videotape is closely related to video hardware sales. In 1980 VCR sales—both major consumer formats, Beta & VHS—were estimated at a cool million units. 1981 looks to 1.5 million units.

Some industry observers believe even these projections may be too conservative. The reason: the 1981 launch of the RCA SelectaVision videodisk system. With the Magnavox/Pioneer optical laser camp already establishing itself and the third rival Matsushita/JVC/Thorn/GE system set to enter in late 1981, it's felt that an already heightened awareness of video will further intensify.

Other competitors on the video horizon promise to bring even more hardware/software formats into the battle—LVR, Philips V-2000 and Technicolor quarter-inch formats to name a few.

Blank audio tape also continues to swell by leaps and bounds, although still somewhat shrouded by the home taping controversy currently sweeping the globe. Blank cassettes are expected to come in at near 400 million units for 1980—over \$600 million at retail. 1981 is expected to generate sales close to 425 million units.

As with videotape, there seems to be a parallel with equipment sales. One of the brighter sales spots in consumer electronics has been sales of home cassette decks, and

the newcomers—lightweight portable stereo headphone players in the Sony Walkman mold.

Beyond the projections, however, which comprise only a part of the marketing decision making process, is access to solid, usable information. That's where Billboard's upscaled directory comes in.

Expanding with the rapid and continued growth of video, this year's directory has a new section identifying independent video production companies involved with music related projects. Information included in this important new section goes beyond the usual name, address and telephone number to include formats used and a brief description of the studio, mobile/portable and post-production facilities and equipment available.

In addition to keeping pace with the rapidly expanding domestic audio/video market, this year's directory adds an 11th burgeoning international marketplace—Australia. This, combined with the expanded number and scope of equipment, service and supply listings will make this year's Audio/Video/Tape Directory even more invaluable.

JIM McCULLAUGH

Publisher: Lee Zhitto (L.A.)
Editor-In-Chief: Gerry Wood (N.Y.)

DIRECTORY STAFF

Editor: Earl Paige (L.A.); Assistant Editor, Susan Peterson (L.A.); Editorial Direction: Jim McCullaugh, Sound Business Editor (L.A.); Manager of Directory Services: Bob Hudoba (Cinti.); Assistant Manager of Directory Services: Lon Braude; Directory Listings Editor: Rand Rugeberg; Directory Associates: Joan Elsener, Kathy Shnurr, Roy Crosthwaite, European Listings: Mike Hennessey, Managing Director U.K. Office and Vera Madan, Assistant, Art Direction: Bernie Rollins

PUBLISHING

Associate Publishers: Tom Noonan, Bill Wardlow (L.A.); Sales Director: Tom Noonan, National Sales Manager: Ron Willman (N.Y.); Vice President European Operations: Miles Killoch (U.K.)

© Copyright 1981 Billboard Publications, Inc. All rights reserved. This work may not be copied or reproduced in any form (including but not limited to microfiche or microfilm), stored in a retrieval system or transmitted, in any form or by any means, electronic, mechanical, photocopying, recording, or otherwise, without the prior permission of the publisher.

Billboard Publications, Inc.
1515 Broadway
New York, N.Y. 10036
(212) 764-7300 Telex: 620523

2160 Patterson St.
Cincinnati, Ohio 45214
(513) 381-6450

9000 Sunset Blvd.
Los Angeles, Calif. 90069
(213) 273-7040

MAY 23, 1981 BILLBOARD

A/V/T-3

1981 BLANK TAPE PRODUCT CHART

CASSETTE

PLAYING TIME	PRODUCT	COATING	LIST PRICE
ALPHA MEDIA			
30/45/60/90	LN/HO	FO	Contract
Custom Lengths	LN/HO	FO	Contract
AMPEX			
60/90	LoNoise (352 Series)	FO	2 10/3 00
45/60/90/120	ELN (374 Series)	FO	2 20/3 00/4 10/4 90
45/60/90	EDR (377 Series)	FO	3 40/4.10/5.40
60/90	GM I (365 Series)	FO	5 40/6 70
60/90	GM II (366 Series)	CMFO	6 00/7 40
60	Metal Particle (367 Series)	Metal	12 50
30/45/60/90/120	Pro Packaged (671 Series)	GFO	73/ 90/1.04/1 54/2 62
AUDIO ACCESSORIES			
Custom	STD	HE/LN	
AUDIOMAGNETICS			
60 3-pack	Cycles	LN-F	1 29
45/60/90/120	Tracs	LN-F	99/1 09/1 69/1 99
60 3-pack	Tracs	LN-F	1 99
90 3-pack	Tracs	LN-F	2 99
45/60/90/120	High Performance I	HP-F	2 19/3 99/4 99/5 99
60/90	High Performance II	HE-F	3 99/4 99
B A S F			
60/90	Performance	LN/HO	2 79/3 99
60/90	Professional I	FO/MO/NB	3 99/5 49
60/90	Professional II	CrO ₂	4 49/5 99
60/90	Professional III	CrO ₂ /FCh	4 29/5 79
BAZZY ELECTRONICS (Custom)			
1 to 90		LN/P/NB	65 & up
CASSETTE MASTERS			
1-124	Private Label		
CERTRON			
60/90/120	Certron HE	HE	1 99/2 59/2 99
30/45/60	Certron LN	LN	99/1 09/1 19
90/120	Certron LN	LN	1 59/1 89
30/45/60	Certron HD	HD	1 29/1 39/1 59
90/120	Certron HD	HD	2 09/2 49
60/90	Ferex I	FE	3 00/3 99
30/40	Certron Mini	HE	3 99/4 99
60	Certron Micro	HE	3 99
CONTINENTAL ELECTRONICS			
45/60/90/120	High Energy	FO/HD/HE	2 59/2 79/3 59/5 79
45/60/90/120	Continental Audiophile	FO/HD/HO	3 29/3 59/4 79/6 59
D A K			
30/60/90	C series	SP/NB	.65/.77/.98
30/60/90	LNC series	LN/HO/NB	74/.88/1.12
2-92	EC series	LN/HO/NB	91 to 1.82
40/60/90	HEC series	HE/HP/NB	1.27/1.57/1.91
60/90	ML series	EHO/HE/NB	1 65/2.19
FUJI			
45/60/90	Metal tape	EHO/LN	8 30/9.10/12 00
46/60/90	Fuji FX I	FO/LN/HO	4 25/4.89/6.70
46/60/90	Fuji FX II	Beridox LN/HO	4 40/5.10/6.96
46/60/90/120	Fuji FL	FO/SLN	3.00/3.40/4.70/6.50
HITACHI			
60/90	UDEX	EC	4 00/5 50
60/90	UDER	EO	4 00/5 50
46/90	ME	Metal	8.45/9.45
HORIAN ENG'G			
60	PCI-600	GFO	3 50
90	PCI-900	GFO	4 50
IRISH MAGNETIC			
30/60/90	Irish	FS	1 50/1.75/2 15
60/90	Irish	FS	2.10/2.70
LE-BO			
60/90	Le-Bo	FO	1 69/1 99
3-pack 60/90	Le-Bo	FO	1 99/2.95
M J S			
46/62/92/122	High Bias II	C	1.85/2.25/3.00/4.50
46/62/92	Wide Dynamic	F	1.65/2.00/2.75
46/62/92/122	HO/LN	F	1.55/1.75/2.25/3.50
46/62/92	Metal	M	2.75/3.25/5 00
MAXELL			
46/60/90/120	Low Noise	GFO	2.59/2.85/4.29/5.59
46/60/90/120	Ultra Dynamic	PxGH	3.89/4.19/6.19/8.29
60/90	UD XL I	EO/CM	5 49/7.59
60/90	UD XL II	EO/CM	5 49/7.59
60/90	XLIS	EO/CM	6.40/8.65
60/90	XLIS	EO/CM	6.40/8.65
46/60/90	MX-Metal	Metaxial	11.25/12 50/14.95

MEDIA INT'L			
30/45/60/90/120	HO/LN		75/1.00/1 25/1.75/3.50
MEMOREX			
30/45/60	MRX I	FO	2.99/3.19/3.39
90/120	MRX I	FO	4.99/6 79
60/90	High Bias II	FE	4.39/5.99
60/90	Metal IV	Pure Metal	7.49/9.99
NAKAMICHI			
60/90	Nakamichi EXII	FCo	6.00/7 80
60/90	Nakamichi SX	FCo	6.30/8 00
60/90	Nakamichi ZX	Metal	9.75/13.50
R K O			
60/90	Broadcast I	F	4.10/5.75
45/60/90	RKO XD	F	2.36/2.60/3.66
60/90	Ultrachrome	C	4.20/5.99
BILL RASE PROD'NS			
C-1 thru C-92		BC	
REALISTIC (Radio Shack)			
60	Supertape	Metal	9 95
60/90	Supertape	CrO ₂	3.49/4.49
45/60/90/120	Supertape Gold	FO	2 59/2 99/3 99/4 79
30/60/90/120	Low Noise	LN	1 49/1 89/2 59/3 19
60/90	Concertape	P	88/1 25
ROBINS			
60/90	Robins Brand 5	SP	1.40/1 80
3-pack 60	Robins Brand 5	3 00	
SENTRY			
60/90	Sentry	LN/HO	.75/1.10
60/90 (3 Pak)	Sentry	LN/HO	1.50/2.25
SONY			
46/60/90/120	LNX	FO	1.95/2 15/3.10/4.00
46/60/90/120	HFX	FO	2.90/3 10/4.40/6.00
46/60/90	SHF	FO	3.30/3.70/5.00
46/60/90	EHF	FCo	3.60/4.00/5 60
46/60/90	FECR	FCh	4 20/4 60/5 90
46/60/90	Metallic	Metal	8.00/10.00/13 00
60	Micro cassette	FO	3 80
60/90	Eicassette	LN	8 00/10 60
60/90	Eicassette	FCh	10 60/12 80
SOUNDPRO			
45/60/90	SoundPro	LN/HO/NB	3 49.3 99.4 69 (2 for 1)
45/60/90	SoundPro	FO/MO/NB	2 36/2 60/3 66
SWIRE-INTERMAGNETICS			
40/60/90/120	XL	FO	.89/ 99/1 49/1 99
45/60/90/120	Laser	FO/HD	1.19/1 49/1 99/2.19
T D K			
60/90	MA-R (Metal Alloy-Reference)	Metal	14.30/19 20
60/90	MA (Metal Alloy)	Metal	10.60/14 40
60/90	SA-X	FCo/AV/SC	6.00/8.40
60/90	SA (Super Avilyn)	FCo/AV	5.25/7 40
60/90	OD (Optimum Dynamic)	EHO/LN/HP	4 70/6 60
60/90	AD (Acoustic Dynamic)	LN/HO/ER	3.85/5.60
30/45/60	D (Dynamic)	LN/HO	2.50/2.75/3.00
90/120/180	D (Dynamic)	LN/HO	4 15/5 00/7 00
20 sec /30 sec.	EC (Endless Cassette)	LN/BC	2.70/2.75
1/3/6/12	EC (Endless Cassette)	LN/BC	2.80/2.90/3.10/3.70
3M SCOTCH			
45/60/90/120	Highlander	LN	1.69/1.99/2 99/4.39
45/60/90/120	Dynarange	LN	2.79/3.29/4.59/6.39
45/60/90	Master I	HO/LN	3.79/4.09/5.39
45/60/90	Master II	HP/HF/CDeq	4.39/4.79/5.99
45/60/90	Master III	Ferrichrome	4.39/4.79/5.99
46/60/90	Metafine	Metal	7.19/7.99/10.29

PRODUCT CHART KEY

AV - Avilyn	FCh - ferric chrome	M - mastering
BC - back coated	FE - ferrite oxide	MB - master backed
C - chrome	FG - ferric gamma hematite	MO - maximum output
CD eq - chrome equivalent	FO - ferric oxide	NB - normal bias
CM - cobalt modified	FS - ferros	P - polyester
CrO - chromium dioxide	FG - gamma ferric oxide	PF - pure ferric
EC - editaxial cobalt	HB - high bias	PLN - premium low noise
EHO - extra high output	HD - high density	PxGH - Px gamma hematite
EO - epitaxial oxide	HE - high energy	SC - super coating
ER - extended range	HF - high ferric	SF - standard ferric
F - ferric	HI - high fidelity	SHF - super high fidelity
FC - ferric cobalt	HO - high output	SLN - super low noise
FCh - ferric chrome	HP - high performance	SP - standard performance
FO - ferric oxide	LN - low noise	XHE - extra high energy
* - 10 1/2" reel	** - 5" reel	*** - 14" reel

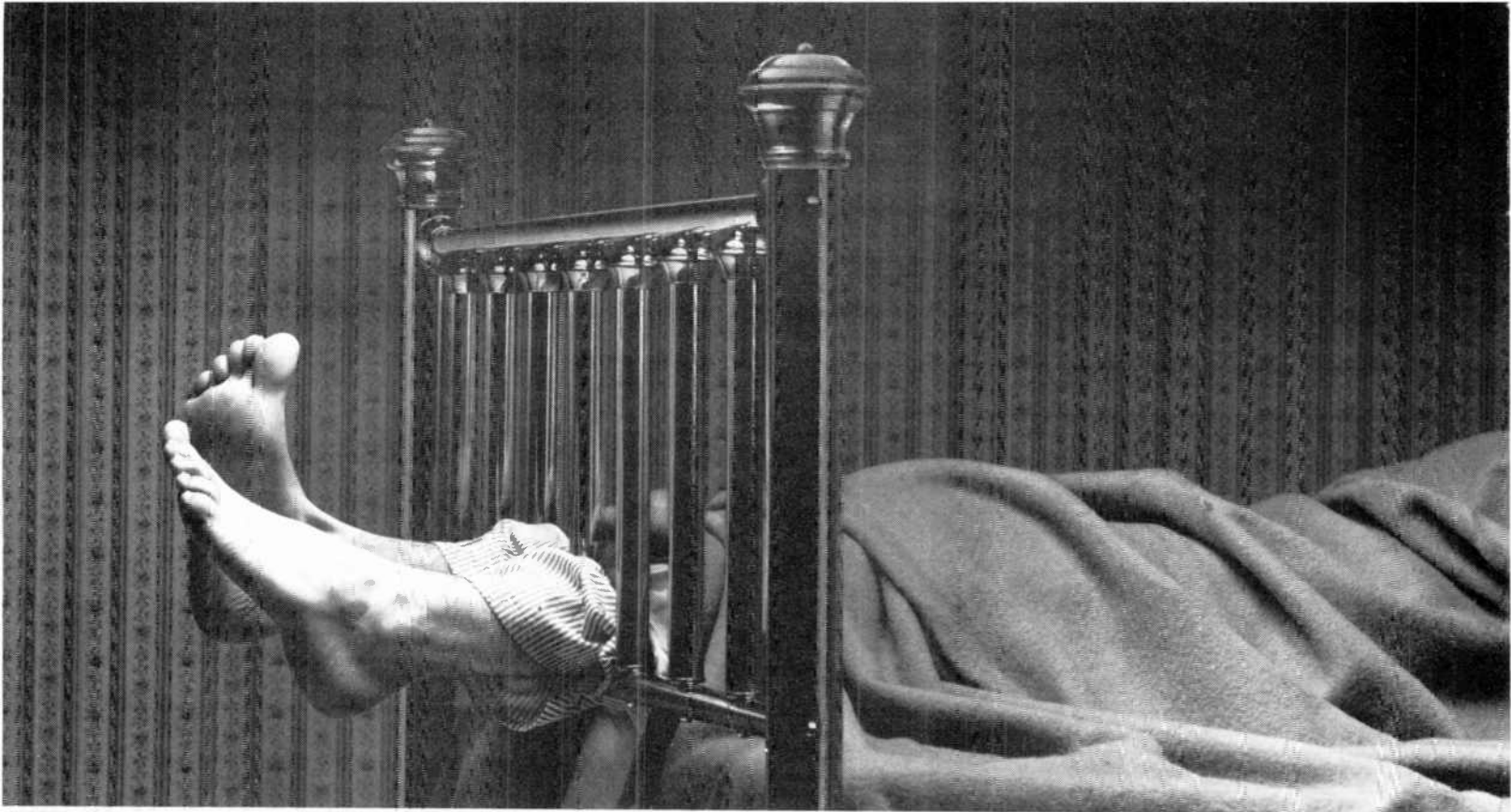

If you think "high bias" is discrimination against tall people, you're not ready for New Memorex.

High bias tape is specially formulated to deliver remarkably improved sound reproduction, particularly in the higher frequencies.

And no high bias tape does that better than totally new Memorex HIGH BIAS II.

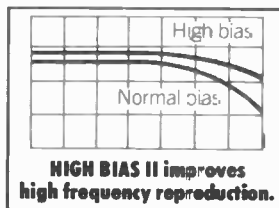

We've developed a unique new formulation of superfine ferrite crystal oxide particles. And while that's a mouthful to say, it delivers an earful of results.

Singers ring out more clearly. Snare drums snap and cymbals shimmer with startling crispness.

Even quiet passages sound clearer. Because new Memorex

HIGH BIAS II has 4 to 5 dB lower noise. Which means dramatically reduced tape hiss.

And thanks to Permapass™, our extraordinary new binding process, the music you put on the tape stays on the tape. Play after play, even after 1,000 plays.

In fact, new Memorex will always deliver true sound reproduction. Or we'll replace it. Free.

Of course, we didn't stop once we made new Memorex sound better. We also made it work better. By improving virtually every aspect of the cassette mechanism.

We even invented a unique fumble-free storage album.

So trust your next recording to

new Memorex. In HIGH BIAS II, normal bias MRX I or METAL IV.

As a discriminating tape user, you'll have a high opinion of the results.

A highly biased opinion, that is.



HOW MORE THAN EVER
WE ASK: IS IT LIVE, OR IS IT

MEMOREX



1981 BLANK TAPE PRODUCT CHART

OPEN REEL

LENGTH (00's)	PRODUCT	COATING	LIST PRICE
AGFA-GEVAERT			
24	PEM468	Iron	
48	PEM428	Iron	
36	PEM368	Iron	
24	PEM526	Iron	
AMPEX			
12/18	ELN (375/376 Series)	FO	8.70/11.20
12/18	406/407	M/FO	11.49/13.89
6**	406	M/FO	8.39
50*** (2")	406	M/FO	389.59
9* (1/4")/36* (2")	407	M/FO	9.79/226.89
12/25	GM (356 series)	FO	12.50/33.70
50*** (2")	Grand Master (456 series)	M/FO	495.19
12/25*	Grand Master (456 series)	M/FO	13.59/34.09
18/36	GM (357 Series)	FO	15.00/37.50
6**/12**/25*	631 Series	FO	4.89/7.39/22.09
9**/18**/36*	641 Series	FO	6.09/10.39/27.09
9**/18**/36*	632 Series	FO	5.39/8.09/24.59
9**/18**/36*	642 Series	FO	6.69/11.09/33.19
12**/24**	651 Series	FO	9.49/15.79
18**/24**	661 Series	FO	10.19/17.09
25 (1"/2")	Grand Master (456 series)	FO	96.59/211.59
AUDIO ACCESSORIES			
Custom (1/4")		BC	
AUDIOMAGNETICS			
12/18/24	Tracs	LN-F	5.89/6.29/6.49
BASF			
18/24	Ferro LH	LN/HO	12.99/16.99
BAZZY ELECTRONICS			
12/18		NB/HO/PLN	2.95/5.00
IRISH MAGNETIC			
12/18/22.5	Emerald	FS	3.90/4.10/6.75
12/18/24	Irish	FS	8.95/11.25/17.40
12/18	Irish	F/BC	12.25/15.25
MJS			
12/18/24*/36*	Pro Mastering	Ferric backed	4.00/5.00/12.00/10.00
12/18/24/36*	LN HO	F	3.00/4.00/8.00/10.00
12/18	LN	F	1.75/2.50
18/36*	Chrome II	C	7.00/12.00
MAXELL			
12/25/18/36	Ultra Dynamic	GFO	8.60/24.45/9.90/27.55
12/25/18/36	UOXL	CM/GFO	13.45/36.45/15.10/41.60
REALISTIC (Radio Shack)			
9**/12/18/36	Supertape	P	3.49/4.99/5.59/9.99
9**/12**/18/24/36	Low Noise	P	2.49/3.49/4.49/5.49/7.29
18	Concertape	P	2.19
SONY			
12/18/36*	ULH	FO	9.00/11.50/31.00
18/36*	FeCR	FCh	14.00/39.00
TDK			
60/90/120/180 min.	GX	EHO/HP/ER/BC	13.75/16.25/37.50/43.75
60/90/120/180 min.	LX-B	HO/HP/ER/BC	12.50/13.75/35.00/38.75
90/180 min.	LX	HO/HP/ER/LN	12.50/35.00
3M-SCOTCH			
12/18	Highlander	LN	5.49/7.59
6**/9**/18**	Dynarange	LN	4.09/4.89/8.39
12/18/24/36	Dynarange	LN	6.29/8.39/12.59/16.59
12/18	206/207	HO/LN	7.99/9.99
18/36*	Master XS	HO/LN	13.39/35.69



8-TRACK

PLAYING TIME	PRODUCT	COATING	LIST PRICE
AUDIO ACCESSORIES			
Custom	STO	BC	
AUDIOMAGNETICS			
45/90	Tracs	LN-F	1.79/2.19
45 2 pack	Tracs	LN F	2.59
90 2 pack	Tracs	LN F	3.19
45/90	High Performance I	HP F	2.59/3.29
BAZZY ELECTRONICS (Custom)			
1.0-90		NB/PLN/HO	80 & up
CERTRON			
45/65/90	Certron	LN	1.69/1.99/2.49
CONTINENTAL ELECTRONICS			
45/60/90	Continental Audiophile	FO/HO/HO	2.99/3.99/4.79
IRISH MAGNETIC			
42/45/60/90	Irish	FS	3.35/3.40/3.65/4.70
LE-BO			
40/45/80/90	Le Bo	FO	2.49/2.49/2.95/3.25
MAXELL			
46/60/90	Low Noise	GFO	4.15/4.59/5.19
MEDIA INT'L			
45/60/90		HO/LN	1.50/2.00/2.50
MEMOREX			
45/60/90	Cartridge	HO/LN	3.49/3.79/4.09
REALISTIC (Radio Shack)			
45/90	Supertape	HO/LN	2.99/3.89
40/80	Low Noise	P	1.99/2.59
SONY			
46/90	HF	FO	3.30/4.20
SOUNDPRO			
45/60/90	SoundPro	HO/LN/XHE	2.36 2.60/3.66
45/60/90	SoundPro	HO/LN	3.49/3.99/4.69 (2 for 1)
SWIRE-INTERMAGNETICS			
45/90	XL	FO	1.19/1.99
TDK			
45-90	O (Dynamic)	LN/HO	4.40/5.35
3M-SCOTCH			
45-90	Dynarange	LN	3.19/3.99
45-90	Master	HO/LN	4.29/4.99

PRODUCT CHART KEY

AV - Avilyn	FCr - ferrocristal	M - mastering
BC - back coated	FE - ferrite oxide	MB - master backed
C - chrome	FG - ferric gamma hematite	MO - maximum output
CD eq - chrome equivalent	FO - ferric oxide	NB - normal bias
CM - cobalt modified	FS - ferros	P - polyester
CoD - chromium dioxide	GFO - gamma ferric oxide	PF - pure ferric
EL - epitaxial cobalt	HB - high bias	PLN - premium low noise
EBO - extra high output	HO - high density	PxGH - Px gamma hematite
EO - epitaxial oxide	HE - high energy	SC - super coating
ER - extended range	HF - high ferric	SF - standard ferric
F - ferric	HI - high fidelity	SHI - super high fidelity
FC - ferric cobalt	HO - high output	SLN - super low noise
FCh - ferric chrome	HP - high performance	SP - standard performance
FCo - ferricobalt	LN - low noise	XHE - extra high energy

* - 1/4" reel

** - 5" reel

*** - 14" reel



The Sound Performer!

Your performance demands the finest! Get it with Agfa Studio Mastering, Video, and Bulk Cassette Tape. It's the tape that has been performing to the highest standards of artists and engineers alike; and continues to out-perform other tape— with quality, reliability, and consistency.

The Sound Performer — producing quality images for sight and sound...



**Agfa
Magnetic
Tape**

AGFA-GEVAERT, INC.
275 North Street, Teterboro, N.J. 07608
(201) 288-4100

1981 BLANK TAPE PRODUCT CHART

VIDEO

PLAYING TIME	PRODUCT	FORMAT	LIST PRICE
AGFA-GEVAERT			
30/60	PEV247	U-matic	
AMPEX			
5/60	U-matic Cassettes	Helical	23.39/45.99
30-60/60-120	1/2" (cassette)	Beta	13.49/16.95
60-120/120-240	1/2" (cassette)	VHS	17.95/24.45
16*/96***	Quadplex	High band color	73.71/373.81
34*/94**	1" Broadcast	Helical	66.45/155.81
B A S F			
L500		Beta	21.95
T120		VHS	29.95
BAZYL ELECTRONICS			
120/240	Cassette	VHS	19.00
CASSETTE MASTERS			
Custom	Studio 1/4"	U-matic	
DUPONT			
T60/T120	Primetime	VHS	17.95/24.95
L250/L500/L750	Primetime	Beta	12.95/16.95/20.95
FUJ			
10/15/20	Fuji Berridox KCA series	U-matic	22.65/25.50/27.30
30/60			28.85/37.10
10/20	Fuji Berridox KCS series	U-matic minis	22.65/27.30
T30/T60/T90/T120	Fuji Berridox HO	VHS	19.45/21.65/26.70/29.65
L125/250/370/500	Fuji Berridox HO	Beta	14.00/15.45/18.10/21.60
90/180/270	L-750	Beta	26.95
34/66/96	Fuji Berridox H621 1"HO	Broadcast width	
22/34/66/96	Broadcasting tape	2" open reel	
IRISH MAGNETIC			
T60/T120	Irish	VHS	19.95/27.15
L-250/L-500	Irish	Beta cassette	17.95/19.95
MAXELL			
L250/L500/L750	Epitaxial	Beta	15.40/20.50/25.10
60/120	Epitaxial	VHS	19.95/28.50
30/60/90/120	Epitaxial	HG VHS	18.95/21.95/25.95/29.95
20/30/60	Epitaxial	U-matic	26.50/28.50/41.50
MEMOREX			
T60/T90/T120	Video Cassette	VHS	16.99/18.99/24.99
L250/L500/L750	Video Cassette	Beta	14.99/18.99/22.99
RKD			
L 250/L-500/L-750	Color Chrome CrO ₂	Beta	13.00/17.00/21.00
SONY			
L125/L250/L500	L series	Beta	10.95/12.45/16.95
L750/L830	L series	Beta	20.95/23.95
10/20 KCS	KCS series	U-matic	20.50/25.00
30/60	KCA series	U-matic	28.00/35.00
20/30/60	V-30 series	1/2" EIAJ	17.00/22.50/37.50
30/60	V-70 series	1/2" HO	30.00/44.00
T D K			
30/60/90/120	Super Avilyn T	VHS	19.50/21.75/25.75/30.00
60/120	SA High Grade	VHS	26.00/36.00
250/500/750	Super Avilyn	Beta	15.50/22.00/NA
3M-SCOTCH			
30/60/90	L-250	Beta	14.95
60/120/180	L-500	Beta	18.95
90/180/270	L-750	Beta	23.95
30/60/90	T-30	VHS	18.45
60/120/180	T-60	VHS	21.75
120/240/360	T-120	VHS	27.95
VIDEO ACCESSORIES			
60/120	L-250/L-500	Beta	
60/120	T-60/T-120	VHS	

BULK VIDEO

PRODUCT	TAPE WIDTH	COATING	PRICE
AGFA-GEVAERT			
PEV 247	1/2"	Chrome	
T D K			
30/60/90/120	Super Avilyn	VHS	10.10/11.30/13.00/15.20

A/V/T-8



BULK AUDIO

PRODUCT	TAPE WIDTH	COATING	PRICE
AGFA-GEVAERT			
PE 611/PE 619	150 mb.	FE 203	
ALPHA MEDIA			
A M Standard	1/2"	FO/LN/HE	3.96 per hub
A M Master	1/2"	FO/HO/LN	6.24 per hub
AMPEX			
601/602	150"	FO	4.88/5.71 per 7250'/7400'
603/604	150"	FO	6.31/10.24 per 7250'/7400'
611/632	150"	FO	4.43/8.73
641/642	100"	FO	6.52/10.28
674/678	Cassettes: 43/45/60/90	FO	.66/.75/.80/1.16
AUDIOTAPE			
Lube Tape	250"		3.78/6.34 per 4200'/8400'
C 60/C-90	150"	HO/LN	4.92 per 8200'
C 60/C-90	150"	HO/LN	7.56 per 10,800'
C 60/C-90	150"	LN	4.10/6.48 per 8200'/10,800'
BASF			
DPS 60/90	150"	FE	
LH B 60/90	150"	FE	
CrO ₂ 60/90	150"	CrO ₂	
CERTRON			
Hubs C60	1/2" (7200')	HE	4.20 per hub
Hubs C90	1/2" (7200')	HE	6.00 per hub
Hubs C60	1/2" (7200')	LN	3.50 per hub
Hubs C90	1/2" (7200')	LN	4.50 per hub
CONTINENTAL ELECTRONICS			
Continental Master	1/2"	FO/EHO/ER/NB	
DUPONT			
Crolyn II	150" (720W')	CrO ₂	15.00 per reel
Crolyn II	150" (810W')	CrO ₂	18.00 per reel
M J S			
HO	1/2"	F	10,800', 16.00 per reel
HO	1/2"	F	3600', 6.00 per hub
T D K			
DXP 60	3/20"	LN/HO	6.50 per reel
DXP 90	3/20"	LN/HO	10.75 per reel
ZD-Y	3/20" (C30, C46, C60)	LN/HO	64/66/68
ZD-Y	3/20" (C90, C120)	LN/HO	92/11.30

PRODUCT CHART KEY

AV - Avilyn	FCr - ferrocrystal	M - mastering
BC - back coated	FE - ferrite oxide	MB - master backed
C - chrome	FG - ferric gamma hematite	MO - maximum output
CO - eq - chrome equivalent	FO - ferric oxide	NB - normal bias
CM - cobalt modified	FS - ferris	P - polyester
CrO ₂ - chromium dioxide	GFO - gamma ferric oxide	PF - pure ferric
EC - epitaxial cobalt	HB - high bias	PLN - premium low noise
EHO - extra high output	HD - high density	PxGH - Px gamma hematite
EO - epitaxial oxide	HE - high energy	SC - super coating
ER - extended range	HF - high ferric	SF - standard ferric
F - ferric	HI - high fidelity	SHI - super high fidelity
FC - ferric cobalt	HO - high output	SLN - super low noise
FCr - ferric chrome	HP - high performance	SP - standard performance
FCo - ferric cobalt	LN - low noise	XHE - extra high energy

* - 10 1/2" reel

** - 5" reel

*** - 14" reel

AUDIO VIDEO TAPE EQUIPMENT MANUFACTURERS & IMPORTERS

The following are lists of Manufacturers & Importers of Audio & Video Tape Recording/Playback Equipment & Components.

The key to the abbreviations for the Types of Distribution is: (M/Ret) Manufacturer-to-Retailer, (M/OEM) Manufacturer-to-OEM, (M/End) Manufacturer-to-End User, (M/C) Manufacturer-to-Contractor, (ID) Independent Distributors, (Br) Factory-Owned Branches, (M/Rep) Manufacturers' Representatives.

Note: For the more specialized recording studio equipment firms, refer to the Billboard International Recording Equipment and Studio Directory

AUDIO

A L, see American Acoustic Labs.
A B SYSTEMS DESIGNS INC., 9477 Greenback Ln., Folsom, Calif. 95630 Tel. (916) 988-8551. Nat'l Mktg. Mgr.: Boli Bird; Sales Mgr. Diane Mackie
 Product: Amplifiers.
A C R INDS. INC., RFD 1, Rt. 2, Presti-n, Conn. 06360. Tel. (203) 886-1562.
 Pres.: W. Wilbur; Sales Mgr.: John Spiza.
 Distribution: M/Ret. M/OEM
 Product: APATURE speakers
A D C, see BSR & Audio Dynamics.
A D S, see Analog & Digital Systems.
A G I, see Audio-Genera
A K G ACOUSTICS DIV., PHILIPS AUDIO VIDEO SYSTEMS, 77 Silleck St. Stamford, Conn. 06902. Tel. (203) 344-2121. VP: Andrew Brakhan; Mktg. Mgr. S. Richard Ravich
 Distribution: M/Rep
 Product: Phono cartridges, stylus-pickup, microphones (condenser, dynamic), h-a-phones, reverberation units.
A R, see Acoustic Research
A S T (AUDIO SPEAKER TECHNOLOGIES), 281 Church St., New York, N.Y. 10013. Tel.: (212) 225-7781. Pres.: Aaron Kramer; Sales Mgr.: Richard Grobarick; Mktg. Mgr.: Michael Kramer. Local branches: 11 Ave. of the Americas. Zip: 10013. Tel.: 925-8149, 1648 Coney Island Ave., Brooklyn 11229. Tel.: 475-1700.
 Distribution: M/Ret, M/OEM, M/End, ID.
 Product: Speakers, subsonic filters
ACCULAR, see BSR
ACCUTRAC, see BSR
ACCURATE SOUND CO., 114 Fifth Ave., Redwood City, Calif. 94063. Tel. (415) 365-2843. Pres.: Ronald M. Newdell; Sales Mgr.: Don O'Beira. Adv. Mgr.: Irwin Diehl. Local branch: 60 Broadway, San Francisco 94111. Tel. 781-2603. Branch Mgr.: Carson Taylor
 Int'l branch: Mexico.
 Distribution: M/End
 Product: ASCO cassette & open reel decks/rec'rs, high speed tape duplicators, ACUPRO amplifiers, STARBIRD microphone booms & stands
ACE AUDIO CO., ACCESSORIES DIV., 532 Fifth St., East Northport, N.Y. 11731. Tel.: (516) 757-8990
 Product: Electronic crossovers, filters
ACOUSTIC CONTROL CORP., 7949 Woodley, Van Nuys, Calif. 91406. Tel. (213) 997-6131
 Distribution: M/Ret, ID.
 Product: Amplifiers, speakers
ACOUSTIC RESEARCH, 10 American Dr., Norwood, Mass. 02062. Tel. (617) 769-4200. Telex: 928310. Pres.: Ron Fone, Exec. VP: Herib Horowitz.
 Sales Dir.: Rick Sands.
 Distribution: M/Rep
 Product: AR speakers
ACOUSTI-PHASE INC., PO Box 207, Beetz St., Proctorsville, Vt. 05153. Tel. (802) 226-7716. Pres.: William Markowitz; Sales Mgr.: Larry Artz.
 Distribution: M/Ret, M/R-Rep
 Product: Speakers
ACUPRO, see Accurate Sound
ACUTEX INT'L INC., 10490 Lee Hwy., Fairfax, Va. 22030. Tel.: (703) 273-7500. TWX: (710) 833-0363. Pres.: Ken K. Kanzler; Nat'l Sales Mgr.: Al Davis, Prod. Mgr.: BBI Bramble.
 Distribution: ID, M/Rep
 Product: Speakers, phono cartridges, headphones (ultra light weight)
ADCOM, 9 Jules Ln., New Brunswick, N.J. 08901. Tel. (201) 828-8590. Telex: 844430. Pres.: Newton A. Cham; Sales Mgr.: Richard McConser.
 Adv. Mgr.: Bernard Newman
 Distribution: M/Rep
 Product: ADCOM amplifiers, phono cartridges (moving coil); BRAUN speakers
ADVENT CORP., 195 Albany St., Cambridge, Mass. 02139. Tel. (617) 661-9500. Telex: 421479. Pres.: Bernie Mitchell; Sales Mgr.: Fred G. Hildestein.
 Adv. Mgr.: Margaret Brzelius. (Also see listing under VIDEO)
 Distribution: M/Ret.
 Product: Receivers, speakers, de ay units
AIMA AMERICA INC. SUB. OF SONY CORP. OF AMERICA, 35 Oxford Dr., Moo-nache, N.J. 07074. Tel.: (201) 446-5220. Pres.: Shigeru Inagaki; VP Sales & Mktg.: William Hoard; Nat'l Sales Mgr.: Robert Fisher

Branch: Torrance, Calif., 20360 Grammercy Pl. Zip. 90501. Tel.: (213) 328-0428
Home office: Japan
 Distribution: M/Ret, M/Rep
 Product: Cassette decks/rec'rs, mixers, amplifiers, pre-amplifiers, tuners, receivers, speakers, turntables, microphones, (condenser, dynamic), ribbon, wireless), noise reduction systems, headphones.
AJAI AMERICA LTD., 800 W. Artesia Blvd., Compton, Calif. 90220. Tel. (213) 537-3880. VP: C.E. Phillips. Adv. Mgr.: Robert G. Caskley Jr. (Also see listing under VIDEO)
 Distribution: M/Rep
 Product: Cassette & open reel decks/rec'rs, mixers, amplifiers (integrated), pre-amplifiers, tuners, receivers, speakers, turntables, equalizers
ALTEC INC., 45 Foley St., Santa Rosa, Calif. 95401. Tel.: (707) 523-2611.
 Distribution: M/Ret
 Product: Pre-amplifiers
ALLISON ACOUSTICS INC., 7 Tech Circle, Natick, Mass. 01760. Tel.: (617) 237-2670. Telex: 948448. Pres.: Roy F. Allison. Mktg. & Adv. Dir.: Sumner Bennett.
 Distribution: M/Ret, M/Rep
 Product: Speakers
ALLISON RESEARCH INC., see Valley People
ALTEC CORP., ALTEC-LANSING SOUND PRODS. DIV., 1515 S. Manchester Ave., Anaheim, Calif. 92803. Tel.: (714) 774-2900. Telex: 655415. Pres.: W. F. Fowler, VP Sales: Chuck Harper, Sales Mgr.: Gary H. Rilling; PR: Marie Walter
 Branch: Oklahoma City, Okla., 10500 W. Reno Ave. Zip: 73126. Tel. (405) 354-5311. Plant Mgr.: Jack Slentz
 Distribution: M/Ret, M/OEM, M/C, M/Rep
 Product: ALTEC LANSING amplifiers, pre-amplifiers, speakers, microphones (condenser, dynamic), equalizers
ALTEC-LANSING, see Altec Corp.
AMBIO-BOX, see Bang & Olufsen
AMBOY AUDIO ASSOCS., 236 Walnut St., South Amboy, N.J. 08879. Tel. (201) 721-5121
 Product: Open reel decks/rec'rs, speakers, turntables, microphones, equalizers
AMERICAN ACOUSTIC LABS (AAL), 629 W. Cermak Rd., Chicago, Ill. 60616. Tel. (312) 243-1310. Telex: 206061. Pres.: George H. Muller, VP: Loyd Ivey. Sales & Adv. Mgr.: James E. Strass.
 Distribution: M/Ret, M/OEM, M/C, M/Rep.
 Product: AAL speakers
AMERICAN AUDIO CORP., 636 Forbes Blvd., South San Francisco, Calif. 94080. Tel.: (415) 872-1331. Telex: 349494. Pres.: Leo R. Ikeda, Sales Mgr.: Jay Holloway
 Distribution: ID, M/Rep
 Product: Auto/mobile tape systems.
AMERICAN MONITOR, see RTR
AMPEX CORP., AUDIO-VIDEO SYSTEMS DIV., 401 Broadway, Redwood City, Calif. 94063. Tel. (415) 367-2011. Telex: 348464. Pres.: Arthur H. Hausman. Adv. Mgr.: Al Fisher. (Also see listing under VIDEO)
 Branches: Glendale, Calif., 500 Rocier Dr. Zip: 91201. Tel. (213) 240-5000. Reg'l Sales Mgr.: Tom Nielson—Atlanta, Ga., 3135 Chestnut Dr. Suite 101. Zip: 30340. Reg'l Sales Mgr.: Paul Hansil—Arlington Heights, Ill., 719 W. Algonquin Rd. Zip: 60005. Tel. (312) 593-6000—Bethesda, Md., 10215 Fernwood Rd. Zip: 20034. Tel. (301) 530-8800. Reg'l Mgr.: Frank Rush—Hackensack, N.J., 75 Commerce Way. Tel. (201) 489-7400. Reg'l Sales Mgr.: Al Slater—Puerto Nuevo, P.R., Ampex Pan American Co., San Miguel Hermanos Bldg., Avenida Kennedy 1880, Oficinas 412 & 413. Zip: 00920. Tel. (809) 781-1985—Dallas, Tex., 1615 Prudential Dr. Zip: 75235. Tel. (214) 637-5100. Reg'l Sales Mgr.: Frank Naufr.
 Int'l branches: Argentina, Australia, Belgium, Brazil, Canada, Colombia, England, France, Germany, Greece, Hong Kong, Italy, Japan, Mexico, Netherlands, Singapore, Spain, Sweden, Switzerland
 Distribution: M/Ret, M/End, ID, M/Rep
 Product: Open reel (professional) decks/rec'rs
AMPRO SCULLY, 826 Newtown Yardley Rd., Newtown, Pa. 18940. Tel. (215) 968-9000. Cable: AMPROSCUL. TWX: (510) 667-2299. Pres.: Alex Meyer.
 Sales Mgr.: John Cyr
 Distribution: M/Rep
 Product: SCULLY open reel decks/rec'rs, AMPRO mixers
ANALOG & DIGITAL SYSTEMS INC. (ADC), One Progress Way, Wilmington, Mass. 01887. Tel. (617) 658-5100. Telex: 947403. Pres. Dr. Goddard A. Guenther, Sales Mgr.: (eastern U.S. & Canada) Bill Duvall, (west) Chris Browder, Mktg. Mgr.: Haddon K. Appleman.
 Distribution: M/Ret, M/Rep
 Product: ADS speakers, digital delay systems

ANDANTE, see Sumko.
APATURE, see ACR
ARISTA ENTS. INC., 35 Hoffman Ave., Hauppauge, N.Y. 11787. Tel. (516) 234-7000. TWX: (510) 227-9882. Pres.: Alan Leifer. Adv. Mgr.: Michael Fedonchik.
 Distribution: M/Ret, ID, M/Rep
 Product: Amplifiers, pre-amplifiers, speakers, phono cartridges, stylus-pickup, microphones (condenser, dynamic), headphones.
ARKAY PRODS. MFG. CO. INC., 1241 W. 135 St., Gardena, Calif. 90247. Tel. (213) 532-5491
 Product: Speakers
ASCO, see Accurate Sound.
ASHLY AUDIO INC., 100 Fernwood Ave., Rochester, N.Y. 14621. Tel. (716) 544-5191. WATS: (800) 828-6308. TWX: (510) 253-3901. Pres.: William Thompson III; Sales & Adv. Mgr.: Greg Green; Customer Serv.: Cindy Jensen.
 Distribution: M/Ret, M/C, ID
 Product: Equalizers (parametric), electronic crossovers, limiter/compressors.
SAM ASH MUSIC CORP., 124 Fulton Ave., Hempstead, N.Y. 11550. Tel. (212) 347-7757. Pres. & Sales Mgr.: Jerry Ash; Exec. VP & Adv. Mgr.: Paul Ash.
 Distribution: M/Ret, M/End
 Product: SAM ASH, SAMSON speakers
ASTATIC CORP., PO Box 120, Conneaut, Ohio 44030. Tel. (216) 593-1111.
 Distribution: M/OEM, M/C, ID.
 Product: Tonearms, phono cartridges, stylus-pickup, microphones (dynamic)
AUDAX, see Polyda.
AUDIKON INC., 3081-D La Jolla St., Anaheim, Calif. 92806. Tel. (714) 630-5230.
 Distribution: M/Rep
 Product: Amplifiers, pre-amplifiers, speakers, equalizers, noise reduction systems, effects generators
AUDIMAX, see Thomson-CSF.
AUDIO CONTROL CORP., 6520 212 St. SW., Lynnwood, Wash. 98036. Tel. (206) 775-8461.
 Distribution: M/Rep
 Product: Equalizers, real time analyzers
AUDIO DYNAMICS CORP. (ADC), Pickett District Rd., New Milford, Conn. 06776. Tel. (203) 355-2671. Pres.: C.E. Wennerstrand; VP Mktg.: Ken Reichel; Adv. Mgr.: Bob Schindhelm; Mktg. Servs. Mgr.: Art O'Neil.
 Distribution: M/Rep
 Product: ADC pre-amplifiers, speakers, turntables, tonearms, phono cartridges
AUDIO GENERAL INC., 1631 Easton Rd., Willow Grove, Pa. 19090. Tel. (215) 659-1236. Pres.: David A. Spiegel; Sales & Adv. Mgr.: Robert Tucker.
 Distribution: M/Ret, ID, M/Rep.
 Product: AGI pre-amplifiers
AUDIO INNOVATIONS, 164 Belle Terre Dr., La Place, La. 70068. Tel.: (504) 652-2079. Pres.: Hugh Hearon, Sales Mgr.: Kevin Aucouin; Adv. Mgr.: Charles Daigle.
 Branch: Gonzales, La., 1827-C S. Burnside. Zip: 70737. Tel.: (504) 644-7510.
 Distribution: M/End, M/C
 Product: HEARON mixers, speakers
AUDIO INT'L INC., PO Box 477, Monticello Rd., Albany, Ky. 42602. Tel. (606) 387-6656. Pres. & Adv. Mgr.: Geoffrey W. Hall; Sales Mgr.: Alfreda Stearns.
 Distribution: M/Ret, M/OEM, M/Rep.
 Product: CM LABS mixers, amplifiers, pre-amplifiers
AUDIOMARKETING LTD., 652 Glenbrook Rd., Stamford, Conn. 06906. Tel. (203) 359-2312. Telex: 996519. Pres.: Hamilton H. Brosious; VP: Robert Berliner; Sales Mgr.: Richard N. Anderson.
 Distribution: M/Ret
 Product: BIG RED, LITTLE RED, SUPER RED speakers; time aligned crossovers
AUDIOMASTER, see RCS.
AUDIONICS OF OREGON, 10950 SW Fifth Ave., No. 160, Beaverton, Ore. 97005. Tel. (503) 641-5225. TWX: (910) 467-8728. Pres. & Sales Mgr.: Charles Wood.
 Distribution: M/Ret
 Product: Amplifiers, pre-amplifiers, turntables, noise reduction systems, SQ decoders.
AUDIOPHILE IMPORTS, B.E. Erie St., Chicago, Ill. 60611. Tel. (312) 281-4575.
 Distribution: M/Ret, M/Rep
 Product: QUAD amplifiers, pre-amplifiers, tuners, speakers.

AUDIO PULSE ELECTRONICS INC., 4501 N Arden Dr., El Monte, Calif. 91731. Tel. (213) 579-4873. Pres.: Donald R. Becker; VP Sales: Don Cole. Gen. Mgr.: John Sedano.
Distribution: M/Ret. M/Rep.
Product: Digital time delay systems

AUDIO RESEARCH CORP., 6801 Shingle Creek Pkwy., Minneapolis, Minn. 55430. Tel. (612) 566-7570. Pres.: William Johnson; Sales & Adv. Mgr.: Ric Kimbell.
Distribution: M/Ret.
Product: Amplifiers, pre-amplifiers

AUDIO SCIENTIFIC, see Superex

AUDIO SPEAKER TECHNOLOGIES, see AST

AUDIO-TECHNICA US INC., 1221 Commerce Dr., Stow, Ohio 44224. Tel. (216) 686-2600. Pres.: Jon R. Kelly; Sr. VP: Fred Nichols; VP Sales: Paul McGuire; Mktg. Communications Dir.: Don Kirkendall; PR Dir.: Shane O'Neil.
Distribution: M/Rep
Product: AUDIO TECHNICA tonearms, phono cartridges, stylus-pickup, microphones (condenser, dynamic), headphones; DESIGN ACOUSTICS speakers

AUDIO TECHNOLOGY, 1169 Tower Rd., Schaumburg, Ill. 60195 Tel. (312) 885-0066. Pres. & Adv. Mgr.: J.B. Hildebrandt; Sales Mgr.: Bill Griffin.
Distribution: M/Rep
Product: Pre-amplifiers, LED peak indicators

AUDIOTEX, see GC Electronics

AUDIO TRANSPORT SYSTEMS, 67 W. High St., Avon, Mass. 02322 Tel. (617) 583-4000.
Distribution: M/Ret. M/C
Product: Pre-amplifiers, speakers

AURATONE CORP., PO Box 698, Coronado, Calif. 92118 Tel. (714) 297-2820 Pres & Adv. Mgr.: J.A. Wilson; Sales Mgr.: H.E. Wilson
Distribution: M/Ret. M/OEM M/End. M/C
Product: Speakers, sound reinforcement equip.

AURORA SOUND INT'L, 238 S. Mission Rd., Los Angeles, Calif. 90033. Tel. (213) 261-7132 Telex 194660. Pres.: B. Rigney.
Distribution: M/Ret. M/OEM. M/Rep
Product: Speakers

AUTO-TEC, see United Research

AVID CORP., 10 Tripps Ln., East Providence, R.I. 02914. Tel. (401) 438-5400 Pres.: Albert C. Allen. VP: Jeff Allen; Sales Mgr.: Alex Hofstetter.
Distribution: M/Ret
Product: Speakers

AVNET, see BIC

AXIOM ENG'G LABS., 9601 Owensmouth Ave., Chatsworth, Calif. 91311 Tel. (213) 998-8014 Pres.: Jerry Axelrod; Sales Mgr.: Mike Serwe
Distribution: M/Ret. M/Rep
Product: Speakers

B & S (BERTAGNI ELECTROACOUSTIC SYSTEMS INC.), 345 Fischer St., Costa Mesa, Calif. 92626 Tel. (714) 549-3833 Pres.: Lynn Morrison; Nat'l Sales Mgr.: Barry Klaidman
Distribution: M/Ret
Product: Speakers

B G W SYSTEMS INC., 13130 S. Yukon Ave., Hawthorne, Calif. 90250. Tel. (213) 973-8090 Pres.: Brian Gary Wachner; VP Adv. & Promo: Barbara Wachner; Mktg. Mgr.: Irwin Laskey
Distribution: M/Rep
Product: Amplifiers

B I C/AVNET, Cantaque Rock Rd., Westbury, N.Y. 11590. Tel. (516) 997-5400 TWX (510) 222-5185 Pres.: Franklin S. Hoffman; Sales Mgr.: Paul D. Albert; Serv. Mgr.: Adam Ruthkowski
Distribution: M/Ret. M/Rep
Product: BIC cassette decks/rec's, speakers, turntables, BEAM BOX in door FM antennas; BEAM BOOSTER FM signal amplifiers

B M I ELECTRONICS INC., 5305 N. Ravenswood, Chicago, Ill. 60640. Tel. (312) 271-7755 Pres.: J. Michael Montalbano; Sales Mgr.: George L. Commons; Adv. Mgr.: Terry Spears
Distribution: M/Rep
Product: DEFINITIVE AUDIO, TRACER speakers

B S R (USA) LTD., Rt. 303, Blauvelt, N.Y. 10913 Tel. (914) 358-6060.
Product: BSR turntables, phono cartridges, stylus-pickup, ADC turn tables, equalizers; ACCUTRAC turntables

B T M F/G. CO., 2005 Lincoln, Pasadena, Calif. 91103. Tel. (213) 798-0476
Distribution: M/Rep
Product: Speakers (electrostatic, tw woofers)

BANG & OLUFSEN OF AMERICA INC., 515 Busse Rd., Elk Grove Village, Ill. 60007 Tel. (312) 640-0660. Pres.: John H. Trux; Sales Mgr.: Ozz Jones; Adv. Mgr.: Dan Radecki
Distribution: M/Rep
Product: BEOCORD cassette decks/rec's, BEOMASTER receivers, BEOVOX PHASELINK speakers, BEOGRAM turntables, BANG & OLUFSEN phono cartridges, headphones, AMBIO-BOX ambience recovery systems

BEAM BOOSTER, see BIC/Avnet

BEAM BOX, see BIC/Avnet

BECKER ELECTRONICS MFG. CORP., Rt. 145, East Durham, N.Y. 12423. Tel. (518) 634-2571 Pres.: Fred Becker Jr.; Sales Mgr.: Fred Becker III
Distribution: M/Ret. M/OEM. M/Rep
Product: BECKER, IDS, RADIANT RESEARCH, TRUCK speakers

BELLE KLIPSCH, see Klipsch

BELLES RESEARCH CORP., PO Box 307, A-1 Country Club Rd., East Rochester, N.Y. 14445 Tel. (716) 586-7300 Pres.: David E. Belles; Sales Mgr.: Robert L. Welch
Distribution: M/Ret. M/Rep
Product: Amplifiers (Class A), pre-amplifiers, bridging units

BELL & HOWELL CO., AUDIO-VISUAL PRODS. DIV., 7100 McCormick Rd., Chicago, Ill. 60645. Tel. (312) 262-1600.
Distribution: M/Ret
Product: Cassette decks/rec's

BENJAMIN ELECTROPRODUCTS INC., 180 Miller Pl., Hicksville, N.Y. 11801 Tel. (516) 931-5558 Telex 127908 Pres.: Joseph Benjamin; Sales & Adv. Mgr.: Edward A. Cote
Distribution: M/Rep
Product: BENJAMIN turntables, speaker stands; BENJAMIN/LENCO cassette changers; BENJAMIN/VIETA speakers

BENJAMIN/LENCO, see Benjamin Electroproducts

BENJAMIN/VIETA, see Benjamin Electroproducts

BEOCORD, see Bang & Olufsen

BEOGRAM, see Bang & Olufsen

BEOMASTER, see Bang & Olufsen

BEOVOX PHASELINK, see Bang & Olufsen

HAROLD BEVERIDGE INC., 505 E. Montecito St., Santa Barbara, Calif. 93103 Tel. (805) 963-6578. Telex 658496 Pres.: Harold Beveridge; VP Ops: F. LeVita
Distribution: M/Ret
Product: Pre-amplifiers, speakers, equalizers

BEYER DYNAMIC INC., 5-05 Burns Ave., Hicksville, N.Y. 11801 Tel. (516) 935-8000. Sales Mgr.: Norm Wieland; Adv. Mgr.: Gerald LeBow.
Distribution: M/Rep
Product: BEYER microphones (condenser, dynamic, ribbon, wireless), headphones, transformers

BIAMP SYSTEMS INC., 9600 SW Barnes Rd., Portland, Ore. 97225 Tel. (503) 297-1555 Pres.: Conrad Sundholm; Mktg. Mgr.: Gail Martin.
Distribution: M/Ret. M/C
Product: Mixers, amplifiers, equalizers, electronic crossovers, compressor/limiters, reverb units.

BLACKMAX SYSTEMS INC., PO Box 23355, Louisville, Ky. 40223 Tel. (502) 491-9920 Pres.: David L. Jarnagin
Distribution: M/Rep
Product: BLACKMAX, ROCK MONITOR, ROCKER speakers

BOGEN DIV./LEAR SIEGLER INC., Box 500, Paramus, N.J. 07662 Tel. (201) 343-5700 Pres.: John H. Ochter; VP Mktg.: Joseph A. Palmieri; Adv. Mgr.: David E. Pear
Distribution: ID. M/Rep
Product: TECH-CRAFT BY BOGEN mixers, amplifiers, pre-amplifiers, tuners, receivers, equalizers, power amplifiers

BOSE CORP., 100 The Mountain Rd., Frammingham, Mass. 01701. Tel. (617) 879-7330. Pres.: A.G. Bose; Adv. Mgr.: Peter Ferguson; Sales & Professional Prods. Mgr.: Jeff Pallin
Distribution: M/Ret
Product: Amplifiers, speakers.

BOSTON ACOUSTICS INC., 130 Concord St., Boston, Mass. 02128 Tel. (617) 569-5114. Pres.: Frank Reed; VP Sales: Jeff Myers
Product: Speakers

BOZAK INC., 587 Connecticut Ave., Norwalk, Conn. 06854 Tel. (203) 838-6521
Distribution: M/C. M/Rep
Product: Amplifiers, pre-amplifiers, speakers, time delay systems

BRAUN, see Adcom

BRITISH INDS. CO., see BIC/Avnet

BROADCAST ELECTRONICS INC., 4100 N. 24 St., Quincy, Ill. 62301 Tel. (217) 224-9600 Cable SPOTMASTER Telex 250142 Pres.: L.J. Cervon; Sales Mgr.: J.M. Engle; Adv. Mgr.: Tom Humphrey
Distribution: M/Ret. M/OEM. M/End. M/C. ID
Product: QRK turntables, QRK-ALPHA pre-amplifiers, GALAXY turntables, REK-O-KUT tonearms

BUHL INC., 5 Paul Kohner Pl., Elmwood Park, N.J. 07407 Tel. (201) 797-7100
Distribution: ID. M/Rep
Product: PROGRAMMA BUHL cassette decks/rec's

C M LABS, see Audio Int'l

CALIFONE INT'L INC., 5922 Bowcroft St., Los Angeles, Calif. 90016 Tel. (213) 870-9631 Cable CALINTL Telex 664313 Pres.: Steve Lavineta
Distribution: ID
Product: Cassette & open reel decks/rec's, amplifiers, speakers, turn tables, tonearms, phono cartridges, stylus-pickup, microphones (condenser, dynamic), headphones

CAMBRIDGE PHYSICS, 26 Fox Rd., Waltham, Mass. 02154 Tel. (617) 890-1560 Pres.: Stanley Penton; Mktg. Dir.: Alan M. Weisberg.
Distribution: M/Rep
Product: Speakers

CARTER CORP., 1916 11 St., Rockford, Ill. 61101 Tel. (815) 397-3200 Pres.: R.L. Fleming; VP Sales & Mktg.: S.L. Fleming; Adv. Mgr.: J. Rattner
Distribution: M/Ret. M/OEM. ID. M/Rep
Product: CARTER CRAFT stylus-pickup, microphones (condenser, dynamic), headphones

CARTER-CRAFT, see Carter Corp

CARVER CORP., PO Box 664, 14304 NE 193 Pl., Woodinville, Wash. 98072 Tel. (206) 487-3483 Pres.: Robert W. Carver; VP & Mktg. Dir.: Diana Raphael Carver
Distribution: M/Ret. M/Rep
Product: Amplifiers, pre-amplifiers, noise reduction systems

CARVIN MFG. CO., 1155 Industrial Ave., Escondido, Calif. 92025 Tel. (714) 747-1710 Sales Mgr.: Carson Kiesel
Distribution: M/End
Product: Mixers, amplifiers, speakers

CASTLE, see Hervic

CELESTION INDS. INC., PO Box 521, Holliston, Mass. 01746 Tel. (617) 429-6706 VP: Robert E. Shapiro
Distribution: M/Rep
Product: Speakers

CERWIN-VEGA INC., 12250 Montague St., Arleta, Calif. 91331. Tel. (213) 896-0777 TWX (910) 496-1589 Pres.: Gene Czerwinski; VP Mktg.: Ray Arbuclie; Mktg. Dir.: Rich Mandella
Distribution: M/Rep
Product: CERWIN VEGA amplifiers, speakers, microphones (condenser, dynamic), equalizers, METRON amplifiers, pre-amplifiers, tuners, HED speakers

CETEC BROADCAST GROUP, 1110 Mark Ave., Carpinteria, Calif. 93013 Tel. (805) 684-7686 Sales Mgr.: Andrew P. McClure
Distribution: M/End. M/C. ID. M/Rep
Branches: Arvada, Colo., 6464 W. 76 Pl. Zip. 80003 Tel. (303) 420-7332 District Mgr.: Todd Harrington-Jackson, Mo., PO Box 146, 1234 Ashbury Ct. Zip. 63755. Tel. (314) 243-1006 District Mgr.: Jim Smith-Strongsville, Ohio, PO Box 8868, Zip. 44136 Tel. (216) 826-4508 District Mgr.: Bob Groom-Hillsboro, Ore., 2847 SE 13 Ct. Zip. 97123 Tel. (503) 648-9873 District Mgr.: Jim Zache-Bethlehem, Pa., 3130 Chalfonte Ave. Zip. 18017 Tel. (215) 865-6013 District Mgr.: Art White-Palestine, Tex., PO Box 906 Zip. 75801 Tel. (214) 729-6857 District Mgr.: Jack Beazley-Marion, Va., PO Box 31, Hwy. 16 S. Zip. (703) 783 2001. District Mgr.: Bob Dix.
Product: Open reel decks/rec's, mixers, pre-amplifiers, turntables, tonearms, phono cartridges, stylus-pickup, microphones (condenser, dynamic), program automation

CETEC GAUSS, 9130 Glenoaks Blvd., Sun Valley, Calif. 91352 Tel. (213) 875-1900 Telex 194989 Pres.: Wesley M. Fuji; Sales Mgrs. (speakers) Robert M. Taylor, (duplicators) Jacques Fleischmann; Asst. Gen. Mgr.: J.R. Williams
Int'l branches: England, Switzerland
Distribution: M/OEM. M/End. M/C. M/Rep
Product: Speakers, high speed tape duplicating equip

CETEC VEGA (DIV. OF CETEC CORP.), PO Box 5348 Zip. 91731. 9900 Baldwin Pl., El Monte, Calif. 91731 Tel. (213) 442-0782 TWX (910) 587-3539 Nat'l Sales Mgr.: Paul Baughman
Product: Wireless intercom systems

CHARTEWELL, see Reference Monitor

CITATION, see Harman/Kardon

CIZEK AUDIO SYSTEMS INC., 300 Canal St., Lawrence, Mass. 01840 Tel. (617) 685-8707 Pres.: Edward A. Gardner.

Distribution: M/Rep
Product: Speakers

DAVID CLARR CO. INC., 360 Franklin St., Worcester, Mass. 01604 Tel. (617) 756-6216. Telex 920482.
Product: STRAIGHTAWAY headphones

CLARKE SYSTEMS INC., 359-C Governor's Hwy., South Windsor, Conn. 06074. Tel. (203) 528-4331.
Distribution: M/Rep
Product: Speakers

CLASSIC RESEARCH & ENG'G, 5070 E. 22 St., Tucson, Ariz. 85711 Tel. (602) 790-0455 Pres.: John Mongelli; Sales Mgr.: Tony Van Note; Adv. Mgr.: Dick Krug; Design: John Zimmerman
Distribution: M/Ret. ID. M/Rep.
Product: SEAS speakers, speaker kits, custom passive & active crossover systems.

CLONE TONE, see Full Compass

CLUBMAN, see Meteor

CONCERTMASTER, see Hartley

CONNOISSEUR, see Hervic

CORNWALL, see Klipsch

CRAIG CORP., 921 W. Artesia Blvd., Compton, Calif. 90220. Tel. (213) 537-1233
Branches: Atlanta, Ga., 2935 Amwiler Rd. Zip. 30360. Tel. (404) 449-6200-Elk Grove Village, Ill., 1450 Greenleaf Ave. Zip. 60007 Tel. (312) 593-3150-Houston, Tex., 8500 Commerce Park Dr., Suite 102. Zip. 77036. Tel. (713) 498-3603-Seattle, Wash., PO Box C-88757, Tukwila Branch, 1020 Andover Park W. Zip. 98188 Tel. (206) 575-0685
Product: 8-tr. & cassette rec's, tuners, receivers, speakers, turntables

CREST, see DMI

CRITERION, see Lafayette

CROWN INT'L INC., 1718 W. Mishawaka Rd., Elkhart, Ind. 46514 Tel. (219) 294-5571 Pres.: Max W. Schofield; Sales Mgr.: James S. Beattie; Adv. & PR Mgr.: Murray Young
Distribution: M/Rep
Product: CROWN amplifiers, pre-amplifiers, tuners, equalizers, P2M microphones

CROWN RADIO CORP., see American Audio

CYGLAND, see Wood Specialty

D B SYSTEMS, PO Box 347, Jaffrey, N.H. 03452 Tel. (603) 899-5121 Pres. David B. Hadaway; Sales Mgr.: John S. Turner
Distribution: M/Ret
Product: Electronic crossovers, pre-pre amplifiers, tone controls, phase inverters

dB i INC., 71 Chapel St., Newton, Mass. 02195 Tel. (617) 964-3210 Telex 922522 Pres.: David E. Blackmer, US Professional Prods. Dir.: Lance Korhals.
Distribution: M/Ret. M/OEM. M/C. M/Rep
Product: Equalizers, noise reduction systems, signal processors, compressor/limiters, dynamic range enhancers, sub harmonic bass synth sizes

D C M CORP., 670 Airport Blvd., Ann Arbor, Mich. 48104 Tel. (313) 994-8481 Pres. & Sales Mgr.: Robert Waterstripe
Distribution: M/Ret. M/Rep
Product: Speakers

D M I INC., 150 Florence Ave., Hawthorne, N.J. 07506 Tel. (201) 423-1300 Telex 219155 Pres.: John Lee; Sales Mgr.: Bob Prdeaux; Adv. Mgr.: James Reilly
Distribution: M/Ret. M/C. M/Rep
Product: NELSEY mixers, CREST amplifiers

D W D INC., PO Box 9056, Fresno, Calif. 93792 Tel. (209) 485-0821
Distribution: M/Ret. M/Rep
Product: ETR SERIES speakers

DAHLQUIST INC., 601 Old Willets Path, Hauppauge, N.Y. 11787 Tel. (516) 234-5757 Pres.: Jon Dahlquist; Asst. Sales Mgr.: Elaine Zuewsky
Distribution: M/Rep
Product: Speakers (pro monitor & phased array) subwoofers, crossovers

DALESFORD, see Denness

DEFINITIVE AUDIO, see BML

DENNESEN ELECTROSTATICS, PO Box 51, Beverly, Mass. 01915 Tel. (617) 927-2521 Pres.: Peter Madnick
Distribution: M/Ret
Product: DENNESEN amplifiers, pre-amplifiers, speakers, tonearms, DALESFORD raw drivers

DESIGN ACOUSTICS, see Audio Technica

DIMENSION, 2020 E. Orangehorpe Ave., Anaheim, Calif. 92806 Tel. (714) 879-2140 Pres.: Fred Daleo, VP Sales & Mktg.: Phil Grieves
Distribution: M/OEM, M/Rep.
Product: Speakers

DOLBY LABS INC., 731 Sansome St., San Francisco, Calif. 94111 Tel. (415) 392-0300 Pres.: Roy Dalbey; VP Mktg.: Ioan Allen; Adv. Mgr.: Bob Peter sen; Technical Inquiries: Clyde McKinney
Product: Noise reduction systems, cinema stereo systems

OUAL, see United Audio

OYNACO INC., 9613 Oates Dr., Sacramento, Calif. 95827 Tel. (916) 362-4102 Pres.: Walter P. Semonoff
Product: Amplifiers, pre-amplifiers, tuners, speakers, equalizers, stereo image enhancers

DYNACORD ELECTRONICS INC., 6908 Lawnton St. Philadelphia, Pa. 19128 Tel. (215) 482-4992
Distribution: M/Rep
Product: Cassette & open reel decks/rec's, amplifiers, pre-amplifiers, tuners, speakers, turntables, tonearms, phono cartridges, stylus-pickup, microphones (dynamic, ribbon), equalizers, headphones

DYNAPHASE, see Stanton

E M T, see Gotham Audio

E P I, see Epurec

E S S INC. (ELECTROSTATIC SOUND SYSTEMS INC.), 9613 Oates Dr., Sacramento Calif. 95827 Tel. (916) 362-4102
Distribution: M/Ret. M/OEM. ID. M/Rep
Product: Speakers

E T R SERIES, see DWG

E V-TAPCO, 3810 148 Ave. NE, Redmond, Wash. 98052. Tel. (206) 883-3510 TWX (910) 449-2594 Gen. Mgr.: F. David Merrey Jr.; Mkt. Development Mgr.: Jim Loggnow
Distribution: M/Ret. M/Rep
Product: Mixers, amplifiers, pre-amplifiers, equalizers, electronic crossovers, reverb units.

EDCOR, 16782 Hale Ave., Irvine, Calif. 92714. Tel. (714) 556-2740
Distribution: M/Ret
Product: Microphones (wireless)

ELECTRO-HARMONIX INC., 27 W. 23 St., New York, N.Y. 10010 Tel. (212) 741-1866 Telex. 423755 Cable. ELHARMONIX Pres.: Mike Matthews; Sales Mgrs.: Manny Zapata, Willie Magee; Adv. Mgr.: Manny Zapata
Distribution: M/Ret.

Hear the difference a Syncaset™ can make.



Chances are, the audio part of your A/V presentation doesn't live up to the visual. Because your slide sync unit has its hands full just running the show. Without enough engineering left over for sound quality.

Not so with the Syncaset. Superb tape recording and reproduction are what it's all about. Because that's what TASCAM is all about.

In fact, the Syncaset has fidelity great enough to accurately record and reproduce digital cue tracks.

At the Syncaset's heart is a high-accuracy frequency-generated servo DC type motor that minimizes wow and flutter—a precision system line voltage variations can't affect.

Throughout, the Syncaset is engineered to extremely fine tolerances. To give you maximum reliability, durability and smooth performance.

Naturally the Syncaset also has the standard features

you need for multi-image presentations. Plus some features that aren't so standard. Like stereo sound at the flip of a switch when you cue manually. A Dolby* noise reduction system. A rewind with a memory. And EQ and bias switches.

But the biggest difference is what you'll hear. Maybe even some applause.



Model 124
A/V Syncaset

TASCAM MULTI-IMAGE
SERIES
TEAC Production Products

Product: Amplifiers, equalizers
ELECTRONIC RESEARCH ASSOCS. INC., 311 E. Park St., Moonachie, N.J. 07074 Tel: (201) 641-3650 Pres. K. L. Hoffman, Sales Mgr. T. Gordon
 Distribution: M/Ret. M/OEM, M/C, IO, M/Rep
 Product: POLY-PLANAR speakers
ELECTROSONIC SYSTEMS INC., 5223 Edina Ind'l Blvd., Minneapolis, Minn. 55435 Tel: (612) 835-5787 Pres. & Adv. Mgr.: Kevin Curry, Mktg. Coord. Linda Roble; Tech Mgr.: John Lillcrap
 Product: Decoders & demodulators
ELECTRO-VOICE INC. (SUB. OF GULTON INDS. INC.), 600 Cecil St. Dept. S.B., Buchanan, Mich. 49127 Tel: (616) 695-6831 Pres. Robert Pabst, Sales Mgr. Dave Rothfeld; Adv. & Sales Promo Dir.: R. Timothy Rooney
 Branch: Visalia, Calif., 8234 Doe Ave. Zip 93277 Tel: (209) 625-1330
 Distribution: M/Rep
 Product: ELECTRO VOICE microphones (condenser, dynamic), INTERFACE, SENTRY speakers
EMPIRE SCIENTIFIC, 1055 Stewart Ave., Garden City, N.Y. 11530 Tel: (516) 222-1400 Telex 125472 Exec. VP Kenneth I. Busch, VP Sales Andrew D. Segal, Adv. Mgr. Marti Manzone
 Distribution: ID, M/Rep
 Product: Turntables, phono cartridges, styli—pickup
EPICURE PRODS. INC., 25 Hale St., Newburyport, Mass. 01950 Tel: (617) 462-1000 Pres. Harry Brustlin, VP Mktg. Ed Carrier
 Product: EPI, EPICURE speakers, THORENS turntables, tonearms.
ERCOMA CORP., 2492 Merrick Rd., Bellmore, N.Y. 11710 Tel: (516) 781-2770 Telex 144673 Pres. E. B. Frank, Sales Mgr. Melvin Handell, Adv. Mgr. Eugene Kneloff
 Distribution: M/OEM, M/Rep
 Product: LEAK amplifiers, pre-amplifiers, tuners, receivers, speakers, P.M.L. microphones (condenser, dynamic, wireless), headphones "Private Label" speakers, headphones
EUMIG (USA) INC., Lake Success Business Park, 225 Community Dr., Great Neck, N.Y. 11020 Tel: (516) 466-6533 Pres. Meinulf Poiss, Sales Mgr. Jeff Thiel, Adv. Mgr. Gerald M. LeBow
 Distribution: M/Rep
 Product: Cassette decks/rec'rs, amplifiers, pre-amplifiers, tuners
F M I, see Fulton Electronics
FIDELITONE INC., 3001 Malmo Rd., Arlington Heights, Ill. 60005 Tel: (312) 640-2473 Telex 281050
 Joe Singer
 Distribution: M/Ret. M/OEM, IO, M/Rep
 Product: Styli—pickup
FIDELITY RESEARCH OF AMERICA (DIV. OF AUDEL INC.), PO Box 5242, Ventura, Calif. 93003 Tel: (805) 642-9277 Telex: 194561 Pres: Phil Schwartz, VP: Sandra Schwartz
 Distribution: M/Ret. Direct from Importer to Retailers
 Product: Tonearms, phono cartridges (moving coil), styli—pickup, toroidal transformer pre-amplifiers for moving coil cartridges
FISHER CORP., 21314 Lassen St., Chatsworth, Calif. 91311 Tel: (213) 998-7322
 Branches: South Plainfield, N.J., 151 Helen St. Zip 07080 Tel: (201) 668-0200—Milroy, Pa., Fisher Park, Zip 17063. Tel: (717) 667-2101
 Telex 842576
 Distribution: M/Rep
 Product: Cassette decks/rec'rs, tuners, receivers, speakers, turntables
FOCUS, see Wood Specialty
FRAZIER INC., 1930 Valley View Ln., Dallas, Tex. 75234 Tel: (214) 241-3441 Pres. Jack Frazier; VP William A. Wadkins Jr., Mktg. Dir. Mike Weber
 Distribution: M/Rep
 Product: Amplifiers, speakers, equalizers
FRIED PRODS. CO., 7616 City Line Ave., Philadelphia, Pa. 19151 Tel: (215) 477-8633
 Product: Speakers
FULL COMPASS SYSTEMS LTD., 6729 Seybold Rd., Madison, Wis. 53719 Tel: (608) 271-1100 Pres. Jonathan Lipp, Sales Mgr. David Wynn, Adv. Mgr. Susan Lipp
 Distribution: M/Ret. M/OEM, M/End, IO
 Product: CLONE TONE mixers, amplifiers, pre-amplifiers
FULTON ELECTRONICS, 4208 Brunswick Ave. N., Minneapolis, Minn. 55422 Tel: (612) 537-7076 Pres. Robert W. Fulton, Sales & Adv. Mgr. Robert W. Freidre
 Distribution: M/Ret. M/OEM, M/Rep
 Product: FMI speakers; FULTON speakers, tonearms, phono cartridges
FURMAN SOUND, 616 Canal St., Suite 25, San Rafael, Calif. 94901 Tel: (415) 456-6766 Pres. Jim Furman Mktg. Dir. Lary Collins
 Distribution: M/Ret. M/OEM, M/Rep
 Product: Pre-amplifiers, equalizers, limiter/compressors, tuneable electronic crossovers, reverb units
G C ELECTRONICS, 400 S. Wyman St., Rockford, Ill. 61101 Tel: (815) 968-9661, Telex 257318 Cable GCELECT, VP Wayne Timpe, Sales Mgr. James E. Heighway, Adv. Mgr. Barry B. Nyquist (Also see listing under VIDEO)
 Distribution: M/Ret. M/OEM, IO, M/Rep
 Product: GC/AUDIOTEX mixers, speakers, microphones (condenser, dynamic), cables & connectors, GC headphones
G L I DIV., INTEGRATED SOUND SYSTEMS INC., 2950 Northern Blvd., Long Island City, N.Y. 11101 Tel: (212) 729-8400 Pres. Stuart Rock, Sales Mgr. Paul Friedman
 Product: Amplifiers, pre-amplifiers, speakers, equalizers
GAIN BRAIN, see Valley People
GALAXY, see ORK
GARRARD USA INC., 85 Sherwood Ave., Farmingdale, N.Y. 11573 Tel: (516) 293-2400, Telex: 961457, VP Mktg. & Adv. Neil Blatt, VP Ops. Nick Romano
 Distribution: M/Ret. M/OEM, M/Rep
 Product: Cassette decks/rec'rs, mixers, amplifiers, pre-amplifiers, tuners, receivers, speakers, turntables, tonearms, equalizers, noise reduction systems
GAUSS, see Ceteq Gauss
GENERAL AUDIO, 308 W. Sixth St., Austin, Tex. 78701 Tel: (512) 477-1122
 Product: Amplifiers, pre-amps.
GENERAL SOUND, 2001 W. Cheryl Dr., Phoenix, Ariz. 85021 Tel: (602) 997-6147 Cable GENSOUND Telex 668368 Pres. Norman J. Fuchs, VP Ops. Hal Paxton, Sales Mgr. Gary Conway
 Distribution: M/Ret. M/C, M/Rep
 Product: MICRON speakers
GENESIS PHYSICS CORP., Newington Park, Newington, N.H. 03801 Tel: (603) 431-5530 Pres. George F. Samuels, Adv. Mgr. Dennis Smith
 Distribution: M/Ret
 Product: Speakers
GOTHAM AUDIO CORP., 741 Washington St., New York, N.Y. 10014 Tel: (212) 741-7411 Pres. Stephen F. Temmer

Branch: Hollywood, Calif., 1710 N. La Brea Ave. Zip 90046 Tel: (213) 874-4444 VP Hugh S. Allen
 Distribution: Direct from Importer to Ret. OEM, End Users & Contractors
 Product: TELEFUNKEN open reel rec'rs, KLEIN & HUMMEL speakers, equalizers, EMT turntables, phono cartridges, reverb units, NEUMANN microphones (condenser), TELCOM noise reduction systems
GRACE, see Sumko
GRADO LABS INC., 4614 Seventh Ave., Brooklyn, N.Y. 11220 Tel: (212) 435-5340
 Distribution: M/Ret. M/OEM, ID, M/Rep
 Product: Phono cartridges, styli—pickup
GRAPHX AUDIO PRODS. INC., 310 Kirk Rd., St. Charles, Ill. 60174 Tel: (312) 584-9503
 Product: STANDARD OF PERFORMANCE speakers
GREAT WHITE WHALE DIST'N INC., 348 E. 84 St., New York, N.Y. 10028 Tel: (212) 861-3434
 Distribution: M/Rep
 Product: GREAT WHITE WHALE amplifiers, pre-amplifiers, POINT 3 POINT 4 speakers
GROMMES-PRECISION, see Precision Electronics
GROPOPOISE, see Stanton
H M ELECTRONICS INC., 6151 Fairmount Ave., San Diego, Calif. 92120 Tel: (714) 280-6050
 Distribution: M/Rep
 Product: Microphones (wireless), wireless intercom systems
HARMAN MICROPH. INC., 55 Ames Court, Plainview, N.Y. 11803 Tel: (516) 349-1300
 Distribution: M/Rep
 Product: HARMAN KAROON cassette decks/rec'rs, amplifiers, tuners, receivers, CITATION amplifiers, pre-amplifiers, tuners, receivers, RABCO turntables
HARTLEY PRODS. CORP., PO Box 316, 620 Island Rd., Ramsey, N.J. 07446 Tel: (201) 327-4443 Pres. & Adv. Mgr. Richard Schmetterer
 Distribution: M/Ret
 Product: CONCERTMASTER, H-SERIES speakers, REFERENCE speakers, cable
HEARON, see Audio Innovations
HEATH CO., Hilltop Rd., St. Joseph, Mich. 49085 Tel: (616) 982-3200
 Product: HEATHKIT amplifiers, pre-amplifiers, tuners, receivers, speakers, equalizers
HEATHKIT, see Heath
HECO, see Osawa
HEIL SOUND LTD., 2 Heil Ind'l Blvd., Marissa, Ill. 62527 Tel: (618) 295-3000
 Distribution: M/Ret. M/C
 Product: Amplifiers, speakers, equalizers, electronic crossovers
HERALD ELECTRONICS, 6611 Lincoln Ave., Lincolnwood, Ill. 60016 Tel: (312) 675-1100 Pres. Charles F. Kellner, Sales Mgr. Hank Katz
 Distribution: M/OEM, IO, M/Rep
 Product: Pre-amplifiers, speakers, microphones (condenser, dynamic), headphones
HERESY, see Klipsch
HERVIC ELECTRONICS INC., 18750 Oxnard St., Tarzana, Calif. 91356 Tel: (213) 343-3441 Gen. Mgr. Armand Herskovic, Sales & Adv. Mgr. Warren Harwood
 Distribution: M/Ret
 Product: HERVIC headphones, THE POD, CASTLE speakers, CONNOIS SEUR turntables, tonearms
HILL TYPE A, see Plasmatronics
HILL TYPE I, see Plasmatronics
HITACHI SALES CORP. OF AMERICA, 401 W. Artesia Blvd., Compton, Calif. 90220 Tel: (213) 774-5151 (Also see listing under VIDEO)
 Distribution: M/Rep
 Product: Cassette decks/rec'rs/amplifiers, pre-amplifiers, tuners, receiver speakers, turntables
H-SERIES, see Hartley
I D S, see Becker
I E M, see International Electro Magnetics
I E M/OPTRO, see International Electro Magnetics
IMPACT, see Unित्रones
IMPORT AUDIO, 13430 Clayton Rd., St. Louis, Mo. 63131 Tel: (314) 434-1310 Pres. Jeff Horen, Sales Mgr. Steven Israel
 Distribution: M/Ret
 Product: REGA turntables, tonearms, phono cartridges, styli—pickup, headphones
INFINITY SYSTEMS, 7930 Oereng Ave., Canoga Park, Calif. 91304 Tel: (213) 883-4800
 Product: Speakers
INOVONICS INC., 503-B Vandell Way, Campbell, Calif. 95008 Tel: (408) 374-8300 Pres. J. B. Wood
 Distribution: M/OEM, M/End, M/C
 Product: Noise reduction systems, compressor/limiters, acoustic analyzers
INTERFACE, see Electro Voice
INTERNATIONAL ELECTRO-MAGNETICS INC., 350 N. Eric Dr., Palatine, Ill. 60067 Tel: (312) 358-4622 Pres. John Pretto, Sales Mgr. Tony Pretto
 Distribution: M/OEM, M/End, M/C, IO
 Product: IEM magnetic heads, IEM/OPTRO equalizers
INTERNATIONAL SOUND CO. SERVO LINEAR AUDIO PRODS. INC., 133 Kerr Ave., Modesto, Calif. 95351 Tel: (209) 524-6968
 Distribution: M/Ret. IO, Br
 Product: SERVO LINEAR speakers
INTERPHASE, see John Marouskis
J B I, see James B. Lansing
J W S ACOUSTIC DESIGN CORP., Rt. Box 368A, Elkhorn, Wis. 53121 Tel: (414) 742-3995 Pres. John Speckman, Sales Mgr. Ralph Meir, Adv. Mgr. Herb Twist
 Distribution: M/End
 Product: Speakers
JANIS, see John Marouskis
JANISZER, see Soundmates
JENSEN SOUND LABS. (AN ESMARK CO.), 4136 N. United Pkwy., Schiller Park, Ill. 60176 Tel: (312) 671-5680 Group VP Jim Tweedahl, VP & Gen. Mgr. Jerry Henricks, VP Sales Pete Fredrickson, Adv. Mgr. Russ Trenert
 Distribution: M/Ret. IO, M/Rep
 Product: Amplifiers, receivers, speakers, equalizers
K A, see Kustom Acoustics
K E F ELECTRONICS, c/o Intralec, PO Box 17414, Oullens Int'l Airport, Washington, D.C. 20041 Va. Tel: (703) 435-9100 Nat'l Sales Mgr. Fred Yando
 Distribution: M/Rep
 Product: Speakers
K L H RESEARCH & DEVELOPMENT CORP., 7945 Oereng Ave., Canoga Park

Calif. 91304 Tel: (213) 992-0418 Pres. Denis Wratten, Sales Mgr. Rick Gibson
 Product: Speakers
KELSEY, see DMI
KENWOOD ELECTRONICS INC., 1315 E. Watsoncenter Rd., Carson, Calif. 90745 Tel: (213) 518-1700 Pres. Alan K. Komatsu Sr. VP Y. Nakase, VP Mktg. Don Palmquist
 Branches: Bensenville, Ill., 1098 Tower Ln. Zip 60106. Tel: (312) 766-2674 VP H. Tada—Secaucus, N.J., 75 Seaview R. Zip 07094 Tel: (201) 863-5600 Sr. VP Bill Kasuga, VP Henry Akuya
 Distribution: M/Rep
 Product: Cassette (home, auto) decks/rec'rs, amplifiers, pre-amplifiers, tuners, receivers, speakers, turntables.
KEPEX, see Valley People
KINDEL AUDIO, 1710 Newport Circle, Unit O, Santa Ana, Calif. 92705 Tel: (714) 556-8220 Pres. William Kinde
 Distribution: M/Ret. Mail Order
 Product: PHANTOM speakers
KINETIC AUDIO LTD., see Kustom Acoustics
KIRKSAETER-SAGA HI-FI INC., 398 S. Pickett St., Alexandria, Va. 22304 Tel: (703) 379-2888 370-4655, Pres. & Sales Mgr. Daniel O. Streisky.
 Distribution: M/Rep
 Product: Speakers
KLEIN & HUMMEL, see Gotham Audio
KLIPSCH & ASSOCS. INC., PO Box 688, Hope, Ark. 71801 Tel: (501) 777-6751 Pres. Paul Klipsch, Nat'l Sales Mgr. Chuck Mulhearn
 Distribution: M/Ret
 Product: BELLE KLIPSCH, CORNWALL, HERESY, KLIPSCHORN, LA SCALA speakers.
KLIPSCHORN, see Klipsch
KOENIG ELECTRONICS, 5630 Laurel St., New Orleans, La. 70115 Tel: (504) 897-2154
 Distribution: M/Ret. M/End, M/C, IO, M/Rep.
 Product: Pre-amplifiers, speakers, equalizers
KORG, see Unicord
KOSS CORP., 4129 N. Port Washington Ave., Milwaukee, Wis. 53212 Tel: (414) 964-5000 Telex 269473 Cable STEREOPHONE
 Product: Speakers, headphones, digital delay systems
KOTSCH CO., DIV. OF CENTRAL NEBRASKA INDS., 805 E. Ninth St., Gothenburg, Neb. 69138 Tel: (308) 537-7102 Omaha Tel: (402) 393-7960
 Telex 484333 Pres. Rex Kotschwar, VP Import/Export Brent Block. (Audio Importer/Exporter/Marketer)
KUSTOM ACOUSTICS INC. (KA)/KINETIC AUDIO LTD., 6628 W. Irving Park Rd., Chicago, Ill. 60634 Tel: (312) 685-6609 Pres. Ted R. Karson.
 Distribution: M/Ret. M/C
 Product: Speakers, equip. cabinets, amp load stabilizer networks.
KUSTOM KREATIONS INC., 19316 Londelius St., Northridge, Calif. 91324 Tel: (213) 886-8383 Pres. William Lang, Sales Mgr. Bruce Lang
 Distribution: M/Ret. M/OEM, IO, M/Rep
 Product: POWER UP amplifiers, XK speakers
LAFAYETTE RADIO ELECTRONICS CORP., 111 Jericho Tpk., Syosset, N.Y. 11791 Tel: (516) 921-7700
 Distribution: M/End, Br
 Product: LAFAYETTE 8-tr & cassette decks/rec'rs, amplifiers, tuners, receivers, turntables, microphones (condenser, dynamic, wireless), noise reduction systems, headphones, CRITERION speakers, styli—pickup
JAMES B. LANSING SOUND INC. (JBL), 8500 Balboa Blvd., Northridge, Calif. 91329 Tel: (213) 893-8411 Telex: 691473 Cable JABALES Pres. Jerry Kalov, Sales Mgr. Ronald H. Means, Adv. Mgr. Curtis Pickette
 Distribution: M/Ret. M/OEM, M/C
 Product: JBL amplifiers, speakers
LA SCALA, see Klipsch
LEAK, see Corona Corp.
MARK LEVINSON AUDIO SYSTEMS, Leederhill Or., Hamden, Conn. 06514 Tel: (203) 281-6333
 Distribution: M/Ret
 Product: Open reel decks/rec'rs, amplifiers, pre-amplifiers
LEXICON INC., 60 Turner St., Waltham, Mass. 02154 Tel: (617) 891-6790 Telex 923468 Cable LEXICON WHA Pres. Ron Noonan, Sales Mgr. Keith Worcester, Adv. Mgr. Oerk Hersum
 Branch: San Francisco, Calif., 185 Berry St., Suite 3865 Zip 94107 Tel: (415) 495-8830
 Distribution: M/End, M/C, IO, M/Rep
 Product: Digital audio delay processors, reverb units
LITTLE RED, see Audiomarketing
LUSTRE, see Sumko
LUX AUDIO OF AMERICA LTD., 160 Dupont St., Plainview, N.Y. 11803 Tel: (516) 349-7070
 Home office: Japan
 Distribution: M/Ret
 Product: LUX, LUXMAN cassette decks/rec'rs, amplifiers, pre-amplifiers, tuners, receivers, turntables, tonearms, equalizers (graphic).
LUXMAN, see Lux Audio
LYNN STEWART CO., 439 E. Illinois St., Chicago, Ill. 60611 Tel: (312) 664-1515
 Product: Tape playback equip.
M C I INC., 1400 W. Commercial Blvd., Fort Lauderdale, Fla. 33309 Tel: (305) 491-0825 Telex 514362 Pres. G. C. Harned, VP Mktg. Lutz H. Meyer, Adv. Mgr. Larry Lamoray
 Distribution: IO
 Product: Open reel (professional) rec'rs, mixers, synchronizers.
M I T, see John Marouskis
M & K, see Miller & Kresel
M X R INNOVATIONS INC., 740 Orving Park Ave., Rochester, N.Y. 14613 Tel: (716) 254-2910 Telex 978451 Pres. Keith Barr, Gen. Mgr. Phil Belette, Sales Mgr. Lindsay Freese, Adv. Mgr. Gerald Brown
 Distribution: M/Ret
 Product: Pre-amplifiers, equalizers (graphic), noise reduction systems, digital delay systems, limiters
MAGNADYNE CORP., 1111 E. Victoria, Carson, Calif. 90746 Tel: (213) 639-2200
 Product: Tape playback equip.
MAGNEPAN INC., 1645 Ninth St., White Bear Lake, Minn. 55110 Tel: (612) 426-1645
 Product: MAGNEPLANAR speakers
MAGNEPLANAR, see Magnepan
MARANTZ CO. INC., 20525 Nordhoff St., Chatsworth, Calif. 91311 Tel: (213) 998-9333 Pres. Fred Tushinsky
 Product: MARANTZ cassette decks/rec'rs, amplifiers, pre-amplifiers, tuners, receivers, speakers, turntables, SUPERSCOPE BY MARANTZ cassette decks/rec'rs (portable), speakers, microphones, headphones
JOHN MAROUSKIS AUDIO SYSTEMS INC., 2889 Roebing Ave., Bronx, N.Y. 10461 Tel: (212) 892-7419 Pres. John Marouskis
 Distribution: M/Ret

Load Yours The Way The Giants Do.

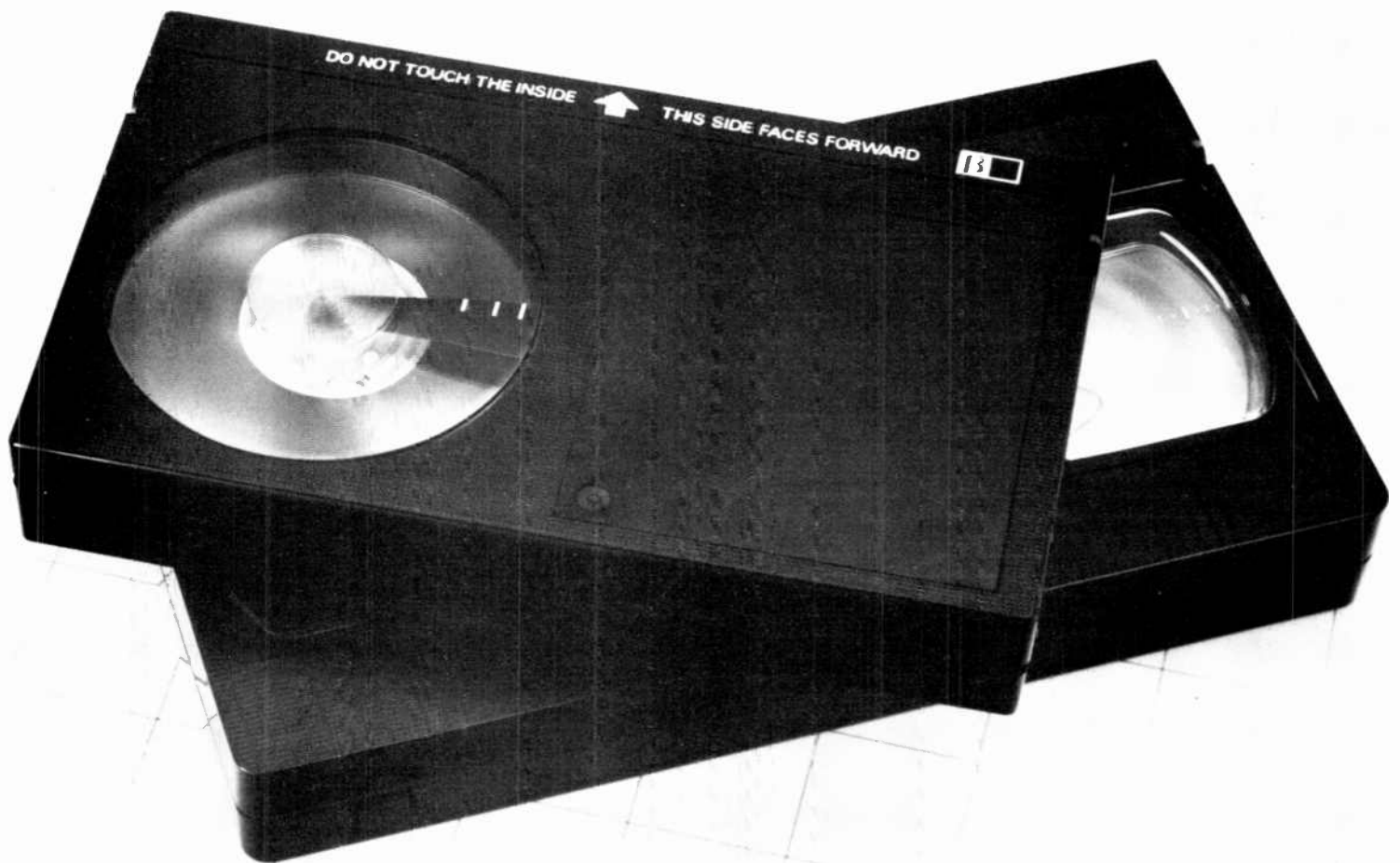

Otari has sold video tape loading equipment to: Ampex, BASF, Dupont, Memorex/Bell & Howell, & 3M.

Contact Mr. Michael Pappas, Industrial Products Sales Engineer at (415) 592-8311. He'll be happy to give you full information on a complete line of:

- Beta & VHS Video Loaders
- Automated Video hub leadering machines
- High Speed audio tape duplicating systems

Find out why Otari is the world leader in automated video blank tape loaders.

The Newest Workhorses

OTARI

Industrial Products Division/U.S. Sales Office
Otari Corporation, 2 Davis Drive
Belmont, California 94002
(415) 592-8311 Telex: 910-376-4890

International inquiries:
Otari Electric Co., Ltd.
4-29-18 Minami Ogikubo
Suginami-ku, Tokyo 167
(03) 333-9631
Telex: OTRDENKI J26604

Product: INTERPHASE amplifiers, MIT phono cartridges, JANIS subwoofers

MARSHALL, see Unicond

MATRECS ELECTRONICS, 805 Woodman Ave., Winslow, Ill 61089 Tel (815) 367 3811 Pres Loyd Ivey, Sales Mgr Robert Landsberg
Distribution: M/Ret., M/OEM, M/C ID, M/Rep

Product: Speakers

MCINTOSH LAB INC., 2 Chamber St., Binghamton, N.Y. 13903, Tel (607) 723 3512

Product: Amplifiers receivers speakers equalizers

MCKAY DYMEK CO., PO Box 5000 111 S College Ave., Claremont Calif 91711 Tel (714) 621-6711 TWX: (910) 581-4990 Chm George McKay Jr Pres Joseph Priske Sales Mgr Jack Peterson
Distribution: M/Ret., M/End
Product: Tuners (AM), AM antennas

McMARTIN INDS. INC., 4500 S. 76 St., Omaha, Neb 68127 Tel (402) 331 2000

Distribution: M/Rep

Product: Mixers amplifiers, pre amplifiers, tuners, receivers, turntables tonearms, equalizers

MESA ELECTRONICS SALES LTD., 2940 Malmo Dr., Arlington Heights, Ill 60005 Tel (312) 437-6500 Telex 726497 Pres Mark L Goldberg, VP & Adv Mgr M Sue Goldberg
Distribution: M/Rep
Product: Speakers

METEOR LIGHTING & SOUND, 155 Michael Dr., Syosset, N.Y. 11791 Tel (516) 364 1900 Pres Colin Hammond, Sales & Adv Mgr Vincent Finnegan Jr.
Branches: Huntsville, Ala., PO Box 6028 Zip 35806 Tel (205) 772 0251 Chief Exec Anthony Orton—Burbank, Calif., 3125 W Burbank Blvd Zip 91505 Tel (213) 846 0500
Distribution: M/OEM, M/C, IO, M/Rep

Product: CLUBMAN amplifiers, pre amplifiers; SOUND PANEL, SUPER SOUND PANEL speakers; METEOR amplifiers pre amplifiers speakers headphones
METRON, see Cerwin Vega

J.A. MICHELL, see Oick Wagner

MICRO-ACOUSTICS CORP., 8 Westchester Plaza, Elmsford N.Y. 10523 Tel (914) 592 7627 Pres Arnold Schwartz, Nat'l Sales Mgr Jonathan Kay, Int'l Sales Mgr Edward Schwartz
Distribution: M/Rep
Product: Speakers phono cartridges (electret), styli

MICRON, see General Sound

MICRO-TRAK CORP., 620 Race St., Holyoke Mass 01040 Tel (413) 536-3551 Pres & Adv Mgr William E. Stacy, Sales Mgr Alan Newhouse
Distribution: M/Ret., M/OEM, M/End, M/C, IO

Product: Open reel decks/rec'rs, mixers, amplifiers, pre amplifiers, turntables tonearms audio production systems

MILLER & KREISEL SOUND INC., 10391 Jefferson Blvd., Culver City, Calif 90230 Tel (213) 204-2854 Pres Ken Kreisel, Sales Mgr Steve Smith; Adv Mgr Chuck Back
Distribution: M/Rep
Product: M&K speakers (sub woofers & satellite systems), electronic crossovers

MINEROFF ELECTRONICS INC., 946 Downing Rd., Valley Stream, N.Y. 11580 Tel (516) 825 4702 Cable UHER Pres Saul Mineroff, Sales Mgr A Mineroff Adv Mgr M Sapin
Distribution: M/Ret., M/C, M/Rep

Product: UHER cassette & open reel decks/rec'rs, mixers, amplifiers, pre amplifiers, headphones, SME rec'rs, pre-amplifiers, microphones (condenser dynamic, wireless)

MINNEAPOLIS SPEAKER CO. (MISCO), 3806 Grand Ave. S., Minneapolis, Minn 55409 Tel (612) 825 1010
Distribution: M/Rep
Product: MISCO REOLINE speakers

MISCO-REDLINE, see Minneapolis Speaker

MIYABISHI ELECTRIC SALES AMERICA INC., 3030 E Victoria St., Compton, Calif 90221 Tel (213) 537 7132 Pres Y Yamaguchi, Sales Mgrs (video) Steve Saake, (audio) Fred Hartfelder, Adv Mgr E Sheppard (Also see listing under VIDEO)

Branch: Lincolnwood, Ill., 7045 N Ridgeway Ave Zip 60645 Tel (312) 973 2000 Branch Mgr Y Yamashita
Distribution: M/Ret

Product: Cassette (home, auto) decks/rec'rs, amplifiers, pre amplifiers, tuners, receivers, speakers turntables

MONITOR, see Sonoc Int'l

MORDAUNT-SHORT INC., 1919 Middle Country Rd., Centereach, N.Y. 11720 Tel (516) 981 0066 Pres Michael C Short, VP & Gen Mgr. Joel Schwartz
Distribution: M/Ret
Product: Speakers

N A D, see New Acoustic Dimension.

N E I, 934 NE 25 Ave., Portland, Ore 97232 Tel (503) 232 4445 Pres Bob Herb Sales & Adv Mgr H.C. Bud Garrison
Distribution: M/Rep

Product: Mixers, amplifiers, equalizers (parametric), real time analyzers, electronic crossovers, reverb systems

NADY SYSTEMS INC., 1145 65 St., Oakland Calif 94608 Tel (415) 652 2411 Pres John Nady, Mktg Dir Byron Stone Sales Mgr Peter T. Kalmen
Distribution: M/Ret., M/OEM, M/Rep

Product: Microphones (wireless)

NAGATRONICS CORP., 2280 Grand Ave., Baldwin, N.Y. 11510 Tel (516) 546 3295 Pres David B Monson Sales Mgr Seth E Hochman
Distribution: M/Rep

Product: Phono cartridges (magnetic), styli—pickup

NAGRA MAGNETIC REC'RS INC., 19 W 44 St., New York, N.Y. 10036 Tel (212) 840 0999
Distribution: IO

Product: Open reel rec'rs, speakers

NAKAMICHI USA CORP., 1101 Colorado Ave., Santa Monica Calif 90401 Tel (213) 451 5901 Pres Niro Nakamichi, Exec VP & Gen Mgr Kat-sura Izumi
Branch: Carle Place, N.Y., 220 Westbury Ave Zip 11514 Tel (516) 333-5440
Distribution: M/Ret., M/Rep

Product: Cassette decks/rec'rs, receivers, microphones (condenser dynamic), noise reduction systems

NAMIKI USA, Century Plaza, 15 Essex Rd., Paramus N.Y. 07652 Tel (201) 368 8310
Home office: Japan
Distribution: M/OEM

Product: Tonearms styli—pickup magnetic heads (audio & data) side force gauges disk stabilizers

NEUMANN, see Gotham Audio

RUPERT NEVE INC., Berkshire Ind'l Park, Bethel, Conn 06801 Tel (203) 744 6230 Telex 969638 Pres & Adv Mgr Tore B Nordahl, Mktg Mgr Anthony H Langley

Branches: Hollywood, Calif., 7533 Sunset Blvd Zip 90046 Tel (213) 874 8124 Telex 194942 Reg'l Sales Mgr P Horsman—Nashville, Tenn., PO Box 120907 Zip 37212 Tel (615) 385 2090
Int'l branches: Canada, England, Germany
Distribution: M/End, M/C, Br

Product: LYREC open reel decks/rec'rs, NEVE equalizers

NEW ACOUSTIC DIMENSION (NAD) (USA) INC., PO Box 98, Irlington, Mass 02090 Tel (617) 769-7050 Telex 924442 Pres Martin L Borish, Sales Mgr Peter D Tribeman Admin Dir & Adv Mgr Janet K Boynton
Distribution: M/Rep

Product: NAD cassette decks/rec'rs, amplifiers, tuners, receivers, turntables, phono cartridges

NEWCOMB AUDIO PRODS. CO., 12881 Bradley Ave., Sylmar Calif 91342 Tel (213) 367 1921
Product: Tape playback equip

NIKKO ELECTRIC CORP. OF AMERICA, 320 Oser Ave., Hauppauge, N.Y. 11787 Tel (516) 231 8181 Pres K Oeda, VP Sales & Mktg John Schroder
Distribution: M/Rep

Product: Amplifiers, pre-amplifiers, tuners, receivers, equalizers

NORDMENDE, see Sterling Hi-Fidelity

NORMAN LABS INC., 2278 Industrial Blvd., Norman, Okla 73069 Tel (405) 321 3205 Pres Oon Wyatt
Distribution: M/Ret

Product: Speakers speaker comparators

OAKTRON INDS., 1000 30 St., Monroe Wis 53566 Tel (608) 328 5560 Pres W L Rollins, Sales & Adv Mgr J F Oisch
Distribution: M/OEM, IO, M/Rep
Product: Speakers

OBEJISA, see Shanhman Acoustics

OHM ACOUSTICS CORP., 241 Taaffe Pl., Brooklyn, N.Y. 11205 Tel (212) 783 1111
Distribution: M/Ret

Product: Speakers

ONIKYO USA CORP., 42 07 20 Ave., Long Island City, N.Y. 11105 Tel (212) 728 4639 Pres S Tanaka; Nat'l Sales Mgr M Mark R Friedman, Adv Mgr Ken Furutani
Branches: Chatsworth, Calif., 20600 Nordhoff St Zip 91311 Tel (213) 998 6501—Wood Dale, Ill., 935 Sweet Or Zip 60191 Tel (312) 595 2970 Midwest Sales Mgr Frank Malitz
Distribution: M/Rep

Product: Cassette decks/rec'rs, amplifiers pre amplifiers, tuners, receivers, speakers, turntables, equalizers

OPAMP LABS INC., 1033 N Sycamore Ave., Los Angeles, Calif 90038 Tel (213) 934 3566 Pres B J Losmandy (Also see listing under VIDEO)
Distribution: M/OEM

Product: Amplifiers (mic, eq, line & power) pre amplifiers

OPTONICA DIV., SHARP ELECTRONICS, 10 Keystone Pl., Paramus, N.Y. 07652 Tel (201) 265 5600 Pres T Sugawa, Nat'l Sales Mgr: William Yanke
Distribution: M/Ret

Product: Cassette decks/rec'rs, amplifiers pre amplifiers, tuners, receivers, speakers, turntables

ORANGE COUNTY ELECTRONICS INT'L INC., c/o Parasong Inc., 680 Beach St., San Francisco Calif 94109 Tel (415) 673 4544 Telex: 278725 Cable 000B9YD
Distribution: IO

Product: Equalizers, compressor limiters

ORBAN ASSOCS. INC., 645 Bryant St., San Francisco, Calif 94107 Tel (415) 957 1063 Sales Mgr: Sid Goldstein
Distribution: M/Ret

Product: Equalizers, reverberation units, limiters, stereo synthesizers

ORTOFON, see Tannoy Ortofon

OSAWA & CO. (USA) INC., 21 Harbor Park Dr., Port Washington N.Y. 11050 Tel (516) 484-5455 Cable OSAWAUS, Telex 221562 Pres Y Oka moto VP Jack McMurray; Adv Mgr Vince Wheeler
Distribution: M/OEM, IO, M/Rep

Product: HECO speakers, ULTRACRAFT tonearms OSAWA, SATIN phono cartridges, styli—pickup

OTARI CORP., 1559 Industrial Rd., San Carlos, Calif 94070 Tel (415) 592 8311 TWX (910) 376 4890 Gen Mgr Jack Soma, Nat'l Sales Mgr Michael Bernard, Sales & Mktg Mgr Steve Krampf Int'l Sales Michael Pappas
Distribution: M/Ret., M/OEM, M/End, IO, M/Rep

Product: Open reel (professional) decks/rec'rs

OXFORD SPEAKER CO., 4237 W 42 Pl., Chicago Ill 60632 Tel (312) 927 3715 TWX (910) 221 5029 Pres Harry Moskow, Sales & Adv Mgr Larry Salzwedel
Distribution: M/OEM, M/End, M/C, IO

Product: OXFORD UTAH speakers

P A S, see Professional Audio Systems

P M L, see Ercona Corp

P Z M, see Crown Int'l

PANASONIC CO. (DIV. OF MATSUSHITA ELECTRIC CORP. OF AMERICA), 1 Panasonic Way, Secaucus, N.J. 07094 Tel (201) 348 7000 Pres Ken Kurahashi Exec VP Ray Gates, Exec VP & Treasurer Nat Gilbert, VP & Gen Mgr (Midwest Group) J Paul Michie, VP & Gen Mgr (Southern Group) F Jack Pluckhan, Gen Mgr (Electronic Components Div.) Todd Nagahisa, VP & Gen Mgr (Northeast Group) Ralph Wolfe, Gen Mgr (Video Systems Div.) Iku Izuka, Gen Mgr (Technics & Home Audio Div.) Jeff Berkowitz Acting Gen Mgr (Auto Prods Div.) Hisao Yam auchi Gen Mgr & Dir., Int'l Ops Lennart Harr (Exec office) local branch: 50 Meadowlands Pkwy Zip 07094 Tel 348 7000 (Also see listing under VIDEO)

Branches: Beverly Hills, Calif., Panasonic West, 8383 Wilshire Blvd Zip 90211 Tel (213) 655 1111—Cerritos, Calif., 17605 'A' Fabrica Way Zip 90701—Ouluth, Ga., Panasonic Atlanta, 1 Meca Way Zip 30136 Tel (404) 923-9700—Honolulu, Hawaii, Panasonic Hawaii, PO Box 774 Zip 96808 Tel (808) 847-5361—Arlington Heights, Ill., Panasonic Chicago 425 E Algonquin Rd Zip 60005 Tel (312) 364 7900—Baltimore, Md., Panasonic Baltimore, 11 Azar Court Zip 21227 Tel (301) 247 4300—Westwood, Mass., Panasonic Boston 75 University Ave Zip 02090 Tel (617) 326 4000—Carolina, P.R., Panasonic Sales Co., Vio tora Ind'l Park, Ave 65 de Infanteria Km 9.7 Zip 00630 Tel (809) 769 4320—Irrving, Tex., Panasonic Dallas, 1825 Walnut Hill Ln Zip 75062 Tel (214) 258 6400

Distribution: M/OEM, IO, M/Rep

Product: PANASONIC 8-tr & cassette decks/rec'rs magnetic heads, TECHNICS cassette & open reel decks/rec'rs amplifiers pre amplifiers,

tuners, receivers, speakers, turntables, microphones (condenser, dynamic), equalizers, headphones, meter systems, magnetic heads

PANASONIC CO. PROFESSIONAL AUDIO DIV., 1 Panasonic Way, Secaucus, N.J. 07094 Tel (201) 348 7000 Pres Ken Kurahashi, Asst Gen Mgr: Jim Parks, Sales Mgr Paul Aichel, Adv Mgr Bob Greenberg
Distribution: M/Rep

Product: RAMSA mixers, amplifiers, speakers, microphones (condenser, dynamic), mixer amplifiers; TECHNICS R&B open reel decks/rec'rs, amplifiers, pre amplifiers, speakers, turntables, tonearms, phono cartridges

PAOLI HIGH FIDELITY CONSULTANTS INC., PO Box 876, Paoli, Pa 19301 Tel (215) 644 7083

Product: Amplifiers, pre amplifiers

PARALLAX, see Wood Specialty

PASO SOUND PRODS. INC., 14 First St., Pelham, N.Y. 10803 Tel (914) 738 4800 Pres Paul Mastrangelo
Distribution: ID, M/Rep

Product: Mixers, amplifiers, pre-amplifiers, speakers, microphones (dynamic), intercoms

PEERLESS AUDIO MFG., 40 Jlytek Dr., Leominster, Mass 01453 Tel (617) 537 6001
Distribution: M/Ret., M/OEM, IO, M/Rep

Product: Speakers

PFANSTIEL, 3300 Washington St., Waukegan, Ill 60085 Tel (312) 623 1360 Pres Merle R Nelson; Adv Mgr Robert B Wight (Sold only through authorized dealers & distributors.)
Distribution: M/Ret., M/OEM, IO

Product: Phono cartridges, styli—pickup, cables, connectors

PHANTOM, see Kintel Audio

PHASE LINEAR CORP., 20121 48 Ave. W., Lynnwood, Wash. 98036 Tel (206) 774 3571 Cable PHASE SEATTLE TWX (910) 449 2851 Pres Donald E Prewett, VP Sales Bruce Lowry, Nat'l Sales Mgr (pro prods) Larry Winter
Distribution: M/Rep

Product: Amplifiers, pre amplifiers, tuners, speakers, turntables equalizers noise reduction systems, crossovers

PHILMORE MFG. CO., 40 Imp Dr., Inwood, N.Y. 11696 Tel (516) 239 6161
Branch: North Hollywood, Calif., 11045 Weddington St Zip 91601 Tel (213) 763 8241
Distribution: ID, M/Rep

Product: Amplifiers, pre amplifiers, tuners, tonearms, microphones (condenser, dynamic), headphones

PIIONEER, see U S Pioneer

PLASMATRONICS INC., 2460 Alamo SE, Suite 101 Albuquerque, N.M. 87106 Tel (505) 843 9430 Pres Alan E Hill, Sales & Adv Mgr Carol A Hill.
Distribution: M/Ret

Product: HILL TYPE 1 speaker systems (plasma type), HILL TYPE A direct drive amplifier

THE POO, see Hervic

POINT 3, see Great White Whale

POINT 4, see Great White Whale

POLK AUDIO INC., 1205 S Carey St., Baltimore, Md 21230 Tel (301) 837 4300 Telex 87993
Distribution: M/Ret

Product: Speakers

POLYDAX SPEAKER CORP., 2 Park Ave., Suite 2002, New York N.Y. 10016 Tel (212) 684 4442 Telex 237608 VP Serge F Ferre
Distribution: IO

Product: AUDAX, POLYOAX speakers

POLY-PLANAR, see ERA

POSTHORN REC'GS, 142 W 26 St., New York, N.Y. 10001 Tel (212) 242 3737 Pres Jerry Bruck, Sales Mgr Noel Harrington, Adv Mgr Marc Ochter
Distribution: ID

Product: SCHOEPS microphones (condenser)

POWER DRIVE, see Reotcon

POWER UP, see Kustom Kreations

PRECISION ELECTRONICS INC./GROMMES-PRECISION, 9101 King St., Franklin Park, Ill 60131 Tel (312) 678 5350 Pres William S Grommes, Sales Mgr. C Robert Franzen
Distribution: M/Ret., M/OEM, M/End, M/C, IO, M/Rep

Product: GROMMES PRECISION amplifiers, pre amplifiers tuners receivers equalizers, power amplifiers

PREMIER, see Sumiko

PROFESSIONAL AUDIO SYSTEMS, 1214 W 252 St Harbor City Calif 90710 Tel (213) 534 3570 Pres Larry Oran Sales Mgr Marilyn Do ran
Product: PAS speakers

PROGRAMMA-BUHL, see Buhl Inc

PULSE TECHNIQUES INC., 1411 Palisade Ave., Teaneck N.J. 07666 Tel (201) 837 2575 Sales Mgr E R Shenk
Distribution: M/End, IO

Product: PULTEC equalizers, filters

PULTEC, see Pulse Techniques

PYLE DRIVER, see Pyle Inds

PYLE INOS. INC., 501 Center St., Huntington, Ind 46750 Tel (219) 356 1200 Pres Frank Pyle Jr., Sales Mgr Ooris Swain, Adv Mgr Kent Pyle
Distribution: M/OEM, IO, M/Rep
Product: PYLE DRIVER speakers

Q R K, see Broadcast Electronics

Q R K-ALPHA, see Broadcast Electronics

Q S C AUDIO PRODS. INC., 1926 Piacentia Costa Mesa Calif 92627 Tel (714) 645 2450 Pres Sales & Adv Mgr Barry Andrews
Distribution: M/Ret., M/C, M/Rep

Product: Amplifiers, electronic crossovers

QUAD, see Audiophile

QYSONIC RESEARCH CORP., 1301 N Tustin Ave., Anaheim Calif 92806 Tel (714) 524 1920
Distribution: IO, M/Rep
Product: Speakers

R C A COMMERCIAL COMMUNICATIONS SYSTEMS DIV., Front & Cooper Sts., Camden N.J. 08102 Tel (609) 338 3000 (Also see listing under VIDEO)
Product: Open reel rec'rs, amplifiers, speakers turntables styli—pickup microphones, equalizers

R C S AUDIO INT'L INC., 1314 34 St., New Washington, D.C. 20007 Tel (202) 342 0400 Pres Richard C Schaus, Sales Mgr Harvey Lane
Distribution: M/Ret

Product: AUDIOMASTER, SPENDOR speakers

R T R INDS. INC., 8116 Deering Ave., Canoga Park Calif 91304 Tel (213) 883 0116 Telex 181062 Chief Exec Officer & Sales Mgr Edward Oug gan Pres Robert Rehorst, Adv Mgr G T Thalberg
Distribution: M/Ret., M/OEM, M/Rep

Product: ACCULAB, AMERICAN MONITOR SYNERGISTICS RTR speakers

RABCD, see Harman Kardon
RADIO SHACK DIV., TANDY CORP., 1 Tandy Center Fort Worth Tex 76102 Tel (817) 390 3011 Cable AMATAYAMA Telex 758253 758263 Pres Lewis Kornfeld Exec VP Merchandising B Appel VP Adv D Becker man Merchandising Dir R Miller (Also see listing under VIDEO)
Distribution: ID Br
Product: REALISTIC 8 tr cassette & open reel decks/rec rs mixers amplifiers tuners receivers speakers turntables phono cartridges styli-pickup microphones (condenser dynamic) equalizers headphones public address equip home computers
RADIAN RESEARCH, see Becker
RAMKO RESEARCH INC., 11355 A Folsom Blvd Rancho Cordova Calif 95670 Tel (916) 635 3600 Pres Ray Kohfeld Sales Mgr Jack M Du cart
Distribution: M/End M/Rep
Product: 8 tr & cassette decks/rec rs amplifiers pre amplifiers equalizers distribution amps audio switchers
RAMSA, see Panasonic Co Professional Audio Div
RANDALL INSTRUMENTS INC., 1132 Duryea Irvine Calif 92714 Tel (714) 556 1030
Distribution: M/Ret
Product: Amplifiers pre amplifiers equalizers
RANK HIFI INC., 260 N Rt 303 West Nyack N Y 10994 Tel (914) 353 1914 VP Geoffrey Muller Western Reg Sales Mgr Derek Whiteman Adv Mgr Bil Keane
Distribution: M Ret M Rep
Product: WHARFEDALE speakers
REALISTIC, see Radio Shack
RECOTON CORP., 46 23 Crane St Long Island City N Y 11101 Tel (212) 392 6442 Pres Robert L Borchardt Exec VP Peter Wish VP Sales George Calvi Reg Sales Mgr Walter Wallenberg
Branch: Culver City, Calif., Marshank Sales 3940 Higuera St Zip 90230 Tel (213) 559 2591 Chief Exec Norman Marshank
Distribution: M Ret M OEM ID M Rep
Product: RECOTON styli pickup microphones (condenser dynamic) POWER DRIVE speakers equalizers headphones ULTRA MAGNETICS styli pickup
REFERENCE, see Hartley
REFERENCE MONITOR INT'L INC., 2380 C Camino Vida Roble Carlsbad Calif 92008 Tel (714) 438 1214 Pres J M Bradford
Distribution: M Ret
Product: ROGERS amplifiers tuners speakers CHARTWELL speakers
REK-O-KUT, see ORK
RENAISSANCE, see Sound Lab
REVDX, see Studer Revox
ROCKER, see BlackMax
ROCK MONITOR, see BlackMax
ROGERS, see Reference Monitor
ROTEL OF AMERICA INC., 13528 S Normandie Ave Gardena Calif 90249 Tel (213) 327 0600 Pres T Tachikawa Sales Mgr Mel Kaplan Adv Mgr M Gregory
Distribution: M Ret M/OEM ID M/Rep
Product: Cassette decks rec rs amplifiers pre amplifiers tuners receivers turntables equalizers noise reduction systems
RUSSCO ELECTRONICS MFG. INC., 5690 E Shields Ave Fresno Calif 93727 Tel (209) 291 5591
Distribution: M Ret
Product: Amplifiers pre amplifiers turntables tonearms
RYSTL ELECTRONICS CORP., 328 NW 170 St North Miami Beach Fla 33169 Tel (305) 652 3838
Distribution: M Ret M OEM ID M Rep
Product: Cassette (auto) decks rec rs headphones
S A E, see Scientific Audio Electronics
S M E, see Mineroff
SABA, see Ultra Hi Fidelity
SAMSON, see Sam Ash
SANSUI ELECTRONICS CORP., PROFESSIONAL PRODS. DIV., 1250 Valley Brook Ave Lyndhurst N J 07071 Tel (201) 460 9710 VP Mktg & Sales Tom Yoda Adv Mgr Stuart I Goldberg
Home office: Japan
Distribution: M Rep
Product: Cassette decks rec rs amplifiers pre amplifiers tuners receivers speakers turntables microphones (condenser dynamic) equalizers headphones
SANYO ELECTRIC INC., 1200 W Artesia Blvd Compton Calif 90220 Tel (213) 537 5830 Pres T Takayama Sr VP William J Byron Adv Mgr Douglas Walmisley PR Mgr Mike Thomas (Also see listing under VIDEO)
Distribution: M Ret M Rep
Product: 8 tr & cassette (home auto) decks rec rs amplifiers tuners receivers turntables
SARAS OF AMERICA, 4150 Glencoe Ave Venice Calif 90291 Tel (213) 821 7927 Pres R Stoklos
Distribution: M/Ret
Product: Speakers

SATIN, see Osawa
SCHOEPS, see Posthorn
SCIENTIFIC AUDIO ELECTRONICS INC. (SAE) PROFESSIONAL PRODS. GROUP, 701 E Macy St Los Angeles Calif 90012 Tel (213) 489 7600 Pres Morris Kessler Adv & Sales Mgr Mark Cohen
Distribution: M Ret M C
Product: Cassette decks rec rs amplifiers pre amplifiers tuners receivers equalizers noise reduction systems headphones
H H SCOTT INC., 20 Commerce Way Woburn Mass 01888 Tel (617) 933 8800 Pres Solomon Boucai Mktg Mgr Ann Carlson Nat'l Sales Mgr William Wagner
Distribution: M Rep
Product: Cassette decks rec rs amplifiers pre amplifiers tuners receivers speakers turntables equalizers real time audio analyzers
SCULLY, see Ampro Scully
SEAS (USA), PO Box 64 Maple Glen Pa 19002 Tel (215) 643 7327 Telex 846341 Sales Mgr (USA) Edward A Laurent
Home office: Norway
Distribution: M OEM ID
Product: Speakers
SENNHEISER ELECTRONICS CORP., 10 W 37 St New York N Y 10018 Tel (212) 239 0190 Pres T Schilling VP I Hieret Sales Mgr C Hofman Adv Mgr Horst Ankermann
Distribution: M Ret M Rep
Product: Microphones (condenser dynamic wireless) headphones (standard & infra red wireless)
SERVOLINEAR AUDIO PRODS., see International Sound
SHAHINIAN ACOUSTICS LTD., 4 Selden Court Selden N Y 11784 Tel (516) 736 0033 Pres Richard Shahinian
Distribution: M Ret M Rep
Product: OBELISK SHAHINIAN ACOUSTICS speakers
SHARP ELECTRONICS, 10 Keystone Pl Paramus NJ 07652 Tel (201) 265 5600 Pres T Sugawa, Exec VP C N Dagneault, Sales Mgr Harvey Schneider Adv Mgr C Grill (Also see listing under VIDEO)
Distribution: M Ret ID M Rep
Product: Cassette decks rec rs amplifiers tuners speakers turntables
SHERWOOD ELECTRONICS (DIV. OF THE INREL CORP.), 17107 Kingsview Ave Carson Calif 90746 Tel (213) 515 6866 TWX (910) 346 6992 Pres S H Chue Sales Mgr David Daniels Adv Mgr Jeffrey Hipps
Distribution: M Ret M OEM
Product: Cassette decks rec rs mixers amplifiers pre amplifiers tuners receivers speakers turntables
SHOT-GLASS, see White Electronics
SHURE BROS. INC., 222 Hartrey Ave Evanston Ill 60204 Tel (312) 866 2200 Telex 724381 Cable SHUREMICRO
Distribution: M Ret M/Rep
Product: Amplifiers pre amplifiers speakers tonearms phono cartridges styli-pickup microphones (condenser dynamic ribbon) equalizers microphone accessories
SIGNET DIV., AUDIO-TECHNICA (US) INC., 4701 Hudson Dr Stow Ohio 44224 Tel (216) 688 9400 Pres (Audio Technica US) Jon R Kelly Nat'l Sales Mgr Howard K Brown Adv Mgr Donald Kirkendall
Distribution: M Rep
Product: Tonearms phono cartridges (magnetic moving coil) styli-pickup headphones
SNELL ACOUSTICS, 10 Prince Pl Newburyport Mass 01950 Tel (617) 462 3194
Distribution: M Ret
Product: Speakers
SOLAR AUDIO PRODS., 3228 E 50 St Los Angeles Calif 90058 Tel (213) 582 6383 Pres Scotty Stell Sales Mgr Sparky Wren
Distribution: M Ret ID M Rep
Product: ULTRALINEAR speakers
SONIC INT'L CORP., 12 Greek Ln Edison N J 08817 Tel (201) 287 8900
Distribution: M/Rep
Product: SONIC speakers headphones MONITOR STUDIO LAB speakers
SONIC RESEARCH INC., 27 Sugar Hollow Rd Danbury Conn 06810 Tel (203) 792 8822 Pres Peter E Pritchard Mktg & Sales Mgr Ronald E Wilcox Adv Mgr Elliot Edrick
Distribution: M Rep
Product: SONUS phono cartridges styli-pickup
SONIC SYSTEMS INC., 137 Rowayton Ave Rowayton Conn 06853 Tel (203) 838 8427
Distribution: M Ret ID
Product: SOUNDSPHERE speakers
SONUS, see Sonic Research
SONY CORP. OF AMERICA, 9 W 57 St New York N Y 10019 Tel (212) 371 5800 **Local branch:** 47 47 Van Dam St Long Island City 11101 Tel 361 8600 (Also see listing under VIDEO)
Distribution: Br
Product: SONY 8 tr cassette & open reel decks/rec rs amplifiers pre amplifiers tuners receivers speakers turntables tonearms phono cartridges styli pickup microphones (condenser dynamic ribbon) headphones



The Professional's Choice IN WIRELESS MICROPHONES

Unsurpassed performance, advanced audio engineering, comfortable styling and reliability never before found in a wireless microphone, make the Model 81 the only sensible choice in wireless microphones.

Cetec Vega

Division of Cetec Corporation
 P.O. Box 5348 • El Monte, CA 91731
 (213) 442-0782 • TWX: 910-587-3539

12-PAK CASSETTE RACK

... STRETCHING THE LIMITS OF MODERN TECHNOLOGY ...

YOU MUST SEE IT ...

D.C.L. MICROELECTRONICS INC.
 P.O. Box 2166, Seattle, Washington 98111

SOUND CONCEPTS INC., PO Box 135, Brookline, Mass. 02146. Tel: (617) 566-0110. Pres.: Joel M. Cohen; Sales & Adv. Mgr.: John J. Bubbers. Distribution: M/Ret., M/OEM, M/Rep.
Product: Time delay systems, image restoration control.

SOUNDCRAFT INC., 2025 Factory St., Kalamazoo, Mich. 49001. Telex: 224408. Chief Exec.: Tom Taylor.
Home office: England.
Distribution: M/Ret., IO.
Product: Open reel decks/rec's.

SOUNDCRAFTSMEN INC., 2200 S. Ritchey St., Santa Ana, Calif. 92705. Tel: (714) 556-6191. Pres.: Ralph Yeomans; Sales Mgr.: Roger Hagemeyer; Adv. Mgr.: Ron Bostelman.
Distribution: M/Rep.
Product: Amplifiers, pre-amplifiers, equalizers, audio analyzers.

SOUND-LAB INC., 5226 S. 300 W., No. 10, Salt Lake City, Utah 84107. Tel: (801) 262-8271. Pres., Sales & Adv. Mgr.: Roger West.
Distribution: M/Ret.
Product: RENAISSANCE speakers (electrostatic).

SOUNDMATES INC., 796-29 Ave. SE, Minneapolis, Minn. 55414. Tel: (612) 379-7700. Telex: 290049. Pres., Sales & Adv. Mgr.: Donald L. Kiewer.
Distribution: M/Rep.
Product: JANSZEN, SOUNDMATES speakers.

SOUND PANEL, see Meteor.

SOUND SOURCE INC., Blakely St., Cuthbert, Ga. 31704. Tel: (912) 732-3714. Pres.: Ernest A. Settles; Adv. Mgr.: Truman V. Low.
Distribution: M/Ret., IO, M/Rep.
Product: SOURCE, SOUND SOURCE speakers.

SOUNDSHERE, see Sonic Systems.

SOUND TECH SYSTEMS, 165 Fieldcrest Ave., Edison, N.J. 08817. Tel: (201) 225-2803. Sales Mgr.: Steven Beda. (Also see listing under VIDEO)
Distribution: M/Ret.
Product: 8-tr. & cassette decks/rec's, amplifiers, tuners, receivers, speakers, turntables.

SOURCE, see Sound Source.

SOUTHWEST TECHNICAL PRODS. CORP., 219 W. Rhapsody, San Antonio, Tex. 78216. Tel: (512) 344-0241.
Product: Amplifiers, pre-amplifiers, equalizers.

SPEAKERLAB INC., 735 N. Northlake Way, Seattle, Wash. 98103. Tel: (206) 633-5020.
Distribution: M/End, M/C, Br.
Product: Speakers.

SPECTRA SONICS, 3750 Airport Rd., Ogden, Utah 84403. Tel: (801) 392-7531. Pres.: William G. Dilley; Sales Mgr.: Gregory D. Dilley.
Distribution: M/Ret., M/OEM, M/C, ID, M/Rep.
Product: SPECTRA SONICS amplifiers, pre-amplifiers, speakers, microphones (wireless), equalizers; SPECTRA SOUND equalizers.

SPECTRA SOUND, see Spectra Sonics.

SPECTRO ACOUSTICS INC., 4500 150 Ave. NE, Redmond, Wash. 98052. Tel: (206) 882-1890. Pres.: John M. Coons; Mktg. Dir.: Don Jay.
Distribution: M/Rep.
Product: Amplifiers, pre-amplifiers, tuners, equalizers.

SPECTRUM, see Arista.

SPENDOR, see RCS.

SPICAL, 1570 Pacheco, Suite E-16, Santa Fe, N.M. 87501. Tel: (505) 988-5056. Pres.: W. John Bau.
Distribution: M/Ret.
Product: Speakers, audio cable.

STAGE, see Uncord.

STANDARD OF PERFORMANCE, see Grafy.

STANTON MAGNETICS INC., 200 Terminal Dr., Plainville, N.Y. 11803. Tel: (516) 349-0200. TWX: (510) 221-1845. Pres.: Walter O. Stanton; VP Professional Prods.: Jim Fox; Professional Prods. Nat'l Sales Mgr.: Pete Bidwell; Adv. Mgr.: Gordon Hurt; Media Coord.: Jean Kapen.
Distribution: M/OEM
Product: STANTON pre-amplifiers, phono cartridges, stylus-pickup, headphones, GYROPOISE, UNIPOISE turntables; DYNAPHASE headphones.

STARBUDD, see Accurate Sound.

STAR KYOGO INC., 940 E. Dominguez St., Carson, Calif. 90746. Tel: (213) 538-5878. Pres.: N. Hayashi; Sales & Adv. Mgr.: Michael Delmer.
Distribution: M/Rep.
Product: Amplifiers, pre-amplifiers, speakers, tonearms, phono cartridges, headphones, power supply for condenser mics.

STEPHENS ELECTRONICS INC., 3513 Pacific Ave., Burbank, Calif. 91505. Tel: (213) 842-5116. Pres.: John F. Stephens; Sales Mgr.: Bobbi Murphy; Adv. Mgr.: Gina D'Esopo.
Distribution: M/End, M/Rep.
Product: Open reel (1/2", 1", 2" professional) decks/rec's.

STERLING HI-FIDELITY INC., 22-20 40 Ave., Long Island City, N.Y. 11101. Tel: (212) 361-8989. Pres.: L. Silver; VP: R. Silver; Sales Mgr.: G. Weinstein.
Distribution: M/Ret., IO, M/Rep.
Product: NORDMENDE cassette decks/rec's, speakers, headphones.

STRAIGHTAWAY, see David Clark.

STUDER REVOX AMERICA INC., 1425 Elm Hill Pike, Nashville, Tenn. 37210.

Tel: (615) 254-5651. Pres.: Bruno Hochstrasser; Nat'l Sales Mgr.: Barry D. Evans; Adv. Mgr.: Gerald M. LeBow.
Branches: Van Nuys, Calif., 14046 Burbank Blvd. Zip: 91401. Tel: (213) 780-4234. Mgr.: Bill Van Doren—New York, N.Y., 155 Ave. of the Americas. Zip: 10013. Tel: (212) 255-4462. Mgr.: Fred Layn.
Distribution: M/Rep.
Product: STUOER open reel decks/rec's, amplifiers, tuners; REVOX open reel decks/rec's, amplifiers, tuners, receivers, speakers, turntables, microphones (dynamic), headphones.

STUDIO LAB, see Sonic Int'l.

SUMIKO INC., PO Box 5046, Berkeley, Calif. 94705. Tel: (415) 843-4500. Pres.: Blair M. Boyd; Sales Mgr.: Joe Abrams; Adv. Mgr.: David Fletcher.
Distribution: M/Rep.
Product: GRACE tonearms, phono cartridges, stylus-pickup, SUPEX phono cartridges, stylus-pickup, LUSTRE tonearms, ANDANTE phono cartridges, stylus-pickup, PREMIER phono cartridges (moving coil), step-up transformers.

SUNN MUSICAL EQUIP. CO., 19350 SW 89, Tualatin, Ore. 97062. Tel: (503) 638-6551. Pres.: Larry Lynn; Adv. Mgr.: Terry White.
Branch: Williamsstown, Ky., 107 Industrial Rd. Zip: 41097. Tel: (606) 824-5091. Plant Mgr.: Mike Ockendorf.
Distribution: M/Ret., M/Rep.
Product: Mixers, amplifiers, pre-amplifiers, speakers, microphones (condenser, dynamic), equalizers.

SUPEREX ELECTRONICS CORP., 151 Ludlow St., Yonkers, N.Y. 10705. Tel: (914) 965-6906. Mktg. Off.: Michael Solomon.
Distribution: M/Ret., M/OEM, M/Rep.
Product: AUDIO SCIENTIFIC amplifiers, pre-amplifiers, equalizers, SUPEREX headphones, tape duplication switchers.

SUPERSCOPE BY MARANTZ, see Marantz.

SUPER SOUND PANEL, see Meteor.

SUPLEX, see Sumiko.

SWITCHCRAFT INC., 5555 N. Elston Ave., Chicago, Ill. 60630. Tel: (312) 792-2700. TWX: (910) 221-5199. Pres.: W.P. Jones Jr.; Sales Mgr.: E. Larabee; Adv. Mgr.: G.F. Zib.
Distribution: M/Ret., M/OEM, M/Rep.
Product: Dolby FM compensators, audio cable assemblies.

SYMMETRY AUDIOPHILE SYSTEMS, 101 Townsend St., San Francisco, Calif. 94107. Tel: (415) 777-1113. Telex: 470584. Pres.: Noel Lee; Sales Mgr.: Garth Leerer; Production Mgr.: Andy Choy.
Distribution: M/Ret., IO, M/Rep.
Product: Pre-amplifiers, speakers, woofers & crossovers.

SYNERGISTICS, see RTR.

TANBERG OF AMERICA INC., Labriola Court, Armonk, N.Y. 10504. Tel: (914) 273-9150. Telex: 137357. VP: Tor Svartens.
Distribution: M/Ret., M/Rep.
Product: Cassette & open reel decks/rec's, amplifiers, pre-amplifiers, tuners, receivers.

TANNOY-ORTOFON INC., 122 Dupont St., Plainville, N.Y. 11803. Tel: (516) 349-9180.
Distribution: M/Ret.
Product: TANNONY speakers; ORTOFON pre-amplifiers, phono cartridges, stylus-pickup.

TAPCO, see EV-Tapco.

TAPE-ATON CORP., 502 S. Issis, Inglewood, Calif. 90301. Tel: (213) 776-6933. Pres.: Lee Tate; Sales Dir.: Bob Mayfield; Sales Mgr.: Blair Hunnicutt; Adv. Mgr.: Bob Haller.
Distribution: IO, M/Rep.
Product: Cassette & open reel decks/rec's, mixer amplifiers.

TASCAM, see Teac.

TEAC CORP. OF AMERICA, 7733 Telegraph Rd., Montebello, Calif. 90640. Tel: (213) 726-0303. Pres.: N. Tamura; Sales Mgr.: Barry Goldman; Adv. Mgr.: Tay Hotta. (Also see listing under VIDEO).
Branch: Little Ferry, N.J., 63 Bergen Tpk. Zip: 07643. Tel: (201) 641-5600. Office Mgr.: Manos Nomikos.
Home office: Japan.
Distribution: M/Rep.
Product: TEAC cassette & open reel decks/rec's, amplifiers, pre-amplifiers, tuners, turntables, microphones (condenser, dynamic, ribbon), equalizers, noise reduction systems; TASCAM open reel (professional) decks/rec's noise reduction systems.

TECH-CRAFT BY BOGEN, see Bogen.

TECHNICS, see Panasonic.

TECHNICS R&B, see Panasonic.

TELECOM, see Gotham Audio.

TELEFUNKEN, see Gotham Audio.

TELEPHONICS (DIV. OF ISC), 770 Park Ave., Huntington, N.Y. 11743. Tel: (516) 549-6000.
Product: Headphones.

TELEX COMMUNICATIONS INC., 9600 Aldrich Ave. S., Minneapolis, Minn. 55420. Tel: (612) 884-4051.
Distribution: M/OEM, IO, M/Rep.
Product: TELEX 8-tr. cassette & open reel decks/rec's, cartridge tape equip. (NAB standard), pre-amplifiers, headphones; TELEX/MAGNECOR open reel decks/rec's, TURNER microphones (dynamic, wireless).

TELEX/MAGNECOR, see Telex Communications.

THIEL AUDIO PRODS. CO., 4158 Georgetown Rd., Lexington, Ky. 40511. Tel: (606) 254-9427. Cable: THIELAUDIO. Pres.: James E. Thiel; Sales & Adv. Mgr.: Kathy Gornik.
Distribution: M/Ret.
Product: Speakers.

THOMPSON-CSF BROADCAST INC., 37 Brownhouse Rd., Stamford, Conn. 06902. Tel: (203) 327-7700. TWX: (710) 474-3346. Pres.: Thomas T. Calahan; VP & Mktg. Dir.: William Fink; Sales Mgr.: Richard T. Sanford; Adv. Mgr.: Abbey L. Miller. (Also see listing under VIDEO).
Branches: Burbank, Calif., 1919 W. Magnolia Blvd. Zip: 91506. Tel: (213) 849-2188. Western Reg'l Sales Mgr.: Mike Clayton—Peachtree City, Ga. 107 Tulipree Terr. Zip: 30269. Tel: (404) 487-6756. Southeastern Reg'l Mgr.: Frank D. Benson—Gurnee, Ill., 7644 Rae Ln. Zip: 60031. Tel: (312) 356-5575. Midwest Reg'l Sales Mgr.: Thomas D. Lorenzen—Alief, Tex., PO Box 905, Zip: 77411. Tel: (713) 933-1700. Sales Rep.: Martin J. McGreevy—Alexandria, Va., 8519 Buckboard Or. Zip: 22308. Wash., D.C. Tel: (202) 296-9189. Sales Rep.: Al Audick.
Distribution: M/OEM, M/End, M/C, ID, Br., M/Rep.
Product: THOMPSON-CSF amplifiers (distribution), equalizers, noise reduction systems (digital); AUDIMAX automatic level control; VOLUMAX automatic peak controller.

THORENS, see Epicure.

T M CO., 3M Center, St. Paul, Minn. 55101. Tel: (612) 733-1110.
Distribution: M/OEM, M/End, ID, Br.
Product: 3M open reel (professional) decks/rec's; WOLLENSAK cassette (audio-visual sync) decks/rec's.

TOSHIBA AMERICA INC., 280 Park Ave., New York, N.Y. 10017. Tel: (212) 557-0200. Telex: 224637. Cable: TOSHIBA. Pres.: Kuniyasu Kobayashi; Audio Sales Mgr.: Peter Dyke; Adv. Mgr.: Richard J. Meidenbauer. (Also see listing under VIDEO).
Distribution: M/Ret., IO, M/Rep.
Product: Cassette decks/rec's, amplifiers, pre-amplifiers, tuners, receivers, speakers, turntables, microphones (condenser), headphones.

TRACER, see BML.

TRIANGLE ACOUSTICS INC., 12721 SW 68 Ln., Miami, Fla. 33183. Tel: (305) 595-8234. Pres.: Todd Gifford Smith; Sales Mgr.: Tom Waters; Adv. Mgr.: Karen Smith.
Distribution: M/Ret., M/Rep.
Product: TRI-DELTA speakers.

TRI-DELTA, see Triangle Acoustics.

TRUCK, see Becker.

TRUSONIC, 10530 Lawson River Ave., Fountain Valley, Calif. 92708. Tel: (714) 964-3541.
Stokes.
Product: Speakers.

TURNER, see Telex.

U S JVC CORP., 41 Slater Dr., Elmwood Park, N.J. 07407. Tel: (201) 794-3900. Pres.: N. Sakoda; Sales Mgr.: Harry Elias; Adv. Mgr.: Cliff Shearer. (Also see listing under VIDEO).
Branches: Compton, Calif., 1011 W. Artesia Blvd. Zip: 90220. Tel: (213) 537-6020. Branch Mgr.: Michael Fleming—Elk Grove Village, Ill., 2250 Lively Blvd. Zip: 60007. Tel: (312) 364-9300. Branch Mgr.: Robert Vavra—Houston, Tex., 3400 S. Loop E. Zip: 77021. Branch Mgr.: Ed Spalding.
Distribution: M/Ret., M/Rep.
Product: Cassette decks/rec's, amplifiers, pre-amplifiers, tuners, receivers, speakers, turntables, phono cartridges, microphones (condenser, dynamic, ribbon), equalizers, headphones.

U S PIONEER ELECTRONICS CORP., 85 Oxford Or., Moonachie, N.J. 07074. Tel: (201) 440-8100. Pres.: Tamatsu Ichijo; VP Sales: Frank Leonard; Adv. Mgr.: Scott Slater; PR Dir.: Ronald F. Petty. Local branch: 75 Oxford Dr. Zip: 07074. Tel: 440-8100. Branch Mgr.: Sid Levy. (Also see listing under VIDEO).
Branches: Hawthorne, Calif., PO Box 404, 4880 Rosecrans Ave. Zip: 90250. Branch Mgr.: Dick Hendley—Elk Grove Village, Ill., 737 Fargo Ave. Zip: 60007. Tel: (312) 593-2960. Branch Mgr.: Jerry Sabino—Irving, Tex., 1875 Walnut Hill Ln. Zip: 75062. Tel: (214) 258-0200. Branch Mgr.: Peter Sartori.
Distribution: M/Rep.
Product: PIONEER cassette & open reel decks/rec's, mixers, amplifiers, pre-amplifiers, tuners, receivers, speakers, turntables, phono cartridges, microphones (dynamic), equalizers, headphones.

UHER, see Mineroff.

ULTRACRAFT, see Osawa.

ULTRA HI-FIDELITY DIST., 1001 E. Touhy Ave., Suite 112, Des Plaines, Ill. 60018. Tel: (312) 827-9818. Sales & Adv. Mgr.: Hank Allen.
Distribution: M/Ret., M/Rep.
Product: SABA cassette decks/rec's, amplifiers, tuners, receivers, speakers, turntables.

ULTRALINEAR, see Solar Audio.

ULTRA MAGNETICS, see Reclon.

UNICORD DIV. GULF + WESTERN MFG. CO., 89 Frost St., Westbury, N.Y. 11590. Tel: (516) 333-9100. Pres.: F. Meshowski; Mktg.: Michael Kovins.
Distribution: M/Ret.
Product: UNIVOX microphones (condenser, dynamic), STAGE, MARSHALL amplifiers; KORG echo units, vocoders.

UNIMPOSE, see Stanton.

UNITED AUDIO PRODS. INC., 120 S. Columbus Ave., Mount Vernon, N.Y. 10553. Tel: (914) 664-6211. Gen. Mgr.: Murray Rosenberg; VP Mktg. & Sales: Jay Schwab; Sales Mgr.: Martin Homlish.
Distribution: M/Rep.
Product: DUAL cassette decks/rec's, turntables.

UNITED RESEARCH LAB. CORP., 681 Fifth Ave., New York, N.Y. 10022. Tel: (212) 751-4663. Local branch: 16 E. 52 St. Zip: 10022.
Distribution: M/End, M/C, IO, M/Rep.
Product: AUTO-TEC open reel decks/rec's, amplifiers.

UNITRONEX CORP., 1171 Landmeier Rd., Elk Grove, Ill. 60007. Tel: (312) 437-9700. Telex: 283538. Pres.: S. Gajdzinski; Exec. VP: Donald J. Mucha; Nat'l Mktg. & Prod. Mgr.: Mike Gerutto, Sales Mgr.: Gary Brunner.
Distribution: M/OEM, M/Rep.
Product: IMPACT speakers.

UNIVOX, see Uncord.

UTAH, see Oxford Speaker.

V M P S AUDIO PRODS. (DIV. OF ITONE AUDIO), 7301 Rockway, El Cerrito, Calif. 94530. Tel: (415) 526-7084. Pres.: Brian Cheney; Sales Mgr.: Karen Richardson.
Branch: Modesto, Calif., 133 Kerr Ave. Zip: 95350. Tel: (209) 524-6968.
Production Chief: Gary Ellwell.
Distribution: M/Ret.
Product: Speakers.

VALLEY PEOPLE INC., (A merger of Allison Research & Valley Audio), 2820 Erica Pl., Nashville, Tenn. 37204. Tel: (615) 383-4737. Telex: 558610.

MISSION PLASTICS SOUTH, INC.

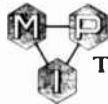

THE ONLY MANUFACTURER IN THE SOUTHEAST OF:

- C-0 Cassettes
- Eight-Track Cartridges
- Cassette Components
- Norelco Boxes

Call or Write

Sales Office:
 341 Hill Ave.
 Nashville, Tennessee 37210
 (615) 244-5668

Mfg. Facility:
 74 Mission Dr.
 Jackson, Tennessee 38301
 (901) 423-0810

Pres. Norman Baker; Exec. VP & Adv. Mgr. Bob Todrank; Sales Mgr. Michael Feniello.
Distribution: M/Ret., M/OEM, M/End, M/C
Product: KEPEx noise reduction systems; GAIN BRAIN limiters
VANDERSTEEN AUDIO, 1018 S. Mooney Blvd., Visalia, Calif. 93277 Tel (209) 625-0679
Distribution: M/Ret.
Product: Speakers, turntables.
VERTAS ELECTRONICS CORP., 22 Grand Ave., Farmingdale, N.Y. 11735. Tel (516) 541-5373
Product: Pre-amplifiers, headphones.
VISAM, see Visonik
VISONIK OF AMERICA INC., 701 Heinz Ave., Berkeley, Calif. 94710 Tel (415) 548-4005 TWX: (910) 366-7275 Pres. Henry Eberle, Sales Mgrs (east) Helmut Stieglitz, (west) Douglas Kim.
Distribution: M/Ret., M/Rep.
Product: VISONIK speakers, turntables; VISAM speakers
VDLUMAX, see Thomson-CSF
DICK WAGNER, 5930 Penfield Ave., Woodland Hills, Calif. 91367 Tel (213) 992-6266 Pres. Dick Wagner
Distribution: M/Ret.
Product: DICK WAGNER speakers, J.A. MICHELL turntables, tonearms
WALD SOUND INC., 11131 Dora, Sun Valley, Calif. 91352 Tel (213) 875-0480.
Product: Speakers
WHARFEDALE, see Rank Hi Fi
WHITE ELECTRONICS, 800 Morse Ave., Schaumburg, Ill. 60193 Tel (312) 529-7580.
Product: SHOT-GLASS speakers
WOLLENSAK, see 3M Co.
WOOD SPECIALTY PRODS., 1501 Vine St., Harrisonville, Mo. 64701 Tel (816) 884-5113 Pres.: David Kinney; VP. Gen. & Adv. Mgr. Roy L. Johnson
Distribution: M/Rep
Product: PARALLAX, CYGLAND, FOCUS speakers
WORLDEX MFG. CO. LTD., 1212 N. La Brea Ave., Hollywood, Calif. 90038 Tel: (213) 466-3324. Cable: WORLDEX. Pres. Louis R. Baptista; Sales Mgr. Carlos A. Lopez.
Distribution: M/End, ID
Product: Amplifiers, speakers, turntables
X K, see Kustom Kreations
YAMAHA INT'L CORP., PO Box 6600, Buena Park, Calif. 90620 Tel (714) 522-9011
Distribution: M/Rep.
Product: Cassette decks/rec's, amplifiers, pre-amplifiers, tuners, receivers, speakers, turntables, phono cartridges, headphones

VIDEO

ACTIVATED BY AKAI, see Akai
ADVENT CORP., 195 Albany St., Cambridge, Mass. 02139 Tel (617) 661-9500. Telex: 921479. Pres. Bernie Mitchell; Sales Mgr. Fred Goldstein, Adv. Mgr.: Margaret Bruzelius. (Also see listing under AUDIO)
Distribution: M/Ret.
Product: VIDEOBEAM large screen television/video projectors
AKAI AMERICA LTD., 800 W. Artesia, Compton, Calif. 90220 Tel (213) 537-3880 VP. C.E. Phillips, Adv. Mgr. Robert G. Caskley Jr. (Also see listing under AUDIO)
Distribution: M/Rep.
Product: ACTIVIDEO BY AKAI portable videocassette rec's (VHS), video cameras (portable-B&W, color).
AMPEX CORP., AUDIO-VIDEO SYSTEMS DIV., 401 Broadway, Redwood City, Calif. 94063 Tel (415) 367-2011 Telex: 348464 Pres. Arthur H. Hausman; Adv. Mgr. Al Fisher. (Also see listing under AUDIO)
Branches: Glendale, Calif., 500 Rodier Dr. Zip 91201 Tel (213) 240-5000 Reg'l Sales Mgr.: Tom Nielson—Atlanta, GA., 3135 Chestnut Dr. Suite 101, Zip 30340. Reg'l Sales Mgr. Paul Hansi—Arlington Heights, Ill., 719 W. Algonquin Rd. Zip 60005 Tel (312) 593-6000—Bethesda, Md., 10215 Fernwood Rd. Zip 20034 Tel (301) 530-8800 Reg'l Mgr. Frank Rush—Hackensack, N.J., 75 Commerce Way Tel (201) 489-7400 Reg'l Sales Mgr. Al Slater—Puerto Nuevo, P.R., Ampex Pan American Co., San Miguel Hermanos Bldg. Avenida Kennedy 1880. Oficinas 412 & 413 Zip: 00920. Tel (809) 781-1985—Dallas, Tex., 1615 Prudential Dr. Zip 75235. Tel: (214) 637-5100. Reg'l Sales Mgr.: Frank Nault
Int'l branches: Argentina, Australia, Belgium, Brazil, Canada, Colombia, England, France, Germany, Greece, Hong Kong, Italy, Japan, Mexico, Netherlands, Singapore, Spain, Sweden, Switzerland
Distribution: M/Ret, M/End, ID, M/Rep.
Product: Open reel video rec's (2" quad, 1" helical), video cameras (color)
BETACORD, see Sanyo.
BETAMAX, see Sony.
COLORMATION, see Roctronics
CONVERGENCE CORP., 1641 McGaw, Irvine, Calif. 92714 Tel (714) 549-3146 TWX (910) 595-2573. Pres. G. Bates, Domestic Sales Dir. R. Moscarello, Int'l Sales Dir., D. Lefebvre, Adv. Mgr. D. Talsma
Int'l branch: England.
Distribution: ID.
Product: Video editing equip
DISCOVISION ASSOCS., 3300 Hyland Ave., Costa Mesa, Calif. 92626 Tel (714) 957-3000. Pres.: John J. Reilly, VP Mktg. Robert T. Knight, Com. munications Dir. Erwin O. Okun
Distribution: M/OEM, M/End
Product: Industrial videodisk players (laser/optical)
ENTERTAINMENT 1 SYSTEMS, see Pyramid Mfg.
F & F SALES, PO Box 1047, Havertown, Pa. 19083 Tel (215) 477-8632 Telex: 902217 Chief Exec. Officer H. Melgin Fried, Pres. W. Matilda Fisher, Sales Mgr. Burt Brooks
Distribution: M/Ret., M/OEM, M/End, M/Rep
Product: ULTRAVISION large screen TV/video projectors, video projection screens (4', 5', 6', 7')
G C ELECTRONICS, 400 S. Wyanon St., Rockford, Ill. 61101 Tel (815) 968-9661. Telex: 257318. Cable: GCELECT. VP. Wayne Timpe, Sales Mgr. James E. Heighway, Adv. Mgr. Barry B. Nyquist (Also see listing under AUDIO)
Distribution: M/Ret, M/OEM, ID, M/Rep
Product: Video cables & connectors, transformers, band separators, maintenance kits.

MEDIA

MEDIA HOME ENTERTAINMENT, INC.

STACKS THEM UP

#1 Independent Video Manufacturer Worldwide!

116 N. ROBERTSON BLVD
 SUITE 701
 L.A., CA. 90048
 (213) 652-1542
 TOLL FREE
 (800) 421-4509



● THE COMPLETE ONE-STOP ● WE HAVE IT ● THE COMPLETE ONE-STOP ● WE HAVE IT ● THE COMPLETE ONE-STOP ● WE HAVE IT ● THE COMPLETE ONE-STOP ●

HOW CAN YOU SELL IT IF YOU DON'T HAVE IT? WE HAVE IT.

The most important things in records and video today are order-fill and prompt delivery. After all, how can you sell it if you don't have it?

We have it.

We carry all the major manufacturers and more. You get to pick from the largest inventory around. Be confident of filling your special orders.

You get what you want, when you want it -- be it records, tapes, video movies, **Atari & Mattel** electronic games, and all audio and video accessories.

THE COMPLETE ONE-STOP. WE HAVE IT.

Sound/Video Unlimited

Sound/Video Unlimited
 5404 West Touhy Avenue
 Skokie Illinois 60077
 312-674-0850 / 312-561-2500
 Toll Free 800-323-4243

Mile Hi One Stop
 150 Ric Grande Boulevard
 Denver Colorado 80223
 303-629-1960 / in CO 800-332-3813
 Out Of State 800-525-6094

Sound/Video Unlimited
 6912 North Tujunga Avenue
 North Hollywood, California 91605
 213-985-7602

● THE COMPLETE ONE-STOP ● WE HAVE IT ● THE COMPLETE ONE-STOP ● WE HAVE IT ● THE COMPLETE ONE-STOP ● WE HAVE IT ● THE COMPLETE ONE-STOP ●

G T E CONSUMER ELECTRONICS CO., 700 Ellicott St., Batavia, N.Y. 14020 Tel (716) 343 3470 Pres. M. Jones. VP Sales K. Thomson; Adv. Mgr.: V. Parker
Distribution: M/Ret. IO. Br
Product: PHILCO. SYLVANIA videocassette recs (VHS).

GENERAL ELECTRIC CO. VIDEO DISPLAY EQUIP. OPERATION, Electronics Park, Bldg. 6, Rm. 205, Syracuse, N.Y. 13221. Tel (315) 456-2562. TWX (710) 541-0498. Mgr. Allen P. Haase; Sales & Adv. Mgr. Jerrold P. Gun dersen.
Distribution: M/End, M/Rep
Product: Large screen television/video projectors

GIANT SCREEN TV, 308 N. Minnesota St., New Ulm, Minn. 56073 Tel (507) 354-3010. Sales Mgr. Paul A. Brown.
Product: VIDEO-MASTER large screen television/video projectors.

HITACHI SALES CORP. OF AMERICA, 401 W. Artesia Blvd., Compton, Calif. 90220 Tel (213) 774 5151 (Also see listing under AUDIO)
Distribution: M/Rep
Product: Videocassette recs (VHS) video cameras (color)

I V C, see International Video Corp.

INTERNATIONAL VIDEO CORP. (INC.), 455 W. Maude Ave., Sunnyvale, Calif. 94086 Tel (408) 738 3900. Cable (INTV). Telex 346404 Pres. John C. Frieberg

Branches: Covina, Calif., 1250 1 W. San Bernardino Zip 91722 Tel (213) 967-8955 Western Reg'l Mgr. Fielding Hedges—Atlanta, Ga., 3957 Pleasantdale Rd., Suite 107, Zip 30340 Tel. (404) 448-5443. Telex 708497—Elk Grove Village, Ill., 440 Bonnie Ln. Zip: 60007. Tel: (312) 439-1261. Telex 724305. Field Serv. Eng.: Robert Plazky—Kings Park, N.Y., 20 Robin Ln. Zip 11754. Tel (516) 269-5176 Eastern Reg'l Mgr. John Dransfield—Houston, Tex., 2019 Briarcreek Zip 77073 Tel (713) 443-8519. Field Serv. Eng.: Bob Poyner
Product: Open reel video recorders (1"). video cameras (studio & port able).

KALART VICTOR CORP., Hultenus St., Plainville, Conn. 06062 Tel (203) 747 1663 Pres. Leonard J. Quartin. Sales & Adv. Mgr. J.J. Costag.
Distribution: M/Ret. M/OEM, M/End, M/C, IO.

TELEBEAM II large screen television/video projectors, KALART VICTOR TV film chain projector (16mm)

KLOSS VIDEO CORP., 145 Sidney St., Cambridge, Mass. 02139. Tel (617) 547-6363. Pres. Henry Kloss. Sales Mgr. Tom DeVesto
Distribution: M/Ret
Product: NOVABEAM large screen television/video projectors

LASER DISC, see US Pioneer

MAGNAVOX CONSUMER ELECTRONICS CO., PO Box 6950, 140 & Straw Plains Pike, Knoxville, Tenn. 37914. Tel (615) 521 4439. Pres. Kenneth C. Meinken Jr.; Sales Mgr.: Robert P. Eastwood; Adv. Mgr. Rita Hutner
Distribution: M/Ret
Product: Videocassette recs (VHS), videodisk players (optical/laser), video cameras (portable)

ALLAN MARKOFF THEATERVISION INC., 61 North St., Middletown, N.Y. 10940. Tel (914) 343 0766 Cable VIDEO. TWX: (510) 260-8719. Pres. Allan Markoff, Exec VP: Alvin Barshop, Sales Mgr.: Rick Kinne; Adv. Mgr.: Doug Mathewson
Int'l branch: France.
Distribution: M/Ret. M/OEM, M/End, M/C, IO.
Product: THEATERVISION large screen television

MIAMI FLOCCA EQUIP. CO. INC., 304 NE 79 St., Miami, Fla. 33138 Tel (305) 751-8931.
Distribution: M/Ret. IO.
Product: Large screen television/video projectors, projection screens
MICROCAM, see Thompson-CSF

MITSUBISHI ELECTRIC SALES AMERICA INC., 3030 E. Victoria St., Compton Calif. 90221. Tel (213) 537-7132 Pres. Y. Yamaguchi; Sales Mgrs (video) Steve Saake, (audio) Fred Hartfelder; Adv. Mgr. E. Sheppard (Also see listing under AUDIO).

Branch: Lincolnwood, Ill., 7045 N. Ridgeway Ave Zip 60645 Tel (312) 973 2000 Branch Mgr. Y. Yamashita
Distribution: M/Ret
Product: Videocassette recs (VHS), large screen television/video pro jectors.

N E C AMERICA INC., 130 Martin Ln., Elk Grove Village, Ill. 60007 Tel (312) 640-3750. Sales Mgr. Dustin Vallahy, Adv. Mgr. A. Suguyama
Distribution: M/Rep
Product: Videocassette recs (U-matic), video cameras (color), large screen TV/video projectors, video monitors.

NATIONAL MICROTCH INC., PO Box 417, Grenada, Miss. 38901 Tel (601) 226-8432. Pres. Dave Fedric; Sales Mgr. Billy Ferguson, Adv. Mgr. Kenny Weaver
Distribution: ID
Product: Satellite receiving dish antennas

NOVABEAM, see Kloss Video

OMNIVISION, see Panasonic.

OPAMP LABS INC., 1033 N. Sycamore Ave., Los Angeles, Calif. 90038. Tel (213) 934-3566. Pres. B.J. Losmandy (Also see listing under AUDIO)
Distribution: M/OEM, M/End
Product: Video distribution amplifiers

PANASONIC CO. (DIV. OF MATSUSHITA ELECTRIC CORP. OF AMERICA), 1 Panasonic Way, Secaucus, N.J. 07094 Tel (201) 348 7000. Pres. Ken Kurahashi; Exec VP: Ray Gates, Exec VP & Treasurer Neil Gilbert; VP & Gen. Mgr. (Midwest Group) J. Paul Michie, VP & Gen. Mgr. (Southern Group) F. Jack Pluchkan; Gen. Mgr. (Electronic Components Div.) Todd Nagahisa, VP & Gen. Mgr. (Northeast Group) Ralph Wolfe, Gen. Mgr. (Video Systems Div.) Ike Izuka, Gen. Mgr. (Technics & Home Audio Div.) Jeff Berkowitz, Acting Gen. Mgr. (Auto Prods. Div.) Hsiao Yam auchi, Gen. Mgr. & Or., Int'l Ops. Lenhart Harr (Exec office) Local branch: 50 Meadowlands Pkwy Zip 07094 Tel 348 7000 (Also see list ing under AUDIO)

Branches: Beverly Hills, Calif., Panasonic West, 8383 Wilshire Blvd Zip 90211. Tel (213) 655-1111—Cerritos, Calif., 17605 "A" Fabrica Way Zip: 90701—Duluth, Ga., Panasonic Atlanta, 1 Meca Way Zip 30136 Tel (404) 923 9700—Honolulu, Hawaii, Panasonic Hawaii, PO Box 774 Zip 96808 Tel (808) 847 5361—Arlington Heights, Ill., Panasonic Chi cago, 425 E. Algonquin Rd. Zip 60005 Tel (312) 364 7900—Baltimore, Md., Panasonic Baltimore 11 Azar Court, Zip 21227 Tel (301) 247 4300—Westwood, Mass., Panasonic Boston 75 University Ave Zip 02090 Tel (617) 326-4000—Carolina, P.R., Panasonic Sales Co., Vic toria Ind'l Park, Ave 65 de Infantera KM 9.7 Zip 00630 Tel (809) 769 4320—Irvine, Tex., Panasonic Dallas, 1825 Walnut Hill Ln Zip 75062 Tel (214) 258 6400

Distribution: M/OEM, IO, M/Rep
Product: OMNIVISION videocassette recs (VHS), PANASONIC large screen television/video projectors, video cameras (B&W, color), monitors (B&W, color), special effects generators, "U" matic computer con trolled editing system.

PANORAMIC 2000 SALES, 2515 E. Anaheim Long Beach Calif. 90804 Tel (213) 433 0540 Pres. Wendel West Sales & Adv. Mgr. Raymond Kra vitz.
Distribution: M/Ret. ID, M/Rep
Product: Large screen television/video projectors

PHILCO, see GTE
PIONEER, see US Pioneer

PROFESSIONAL AUDIO VIDEO SERVS., 3117 Gillham Rd., Kansas City, Mo. 64109 Tel (816) 931 5070
Distribution: M/Ret. M/OEM, M/End, M/C, ID, Br
Product: SUPERVISION large screen television/video projectors, projec tion screens

PYRAMID MFG. INC., 13127 Harper Ave., Detroit Mich. 48213 Tel (313) 839-2888 Pres. Russ DiBartolomeo
Product: ENTERTAINMENT I SYSTEMS large screen television/video pro jectors

QUASAR CO., 9401 W. Grand Ave., Franklin Park, Ill. 60131 Tel: (312) 451 1200/2235 Pres. Alex Stone, VP & Gen. Mgr. James Ambrose, Sales Dr. Dick Mentzinger, Adv. & Sales Promo John Fortino

Branches: Birmingham, Ala., 1616 Second Ave S Zip 35233 Tel (205) 252 9041 VP & Gen. Mgr. Larry Kwokle—Tempe, Ariz., 733 W 22 St Zip: 85282 Tel (602) 967 3315 VP & Gen. Mgr. Hal Silverman—Fresno, Calif., PO Box 1989 Zip 93718, 104 Fulton St Zip 93721 Tel (209) 486-5700 VP & Gen. Mgr. Joe Conley—Los Angeles, Calif., 2041 Say brook Ave Zip 90040 Tel (213) 726 2900 VP & Gen. Mgr. Dave Chess—South San Francisco, Calif., 700 Forbes Blvd Zip 94080 Tel (415) 871 0915 VP & Gen. Mgr. Frank Holmstrom—Denver, Colo., 10515 E 40 St., Suite 107 Zip 80239 Tel (303) 371 1996 VP & Gen. Mgr.: Bob Bills—East Hartford, Conn., 111 Prestige Park Rd Zip 06108 Tel (203) 528 4491 VP & Gen. Mgr. Dave Isenberg—Miami, Fla., 16500 NW Seventh Ave Zip 33169 Tel (305) 620 9011 VP & Gen. Mgr. Neil Davis—Tampa, Fla., 424 Ware Blvd Zip 33619 Tel (813) 621 3402 VP & Gen. Mgr. Mitch Samaha—Indianapolis, Ind., 1365 Sadlier Circle S Dr Zip 46239 Tel (317) 353 9731 VP & Gen. Mgr. Tom Cowen—West-wood, Mass., 25 Dartmouth St Zip 02090 Tel (617) 329-5400 VP & Gen. Mgr. Peter Sikalis—Troy, Mich., Troy Trade Center, 1307 Allen Dr., Suite A Zip 48084. Tel (313) 588 8480 VP & Gen. Mgr. Don Uhl—Lyndhurst, N.J., 1050 Wall St W Zip 07071 Tel (201) 438 8100 VP & Gen. Mgr. Bob Gertz—Houston, Tex., 4540 S. Pinemont, Suite 110 Zip 77041 Tel (713) 462 5250 VP & Gen. Mgr. Bob Harmon—San Antonio, Tex., 10601 Sentinel Dr Zip 78217 Tel (512) 654 7755 VP & Gen. Mgr.: John Jackson—Tulwika, Wash., 220 Andover Park E Zip 98188 Tel (206) 246 8400 VP & Gen. Mgr. Bob Barman

Distribution: ID, Br
Product: Videocassette recs (home & portable) (VHS), video cameras (portable—B&W, color), video projectors

R C A CONSUMER ELECTRONICS DIV., 600 N. Sherman Dr., Indianapolis Ind. 46201 Tel (317) 267 5000 TWX (810) 341 3342 Pres. J.K. Sau ter, Sales Mgr. M.E. Kramer, Adv. Mgr. J.K. Devoe
Distribution: ID, Br
Product: SELECTAVISION videocassette recs (VHS), RCA video cameras (portable), large screen television/video projectors

R C A CONSUMER ELECTRONICS DIV., SELECTAVISION VIDEODISK OPNS., 7900 W. Rockville Rd., Indianapolis, Ind. 46224 Tel (317) 267 5000 Telex: 2733399 Pres. J.J. Brandinger, Sales Mgr. M.E. Kramer, Adv. Mgr. J.K. Devoe
Distribution: ID, Br
Product: SELECTAVISION videocassette recs (VHS), RCA video cameras (portable), large screen television/video projectors

RCA CONSUMER ELECTRONICS DIV., SELECTAVISION VIDEODISK OPNS., 7900 W. Rockville Rd., Indianapolis, Ind. 46224 Tel (317) 267 5000 Telex: 2733399 Pres. J.J. Brandinger, Sales Mgr. M.E. Kramer, Adv. Mgr. J.K. Devoe
Distribution: ID, Br
Product: SELECTAVISION videocassette recs (VHS), RCA video cameras (portable), large screen television/video projectors

RCA CONSUMER ELECTRONICS DIV., SELECTAVISION VIDEODISK OPNS., 7900 W. Rockville Rd., Indianapolis, Ind. 46224 Tel (317) 267 5000 Telex: 2733399 Pres. J.J. Brandinger, Sales Mgr. M.E. Kramer, Adv. Mgr. J.K. Devoe
Distribution: ID, Br
Product: SELECTAVISION videocassette recs (VHS), RCA video cameras (portable), large screen television/video projectors

RCA CONSUMER ELECTRONICS DIV., SELECTAVISION VIDEODISK OPNS., 7900 W. Rockville Rd., Indianapolis, Ind. 46224 Tel (317) 267 5000 Telex: 2733399 Pres. J.J. Brandinger, Sales Mgr. M.E. Kramer, Adv. Mgr. J.K. Devoe
Distribution: ID, Br
Product: SELECTAVISION videocassette recs (VHS), RCA video cameras (portable), large screen television/video projectors

RCA CONSUMER ELECTRONICS DIV., SELECTAVISION VIDEODISK OPNS., 7900 W. Rockville Rd., Indianapolis, Ind. 46224 Tel (317) 267 5000 Telex: 2733399 Pres. J.J. Brandinger, Sales Mgr. M.E. Kramer, Adv. Mgr. J.K. Devoe
Distribution: ID, Br
Product: SELECTAVISION videocassette recs (VHS), RCA video cameras (portable), large screen television/video projectors

RCA CONSUMER ELECTRONICS DIV., SELECTAVISION VIDEODISK OPNS., 7900 W. Rockville Rd., Indianapolis, Ind. 46224 Tel (317) 267 5000 Telex: 2733399 Pres. J.J. Brandinger, Sales Mgr. M.E. Kramer, Adv. Mgr. J.K. Devoe
Distribution: ID, Br
Product: SELECTAVISION videocassette recs (VHS), RCA video cameras (portable), large screen television/video projectors

Product: SELECTAVISION videodisk players (capacitance)
RADIO SHACK DIV., TANDY CORP., 1 Tandy Center, Fort Worth, Tex. 76102. Tel (817) 390-3011 Cable AMATAYAMA Telex 758253, 758263 Pres. Lewis Kornfeld; Exec VP: Merchandising B. Appel, VP Adv. D. Becker-man, Merchandising Dr. R. Miller (Also see listing under AUDIO)

Distribution: IO, Br
Product: REALISTIC videocassette players (capacitance)

REALISTIC, see Radio Shack

ROCTRONICS ENTERTAINMENT LIGHTING INC., 100-DS Roctronics Park, Pembroke, Mass. 02359 Tel (617) 826 8888 Pres. & Adv. Mgr. Rich ard Jacobucci, Sales Mgr. Judy Kirshner
Distribution: M/Ret. M/End, M/C, IO, M/Rep
Product: COLORMATION large screen television/video projectors.

SANYO ELECTRIC INC., 1200 W. Artesia Blvd., Compton, Calif. 90220 Tel (213) 537 5830 Pres. T. Takayama, Sr VP William J. Byron Adv Mgr Douglas M. Walmsley, PR Mgr. Mike Thomas (Also see listing under AUDIO)

Distribution: M/Ret. M/Rep
Product: BETACORD videocassette recs (Beta). SANYO video cameras (B&W color).

SCHUDEL INC., 6973 Consolidated Way, San Diego, Calif. 92121 Tel (714) 578 1770 Telex 181706 Pres. Conrad R. Schudel, Sales Mgr. James D. Mitchell, Office Mgr. Tina Norwood
Distribution: M/Ret. M/OEM, M/End
Product: Large screen television/video projectors, video projection screens.

SELECTAVISION, see RCA

SHARP ELECTRONICS, 10 Keystone Pl., Paramus, N.J. 07652 Tel (201) 265 5600 Pres. T. Sugawa, Exec VP. C.N. Daigneault, Sales Mgr. Harvey Schneider, Adv. Mgr. C. Grill (Also see listing under AUDIO)
Distribution: M/Ret. ID, M/Rep
Product: Videocassette recs (VHS), video cameras (color—studio & portable)

SONY CORP. OF AMERICA, 9 W. 57 St., New York, N.Y. 10019 Tel (212) 371 5800 Local branch: 47-47 Van Dam St. S. Long Island City 11101 Tel 361 8600 (Also see listing under AUDIO)

Distribution: Br
Product: BETAMAX videocassette recs (Beta), SONY videocassette recs (U-matic), video cameras

SOUND TECH SYSTEMS, 165 Fieldcrest Ave., Edison, N.J. 08817 Tel (201) 225 2803 Sales Mgr. Steven Beda (Also see listing under AUDIO)
Distribution: M/Ret
Product: Large screen TV/video projectors

STARBRATE, see Voorhies

SUPERVISION, see Professional Audio Video

SYLVANIA, see GTE

TAPE HEAD CO. INC., 665 S. State St., Salt Lake City, Utah 84111 Tel (801) 521 3838. Pres. Sales & Adv. Exec VP. Stan Schuchach
Distribution: M/Ret, M/End, M/C
Product: TELEPROSYS SYSTEMS large screen television/video projec tors

TEAC CORP. OF AMERICA, 7733 Telegraph Rd., Montebello, Calif. 90640 Tel (213) 726-0303 Pres. N. Tamura, Sales Mgr. Mace Sekine Adv Mgr. Tay Hotta (Also see listing under AUDIO)
Branch: Little Ferry, N.J., 63 Bergen Tpk Zip 07643 Tel (201) 641 5600 Office Mgr. Manos Nomikos
Distribution: M/Rep
Product: Videocassette recs (U-matic)

TELEBEAM II, see Kalart Victor

TELEPROSYS SYSTEMS, see Tape Head Co.

TELE VUE OPTICS INC., 15 Green Hill Ln., Spring Valley, N.Y. 10977 Tel (914) 354 4262 Pres. Albert Nagler, Sales Mgr. Judi Pearl
Distribution: M/OEM
Product: Lenses for projection television

THEATERVISION, see Allan Markoff

THOMPSON-CSF BROADCAST INC., 37 Brownhouse Rd., Stamford, Conn. 06902 Tel (203) 327 7700 TWX (710) 474 3346 Pres. Thomas T. Calahan, VP & Mktg. Dr. William Fink, Sales Mgr. Richard R. Sanford, Adv. Mgr. Abbey L. Miller (Also see listing under AUDIO)

Branches: Burbank, Calif., 1919 W. Magnolia Blvd Zip 91506 Tel (213) 849 2188 Western Reg'l Sales Mgr. Mike Clayton—Peachtree City, Ga., 107 Tuliptree Terr Zip 30269 Tel (404) 487 6756 Southeastern Reg'l Sales Mgr. Frank D. Benson—Gurnee, Ill., 7644 Rae Ln Zip 60031 Tel (312) 356 5575. Midwest Reg'l Sales Mgr. Thomas D. Lorenzen—Niief, Tex., PO Box 905 Zip 77411 Tel (713) 933 1700 Sales Rep. Martin J. McGreevey—Alexandria, Va., 8519 Buckboard Dr Zip 22308 Wash. D.C. Tel (202) 296-9189 Sales Rep. Al Audick
Distribution: M/OEM, M/End, M/C, ID, Br. M/Rep
Product: MICROCAM video cameras (color—hand held), THOMPSON-CSF video cameras (color—studio model), color correction systems, image en hancers, NTSC mode chroma insert keys, colorizer keyers, electronic character generator systems, digital video processors, digital videoplaxers, digital video multipliers

TOSHIBA AMERICA INC., 280 Park Ave., New York, N.Y. 10017. Tel (212) 557 0200 Telex: 224637 Cable TOSHIBA Pres. Kimiyasu Kobayashi, Adv. Mgr. Richard Meidenbauer (Also see listing under AUDIO)
Distribution: M/Ret. ID, M/Rep
Product: Videocassette recs (Beta—home & portable), video cameras (color. B&W)

TRANSVISION CORP., 5627 Paradise Dr., Corte Madera, Calif. 94925 Tel: (415) 924-6963 Pres. John Edmister, Sales Mgr. Bruce Joki, Adv. Mgr. Gordon Leele
Distribution: M/Ret. M/OEM, M/End, M/C, ID, M/Rep
Product: VIDIMAX large screen television/video projectors

U S JVC CORP., 41 Stater Dr., Elmwood Park, N.J. 07407 Tel (201) 794 3900 Pres. N. Sakoda, Sales Mgr. Harry Elias, Adv. Mgr. Cliff Shearer. (Also see listing under AUDIO)

Branches: Compton, Calif., 1011 W. Artesia Blvd Zip 90220 Tel (213) 537 6020 Branch Mgr. Michael Fleming—Elk Grove Village, Ill., 2250 Lively Blvd Zip 60007 Tel (312) 364 9300. Branch Mgr. Robert Vavra—Houston, Tex., 3400 S. Loop E Zip 77021 Tel (713) 741-3741. Branch Mgr. Ed Spalding
Distribution: M/Ret. M/Rep
Product: VIOSTAR videocassette recs (VHS), JVC videodisk players (VHD), video cameras (studio & portable—color & B&W), video editing equip

U S PIONEER ELECTRONICS CORP., 85 Oxford Dr., Moonachie, N.J. 07074. Tel (201) 440-8100 Pres. Tamatsu Iuchi, VP Sales Frank Leonardi; Adv. Mgr. Scott Slater, PR Mgr. Ron Petty Local Branch: 75 Oxford Dr Zip 07074 Tel 440 8100 Branch Mgr. Sid Levy (Also see listing under AUDIO)

Branches: Hawthorne, Calif., PO Box 404, 4880 Rosecrans Ave Zip 92050 Branch Mgr. Dick Hendley—Elk Grove Village, Ill., 737 Fargo Ave.
(Continued on page 32)

TAKE THE SAME PRIDE IN A VIDEOTAPE
AS YOU DO IN YOUR MUSIC



PROFESSIONAL MUSIC VIDEOTAPE
HOLLYWOOD 213-465-2484

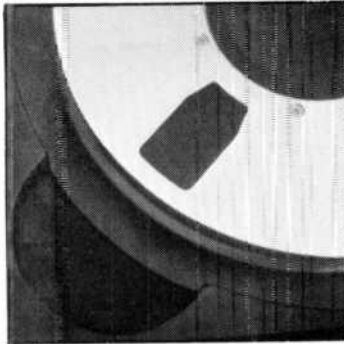

INTERNATIONAL AUDIO VIDEO TAPE DIRECTORY

PRE-RECORDED VIDEO SUPPLIERS

The following is a list of companies which are involved in the duplication, wholesaling/distribution, retailing & mail order of pre-recorded video. All videocassette product is in the NTSC (U.S. system) mode unless otherwise stated.

The key to the abbreviations used is: (D) duplicator, (R) retailer, (W/D) wholesaler/distributor, (MO) mail order house.

- A & H VIDEO SALES**, 430 W. 54 St., New York, N.Y. 10019. Tel: (212) 488-8156. Pres. Arthur Morowitz, Sales Mgr. Arnold Cantor (W/D).
Formats: Videocassette-Beta, VHS. (Also available in PAL mode).
Subjects: Adult, Children's, Feature Films, Gen. Entertainment, Music/Concerts, Sports, Instructional/Educational, Spanish Language Tapes.
- ADULT VIDEO CORP.**, 18121 Napa St., Northridge, Calif. 91325. Tel: (213) 886-8680. WATS (outside Calif.) (800) 423-5599. Sales Mgr. Steve Hirsch. (W/D).
Formats: Videocassette-Beta, VHS.
Subject: Adult.
- ADVANCED VIDEO COMMUNICATIONS**, 729 W. 16 St., No. A 4, Los Angeles, Calif. 90027. Tel: (714) 631-0370. Pres. Steve Shanafelt, Sales Mgr. Dave Weimar (R, MO).
Formats: Videocassette-Beta, VHS.
Subjects: Adult, Cartoons, Feature Films, Gen. Entertainment, Music, Sports, Instructional.
- ALLIED ARTISTS VIDEO CORP.**, 15 Columbus Circle, New York, N.Y. 10023. Tel: (212) 541-9200.
Formats: Videocassette-Beta, VHS.
Subjects: Adult, Cartoons, Feature Films, Gen. Entertainment, Music, Sports.
- ALL STAR VIDEO CORP.**, 3483 Hempstead Tpk., Suite BB, Levittown, N.Y. 11756. Tel: (516) 752-7898. Pres. B. Rubinowitz, Mktg. Dir. Les Rubinowitz (W/D, MO).
Formats: Videocassette-Beta, VHS. (Available in PAL & SECAM modes).
Subjects: Feature Films, Gen. Entertainment, Music.
- ALTEC DIST'G CO. INC.**, 36 Church St., Burlington, Vt. 05401. Tel: (802) 864-5777. Pres. Martin F. Gold, Sales Mgr. Billy Northrup. (W/D).
Formats: Videocassette-Beta, VHS, U-matic. (Also available in PAL & SECAM modes).
Subjects: Adult, Children's, Feature Films, Gen. Entertainment, Music/Concerts, Sports, Instructional/Educational.
- AMERICAN RADIO & TELEVISION PRODS INC.**, 488 Madison Ave., New York, N.Y. 10022. Tel: (212) 752-3178. Pres. Philip S. Kurnit, Programming Dir. Alan D. Hecht. (W/D).
Formats: Videocassette-Beta, VHS, U-matic. (Also available in PAL & SECAM modes).
Subjects: Children's, Gen. Entertainment, Music/Concerts, Instructional/Educational.
- A-1 VIDEO SERVS. INC.**, 7310 Biscayne Blvd., Miami, Fla. 33134. Tel: (305) 751-5808. Pres. Joe Wolff, Sales Mgr. Richard Pullen (W/D).
Formats: Videocassette-Beta, VHS. Videodisk-Laser/Optical.
Subjects: Children's, Feature Films, Gen. Entertainment, Music/Concerts, Sports, Instructional/Educational, Spanish Dubbed Titles.
- ASTROVIDEO/ASTRONICS**, 90 Golden Gate Ave., San Francisco, Calif. 94102. Tel: (415) 673-4320. Pres. David Gussock, Gen. Mgr. Marianne Waggoner, Sales Mgr. Mark Sterns. (D, MO).
Formats: Videocassette-Beta, VHS, U-matic. (Also available in PAL mode).
Subjects: Adult, Feature Films, Gen. Entertainment, Music/Concerts, Sports, NASA Space Programs.
- AUDIO-VIDEO PRODS, PO Box 5231**, Flint, Mich. 48508. Tel: (313) 233-4003. Pres. James Hamilton, Mktg. & Sales Mgr. Peggy Ivins. (MO).
Formats: Videocassette-Beta, VHS.
Subjects: Adult, Cartoons, Feature Films, Gen. Entertainment, Music, Sports.
- BENCHMARK FILMS INC.**, 145 Scarborough Rd., Briarcliff Manor, N.Y. 10510. Tel: (914) 762-3838. Pres. Myron Sofin, Sales Mgr. Karen Battersfield. (W/D).
Formats: Videocassette-Beta, VHS, L-matic.
Subjects: Informational, Educational.
- BEXLEY ART THEATRE**, PO Box 09635, 7484 E. Main St., Columbus, Ohio 43209. Tel: (614) 235-2342. Pres. Louis K. Sher, Sales Mgr. Denis R. Young. (MO, R, W/D).
Formats: Videocassette-Beta, VHS, U-matic, V-Cord. (Also available in PAL mode).
Subjects: Adult, Feature Films, Gen. Entertainment, Music/Concerts.
- BLACKHAWK FILMS**, Best Bldg., 235 W. Fifth St., Davenport, Iowa 52808. Tel: (319) 323-9735. Pres. & Sales Mgr. Ted Ewing. (D, R, MO).
Formats: Videocassette-Beta, VHS, U-matic.
Subjects: Cartoons, Feature Films, Gen. Entertainment, Music, Sports, Historical.
- BOX OFFICE VIDEO**, Dick Drost's Naked City, Roselawn, Ind. 46372. Tel: (219) 345-2000. Pres. Dick Drost, Sales Mgr. Raquel Fonda. (D, R, W/D, MO).
Formats: Videocassette-Beta & VHS, U-matic.
Subjects: Adult, Gen. Entertainment.
- BUDGET VIDEO INC.**, 4590 Santa Monica Blvd., Los Angeles, Calif. 90029. Tel: (213) 660-0187/0800. Pres. & Sales Mgr. Larry S. Fine. (D, R, W/D, MO).
Formats: Videocassette-Beta, VHS.
Subjects: Cartoons, Feature Films, Gen. Entertainment, Music, Sports.
- CABLE FILMS**, PO Box 7-71, Country Club Sta., Kansas City, Mo. 64113. Tel: (913) 362-2804. Pres. Herbert Miller, Sales Mgr. Marc Stevens. (D, R, W/D, MO).
Formats: Videocassette-Beta, VHS, U-matic. (Also available in PAL & SECAM modes).
Subjects: Adult, Children's, Feature Films, Gen. Entertainment, Music/Concerts, Sports, Instructional/Educational.
- Mgr. Todd Randall. (D, R, W/D, MO)**—Note: Also a Program Supplier for CATV & Television Stations.
Formats: Videocassette-Beta, VHS, U-matic. (also available in PAL & SECAM modes).
Subjects: Children's, Feature Films, Gen. Entertainment, Instructional/Educational, Documentary.
- CALIFORNIA INT'L RECS. & VIDEOWORKS INC.**, PO Box 2818, Newport Beach, Calif. 92663. Tel: (714) 497-3758. Pres. Joseph Nicoletti, VP & Gen. Mgr. Cheryl Lee Gammon.
- CINEMA CONCEPTS INC.**, 1805 Berlin Tpk., Wethersfield, Conn. 06109. Tel: (203) 529-0575. Pres. Joel G. Jacobson, Sales Mgr. Susan Gayle. (R, W/D, MO).
Formats: Videocassette-Beta, VHS, U-matic, Videodisk.
Subjects: Adult, Cartoons, Feature Films, Gen. Entertainment, Music, Sports.
- COLUMBIA AUDIO/VIDEO**, Laurel & Second Sts., Highland Park, Ill. 60035. Tel: (312) 433-6010. Pres. Gene R. Kahn, Sales Mgr. Bruce Berg. (R, W/D, MO).
Formats: Videocassette-Beta, VHS.
Subjects: Adult, Cartoons, Feature Films, Gen. Entertainment, Music, Sports, Educational/Instructional.
- COLUMBIA PICTURES HOME ENTERTAINMENT**, 711 Fifth Ave., New York, N.Y. 10022. Tel: (212) 751-4400. Telex. 12063. VP & Gen. Mgr.: Steven Schiffrer, Sales Dir.: Rob Blattner. (W/D).
Formats: Videocassette-Beta, VHS, Videodisk-Laser/Optical.
Subjects: Children's, Feature Films, Gen. Entertainment, Music/Concerts, Sports.
- COMMUNICATIONS GROUP WEST**, 6606 Sunset Blvd., Hollywood, Calif. 90028. Tel: (213) 462-7353. Pres. Sidney Galanty, Sales Mgr. Gary Horowitz. (W/D).
Formats: Videocassette-Beta, VHS, U-matic.
Subject: Educational.
- CONCEPT VIDEO PRODS INC.**, 3125 Burbank Blvd., Burbank, Calif. 91505. Tel: (213) 841-7030. (D, W/D, MO).
Formats: Videocassette-Beta, VHS.
Subjects: Adult, Gen. Entertainment, Music, Instructional.
- De MAIO VIDEO**, 20222 Morristown Circle, Huntington Beach, Calif. 92646. Tel: (714) 964-1979. Pres. Carl J. DeMaio, Sales Mgr. Diane M. DeMaio. (W/D, MO).
Formats: Videocassette-Beta, VHS.
Subjects: Children's, Feature Films, Gen. Entertainment, "Classic" Films.
- DISCOTRONICS FILMS INC.**, 50 N. Main St., Cranbury, N.J. 08512. WATS Tel: (800) 257-5108. Sales Mgr.: Bob Edwards. (R, MO).
Formats: Videocassette-Beta, VHS, Videodisk-Capacitance.
Subjects: Adult, Children's, Feature Films, Gen. Entertainment, Music/Concerts.
- DISCOUNT VIDEO TAPES INC.**, 1117 N. Hollywood Way, Burbank, Calif. 91505. Tel: (213) 843-3366. Pres. & Sales Mgr. Woody Wise. (D, MO, R, W/D).
Formats: Videocassette-Beta, VHS, U-matic.
Subjects: Children's, Feature Films, Gen. Entertainment, Music/Concerts, Sports, Instructional/Educational.
- ELECTRONIC ARTS INTERNATIONAL INC.**, 84 Fifth Ave., Rm. 301, New York, N.Y. 10011. Tel: (212) 989-2316. Pres.: Howard E. Wise. (W/D-Distributor only).
Formats: Videocassette-Beta, VHS, U-matic.
Subjects: Video Artworks & Independent Prods.
- ELECTRONICS CENTER INC.**, 1840 "D" St., Lincoln, Neb. 68508. Tel: (402) 476-7331. Pres.: R. Eastwood, Sales Mgr.: B. Kurtz. (MO).
Formats: Videocassette-Beta, VHS, Videodisk-Laser/Optical, Capacitance.
Subjects: Gen. Entertainment, Music/Concerts, Sports, Instructional/Educational.
- ENTERTAINMENT UNLIMITED VIDEO PROGRAMMING (DIV. OF INLAND TELEVISION TECHNOLOGIES)**, 4202 W. Jefferson Blvd., Los Angeles, Calif. 90016. Tel: (213) 733-7836. (D).
Formats: Videocassette-Beta, VHS, U-matic.
Subjects: Adult, Cartoons, Feature Films, Gen. Entertainment, Music, Sports, Vintage TV, Educational.
- ENTERTAINMENT VIDEO RELEASING/ULTIMATE INT'L VIDEO MOVIE CLUB**, 1 E. 57 St., New York, N.Y. 10022. Tel: (212) 664-0940. (D, MO).
Formats: Videocassette-Beta, VHS.
Subjects: Adult, Cartoons, Feature Films, Gen. Entertainment, Music, Nostalgia.
- FILM/VIDEO ENTERTAINMENT**, PO Box 1987, Richardson, Tex. 75080. Tel: (214) 783-8477. Sales Mgr. Mark Lambert. (W/D, MO).
Formats: Videocassette-Beta, VHS.
Subjects: Cartoons, Feature Films, Gen. Entertainment.
- FLANDERS SALES CO.**, 13702 Gamma Rd., Dallas, Tex. 75240. Tel: (214) 239-0216. Pres. Flip Flanders, Sales Mgr.: Rob Prudhomme. (Manufacturer's Rep.).
Formats: Videocassette-Beta, VHS.
Subjects: Cartoons, Feature Films, Gen. Entertainment, Music, Sports, Documentaries, Instructional.
- GOLDEN TAPES**, 336 Foothill Rd., Beverly Hills, Calif. 90210. Tel: (213) 550-0659. (R, W/D, MO).
Formats: Videocassette-Beta, VHS.
Subjects: Adult, Cartoons, Feature Films, Gen. Entertainment, Music, Sports.
- GOLDEN VIDEOCASSETTE LIBRARY**, 5415 Butler Rd., Bethesda, Md. 20016. Tel: (301) 656-7343, WATS (800) 638-8243. Pres.: Norman R. Selinger, Sales Mgr. Paul Clar. (D, R, W/D, MO).
Formats: Videocassette-Beta, VHS, U-matic.
Subjects: Adult, Cartoons, Feature Films, Gen. Entertainment, Music, Sports.
- HOLLYWOOD FILM EXCHANGE**, 1534 N. Highland Ave., Los Angeles, Calif. 90028. Tel: (213) 466-2431. Pres. & Sales Mgr.: Bruce Venezia. (D, R, W/D, MO).
Note: For all MO & W/D Opns. Contact Budget Video (see listing).
Formats: Videocassette-Beta, VHS.
Subjects: Adult, Children's, Feature Films, Gen. Entertainment, Music/Concerts, Sports, Documentary.
- HOME THEATRE**, 6464 Sunset Blvd., Suite 900, Hollywood, Calif. 90028. Tel: (213) 465-6121. Pres.: Alfred Landau, Sales Mgr.: Dran May. (D, MO, W/D).
Formats: Videocassette-Beta, VHS, U-matic. (Also available in PAL mode).
Subjects: Children's, Gen. Entertainment, Music/Concerts, Sports, Instructional/Educational.
- I A I RECS. & VIDEOTAPES**, 26 June St., New York, N.Y. 10014. Tel: (212) 243-2018. Pres.: C. Goss, Sales Mgr.: D.S. Good. (W/D).
Formats: Videocassette-Beta, VHS, U-matic. (Also available in PAL & SECAM modes).
Subject: Music.
- INOVISION CORP.**, PO Box 402425, 1250 American Pkwy., Dallas, Tex. 75240. Tel: (214) 661-4370. VP & Gen. Mgr.: Fred T. Mirick. (MO).
Formats: Videocassette-Beta, VHS, U-matic.
Subjects: Cartoons, Feature Films, Gen. Entertainment, Music, Sports, "Classic" Films, Instructional, Documentaries.
- INSTANT REPLAY VIDEOCASSETTE MAGAZINE**, 2980 McFarlane, Suite 210, Coconut Grove, Fla. 33133. Tel: (305) 448-7088. Pres.: Charles Azar, Sales Mgr.: Irv Reinhard. (D, W/D, MO).
Formats: Videocassette-Beta, VHS, U-matic, Technicolor (1/4" cassette). (Also available in PAL mode).
Subjects: Gen. Entertainment, Music/Concerts, Sports, Instructional/Educational, Video "Magazine."
- INTERMAG PRODS INC.**, 488 Madison Ave., New York, N.Y. 10022. Tel: (212) 688-7857. Pres.: Wilbur Freifeld. (W/D, MO).
Formats: Videocassette-Beta, VHS, U-matic.
Subject: Instructional.
- IVY VIDEO**, 165 W. 46 St., New York, N.Y. 10036. Tel: (212) 765-3940. Pres. Sidney Tager, Sales Mgr.: Martin Schlusserberg. (W/D).
Formats: Videocassette-Beta, VHS, U-matic.
Subjects: Cartoons, Feature Films, Gen. Entertainment, Music, Sports, Educational, Travel.
- M C A**, 100 Universal Plaza, Universal City, Calif. 91608. Tel: (213) 985-4321. Pres.: Jim Fiedler. (W/D).
Formats: Videodisk-Laser/Optical.
Subjects: Children's, Feature Films, Gen. Entertainment, Music/Concerts, Sports, Instructional/Educational.
- MAGNETIC VIDEO CORP.**, 23434 Industrial Park Court, Farmington Hills, Mich. 48024. Tel: (313) 477-6066, 476-2250. Pres.: Andre A. Blay, VP Jack Dreyer, Sales Mgr. Robert F. Cook. (D, W/D, MO).
Branch: Culver City, Calif., 8647 Hayden Pl. Zip: 90230. Tel: (213) 204-6806. Sales Mgr.: Anne Lieberman.
Formats: Videocassette-Beta, VHS, U-matic.
Subjects: Cartoons, Feature Films, Gen. Entertainment, Music, Sports, Instructional.
- MARSHALL-DISCOUNT VIDEO SERV.**, 3130 Edsel Dr., Trenton, Mich. 48183. Tel: (313) 671-5483. Pres. & Sales Mgr.: David W. Marshall. (MO).
Formats: Videocassette-Beta, VHS.
Subjects: Adult, Children's, Feature Films, Gen. Entertainment, Music/Concerts, Sports.
- MEDIA HOME ENTERTAINMENT INC.**, 116 N. Robertson Blvd., Suite 701, Los Angeles, Calif. 90048. Tel: (213) 652-1542. Telex: 194519. Pres.: Ron A. Safnick, Sales Mgr.: Bill Gluckman. (D).
Formats: Videocassette-Beta, VHS. (Also available in PAL & SECAM modes).
Subjects: Adult, Children's, Feature Films, Gen. Entertainment, Music/Concerts.
- MILE HI ONE STOP INC.**, 150 Rio Grande Blvd., Denver, Colo. 80223. Tel: (303) 629-1960, WATS (Colo.) (800) 332-3812. (outside Colo.) (800) 525-6094. Pres.: Noel Gimb. Mgr.: Bob Jacobs. (W/D).
Formats: Videocassette-Beta, VHS.
Subjects: Adult, Children's, Feature Films, Gen. Entertainment, Music/Concerts, Sports, Instructional/Educational.
- MITCHELL BROS. FILM GROUP**, 810 Van Ness Ave., San Francisco, Calif.

94109 Tel (415) 441 0903 WATS (800) 227 3400 Telex 125636
 Pres: James L. Mitchell, Sales Mgr. Jeffrey S. Armstrong (R, W/D, MO)
 Formats: Videocassette-Beta, VHS
 Subjects: Adult, Children's, Feature Films, Gen. Entertainment, Music/
 Concerts, Sports, Instructional/Educational

MODERN TALKING PICTURE SERV. INC., 5000 Park St. N., St. Petersburg, Fla. 33709 Tel (813) 541 7571 Pres: Carl Lentz VP & Sales Mgr.: Dan Kater (Free-loan distributor)
 Branches: Los Angeles, Calif., 1145 N. McCadden Pl. Zip 90038 Tel (213) 462 2202 VP Jack Whalen - Washington, D.C., 1901 "L" St. NW Zip 20036 Tel (202) 293 1222 VP Robert A. Kelley - Chicago, Ill., 2020 Prudential Plaza Zip 60601 Tel (312) 337 3252 VP Edwin L. Swanson - New York, N.Y., 45 Rockefeller Plaza. Zip 10111 Tel (212) 765 3100 Cable MOOTALK
 Int'l branch: Canada
 Formats: Videocassette-Beta, VHS, U-matic
 Subjects: Adult, Gen. Entertainment, Sports, Business

MOVIES UNLIMITED INC., 6736 Castor Ave., Philadelphia, Pa. 19149 Tel (215) 722 8298 Pres: Jerry Frebowitz (MO, R)
 Formats: Videocassette-Beta, VHS, U-matic, Videodisk-Laser/Optical, Capacitance
 Subjects: Adult, Children's, Feature Films, Gen. Entertainment, Music, Concerts, Sports, Instructional/Educational

N F I FILMS VIDEO, 330 Fellowship Rd., Mt. Laurel N.J. 08054 Tel (609) 778 1600 Pres: Ed Sabol, Sales Mgr. David A. Grossman (W/D)
 Formats: Videocassette-Beta, VHS, "i" CVC, Videodisk-Laser/Optical, Capacitance
 Subjects: Sports

NATIONAL VIDEO GROUP, 2029 Century Park E., Los Angeles, Calif. 90067 Tel (213) 553 3636 Pres: S. Gerald Stone, Nat'l Sales Mgr. Ron Friedman (MO)
 Formats: Videocassette-Beta, VHS
 Subjects: Cartoons, Feature Films, Gen. Entertainment, Music, Sports

NEBULAE PRODS INC., 31 90 140 St., Flushing, N.Y. 11354 Tel (212) 886 6242 Pres & Sales Mgr. Roy Kamen (W/D, MO)
 Formats: Videocassette-Beta, VHS, U-matic
 Subjects: Adult, Gen. Entertainment, "Video Wallpaper" (background visuals)

NEW PRODUCTS CO., State Hwy 73 & Fellowship Rd., Maple Shade, N.J. 08052 Tel (609) 779-1101 Pres: Fred J. O'Imperio, Sales Mgr. Phil Goldstein (W/D, MO)
 Formats: Videocassette-Beta, VHS
 Subjects: Adult, Cartoons, Feature Films, Gen. Entertainment, Music, Sports

NILES CINEMA INC., 1141 Mishawaka Ave., South Bend, Ind. 46615 Tel (219) 289 2845 Pres: Louis F. Freitag, VP & Sales Mgr. Paula Casey (W/D, MO)
 Formats: Videocassette-Beta, VHS
 Subjects: Cartoons, Feature Films, Gen. Entertainment, Music, Sports

THE NOSTALGIA MERCHANT, 6255 Sunset Blvd., Suite 1019, Hollywood, Calif. 90028 Tel (213) 464 1406, Pres: Nick Oraklich, VP. Earl Blair, Sales Mgr. Chuck Thagard. (D, W/D, MO)
 Formats: Videocassette-Beta, VHS, U-matic; Videodisk-Laser/Optical, Capacitance
 Subjects: Children's, Feature Films, Gen. Entertainment, Instructional/Educational

PACIFICA LABS., Box 813, Tarzana, Calif. 91356 Tel (213) 343-0588 Owner: O.S. Jenkins (R, MO)
 Formats: Videocassette-Beta, VHS
 Subjects: Cartoons, Feature Films, Gen. Entertainment, Sports

PARAMOUNT HOME VIDEO, 5451 Marathon St., Hollywood, Calif. 90038 Tel (213) 468 5000 Pres: Richard B. Childs, Sales Mgr. Paul Culberg (W/D)
 Formats: Videocassette-Beta, VHS
 Subjects: Children's, Feature Films, Gen. Entertainment

PERSPECTIVE FILMS, 65 E. S. Water St., Chicago, Ill. 60601, Tel (312) 977 4144 Pres: Robert Whitworth Sales Mgr. Patty Freed. (W/D-Distributor only)
 Formats: Videocassette-Beta, VHS, U-matic
 Subjects: Cartoons, Gen. Entertainment, Music, Educational

PIIONEER ARTISTS INC., 85 Oxford Dr., Moonachie, N.J. 07074 Tel (201) 440 8100 Pres: Barry M. Shereck (W/D)
 Formats: Videodisk-Laser/Optical
 Subjects: Gen. Entertainment, Music/Concerts

PROJECTAPIX LTD., 300 314 W. 53 St., New York, N.Y. 10019 Tel (212) 765 7869 Pres: Bob Fischer, VP. Harry Edelman, Sales Mgr. Steven Caspi (W/D)
 Formats: Videocassette-Beta, VHS, U-matic, V-Cord
 Subjects: Adult, Cartoons, Feature Films, Gen. Entertainment, Nostalgia

PYRAMID FILM & VIDEO, Box 1048, Santa Monica, Calif. 90406 Tel (213) 828 7577 Pres: David Adams, Sales Mgr. Pamela Land. (W/D)
 Formats: Videocassette-Beta, VHS, U-matic
 Subjects: Adult, Children's, Gen. Entertainment, Sports, Instructional/Educational

RED FOX ENTS., Rt. 209 E., Elizabethtown Pa. 17023 Tel (717) 362-3391 Pres: Ronald Knorr, Sales Mgr. Julie Hollenbauch (W/D, MO)
 Formats: Videocassette-Beta, VHS
 Subjects: Children's, Feature Films, Gen. Entertainment, Music/Concerts, Sports

ALBERT SCHULTZ INC., 116 W. 14 St., 6th fl., New York, N.Y. 10011 Tel (212) 924 1122 Cable: ALBYREP Telex 236569 Pres.: Albert Schultz, Sales Mgr. Ricardo Leon (Exporter)
 Formats: "i" Beta & VHS (Also available in PAL mode)
 Subjects: Adult, Children's, Feature Films, Gen. Entertainment, Music/Concerts, Sports, Instructional/Educational

SCORPIO ETC., 22714 Ventura Blvd., Woodland Hills, Calif. 91364 Tel (213) 884 6692 (W/D, MO)
 Formats: Videocassette-Beta I & II, VHS, U-matic
 Subjects: Adult, Feature Films

SELECT A TAPE, 8750 Holloway Dr., Los Angeles, Calif. 90069 Tel (213) 652 6552 Pres: Alan Roberts, Sales Mgr. Abe Roth Local branch: 8758 Holloway Dr. Zip 90069 Tel 659-9247 (D, W/D)
 Formats: Videocassette-Beta, VHS
 Subjects: Adult, Feature Films, Gen. Entertainment, Music/Concerts

SOUND/VIDEO UNLIMITED, 5404 W. Touhy, Skokie, Ill. 60077 Tel (312) 674 0850 Pres: Noel Gimbel, Sales Mgr. Jeff Tuckman (W/D)
 Branch: North Hollywood, Calif., 6912 Tujunga Ave. Zip 91605 Tel 985 7602
 Formats: Videocassette-Beta, VHS
 Subjects: Adult, Cartoons, Feature Films, Gen. Entertainment, Music, Sports

SPORTS WORLD CINEMA, PO Box 17022, Salt Lake City, Utah 84117 Tel (801) 486 3925 Pres: Gary Ewing, Sales Mgr. Linda Lamoreaux. (D)
 Formats: Videocassette-Beta, VHS, U-matic

Subject: Sports
STAR VIDEO ENTERTAINMENT INC., 225 W. 34 St., New York, N.Y. 10001 Tel (212) 695-8628 (W/D)
 Formats: Videocassette-Beta, VHS (Also available in PAL mode)
 Subjects: Cartoons, Feature Films

T V I, 1643 N. Cherokee, Hollywood, Calif. 90028 Tel (213) 462 6018. WATS (800) 421-4133 Pres: Phillip Bernstene, Sales Mgr. Michael Rogers (R, W/D, MO)
 Formats: Videocassette-Beta, VHS
 Subjects: Adult, Children's, Feature Films, Gen. Entertainment, Music/Concerts, Sports, Instructional/Educational

TAPE CITY INC., 404 Park Ave. S., New York, N.Y. 10016 Tel (212) 679 1606. 684 2020 Cable: TAPCITY Pres: Al Goldberger, Sales Mgr. Andy Wender (R, W/D, MO)
 Formats: Videocassette-Beta, VHS, U-matic. (Also available in PAL mode), Videodisk-Laser Optical, Capacitance
 Subjects: Adult, Children's, Feature Films, Gen. Entertainment, Music/Concerts, Sports, Instructional/Educational

THUNDERBIRD FILMS, PO Box 65157, 3500 Verdugo Rd., Los Angeles, Calif. 90065 Tel (213) 256 1034, Owner: Thomas W. Ounnaldoo (D, MO, R, W/D)
 Formats: Videocassette-Beta, VHS, U-matic
 Subjects: Children's, Feature Films, Gen. Entertainment, Music/Concerts, Sports, Adult

TIME-LIFE FILMS INC., Time Life Bldg., New York, N.Y. 10020 Tel (212) 841 4013 (D, R, W/D, MO)
 Formats: Videocassette-Beta, VHS
 Subjects: Cartoons, Feature Films, Gen. Entertainment, Music, Sports

TRIPLE X CHANGE SERV., 3125 W. Burbank Blvd., Burbank, Calif. 91505 Tel (312) 841-7426 (Adult Videocassette Exchange Service)
 Formats: Videocassette-Beta, VHS
 Subject: Adult

ULTIMATE INT'L VIDEO MOVIE CLUB, see Entertainment Video Releasing V C I, see Video Communications

V C I, 7313 Varna, North Hollywood, Calif. 91605 Tel (213) 764 0319 Telex: 651-461
 Formats: Videocassette-Beta, VHS (Some titles available in PAL mode)
 Subjects: Adult, Feature Films, Music, Sports

V T S ENTS., 19201 B Parthenia Ave., Northridge, Calif. 91324 Tel (213) 993 5332 (D, W/D)
 Formats: Videocassette-Beta, VHS
 Subjects: Adult, Feature Films, Gen. Entertainment, Music, Sports

VIDAMERICA INC., 235 E. 55 St., New York, N.Y. 10022 Tel (212) 355 1600 Pres: Alfred Markin, Mktg. Mgr. Joe Gunsberg, Direct Mail Programming Mgr. Meryl Fine (MO, W/D)
 Formats: Videocassette-Beta, VHS
 Subjects: Adult, Children's, Feature Films, Gen. Entertainment, Music/Concerts, Sports, Instructional/Educational

VIDEO ARTISTS INC., 11336 K-Tel Dr., Minnetonka, Minn. 55343 WATS Tel (800) 328 8181 Pres: Rand Charles Capp, Sales Mgr. Bill Hudlow. (R, W/D, MO)
 Formats: Videocassette-Beta, VHS, U-matic
 Subjects: Adult, Cartoons, Feature Films, Gen. Entertainment, Music, Sports

VIDEO-AUDIO ELECTRONICS INC., 153 W. Fourth St., Suite 35, Williamsport, Pa. 17701 Tel (717) 323-8756 (D, R, W/D, MO)
 Formats: Videocassette-Beta, VHS, U-matic
 Subjects: Adult, Cartoons, Feature Films, Gen. Entertainment, Music, Sports

VIDEOBRARY INC., 3518 W. Cahenga Blvd., Suite 301, Hollywood, Calif. 90068 Tel (213) 851 5811 (W/D, MO)
 Formats: Videocassette-Beta, VHS
 Subjects: Adult, Cartoons, Feature Films, Gen. Entertainment, Music, Sports, Nostalgia

VIDEOCASSETTE-OF-THE-MONTH-CLUB, PO Box 2000, Roselawn Ind. 46372 Tel (219) 345 2000 Telex 725486 Pres: Dick Drost, VP. PR. Bambi Hansen, Sales Mgr. Mary Gugliotta (D, MO, R, W/D)
 Formats: Videocassette-Beta, VHS, U-matic
 Subjects: Adult, Gen. Entertainment, Music/Concerts Sports

VIDEO CITY, 3371 Mt. Diablo Blvd., Lafayette, Calif. 94549 Tel (415) 284 7312 (D, R, MO)
 Formats: Videocassette-Beta, VHS, U-matic
 Subjects: Adult, Cartoons, Feature Films, Gen. Entertainment, Music, Sports

THE VIDEO CLUB OF AMERICA (DIV. OF MAGNETIC VIDEO CORP.), 23434 Industrial Park Court, Farmington Hills, Mich. 48024 Tel (313) 476 8460, Bus. Mgr. T.R. Kantner (MO)
 Formats: Videocassette-Beta, VHS
 Subjects: Cartoons, Feature Films, Gen. Entertainment, Music, Sports

VIDEO COMMUNICATIONS INC. (VCI), 6555 E. Skelly Dr., Tulsa, Okla. 74145 Tel (918) 622 6460 Pres: Bill F. Blair, Exec. VP & Sales Mgr. Bob Blair (D, W/D, MO)
 Branch: Oak Forest, Ill., 15620 Rob Roy Dr. Zip 60452 Tel (312) 687 7881
 Formats: Videocassette-Beta, VHS, U-matic
 Subjects: Children's, Feature Films, Gen. Entertainment, Instructional, Religious

THE VIDEO CONNECTION, 1920 Sylvania Ave., Suite 101, Toledo, Ohio 43613 Tel (419) 472 7727 Pres: John G. Oay, Sales Mgr. Yvonne Blair (D, MO, R, W/D)
 Formats: Videocassette-Beta I & II, VHS, Videodisk-Capacitance
 Subjects: Adult, Children's, Feature Films, Gen. Entertainment, Music/Concerts, Sports, Instructional/Educational

VIDEO DIMENSIONS, 43 E. 10 St., New York, N.Y. 10003 Tel (212) 533 5999 Pres: Allan Greenfeld, Sales Mgr. John G. Donaldson (D, MO, R, W/D)
 Formats: Videocassette-Beta, VHS
 Subjects: Children's, Feature Films, Gen. Entertainment, Music/Concerts, Sports, Foreign Films, Outakes

VIDEO DISCOUNT CENTER, 2121 Biscayne Blvd., Miami, Fla. 33137 Tel (305) 576 8877 (W/D, MO)
 Formats: Videocassette-Beta, VHS
 Subjects: Adult, Cartoons, Feature Films, Gen. Entertainment, Music, Sports, Educational

VIDEOHO, PO Box 42, Medina, Ohio 44256 Tel (216) 722-5085 Pres: Mark S. Philips. (MO, R, W/D)
 Formats: Videocassette-Beta, VHS (Also available in PAL mode) Video disk-Laser/Optical
 Subjects: Adult, Children's, Feature Films, Gen. Entertainment, Music/Concerts, Sports, Instructional/Educational

VIDEO HOME LIBRARY LTD., PO Box G, Madison Square Sta., New York, N.Y. 10010 Tel (212) 925 7744. WATS (800) 221-4066, Pres. & Sales Mgr. Andre O'Apice (W/D, MO)
 Formats: Videocassette-Beta, VHS

Subject: Adult, Feature Films, Gen. Entertainment
VIDEO KING INC., TIME SHARING LIBRARY NETWORK, 3907 56 Ave., Hyattsville, Md. 20784 Tel (301) 779-3010. Sales Mgr.: Robert Sorkin (R, W/D, MO)-Note: Has National Rental Program
 Formats: Videocassette-Beta, VHS
 Subjects: Adult, Feature Films, Gen. Entertainment, Music, Sports, Special Interest

VIDEO LA, see Video Yesterday

VIDEO LIBRARY CO., 612 Montgomery Ave., Narberth, Pa. 19072 Tel (215) 664 0249 Pres: Homer Hewitt III, Sales Mgr. Karen Pressman (W/D)
 Formats: Videocassette-Beta, VHS, U-matic
 Subjects: Adult, Cartoons, Feature Films, Gen. Entertainment, Music, Sports

VIDEO ONE-STOP, 10250 Santa Monica Blvd., Los Angeles, Calif. 90067 Tel (213) 879 5677 Pres: Russ Berens (W/D)
 Formats: Videocassette-Beta, VHS, U-matic
 Subjects: Adult, Cartoons, Feature Films, Gen. Entertainment, Music, Sports

VIDEO ONE VIDEO INC., 2110 116 St. NE, Bellevue, Wash. 98004 Tel (206) 454 5992 Pres: Weston Nishimura, Sales Mgr. Robert G. Johnson. (W/D)
 Formats: Videocassette-Beta, VHS
 Subjects: Adult, Children's, Feature Films, Gen. Entertainment, Music/Concerts, Sports, Instructional/Educational

THE VIDEO SOCIETY, 2029 Century Park E., Suite 3440, Los Angeles, Calif. 90067 Tel (213) 557 2066 Pres: S. Gerald Stone, Sales Mgr. Ron Friedman (MO)
 Formats: Videocassette-Beta, VHS, Videodisk-Laser/Optical, Capacitance VHO
 Subjects: Children's, Feature Films, Gen. Entertainment, Music/Concerts, Sports, Instructional/Educational

VIDEOSPACE, 624 Bellevue Way NE, Bellevue, Wash. 98004 Tel (206) 454 4488 Sales Mgr. Ken Bostock Local branch: 810 NE 45 St. Seattle 98105 Tel 633 0804 (MO, R)
 Formats: Videocassette-Beta, VHS; Videodisk-Laser/Optical
 Subjects: Adult, Children's, Feature Films, Gen. Entertainment, Music/Concerts, Sports, Instructional/Educational

VIDEO STATION INC., 11906 Wilshire Blvd., Los Angeles, Calif. 90025 Tel (213) 478 5007 Pres: George Atkinson, Sales Mgr. G. Brock (D, R, W/D)
 Formats: Videocassette-Beta, VHS, U-matic, Technicolor ("i") (Also available in PAL mode), Videodisk-Capacitance
 Subjects: Adult, Cartoons, Feature Films, Gen. Entertainment, Music, Sports

VIDEO SUPPLIERS OF AMERICA, 9601 Katy Fwy., Suite 400, Houston, Tex. 77024 Tel (713) 465 8220 Pres: Bill Mulkey (MO, W/D)
 Formats: Videocassette-Beta, VHS
 Subjects: Adult, Feature Films, Gen. Entertainment, Music/Concerts Sports, Instructional/Educational

VIDEO T.E.M. INC., 121 La Tori NE, Albuquerque, N.M. 87108 Tel (505) 266 8619. WATS (outside N.M.) (800) 545 6580 Pres & Sales Mgr. J.G. Ralston. (D, W/D, MO)
 Formats: Videocassette-Beta, VHS, U-matic
 Subjects: Adult, Cartoons, Feature Films, Gen. Entertainment, Nostalgia

VIDEO TAPE NETWORK INC., 115 E. 62 St., New York, N.Y. 10021 Tel (212) 759 8735 Pres: John Friede: Sr. VP: John S. Lollo (W/D, MO)
 Formats: Videocassette-Beta, VHS, U-matic, "i" EIAJ open reel
 Subjects: Gen. Entertainment, Music, Sports, Instructional

VIDEO TECH PRODS INC., P.O. Box 12855, Kansas City, Mo. 64124 Tel (816) 331 5834 Pres: R.K. Bernard, Sales Mgr. Jane Bernard (D, MO, R, W/D)
 Formats: Videocassette-Beta, VHS, U-matic
 Subjects: Feature Films, Music/Concerts

VIDEOWAYS INC., 10000 NW 80 Ave. Hialeah Gardens Fla. 33016 Tel (305) 557 5262 Pres: Angel Tamargo, Sales Mgr. Carlos Garcia (D, MO, W/D)
 Formats: Videocassette-Beta, VHS, U-matic (Also available in PAL mode), Videodisk-Capacitance
 Subjects: Adult, Children's, Feature Films, Gen. Entertainment, Music/Concerts, Instructional/Educational

VIDEO-X-PIX, 430 W. 54 St., New York, N.Y. 10019 Tel (212) 498 8156 Pres: Arthur Morowitz, Sales Mgr. Vicki Langer (W/D)
 Formats: Videocassette-Beta, VHS. (Also available in PAL mode)
 Subjects: Adult

VIDEO YESTERYEAR, Box C, Sandy Hook, Conn. 06482 Tel (203) 426 2574 WATS (outside Conn.) (800) 243 0987. Pres: J. David Goldin, Sales Mgr. Craig Gallichotte (D, W/D)
 Formats: Videocassette-Beta, VHS, U-matic (Also available in PAL mode)
 Subjects: Adult, Cartoons, Feature Films, Gen. Entertainment

WARNER HOME VIDEO INC., 75 Rockefeller Plaza, New York, N.Y. 10019 Tel (212) 484-6119 Pres: Morton J. Fink, Sales Mgr. Rand Bliemeister (W/D-Distributor only)
 Branch: Burbank, Calif., 4510 Vanowen St. Zip 91505 Tel (213) 841 0814
 Formats: Videocassette-Beta, VHS
 Subjects: Adult, Children's, Feature Films, Gen. Entertainment, Music/Concerts

WESTERN VIDEO CORP., 430 E. 58 Ave., Oenver, Colo. 80216 Tel (303) 623 2227 WATS (800) 525-5817 Pres: Stephen W. Hunter; Gen. Mgr. Cathie Ries (W/D)
 Formats: Videocassette-Beta, VHS
 Subjects: Children's, Feature Films, Sports

WORLD TELEVISION, 702 W. 17, Los Angeles, Calif. 90015 Tel (213) 748-3898 (MO)
 Formats: Videocassette-Beta, VHS
 Subjects: Cartoons, Feature Films, Gen. Entertainment, Music, Sports, Educational

WORLD WIDE VIDEO INC., 3134 Foothill Blvd., La Crescenta, Calif. 91214 Tel (213) 957 1219 WATS (800) 423 2606 Pres: Jim Sicilia, Sales Mgr. Craig Sicilia. (D, MO)
 Formats: Videocassette-Beta, VHS (Also available in PAL mode)
 Subjects: Adult, Children's, Gen. Entertainment, Music/Concerts

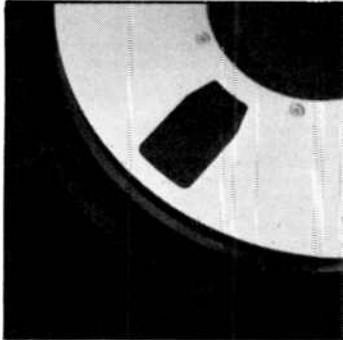

INTERNATIONAL AUDIO VIDEO TAPE DIRECTORY

INDEPENDENT VIDEO PRODUCERS

The following is a list of Video Production companies that are involved in the production and recording of video for concerts, record/artist promos and other music related projects. Facilities, equipment and services listed are intended as a brief description only and may not necessarily reflect a particular company's full capabilities.

ADCO PROD'NS (DIV. OF SHEER GENIUS INC.), /101 Biscayne Blvd., Miami, Fla. 33138. Tel: (305) 751-3118. Prod'rs: Bill Wyley, Earl Wainwright, Bob Arbogast.

Facilities: studio—150' x 200' soundstage, multiple video cams, limited audio facilities, mobile/portable—RCA TK-76 or TK-76B cams, remote 1" type C w/ 1/4" U-matic recorders; post-prod'n—complete editing in all broadcast formats, film & videotape interlock, music mixing & transfer; other—fully capable for 16 & 35mm film shooting & editing.

ANGELSEA PROD'NS, 55 Russ St., Hartford, Conn. 06106. Tel: (203) 244-2287. Prod'rs: Douglas Munford, David H. Gilroy.

Facilities: studio—2 studios (20' x 36' x 13' & 12' x 24' x 8'); Sony Tricam cam; Panasonic cam; JVC CR-4400 LU 1/4" VTR; Sony AV-8440 open reel & Betamax 1/2" VTR's; other various VHS format (1/2") VTR's, mobile/portable—for equipment see above; post-prod'n—2 control rooms (15' x 20' x 8' & 12' x 11' x 8'); Sony Trinitron color monitors.

ARIZONA VIDEO SERVS., 3525 E. Flower, Tucson, Ariz. 85716. Tel: (602) 326-9610, 298-7244. Owners: Stefan Weglarz, Dave Vizedim; Prod'r: Bonnie Odem.

Facilities: studio—none; mobile/portable—single or multi-cam mobile unit w/ 1" or 1/4" VTR; post-prod'n—state-of-the-art facilities incl. SMPTE time coding & on or off-line editing.

AUDIO-VIDEO CORP., 55 Delaware Ave., Delmar, N.Y. 12054. Tel: (516) 439-7611. Owner: Milton A. Xlarsfield; Prod'rs: James Tusty, Lee Bowden.

Facilities: studio, mobile & post-prod'n—1/4" U-matic cassette- or 1" type C VTR.

AUDIO-VIDEO REC'RS OF ARIZONA INC., 3830 N. Seventh St., Phoenix, Ariz. 85014. Tel: (602) 277-4723. Owner: Floyd M. Ramsey; Prod'rs: Scott Benner, John Chambers.

Facilities: studio—66' x 44' x 20' studio, 3 Ikegami color cams; light grid; mobile/portable—location "film style" only; post-prod'n—1/4" editing; SMPTE time coding.

BAMCAMP VIDEO INC., 848 Lake Nora, Indianapolis, Ind. 46240. Tel: (317) 844-6900. Owners: James Bamberger, Curtis Ping.

Facilities: recording—1/4" Beta & VHS; editing—1/4" U-matic.

BENNETT PROD'NS, 2553 Cleveland Ave., Columbus, Ohio 43211. Tel: (614) 263-7007. Owner & Prod'r: John W. Coffey; Ass't Prod'r: Joel Chow.

Facilities: studio—15' x 16' studio w/ lights & sound mixing, film cam, mobile/portable—cam & portapack unit w/ monitor & lights; post-prod'n—none (utilizes nearby facilities); other—film prod'n, processing & editing, transfers.

CENTEL/CENTURY THREE FILMS, 651 Beacon St., Boston, Mass. 02115. Tel: (617) 267-6400. Owner: Boss Cibella; Prod'rs: Bobbi Gevas, Dianna Costello, Michael Dick.

Facilities: studio—30' x 60' x 20' studio, 14' lighting grid; 70' curved hard cnc, RCA TKP 46 plumbeon broadcast color cam, complete grip, lighting & sound equip.; mobile/portable—21' Transvan w/6500 watt generator; 21' Winnebago w/500 watt generator; portable 2", 1" & 1/4" VTR's, full grip, lighting & sound equip.; post-prod'n—CMX computer edit system; 1/4" off-line edit system; Grass Valley switcher, 3 RCA 600 A 2" qwd VTR's; MCI 4-tr. audio console.

FAX CREATIVE PROD'NS INC., 4810 Auburn Ave., Bethesda, Md. 20014. Tel: (301) 652-7800. Owners: Joseph & Karen Nagy; Prod'rs: Joseph Nagy, John Marcus, Eric Kulberg.

Facilities: studio—complete facilities for broadcast quality productions; mobile/portable—Hitachi cams; ENG or EFP crews capable of 1" & 1/4" single or multiple cam productions; post-prod'n—Convergen computer editor, full post-prod'n facilities for 1/4" or 1".

FOCUS TELEPRODUCTIONS, PO Box 9342, 923 1/2 Metairie Rd., New Orleans, La. 70005. Tel: (504) 837-2420. Owner: James R. Pratt Jr.

Facilities: studio—20' x 20' open studio; mobile/portable—van equipped to handle 4 matched color cams; main console can leave van for reside work; post-prod'n—Panasonic 1/4" editing system, graphics generator, other—film prod'n & photographic servs. available.

GEOMETRIX ASSOCS., 23 Central Ave., Milford, Conn. 06460. Tel: (203) 878-6066. Owner: Guy E. Ortoleva; Prod'rs: Guy E. Ortoleva, Cathie I. Ienthal.

Facilities: studio—2500 sq. ft. rehearsal studio w/ lighting & P.A.; mo-

bile/portable—1 Ikegami HL 77 & HL 79 cams; 2 Ampex 1" VTR's, switcher; post-prod'n—none.

GILMORE ASSOCS. INC., 990 Washington St., Dedham, Mass. 02021. Tel: (617) 329-6633. Owner: Robert Gilmore; Prod'rs: Tom Haley, John Bell, Jane Bara.

Facilities: studio—2 sound studios; mobile/portable—2 remote vans completely equipped for multiple-cam pickups; post-prod'n—CMX 340X editing (2", 1" & 1/4"), 4 VTR's.

GOWERS, FIELDS & FLATTERY, 710 M. Seward St., Los Angeles, Calif. 90038. Tel: (213) 467-4000. Owners: Bruce Gowers, Simon Fields, Paul Flattery; Prod'rs: Paul Flattery, Simon Fields.

Facilities: studio—small studio & set w/ GE PJ-5000 video projector; mobile/portable—1/4" VCR for remote production of visuals, 1" VTR available; post-prod'n—2 1/4" editing suites.

INSTANT REPLAY, 2980 McFarlane Rd., Coconut Grove, Fla. 33133. Tel: (305) 448-7088. Owner: Charles Azar; Prod'rs: Charles Azar, Iv. Reinhart, Tom Brustetter, Chaz Shukat.

Facilities: studio—full service production facility complete w/ 1" & 1/4" VTR's, broadcast cams; test & support equip. including lighting, sound & film; dressing room; large screen viewing; mobile/portable—1/4" ton van equipped w/ Ikegami HL 79A cam, Hitachi HR-100 1" VTR; post-prod'n—1/4" editing facilities w/ Ultimate special effects; insert stage w/ slide chain & graphics generator; other—16 & 35mm film prod'n.

INTERIMX INC., 2505 S. Robertson Blvd., Los Angeles, Calif. 90034. Tel: (213) 870-2121. Owner & Prod'r: Reiko Posner.

Facilities: studio—none; mobile/portable—single or multi-cam mobile unit w/ 1" or 1/4" VTR; post-prod'n—state-of-the-art facilities incl. SMPTE time coding & on or off-line editing.

M T V PROD'NS, PO Box 3356, Hollywood, Calif. 90028. Tel: (213) 465-2484. Owners: Jim Mylenek, Ken Turner.

Facilities: studio—none; mobile/portable—single or multi-cam mobile unit w/ 1" or 1/4" VTR; post-prod'n—state-of-the-art facilities incl. SMPTE time coding & on or off-line editing.

MATRIX TELEVISION PROD'NS INC., 14422 NW Seventh Ave., Miami, Fla. 33168. Tel: (305) 864-1460. NYC Tel: (212) 926-0004. Owner: Frank Beacham; Prod'rs: Carol Dickman, Warren Jones, Frank Beacham.

Facilities: studio—none, rented as needed, mobile/portable—van w/ Sony BVP-330 and RCA TK-76 cams, type C 1" open reel & 1/4" U-matic VTR's; complete audio facilities including wireless mics; post-prod'n—mobile editing package consisting of Sony BVU-200A VTR's and BVE 500A editor; Microtime time base corrector; audio mixing facilities.

MIDTOWN VIDEO (DIV. OF MILLER-WERMEL INC.), 130 W. Fifth Ave., Denver, Colo. 80204. Prod'rs: Kenneth Miller, Debra Mermel.

Facilities: studio—12' x 20' insert stage; mobile/portable—van equipped for single or multi-cam remotes, 1" & 1/4" VTR's; post-prod'n—complete 1/4" editing w/ TBC, special effects.

MOBILE-VIDEO PROD'NS INC., 7315 Wisconsin Ave., Suite 1C18-E, Bethesda, Md. 20014. Tel: (301) 656-2525. Owner: Stephen King.

Facilities: studio—30' x 50' studio w/ cnc; mobile/portable—1 Ikegami & JVC cams; Sony VTR's, lights, mics, etc.; post-prod'n—1/4" Sony 2260/2860 editor, switcher w/ special effects.

MODERN TELECOMMUNICATIONS INC. (MTI), 885 Second Ave., New York, N.Y. 10017. Tel: (212) 355-0510. Pres.: Robert C. Weisgerber, VP Eng'g Philip Mancino; VP & Treas.: William Dalessandro.

Facilities: studio—45' x 60' columnless soundstage equipped w/ hard cnc; lighting grid, 3 cams; make-up rooms; 16' x 45' insert stage; control room w/ Grass Valley switcher; Chyron character generator; Ultimatte; Quantel available; audio room & announcer's booth; mobile/portable—remote van; post-prod'n—4 computerized editing suites w/ Quantel DPE 5000 systems; on-line 2", 1" & 1/4" editing w/ CMX 340X and Datatron systems; off-line 1/4" editing w/ 2 VCR's; disc, slow-motion & Chyron effects available; other—extensive transfer services available utilizing Galaxy System & Electronic Separation Process; video duplication packaging & distribution.

MULTIVISION INC., 31 Old Randolph St., Canton, Mass. 02021. Tel: (617) 828-8864. Owners: Don O'Sullivan, Joseph Heard; Prod'rs: Don O'Sullivan, Joseph Heard, Jay Rowe.

Facilities: studio—none; mobile/portable—1 Ikegami cam; 1" & 1/4" Sony VTR's; Ross switcher; Adda Frame store synchronizing time base correctors; post-prod'n—CMX-340X edit suite w/ Sony VTR's Ross switcher, Adda Frame time base correctors.

MUSIC VIDEO PROD'NS INC., 23 Stillings St., Boston, Mass. 02250. Tel: (617) 482-7428. Owner & Prod'r: Christopher McKinnon.

Facilities: studio—2500 sq. ft. rehearsal studio w/ lighting & P.A.; mo-

bile/portable—1 Ikegami HL 77 & HL 79 cams; 2 Ampex 1" VTR's, switcher; post-prod'n—none.

NARROWCASTERS INC., PO Box 523027, Miami, Fla. 33152. Tel: (305) 624-4853. Owner & Prod'r: Joel B. Stein.

Facilities: studio—none; mobile/portable—single & multi-cams available; 18-tr. audio; post-prod'n—1/4" editing facilities.

NEW ENGLAND VIDEO, 259 Walnut St., Newtonville, Mass. 02160. Tel: (617) 332-4953. Owner: Albert C. Rondinelli; Prod'rs: Carl Rondinelli, Robert Vedeccio.

Facilities: studio—none; mobile/portable—single & multi-cams available; 18-tr. audio; post-prod'n—1/4" editing facilities.

NEW LIFE COMMUNICATIONS INC., 424 Minnesota Ave., Willmar, Minn. 56201. Tel: (612) 235-6404. Prod'r: Larry Huisinga.

Facilities: studio—small studio used for voice-overs, narration, special effects and limited prod'ns; multiple cams, mics & rec'rs; mobile/portable—on-location package consists of specially built video console w/ switching, waveform monitor; post-prod'n—1/4" editing w/ SMPTE time code; off-line editing; film chain; other—art & graphics dept.

NORTHWEST VIDEO CENTER, 2816 Thornhyke Ave. W., Seattle, Wash. 98199. Tel: (206) 282-9670. Owner: Loy Norris.

Facilities: studio—2400 sq. ft. studio, 100' curved cnc; 14' lighting grid; 2 Ikegami HL-77 cams; 2 IVC-500 cams; Central Dynamics switcher w/ chroma key, soft wipes & positioner; 2" VTR; 2 Ampex VPR-2 1" VTR's, 1/4" & 1/2" VCR's; character generator; teleprompter; mobile/portable—2 compact video vans (24' x 15'); equip. as above; post-prod'n—2 Ampex VPR-2 1" VTR's; SMPTE time code; 1/4" Panasonic editor; complete interface w/ CMX 340X editing system; audio mixdowns, sweetening & relay to video in sync.

DNE PASS INC., 900 Third St., San Francisco, Calif. 94107. Tel: (415) 777-5777. Prod'r: Larry King.

Facilities: studio—40' x 40' studio/soundstage; 20' x 30' insert stage; mobile/portable—remote truck; 4 Ikegami cams; gnp van; post-prod'n—CMX 340 & 600 editors; Sony BVE 500-A editor/controller.

OPRYLAND PROD'NS (DIV. OF WSM INC.), 2806 Opryland Dr., Nashville, Tenn. 37214. Tel: (615) 889-6840. Prod'rs: Bayron Binkley, John McCorkle; Sales Mgr.: John McCorkle.

Facilities: studio—70' x 80' studio w/ computerized lighting, 5 cams, 180' cnc, Chapman crane, seating for 300, 110' x 90' stage w/ seating for 4400; mobile/portable—3 mobile units w/ RCA TK45 and TKP 45 cams available; 1" or 2" formats available; post-prod'n—CMX 340X computerized editing systems w/ interface to 16-tr. audio recorder, 1" or 2" editing available; Quantel digital effects, slow motion available.

OSMOND'S STUDIO, 1420 E. 800 N., Salem, Utah 84059. Tel: (801) 224-4444. Telex: 453051. Owners & Prod'rs: Osmond Bros.

Facilities: studio—110' x 155' soundstage; 360' cnc w/ 4' x 4' cnc pit, costume shop; set construction facilities; mobile/portable—1" type C VTR; RCA TK46 cam; post-prod'n—5-2" AVR 3's w/ Mach 1 computerized editing; ESS 2 slow motion effects; Compositor 1 graphics; Ampex 1" type C VTR; Rank-Cintel 1/4" off-line editing.

P M C VIDEO CORP., 14875 NE 20 Ave., North Miami, Fla. 33181. Tel: (305) 947-7851. Prod'r: Mark Glanz.

Facilities: studio—24' x 40' video studio; 24-tr. audio recording studio, mobile/portable—1/4" VTR, broadcast quality cam, post-prod'n—1/4" edit suite; special effects generator; character generator; titling cam, other—dubbing facilities.

PARADISE AUDIO/VIDEO CENTER, see Leon Russell.

THE POST GROUP, 6335 Homewood Ave., Hollywood, Calif. 90028. Tel: (213) 462-2300. Gen. Mgr.: John Williams, Mktg. Dir.: Meryl Lippman; Ops. Dir.: Joan Adler. (Post-Prod'n only)

Facilities: post-prod'n—4 CMX 340X editing suites; Sony 1" type C VTR; Quantel digital effects; Chyron electronic titling; 1/4" off-line editing, black & white matte cam; limited audio facilities; other—film to tape transfers; videotape duplication.

PRESIDIO VIDEO, 121 S. Cherry Ave., Tucson, Ariz. 85719. Tel: (602) 884-8117. Owners & Prod'rs: Sam Behrend, John Hall, Steve Levey.

Facilities: studio—24' x 40' video studio; 24-tr. audio recording studio, mobile/portable—1/4" VTR, broadcast quality cam, post-prod'n—1/4" edit suite; special effects generator; character generator; titling cam, other—dubbing facilities.

PRODUCERS VIDEO, 282 E. Sycamore, Columbus, Ohio 43206. Tel: (614) 461-9818. Owner & Prod'r: Dan Sakas.

Facilities: studio—none; mobile/portable—specializes in "on location" shoots; broadcast cams; professional audio equip.; Lowell lighting equip.; post-prod'n—1/4" editing facilities, other—1/4" duplication.

PROFESSIONAL VIDEO SERVICES (PVS), 206 E. 29 St., New York, N.Y. 10016.

Tel (212) 683 3636 Owners Richard & Alan Namm, Prod'r Richard Namm

Formats: 2", 1", 1/2", 1/4"
Facilities: studio—30' x 30' soundstage w/control room, 18' lighting grid, mobile/portable—mobile teleproduction van w/15 broadcast color cams, completely modular & portable video production control room, Grass Valley 1600 IA switcher package, Sony 1" VTR, Steadicam equip post-prod'n—1/2" off line editing system w/SMPTE edit code capability

RIMTHY VIDEO PRODS, 342 Madison Ave New York, NY 10017 Tel (212) 687 1217 Owners & Producers Robert & Shirley Bass
Formats: 2", 1", 1/2", 1/4" Beta & VHS
Facilities: studio—available, mobile/portable—30' air conditioned w/v generator, 23' Winnebago production truck, Fernseh, RCA TK 76 & Ikegami HL 79A color cams, Sony 1" VTR's, post-prod'n—Grass Valley 16001 A switcher w/32 special effects, Tascam audio board (12 input, 8 output), 2 Shure mixers, 2 machine editing

LEON RUSSELL'S PARADISE AUDIO/VIDEO CENTER, 4720 W Magnolia Blvd, Burbank, Calif 91505 Tel (213) 980-5644/5648
Formats: 2", 1", 1/2", 1/4" Beta & VHS
Facilities: studio—none, mobile/portable—45' motor coach w/on line editing & live switching or 7 cam isolated rec'g, 6 Bosch BCN 50 VTR's 1 Bosch BCN 20 1" hi band VTR, Grass Valley 24 x 1600 switcher w/E Mem, Mach 1 computerized editor, Hitachi studio or hand-held cams, 5 Sony 2860 1/2" U-matic VCR's, 2 RCA 400X 1/2" VHS VCR's, 2 Zenith 1/2" Beta VCR's, 1 JVC HR-400 Porta Pack VCR, 1 Quantel DPE 5000 Effects generator, 1 Bosch digital effects generator, color & B&W monitors Adv vent 1000A video projector, complete mobile audio system also available, post-prod'n—see above items

SCENE THREE VIDEO, 1813 Eighth Ave S Nashville, Tenn 37203 Tel (615) 385-2820 Owners Marc W Ball, Kitty Moon, Prod'r Mike Duncan
Formats: 2", 1", 1/2", 1/4" Beta & VHS
Facilities: studio—insert stage, mobile/portable—remote truck, Ikegami HL 79A color cams, Sony 1" VTR, post-prod'n—CMX 340X editing systems, Vital switcher, SqueezeZoom, Chyron titling system, 1" & 2" VTR's, Neve audio facilities

SOFT FOCUS PRODS/ROCKAMERICA, 41 E 20 St New York, NY 10003 Tel: (212) 475-5791, Owner & Prod'r Edward Stenberg
Formats: 2", 1", 1/2", 1/4" Beta & VHS
Facilities: studio—insert stage & 500 seat 24-tr audio/video theater, mobile/portable—1" or 1/2" VTR's, broadcast or industrial quality cams, lighting, audio & personnel support available, post-prod'n—all formats available; post-prod'n supervision available

SOUND VIDEO PROJECTOR, 356 South West Temple, Salt Lake City Utah 84101 Tel (801) 322-2526 Owners & Producers James O Scaggs, John F Jackman
Formats: 1", 1/2" Beta & VHS
Facilities: studio—800 sq ft recording area, Sharp XC 700 & 530U studio cams, 2 4 tr audio available, mobil/portable—Sharp CX 700 & 530U cams, Grass Valley switcher, Altec audio board, E V mics, Clear Com system, post-prod'n—Panasonic & JVC editing equip

E. J. STEWART INC., 525 Mildred Ave., Primos, Pa 19018 Tel (215) 626 6500 Owners Howard S Lipman, Eric R Aderson, David S Wiggins, Producers Kathy DeBe, Corrine Cardillo, Sherry Feldesman
Formats: 2", 1", 1/2", 1/4"
Facilities: studio—2 studios (77' x 63' & 54' x 44') w/hard infinity cycs, RCA cams, talent dressing rooms, prop & scene shop, mobile/portable—

7 RCA cams, 2 RCA 1" VTR's, Grass Valley switcher Chyron character generator Oktel disc machine, post-prod'n—CMX 340X editor, Grass Valley switcher w/effects memory, 32 channel Yamaha audio console, 8 tr MCI audio recorder, Chyron IV titling
STEWART PRODUCTIONS INC., 13955 SW 192 St Miami, Fla 33177 Tel (305) 447 7309 Residence Tel 666 8805 Producers (Miami) Chuck Stewart (Los Angeles) John McBride
Formats: 2", 1", 1/2", 1/4" Beta & VHS
Facilities: studio—soundstage w/hard cyc, mobile/portable—Ikegami HL 79 cams RCA 1" type C VTR, Sony 1/2" U-matic VCR, full sound repro duction & color playback, post-prod'n—facilities for all formats

SUNBIRD TELEPRODUCTIONS INC., 400 Schultz Rd Elma N Y 14059 Tel (716) 882 1900, Prod'r Philip Arno
Formats: 1", 1/2" Beta & VHS
Facilities: studio—none, mobile/portable—van w/4 cam capability graphics audio mixing, mini cams available, post-prod'n—Convergence 1/2" editing

SUNRISE CANYON VIDEO, 1813 Victory Blvd, Glendale, Calif 91201 Tel (213) 241 5173 Owners William Hughes Ronald Carter, Adv & PR Lynne Hughes
Formats: 2", 1", 1/2", 1/4"
Facilities: studio—900 sq ft stage w/lighting grid cyc & double cover misc grip equip available kitchen facilities, mobile/portable—20' 4 cam capable production van Ikegami HL 79 A cam w/digital command unit & 22 1/2" lens, Ampex VPR 1 & VPR 2 VTR's, Sony 2850 VTR, Vital 703 production switcher Ikegami high resolution monitor Teac 10 input audio console w/graphic equalization 1" & 1/2" porta pac systems available w/Ikegami color cam 9" B&W monitor, Cine 60 battery belts, assortment of mics, van seats 2 production personnel & truck operator, cams can operate up to 1000' from van, post-prod'n—none, other—production technical make up prop wardrobe & set design personnel available

T D I, TELEVISION DIV., 4100 W Flagler St Miami, Fla 33134 Tel (305) 446 1900 Owner Larry Brahm Producers Larry Brahm Olga Mercedes Ruiz
Formats: 2", 1", 1/2"
Facilities: studio—none, mobile/portable—remotes available locally & in South American locations, post-prod'n—full editing capabilities for 2" 1" & 1/2" formats other—foreign language dubbing

TAKE TWO PRODS, 5200 Mitchelldale, No F 28, Houston, Tex 77092 Tel (713) 680 0600 Owner Alan L MacAdams Prod'r George Dismukes
Format: 1/2"
Facilities: studio—20' x 38' studio w/lighting grid 20kw of lighting, 3 cams, mobile/portable—2 cam mobile unit w/1/2" VCR, post-prod'n—1/2" editor

TELE-COLOR PRODS INC., 150 S Gordon St Alexandria Va 22304 Tel (703) 823 2800 Pres Chas F Riley
Formats: 2", 1", 1/2", 1/4" Beta & VHS
Facilities: studio—2 studios (50' x 100' & 50' x 50') w/black or white cycs, chroma key, mobile/portable—2 mobile units accommodating up to 6 cams & 3 VTR's Hitachi SK 96 cams, slow motion effects post-prod'n—Mach One computer editor w/ 4 VTR's, Ampex 440 4 tr audio recorder

TELEVISION PRODS INC./CHICAGO, 3210 W West Lake Ave Glenview, Ill 60025 Tel (312) 729 5215 Pres R Terry Hoffman VP Scott Kane Mktg Dir & Client Servs Pat Savano, Opns Mgr Steve Ullman, Senior Dir Ron Ascher
Formats: 2", 1", 1/2", 1/4" Beta & VHS
Facilities: studio—2 soundstages w/hard cyc full production staff, scenic design & construction mobile/portable—commercial production van post-prod'n—computerized 1" & 2" editing suites, SqueezeZoom digital effects Compositor graphics, multi channel audio, other—16mm & 35mm film to tape transfers video & audio tape duplication, microwave unit for satellite reception

TELEVISION PRODS INC./SEATTLE, 1200 Stewart St Seattle Wash 98101 Tel (206) 623 5934 Pres R Terry Hoffman, Gen Mgr Al Abady, Mktg Dir Connie Collins, Opns Sup Terry Sorensen
Format: 1"
Facilities: studio—38' x 60' soundstage w/hard cyc, flats, risers & other support equip mobile/portable—van w/single Hitachi SK 70 cam 1" type C recorder w/full color playback, full lighting, audio & grip packages, post-prod'n—CMX 1" editor w/SqueezeZoom digital effects 3 Sony BUH 1000 1" type C VTR's, still frame capability, Compositor graphics generator multi channel audio studio, other—video & audio tape duplication

THETA VIDEO TAPE CENTER, 2939 Nebraska Ave Santa Monica, Calif 90404 Tel (213) 829 2676 Mgr Bravid L Gaylor Prod'r Lewis Bert
Formats: 2", 1", 1/2", 1/4"
Facilities: studio—35' x 26' soundstage 3 cams full lighting package mobile/portable—single cam "film style" remotes using Hitachi SK 96 cam & Sony BVH 500 VTR, post-prod'n—3 Sony BVH 1000 1" type C VTR's, Sony BVE 500A editor/controller

T. THURE VIDEO PRODS, 1802 W Grant Rd, Suite 119, Tucson, Ariz 85705 Tel (602) 882 4048 Owners Terry & Karen Thure Producers Terry Thure, Tony Di Russo
Formats: 1", 1/2", 1/4"
Facilities: studio—audio facilities only mobile/portable—fully equipped van w/Sony BVP 300 cams, 1" & 1/2" broadcast quality recorders, Conrac monitors mini grip package, 12kw of lighting, post-prod'n—1/2" editing facilities

TRANS-AMERICAN VIDEO INC. (DIV. OF MERV GRIFFIN PRODS), 1541 Vine St Hollywood, Calif 90028 Tel (213) 466 2141 Owner Merv Griffin Pres Murray Schwartz, VP Opns Louis S Stenberg, VP Sales Jeff Ross
Branch: Las Vegas, Nev., 3355 W Spring Mountain Rd Zip 88102 Tel (702) 873 3660
Formats: 2", 1", 1/2", 1/4"
Facilities: studio—7000 sq ft "Celebrity Theater" equipped for video tape prod'n, mobile/portable—2 42' mobile studios w/ 1" or 2" VTR's (Based in Las Vegas, Nev see above), post-prod'n—2 1" & 2" CMX editing bays 1 1/2" Mach I off line bay, other—Rank Cintel negative transfers

UNITEL PROD'N SERVS. INC., 510 W 57 St New York, NY 10019 Tel (212) 265 3600 Pres Herb Bass, Exec VP Alex Geissler VP & Gen Mgr John Hoffman, VP Mktg Phil McEneny
Formats: 2", 1", 1/2", 1/4"
Facilities: studio—40' x 50' studio w/30' x 35' x 14' hard cyc, 20' x 30' studio w/ 20' x 20' x 10' hard cyc, mobile/portable—4 mobile video units, studio & hand-held cams, 1 audio mobile unit w/ 48 input Trident console, multi track audio recording, post-prod'n—2 CMX editing suites, 1 optical computer editing suite, Chyron IV titling, other—16 & 35mm film to tape transfers w/color correction, video duplication

VIDEO BASE IN FLORIDA INC., 2053 Lee St Hollywood, Fla 33020 Tel (305) 925 7555 Owner Rusty Hancock
Formats: 2", 1", 1/2", 1/4" Beta & VHS
Facilities: studio—2 60' x 40' shooting stages RCA video equip multitrack audio studio w video sync, mobile/portable—truck w 1" VTR, post-prod'n—editing w/digital effects, audio mixing w video interface other—film to tape transfers, video duplication

VIDEOCDM INC., 502 Sprague St, Dedham, Mass 02026 Tel (617) 329 4080 Owner Willard S Taylor, Producers Lucien A Lessard Karen Clark, Producers/Act Execs (corporate) Elaine Purcell (commercial) Debbie Wierum
Formats: 2", 1", 1/2", 1/4" Beta & VHS (PAL & SECAM broadcast modes available for 1/2" & 1/4" only)
Facilities: studio—completely equipped 40' x 60' studio w hard cyc mobile/portable—2 completely equipped mobile units w/ 2" 1" & 1/2" VTR's, post-prod'n—completely computerized 4 machine electronic editing, color correction, special effects, character generator, TBC, other—multiplexer slide transfer system film transfers

VIDEO IMAGE CONSULTANTS, 1912 S University Blvd Denver Colo 80210 Tel (303) 777 1940 Owner & Prod'r Truxton Simmons Jr
Formats: 1", 1/2", 1/4" Beta & VHS
Facilities: rented or leased as needed

VIDEOLINKS INC., 214 W 92 St New York NY 10024 Tel (212) 877 7851 Owners & Producers Richard Greenberg, John Jopson
Formats: 1", 1/2", 1/4"
Facilities: studio—available, mobile/portable—1/2" EFP & 1" type C VTR's, post-prod'n—1/2" & 1" editing, audio mixing for visuals special effects & conceptualizations

VIDEO NEWS SERVS., 2313 Fairmount Ave Philadelphia, Pa 19130 Tel (215) 235 6315 Owner & Prod'r James B Schoedler
Formats: 1", 1/2", 1/4" Beta & VHS
Facilities: studio—none, mobile/portable—RCA TK 76 cam 1/2" VTR post-prod'n—1/2" editing, special effects

VIDEO PRODS CORP., 222 Cooper St, Beverly N J 08010 Tel (609) 387 4155 Owner Michelle Caplan Prod'r Howard Caplan
Formats: 1", 1/2", 1/4" Beta & VHS
Facilities: studio—2000 sq ft studio 5 cam operation mobile/portable—multi cam mini van, post-prod'n editing equip, graphics film chain

VIDEO PRODS UNLIMITED INC., 4554 SW 71 Ave Miami Fla 33155 Tel (305) 667 1398 Owner & Dir T C Waters, Prod'r Stanley G Williams
Formats: 1", 1/2", 1/4" Beta & VHS
Facilities: studio—full cycs available (18' x 24' x 12' & 30' x 60' x 18'), mobile/portable—3 cams switcher, character generator, post-prod'n—double 1/2" editors, TBC switcher, character generator other—multiplexer for film to tape & slide to tape transfers

VIDEO REC. ALBUMS OF AMERICA, 8471 Universal Plaza Universal City Calif 91608 Tel (213) 462 1099 Owner Troy Cory Prod'r Lynn Mann Josie Whitenack Baines Trescott
Formats: 2", 1", 1/2", 1/4" Beta & VHS
Facilities: studio—100' x 100' studio mobile/portable—2" 1" & 1/2" mobile video production capability, post-prod'n—1" & 1/2" editing suites film chain

VIDEO TAPING SERVS., 908 S Kings Dr Charlotte N C 28204 Tel (704) 333 9584 Owner & Prod'r Lloyd Scher
Formats: 1", 1/2", 1/4" Beta & VHS
Facilities: studio—none, but local television studio is available, mobile/portable—1/2" & 1/4" mobile facilities, post-prod'n—All editing available (audio & video)

VIDEO WORKSHOP, 468 Forest Ave, Portland, Me 04101 Tel (207) 774 7798 Producers Eric Jurgenson Everett Foster
Formats: 1", 1/2", 1/4" Beta & VHS
Facilities: studio—25' x 40' studio 2 broadcast quality cams w/12 1 m torized zoom lenses 20' hard cyc, chroma key wall mobile/portable—Dodge Kary Van for single & multi cam remotes, 8 tr audio, post-prod'n—Dynamic Video 7 buss customized switcher Sony automatic videocassette edit system, film chain

VOYLES VIDEO PRODS, 1800 SW First Ave Suite 150 Portland Ore 97201 Tel (503) 248 0209 Owner Bill Voyles Producers Bill Voyles Doug Lamb Anne DeRock
Formats: 1", 1/2", 1/4" Beta & VHS
Facilities: studio—Ampex VPR 2 1" VTR w/time base correction, broadcast switcher Tektronix color sync generator 2 Ikegami 15" monitors slide filmchain; small studio used primarily for producing animatic commercials & 2 3 person interviews mobile/portable—van w/2 MMC 71CP mini cams, broadcast special effects switcher 1/2" VCR Ampex VPR 2 1" type C VTR w/time base correction SMPTE time code generator reader post-prod'n—2 1/2" editing bays w complete sound make up & use of film chain 1/2" Beta or VHS VCR's for "bump ups" and 1/2" duplication

WESTERN VIDEO, 8050 Ronson Rd San Diego, Calif 92111 Tel (714) 292 0337 Owner Robert Sommer Producers Rob Day, Brian Bersheim, Mike Kurtz
Formats: 2", 1", 1/2", 1/4" Beta & VHS
Facilities: studio—4 cams 2", 1" or 1/2" VTR's 8000 sq ft stage w 40' x 60' x 25' cyc mobile/portable—single cam self generated van, 27 ft 4 cam truck, post-prod'n—CVS EPIC computer assisted editing bay w 4 VTR's (2" & 1")

WINDSOR TOTAL VIDEO INC., 565 Fifth Ave New York, NY 10017 Tel (212) 725 8080 Owners R J Henderson B B Goodman Prod'r B Sa perstein
Formats: 2", 1", 1/2", 1/4"
Facilities: studio—2 video studios mobile/portable—2 cams, 1" or 1/2" VTR's available, post-prod'n—CMX 2" & 1" full effects editing system 1/2" full effects editing systems other—duplication of 1/2" Beta & VHS formats

Duotone®

6875 S.W. 81st St., Miami, FL 33143
Tel. (305) 665-1121

Duotone Phonograph Needles Diamond, Sapphire & Steel



We carry an extensive inventory of all makes of needles, including Shure, A.D.C., Tetrad, Pickering, B.S.R. Sony.

Write for FREE catalog with the most complete line of needles, cassettes, record care and tape accessories, blank tapes, audio cables.

We Export Around the World

GIVE TO MARCH OF DIMES

THIS SPACE CONTRIBUTED BY THE PUBLISHER

INTERNATIONAL AUDIO VIDEO TAPE DIRECTORY

ACCESSORIES MANUFACTURERS & IMPORTERS

The key to the abbreviations following the company listings is: (M) Manufacturer, (D) Distributor, (I) Importer.

A A, see Audio Accessories

A/V Paragon, see Universal Tape

A Bee Synchronic Inc. 230 Fifth Ave., New York, N.Y. 10001 Te (212) 664 7850.

Product: Record & Tape—carrying & storage cases (M)

Acrylic Design & Fabrication Co., 1147 W. Dine, Chicago, Ill. 60622 Te (312) 226 4222

Product: Record & Tape—carrying & storage cases (audio & video)

Advance Prods. Co. Inc., PO Box 2178 Zip 67201 1101 E. Central, Wichita, Kan. 67214 Te (316) 263-4231 Pres: William D. DeVore, Sales & Adv. Mgr.: Paul Krack

Product: Storage cabinets (Pixerobile) (M)

Akro Mills, 880 W. Waterloo Rd., Akron, Ohio 44314 Te (216) 848 3773

Product: Record & Tape—carrying & storage cases (Record Mate Tape-Mate) (M)

Aldshir Mfg. Co. Inc., 63 E. Sanford Blvd., Mount Vernon, N.Y. 10550 Te (914) 668 1297 Pres & Adv. Mgr.: Gerald Shirley, Sales Mgr.: Lindsey Nichols

Product: Record—45 rpm adaptors (T-lexev) (M)

Allsup Inc., PO Box 23, Bellingham, Wash. 98227 Te (206) 734 9090 Telex 152101 VP Jim Allsup, Sales & Adv. Dir.: Ron Morgan

Product: Tape—cassette head cleaners (audio & video)

Amarav Inc. Corp., 2251 Grant Rd., Suite H, Los Altos, Calif. 94022 Te (415) 968-2640 VP Sales & Mktg.: Ron Garrett

Product: Tape—cassette storage cases (audio & video) (M)

Amberg, see Vernon McMillan

American Lighting Specialties Inc., 1942 W. Artesia Blvd., Torrance, Calif. 90504 Te (213) 532 9262

Product: Record & Tape—carrying & storage cases (M)

American Sound Corp., 3319 E. Ten Mile Rd., Warren, Mich. 48091 Te (313) 539 2900 Pres. Frank S. Day, VP & Gen. Mgr.: Paul Hayes, VP & Sales Mgr.: Paul E. Adams

Branches: North Hollywood, Calif., 8120 Webb Ave. Zip 91605 Te (213) 768 6100 VP Paul Hayes, VP Mktg.: Paul Adams, Reg'l Sales Mgr.: William Dawson—Atlanta, Ga., American Sound Atlanta, 2091 Faulkner Rd. NE Zip 30324 Te (404) 611 4577 Gen. Mgr.: Matt Polshoff, Sales Mgr.: Peter Thomason—Closter, N.J., 317 Harrington Ave. Zip 07524 Te (201) 767 903

Product: Tape—head cleaners (M)

Amplex Corp., 441 Broadway, Redwood City, Calif. 94063 Te (415) 367 2011 Telex 348464 FWX (910) 78 5920

Sales Offices: Birmingham, Ala., PD Box 845, Zip 35205 Te: (205) 823 6132—Glendale, Calif., 500 Roderer Dr. Zip 91201 Te (213) 240 5000—San Diego, Calif., PD Box 99847 Zip 92109 Te (714) 272 8337—Denver, Colo., 2124 S. Birch Zip 80222 Te (303) 757 1829—5491—Orlando, Fla., PO Box 15008 Zip 32808 Te (305) 423 2962—Atlanta, Ga., 3125 Chestnut Dr., Suite 101 Zip 30334 Te (404) 411 7112—Honolulu, Hawaii, PO Box 25367 Zip 96825 Te (808) 395-7144—Elin Grove Village, Ill., 2201 Lunt Ave. Zip 60007 Te (312) 513 6000—Overland Park, Kan., PO Box 7282 Zip 66247 Te (913) 313 1951—Florence, Ky., Elsdor Blg. Zip 41042 Te (606) 371 1416—Baton Rouge, La., PO Box 14238 Zip 70808 Te (504) 766 6270—Bethesda, Md., 20215 Fernwood Rd. Zip 20034 Te (301) 530 8800—Framingham, Mass., PD Box 1020 Zip 01701 Te (617) 877-8160—Minneapolis, Minn., 5200 W. 73 St. Zip 55435 Te (612) 835 5560—Elkhorn, Neb., PO Box 533 Zip 68027 Te (402) 556 3400—Hackensack, N.J., 65 Commerce Way Zip 07601 Te (201) 489 7400—Williamstown, N.J., PO Box 513 Zip 08044 Phila Te (215) 887 7650—Buffalo, N.Y., PO Box 4 Zip 14221 Te (716) 586 2580—Cleveland, Ohio, PO Box 134 Zip 44212 Te (216) 225 1262—Nashville, Tenn., PO Box 120532 Zip 37212 Te (615) 256 4836—Dallas, Tex., 1615 Prudential Dr. Zip 75235 Te (214) 637 5100—Houston, Tex., 1300 Telephone Rd. Zip 77087 Te (713) 928 3741—Salt Lake City, Utah, 2880 S. Wain Suite 111 Zip 84115 Te (801) 487 8111—Seattle, Wash., 628 Industry Cr. Bldg. 8 Zip 98188 Te (206) 575 0156

Product: Tape—head cleaners, demagnetizer, leader & splicing tape (M)

Ampro Design Prod'n Inc., see Dist. C Inc.

R. B. Annis Co., 1101 N. Delaware St., Indianapolis, Ind. 46202 Te (317) 537 5242 Owner: R. B. Annis

Product: Tape—demagnetizers (audio & video) (Han D. May) pocket magnetometer (Annis) (M)

Apres Audio Ltd., 77 Revere Court, Suffern, N.Y. 10901 Te (914) 368 0866 Pres.: Eric Snupack, Sales Mgr.: Midey Snupack, Adv. Mgr.: Alan Snupack

Product: Designer audio & video furniture (Apres), speaker-wall brackets (Audio Architects)

Arista Ent. Inc., 35 Hoffman Ave., Hauppauge, N.Y. 11787 Te (516) 234 7000

Product: Record—record care prods., replacement stylus, 45 rpm adaptors—Tape—head cleaners, demagnetizers, leader & splicing tape

Aspen Ltd., 77 E. Floyd Ave., Englewood, Colo. 80110 Te (303) 789 2239 Pres. Sid Laks, Sales Mgr.: Bill Bystrom, Adv. Mgr.: K. Davis

Product: Record—record care prods., anti-static cleaner & scratch re-

mover, stylus cleaner, Tape—head cleaners & demagnetizers, test tape (M)

Audio Accessories Co., 38 W. 515 Deerpath Rd., Batavia, Ill. 60510 Te (312) 879-5998 Sales Mgr.: John S. Maloney

Product: Tape—carrying & storage cases (audio & video), head cleaners (audio), cassette hub locks (AA), cassette repair kit (Sav A-Tape), plastic splicing blocks

Audio Architects, see Apres

Audio Grooms, see Empire

Audio Inds. Inc., Broad & Linden Aves., Ridgefield, N.J. 07657 Te (201) 945-4545

Product: Tape—head cleaners, leader tape (M)

Audio Kare (div. of Hammond Inds. Inc.), 155 Michael Dr., Syosset, N.Y. 11791 Te (516) 364 1900 Pres.: Colin E. Hammond, VP: David C. Rich, Sales Mgr.: Vincent E. Finnegan Jr.

Product: Record—turntable level, Tape—cleaners (Quietone), head cleaners (TPC)

Audiolab Electronics, 3725 Esperanza Dr., Sacramento, Calif. 95825 Te (916) 485 0500

Product: Tape—demagnetizers (MD)

Automatic Corp., 1290 Ave. of the Americas, New York, N.Y. 10019 Te (212) 582-4870 Telex: 126419 Pres.: Milton B. Gelfand, VP: Customer Servs.: Marilyn J. Best, Adv. Mgr.: J.P. Lohman Local branch: Audio Matrix Inc., 915 Westchester Ave., Bx. 10459 Te 589-3500

Product: Tape—leader & splicing tape (audio)

Audio Technica US Inc., 1221 Commerce Dr., Stow, Ohio 44224 Te (216) 686 2600 Pres.: Jon R. Kelly, Sr. VP: Fred Nichols, VP: Sales: Paul A. McGuire; Mktg. Communications Dir.: Don Kirkendall

Product: Record—record care prods., preservatives, record cleaners, stylus cleaners, replacement stylus, tonearm lifts, phono cables (M)

Audioteq (div. of GC Electronics), 400 S. Wyman St., Rockford, Ill. 61101 Te (815) 968 9661 Cable: GCELECT

Product: Record—record care prods., (Record Basic, Record Plus, Blue Max, Record Purifier), anti-static turntable mat, 45 rpm adaptors, Tape—head cleaners, demagnetizers, leader tape, splicing tape & equip

B A S F Systems Corp., Crosby Dr., Bedford, Mass. 01730 Te (617) 271 4000 Audio Prod. Mgr.: John P. Hillz

Branches: Santa Monica, Calif., 1307 Colorado Ave. Zip 90404 Te (213) 451 8781—Atlanta, Ga., 3360 Buckley Rd., Suite 403, Zip 30341 Te (404) 455 4145—Palatine, Ill., 800 E. Northwest Hwy., Suite 220 Zip 60067 Te (312) 934 4990—Ridgewood, N.J., 579 Franklin Tpk. Zip 01730 Te (201) 447-6904

Product: Tape—Cassette storage units

B M I (Bokor-Merzon Inc.), 4916 Maspeth Ave., Maspeth, N.Y. 11378 Te (212) 381 1303

Product: Record—carrying cases, record care prods., Tape—carrying cases, cassette head cleaners

Kenneth A. Bacon Assocs., 216 Montego Key, Novato, Calif. 94947 Te (415) 883-5041 Owner: Kenneth A. Bacon, Prod'n Mgr.: Rick Bacon

Product: Tape—carrying & storage cases, bulk erasers, demagnetizers, leader tape, splicing tape & equip (all audio)

Bazy Electronics Corp., 39 N. Ros., Mount Clemens, Mich. 48043 Te (313) 463 2592

Product: Tape—head cleaners, demagnetizers

Bib, 1751 Jay Ell Dr., Richardson, Tex. 75081 Te (214) 238-1224 Telex: 792451 Mng. Dir. (USA): Stephen Godfrey, Nat'l Sales Mgr.: Michael Craft, Internal Sales Coord.: Debra McBride

Home office: England

Product: Record—record care prods., Tape—head cleaners, demagnetizers, splicing tape & equip. (audio & video)

Blackbourn Inc., 10150 Crosstown Circle, Eden Prairie, Minn. 55344 Te (612) 944 7010 Pres. & Adv. Mgr.: George F. Snelgrove; Sales Mgr.: Thomas F. Sabow

Product: Tape—vinyl cassette albums (audio & video) (M)

Black Magic, see Recoton

Blue Max, see Audiotex

Bokor—Merzon, see BMI

Bowers Rec. Sleeve Co., 5331 N. Tacoma Ave., Indianapolis, Ind. 46220 Te (317) 251 3918 Pres.: James E. Bowers, VP: Thomas R. Bowers

Product: Record—replacement record sleeves (Lifetime Protectors, Protect Your Records), LP & tape gift wraps, polyethylene jacket covers (M)

W. H. Brady Co., PO Box 571, 727 W. Glendale Ave., Milwaukee, Wis. 53201 Te (414) 332 8100 Cable: BRADYCD Telex: 26677 Gen. Mgr.: John Arnold, Mktg. Mgr.: Ken Vaughn

Product: Tape—leader & splicing tape

Broadcast Electronics Inc. (a Filmways Co.), 4100 N. 24 St., Quincy, Ill. 62301 Te (217) 224-9600 Cable: SPDTMASTER Pres.: Lawrence J. Cervon, VP: Mktg. C: Kring, Sales Mgr.: J. Engle, Adv. Mgr.: Thomas R. Humphrey

Product: Tape—carrying & storage cases, head cleaners, demagnetizers, leader & splicing tape

Calibron, see Horan

Cambr, see RNS

Carter Corp., 1916 11 St., Rockford, Ill. 61101 Te (815) 397-3200 Cable: CARTERCDRP Pres.: Robert L. Fleming, VP: Sales & Mktg.: Sandra L. Fleming, Plant Mgr.: W. Skip Kruger

Product: Record—replacement stylus, 45 rpm adaptors, Tape—head cleaners, demagnetizers, splicing tape, connectors, cables, adaptors & other video accessory prods.

Certron Corp., 1701 S. State College Blvd., Anaheim, Calif. 92806 Te (714) 634-4280 TWX (910) 593-1611 Pres.: Edwin Gamson, VP: Mktg.: Ray Allen, Adv. Mgr.: Hal Wilde; Sales Mgr.: Monica Terrill

Product: Tape—head cleaners

Clean Sound, see Recoton

Clean Sweep, see Horan

Clean-Track, see Horan

Coastal Specialty Tapes Inc., 274 Bangor St., Lindenhurst, N.Y. 11757 Te (516) 226-5900 Dpns. Head & Sales Mgr.: Dan Dobbs

Product: Tape—leader tape: splicing tape (CMC)

Continental Electronics, 4087 Glencoe Ave., Marina del Rey, Calif. 90291 Te (213) 822 2045 Sales Mgr.: John Adams

Product: Record—carrying & storage cases, record care prods., turntable mats, 45 rpm adaptors, replacement stylus; Tape—carrying & storage cases, head cleaners, bulk erasers, demagnetizers, leader tape, splicing tape & equip

C'estmark Inds., Edison, N.J. 08817 Te (201) 225-0700

Product: Record & Tape—carrying & storage cases

Custom Case Mfg. Co., 6232 Bragg Blvd., Fayetteville, N.C. 28303 Te (919) 867-4106 Pres.: Al Metzger; Nat'l Sales Mgr.: Judy Harris

Product: Record & Tape—carrying & storage cases (M)

Custom Dupl'n Inc., 6330-36 Arizona Circle, Los Angeles, Calif. 90045 Te (213) 670-5575 Pres.: Leonard Gracie, Sales Mgr.: Bob Hively, Prod'n Mgr.: Jeri Gonzales

Product: Tape—head cleaners, leader tape, splicing tape & equip (CDI) (M)

D M I, see Display Media

D Stat II, see Discwasher

Daym Corp., 1 Park St., Amsterdam, N.Y. 12010 Te (518) 842-4800

Product: Home audio furniture

Data Packaging Corp., 205 Broadway, Cambridge, Mass. 02139 Te (617) 868 6200 Pres.: Dito Morningstar, Exec. VP: Gregory Mathus; VP: Mktg.: Jeri Hill, Sales & Mktg. Mgrs.: (audio-video) Gene Hull, (consumer) Peggy Harmatz

Product: Record & Tape—carrying & storage cases (Dynasound) (M)

Delrama Int'l., 37 Newtown Rd., Plainview, N.Y. 11803 Te (516) 293 8740

Product: Record—record care prods (M)

Diellectrics Inc., 300 Burnett Rd., Chicopee, Mass. 01020 Te (413) 598 8308

Product: Record & Tape—carrying & storage cases (custom fabrication) (M)

DISContinued Recs., 444 S. Victory Blvd., Burbank, Calif. 91502 Te (213) 849 4791, 846 9192 Owner: Les Szarvas

Product: Reference library of out of print recorded material

Discover Division Inc., 5198 W. 76 St., Minneapolis, Minn. 55435 Te (612) 831 5338 Pres.: Paul W. Smith, VP: Les Boelter

Product: Record—record care prods

DiscTraker, see Discwasher

Discwasher Inc., 1407 N. Providence Rd., Columbia, Mo. 65201 Te (314) 449 0941 Pres.: Bruce R. Marer, Nat'l Sales Mgr.: James D. Hall, Adv. Mgr.: Vickie Williamson

Product: Record—record care prods., cleaner (Discwasher system), stylus cleaner (SC 2) piezoelectric anti-static gun (Zerostat), audio connector cables (Gold ens), anti-static turntable mat (D Stat II), turntable isolation damping device (DiscFoot), speaker cables (Smog Lifters), Tape—head cleaners (audio) (Perfect Path)

Display Media Inc., 120 Laura Dr., Addison, Ill. 60101 Te (312) 543 8330 Pres. & Gen. Mgr.: R. Grubben

Product: Record & Tape—carrying & storage cases (DMI) (M)

Distec Inc., 42 Barringer Dr., Charlotte, N.C. 28210 Te (704) 527 6931 VP & Gen. Mgr.: Fred E. Martiniz

Product: Record—carrying & storage cases, record care prods. (Dustbuster), Tape—head cleaners, demagnetizers

Tel. (516) 378-0440. Pres.: Michael Damsky. Nat'l Sales Mgr.: Bill Ranshous. Adv. Co-ord.: Charlotte Larson.
Product: Record—45 rpm adaptors, replacement styli (Electro voice, Pro Mag.) (M)

Electronic Homes Co., 1225 Broadway, Main Floor, New York, N.Y. 10001
Tel. (212) 725-0290, Bd. Chm.: George T. Saddler; Sales Mgr.: Elias Smyrnakis. Adv. Mgr.: Joe Gary
Product: Tape—storage cases, head cleaners, demagnetizers (Toyota) (M)

ElectroVoice, see EVG.

El Mar Plastics Inc., 821 E. Artesia Blvd., Carson, Calif. 90746. Tel. (213) 327-3180. Cable: ELMAR TWX. (910) 346-6940. Pres.: Allen Schor.
Product: Tape—cassette storage box, head cleaners, demagnetizers, splicing tape. (M)

Empire Scientific Corp., 1055 Stewart Ave., Garden City, N.Y. 11530. Tel. (516) 222-1400. Telex: 125472. VP Sales: Andrew D. Segal.
Product: Record—record care prods. (Audio Groome, Watts) replacement styli (for Empire phono cartridges) (M)

Ergone Sure, see Magnesonics

Esselte Pendaflex Corp., 300 Garden City Plaza, Garden City, N.Y. 11530. Tel. (516) 741-3200.
Product: Record & Tape—carrying & storage cases (Music Library) (M)
Ever-Ready Packaging & Assembly, see Reliance Plastics.

Fidelipac Corp., 109 Gaither Dr., Mount Laurel, N.J. 08057. Tel. (609) 235-3511. TWX: (710) 897-0254. Pres.: Roger Thanhauser; Sales & Mktg Mgr.: Arthur Constantine.
Product: Tape—carrying & storage cases, head cleaners, demagnetizers, splicing tape & equip. (M)

Fidelitone Inc., 3001 Malmo Rd., Arlington Heights, Ill. 60005. Tel. (312) 640-2473. Telex: 281050. Pres.: Charles M. Smith; Sales Mgr.: Gordon Dakes; Adv. Mgr.: Joe Singer.
Product: Tape—video storage chests.

Filam Nat'l Plastics Inc., 416 W. El Segundo, Los Angeles, Calif. 90061. Tel. (213) 515-0623.
Product: Tape—storage cases

Finelbit Mfg. Co. Inc., 931 N. Citrus Ave., Hollywood, Calif. 90038. Tel. (213) 466-9511. Pres.: Alvin P. Schmid; VP: Joseph Bouzoglou; Sales Mgr.: Manuel Munoz
Product: Tape—head cleaners, leader tape (Finetape)

Fine Design Prods. Inc., 1830 S. Clinton, Chicago, Ill. 60616. Tel. (312) 939-5420. Pres.: Harvey Fine; Gen. Mgr.: Dorothy Dison; Sales Mgr.: Richard Doherty
Product: Record & Tape—carrying & storage cases. (M)

Finetape, see Finelbit

Fuji Photo Film USA Inc., Magnetic Tape Div., 350 Fifth Ave., 70th fl., New York, N.Y. 10118. Tel. (212) 736-3335. VP & Gen. Mgr.: John Dale. Nat'l Sales Mgr.: John Bermingham; Adv. Mgr.: Margaretha Bystrom
Product: Tape—1/2" videocassette head cleaning cassettes

G C Electronics, 400 S. Wyman St., Rockford, Ill. 61101. Tel. (815) 968-9661. Cable: GCELECT VP & Gen. Mgr.: Wayne Timpe; Sales & Special Mkts. Dir.: James E. Heighway; Adv. Joyce Donahue.
Product: Record—record care prods. 45 RPM adaptors, record handler grip device; Tape—head cleaners, demagnetizers, tape erasers & splicers. (M)

Gabriel Mfg. Co. Inc., 125 S. Liberty Dr., Stoney Point, N.Y. 10980. Tel. (914) 942-0100. Pres.: Ed Gabriel; VP: Richard Gabriel; Gen. Mgr.: Vin Tullo; Adv. Mgr.: Ellen Gabriel
Product: Tape—head cleaners. (M)

Gold-ens, see Discwasher

Gusdorf Corp., 6900 Manchester Ave., St. Louis, Mo. 63143. Tel. (314) 647-1207. Cable: GUSDSDSN. Telex: 44821.
Product: Electronics furniture

Han-D-Mag, see RB Anns

Hartzell Custom Prods., Turtle Lake, Wis. 54889. Tel. (715) 986-4407.
Product: Record & Tape—carrying & storage cases (The Organizer) (M)

Herald Electronics (div. of Teledyne Inc.), 6611 Lincoln Ave., Lincolnwood, Ill. 60465. Tel. (312) 675-1100. Pres.: Charles F. Kellner; Sales Mgr.: Hank Katz.
Product: Record—45 RPM adaptors; Tape—carrying & storage cases, demagnetizers.

Hervic Electronics Inc., 18750 Dixnard St., Tarzana, Calif. 91356. Tel. (213) 343-3441. Gen. Mgr.: Armand Herskovic; Sales & Adv. Mgr.: Warren Harwood.
Product: Record—stylus cleaners, turntable accessories

Horan Eng'g Inc., 600 Lake Emma Rd., Lake Mary, Fla. 32746. Tel. (305) 323-2400. Pres.: Richard C. Horan; Gen. Mgr.: James Horan; Sales Mgr.: Robert L. Horan; Adv. Mgr.: Sue Coleman
Product: Record—carrying & storage cases, record care prods. (Calibron, Clean-Sweep); Tape—carrying & storage cases, head cleaners, demagnetizers (Calibron, Clean-Track) (M)

I P S., 107 Bridge Rd., Hauppauge, N.Y. 11787. Tel. (516) 234-3222.
Product: Tape—8 tr. & cassette head cleaners

Imperial Plastics Inc., PO Box 246, Lakeville, Minn. 55044. Tel. (612) 469-4951. Pres.: John Gambell; Nat'l Sales Mgr.: Daniel P. Mahoney
Product: Record—carrying & storage cases; Tape—carrying & storage cases, plastic security boxes for cartridges & cassettes

International Rec'g Co., 1649 E. Evergreen Ave., Chicago, Ill. 60622. Tel. (312) 227-2000. Pres.: Leonard March.
Product: Record—record care prods., turntable mats, 45 RPM adaptors, replacement styli; Tape—head cleaners, bulk erasers, demagnetizers, leader tape, splicing tape & equip.

Irish Magnetic Rec'g Tape (div. of Mohan Nat'l Sales Co. Inc.), 270-78 Newtown Rd., Plainview, N.Y. 11803. Tel. (516) 293-5582. Cable: MDRH-NEX. Telex: 96-7880. Pres.: G. Zigman; Sales Mgr.: George Krug; Adv. Mgr.: George Taub
Product: Tape—head cleaners. (M)

Itera Ltd., 1535 Broad St., North Bellmore, N.Y. 11710. Tel. (516) 785-6480
Product: Record—replacement styli; Tape—cassette storage library, tape carousels & storage centers, demagnetizers

Jacksonville Ginter Box Co. Inc., 2527 Walnut St., Jacksonville, Fla. 32206. Tel. (904) 355-8341
Product: Record—LP storage rack (Pack Rack); Tape—8 tr. case

K A/Kustom Acoustics Inc., 6628 W. Irving Park Rd., Chicago, Ill. 60634. Tel. (312) 685-6609. Pres.: Ted R. Karson.
Product: Speaker stands, audio cable

King Instrument Corp., 80 Turnpike Rd., Westboro, Mass. 01581. Tel. (617) 366-9141. Pres.: William H. Anderson; VP Sales: William E. Cline
Product: Tape—splicing tape

Kustom Kreations Inc., 19316 Londelius St., Northridge, Calif. 91324. Tel. (213) 886-8383.
Product: Tape—carrying & storage cases. (M)

Lafayette Radio Electronics Corp., 111 Jericho Tpk., Syosset, N.Y. 11791. Tel. (516) 921-7700
Product: Tape—demagnetizers. (M)

Le-Bo Prods. Co. Inc. (div. of Peerless VidTronics Corp.), 58-60 Grand Ave., Masopeth, N.Y. 11378. Tel. (212) 894-5155. Cable: LEEDPRDDUX. Telex: 424790. Pres.: P. Dayton
Product: Record—carrying & storage cases, record care prods., turntable mats, 45 rpm adaptors, replacement styli; Tape—carrying & storage cases, head cleaners, bulk erasers, demagnetizers

Lifetime Protectors, see Bowers

Linear Sound Rec'g, 211 Glenridge Ave., Montclair, N.J. 07042. Tel. (201) 744-0686. Pres.: M. Kroll; Sales Mgr.: T. Steinman
Product: Tape—carrying & storage cases, head cleaners, demagnetizers, leader & splicing tape

M J S, 2514 Seaboard Ave., San Jose, Calif. 95131. Tel. (408) 262-8793. Owner: Michael Steiner
Product: Tape—head cleaners

M M C, see Magnetic Mktg

Magnesonics Sales & Mfg. Co., 3740-E Transport, Ventura, Calif. 93003. Tel. (805) 642-3092. Pres.: Donald P. Grosslight.
Product: Tape—bulk erasers (Erase-Sure), cassette rewinder (Rapid-Winder)

Magnetic Mktg Corp., 29 Valley View Terr., Wayne, N.J. 07470. Tel. (201) 694-3502. Telex: 138558. Pres.: Thomas J. Hofbauer; Sales Mgr.: Brendan F. Browne; Adv. Mgr.: M. Judge
Product: Tape—demagnetizers, bulk erasers (MMC) (M)

Magnetic Media Corp., 500 Eastern Pkwy., Farmingdale, N.Y. 11735. Tel. (516) 293-1010. Cable: MAGMEDIA. Telex: 143223. Pres.: Aaron Wasserstrom; Gen. Mgr.: John Christiano; Sales Mgr.: Paul Mastroianni.
Product: Tape—leader tape (audio) (M)

Mallory Dist'r Prods. Co., 3029 E. Washington Ave., Indianapolis, Ind. 46201. Tel. (317) 636-5353.
Product: Tape—head cleaners. (M)

Marsand Inds. Inc., 5150 W. Jefferson Blvd., Los Angeles, Calif. 90016. Tel. (213) 938-2755. Exec. VP: Martin A. Waterman; VP Sales: Ron News-wander
Product: Record—carrying & storage cases. Tape—carrying & storage cases (audio & video) (M)

Marshall Electronics Inc., PO Box 2027, Culver City, Calif. 90230. Tel. (213) 836-4288. Pres.: H. Shultz; Sales Mgr.: L. Marshall; Adv. Mgr.: W. Rex Branch; Tuckahoe, N.Y., LCA Sales Co., 76 Main St., Tel. 10707. Tel. (914) 961-4700. Sales Mgr.: Bob Sherwood.
Product: Tape—microphone cable, video camera cable.

Mastro Inds. Inc., 3040 Webster Ave., Bronx, N.Y. 10467. Tel. (212) 547-5600. Pres.: Mario Maccaferri.
Product: Tape—head cleaners, 8-tr. dust caps.

Maxell Corp. of America, 60 Oxford Dr., Monticello, N.J. 07074. Tel. (201) 440-8020. Pres.: T. Diada; Nat'l Sales Mgrs.: (consumer audio) M. Standley, (consumer video) D. Patricia, (professional/industrial prods.) J. Ringwood; Adv. Mgr.: Chris Mangiapane.
Product: Tape—demagnetizers (audio)

Vernon McMillan Inc., 801 Newark Ave., Elizabeth, N.J. 07208. Tel. (201) 352-8800.
Product: Record & Tape—carrying & storage cases (Amberg) (M)

Memorex Corp., Consumer Prods. Group, 1600 Memorex Dr., Santa Clara, Calif. 95052. Tel. (408) 987-1752. Telex: 334492. VP & Gen. Mgr.: John R. Humphreys; Mktg. Mgr.: Albert P. Pepper; Nat'l Sales Mgr.: Jack C. Battaglia.
Branches: Garden Grove, Calif., 12821 Western Ave., Suite L. Zip: 92641. Tel. (714) 891-2541—Lombard, Ill., 335 Eisenhower Ln. S. Zip: 60148. Tel. (312) 620-3240—Cincinnati, Ohio, 8170 Corporate Park Dr. Zip: 45242. Tel. (513) 891-3380—King of Prussia, Pa., 741 Fifth Ave. Zip: 19406. Tel. (215) 337-1050—McLean, Va., 1970 Chain Bridge Rd. Zip: 22101. Tel. (703) 821-3300—Lynnwood, Wash., 4208-198 SW, Suite 110. Zip: 98036. Tel. (206) 774-6507
Product: Record—record care prods., Tape—8 tr. head & capstan cleaners, cassette head cleaners, cassette cleaning kit.

Metacorn Inc., 1401-B.W. River Rd. N., Minneapolis, Minn. 55411. Tel. (612) 588-2781. Pres.: James I. McCann; Sales Mgr.: Phillip T. Levin; Adv. Mgr.: Timothy Dewbliss.
Product: Tape—carrying & storage cases. (MD)

Metrocare, see RNS

MetroSound, see RNS

Micro-Trak Corp., 620 Race St., Holyoke, Mass. 01040. Tel. (413) 536-3551. Pres. & Sales Mgr.: William E. Stacy
Product: Tape—carrying & storage cases (audio) (M)

Microtran Co. Inc., PO Box 236, 145 E. Mineola Ave., Valley Stream, N.Y. 11582. Tel. (516) 561-6050.
Product: Tape—head cleaners, demagnetizers. (M)

Mid America Plastics Corp., 6900 Canby, Reseda, Calif. 91335. WATS Tel. (800) 423-5000.
Product: Tape—carrying & storage cases (audio & video)

Monster Cable Co., 101 Townsend St., San Francisco, Calif. 94107. Tel. (415) 777-1355. Telex: 470584. Pres.: Noel Lee; Sales Mgr.: Jan Whitaker; Production: Andy Choy.
Product: Speaker cables & connectors (Monster Cable, Powerline); Record—disk stabilizers, head shells (Drasonic).
Music Library, see Esselte Pendaflex

Nakamichi USA Corp., 1101 Colorado Ave., Santa Monica, Calif. 90403. Tel. (213) 451-5901. Pres.: E. Nakamichi; VP & Nat'l Sales Mgr.: Katsura Izumi.
Product: Tape—demagnetizers.

National Audio Co. Inc., Box 3657 GS, Springfield, Mo. 65804. Tel. (417) 883-5377.
Product: Tape—bulk erasers, splicing tape & equip. (audio & video); leader tape (audio).

North American Tape Dupl'g Co., 15414 Cabrito Rd., Van Nuys, Calif. 91406. Tel. (213) 781-7650. VP & Gen. Mgr.: Norm Teter; Mktg. Dir.: Larry Stagnaro.
Product: Tape—carrying & storage cases (audio); head cleaners (audio), bulk erasers (audio), demagnetizers (audio).

Nortronics Co. Inc., 8101 10 Ave. N., Minneapolis, Minn. 55427. Tel. (612) 545-0401. Nat'l Sales Mgr.: Ken Lubitz.
Product: Tape—carrying & storage cases (audio), head cleaners, bulk erasers, demagnetizers, splicing tape (M)

Nuclear Prods. Co., PO Box 5178, El Monte, Calif. 91734. Tel. (213) 283-2603. Pres. & Gen. Mgr.: Richard M. Elveth.
Product: Record—record care prods.: cleaning brush (Staticmaster) (M)
The Organizer, see Hartzell

Drasonic, see Monster Cable

Osawa & Co. Inc., 21 Harbor Park Dr., Port Washington, N.Y. 11050. Tel. (516) 484-5455. Pres.: Y. Dhamoto; VP Sales: Jack McMurray; Adv. Mgr.: Vince Wheeler.

Product: Record—record care prods. (Nagaoka), turntable mats; Tape—head cleaners (audio), splicing tape & equip. (audio).

Pacific Int'l Magnetics Inc., 185 Berry St., No. 3865, San Francisco, Calif. 94107. Tel. (415) 495-8830.
Home office: Canada.
Product: Tape—carrying & storage cases, head cleaners, bulk erasers (audio & video); demagnetizers, (audio), leader tape (audio), splicing tape & equip. (audio & video).

Pack Rack, see Jacksonville

Paramount Housewares, 1035 Westminster Ave., Alhambra, Calif. 91803. Tel. (213) 570-1601. Pres.: Joseph D. Winston; Sales & Adv. Mgr.: Charles W. Holmes.
Product: Tape—storage cases.

Peerless Vid-Tronics Corp., 60 West St., Bloomfield, N.J. 07003. Tel. (201) 429-8600. Pres.: Herb Ravis; Sales Mgr.: Andy Danzico.
Product: Record—carrying & storage cases; Tape—carrying & storage cases, head cleaners, demagnetizers. (M)

Perfect Path, see Discwasher

Permatost, see Stanton

Pfanstiel Chemical Corp., 3300 Washington St., Waukegan, Ill. 60085. Tel. (312) 623-1360. Pres.: Merle R. Nelson; Mkt. Dir.: Bob Wight.
Product: Record—record care prods., 45 rpm adaptors, (all Pfantone); replacement styli (Pfanstiel); Tape—head cleaners (Pfantone)

Pfantone, see Pfantstiel

Phylco Audio, 4709 Brooks St., Montclair, Calif. 91763. Tel. (714) 621-9561. Owner: Robert Deates; Gen. Mgr.: Rick Deates.
Product: Tape—head cleaners, leader tape, splicing tape (all audio).

Pramobile, see Advance Prods.

Profil, see Somic Research

Plasti Plex Corp., 1209 Chicago Rd., Troy, Mich. 48084. Tel. (313) 589-1771.
Product: Record—storage cases, record care prods.; Tape—storage cases.

Port-A-Tune (div. of Action Leathercraft Inc.), 5340 E. Harbor Commerce, Calif. 90040. Tel. (213) 728-1155.
Product: Record & Tape—carrying & storage cases.

Powerline, see Monster Cable

Pro Mag, see EVG.

Pro I Audio-Visual Inc., PO Box 33, Highland Park, Ill. 60035. Tel. (312) 433-4575. Pres.: R.L. Pink, VP: J. Pink; Sales Mgr.: M.M. Pink; Adv. Mgr.: D.D. Pink.
Product: Record & Tape—carrying & storage cases.

Protect Your Records, see Bowers

Pyramid Mfg. Inc., 13127 Harper Ave., Detroit, Mich. 48213. Tel. (313) 839-2888. Pres.: Russ DiBartolomeo.
Product: Tape—modular storage furniture (Videnza)

Q-A-I Inc., 640 Dell Rd., Carlstadt, N.J. 07072. Tel. (201) 460-0060. NYC (212) 964-1714. Pres.: Steve Dauman; Sales Mgr.: George Ratowsky.
Product: Tape—splicing & cueing tape.

Q R K, see Broadcast Electronics

Quietone, see Audio-Kare

R C 4, see Stanton

R M S Electronics Inc., 50 Antin Pl., Bronx, N.Y. 10462. Tel. (212) 892-6700. Pres.: Arthur A. Fink; VP: Albert Goldstein; Sales Mgr.: Seymour Goldberg.
Product: Tape—carrying & storage cases, videocassette recorder accessories, camera cables, video connectors. (M)

R N S Inc., 7 Manor Dr., Dah Ridge, N.J. 07438. Tel. (201) 697-2212. Pres.: Robert N. Schwartz; Gen. Mgr.: Elizabeth Schwartz; Sales Mgr.: Gary Pranchitas.
Product: Record—record care prods. (Metrocare, MetroSound); Tape—carrying & storage cases, head cleaners (MetroSound); leader & splicing tape. (I)

Radio Shack (div. of Tandy Corp.), 1 Tandy Center, Fort Worth, Tex. 76086. Tel. (817) 390-3272.
Product: Record—record care prods., turntable mats, 45 RPM adaptors, replacement styli, patch cords; Tape—carrying & storage cases, head cleaners (audio & video), bulk erasers, demagnetizers, leader tape, splicing tape & equip. (all Realistic).

Rapid-Winder, see Magnesonics

Raynor Sales Co. Inc., 2698 W. Pico Blvd., Los Angeles, Calif. 90006. Tel. (213) 737-3737. Pres. & Adv. Mgr.: Ray Abrams Sr.; Sales Mgr.: Ray Abrams Jr.
Product: Record—carrying & storage cases, record care prods., 45 rpm adaptors, replacement styli, record gift sleeves; Tape—head cleaners, demagnetizers, leader & splicing tape.

Realistic, see Radio Shack

Record Basic, see Audioteq

Record-Mate, see Akro-Mills

Record Plus, see Audioteq

Record Purifier, see Audioteq

Reconon Corp., 46-23 Crane St., Long Island City, N.Y. 11101. Tel. (212) 392-6442. Pres.: Robert Borchardt; Exec. VP: Peter Wish; VP Sales: George Calvi.
Product: Record—carrying & storage cases, 45 rpm adaptors, replacement styli (all Reconon); record care prods. (Black Magic, Clean Sound); Tape—carrying & storage cases (audio & video), leader & splicing tape (Reconon); head cleaners (audio & video), & demagnetizers (Black Magic & Reconon), video cables & connectors, splitters & switching boxes. (M)

Reliance Plastics & Packaging Div., Reliance Folding Carton Corp., 225 Bellville Ave., Bloomfield, N.J. 07003. Tel. (201) 748-2222. Pres.: Marshall Weingarden; Sales Mgr.: Marion Burleigh.
Product: Tape—vinyl storage cases (audio & video), videocassette slip-cases. (M)

Rivertone Corp., Dillon Rd., Monticello, N.Y. 12701. Tel. (914) 794-8888.
Product: Record—carrying & storage cases, record care prods., 45 rpm adaptors, replacement styli; Tape—head cleaners.

Robins Inds. Corp., 75 Austin Blvd., Commack, N.Y. 11725. Tel. (516) 543-5200. Pres.: Herman Post; VP Sales: Stu Gaime.
Product: Record—carrying & storage cases, record care prods., 45 RPM adaptors, stylus pressure gauge (Grame); ionic static neutralizing gun (Rob-D-Stat), stylus microscope, phono pads & cushions; Tape—carrying & storage cases, head cleaners, demagnetizers, leader, splicing & sensing tape, bulk erasers, tape cleaners (Soundtrack Scrubbers); splicing & editing equip., cassette & 8-tr. repair kits, cassette tension winder, tape clips.

Rotef of America Inc., 13528 S. Normandie Ave., Gardena, Calif. 90249. Tel. (213) 327-0600. Pres. T. Tachikawa; Sales Mgr.: Mel Kaplan.
Product: Record—record care prods. (M)

S C 2, see Discwasher

S S K Ent's Inc., 2488 Towngate Rd., Westlake Village, Calif. 91361. Tel. (805) 889-1831.
Product: Tape—head cleaners (audio & video) (M)

Sav-A-Tape, see Audio Accessories

THE PERFECT SPLICE

Brady Splicing Tapes make it easy. That's because we developed both the tapes and the adhesives. So you get the right combination for perfect performance on manual or automated splicing equipment — in audio or video cassettes and 8-track cartridges. See the difference quality splicing tapes make.

To assure smooth, trouble-free feeding and operation, Brady splicing tapes are tested for separation under impact, for adhesive ooze, tensile and shear strength. And width tolerances are guaranteed by electronic measurement.

Adhesive coating thickness within micron limits eliminates layer to layer impressions that can cause sound or picture distortion in cassettes.

In every way, Brady makes sure you get the perfect splice. And Brady offers a complete line of splicing tapes for audio and video cassettes, 8-track stereo cartridges, master recordings, plus a wide selection of other tapes and materials.



For samples and complete information, call or write:

W. H. BRADY CO.
SPECIALTY TAPE PRODUCTS
727 W. Glendale Avenue
P.O. Box 571
Milwaukee, WI 53201
(414) 332-8100

© 1981, W. H. Brady Co. All rights reserved.



STP 1481

WHY YOU SHOULD MAKE A CORPORATE CONTRIBUTION TO THE AD COUNCIL

The Advertising Council is the biggest advertiser in the world. Last year, with the cooperation of all media, the Council placed almost six hundred million dollars of public service advertising. Yet its total operating expense budget was only \$1,147,000 which makes its advertising programs one of America's greatest bargains... for every \$1 cash outlay the Council is generating over \$600 of advertising.

U.S. business and associated groups contributed the dollars the Ad Council needs to create and manage this remarkable program. Advertisers, advertising agencies, and the media contributed the space and time.

Your company can play a role. If you believe in supporting public service efforts to help meet the challenges which face our nation today, then your company can do as many hundreds of others—large and small—have done. You can make a tax-deductible contribution to the Advertising Council.

At the very least you can, quite easily, find out more about how the Council works and what it does. Simply write to: Robert P. Keim, President, The Advertising Council, Inc., 825 Third Avenue, New York, New York 10022.

Ad Council A Public Service of This Magazine & The Advertising Council.

The cost of preparation of this advertisement was paid for by the American Business Press, the association of specialized business publications. This space was donated by this magazine.

Savoy Leather Mfg. Corp. Ward Hill Ind'l Park, 260 Neck Rd., Haverhill, Mass 01830. Tel: (617) 374-0351. TWX (710) 347 1121
 Product: Record & Tape—carrying & storage cases (audio & video)
 Saxton Prods. Inc., 215 N. Rt. 303, Congers, N.Y. 10920. Tel: (914) 268-6846
 Product: Record—replacement styli, Tape—demagnetizers
 Scotch, see 3M
 Seebro Prods. Co., 2416 S. Michigan Ave., Chicago, Ill 60616 Tel: (312) 842-8221. Pres. I. Siegal, Sales Mgr. R. Siegal
 Product: Record—carrying & storage cases, wire record racks, pole record racks, record carts; Tape—carrying & storage cases. (MD)
 Sentry Inds. Inc., 221 N. MacQueen Pkwy., Mount Vernon, N.Y. 10550
 Tel: (914) 664-2909 Cable SENTIND Pres. Harold Rosen, VP. Barry Rosen
 Product: Record—carrying & storage cases, record care prods., 45 RPM adaptors, replacement styli, Tape—carrying & storage cases, head cleaners, demagnetizers, leader & splicing tape. (MD)
 Service Mfg. Co. Inc., River St., Hastings-on-Hudson, N.Y. 10706 Tel: (914) 478-4000 Pres. Joseph L. Berkman, Nat'l Sales Mgr. Stuart Glenwick
 Product: Tape—carrying & storage cases, videocassette storage cabinets (M)
 Shape Inc., PO Box 366, Biddford Ind'l Park, Biddford, Me 04005 Tel: (207) 282-6155
 Product: Tape—audio & video cassette storage cases (Shape)
 Smog Lifters, see Oiscwasher
 Snap Jack Inc., 805 Clifton Ave., Clifton, N.J. 07013 Tel: (201) 779-0225
 Product: Record—LP jacket wall frames
 Sonar Radio Corp., 3000 Stirling Rd., Hollywood, Fla. 33021 Tel: (305) 981-8800. Chm.: Bernard E. Klein
 Product: Tape—Video bulk erasers (Videoraser)
 Sonic Research Inc., 27 Sugar Hollow Rd., Danbury, Conn 06810 Tel: (203) 792-8822. Pres. Peter E. Pritchard; Nat'l Sales & Mktg. Mgr. Ronald E. Wilcox. Adv. Mgr.: Elliot Ednick
 Product: Record—record care prods. (Pixoff) (I), replacement styli (Sonus) (M)
 Sonrise Audio Systems, 13622 NE 20 St., Bellevue, Wash. 98005 Tel: (206) 641-1900. Pres. Oouglas Anderson
 Product: Audio & video cabsnetry
 Sonus, see Sonic Research
 Sound Guard Corp. (div. of Audio Technica), 348 SW 13 Ave., Pompano Beach, Fla. 33060. Tel: (305) 782-1041. WATS (800) 327 1144 Pres. Greg Cornells
 Product: Record—record care prods.: preservatives cleaners, record care work pad, stylus care kit
 Sound/Pro Inds. Inc., 7529 Trasic Ave., Playa del Rey, Calif 90291. Tel: (213) 822-0510 Pres.: Oonald K. M. Rothgerly, Nat'l Mktg. Dir. Don Millard; Sales Mgr. Tom Reed; Adv. Mgr. Linda Newton
 Product: Tape—carrying & storage cases, head cleaners
 Soundtrack Scrubber, see Robins
 Speaker Uppers, 20946 Currier Rd., Walnut, Calif. 91789 Tel: (714) 598-1906
 Product: Speaker stands
 Stak-It by Visual Displays Corp., 675 Barbey St., Brooklyn, N.Y. 11207 Tel: 345-7300 Pres. Samuel Nadrich, Sales Mgr. Michael Nadrich, Plant Mgr. David Nadrich
 Product: Record & Tape—cabinets, stereo component & speaker stands, video component cabinets
 Stanford Int'l, PO Box 609, 569 Laurel St., San Carlos, Calif 94070 Tel: (415) 592-5958. Pres. Fred Dobbs, Opns Mgr. Jan Dillard
 Product: Tape—carrying & storage cases, head cleaners, bulk erasers, demagnetizers, leader & splicing tape
 Stanton Magnetics Inc., 200 Terminal Dr., Plainview, N.Y. 11803 Tel: (516) 349-0200 TWX (510) 221-1845 Pres. Walter O. Stanton, VP Prof Prods. Jim Fox, Prof. Prods. Nat'l Sales Mgr. Peter Bidwell, Adv. Mgr. Gordon Hurst
 Product: Record—record care prods. anti-static record preservative (Permostat); record care kit (RC4), replacement styli, stylus cleaning kit (Stanton)
 Statimaster, see Nuclear Prods
 Sterling Prods Co. Inc., 1689 Oakdale Ave., West St. Paul, Minn 55118 Tel: (612) 455 6691
 Product: Tape—carrying & storage cases
 Studio Magnetics Co. Inc., 12 Long Island Ave., Holtsville, N.Y. 11742 Tel: (516) 289-3400. Pres. George Chahane, VP. Craig M. Balaban
 Product: Tape—Non-abrasive cassette head cleaners, aerosol head cleaners, cassette storage modules (Add'N'Stac) (M)
 T O K Electronics Corp., 755 Eastgate Blvd., Garden City, N.Y. 11530 Tel: (516) 746-0880 Telex: 144535 VP & Gen Mgr. Ken Kohda, Sales Mgr. John Schattin, Video Prod. Mgr. Ed Pessara
 Branches: Irvine, Calif., 2102 E. Alton St. Zip 92714 Tel: (714) 979-5811 WATS (800) 854-0123 Div. Mgr. Lee Adams—Marietta, Ga., 4062 Kingston Court Zip 30067 Tel: (404) 952-4600 Reg'l Mgr. George Casleel—Des Plaines, Ill., 1011 E. Touhy Ave., Suite 165 Zip 60018 Tel: (312) 297-1341 WATS (800) 323-5956 Reg'l Mgr. Jack Pender
 Product: Tape—carrying & storage cases, head cleaners, demagnetizers (M)
 T P C, see Audio Kare
 Taberacer, see Taber Mfg
 Taber Mfg. & Eng'g Co., 2081 Edison Ave., San Leandro, Calif 94577 Tel: (415) 635-3831
 Product: Tape—demagnetizers (Taberacer) (M)
 Tapecom Inc., 45 Jefferson St., Stamford, Conn. 06902 Tel: (203) 325-1541 TWX (710) 474 3334 Pres. Gene Tornatore, VP. Fred Luminoso
 Product: Tape—carrying & storage cases
 Tapemaker Sales Co. Inc., 48 Urban Ave., Westbury, N.Y. 11590 Tel: (516) 333-2700. Pres. Arthur Brandwein, Office Mgr. Karen Sitkoff
 Product: Tape—splicing tape (M)
 Tape Mate, see Akro-Mills
 Tape Servs. Inc., Cherry Hill Ind'l Park, 1 Keystone Ave., Cherry Hill, N.J. 08003 Tel: (609) 424 9450 Sales Mgr. Michael I. Mulcahy
 Product: Record—record care prods. (private label), Tape—head cleaners, demagnetizers (M)
 Teac Corp. of America, 7733 Telegraph Rd., Montebello, Calif 90640 Tel: (213) 726-0303 Pres. Norio Tamura, VP Mktg. Barry Goldman, Gen Mgr. Gary Beckerman, Adv. Mgr. Tay Hotta
 Product: Tape—head cleaners, demagnetizers (M)
 Televex, see Aldshar
 Tempo (div. of Hagerstown Leather Goods Co.), 858 Willow Circle, Hagers town, Md. 21740 Tel: (301) 797-6600 Pres. Or. Harold N. Taylor, VP Mktg. David L. Handler
 Product: Record & Tape—"custom made" carrying & storage cases (audio & video)
 J M Co., Audio/Video Prods. Div., 3M Center, St Bldg 223-5N, St Paul, Minn. 55101 Tel: (612) 733-1466. Coro VP: D.E. Oenham, Div VP: J.E.

Povoiny Mktg. Dir. W.J. Madden Nat'l Sales Mgr. J.L. Leon Mkt Opns Mgr. J.B. Hanks, Mkt Communications Mgr. D.J. Linehan
 Branches: Anchorage, Alaska, 5531 Minnesota Dr. Zip 99502 Tel: (907) 276 2363—Burbank, Calif., 126 W. Elm Court Zip 91502 Tel: (213) 848 5534—Los Angeles, Calif., 6023 S. Garfield Ave. Zip 90040 Tel: (213) 726 6300—South San Francisco, Calif., 320 Shaw Rd. Zip 94080 Tel: (415) 589 2663—Washington, D.C., 1101 15 St. NW Zip 20005 Tel: (202) 331 6900—Atlanta, Ga., 2860 Bankers Ind'l Dr. Zip 30360 Tel: (404) 447 7000—Honolulu, Hawaii, PO Box 30048, 4443 Malaas St. Zip 96818—Argo, Ill., 6850 S. Harlem Ave. Zip 60501 Tel: (312) 496-6500—Needham Heights, Mass., 155 Fourth Ave. Zip 02194. Tel: (617) 449 0300—Farmington, Mich., 23923 Research Dr. Zip 48024 Tel: (313) 477 5000—Eagan, Minn., PO Box 33211, St. Paul 55133, 3130 Lexington Ave. S. Zip 55121 Tel: (612) 733 3300—St. Louis, Mo., PO Box 510 10725 Baur Blvd. Zip 63166 Tel: (314) 997 8500—West Caldwell, N.J., PO Box 76, 15 Henderson Dr. Zip 07006 Tel: (201) 575 2000—Cincinnati, Ohio, 4835 Para Dr. Zip 45237 Tel: (513) 242 2313—Cleveland, Ohio, 12200 Brookpark Rd. Zip 44130 Tel: (216) 267 1800—Philadelphia, Pa., 5698 Rising Sun Ave. Zip 19120 Tel: (215) 728 5300—Dallas, Tex., 2121 Santa Ana Ave. Zip 75228 Tel: (214) 324 8100—Seattle, Wash., Andover Ind'l Park, 100 Andover Park W. Zip 98188. Tel: (206) 244 7200
 Product: Tape—carrying & storage cases, head cleaners, leader & splicing tape (Scotch) (M)
 Toyota, see Electronic Homes
 Trackmaster Inc., 1310 S. Dixie Hwy W., Pompano Beach, Fla. 33060 Tel: (305) 943 2334 Pres. Roy Parsons, Sec'y Treas. Lupe Parsons
 Product: Tape—bulk erasers, splicing tape & equip
 Transcriber Co. Inc., PO Box 478, Attleboro, Mass 02703 Tel: (617) 222 3525 VP. John Sheasgreen, Nat'l Sales Mgr. John McDonald
 Product: Record—record care prods. record preservative (Sound Saver), turntable mats, Tape—demagnetizers (audio), bulk erasers (audio)
 U T C, see Universal Tape
 Ultra Specialty Inc., 20700 S. Belshaw Ave., Carson, Calif 90746 Tel: (213) 537 8850 Cable ULTRASPEC Telex 194566 Pres. Don Wong, Pres. UI traspec Int'l Gary Lyle
 Product: Record—carrying & storage cases, Tape—carrying & storage cases, leader & splicing tape, ultrasonic film splicer
 Universal Tape Corp. Inc., 821 E. Artesia Blvd., Carson, Calif 90746 Tel: (213) 327 3203 Pres. Edward O. Praeger
 Product: Tape—head cleaners, demagnetizers, leader & splicing tape (A/V Paragon, UTC, Universal) (M)
 Utopia Ultra-Sound, 38-40 S. First St., Newark, Ohio 43055. Tel: (614) 345 9426 Owner Robert H. Kirk Jr.; VP. Don Shannon, Gen Mgr. Robert H. Kirk Sr., Sales Mgr. Rose Shannon
 Product: Tape—head cleaners (MD)
 Videnza, see Pyramid
 Videoraser, see Sonar Radio
 Vinylweld, 2011 W. Hastings, Chicago, Ill 60608 Tel: (312) 243 0606
 Product: Record & Tape—carrying & storage cases
 Visual Displays Corp., see Stak It
 Vulcan Binder & Cover (div. of EBSCO Inds. Inc.), PO Box 29, Vincent, Ala 35178 Tel: (205) 672-2241. VP. R. Oenson Parker, Sales Mgr. John R. Boieslawski; Adv. Mgr. B.R. Cummings
 Product: Tape—carrying & storage cases. (M)
 W R E, see Wide Range Electronics
 Walco-Linck Corp., 1234 Hwy. 46, Clifton, N.J. 07015. Tel: (201) 471 1070
 Product: Record—replacement styli (M)
 Watts, see Empire
 Wide Range Electronics Corp., 2119 Schuetz Rd., St. Louis, Mo 63141. Tel: (314) 567 5366
 Product: Tape—bulk erasers, magnetic erasing pencil (WRE)
 Xedit Corp., 133 S. Terrace Ave., Mount Vernon, N.Y. 10550. Tel: (914) 668 0388 Pres. Claude Karczmer, Sales Mgr. Daniel Brielstein
 Product: Tape—splicing & editing equip (Edritail)
 Zerostat, see Oiscwasher



When you need to fill a position, you'll have a qualified graduate that you helped educate.

GIVE TO THE UNITED NEGRO COLLEGE FUND. A MIND IS A TERRIBLE THING TO WASTE.

Photographer: Dwight Carter
 A Public Service of This Magazine & The Advertising Council
 © 1981 United Negro College Fund, Inc.



One of the most popular groups in the recording industry.



A full line of record care products.

At Sound Guard we offer the audio and record retailer a money-making line of professional-quality products. Our products clean, preserve, protect and enhance your customers' records. With Sound Guard it's a snap to stimulate those valuable "extra" sales. Because, at today's record prices, consumers want to protect their investments.

It's easy to spot our popular group.

At Sound Guard we've created new colorful eye-catching packaging that's a handsome addition to your store. Our point-of-purchase displays grab the impulse buyer; our literature helps make the sale; our quality gets the repeat sales. And we'll also be winning consumers over with our new national advertising program. In addition to a strong campaign in the audio books we'll be advertising in such magazines as *Oui*, *Rolling Stone*, *GQ*, *Esquire*, *Popular Electronics* and *Scientific American*.

You'll be seeing more of us soon.

Because, in addition to our quality line of record care products, we're improving and expanding. This year we introduced a vastly superior anti-static preservative, and we'll soon be announcing several new products.

The stage is set for profits.

We have all the top performers: Sound Guard Record Preservative, Cleaner, Work Pad, Stylus Care Kit, and Total Record Care System. All you have to do is stock them, spotlight them, and start ringing up sales.



Sound Guard Corporation
348 S.W. 13th Avenue
Pompano Beach, Fla. 33060
(800) 327-1144
In Florida: (305) 782-1041

Facilities: Cincinnati, Ohio; Tokyo, Japan; Brussels, Belgium.

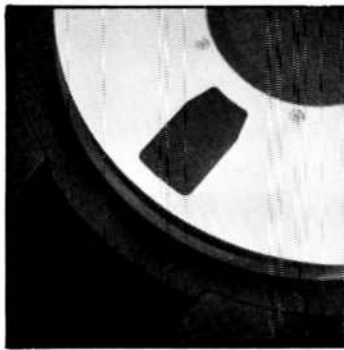

INTERNATIONAL AUDIO VIDEO TAPE DIRECTORY

BLANK LOADED TAPE & ACCESSORIES WHOLESALE

The following is a listing of Wholesalers and Independent Distributors of blank tape and record and tape accessories. The lines listed are not necessarily full lines, and the wholesalers and distributors are not necessarily limited to those lines only.

ARIZONA

● PHOENIX (Area Code 602)

All Label Rec. Serv., 3304 N. 27 Ave. Zip 85017 Tel: 258-1542
Lines: Memorex, Tracs.
Alta Dist'g Co. (Southwest div. of Aldisco Inc.) 2950 W. Catalina Or. Zip 85017 Tel: 269-1411 Pres: George Souvall, VP & Gen. Mgr. Lee Weimar, One Stop & Oist'n Mgr. Rita Pow-ll, Tape & Accessories Buyer Fred Rivers.
Branch: Salt Lake City, Utah
Lines: Allsop, Ampex, Atari, Audic, Magnetics, Certron, Discwasher, Dynascund, Fidelitone, Le-Bo, Maxell, Memorex, Moonshadows, Recoton, Savoy, Scotch, Sound Saver, TOK, Tracs
Terr.: Ariz.; Southern Calif.; Nev.; N.M.; Western Tex
Associated Oists Inc., 3803 N. 36 Ave. Zip 85019 Tel: 278-5584. Pres: Leonard M. Singer; Sales Mgr. Gus Figueroa
Lines: Ampex, BASF, Discwasher, Le-Bo, TOK, Walco
Terr.: Southwestern USA
Pickwick Int'l Inc., 3118 W. Thomas Rd. Zip 85017 Tel: 272-9343
Home office: Minneapolis, Minn

ARKANSAS

● WEST MEMPHIS (Area Code 501)

Mr. T's Recs., 901 E. Broadway Zip 72301 Tel: 735-8917
Home office: Memphis, Tenn.; Boss Ugly Bob Recs

CALIFORNIA

● BUENA PARK (Area Code 714)

Brown Rec. Oists., 7342 Melrose St. Zip 90621 Tel: 522-8551. LA (213) 921-0811 Pres: David Mings, Sales Mgr., David Guccione
Lines: AOC, Ampex, Audio Magnetics, Audio Technica, Discwasher, Glory, Le-Bo, Marsand, Maxell, Memorex, Planstehl, Pickering, Port-A-Tune, Scotch, Shure, Sound Guard, Stanton, TDK, Walts
Terr.: Alaska, Ariz., Calif., Colo., Hawaii, Idaho, Nev., N.M., Ore., Utah, Wash., Wyo., exports to Asia & Europe

● LOS ANGELES METROPOLITAN AREA (Area Code 213)

Cal-Mex Int'l One Stop, 4819 E. Whittier Blvd. Zip 90022 Tel: 261-6723
Lines: BASF, Le-Bo, Planitone, Scotch, Sound Pro, Walts, Mel Mac Garmisa Sales, 10457 Lindbrook Dr. Zip 90024 Tel: 475-8884 Owner: Robert M. Garmisa
Lines: Arista, Audio Magnetics, Le-Bo
Terr.: Ariz., Calif., Nev.

Music Brokers, 2576 W. Pico Blvd. Zip 90006 Tel: 386-4937
Lines: AVM, Gopher, Memorex, Paramount

Pickwick Int'l Inc., 7100 Tujunga Ave., North Hollywood 91605 Tel: 764-5050.
Home office: Minneapolis, Minn

Sound/Video Unlimited, 6912 Tujunga Ave., North Hollywood 91605 Tel: (213) 985-7602. Branch Mgr. Bruce Reiman
Home office: Niles (Chicago Metropolitan Area), Ill., Sound Unlimited Inc.

Lines: Fuji, Maxell, Memorex, Nortronics, Sony, TDK, Total Video
Terr.: Western USA

● SACRAMENTO AREA (Area Code 916)

A M Custom Tape Servs., 6420 Fair Oaks Blvd., No. 210, Carmichael 95608 Tel: 485-3701
Terr.: Ariz., Calif., Idaho, Nev., Ore., Wash

● SAN FRANCISCO & BAY AREA (Area Code 415)

Major Oists Inc., 4189 First St., Livermore 94550. Tel: 455-6868 Pres: Robert Anderson; Branch Mgr. Don Thurman
Home office: Tukwila (Seattle Area), Wash
Lines: BASF, Le-Bo, Memorex, 3M, Transcriber
Terr.: Calif

The Music People Inc., 1025 W. MacArthur Blvd., Oakland 94608 Tel: 653-5811 Pres: Elliot Blaine, VP/Mgr.; Jason Blaine
Lines: Le-Bo, Maxell, Memorex, Recoton, TOK

Pickwick Int'l Inc., 11 Guttard Rd., Burlingame 94010 Tel: 697-6800
Home office: Minneapolis, Minn

Promark Assocs., PO Box 6246, Hayward 94540 Tel: 785-0422
Lines: Plattner Matter, Supex

Western Rec. Sales, 5021 Seaport Ave., Richmond 94804 Tel: 235-8840 Pres.: Vern Cupples
Lines: Discwasher, Le-Bo, Marsand, Recoton, Savoy, Sony, Sound Guard, TOK, Tempo

Terr.: Ariz., Calif., Nev.; Ore., Wash

● SAN LUIS OBISPO (Area Code 805)

Square Deal Rec. Co., 169 Prado Rd. Zip 93406 Tel: 543-3636 Pres: Richard W. Ferris
Lines: BASF, Becht, Maxell, Planstehl, Scotch, TOK, Transcriber
Terr.: Western USA

Lines: BASF, Becht, Maxell, Planstehl, Scotch, TOK, Transcriber
Terr.: Western USA

COLORADO

● DENVER AREA (Area Code 303)

C.M.O. Sales Co. 4085 E. Mississippi Ave., Rm. E Zip 80222 Tel: 692-9665 Pres: Ron Staggs
Lines: Discwasher, Savoy, Sound Saver, TOK, Tracs
Terr.: Colo., Kan., Neb., Northeast N.M., Okla., Panhandle, Wyo

O.L.M. Music Inc., 4990 N. 30th St. Zip 80239 Tel: 371-3260 Pres: Darrel Nielson, Gen. Mgr. Mel Nimon
Lines: Discwasher, Le-Bo, Maxell, Memorex, Scotch, TOK, Walts
Terr.: Colo., Idaho, Mont., N.M., Utah, Wyo

Little House, 602 S. Emerson Zip 80209 Tel: 778-7258
Lines: Audiosource, Decca, SAEC
Mile Hi One Stop Inc., 150 Rio Grande Blvd. Zip 80223, Tel: 629-1960
Colo. WATS (800) 525-6094, Branch Mgr. Bob Jacobs, Accessory Salesman & Buyer: John Bicos; Video Sales: Mike Kelley
Home office: Skokie (Chicago Metropolitan Area), Ill., Sound Unlimited Inc.

Lines: Allsop, Amaray, Discwasher, Dynasound, Hagerstown, Le-Bo, Marsand, Maxell, Memorex, Planstehl, Savoy, Sony, Sound Guard, TOK, Total Video, Walts
Terr.: Alaska, Ariz., Ark., Calif., Colo., Idaho, Iowa, Kan., Mont.; Nev., N.M., N.D., Okla., Ore., Tex., Utah, Wash., Wyo

Pickwick Int'l Inc., 11720 E. 49 Ave. Zip 80239 Tel: 371-0900
Home office: Minneapolis, Minn

Lines: Allsop, Amaray, Discwasher, Dynasound, Hagerstown, Le-Bo, Marsand, Maxell, Memorex, Planstehl, Savoy, Sony, Sound Guard, TOK, Total Video, Walts
Terr.: Alaska, Ariz., Ark., Calif., Colo., Idaho, Iowa, Kan., Mont.; Nev., N.M., N.D., Okla., Ore., Tex., Utah, Wash., Wyo

Pickwick Int'l Inc., 11720 E. 49 Ave. Zip 80239 Tel: 371-0900
Home office: Minneapolis, Minn

Lines: Ampex, Audio Magnetics, EV Game, Savoy, TOK
Terr.: Ala., Fla., Ga.; Miss., N.C., S.C., Tenn.

● CLARKESVILLE (Area Code 404)
Clarkesville Rec. Sales Co. Inc., PO Box 198, 608 N. Washington St. Zip 30523 Tel: 754-2152. Sales Mgr.: Peter J. Rosetty; Mgr.: James Stockton
Lines: Ampex, Audio Magnetics, Bokor-Merzon, Capitol, Le-Bo, Sony, TOK
Terr.: Ala., Fla., Ga.; N.C., S.C.

Lines: Ampex, Audio Magnetics, Fidelitone, Le-Bo, Savoy, TOK, Tracs
Terr.: Ala., Ga., N.C., S.C., Tenn.
Trac Rec. Inc., 2070-G Boston Or. Zip 30337 Tel: 997-2263; Out-of-state WATS (800) 241-3090. Pres.: Owen L. McRee; Sales/Buyer: Walt Lumpkin
Lines: Ampro, Audio Magnetics, EV Game, Savoy, TOK
Terr.: Ala., Fla., Ga.; Miss., N.C., S.C., Tenn.

● CLARKESVILLE (Area Code 404)
Clarkesville Rec. Sales Co. Inc., PO Box 198, 608 N. Washington St. Zip 30523 Tel: 754-2152. Sales Mgr.: Peter J. Rosetty; Mgr.: James Stockton
Lines: Ampex, Audio Magnetics, Bokor-Merzon, Capitol, Le-Bo, Sony, TOK
Terr.: Ala., Fla., Ga.; N.C., S.C.

Lines: Ampex, Audio Magnetics, Bokor-Merzon, Capitol, Le-Bo, Sony, TOK
Terr.: Ala., Fla., Ga.; N.C., S.C.

Lines: Ampex, Audio Magnetics, Bokor-Merzon, Capitol, Le-Bo, Sony, TOK
Terr.: Ala., Fla., Ga.; N.C., S.C.

Lines: Ampex, Audio Magnetics, Bokor-Merzon, Capitol, Le-Bo, Sony, TOK
Terr.: Ala., Fla., Ga.; N.C., S.C.

Lines: Ampex, Audio Magnetics, Bokor-Merzon, Capitol, Le-Bo, Sony, TOK
Terr.: Ala., Fla., Ga.; N.C., S.C.

Lines: Ampex, Audio Magnetics, Bokor-Merzon, Capitol, Le-Bo, Sony, TOK
Terr.: Ala., Fla., Ga.; N.C., S.C.

Lines: Ampex, Audio Magnetics, Bokor-Merzon, Capitol, Le-Bo, Sony, TOK
Terr.: Ala., Fla., Ga.; N.C., S.C.

Lines: Ampex, Audio Magnetics, Bokor-Merzon, Capitol, Le-Bo, Sony, TOK
Terr.: Ala., Fla., Ga.; N.C., S.C.

Lines: Ampex, Audio Magnetics, Bokor-Merzon, Capitol, Le-Bo, Sony, TOK
Terr.: Ala., Fla., Ga.; N.C., S.C.

Lines: Ampex, Audio Magnetics, Bokor-Merzon, Capitol, Le-Bo, Sony, TOK
Terr.: Ala., Fla., Ga.; N.C., S.C.

Lines: Ampex, Audio Magnetics, Bokor-Merzon, Capitol, Le-Bo, Sony, TOK
Terr.: Ala., Fla., Ga.; N.C., S.C.

Lines: Ampex, Audio Magnetics, Bokor-Merzon, Capitol, Le-Bo, Sony, TOK
Terr.: Ala., Fla., Ga.; N.C., S.C.

Lines: Ampex, Audio Magnetics, Bokor-Merzon, Capitol, Le-Bo, Sony, TOK
Terr.: Ala., Fla., Ga.; N.C., S.C.

Lines: Ampex, Audio Magnetics, Bokor-Merzon, Capitol, Le-Bo, Sony, TOK
Terr.: Ala., Fla., Ga.; N.C., S.C.

Lines: Ampex, Audio Magnetics, Bokor-Merzon, Capitol, Le-Bo, Sony, TOK
Terr.: Ala., Fla., Ga.; N.C., S.C.

Lines: Ampex, Audio Magnetics, Bokor-Merzon, Capitol, Le-Bo, Sony, TOK
Terr.: Ala., Fla., Ga.; N.C., S.C.

Lines: Ampex, Audio Magnetics, Bokor-Merzon, Capitol, Le-Bo, Sony, TOK
Terr.: Ala., Fla., Ga.; N.C., S.C.

Lines: Ampex, Audio Magnetics, Bokor-Merzon, Capitol, Le-Bo, Sony, TOK
Terr.: Ala., Fla., Ga.; N.C., S.C.

Lines: Ampex, Audio Magnetics, Bokor-Merzon, Capitol, Le-Bo, Sony, TOK
Terr.: Ala., Fla., Ga.; N.C., S.C.

Lines: Ampex, Audio Magnetics, Bokor-Merzon, Capitol, Le-Bo, Sony, TOK
Terr.: Ala., Fla., Ga.; N.C., S.C.

Lines: Ampex, Audio Magnetics, Bokor-Merzon, Capitol, Le-Bo, Sony, TOK
Terr.: Ala., Fla., Ga.; N.C., S.C.

Home office: Miami, Fla.; MJS Entertainment of Florida
Lines: Le-Bo, Maxell, Memorex, Savoy, TOK
Terr.: Ala.; Ark.; Ga.; Ky.; La.; Miss.; N.C.; S.C.; Tenn.; Va

One Stop Rec. House Inc., 1872 Marietta Blvd. NW. Zip 30318. Tel: 351-9140. Ga. WATS (800) 282-7956. SE WATS (800) 241-0318. Pres.: S.R. Freeman; Sales Mgr.: Jack McIntyre
Lines: Oustbuster, Le-Bo, Memorex, Planstehl, Savoy, Tracs
Terr.: Ala.; Fla.; Ga.; Ky.; Miss.; N.C.; S.C.; Tenn.; Va

Pickwick Int'l Inc., 365 Patton Dr. Zip: 30336. Tel: 696-1850. Branch Mgr.: Dennis Hoelzer
Home office: Minneapolis, Minn
Lines: Data Pkg., Maxell, Memorex, Pickwick, Plasti-Plex, Scotch, Tracs
Terr.: Ala.; Fla.; Ga.; Ky.; Miss.; N.C.; S.C.; Tenn.

Record Oists Inc., 6427 Warren Dr., Norcross 30093. Tel: 449-6085. Pres.: Gene Donley; Sales Mgr.: Bob Newell; Controller: Marian Runger
Lines: Intermagnetics, Maxell, Savoy, Sound Guard
Terr.: Eastern USA

Tara Rec. & Tape Dist. Co. Inc., 582 Armour Circle NE. Zip: 30324. Tel: 875-8272. Pres.: Gwen M. Kester; Sales Mgr.: Jamie Miller; Mgr.: Joe Terribonne
Lines: Ampex, Audio Magnetics, Fidelitone, Le-Bo, Savoy, TOK, Tracs
Terr.: Ala., Ga., N.C., S.C., Tenn.

Trac Rec. Inc., 2070-G Boston Or. Zip 30337 Tel: 997-2263; Out-of-state WATS (800) 241-3090. Pres.: Owen L. McRee; Sales/Buyer: Walt Lumpkin
Lines: Ampro, Audio Magnetics, EV Game, Savoy, TOK
Terr.: Ala., Fla., Ga.; Miss., N.C., S.C., Tenn.

Lines: Ampro, Audio Magnetics, EV Game, Savoy, TOK
Terr.: Ala., Fla., Ga.; Miss., N.C., S.C., Tenn.

Lines: Ampro, Audio Magnetics, EV Game, Savoy, TOK
Terr.: Ala., Fla., Ga.; Miss., N.C., S.C., Tenn.

Lines: Ampro, Audio Magnetics, EV Game, Savoy, TOK
Terr.: Ala., Fla., Ga.; Miss., N.C., S.C., Tenn.

Lines: Ampro, Audio Magnetics, EV Game, Savoy, TOK
Terr.: Ala., Fla., Ga.; Miss., N.C., S.C., Tenn.

Lines: Ampro, Audio Magnetics, EV Game, Savoy, TOK
Terr.: Ala., Fla., Ga.; Miss., N.C., S.C., Tenn.

Lines: Ampro, Audio Magnetics, EV Game, Savoy, TOK
Terr.: Ala., Fla., Ga.; Miss., N.C., S.C., Tenn.

Lines: Ampro, Audio Magnetics, EV Game, Savoy, TOK
Terr.: Ala., Fla., Ga.; Miss., N.C., S.C., Tenn.

Lines: Ampro, Audio Magnetics, EV Game, Savoy, TOK
Terr.: Ala., Fla., Ga.; Miss., N.C., S.C., Tenn.

Lines: Ampro, Audio Magnetics, EV Game, Savoy, TOK
Terr.: Ala., Fla., Ga.; Miss., N.C., S.C., Tenn.

Lines: Ampro, Audio Magnetics, EV Game, Savoy, TOK
Terr.: Ala., Fla., Ga.; Miss., N.C., S.C., Tenn.

Lines: Ampro, Audio Magnetics, EV Game, Savoy, TOK
Terr.: Ala., Fla., Ga.; Miss., N.C., S.C., Tenn.

Lines: Ampro, Audio Magnetics, EV Game, Savoy, TOK
Terr.: Ala., Fla., Ga.; Miss., N.C., S.C., Tenn.

Lines: Ampro, Audio Magnetics, EV Game, Savoy, TOK
Terr.: Ala., Fla., Ga.; Miss., N.C., S.C., Tenn.

Lines: Ampro, Audio Magnetics, EV Game, Savoy, TOK
Terr.: Ala., Fla., Ga.; Miss., N.C., S.C., Tenn.

Lines: Ampro, Audio Magnetics, EV Game, Savoy, TOK
Terr.: Ala., Fla., Ga.; Miss., N.C., S.C., Tenn.

Lines: Ampro, Audio Magnetics, EV Game, Savoy, TOK
Terr.: Ala., Fla., Ga.; Miss., N.C., S.C., Tenn.

Lines: Ampro, Audio Magnetics, EV Game, Savoy, TOK
Terr.: Ala., Fla., Ga.; Miss., N.C., S.C., Tenn.

Lines: Ampro, Audio Magnetics, EV Game, Savoy, TOK
Terr.: Ala., Fla., Ga.; Miss., N.C., S.C., Tenn.

Lines: Ampro, Audio Magnetics, EV Game, Savoy, TOK
Terr.: Ala., Fla., Ga.; Miss., N.C., S.C., Tenn.

Lines: Ampro, Audio Magnetics, EV Game, Savoy, TOK
Terr.: Ala., Fla., Ga.; Miss., N.C., S.C., Tenn.

Lines: Ampro, Audio Magnetics, EV Game, Savoy, TOK
Terr.: Ala., Fla., Ga.; Miss., N.C., S.C., Tenn.

Lines: Ampro, Audio Magnetics, EV Game, Savoy, TOK
Terr.: Ala., Fla., Ga.; Miss., N.C., S.C., Tenn.

Lines: Ampro, Audio Magnetics, EV Game, Savoy, TOK
Terr.: Ala., Fla., Ga.; Miss., N.C., S.C., Tenn.

Lines: Ampro, Audio Magnetics, EV Game, Savoy, TOK
Terr.: Ala., Fla., Ga.; Miss., N.C., S.C., Tenn.

Lines: Ampro, Audio Magnetics, EV Game, Savoy, TOK
Terr.: Ala., Fla., Ga.; Miss., N.C., S.C., Tenn.

Lines: Ampro, Audio Magnetics, EV Game, Savoy, TOK
Terr.: Ala., Fla., Ga.; Miss., N.C., S.C., Tenn.

Lines: Ampro, Audio Magnetics, EV Game, Savoy, TOK
Terr.: Ala., Fla., Ga.; Miss., N.C., S.C., Tenn.

Lines: Ampro, Audio Magnetics, EV Game, Savoy, TOK
Terr.: Ala., Fla., Ga.; Miss., N.C., S.C., Tenn.

Lines: Ampro, Audio Magnetics, EV Game, Savoy, TOK
Terr.: Ala., Fla., Ga.; Miss., N.C., S.C., Tenn.

Lines: Ampro, Audio Magnetics, EV Game, Savoy, TOK
Terr.: Ala., Fla., Ga.; Miss., N.C., S.C., Tenn.

Lines: Audio Technica, Discwasher, Marsand, Maxell, Memorex, Savoy, Service, Sound Guard, Sound Saver, TDK, Watts
Terr.: National

IOWA

• DES MOINES (Area Code 515)

Pickwick Int'l Inc., 2400 Sunset Rd. Zip 50321 Tel 282-8185.
Home office: Minneapolis, Minn

KANSAS

• SHAWNEE MISSION (Area Code 913)

Vanguard Systems Inc., 4210 Johnson Dr. Zip 66205 Tel 432 6520 Pres Robert L. Stutz.
Line: Studio Magnetics
Terr.: Kan.; Mo

KENTUCKY

• CAMPBELLSVILLE (Area Code 502)

Central Electronics, PO Box 340, 108 N Central Ave. Zip: 42718 Tel 465 5631 Pres.: Randall B. Herron.
Terr.: Ind., Ky., Tenn.

• OWENSBORO (Area Code 502)

Wax Works Inc., 325 E. Third St. Zip 42301. Tel 926-0008 Pres: Terry Woodward.
Lines: Ampex, Discwasher, Le Bo, Maxell, Memorex, Planstehel, Sound Guard, TDK, Watts.
Terr.: Ala.; Ill.; Ind.; Ky.; Mo; Tenn.; Va.

LOUISIANA

• NEW ORLEANS (Area Code 504)

All South Dist., 1924 Lafayette St. Zip 70113 Tel 568 0971 Pres Warren Hildebrand; Sales & Opns. Mgr. Richard Brown.
Lines: Maxell, Memorex, Recoton, Savoy, TDK
Terr.: Mobile, Ala., Fla Gulf Coast, La., Miss.

• VILLE PLATTE (Area Code 318)

Floyd's Whistle, Oist'g Co Inc., 434 E. Main St. Zip 70586. Tel: 363 2184 Owner & Pres J Floyd Soileau, Sales Mgr.: Ray LaFleur
Lines: Le-Bo, Memorex, Peerless, Planstehel, Scotch
Terr.: Central & Southern La., Western Miss.; Eastern Tex.

MAINE

• PORTLAND (Area Code 207)

Commercial Dists., 8 Somerset St. Zip 04101 Tel 775 5644 Pres Herbert S Holmes Jr., Mgr William E. Tiffany
Lines: Memorex, Recoton, Savoy, Sound Guard, Watts.
Terr.: Me.; N.H.

MARYLAND

• BALTIMORE METROPOLITAN AREA (Area Code 301)

Pickwick Int'l Inc., 7310 Ritchie Hwy., Glen Burnie 21061 Tel 760-6750
Home office: Minneapolis, Minn.
Terr.: Md., N.J., N.Y.; Va.

The Zamoski Co., 1101 Desoto Rd. Zip 21223 Tel 644 2900

Lines: Calibron, Le-Bo, Maxell, Memorex, Recoton, Service, TOK
Terr.: Washington, O.C., Md., Pa., Va

• LANHAM (Area Code 301)

Schwartz Bros Inc., 4901 Forbes Blvd. Zip 20801 Tel: 459 8000. Pres James Schwartz; Sales Mgr.: Eugene Horn; Buyer Charles Myers
Branches: Cherry Hill, N.J., Norfolk, Va., Tidewater One-Stop.
Lines: Allsop, Ampex, Audio Technica, BASF, Bowers, Dynasound, Empire, Maxell, Memorex, Pickering, Recoton, Scotch, Shure, Sony, Sound Guard, Stak-It, TDK.
Terr.: Washington, O.C.; Md.; Va.; W. Va.

MASSACHUSETTS

• BOSTON METROPOLITAN AREA (Area Code 617)

Royal Dists., 92 Sagamore St., North Quincy 02171 Tel 328 1822. Owner Aaron Gross.
Lines: Maxell, Recoton
Terr.: New England.

• LAWRENCE (Area Code 617)

Nert of New England, PO Box 268, 641 Haverhill St. Zip 01842. Tel 686 4293 Pres Jerry P. Marcus, Sales Mgr. Melvin L. Marcus.
Lines: Ampex, Audio-Technica, BASF, Discwasher, Empire, Maxell, Memorex, Recoton, Savoy, Scotch, Shure, Sony, Sound Guard, TOK, Watts
Terr.: Africa, Asia, Europe, USA

• SOMERSET (Area Code 617)

Pickwick Int'l Inc., 185 Riverside Ave. Zip: 02725 Tel: 676 3061
Home office: Minneapolis, Minn.

MICHIGAN

• DETROIT METROPOLITAN AREA (Area Code 313)

Ami Dist Corp., 34411 Industrial Rd., Livonia 48150 Tel 525 7600. Pres Harry Manoogian; Mgr. Carl Mooradian.
Lines: Audio Magnetics, Fuji, Memorex, Panasonic, Sony, TDK, Toshiba
Terr.: Mich., Ohio

Angott Rec. & Tape Sales, 2616 Puritan. Zip. 48238 Tel: 341 7053 Partner Ken Walker

Lines: Le-Bo, Maxell, Memorex, TDK

Cadet Dist Co Inc., 13380 Capital, Oak Park 48237. Tel 548 3171 Pres Harry Levin

Lines: Intermagnetics, Memorex, Recoton.

Terr.: National

Music Peddlers Inc., 1755 E Maple Rd., Troy 48084 Tel. 524 2800. Pres Carl Thom, Gen Mgr. Jerry Adams

Lines: Allsop, Audio Magnetics, DMI, Discwasher, Fuji, Maxell, Memorex, Nortronics, Planstehel, Pusher, Savoy, Service, Sony, TDK

Terr.: Metropolitan Detroit, Mich. Outstate Mich

Radio Frank Inc., 15250 Mercantile Dr., Dearborn 48121 Tel 336 2900

Simpson's Inc., 845 Livernois Ave., Ferndale 48220 Tel 544 9252 Pres Calvin Simpson Jr., Branch Mgr. Alice Rayford

Lines: BASF, GRT, Le-Bo, Memorex, Planstehel, Recoton, TDK

Terr.: Flint, Saginaw, Mich., Toledo, Youngstown, Ohio

Video Trend Inc., 24611 Crestview Court Zip 48018 Tel 474 0300 Pres Eugene L. Silverman; Sales Mgr.: Jeffrey N. Freedman.

MAY 23, 1981 BILLBOARD

WHY NOT DEAL WITH THE BEST?

BEST SELECTION - BEST SERVICE - BEST FILL

FUJI
CASSETTES



maxell
THE
OBVIOUS CHOICE
FOR
CHOICE RESULTS



Sony Tape.



Full Color Sound.

SCOTCH
RECORDING TAPE.



THE TRUTH
COMES OUT.

Full Lifetime Warranty
TDK



24-HOUR FREIGHT-PAID SERVICE

A. I. Rosenthal Associates, INC.

TOLL-FREE ORDERING CALL (800)523-2472 (PA call collect)

SEND FOR FREE CATALOG
(dealers only)

Dept. A, 1035 Louis Dr., Warminster, PA 18974 (215)441-8900

AMPEX • AUDIO TECHNICA • DISCWASHER • DURACELL • DYNASOUND • EVEREADY •
FUJI • MAXELL • MEMOREX • PICKERING • RECOTON • SAVOY •
SCOTCH • SHAPE • SHURE • SONY • SOUND GUARD • TDK • TRACS • WATTS

Lines: Alltop, Le-Bo, Maxell, Nortronics, Savoy, Sony, TDK.
Terr.: Dist.—Mich & Ohio, One Stop—National

- **FLINT (Area Code 313)**

Audio Video Prod'ns, 3213 Salsban Circle, Zip 48506. Tel: 233-4003.

- **KALAMAZOO (Area Code 616)**

Vinyl Vendors Inc., 7870 Sprinkle Rd, Zip 49002. Tel: 323-0131. Pres. Jeff D. Boyd, Sales Mgr. Teri A. Broese
Lines: Alltop, Bokor/Merzon, Discwasher, Le-Bo, Maxell, Planstiehl, Port-A-Tune, Savoy, Service, TDK, Vac-D Rec, Watts.
Terr.: Ind., Mich., Ohio

- **OWOSSO (Area Code 313)**

Rock-A-Rolla Recs. Inc., 200 W Main St, Zip 48867. Tel: 767-5891. Pres. Edwin T. Dews, Sales Mgr. Thomas E. Dews
Lines: Audio Groome, Audio Technica, BASF, Discwasher, EV Game, Holly wood Pro, Le-Bo, Maxell, Memorex, Plantone, Port-A-Tune, Savoy, Service, Sony, Sound Guard, TDK, Watts
Terr.: Mich. counties: Genesee, Saginaw, Shiawassee

MINNESOTA

- **MINNEAPOLIS-ST. PAUL AREA (Area Code 612)**

Pickwick Int'l Inc., 7500 Excelsior Blvd., Minneapolis 55426. Tel: 932-7548
Local branch: 7600 Wayzata Blvd, Zip 55426. Tel: (612) 932-7600
Branches: Phoenix, Ariz., Burlingame (San Francisco & Bay Area), North Hollywood (Los Angeles Metropolitan Area), Calif.; Denver, Colo., Dpa Locka (Miami Metropolitan Area), Fla., Atlanta, Ga.; Honolulu, Hawaii; Elk Grove Village (Chicago Metropolitan Area), Ill.; Des Moines, Iowa; Glen Burnie (Baltimore Metropolitan Area), Md.; Somerset, Mass.; Arlington (Fort Worth Area), Tex.; Seattle, Wash.

MISSISSIPPI

- **JACKSON (Area Code 601)**

Bennett Rec. Dist., 3109 Delta Dr, Zip 39213. Tel: 981-4328
Lines: Capitol, Finetone.

MISSOURI

- **KANSAS CITY (Area Code 816)**

The House Dist., PO Box 5935, Zip 64111. Tel: 561-2744. Pres. Harold Brody, Sales Mgr.: Kevin Papuga
Line: Planstiehl.

- **ST. LOUIS (Area Code 314)**

P B One Stop, 1919-21 Washington St, Zip 63103. Tel: 231-2074. Pres. Patrick J. Blunda, Mgrs.: Perry F. Blunda, John Gavin
Lines: High Performance, Le-Bo, Memorex, Planstiehl, Scotch, TDK, Tracs
Terr.: Ark., Ill., Ind., Iowa, Kan., Ky., Miss., Mo., Neb., Okla., Tenn., Wis
Record Wide Dist., Inc., 1755 Chase Dr., Fenton 63026. Tel: 343-7100, WATS (800) 325-9690. TWX (910) 760-1301. VP Sales & Mktg. Kermit R. Howard

MONTANA

- **GREAT FALLS (Area Code 406)**

Holm James Dist., Inc., Box 2487, 320 Sixth St. S., Zip: 59405. Tel: 761-2420. Pres. Richard E. Holm, Mgr. Jeffrey E. Holm.
Lines: Fidelitone, Le-Bo, Robins, Scotch
Terr.: Mont., Northern Wyo

NEBRASKA

- **OMAHA (Area Code 402)**

Records & Tapes Inc., 3124 Harney St. Zip 68131. Tel: 344-3344. Pres. Bruce Hoberman
Lines: Alltop, Audio Technica, Discwasher, Fuji, Le-Bo, Maxell, Memorex, Nortronics, Savoy, TDK, Transcriber.
Terr.: Iowa; Southern Kan.; Neb., N.D., S.D.

NEW JERSEY

- **CHERRY HILL (Area Code 609)**

Schwartz Bros. Inc., 1101 Kings Hwy N, Zip 08002. Tel: (609) 482-2130
Home office: Lanham, Md.
Terr.: Del., N.J., Pa.

- **EAST BRUNSWICK (Area Code 201)**

P R D B Dist., 742 Hwy. 18, Zip: 08816. Tel: 257-3336.
Lines: Maxell, Memorex, Recoton, TDK.

- **HILLSIDE (Area Code 201)**

Apex/Martin Rec. Sales Inc., 467 Mundet Pl, Zip: 07205. Tel: 964-5960
Pres. Sol Gleit; Mgr. Joe Martinez
Lines: Le-Bo, Maxell, Memorex, Walco
Terr.: Northeastern USA

- **PENNSAUKEN (Area Code 609)**

Richman Bros. Inc., 6935 Airport Hwy. Ln. Zip 08109. Tel: 665-8085, Phila (215) 477-1742. Pres.: A. Richman; Mgr.: Gary Wolfe.
Lines: Discwasher, Fidelitone, Maxell, Memorex, Norelco, Planstiehl, Savoy, Sony, TDK, Tempo, Watts.
Terr.: East Coast; Parts of Midwest

- **SPRINGFIELD (Area Code 201)**

Profit Sales Dist. Co., Runyon Bldg., Rt. 22 & Fadem Rd., Zip: 07081. Tel: 379-9640
Lines: Itera, Le-Bo, Maxell, Savoy, Walco
Terr.: Continental USA

NEW MEXICO

- **ALBUQUERQUE (Area Code 505)**

Tocino Music Ent., 900 Fourth St. SW, Zip: 87102. Tel: 247-8051
Line: Recoton.

NEW YORK

- **ALBANY AREA (Area Code 518)**

Bee Gee Recs. & Tape, 10 Northway Ln N., Latham 12110. Tel: 785-1122
Pres. Lawrence Smith, Gen. Mgr. Chip Heath.
Lines: EV Game, Hartzell, Le-Bo, Maxell, Memorex, Peerless, Savoy, Scotch, Sony
Terr.: New England, N.J., N.Y.; Ohio; Pa.; W. Va.

Dne Way Recs. Inc., 12 Commercial Rd, Zip 12205. Tel: 489-3288. Pres. David H. Schlang, Sales Mgr. Gerald McCarthy
Lines: BASF, Discwasher, Le-Bo, Maxell, Memorex, Sony, TDK
Terr.: International

Trans World Music Corp., 874 Albany Shaker Rd., Latham 12110. Tel: 783-5152. Pres. Robert J. Higgins, Gen. Mgr. Frank Griffin
Lines: Alltop, BASF, Discwasher, Le-Bo, Maxell, Memorex, Planstiehl, Savoy, Sound Guard, TDK
Terr.: New England, Md., N.J., N.Y., Pa., Va

- **AMSTERDAM (Area Code 518)**

Aimor Playtime Co. Inc., 140 Guy Park Ave, Zip 12010. Tel: 843-3801. Pres. Albert A. Hyman, VP. Bruce M. Hyman, Sales Mgr. Tony Garass.
Lines: BASF, Le-Bo, Maxell, Memorex, Recoton, TDK
Terr.: Conn., Me., Mass., N.H., N.J., N.Y., Ohio, Pa., Vi

- **BUFFALO AREA (Area Code 716)**

Best & Gold Rec. Dist., 355 Harlem Rd., West Seneca 14224. Tel: 826-9560
Line: Watts.

- **FREPORT (Area Code 516)**

Candy Stripe Recs. Inc., 371 S. Main St, Zip: 11520. Tel: 379-5151, NYC (212) 895-3930, WATS (outside N.Y. State) (800) 645-3747. Chm. Bernard Keil; Pres. Stan Gecht, Sales Mgr. Michael Schlackman, Accessory Buyer Irving Glasser
Lines: Ampex, Audio Magnetics, BASF, Discwasher, Fuji, Le-Bo, Magna-tone, Maxell, Memorex, Recoton, Recoton/Black Magic, Robins, Savoy, Scotch, Sharp, Sony, Sound Guard, TDK
Terr.: National & Export

- **HOLTSVILLE (Area Code 516)**

Studio Magnetics Co. Inc., 12 Long Island Ave, Zip: 11742. Tel: (516) 289-3400.

- **ISLAND PARK (Area Code 516)**

Scott Dist'g Corp., 4217 Austin Blvd, Zip 11558. Tel: 432-1234
Branch: Norfolk, Va
Line: Scotch
Terr.: Military

- **NEW YORK METROPOLITAN AREA (Area Code 212)**

Citywide Sales (div. of Intercontinental Electronics Ltd.), 419 Park Ave. S, Zip 10016. Tel: 689-2700

Lines: ADC, Audio-Technica, Pickering, Shure
M J S Entertainment of New York Inc., 47-31 35 St., Long Island City 11101. Tel: 784-0360. Telex: 4222479

Home office: Miami, Fla.; MJS Entertainment of Florida

Dlympia Dist., 239 W. 18 St., Zip 10011. Tel: 989-7200

Line: Le-Bo.

Albert Schultz Inc., 116 W 14 St, Zip 10011. Tel: 924-1122. Cable ALBY REP. Telex: 236569. Pres. Albert Schultz, Sales Mgr. Ricardo Leon (Ex. porter—audio & video blank cassettes)
Tara Audio Sales Ltd., 1370 Ave of the Americas, Zip 10019. Tel: 581-6950
Win Recs. Inc., 45-50 38 St., Long Island City 11101. Tel: 786-7667. Pres. Sam Weiss, Sales Mgr. George Weiss
Lines: Ampex, Maxell, Memorex, Scotch, TDK
Terr.: National

- **POUGHKEEPSIE (Area Code 914)**

Toy House of Hudson Valley, Manchester Rd, Zip 12603. Tel: 471-2740
Pres. Lou J. Kustas
Lines: Hagerstown, Le-Bo, Maxell, Memorex, Recoton, Savoy
Terr.: Hudson Valley

- **ROCHESTER (Area Code 716)**

Kack Klick Dist., Inc., House of Guitars Inc. Bldg., 645 Titus Ave, Zip 14617. Tel: 544-3500. Pres. P. Armand, Mgr. Kim Simmons
Lines: House of Guitars, Machine Cleaner, Machine Tape, Memorex, Recotape, Sound Guard
Terr.: National

- **SYRACUSE (Area Code 315)**

Morris Dist'g Co., 1153 W Fayette St, Zip 13204. Tel: 475-9955

Lines: Le-Bo, Memorex, Recoton, Scotch, Watts

- **WESTBURY (Area Code 516)**

All Rec. Dist. Inc., 44 Bond St, Zip 11590. Tel: 997-7160. Pres. Michael R. Cono
Lines: Le-Bo, Maxell, TDK

- **WOODMERE (Area Code 516)**

Leonard Finkel Assocs., 574 Lehigh Ln, Zip 11598. Tel: 374-3221/3122. Pres. Leonard Finkel, Mgr. John DiLello
Lines: ADC, Ampex, Astatic, Audiotech, BASF, BSR, Bokor-Merzon, Em pire, Fuji, Le-Bo, Maxell, Memorex, Planstiehl, Pickering, Shure, Sony, Stanton, TDK
Terr.: National

NORTH CAROLINA

- **CARY (Area Code 919)**

ExSell Mktg., PO Box 884, Zip 27511. Tel: 467-8122, WATS (800) 334-2484.
Lines: ADC, Alltop, Discwasher, Maxell, Memorex, Sony, Sound Guard, Sound Saver.

- **CHARLOTTE (Area Code 704)**

Bib Dist'g Co., 101 Yorkmont Rd, Zip 28210. Tel: 527-0440
Lines: Le-Bo, Pageant.

OHIO

- **AKRON (Area Code 216)**

Twelgenn Ent's Inc., 2775 Yellow Creek Rd, Zip 44313. Tel: 836-5591. Pres. J. Hugh Macey, Mgr. Catherine E. Macey
Lines: EV Game, Electro Voice, Hagerstown, Newcomb
Terr.: Australia, Canada, Germany, Japan; USA

- **CINCINNATI (Area Code 513)**

Supreme Dist. Co. Inc., 1000 Broadway, Zip 45202. Tel: 421-0747. Sales Mgr. Al Klayman
Lines: Disney, Dustbuster, Fidelitone
Terr.: Ind.; Ky., Ohio

- **CLEVELAND METROPOLITAN AREA (Area Code 216)**

Action Music Sales Inc., 6541 Eastland Rd, Zip 44142. Tel: 243-0300. Pres. Len Silver, VP. Dennis Baker
Lines: Maxell, Memorex, Scotch, Sound Guard, TDK, Tracs

Terr.: Northern Ky., Mich., Western N.Y.; Ohio, Western Pa., North western W. Va

Man In The Middle, 5923 Cantwell Dr., Mayfield Heights 44124. Tel: 461-3342. Pres. Sherman Lieberman

Lines: Fidelitone, Pyramid, Savoy, Vid Lid, Video Commander, Video Organizer
Terr.: Ohio, Western Pa

OKLAHOMA

- **TULSA (Area Code 918)**

Oklahoma News Co., 909 W 23 St, Zip 74107. Tel: 584-4754

Lines: Le-Bo, Memorex, Tracs
Terr.: Western Ark., Eastern Okla

PENNSYLVANIA

- **PHILADELPHIA METROPOLITAN AREA (Area Code 215)**

A. I. Rosenthal Assocs. Inc., 1035 Louis Dr., Warmunster 18974. Tel: 441-8900. Pres. Alfred Rosenthal, Sales Mgr.: Hugh Boyle
Lines: Add-N-Stac, Alltop, Amaray, Ampex, Audio-Technica, Bib, Bowers, Discwasher, Dynasound, Maxell, Memorex, Pickering, Recoton, Savoy, Scotch, Shape, Shure, Sony, Sound Guard, TDK, Tracs, Watts
Terr.: National & Export

Universal Rec. Dist'g Corp., 919 N. Broad St, Zip 19123. Tel: 232-3333
Line: Le-Bo

Villanueva Asturias Corp., 401 W Girard Ave, Zip 19123. Tel: 236-4544

Lines: EV Game, Electro Voice, VAC

Vintage Recs. Inc., PO Box 251, Darby 19023. Tel: 586-5200. Pres. Murray Graber.
Lines: Audio Magnetics, EV Game, Hartzell, Memorex, Rvvertone, Savoy.
Terr.: Worldwide

PUERTO RICO

- **SAN JUAN (Area Code 809)**

Caribe Audio Dist., Inc., Condado St., No. 70, Zip 00907. Tel: 722-0219
Pres. Fernando Gallardo, Mgr. Jose A. Benitez
Lines: Audio Technica, Discwasher, Fidelitone, Maxell, Shure, Stanton
Terr.: Puerto Rico, US Virgin Islands

SOUTH CAROLINA

- **GREENVILLE (Area Code 803)**

Custom Rec'g & Sound Inc., 1225 Pendleton St., Zip 29610. Tel: 269-5018

Pres. Robert W. Edwards, Sales Mgr.: Jere Davis

Lines: Ampex, Scotch, Studio Magnetics

Terr.: Ga., N.C., S.C.

TENNESSEE

- **KNOXVILLE (Area Code 615)**

A & R Dist. Co., 1301 Prosser Rd, Zip 37914. Tel: 546-7881. Dwner & Pres. Tommy Ayres, Mgr. & Buyer Albert W. Smith
Lines: Ampex, BASF, Custom Case, Le-Bo, Planstiehl
Terr.: Ala., Ga., N.C., Ohio, S.C., Tenn.; Va.; W. Va.

Knox Rec. Rack Co., PO Box 11167, 1539 Amherst Rd, Zip: 37919. Tel: 584-8531
Lines: Custom, Memorex, Recoton, Savoy, TDK
Terr.: Southeastern USA

- **MEMPHIS (Area Code 901)**

Boss Ugly Bob Recs (BC Ents of Memphis Inc.), 726 E. McLemore Zip 38106. Tel: 947-2553, 774-6400. Pres. Robert L. Catron Jr., Sales Mgr. R. Karriem
Branch: West Memphis, Ark., Mr. T's Recs
Lines: Duotone, Fidelitone, Le-Bo, Maxell, Memorex, Savoy, Shure
Terr.: Ark., Southern Ill., Miss., Mo.; Tenn

Hot Line Rec. Dist. Inc., 421 S. Main St, Zip: 38103. Tel: 525-0756

Lines: Capitol, Fidelitone, Gemco, Le-Bo, Memorex

Select D Hits Inc., 605 Chelsea Ave, Zip 38107. Tel: 523-1190. Pres. Sam W. Phillips, Mgr. John Phillips

Lines: Advent, Audio Magnetics, BASF, Custom Case, EV Game, Fidelitone, Fuji, Robins Tracs

Terr.: Ala., Ark., Fla., Ga., Ind., Ky., La., Miss., Mo., Okla., Tenn., Tex

- **NASHVILLE (Area Code 615)**

Music City Rec. Dist. Inc., 25 Lincoln St, Zip 37212. Tel: 255-7315. Pres. E. Hutch Carlock, Sales Mgr. Mike Wise.

Lines: Discwasher, Empire, Fidelitone, Hagerstown, Maxell, Memorex, Peerless, Savoy, Sound Guard, TDK, Tempo, Tracs, Watts

Terr.: Ala.; Ark., Ga., Ill., Ind., Ky., Miss., N.C., S.C., Tenn., Va., W. Va.

TEXAS

- **DALLAS (Area Code 214)**

Big State Dist'g Corp., 4830 Lakawana, Suite 121, Zip 75247. Tel: 631-1100
Lines: Le-Bo, Maxell, Memorex, Recoton, Savoy, Scotch, Sony, Sound Guard
Terr.: Okla., Tex

- **FORT WORTH AREA (Area Code 817)**

Pickwick Int'l Inc., 2200 E. Randal Mill Rd., Arlington 76011. Tel: 261-4281

Home office: Minneapolis, Minn

- **HOUSTON (Area Code 713)**

H W Daily Inc., 3409 Brinkman, Zip 77018. Tel: 861-9251. Pres. Donald M. Daily, Mgr. David Bennett

Lines: Bokor Merzon, Le-Bo, Marsand, Maxell, Memorex, Planstiehl, Plantone, Pusher, Scotch, Sound Guard, TDK

Terr.: Tex

Southwest Whistle Recs & Tapes, 8566 Katy Fwy., Suite 123, Zip 77024. Tel: 464-6507

Home office: San Antonio, Tex.; South Texas Whistle Recs & Tapes Inc.

Lines: Le-Bo, Maxell, Memorex

Terr.: Texas

- **SAN ANTONIO (Area Code 512)**

South Texas Whistle Recs & Tapes Inc., 724 Lexington, Zip 78212. Tel: 224-0754. Pres. Richard W. Powers, Sales Mgr. Robert Guilerman

Branch: Houston, Tex., Southwest Whistle Recs & Tapes

Lines: Audio Magnetics, Le-Bo, Maxell, Memorex, Pickwick

Terr.: Southwestern USA

(Continued on page 32)

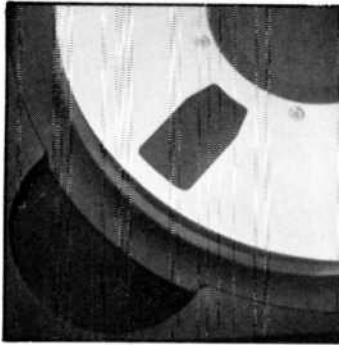

INTERNATIONAL AUDIO VIDEO TAPE DIRECTORY

STORE FIXTURES MANUFACTURERS & IMPORTERS

The key to the abbreviations following the company listings is: (M) Manufacturer, (D) Distributor, (I) Importer.

A-Elec Synchronic Inc., 230 Fifth Ave., New York, N.Y. 10001. Tel (212) 684-7150
Product: Record & tape display racks (M)
 Acrylic Design & Fabrication Co., 1147 W. Dhuo, Chicago, Ill. 60622 T-1 (312) 226-1222
Product: Record & tape (audio & video) display racks, point-of-purchase displays
 George Alexander Group Inc., 1063 Post Rd., Darien, Conn. 06820 T-1 (203) 655-7791
Product: Record & tape browser boxes, record & tape display racks, record & tape divider cards
 Art Phyl Creations, 162 50 NW 48 Ave., North Miami, Fla. 33127 Pres. Art Hochman, Adv. Mgr. Lori Sidlar
Product: Record & tape (audio) browser boxes, record & tape (audio) display racks (M)
 G Binson & Co. Printers Inc., 75 Spring St., New York, N.Y. 10012 Tel (212) 925-7100. Contact: Gerald J. Benson
Product: Record & tape divider cards
 Tec. Bushman Signs, 627 Broadway, Massapequa, N.Y. 11758 Tel (516) 798-8590. Owner: Ted Bushman
Product: Record & tape divider cards & signs (M)
 Carter Corp., 1916 11 St., Rockford, Ill. 61108 Tel (815) 397-3200 Pres. Robert L. Fleming, VP Sales & Mktg. Sandra L. Fleming, Plant Mgr. W. Kirk Kruger
Product: Record display racks (Carter-Craft) (M)
 Cortainer Kraft Inc., 831 De Celis Pl., Sepulveda, Calif. 91343, Tel (213) 893-9721
Product: Record & tape browser boxes, record & tape display racks
 Continental Forest Inds., Bleached System Dpns., Office Park II, Greenwich, Conn. 06831, Tel (203) 661-2233. TWX (710) 579-2912 VP John F. Curtin
Product: Security systems (Conver-safe Drange anti-counterfeiting paperboard product)
 Conversafe Drange, see Continental Forest Inds.
 Creative Store Equip. Inc., PC Box 933, Terrell, Tex. 75160, Tel (214) 563-5869 Pres. Jerry G. White, Gen. Mgr. John Bowen
Product: Record & tape display racks, tape security systems
 Crow Prods., 700 Shore Rd., No. 5-D, Long Beach, N.Y. 11561 Tel (516) 584-0244. Pres. Gary Leider (Point of Purchase Displays)
 Cuskom Case Mfg. Co., 6232 Bragg Blvd., Fayetteville, N.C. 28303 Tel (919) 867-4196 Pres. Al Metzger, Nat'l Sales Mgr. Judy Harris
Product: Record & tape divider cards (M)
 Dayton Corp., 1 Park St., Amsterdam, N.Y. 12010 Tel (518) 842-4800
Product: Record browser boxes, record & tape display racks (Monark) (M)
 Design Fabrications Inc., 1215 Wheaton St., Troy, Mich. 48084 Tel (313) 589-8206
Product: Record & tape display racks (custom) (M)
 Dielectrics Inc., 400 Burnett Rd., Chicopee, Mass. 01020 Tel (413) 598-2318
Product: Record & tape divider cards (custom fabrication)
 Directfree, see Hick Wagner
 Discover Division Inc., 5888 W. 76 St., Minneapolis, Minn. 55435 Tel (612) 831-5538 Pres. Paul W. Smith, VP. Les Boelter
Product: Record & tape browser boxes, record & tape display racks, record & tape divider cards
 Display Media Inc., 120 Laura Dr., Addison, Ill. 60101 Tel (312) 543-8330 Pres. & Gen. Mgr. R. Gribben
Product: Tape display racks & security systems (Securette) (I)
 Distric Inc., 42 Barringer Dr., Charlotte, N.C. 28210 Tel (704) 527-6151 VP & Gen. Mgr. Fred E. Martintz
Product: Record & tape browser boxes, record & tape display racks, record & tape divider cards
 Electra Display, 122 W. 27 St., New York, N.Y. 10001 Tel (212) 924-1022 VP. D. Ruderman
Product: Moving signs, display lighting
 Fidelity Corp., 109 Gaitner Dr., Mount Laurel, N.J. 08057 Tel (609) 235-3411 TWX (710) 897-0254 Pres. Roger Thanhauser, Sales & Mktg. Mgr. Arthur Constantine
Product: Tape display racks (M)
 Fixture Concepts Inc., 104 Neilsen Ave., Tukwila, Wash. 98188 Tel (206) 2, E 1450 Gen. Mgr., Jerry Schoeller, Sales Mgr. Peter Scott, Adv. Mgr. Lynda Hosson
Product: Record & tape (video) browser boxes, record & tape (video) display racks, tables, counters & related items for display & merchandising, with LP rack & pegboard accessories
 Forest Packaging Corp., 542 Factory Rd., Addison, Ill. 60101, Tel. 543-7035. Pres. John Kessock, VP. Richard Napp
Product: Corrugated counter top displays
 Freeman Artcraft Eng'g Corp., PO Box 228, Charlevoix, Mich. 49720 Tel (616) 547-6531, Gen. Mgr. Ronald Massey, Sales Mgr. L.L. Espich
 Branch: City of Industry, Calif., 14424 Bonellist Zip 91744 Tel (213) 958-9591 Sales & Dpns. Mgr. Ron Lloyd
Product: Record browser boxes, record & tape display racks
 Gopher Prods. Corp., PO Box 1812, 2201 Lockheed Way, Carson City, Nev.

89701 Tel (702) 882-9333 WATS (800) 648-0958 Pres. Warren Perkins
Product: Record & tape divider cards (M)
 Hamilton Fixture Co., 4805 Hamilton Middletown Rd., Hamilton, Ohio 45012 Tel (513) 868-2144. Pres. John Schlegel, VP & Sales Mgr. John Dvermann
Product: Record & tape browser boxes, record & tape display racks (MD)
 Ivy Hill Graphics & Packaging (div. of Ivy Hill Communications Inc.), 4800 S. Santa Fe Ave., Los Angeles, Calif. 90058 Tel (213) 587-3131 Exec. VP. Russell Muir, Gen. Mgr. Del Eaton, Sales Mgr. Arthur Kern, Display Div. Dir. Jerry Gottschalk
Product: Record & tape browser boxes, record & tape display racks, record & tape divider cards
 Kobrin Store Fixture Co., 254 Wallabout St., Brooklyn, N.Y. 11206 Tel (212) 387-1747 Prod'n Mgr. Benjamin Kobrin, Plant Superintendent Charles Kobrin, Sales Mgr. Samuel Kobrin
Product: Record & tape (audio & video) browser boxes, record & tape (audio & video) display racks (M)
 Kustom Creations Inc., 19316 Lordelius St., Northridge, Calif. 91324 Tel (213) 886-1383
Product: Tape browser boxes & display racks
 Le Bo Prods. Co. Inc. (div. of Peerless Vidronics Corp.), 58 60 Grand Ave., Maspeth, N.Y. 11378 Tel (212) 894-5155 Cable LEBDPRDDLX Telex 424790 P-15 P. Dayton
Product: Record & tape (audio) browser boxes, record & tape (audio) divider cards (M)

Liberty Fixture Inc., PO Box 8431 2467 Mariposa Rd., Stockton, Calif. 95208 Tel (209) 948-1176 Pres. Sales & Adv. Mgr. Leonard Semier, Gen. Mgr. Wayne Hibner
Product: Record & tape (audio & video) browser boxes, record & tape (audio & video) display racks & related items
 Loranger Mfg. Corp., Entertainment Prods. Div., 10-48 Clark St., Warren, Pa. 16365 Tel (814) 723-8600 VP. Robert Loranger
Product: Record & tape browser boxes (M)
 Harold Luck & Assocs., 110 Garfield St., Carlisle, Iowa 50047 Tel (515) 989-3679 Contact: Harold L. Luck
Product: Record & tape display racks (M)
 Malloy Dist'r Prods. Co., 3029 E. Washington Ave., Indianapolis, Ind. 46201 Tel (317) 636-5353
Product: Tape display racks (M)
 Modern Album & Finishing Co. Inc., Cardinal Ind'l Park, Gilpin Ave., Hauppauge, N.Y. 11787 Tel (516) 234-1100 NYC (212) 291-7600 Pres. G.D. Thomas, Sales Mgr. RA Froehlig
 Branches: Burbank, Calif., Modern Album of California Inc., 3116 Vanowen St. Zip 91505 Tel (213) 845-7655 Pres. William S. Pine, Sales Mgr. Raymond Gardocki—Terre Haute, Ind., Modern Album of Indiana, 1299 Voorhees St. Zip 47808 Tel (812) 235-6001—Nashville, Tenn., Modern Album of Tennessee Inc. 457 Chestnut Zip 37203 Tel (615) 255-7461
Product: Record & tape divider cards
 Monark, see Dajim
 N E R T (New England Record & Tape) (div. of PBN Survey), PO Box 268,

COLOR CASSETTE LABELS

WHITE AND COLOR
PRE-DIECUT PRESSURE SENSITIVE
SHEETS READY FOR IMPRINTING
OR IMPRINTED TO ORDER.

OTHER ADDRESS AND DIECUT
PRESSURE SENSITIVE LABELS
IN SHEETS.



PAULI PRODUCTS
P. O. BOX 29 • DEPT. BD
COLLINGSWOOD, N. J. 08108
(609) 547-8925

THE TAPE CENTER

In Store Display for
VIDEO CASSETTES
AUDIO CASSETTES • 8 TRACKS

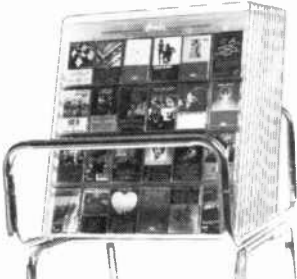

If you're looking for a small display fixture to expand your tape department, or if you would like to re-fixture an entire tape area, here's the best Tape Display-Merchandise made today.

EACH UNIT DISPLAYS 240 AUDIO CASSETTES or 120 8-TRACK TAPES or 80 VHS/BETA VIDEO TAPES.

- 22"x22" floor space per unit
- w/unique lock system
- offers total tape security
- displays all titles, same as records
- can be detached and used as counter-top display

DISTEC INC.

4212 Barringer Drive, Charlotte, NC 28210
(704) 527-6931

Rated No. 1



Video Wall Unit

NO. 1745 84" H • 48" L • 15½" D

- Holds 256 VHS Tapes 440 beta tapes
- Clear plastic secured doors
- Walnut finish

FREE Write for our brochure showing our complete line of video racks.



Liberty Fixture Inc. • 2467 Mariposa Rd.
P.O. Box 8431, Stockton, Ca. 95208
(209) 948-1176

Zip 01842, 641 Haverhill St., Lawrence, Mass 01841 Tel (617) 686 4293 Pres Jerry P. Marcus, VP Int'l Sales P.H. Kankey, Gen Mgr Melvin L. Marcus, Sales Mgr B.I. Kankey

Product: Record browser boxes, record display racks
Nostalgia Lane Inc., 200 W 57 St., New York, N.Y. 10019 Tel (212) 582 5390

Product: Record browser racks, record & tape display racks, record divider cards

Pacific Int'l Magnetics Inc., 185 Berry St., No. 3865, San Francisco, Calif 94107 Tel (415) 495 8830

Home office: Canada
Product: Tape display racks (audio)

Pak Wik Corp., 128 Tivoli St., Albany, N.Y. 12207 Tel (518) 465 4556 Pres Samuel A. Strasser, Sales Mgr Myron S. Strasser Jr

Product: Tape browser boxes

Paramount Housewares, 1035 Westminster Ave., Alhambra, Calif 91803 Tel (213) 570 1601 Pres Joseph D. Winston, Sales & Adv Mgr Charles W. Holmes

Product: Record browser boxes, record display racks, tape storage cases (M)

Raynor Sales Co. Inc., 2698 W Pico Blvd., Los Angeles, Calif 90006 Tel (213) 737 3737 Pres & Adv Mgr Ray Abrams Sr., Sales Mgr Ray Abrams Jr

Product: Record & tape browser boxes record & tape display racks, record & tape divider cards

Recoton Corp., 46 23 Crane St., Long Island City, N.Y. 11101 Tel (212) 392 6442 Pres Robert Borchardt, Exec VP Peter Wish VP Sales George Calvi

Product: Record & tape browser boxes record & tape display racks, record & tape divider cards

Scotch, see 3M
Securette see Display Media

Seebro Prods Co., 2416 S Michigan Ave., Chicago Ill 60616 Tel (312) 842 8221 Pres I. Siegal Sales Mgr R. Siegal

Product: Record display racks, wire pegboard baskets

Shape Inc., PO Box 366, Biddelford Indl Park, Biddelford, Me 04005 Tel (207) 282 6155

Product: Record & tape display racks (Shape Multistand)

Starbrite Video Advertiser see Voorhies

Star Title Strip Co., 842 Western Ave., Pittsburgh Pa 15233 Tel (412) 231 4314 Mgr William P. Miller

Product: Record & tape divider cards (MD)

3 M Co., Audio/Video Prods Div., 3M Center, St Paul, Minn 55101 Tel (612) 733 1466 Corp VP D.E. Denham Div VP J.E. Povolny, Mktg Dir W.J. Madden, Nat'l Sales Mgr J.L. Leon Mktg Opm Mgr J.B. Hanks Mkt Communications Mgr D.J. Lincham

Branches: Anchorage, Alaska, 5531 Minnesota Dr. Zip 99502 Tel (907) 276 2363-Burbank, Calif., 126 W Elm Court Zip 91502 Tel (213) 848 5534-Los Angeles, Calif., 6023 S Garfield Ave Zip 90040 Tel (213) 726 6300-South San Francisco, Calif., 320 Shaw Rd Zip 94080 Tel (415) 589 2663-Washington, D.C., 1101 15 St NW Zip 20005 Tel (202) 331 6900-Atlanta, Ga., 2860 Bankers Indl Dr. Zip 30360 Tel (404) 447 7000-Honolulu, Hawaii, PO Box 30048, 4443 Malaas St Zip 96818-Argo, Ill., 6850 S Harlem Ave Zip 60501 Tel (312) 496 6500-Needham Heights, Mass., 155 Fourth Ave Zip 02194 Tel (617) 449 0300-Farmington, Mich., 23923 Research Dr Zip 48024 Tel (313) 477 5000-Eagan, Minn., PO Box 33211, St Paul 55133 3130 Lexington Ave S Zip 55121 Tel (612) 733 3300-St. Louis, Mo., PO Box 510, 10725 Baur Blvd Zip 63166 Tel (314) 997 8500-West Caldwell, N.J., PO Box 76, 15 Henderson Dr Zip 07006 Tel (201) 575 2000-Cincinnati, Ohio, 4835 Para Dr Zip 45237 Tel (513) 242 2313-Cleveland, Ohio, 12200 Brookpark Rd Zip 44130 Tel (216) 267 1800-Philadelphia, Pa., 5698 Rising Sun Ave Zip 19120 Tel (215) 728 5300-Dallas, Tex., 2121 Santa Anna Ave Zip 75228 Tel (214) 324 8100-Seattle, Wash., Andover Indl Park, 100 Andover Park W Zip 98188 Tel (206) 244 7200

Product: Tape display racks (Scotch) (M)

Voorhies Ents Inc., 2869 Wexford Blvd Stow, Ohio 44224 Tel (216) 688 5811 Pres, Sales & Adv Mgr Robert Voorhies, Treas. Jennie Voorhies

Product: Moving video signs (Starbrite Video Advertiser)

Vulcan Binder & Cover (div of EBSCO Inds Inc.), PO Box 29, Vincent, Ala 35178 Tel (205) 672 2241 VP R. Denson Parker, Sales Mgr John R. Boleslawski, Adv Mgr B.R. Cummings

Product: Tape display racks (M)

Dick Wagner, 5930 Penfield Ave Woodland Hills, Calif 91367 Tel (213) 992 6266

Product: Record display racks (Directree)

Wiremaid Prod Corp (div of Cove Four Slide), 60 West Ave., Patchogue, N.Y. 11772 Tel (516) 475 0193 Pres Barry Jaffe, Sales Mgr A. Boden, Adv Mgr Leigh Boden

Product: Record & tape display racks (M)

Zip 01842, 641 Haverhill St., Lawrence, Mass 01841 Tel (617) 686 4293 Pres Jerry P. Marcus, VP Int'l Sales P.H. Kankey, Gen Mgr Melvin L. Marcus, Sales Mgr B.I. Kankey

Product: Record browser boxes, record display racks

Nostalgia Lane Inc., 200 W 57 St., New York, N.Y. 10019 Tel (212) 582 5390

Product: Record browser racks, record & tape display racks, record divider cards

Pacific Int'l Magnetics Inc., 185 Berry St., No. 3865, San Francisco, Calif 94107 Tel (415) 495 8830

Home office: Canada
Product: Tape display racks (audio)

Pak Wik Corp., 128 Tivoli St., Albany, N.Y. 12207 Tel (518) 465 4556 Pres Samuel A. Strasser, Sales Mgr Myron S. Strasser Jr

Product: Tape browser boxes

Paramount Housewares, 1035 Westminster Ave., Alhambra, Calif 91803 Tel (213) 570 1601 Pres Joseph D. Winston, Sales & Adv Mgr Charles W. Holmes

Product: Record browser boxes, record display racks, tape storage cases (M)

Raynor Sales Co. Inc., 2698 W Pico Blvd., Los Angeles, Calif 90006 Tel (213) 737 3737 Pres & Adv Mgr Ray Abrams Sr., Sales Mgr Ray Abrams Jr

Product: Record & tape browser boxes record & tape display racks, record & tape divider cards

Recoton Corp., 46 23 Crane St., Long Island City, N.Y. 11101 Tel (212) 392 6442 Pres Robert Borchardt, Exec VP Peter Wish VP Sales George Calvi

Product: Record & tape browser boxes record & tape display racks, record & tape divider cards

Scotch, see 3M
Securette see Display Media

Seebro Prods Co., 2416 S Michigan Ave., Chicago Ill 60616 Tel (312) 842 8221 Pres I. Siegal Sales Mgr R. Siegal

Product: Record display racks, wire pegboard baskets

Shape Inc., PO Box 366, Biddelford Indl Park, Biddelford, Me 04005 Tel (207) 282 6155

Product: Record & tape display racks (Shape Multistand)

Starbrite Video Advertiser see Voorhies

Star Title Strip Co., 842 Western Ave., Pittsburgh Pa 15233 Tel (412) 231 4314 Mgr William P. Miller

Product: Record & tape divider cards (MD)

3 M Co., Audio/Video Prods Div., 3M Center, St Paul, Minn 55101 Tel (612) 733 1466 Corp VP D.E. Denham Div VP J.E. Povolny, Mktg Dir W.J. Madden, Nat'l Sales Mgr J.L. Leon Mktg Opm Mgr J.B. Hanks Mkt Communications Mgr D.J. Lincham

Branches: Anchorage, Alaska, 5531 Minnesota Dr. Zip 99502 Tel (907) 276 2363-Burbank, Calif., 126 W Elm Court Zip 91502 Tel (213) 848 5534-Los Angeles, Calif., 6023 S Garfield Ave Zip 90040 Tel (213) 726 6300-South San Francisco, Calif., 320 Shaw Rd Zip 94080 Tel (415) 589 2663-Washington, D.C., 1101 15 St NW Zip 20005 Tel (202) 331 6900-Atlanta, Ga., 2860 Bankers Indl Dr. Zip 30360 Tel (404) 447 7000-Honolulu, Hawaii, PO Box 30048, 4443 Malaas St Zip 96818-Argo, Ill., 6850 S Harlem Ave Zip 60501 Tel (312) 496 6500-Needham Heights, Mass., 155 Fourth Ave Zip 02194 Tel (617) 449 0300-Farmington, Mich., 23923 Research Dr Zip 48024 Tel (313) 477 5000-Eagan, Minn., PO Box 33211, St Paul 55133 3130 Lexington Ave S Zip 55121 Tel (612) 733 3300-St. Louis, Mo., PO Box 510, 10725 Baur Blvd Zip 63166 Tel (314) 997 8500-West Caldwell, N.J., PO Box 76, 15 Henderson Dr Zip 07006 Tel (201) 575 2000-Cincinnati, Ohio, 4835 Para Dr Zip 45237 Tel (513) 242 2313-Cleveland, Ohio, 12200 Brookpark Rd Zip 44130 Tel (216) 267 1800-Philadelphia, Pa., 5698 Rising Sun Ave Zip 19120 Tel (215) 728 5300-Dallas, Tex., 2121 Santa Anna Ave Zip 75228 Tel (214) 324 8100-Seattle, Wash., Andover Indl Park, 100 Andover Park W Zip 98188 Tel (206) 244 7200

Product: Tape display racks (Scotch) (M)

Voorhies Ents Inc., 2869 Wexford Blvd Stow, Ohio 44224 Tel (216) 688 5811 Pres, Sales & Adv Mgr Robert Voorhies, Treas. Jennie Voorhies

Product: Moving video signs (Starbrite Video Advertiser)

Vulcan Binder & Cover (div of EBSCO Inds Inc.), PO Box 29, Vincent, Ala 35178 Tel (205) 672 2241 VP R. Denson Parker, Sales Mgr John R. Boleslawski, Adv Mgr B.R. Cummings

Product: Tape display racks (M)

Dick Wagner, 5930 Penfield Ave Woodland Hills, Calif 91367 Tel (213) 992 6266

Product: Record display racks (Directree)

BLANK LOADED TAPE & ACCESSORIES WHOLESALERS

• Continued from page 30

• SAN BENITO (Area Code 512)

Rio Grande Music Co., 119 S. Sam Houston Blvd., Zip 78586 Tel 399-5377
Lines: BASF, Scotch

UTAH

• SALT LAKE CITY (Area Code 801)

Alta Dist'g Co., Intermountain Div., 2370 W. Bridger Rd., Zip 84104, Tel: 972 3800 Pres. George Souvall, VP & Gen Mgr. Joseph E. Sasich, Sales Mgr. Winston G. Jones Jr
Branch: Phoenix, Ariz
Lines: Le-Bo, Maxell, Memorex, Savoy, Scotch, Sound Guard, TDK, Tracs, Watts
Terr.: Idaho, Mont., Nev., Utah, Wyo

VERMONT

• WHITE RIVER JUNCTION (Area Code 802)

Electronic Supply Inc., Prospect St. Zip 05001 Tel 295 3183

VIRGINIA

• NORFOLK (Area Code 804)

Eurpac East (formerly Contact Norfolk), 961 Norfolk Square Zip 23502 Tel 857 0131

Lines: Ampex, Le Bo

Scott Dist'g Corp., 3418 Azalea Garden Rd. Zip 23513 Tel 855 0188 Pres Sidney Kruglick, Mgr R. Kruglick

Home office: Island Park, N.Y.

Line: Scotch

Terr.: Military

Tidewater One Stop, 1910 Granby St. Zip 23517 Tel 623 6256 Sales Mgr Charles Faison

Home office: Lanham, Md., Schwartz Bros Inc

Lines: Allsup, Ampex, Audio-Technica, BASF, Bowers, Dynasound, Empire, Maxell, Memorex, Pickering, Recoton, Scotch, Shure, Sony, Sound Guard, Stak II, TDK

Terr.: N.C., S.C., Va., W. Va

WASHINGTON

• SEATTLE (Area Code 206)

Major Dist.: 18292 Andover Park W., Tukwila 98188 Tel 575-0081 Pres R. G. Anderson, Mgr Gary Clark

Branches: Livermore (San Francisco & Bay Area), Calif., Honolulu, Hawaii

Lines: Allsup, BASF, Le Bo, Maxell, Memorex, Recoton, Transcriber

Terr.: Alaska, Calif., Hawaii, Idaho, Mont., Ore., Wash

Pickwick Int'l Inc., 9860 40 Ave S Zip 98118 Tel 725 2500

Home office: Minneapolis, Minn

WEST VIRGINIA

• CHARLESTON (Area Code 304)

3 D Electronics Inc., 1541 Washington St W Zip 25312 Tel 345-6829

Lines: BSR, Electro Voice, Le Bo, Memorex, Scotch

Terr.: Eastern Ky., Eastern Ohio, Southwestern Va., W. Va

AUDIO/VIDEO/TAPE EQUIPMENT MANUFACTURERS & IMPORTERS

• Continued from page 18

Zip 60007 Tel (312) 593 2960 Branch Mgr Jerry Sabino-Irving, Tex., 1875 Walnut Hill Ln Zip 75062 Tel (214) 258 0200 Branch Mgr Peter Sartori

Distribution: M/Rep

Product: LASER DISC videodisk players (optical/laser)

ULTRAVISION, see F&F Sales

VELBON INT'L CORP., 2433 Moreton St., Torrance, Calif. 90505, Tel: (213) 326 7902 Telex 653499, Pres. Koma Nakatani; VP Sales & Adv: Ted Yokofich

Distribution: M/Rep.

Product: Video camera tripods.

VIDEOBEAM, see Advent.

VIDEO-MASTER, see Giant Screen TV.

VIDIMAX, see TransVision.

VIDSTAR, see JVC.

VIEWPOINT PROJECTION INC., PO Box 4221, Clearwater, Fla. 33518, Tel: (813) 531 8996 Pres. Michael E. Davis; Adv Mgr. J.A. Crilly

Distribution: M/End, M/C, M/Rep.

Product: Large screen television/video projectors.

VOORHIES ENTS. INC., 2869 Wexford Blvd., Stow, Ohio 44224 Tel: (216) 688 5811 Pres, Sales & Adv Mgr Robert Voorhies, Treas. Jennie Voorhies

Distribution: M/Ret., M/End, ID, M/Rep

Product: STARBRITE large screen television/video projectors, video projection screens, satellite receiving dish antennas

ZENITH RADIO CORP., 1900 N. Austin Ave., Chicago, Ill 60639, Tel: (312) 745 2000

Product: Videocassette rec'rs (Beta II)



"In Harmony"

You know harmony means more than just entertainment at the USO. It's volunteers working together to create a "back home" environment for servicemen and women stationed far from home. It's informal classes...inter-cultural understanding...and orientation information. USO...It's sweet music.

Dixie Humming Birds

Support USO through the United Way, OCF, or local USO campaign

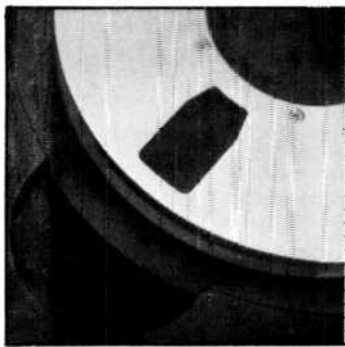

INTERNATIONAL AUDIO VIDEO TAPE DIRECTORY

TAPE SERVICES

1 DESIGN & ARTWORK/ PRINTING & LITHOGRAPHING

The key to the abbreviations used in this category is: "(DES)" for those companies which execute designs or artwork, and "(PRT)" for those which do printing or lithographing.

ALABAMA

• DOTHAN (Area Code 205)

Tri-State Publ'g Co. Inc., 120 S St Andrews, Zip: 36301 Tel: 792-6808 (DES, PRT)

ARIZONA

• PHOENIX (Area Code 602)

General Cassette Corp., 2311 N 35 Ave Zip 85009 Tel 269 3111 (DES-tape only)
Universal Audio Corp., 5540 E Lafayette Blvd., Scottsdale 85217 Tel 949 7577 (DES)

• TUCSON (Area Code 602)

Antique Print'n Parlor, 601 E Sixth St Zip 85705 Tel 884 7544. Prop J.W. Shirley, Art Dir Steve Nelson (DES, PRT)

CALIFORNIA

• CAMPBELL (Area Code 408)

Westpac, 503-B Vandell Way Zip: 95008. Tel: 374-0871. Sales Mgr. Rich Krueger (DES-record & tape, PRT-tape only).

• LA PALMA (Area Code 714)

Matthews Int'l Corp., 5555 Fresca Dr Zip 90623 Tel 523 5511 Mgr J Davis (PRT-film masters, symbol consultant & testing)
Home office: Pittsburgh, Pa.

• LOS ANGELES METROPOLITAN AREA (Area Code 213)

A G I (Album Graphics Inc.), 424 N. Larcumnt Blvd. Zip 90004. Tel: 462-0821 (Sales office only) (DES, PRT)

Home office: Melrose Park (Chicago Metropolitan Area), Ill
Album Graphics Inc., see AGI

Alshire Int'l Inc., 1015 Isabel St., Burbank 91510 Tel 849 4671 WATS (800) 423 2936 Cable BUDSHUND TWX (910) 498-2759 Pres. Al Sherman, Gen Mgr. Dick Ceja (DES, PRT)

Award Rec. Mfg. Inc., 11016 La Granga Blvd., Inglewood 90304 Te 645-2281. (PRT-record only).

Bert-Co Encls. Inc. (div. of the Walker Reade Org. Inc.), 1855 Glendale Blvd Zip 90026 Tel 665-5137 (DES, PRT).

Home office: New York, N.Y.

Cadet Recs Inc., 5810 S Normandie Ave Zip: 90044 Tel 753 5121 Pres. Jules Bihari, Mgr. Don Macmillan (DES PRT)

Branch: Park Ridge, N.J.

Container Kraft Inc., 8321 DeCelo, Pl. Sepulveda: 91343 Tel 893-9721. (PRT)

Creative Minds Inc., 1560 N. La Brea, Suite M, Hollywood 90028. Pres. Arthur H. Benson, Sales Mgr. Howard Wormser. (DES)

Custom Rec. Mfg Co., 5810 S Normandie Ave. Zip 90044 Tel 753-5121 Pres. Jules Bihari; VP: Don Macmillan (DES, PRT)

D A K Inds Inc., 11845 Vanowen St., North Hollywood 91605 Te 984-1559 WATS (800) 423-2636 Cable DAKENT. Telex 651396 Pres. Drew Alan Kaplan. (PRT-tape only)

Rod Dyer Inc., 5550 Wilshire Blvd., Suite 301. Zip: 90036 Tel. 937-4100 Pres.: Rod Dyer; VP: Robert Kern. (DES)

Hoppe Street Studio, 607 N. Ave. 54. Zip: 90042 Tel. 258-6741 Pres. & Owner Van Webster, Studio Mgr. Cristy Robertson (DES)

Ivy Hill Graphics & Packaging (div. of Ivy Hill Communications Inc.), 4800 S. Santa Fe Ave Zip 90058 Tel 587 3131 Exec. VP Russell Muir, Gen Mgr. Del Eaton, Sales Mgr. Arthur Kern. (DES, PRT)

Home office: Great Neck, N.Y.

K M Recs. Inc., 2980 N. Ontario St., Burbank 91504 Tel 841-3400 Pres. Glade Merkleby; VP Custom Servs.: Jim Auchtericome; VP Audiophile Sales: Mike Malan, Mktg. & Adv. Mgr.: Bruce Leek. (PRT-record only)

Kdisc (sub. of Keycor Century Corp.) 6550 Sunset Blvd., Hollywood 90028. Tel 466-1323 Gen. & Studio Mgr. Bill Lightner (DES, PRT-record only)

Plant: Saugus, Calif.

Kosh & Co., 1584 Crossroads of the World, Hollywood 90028. Tel 466-9755 (DES)

Lester Music Engraving, 345 S Citrus Ave Zip 90036 Tel 939 3630 Owner James T Lester (DES)

The Merchandising Guild, 61n3 Glen Alder Zip 90068 Tel 663 1293 (DES)

Modern Album of California Inc., 3116 Vanowen St., Burbank 91505 Tel 845 7455. Pres. William S Pine, Gen Mgr. Raymond Gardocki (PRT-record only)

Home office: Hauppauge, N.Y., Modern Album & Finishing Co Inc

Monarch Rec. Mfg. Corp. (sub. of ElectroSound Group Inc.), 9545 San Fernando Rd., Sun Valley 91352. Tel 767-8833 Pres. Nate DuRoff, VP & Gen Mgr. Bob Barone (PRT-record only)

Home office: Holbrook, N.Y., ElectroSound Group Inc

Sales office: New York, N.Y., ElectroSound Group Inc

Musicsearch, 9000 Cynthia St., Suite 205 Zip 90069 Tel 275-4790 VP Admin., Robert Greenfield, VP Creative Servs. Topper Schroeder. (DES)

Myriad Prod'ns, 1314 N Hayworth Ave., Suite 402 Zip 90046 Tel 851 1400. Pres: Ed Harris (DES)

Neilson/Anklam Inc., 11908 Ventura Blvd., Studio City 91423 Tel 980 1631 Bd. Chm. Ron Neilson, Pres. Barry D Anklam, VP: Bill Feltz (DES)

Pacific Eye & Ear, 451 N La Granga Blvd Zip 90048 Tel 659-2121 (DES)

Pedersen Label Printing Co., 11152 Fleetwood St., Sun Valley 91352 Tel 768-3-22. Pres. Herman A Fredriks, Prod. Mgr. S Kadonaga (PRT)

Photo/Graphics, 1125 E Orange Ave. Monrovia 91016 Tel. 359-9414 (DES)

Queens Lithographing Corp., 6290 Sunset Blvd., Suite 304, Hollywood 9002E Tel 464-7700 (DES, PRT)

Home office: Long Island City (New York Metropolitan Area), N.Y.

Plant: Indianapolis, Ind., Rutgers Packaging Corp

Radio Central, 427 W Fifth St., Suite 631 Zip 90013 Tel 626-9891 (DES, PRT-tape only)

Rainco Rec. Mfg. Corp., 1738 Berkeley St., Santa Monica 90404. Tel 829 3476 TWX (910) 343 7420. Pres.: Jack G. Brown, VP & Gen. Mgr.: James Doyle, Prod'n Supervisor Steve Sheldon (PRT-record only)

Roach Inc., 8430 Tujunga Ave., Sun Valley 91352 Tel 767-8300. (DES & PRT-customized tee shirts & hats only)

Home office: Columbus, Ohio

Shorewood Packaging Corp., 1830 Glendale Blvd Zip 90026 Tel 660 3043. (PRT-record only)

Home office: New York, N.Y.

Stoughton Printing Co., 130 N Sunset Ave., City of Industry 91744 Tel 961-3578, LA 686-2753. Pres. & Gen. Mgr. Jack W Stoughton; Sales Mgr. Jack Stoughton Jr (PRT-record only)

Superior Data/Graphic Corp. 5717 Santa Monica Blvd Zip 90038 Tel 467 5133 (PRT)

Superscope Inc., 22459 Paul Revere Dr., Woodland Hills 91364 Tel 998 9333 x 2090. Pres. Joseph S Tushinsky, Mktg & Sales Mgr.: Bill Rosen. (DES, PRT)

Surf City Recs., PO Box 14, Hollywood 90028 Tel. 349-9099 Pres.: Gary M. Theroux; Admn. Ass't Russell Bidwell, Sales Mgr. Mark Charger; Adv. Mgr.: Peter Roberts (DES)

Tape Specialty Inc., 13411 Satcoy St. North Hollywood 91605. Tel 786-6111 Pres. Steve Feldman, Gen Mgr. Len Feldman, Chief Eng. Stu Feldman (DES-tape only)

Wong Design Co., 6255 Sunset Blvd. Zip: 90028 Tel 469-4194 Chief Exec. Ron Wong. (DES-record only)

• MISSION VIEJO (Area Code 714)

Kernie Erickson Visual Communications, Box 2175 Zip: 92690. Tel 831 2818. (DES)

• MONTEREY (Area Code 408)

Publishers Art Serv., 455 Pierce St Zip 93940. Tel 375-1191 (DES)

• OCEANSIDE (Area Code 714)

Exzel Co., 1907 Apple St. Zip: 92054. Tel. 439-3020. Pres. J. Richard Lee, Gen. Mgr.: Bill Mottcamp (DES)

• SACRAMENTO (Area Code 916)

Bill Rase Prod'ns Inc., 955 Venture Court. Zip 95825 Tel 929-9181 Owner & Pres. Bill Rase (DES)

• SAN FRANCISCO & BAY AREA (Area Code 415)

Conlan/Golden Inc., 501 Forbes Blvd., Suite 106, South San Francisco 9408H. Tel: 871 9672. (DES, PRT)

Fred Fox Music Co., 406 Kehue Ave., Half Moon Bay 94019. Tel 726-3725 Pres.: F.H. Nesbitt Jr., Sales Mgr.: V.A. Nesbitt (DES)

Cathy Furniss & Assocs., 680 Beach St., Suite 445 Zip: 94109 Tel 885-2807 Pres. Cathy Furniss; Adv Mgr. Isabelle Aggson (DES, PRT)

Luna's Illuminations, 111 Chester St., Fairfax 94930 Tel 457-5970. (DES)

Pacific Int'l Magnetics Inc., 1K5 Berry St. Zip. 94107 Tel 495-8830. (Sales office only) (DES, PRT)

Home office: Richmond, B.C., Canada.

Sonic Arts Corp., 665 Harrison St. Zip 94107 Tel. 781-6307. Pres. Leo de Gar Kulkas; Gen. Mgr. Herbert P Haas. (DES, PRT).

• SANTA CRUZ (Area Code 408)

Suttle Designs, 118 Myrtle St Zip 95060 Tel 426-2819 (DES)

• SAUGUS (Area Code 805)

Kdisc (sub. of Keycor Century Corp.), 26000 Springbrook Ave Zip 91350 Tel 259 2360 Pres. Eugene R. Schultz, Gen Mgr. Bill Lightner (DES, PRT-record only)

Office: Hollywood (Los Angeles Metropolitan Area), Calif

• STANTON (Area Code 714)

Photo-Lith Int'l, 11816 Western Ave. Zip 90680. Tel 893-5037. WATS (800) 893 5037 (DES & PRT-customized tee shirts only)

• STOCKTON (Area Code 209)

Liberty Fixture Inc., PO Box 8431, 2467 Mariposa Rd. Zip 95208 Tel 948 1176 Pres. Sales & Adv. Mgr. Leonard Semier, Gen. Mgr. Wayne Hibner (PRT).

COLORADO

• BOULDER (Area Code 303)

Video/Audio Artistry Corp. (Vidaac Ltd.), PO Box 4571, 1258 Bear Mountain Court. Zip 80302 Tel 499-2001 (DES)

• DENVER (Area Code 303)

Soundmark Corp 4950 Nome St., Unit C Zip 80239 Tel 371 3076 (PRT)

CONNECTICUT

• DARIEN (Area Code 203)

George Alexander Group Inc., 1063 Post Rd Zip 06820. Tel: 655 7791. NYC (212) 886 5600 (DES, PRT)

• SOUTHPORT (Area Code 203)

Sound Innovations, 290 Bronson Rd Zip 06490 Tel 259-0467 Owner & Eng. John Arcotta, Gen. Mgr. Frank Baldissero, Sales Mgr. Steve Kruzeine (DES, PRT-tape only)

• TRUMBULL (Area Code 203)

J & D Litho Serv., 9 Sally Ann Dr. Zip 06611 Tel 261-3366 (PRT)

• UNION CITY (Area Code 203)

A C Hampson Printing Co Inc., 168 City Hill St Zip 06770. Tel 729 2294 Pres. Augustus D Hampson, Sales Mgr. John W Berry (DES, PRT-tape only)

DELAWARE

• BEAR (Area Code 302)

Factors Etc Inc., Geissler Park, Zip 19701 Tel 834-1625 Pres. H. Lee Geissler, Sales Mgr. Laurence H. Seeny (DES, PRT-customized tee-shirts only)

• WILMINGTON AREA (Area Code 302)

Ken-Del Prod'ns Inc., 111 Valley Rd., Richardson Park 19804 Tel 655-7488 (DES, PRT)

National Tape Dupl'rs, see Ken-Del

FLORIDA

• FORT LAUDERDALE AREA (Area Code 305)

Alpha Recs Inc., 1400 NW 65 Ave., Plantation 33313 Tel 587 6011 (DES, PRT)

• MIAMI METROPOLITAN AREA (Area Code 305)

Allison-Alhambra Recs Inc., 4380 NW 128 St Zip: 33054. Tel 685-8396 Telex 522178 (PRT)

Image Devices Inc., 1825 NE 149 St Zip 33181 Tel 945-1111 Telex 519348 TWX (810) 845-4242 Sales Mgr. Bill Reiter (PRT)

Miami Tape Inc., 8180 NW 103 St., Hialeah Gardens 33015 Tel 558-9211 (PRT)

Musical Tapes Inc., 770 W. 27 St., Hialeah 33010. Tel. 885-9156. Pres. Eliseo C. Valdes. (DES-tape only, PRT-record & tape)

Tropical Paper Box Co., 7000 NW 25 St Zip 33122 Tel 592-5520 (PRT)

• ORLANDO AREA (Area Code 305)

Magnetics Corp., 770 W Bay St., Winter Garden 32787. Tel 656-4494 Pres John Lory (PRT)

GEORGIA

• ATLANTA METROPOLITAN AREA (Area Code 404)

Linear Prods Inc., 4507-K Mills Pl SW, College Park 30366 Tel 761 5432 (DES, PRT)

Home office: New York, N.Y.

Matthews Int'l Corp., 1303 Logan Circle NW Zip 30318 Tel 355 3255 Mgr. D. Barley (PRT-film masters, symbol consultation & testing)

Home office: Pittsburgh, Pa.

Project 70 Audio Servs. Inc., 1127 Spring St NW. Zip: 30309. Tel. 875-7008. (PRT-tape only)

The T-Shirtery Inc., 1200 Menlo Dr NW Zip 30377 Tel 351-9850. WATS (800) 241-1052. Pres.: Jay J Cohen, VP Sales Paul Katz (DES, PRT-customized tee-shirts only)

Wonder Graphics Inc., 983 Waverly Way. Zip: 30307 Tel: 524-1200. (DES)

● **COLUMBUS (Area Code 404)**

Capricorn Sales, 4018 Buena Vista Rd Zip 31907 Tel: 563-5353 (DES & PRT—customized tee-shirts only)

● **LA GRANGE (Area Code 404)**

S P C Co (div of Shorewood Packaging Corp.), 1707 Shorewood Or Zip 30240, WATS Tel: (800) 241-0186. Plant Mgr. Ken McCabe. (DES, PRT)
Home office: New York, N.Y., Shorewood Packaging Corp

ILLINOIS

● **CHICAGO METROPOLITAN AREA (Area Code 312)**

A G I (Album Graphics Inc.) 1950 N. Ruby St., Melrose Park 60160 Tel: 344 9100 TWX (910) 226-0417 Pres: Donald W Kosterka, Sales Mgr: Kevin McKenna (DES, PRT)

Sales offices: Los Angeles, Calif., New York, N.Y.

Acrylic Design & Fabrication Co., 1147 W. Ohio Zip 60622. Tel: 226-4222 (DES)

Ad-Vertising Unlimited, PO Box 8135 Zip 60680 Tel: 787-8220. Pres: R.C. Hillsman, Sales Mgr: Frank Howard Jr., Adv. Mgr: Howard Pittman (DES)

Album Graphics Inc., see AGI

Armageddon Talent Assocs., 1604 W Juneway Terr Zip 60626. Tel: 465 3373 Mgr: Fred Tiekens (DES)

Audio Accessories Co., 38 W 515 Oerpath Rd., Batavia 60510 Tel: 879-5998 Sales Mgr: John S Maloney (DES—tape only)

Audio Artists Ltd., PO Box 7, Wheaton 60187 Tel: 668-6682 (DES)
Bruce Packaging Co., 8025 N. Kenneth Ave., Skokie 60076 Tel: 583 2818 Pres: Joseph Halpern (DES)

M. M. Cole Music Publ'g Co., Playbox Bldg., Suite 1602, 919 N. Michigan Ave. Zip 60611. Tel: 787-0804 Cable: MIMCOLE Pres: Shepard Stern, Sales Mgr: J.C. Cole, Adv. Mgr: Mike Stern. (DES, PRT)

Fort Oearborn Lithograph Co., 6035 W Gross Point Rd., Niles 60648 Tel: 647 8730 (DES, PRT)
Higgins, Hegner, & Genovese Int'l, 510 N. Oearborn Zip 60610. Tel: 644 1882 (DES)

Kidman Recs Prod'ns, 4926 W Gunnison St Zip 60630. Tel: 545-0861 Pres: Raymond Peck, Gen & Sales Mgr: George Peck (DES—record only)

Matthews Int'l Corp., 3435 N. Kimball Ave. Zip 60618 Tel: 539-7000 Mgr: J. Bluemling (PRT—film masters, symbol consultation & testing)
Home office: Pittsburgh, Pa

Media Int'l Inc., 425 N. Michigan Zip 60611. Tel: 467-5430. Pres: Ouanne Lundeun, VP: Margaret Lundeun, Gen. Mgr.: Al Masters (DES—record & tape, PRT—tape only)

Planet Communications (div of Clay Pigeon Int'l), PO Box 20346 Zip 60620 Tel: 778 8760 Pres. & Gen. Mgr.: Vytautas Beleska, Sales Mgr: Rudy Marius, Special Projects Mgr.: O. Jaras. (DES)

Poly Com Group, 201 E. Ohio St. Zip 60611. Tel: 222-9480. Gen. Mgr: Richard Jablonski, Sales Mgr: Oaive Bertz, Prod'n Mgr: Carmen Trombetta (DES)

Pro I Audio Visual Inc., PO Box 33, Highland Park 60035 Tel: 433-4575 Pres: R.L. Pmk, VP: J. Pmk, Sales Mgr: M.M. Pmk, Adv. Mgr.: O.O. Pmk (DES, PRT)

Rainbow Bridge Studios Inc., 117 Rockland Rd., Libertyville 60048. Tel: 362-4060 Studio Mgr.: Ron Schwartz (DES)
Rooster Blues Recs., 2615 N. Wilton Ave. Zip 60614 Tel: 281-3385 (DES, PRT)

Vinyliweld, 2011 W Hastings. Zip 60608 Tel: 243 0606 (PRT—tape only)

● **ROCKFORD (Area Code 815)**

Carter Corp., 1916 11 St. Zip 61101. Tel: 397-3200. Cable: CARTERCORP. Pres: Robert L. Fleming, VP: Sales & Mktg: Sandra L. Fleming, Plant Mgr: W. Skip Kruger (DES, PRT)

INDIANA

● **INDIANAPOLIS (Area Code 317)**

Bowers Rec. Sleeve Co., 5331 N. Tacoma Ave. Zip 46220. Tel: 251 3918 Pres: James E. Bowers, VP: Thomas R. Bowers (DES & PRT)

Infitheatre Inc., 4990 Massachusetts Zip 46218 Tel: 545 2001 (DES)
Reco-Sleeve Packaging, 620 S Belmont Zip 46221 Tel: 635 7777 (PRT)
Rutgers Packaging Corp. (div of Queens Lithographing Corp.), 620 S Belmont Ave. Zip 46221. Tel: 635 7777. TWX: (810) 341-3457/3400. Pres: Abe Garde. (DES, PRT)

Home office: Long Island City (New York Metropolitan Area), N.Y., Queens Lithographing Corp

● **RICHMOND (Area Code 317)**

P R C Rec'g Co. (div. of Richmond Rec'g Corp.), 1600 Rich Rd. Zip 47374 Tel: 962 9511 (PRT)
Home office: New York, N.Y.

● **TERRE HAUTE (Area Code 812)**

Ivy Hill Communications Inc., Fort Harrison Ind'l Park, Fruitridge Ave. Zip 47803 Tel: 466-9851. (PRT)
Home office: Great Neck, N.Y.

Modern Album of Indiana Inc., 1299 Voorhees St. Zip: 47808. Tel: 235-6001. (PRT)
Home office: Hauppauge, N.Y., Modern Album & Finishing Co. Inc. Woodburn Printing Co., 25 S Sixth St. Zip 47808 Tel: 466-6822 Pres: Donald P. Pendergast; Sales Mgr: Ed Schulz, Adv. Mgr: John Crippen (PRT)

IOWA

● **CARLISLE (Area Code 515)**

Harold Luck & Assocs., 110 Garfield St. Zip 50047 Tel: 989-3679 Contact: Harold L. Luck (DES, PRT)

● **CORALVILLE (Area Code 319)**

Safeguard Co., PO Box 5555, 108 Second Ave. Zip 52241. Tel: 351-7830 Gen. Mgr: (Audio-Visual Prod'ns) Ben Pflof. (DES—tape only)
Home office: Brookfield (Milwaukee Metropolitan Area), Wis

● **DES MOINES (Area Code 515)**

Stenclo Graphics, PO Box 2501, 5311 SW Ninth. Zip 50315. Tel: 285-6564. (DES & PRT—customized tee shirts only)

KENTUCKY

● **LOUISVILLE (Area Code 502)**

Allen-Martin Prod'ns Inc., 9701 Taylorsville Rd. Zip 40299. Tel: 267-9658 (DES)

A/V/T-34

LOUISIANA

● **BATON ROUGE (Area Code 504)**

Record Co of the South (RCS), 5220 Essen Ln. Zip 70808 Tel: 766 3233. Pres: Cyril E. Vetter, Gen. Mgr: John Fred, Sales Mgr: Ronnie Schaab; Art. Or: Ed Lakin. (DES, PRT)

● **VILLE PLATTE (Area Code 318)**

Ville Platte Rec. Mfg. Co., 120 E Cypress St. Zip 70586. Tel: 363 2104. Pres: J. Floyd Soileau, Sales Mgr.: Ronnie Soileau (DES & PRT—record only)

MARYLAND

● **BALTIMORE AREA (Area Code 301)**

The Record Factory, 10120 Marble Court, Cockeysville 21030 Tel: 628-2920 (DES)

● **HYATTSVILLE (Area Code 301)**

The Shirt Explosion Co. Inc., 5618 Lafayette Pl. Zip 20781. Tel: 277-4400. (DES & PRT—customized tee-shirts only)

● **KENSINGTON (Area Code 301)**

Omega Rec'g Servs., 10518 Connecticut Ave. Zip 20795 Tel: 946 4686 Owner & Chief Eng. W. Robert Yesbek (DES)

● **WHEATON (Area Code 301)**

Big Ed's Unlimited, 11141 Georgia Ave., Suite A-1, Silver Springs Zip 20902 Tel: 949-9500 (DES & PRT—customized tee-shirts only)

MASSACHUSETTS

● **BOSTON METROPOLITAN AREA (Area Code 617)**

Fleetwood Communications Co. Inc., 321 Revere St., Revere 02151 Tel: 289-6800 Pres.: V.P. Giarrusso, Gen. Mgr: Raymond G. Samora, Sales Mgr: Victor Mancini, Adv. Mgr: Robin Samora (DES, PRT)

Matthews Int'l Corp., 3 Brooks Dr., Braintree 02184 Tel: 848 8220 Mgr: R. Deats (PRT—film masters, symbol consultation & testing)
Home office: Pittsburgh, Pa.

Rik Tynory Prod'ns, 180 Pond St., Cohasset 02025 Tel: 383-9494 Pres: Richard F. Tynory, Artist Relations: Claire L. Babcock (DES, PRT)

● **CHICOPEE (Area Code 413)**

Otelectrics Inc., 300 Burnett Rd. Zip: 01020 Tel: 598-8308. (DES, PRT)
Just for the Record, 40 Marion St. Zip: 01013. Tel: 592-0457 Pres: Robert S. Bator, Adv. Mgr: Celine St. Laurent Bator. (DES)

● **TURNERS FALLS (Area Code 413)**

Silver Screen Design, 88 Third St. Zip 01376 Tel: 863-4496 (DES—customized silk screened tee shirts only)

MICHIGAN

● **DETROIT METROPOLITAN AREA (Area Code 313)**

Graphic Design Inc., 23800 Amber, Warren 48089 Tel: 758-0480 (DES, PRT)

Tape-Tronics Inc., 750 E. Mandoline, Madison Heights 48071 Tel: 588-8281 TWX: (810) 232 1524 (DES)

MINNESOTA

● **MINNEAPOLIS-ST. PAUL METROPOLITAN AREA (Area Code 612)**

Ark Rec'g Co. (div. of Fulton Electronics), 4208 Brunswick Ave. N., Minneapolis 55422 Tel: 537 7076. Pres: Robert W. Fulton; Sales Mgr: Robert W. Fredder (DES)

Bethany Fellowship Inc., 6820 Auto Club Rd., Minneapolis 55438 Tel: 944-2121 Cable: BETHANY. Pres: T.A. Hegre, Gen. Mgr.: M.F. Johnson; Sales Mgr.: Bill Linder. (DES—tape only)

Communication Arts Inc., 2526 27 Ave. S., Minneapolis 55406 Tel: 721-5357 (DES)

E M C Corp., 180 E. Sixth St., St. Paul 55101 Tel: 227-7366 Pres: David E. Feinberg, VP: Richard T. Stevens, Customer Sales Dir.: C. Carter (PRT)
Esco Artist, 2613 NE Garfield St., Minneapolis 55418. Tel: 789 5650. Owner: Jo Esco. (DES)

MISSOURI

● **KANSAS CITY (Area Code 816)**

Stage 3 Sound Prod'ns Inc., 12 E. 39 St. Zip 64111 Tel: 531-1375. (DES)

● **ST. LOUIS METROPOLITAN AREA (Area Code 314)**

Matthews Int'l Corp., 10866 Indian Head Ind'l Blvd. Zip 63132 Tel: 423-9800 Mgr: C. Gilbert (PRT—film masters, symbol consultation & testing)

Home office: Pittsburgh, Pa

MONTANA

● **MISSOULA (Area Code 406)**

Meadowlark Ventures—Graphic Design by Oolack, PO Box 7218 Zip 59807 Tel: 728-2180.

NEW JERSEY

● **ASBURY PARK (Area Code 201)**

Sound-Arts Co. Inc., 5 Cindly Ln. Zip 07712 Tel: 493 8666 Pres: Charles J. Gspann; VP: Francis M. Gspann. (DES)

● **CAMDEN (Area Code 609)**

Recorded Publ'ns Labs. (div. of Recorded Publ'ns Mfg. Co. Inc.), 1100 State St. Zip 08105. Tel: 963 3000; Phita. (215) 922 8558 Pres: David H. Goodman, Sales Mgr: Pat Landon; Adv. Mgr: Edward J. Goodman. (DES)

● **CARLSTADT (Area Code 201)**

Q-A-I Inc., 640 Dell Rd. Zip: 07072 Tel: 460-0060, NYC (212) 964-1714. Pres: Steve Dauman, Sales Mgr: George Ratowsky. (PRT).

● **CLIFTON (Area Code 201)**

Matthews Int'l Corp., 1151 Bloomfield Ave. Zip 07012 Tel: 473 7330 Mgr.: W. Hammond. (PRT—film masters, symbol consultation & testing)
Home office: Pittsburgh, Pa

● **COLLINGSWOOD (Area Code 609)**

Pauli Prods., PO Box 29 Zip: 08108. Tel: 547 8925 Pres: Joseph A. Pauli; VP: Zara May Pauli (PRT—tape only)

● **FARMINGDALE (Area Code 201)**

Charlie Roberts Advertising & Promos. Inc., Vat 69 Zip 07727. Tel: 938-4351. Pres: Robert Schumann, Gen. Mgr.: Charlie Roberts; Sales Mgr: Linda Chiaramonte (DES)

● **GLENDORA (Area Code 609)**

Record Room, 308 E. Evesham Rd. Zip 08029 Tel: 939 0034 (DES)

● **HAWORTH (Area Code 201)**

Trutone Recs., 163 Terrace St. Zip 07641. Tel: 385-0940 (DES, PRT)

● **LYNDHURST (Area Code 201)**

Color Seps-Litho Preps Serv., PO Box 151 Zip 07071 Tel: 438-6729. Pres: J.G. Principato (DES)

● **MONTCLAIR (Area Code 201)**

Linear Sound Rec'g, 211 Glenridge Ave. Zip 07042. Tel: 744 0686. Pres.: M. Kroll; Sales Mgr.: T. Steinmann. (DES)

● **PARK RIDGE (Area Code 201)**

Cadet Recs. Inc., 12 Maple Leaf Dr. Zip 07656. Tel: 391 3676 VP Sales & Mktg.: Robert K. Herrington (Sales office only) (DES, PRT)
Home office & plant: Los Angeles, Calif.

● **PENNSAUKEN (Area Code 609)**

Rand-El Advertising, 7249-A Browning Rd. Zip: 08109 Tel: 665-8611. (DES)

NEW YORK

● **BOHEMIA (Area Code 516)**

R H M Inds. Ltd., 180 Orville Or. Zip: 11716. Tel: 567-7222. NYC (212) 895-9344 (PRT)

● **CLARENCE (Area Code 716)**

Mark Custom Rec'g Serv., 10815 Boreline Rd. Zip. 14031 Tel: 759-2600 Pres & Sales Mgr: Vincent S. Modette (DES)

● **FARMINGDALE (Area Code 516)**

Pressure Sensitive Tape & Label Corp., 135 Schmitt Blvd. Zip 11735. Tel: 293 7300 (DES, PRT—tape only)
Shorewood Packaging Corp., 55 Engineers Ln. Zip 11735 Tel: 694-8230 (DES, PRT)
Home office: New York, N.Y.

● **GREAT NECK (Area Code 516)**

Ivy Hill Communications Inc., Community Or Zip: 11022 Tel: 487-0200 Pres: Ellis Kern (PRT)
Branches: Los Angeles, Calif., Terre Haute, Ind

● **HAUAPPAUGE (Area Code 516)**

Disc Graphics (div of Pickwick Int'l Inc.), 10 Gilpin Ave. Zip: 11787 Tel: 234-1400. (PRT)
Modern Album & Finishing Co. Inc., Cardinal Ind'l Park, Gilpin Ave. Zip 11787 Tel: 234 1100, NYC (212) 291 7600 Pres: G O Thomas; Sales Mgr: R.A. Froehlig (PRT)

Branches: Burbank (Los Angeles Metropolitan Area), Calif., Modern Album of California Inc., Terre Haute, Ind., Modern Album of Indiana Inc., Nashville, Tenn., Modern Album of Tennessee Inc.

Prestige Label Corp., 255 Oser Ave. Zip 11787 Tel: 273-0020. (PRT)

● **HOLBROOK (Area Code 516)**

Electrosound Group Inc., 725 Broadway Ave. Zip 11741 Tel: 567-3700 Corporate Pres: Richard H. Burkett, Pres.: Rec. Pressing Div.: Dick Meixner, Sales Mgr (east): Ron Roberto. Local plant: Goldsrec Rec'g Inc., Veterans Hwy & Broadway Zip: 11741. Tel: 589-0462; NYC (212) 895 6575. Pres: Richard Meixner, Sales Mgr.: John Finnegan; Adv. Mgr: Rich Renda. (PRT—record only)

Plants: Sun Valley (Los Angeles Metropolitan Area), Monarch Rec. Mfg Co., Shelbyville, Ind.; Allentown, Pa., Allentown Rec. Co. Inc

● **HUNTINGTON STATION (Area Code 516)**

Shelley Prods Ltd., 220 Broadway. Zip: 11746 Tel: 423-7090 (DES, PRT)

● **LINDENHURST (Area Code 516)**

Coastal Specialty Tapes Inc., 274 Bangor St. Zip 11757 Tel: 226-5900 Ops. Head & Sales Mgr: Oan Obobbs (DES, PRT—tape only)

● **MELVILLE (Area Code 516)**

Sound by Blachly, 69 Old East Neck Rd. Zip: 11747. Tel: 673-0330 Contact: Bill Blachly (DES)

● **NEW ROCHELLE (Area Code 914)**

Westchester Int'l Prod'ns Inc., 41 Rosedale Ave. Zip: 10801 Tel: 664-3099 NYC (212) 724 2880. Pres: Jon H. Starke, Gen. Mgr: William Starke, Sales Mgr.: Gloria Fingnan. (DES, PRT)

● **NEW YORK METROPOLITAN AREA (Area Code 212)**

A G I (Album Graphics Inc.), 125 W 55 St. Zip: 10019 Tel: 489-0793 TWX (710) 581-5597 VP Mktg.: Richard Block. (Sales office only) (DES)
Home office: Melrose Park (Chicago Metropolitan Area) Ill.

A. O. Adams Advertising Inc., 145 E. 52 St. Zip 10022 Tel: 755-0845 Pres: A.O. Adams (DES)
Branch: Woodbury, N.Y.

Album Graphics Inc., see AGI
Ampro Prod'ns Inc., 150 Fifth Ave. Zip 10011 Tel: 243-7726 Cable: TA PEXXRON Tel: 425233 (DES)

Apon Rec. Co. Inc., PO Box 3082, Steinway Sta., 44-16 Broadway, Long Island City 11103 Tel: 721-5599. Pres: Andrew M. Poncic, Sales Mgr: Roman Krawcow, Adv. Mgr: Oon Zemann. (DES)

Atwater Press Inc., 207 W 25 St Zip 10001. Tel: 675 2710 (DES, PRT)
James Bell Graphic Design Inc., 119 W 23 St. Zip 10011 Tel: 929-8855 Pres: James Bell, VP: S. Campbell; Sales Mgr: Jane Sapiro (DES)

G. Benson & Co. Printers Inc., 75 Spring St. Zip: 10012 Tel: 925-7100 Contact: Gerald J. Benson (DES, PRT)

Bert-Co. Ent's. Inc. (div of the Walter Reed Org. Inc.), 241 E. 34 St. Zip 10016 Tel: 683 6300 Cable: WALREAD Tel: 12227 Pres: Sheldon Gunsberg, Exec. VP: VP Finance & Treas: Christopher W. Preuster (Sales office only) (DES, PRT)

Branch: Los Angeles, Calif.
Ely Besalee Ltd., 235 E. 49 St. Zip: 10017 Tel: 759-7820 Pres: Ely Besalee. (DES)

Leo Bliok Advertising, 24 W. 57 St. Zip 10019 Tel: 245-8938 Owner: Leo Bliok. (DES—record only)

Creative Media Agency, 227 E. 69 St. Zip 10021 Tel: 472 0100 Pres & Creative Or: Arthur Krieger, Prod'n Mgr: Al Oouglas (DES)
O R G Recs. Inc., 200 W 57 St. Zip 10019 Tel: 582-3040 Cable: STETRECS TWX: (710) 581 4825 Pres: Hugh Fordin, Mng. Or: Rick Winter; Nat'l

Sales & Mktg. Dir. Ted Wolff (DES)
Disc Communications Ltd., 743 Fifth Ave. Zip: 10023 Tel: 371-0390. (DES, PRT)
Drate Design, 145 E. 52 St., Rm. 403 Zip: 10022 Tel: 751-2031. Pres. & Art Dir.: Spencer Orate. (DES—record only)
E R H Sales Corp., 221 W 57 St. Zip: 10019 Tel: 582-4200. Pres.: Lee Halpern, Gen. Mgr.: Michael Halpern. Sales Mgr.: Robert Shavelson (DES, PRT)
Electrosound Group Inc., 1290 Ave. of the Americas. Zip: 10019. Tel: 581-5641. (PRT—record only)
Home office: Holbrook, N.Y.
Farmlett & Barsanti, 1123 Broadway. Zip: 10010. Tel: 691-9398 (DES)
Great American Screen Designs Ltd., 230 Fifth Ave. Zip: 10001 Tel: 683 4077. (DES, PRT)
Guaranteed Printing Serv. Co., 119 W. 23 St. Zip: 10011 Tel: 929-2410 (DES, PRT)
Stephen P. Haas Advertising Art. 24 W 57 St. Zip: 10019 Tel: 581 8442. Pres.: Stephen Haas (DES)
Image Creators Inc., 310 E. 65 St. Zip: 10021. Tel: 535-0257. (DES)
Jewelle Signs & Letters, 13 E. 31 St., New York, N.Y. 10016 Tel: 473-1169. 683 4474. Design & Lettering Dir.: William Bank; Artwork Dir.: F. Frank (DES)
Lee-Myles Assocs Inc., 160 E 56 St. Zip: 10022 Tel: 758-3232 Cable LEE-MYLES. Pres.: Robert M. Miller, VP: Howard Roseff. (DES, PRT)
Mac Murray Press Inc., 230 W 17 St. Zip: 10011 Tel: 924 1530 Pres: Bernard Lerman; Sales Mgr.: Arnold Kohn (DES, PRT)
Olympic Litho Corp., 116 Nassau St., Brooklyn 11201 Tel: 522-2400 Pres Marvin O. Frankel; Gen. Mgr.: Herbert Farber (PRT—color separations)
P R C Rec'g Co. (div. of Richmond Rec'g Corp.), 1185 Ave. of the Americas. Zip: 10036. Tel: 997-1250. Pres.: Hugh Landy; VP & Sales Mgr.: David Grant (PRT)
Plants: Compton (Los Angeles Metropolitan Area), Calif., Richmond, Ind. Charlie Passantino Inc. 311 W 43 St., 5th fl. N.Y. 10036 Tel: 586 1469 Pilgrim Press Corp., 36 01 43 Ave., Long Island City 11101. Tel: 937 9515. (PRT)

Omel H Price Inc., 15 E 48 St. Zip: 10017 Tel: 755 1982 Acct Exec Mitchell Price (DES, PRT)
Progressive Label & Litho Co., 286 Stanhope St., Brooklyn 11237 Tel: 497 2320. Pres.: Jerome J. Road; Gen. Mgr.: Bernie Stein. (DES, PRT)
Promedeus Arts Inc., 1776 Broadway. Zip: 10019 Tel: 586-3770 Pres: Lew Morris; Sales Mgr.: Jerry Present; Adv. Mgr.: Ron Parisi (DES)
Queens Lithographing Corp., 52-35 Barnett Ave., Long Island City 11104 Tel: 457 7700 Chief Exec. Officer: Eric Kaitman; Pres: Leonard Verebay, Sr. VP Sales. Richard Roth (DES, PRT)
Branch: Hollywood (Los Angeles Metropolitan Area), Calif
Plant: Indianapolis, Ind., Rutgers Packaging Corp.
Recorded Publ's Labs (div. of Recorded Publ's Mfg Co Inc.), 2 Penn Plaza, Suite 1500. Zip: 10001. Tel: 868 3115. Eastern Reg'l Sales Mgr Lee Kallett. (Sales office only) (DES, PRT)
Home office: Camden, N.J.

Roman & Smith Assocs., 401 E. 89 St. Zip: 10028 Tel: 348-2852 Contacts Johanna Roman, Roscoe Smith. (DES, PRT)
Jasper Samuel Advertising & Recs. Inc., 60 E. 42 St., Suite 541 Zip: 10017 Tel: 490-2787. Pres.: Jasper Samuel. (DES)
Shepard Printing Corp., 111 Eighth Ave. Zip: 10011. Tel: 255-1930 (DES, PRT)
Shorewood Packaging Corp., 10 E. 53 St. Zip: 10022 Tel: 371-1500 Pres Paul Shore; Exec. VP Floyd S. Gliner, VP Special Projects Marc Shore, VP Nat'l Sales: Ken Rosenblum; VP West Coast Sales: Jim Palmer. (DES, PRT)
Branches: Los Angeles, Calif., La Grange, Ga., Farmingdale, N.Y.
Tri-Lon Color Lithographers Ltd., 54 W 21 St. Zip: 10010 Tel: 255 6140 Pres.: Morris Strickler, VP: David Strickler. (PRT)
Video Corp of America, 231 E. 55 St. Zip: 10022. Tel: 355 1600. (DES)
Visual Information Systems, 15 Columbus Circle. Zip: 10023 Tel: 541-8080 Pres: Jay Raeben, VP Prod'n & Programming: David Barnhizer; Gen Mgr.: Paul Gersh, Sales Mgr: Joe Scozzari (DES)
Warjo Promos., 145 W. 55 St., Suite 2E Zip: 10019 Tel: 245-7179 (DES, PRT)
Morton O Wax & Assocs., 1650 Broadway Zip: 10019 Tel: 247-2159 Pres Morton O Wax. Local branch: 200 W 51 St. Zip: 10019 (DES)

● **ROCHESTER (Area Code 716)**
Visual Horizons, 208 Westfall Rd. Zip: 14623. Tel: 424-5300. (DES)
Wakeup Promos., 194 Ripplewood Dr. Zip: 14616. Tel: 865 2307 (DES, PRT)
● **RONKONOMA (Area Code 516)**
Andrews-Munney Envelope & Paper Co., 2175 Fifth Ave. Zip: 11779 Tel: 467-2000. TWX: (510) 228-1095. Pres.: Stuart M. Andrews Jr., Sales Mgr.: John F. Muller Jr., Ass't Plant Mgr.: Robert J. Andrews (DES, PRT)
Home office: Holbrook, N.Y., Electrosound Group Inc.
Sales offices: Sun Valley (Los Angeles Metro Area), Calif., Monarch Rec Mfg. Inc., New York, N.Y., Electrosound Group Inc.
● **SPRING VALLEY (Area Code 914)**
Pro/Creatives Corp., 25 W Burda Ln. Zip: 10977 Pres. Sales & Adv Mgr Oud Rapp. (DES—record only)
● **TROY (Area Code 518)**
Wildwood Entertainment, 276 Fourth St. Zip: 12180. Tel: 273-7660. VP: Erich Borden (DES)
● **UTICA (Area Code 315)**
Oneida Video-Audio Tape Cassette Corp., 760 Blandina St. Zip: 13501 Tel: 735-6187. Pres.: Stanley Markowski. (DES & PRT—record only)

NORTH CAROLINA

● **CANTON (Area Code 704)**
Recording Servs. of Western North Carolina Inc., 10 Penland St. Zip: 28716 Tel: 648-6012. Owner: J. Ted Evans Jr. VP: Kay Evans (DES, PRT)
● **THOMASVILLE (Area Code 919)**
Adtees Corp., PO Box 608, Stanley Ave. Zip: 27360. Tel: 475-0111. (DES & PRT—customized tee-shirts only)

OHIO

● **AKRON (Area Code 216)**
Yoe-Yoe Studios, 174 Portage Dr. Zip: 44303 Tel: 836-2497 Contacts: Craig & Janet Yoe. (DES)
● **CINCINNATI (Area Code 513)**
Artists Rec'g Co. Inc., 320 Mill St. Zip: 45215 Tel: 761 0011 (DES)
Counterpart Creative Studios Inc., 3744 Applegate Ave. Zip: 45211 Tel: 661-8810 (PRT)

MAY 23, 1981 BILLBOARD

Alex Gellen Design, 405 Executive Bldg. Zip: 45202. Tel: 651-1308 Pres Alex Gellen (DES)
Jewel Rec'g Co., 1594 Kinney Ave. Zip: 45231 Tel: 522-9336. Pres.: Rusty York; Gen. Mgr.: Linda York, Sales Mgr.: Rollin Bennett Jr (DES—record only)
Q C A Custom Pressing, 2832 Spring Grove Ave. Zip: 45225 Tel: 681-8400 Pres: Edward R. Bosken, VP & Sales Mgr: Keith Myers, Plant Mgr: Ken Martin. (DES & PRT—record only)
Rite Rec. Prod'n Inc., 9745 Mangham Dr. Zip: 45215 Tel: 733-5533. Owner Carl J. Burkhardt, Pres.: Philip M. Burkhardt; VP Prod'n: Lan A. Ackley; VP Graphics: Kenneth O. Keith Jr.; Sales Mgr.: Dan Burton. (DES, PRT)
Studio Pressing Serv., 320 Mill St. Zip: 45215 Tel: 761-8294 Pres: B Hyrne. Sales Mgr.: M. Tye (DES, PRT)

● **CLEVELAND METROPOLITAN AREA (Area Code 216)**
Storycraft Inc., 18630 Detroit Ave., Lakewood 44107 Tel: 221-4722 (DES)
● **COLUMBUS (Area Code 614)**
Graphics of Columbus Inc., 5211 N High St. Zip: 43214 Tel: 846-6126 (PRT)
Hillsdale Recs., 948 Studer Ave. Zip: 43206 Tel: 252-7116. Owner & Pres Larry McKenzie (DES)
Roach Inc., PO Box 16548, 2255 Westbelt Dr. Zip: 43216 Tel: 876-9951 WATS (800) 848 7970 (outside Ohio) (DES & PRT—customized tee shirts only)
Branch: Sun Valley (Los Angeles Metropolitan Area), Calif

● **NEWARK (Area Code 614)**
Utopia Ultra-Sound, 38-40 S First St. Zip: 43055 Tel: 345 9426 Pres Robert H. Kirk Jr., VP: Don Shannon, Gen. Mgr: Robert H. Kirk Sr., Sales Mgr: Rose Shannon (DES)
● **YOUNGSTOWN (Area Code 216)**
United Audio Rec'g Studio, 5947 Stillson Pl. Zip: 44512 Tel: 758-5463 Pres: William Warner; Gen & Sales Mgr: Ray Nevel. (DES)

OKLAHOMA

● **TULSA (Area Code 918)**
C E S Rec'g Inc., 2500 N. Hemlock Circle, Broken Arrow 74012 Tel: 627 8474. Pres.: Basil W. Thomas; Gen. Mgr.: Judy McAlister, Mktg. Mgr.: Walter J. McKee Jr. (DES & PRT—tape only)
I T T Studios (International Teaching Tapes), 4235 S. Memorial Or. Zip: 74145. Tel: 663 7700. Pres: Meridith R. Gray, Sales Mgr: Sonny Gray (DES, PRT)
The Master Sound Inc., 8137 E. 46 St. Zip: 74145 Tel: 663-7186. Pres: Donald Boshears, Gen. Mgr. Peter Enns; Sales Mgr: Louis Threeton (DES)

OREGON

● **PORTLAND (Area Code 503)**
Northwestern Inc., Motion Pictures & Rec'g, 1224 SW Broadway Zip: 97205 Tel: 226-0170. Pres: Robert M. Lindahl, Sales Mgr.: Paul A. Buescher (PRT)

PENNSYLVANIA

● **ALLENTOWN (Area Code 215)**
Allentown Rec. Co. Inc. (sub. of Electrosound Group Inc.), 1002-10 Walnut St. Zip: 18102 Tel: 433-7405 (PRT—record only)
Home office: Holbrook, N.Y., Electrosound Group Inc.
Sales office: New York, N.Y., Electrosound Group Inc.
● **BETHLEHEM (Area Code 215)**
Mystic Oak Recs., 1 E Church St. Zip: 18018 Tel: 867-4300. (DES)
● **CARLISLE (Area Code 717)**
Inside Art, 80 York Rd. Zip: 17013 Tel: 243-1082 Chief Exec: Gail S. Gorden (DES)

● **MECHANICSBURG (Area Code 717)**
H R C Printing, PO Box 1152, 5252 E Trindle Rd. Zip: 17055 Tel: 766-0943. Gen Mgr: Donald E. Baldwin (DES, PRT)

● **PHILADELPHIA METROPOLITAN AREA (Area Code 215)**
Community Press, 6047-49 Woodland Ave. Zip: 19142. Tel: 729-4655 (DES & PRT—record only)
Kalstein Graphics, 6128 York Rd. Zip: 19141 Tel: 549-5085 (DES)
Matthews Int'l Corp., 3780 Main St. Zip: 19127 Tel: 483-6200 Mgr: R McCann. (PRT—film masters, symbol consultation & testing)
Home office: Pittsburgh, Pa.
UniComm Inc., 414 Swedeland Rd., King of Prussia 19406. Tel: 275-7100 Pres: J.L.C. Ulrich Jr., Gen Mgr: Robert G. Rowe Jr. (PRT—tape only)

● **PITTSBURGH (Area Code 412)**
George Heid Prod'n & AV Prods., 701 Washington Rd. Zip: 15228. Tel: 561-3399 (DES)
Matthews Int'l Corp., 1575 McFarland Rd. Zip: 15216 Tel: 341 4464 Chm & Pres: T.F. Purner Jr.; Symbol Mgr: M. Field Local branch: 1211 W Liberty Ave. Zip: 15226. Tel: 561-5120. Mgr: G Barefoot. (PRT—film masters, symbol consultation & testing)
Branches: La Palma, Calif., Atlanta, Ga., Chicago, Ill.; Braintree (Boston Metropolitan Area), Mass., St. Louis, Mo., Clifton, N.J., Philadelphia, Pa., Dallas, Tex.
Int'l branch: Canada, Bernard-Matthews Ltd

● **SCRANTON (Area Code 717)**
Keystone Printed Specialties Co. Inc., 321 Pear St. Zip: 18505 Tel: 346-1761 Pres: M.C. Fischer; Sales & Adv Mgr: Martin C. Fischer (DES, PRT)
● **SHARON (Area Code 412)**
Marjon Recs. Inc., 159 Easton Rd., Hermitage 16146 Tel: 347 4726 Pres John T. Kznancic, Sales Mgr: Martha Kznancic, Adv Mgr: Ruth Toth (DES, PRT)

PUERTO RICO

● **CIDRA (Area Code 809)**
near Prods. of Puerto Rico, PO Box AB Zip: 00639 Tel: (809) 739-8435 (DES, PRT)

RHODE ISLAND

● **WARWICK (Area Code 401)**
Great Graphics!, PO Box 3, Zip: 02887. 151 Keeley Ave. Zip: 02886. Tel: 738-8877. Owner & Pres.: Bill Montella Jr (DES, PRT)

SOUTH CAROLINA

● **COLUMBIA (Area Code 803)**
Howard Knight Ents. Inc., 2424 Pleasant Ridge. Zip: 29209 Tel: 783-0325 (DES, PRT)

TENNESSEE

● **FAYETTEVILLE (Area Code 615)**
Kim-Pat Ents., PO Box 654, Hillwood Dr. Zip: 37334 Tel: 433-2323/5661 (DES)
● **MEMPHIS (Area Code 901)**
T-Shirts Int'l, 239 S Cooper St. Zip: 38104 Tel: 522-8383 (DES, PRT)
● **NASHVILLE METROPOLITAN AREA (Area Code 615)**
Album Globe Dist'n Co. Inc., City Square, 260 W Main, Suite 107, Hendersonville 37075. Tel: 824 9100. Pres: Mike Shepherd, Adv. Mgr.: Keith Stewart (DES, PRT)
American Sound Recs./Emerald Recs., 62 Music Square W. Zip: 37203 Tel: 327 4538. Pres: Cliff Ayers Ostermeyer, Sales Mgr: Chris Ostermeyer. Gen & Adv Mgr: Connie L. Wright, PR: Alma Lee Combs (DES)
Chumley Prod'n, PO Box 100823, 2802 Foster Ave. Zip: 37210 Tel: 833 6184. Pres: P.E. Chumley (PRT—record only)
Color Graphics Inc., 305 Church St., Goodlettsville 37072. Tel: 859 4001 (DES, PRT)
Creative Concepts, Faron Young Exec. Bldg., 1300 Division St., Suite 106 Zip: 37203 Tel: 259 3790 Partners: Jim Kent, Vernell Hackett (DES, PRT)
Custom Tape Dupl'r Inc., 341 Hill Ave. Zip: 37210 Tel: 256-1728. Pres: L.C. Tant, Sales Mgr: Mike Tant (DES, PRT—tape only)
Gusto Recs & Tapes, 220 Boscobel St. Zip: 37213 Tel: 256-1656 TWX '810) 371 1055 Pres & Sales Mgr: Moe Lytle, Gen Mgr: Steve Kouzntz man (DES, PRT)
M F P Inc., 453 Chestnut St. Zip: 37203 Tel: 256-6161. (PRT—record only)
Modern Album of Tennessee Inc., 457 Chestnut. Zip: 37203. Tel: 255 7461. (PRT)
Home office: Hauppauge, N.Y., Modern Album & Finishing Co. Inc. Nashville Album Prod'n Inc., 101 Music City Circle. Zip: 37203 Tel: 883-2153 (DES, PRT)
Pinwheel Art & Photography Studios Inc., 1211 16 Ave. S. Zip: 37212 Tel: 327 9125 (DES)
Professional Mktg Serv. Inc., 50 Music Square W., Suite 907, Nashville, Tenn 37203. Pres: Oee Mullins (DES)
Sea Cruise Prod'n, PO Box 110830, Zip: 37211. Tel: 834 1856 Pres & Adv Mgr: Ken Keene, VP & Gen Mgr: F.V. Guzzo, VP & Sales Mgr: Gene Miller (DES)
Superior Sound Studios, 329 Rockland Rd. Hendersonville 37075 Tel: 824 5141 (DES)
Harrison Tyner Int'l Inc., 38 Music Square E., Suite 115 Zip: 37203 Tel: 244 4224 Owner & Pres: Harrison Tyner, Sales Mgr: Dallas Laird, Adv Mgr: Kevin McMaster (DES)
United Rec. Pressing Inc., 453 Chestnut Zip: 37122 Tel: 259-9396 (DES, PRT—record only)
Wilkins Printing Co., 417 Commerce St. Zip: 37219. Tel: 256-7125 VP Sales: Udolet Fortner (PRT)

● **DALLAS (Area Code 214)**
Electronic Technological Inds. of America Inc., PO Box 1580 Zip: 75221 Tel: 827 8002 Bd Chm: John Kanter, Gen Mgr: Oavid Coleman, Sales Mgr: Larry Pearson (DES, PRT)
Matthews Int'l Corp., 7715 Sovereign Row. Zip: 75247 Tel: 631-8240. Mgr: G. Motley (PRT—film masters, symbol consultation & testing)
Home office: Pittsburgh, Pa.
Rainbow Sound Inc., 1322 Inwood Rd. Zip: 75247 Tel: 638 7712 Pres: Bob Cline, Exec. VP: Jack Whit (DES—record only)

TEXAS

● **FORT WORTH AREA (Area Code 817)**
Ink Inc., PO Box 946, Springtown 76082 Tel: 433 5720 Pres: James Michael Taylor, Sales Mgr: Charles Bowles, Adv Mgr: Barbara Anne Taylor (DES)
● **HOUSTON (Area Code 713)**
Riverside Albums, 7400 Pinemont Zip: 77040 Tel: 462 2700 VP: Earl Thomas, Sales Mgr: Brenda Cox (DES, PRT)
● **SAN ANTONIO (Area Code 512)**
Joy Rec. Mfg., 6703 W Commerce. Zip: 78227 Tel: 432-7893 (DES)
Telex Rec. Mfg. Inc., 1422 W. Poplar. Zip: 78207 Tel: 733-6138 Pres: C. Foy Lee, Gen Mgr: Jimmy Burton, Sales Mgr: Jeannie Hill (DES, PRT)
● **SAN BENITO (Area Code 512)**
Rio Grande Music Co., 119 S. Sam Houston Blvd. Zip: 78586. Tel: 399-5377 Sales Mgr: John F. Phillips (DES—record only)

● **WACO (Area Code 817)**
Creative Communications Inc. (sub. of SMI), 918 N. Valley Mills. Zip: 76710 Tel: 776-6553. (DES)
Mike's Print Shop, 2507 Grim Zip: 76707 Tel: 752 2321 Owner: Mike Stanley (PRT)
Charles Wallis Inc., 4700 W. Waco Dr. Zip: 76710 Tel: 776-5113. Pres: Charles Wallis; Gen Mgr: Roger Lindstrom (DES)

UTAH

● **SALT LAKE CITY (Area Code 801)**
Covenant Rec'gs Inc., PO Box 26817, 1345 Major St. Zip: 84126. Tel: 487 1096. Pres.: V. Lewis Kofford; Adv. Mgr: Jeff Lund (DES)

VIRGINIA

● **ALDIE (Area Code 703)**
Solar Sound Prod'n (div. of VEE Corp.), Box 98. Zip: 22001 Tel: 471 5359. Bus. Mgr: Frank Adair (PRT)

WISCONSIN

● **ELKHART LAKE (Area Code 414)**
Sohn Mfg. Inc., Box X Zip: 53020. Tel: 876 3361. (DES, PRT)
● **MILWAUKEE METROPOLITAN AREA (Area Code 414)**
Audio Cassette Dupl'r's of Wisconsin, 159 E Silver Spring Or. Zip: 53217. Tel: 961-1635. Pres.: J. Shutter; Gen. Mgr.: G. Miller; Sales Mgr.: J. Stoeker (DES)

Holubek Studios Inc., 4712 N. 125 St., Butler 53007 Tel 781-4800. WATS (800) 558-0566 Nat'l Sales Mgr. David W. Bruns (DES & PRT—iron-on transfers & customized tee-shirts only)

WYOMING

• CHEYENNE (Area Code 307)

Rocky Mountain Rec'g, 8305 Christensen Rd. Zip 82001 Tel 638-8733 Pres. Ray Alexander, Sales & Adv. Mgr. Georgia Alexander (DES, PRT)

2

CUSTOM DUPLICATORS/ PACKAGING & LABELING

Audio and Video lines indicate which configurations the firms duplicate. Companies which offer packaging and labeling of tape product are indicated by "(PKG)" which appears after the main body of their listings.

ALABAMA

• MUSCLE SHOALS (Area Code 205)

Fame Rec'g Studios Inc., 603 E. Avalon Ave. Zip 35660 Tel 381-0801
Audio: Cassette, open reel

ARIZONA

• PHOENIX (Area Code 602)

Audio-Video Rec'rs of Arizona Inc., 3830 N. Seventh St. Zip: 85014. Tel: 277-4723

Audio: Cassette, open reel.
Video: 1/2" U-matic cassette, 1/2" Beta & VHS cassette
General Cassette Corp., 2311 N. 35 Ave. Zip: 85009 Tel: 269-3111 (PKG—audio & video)

Audio: 8 tr., cassette
Universal Audio Corp., 7244 E. Indian School Rd., Scottsdale 85251 Tel 949-7577

Audio: 8 tr., cassette, open reel

• TUCSON (Area Code 602)

Kyric Corp., 2111 E. 20 St. Zip 85719 Tel. 624-2408 Pres. & Sales Mgr. Keyran Mokhtarian (PKG)
Audio: 8 tr., cassette, open reel

CALIFORNIA

• ANAHEIM (Area Code 714)

Certron Corp., 1701 S. State College Blvd. Zip 92806. Tel 634-4280 TWX (910) 593-1611
Audio: 8 tr., cassette

Harry McCune Sound Serv. Inc. 1773 W. Lincoln Ave. Zip 92801 Tel 533-7650, LA (213) 656-0112 Pres: Harry McCune Jr.; Gen. Mgr.: Herbert Shor (Sales office only) (PKG)
Home office: San Francisco, Calif.
Audio: Cassette, open reel
Video: 1/2" U-matic cassette

• CAMPBELL (Area Code 408)

Westape, 503-B Vandell Way Zip 95008 Tel 379-0871 Sales Mgr. Rich Krueger
Audio: Cassette

• HUNTINGTON BEACH (Area Code 714)

Tapette Corp., 15702 Producer Ln Zip 92649 Tel 638-7960 Pres. Jim Neiger II, Video Div. Sales Mgr. John Miles, Audio Div. Special Accts. Mgr. Bob Sheehy, Customer Servs. Mgr. Mary Deery (PKG)

Audio: Cassette, open reel
Video: 1" helical, 1/2" U-matic cassette, 1/2" Beta & VHS cassette

• LOS ANGELES METROPOLITAN AREA (Area Code 213)

A G I (Album Graphics Inc.), 424 N. Larchmont Blvd Zip 90004 Tel 462-0821 (Sales office only) (PKG only—audio & video)
Home office: Melrose Park (Chicago Metro Area), Ill

A S R Rec'g Servs. Inc., 8960 Eton Ave., Canoga Park 91304 Tel 341-1124 VP Sales Howard Shapiro, Gen. Mgr. Robert Goldman (PKG)

Home office: Glen Rock, N.J.
Audio: 8 tr., cassette, open reel
A T & T (Able Turntable & Tape) Rec'g Inc., 725 N. Highland Ave., Hollywood 90038 Tel 933-5701 Pres. James Carroll, Sales Mgr. Renny Kelly (PKG)

Audio: 8 tr., cassette, open reel
Abbey Tape Dupl'rs Inc., 5358 Cartwright Ave., North Hollywood 91601 Tel 985-3136 Pres. Norman C. Cooke (PKG)

Audio: Cassette, open reel
Able Turntable & Tape, see AT&T
Album Graphics Inc., see AGI
Audio Encounter, 9614 Cozycroft Ave., Unit H, Chatsworth 91311 Tel 998-7455 Pres. Elinore Freeland
Audio: Open reel

Bert Co. Ent's Inc. (div. of the Walter Reade Org. Inc.), 1855 Glendale Blvd Zip 90026 Tel 665-5137. (PKG only)
Home office: New York, N.Y.

Cadet Recs Inc., 5810 S. Normandie Ave. Zip. 90044 Tel. 753-5121 Pres. Jules Bihari, Mgr. Don Macmillan (PKG)
Branch: Park Ridge, N.J.

Audio: 8 tr., cassette
Columbia Rec. Prod'ns., 1801 Century Park West, Century City 90067 Tel 556-4700 (Sales office only)
Plants: Santa Maria, Calif., Terre Haute, Ind., Pitman, N.J.

Audio: 8 tr., cassette
Custom Dupl'n Inc., 6330 36 Arizona Circle Zip 90045 Tel 670-5575 Pres. Leonard Gross Sales Mgr. Bob Hively, Prod'n. Jeri Gonzales (PKG)
Audio: 8 tr. cassette

Video: 1/2" Beta & VHS cassette
Custom Rec. Mfg. Co. 5810 S. Normandie Ave. Zip 90044 Tel 753-5121 Pres. Jules Bihari VP. Don Macmillan (PKG)
Audio: 8 tr. cassette, open reel

D A K Inds. Inc., 10845 Vanowen St., North Hollywood 91605 Tel 984-1559 WATS (800) 423-2636 Cable OAKENT Telex 651396 Pres. Drew Alan Kaplan (PKG)
Audio: Cassette

E M C Corp., 6855 Santa Monica Blvd., Hollywood 90038 Tel 463-3282 (Sales office only) (PKG)
Home office: St. Paul (Minneapolis-St. Paul Metro Area) Minn

Audio: Cassette, open reel
Excalibur Video Systems Inc., 4015 Wilshire Blvd Zip 90010 Tel 384-5175 (PKG)

Video: 1" type C open reel, 1/2" U-matic cassette, 1/2" VHS cassette
H I Ent's Inc., 9537 Teistar Ave., Suite 121, El Monte 91731 Tel 444-9224 (PKG)

Audio: Cassette, open reel
Ivy Hill Graphics & Packaging (div. of Ivy Hill Communications Inc.), 4800 S. Santa Fe Ave. Zip 90058 Tel 587-3131 Exec. VP. Russell Muir, Gen. Mgr. Del Eaton, Sales Mgr. Arthur Kern (PKG only)

J & I Cassette, 23947 Ventura Blvd., Calabasas 91302 Tel 992-6200 Pres. John F. Brennan, Sales & Adv. Mgr. Ivy Brennan (PKG—audio & video)
Audio: Cassette

M C A Whitney Rec'g Studios Inc., 1516 W. Glenoaks Blvd., Glendale 91201 Tel 245-6801 VP & Gen. Mgr.: Brent Albright, Tape Dupl'g Mgr. Ted Glover
Audio: Cassette, open reel

M L Tape Dupl'g, 16834 Superior St., Sepulveda 91343 Tel 988-2737 Co. Owners Bill & Carol Ball, Pres. Bill Ball, VP. Carol Ball, Gen. Mgr. Mike Hathaway, Sales Mgr. Susan Castle (PKG)

Audio: 8 tr. cassette
Video: 1/2" U-matic cassette, 1/2" Beta & VHS cassette
Modern Album of California Inc., 3116 Vanowen St., Burbank 91505 Tel 845-7655 Pres. William S. Pine, Sales Mgr. Raymond Gardocki (PKG only—audio & video)

Home office: Hauppauge, N.Y., Modern Album & Finishing Co. Inc.
Montclair Studios, 13755 Bayliss Rd Zip 90049 Owner & Pres. Wallace Todd, Studio Mgr. & Chief Eng. Miriam Todd (PKG)

Audio: 8 tr., cassette, open reel
Video: 1/2" Beta & VHS cassette
North American Tape Dupl'g Co., 15414 Cabrito Rd., Van Nuys 91406 Tel 781-7650 VP & Gen. Mgr. Norm Teter; Mktg. Dir. Larry Stagnaro (PKG)

Audio: 8 tr., cassette
Professional Cassette Equip., 2909 Ocean Park Blvd. Santa Monica 90405 Tel 450-4499 (PKG)
Audio: Cassette

R C A Recs., 6363 Sunset Blvd., Hollywood 90028 Tel 468-4000 (Sales office only)
Home office: New York, N.Y.

Plant: Indianapolis, Ind.
Audio: 8 tr., cassette
Radio Central, 427 W. Fifth St., Suite 611 Zip 90013 Tel 626-9891 (PKG)
Audio: Cassette, open reel

Martin Roberts & Assocs. Inc., 270 N. Canon Dr., Suite 103, Beverly Hills 90210 Tel 273-0381. (PKG)

Audio: Cassette
See Hear Inds. (div. of RJA Inc.), 120 W. 155 St., Gardena 90248 Tel 516-0315 Pres. Ray Jacobs, Dupl'n Sales Mgr. Stan Gerstein (PKG—audio only)

Audio: 8 tr., cassette, open reel
Video: 1/2" U-matic cassette, 1/2" Beta & VHS cassette
Shorewood Packaging Corp., 1830 Glendale Blvd Zip 90026 Tel 660-3043 VP Sales Jim Palmer (PKG only—audio & video)

Home office: New York, N.Y.
Sound/Pro Inds. Inc., 7529 Trasic Ave., Playa del Rey 90291 Tel 822-0510 Pres. Donald K.M. Rothgery; Nat'l Mktg. Dir.: Don Millard, Sales Mgr. Tom Reed, Adv. Mgr. Linda Newton (PKG)

Audio: 8 tr., cassette
Studer Revox America Inc., 14046 Burbank Blvd., Van Nuys 91401 Tel 780-4234 Contact: Bill Van Doren
Home office: Nashville, Tenn.

Audio: Open reel
Superscope Inc., 22459 Paul Revere Dr., Woodland Hills 91364, Tel 998-9333 x 2090 Pres. Joseph Tushinsky; Mktg. & Sales Mgr. Bill Rosen (PKG)

Audio: Cassette
Tape A Thon Corp./Cavox Stereo Prod'ns, 502 S. Isis Ave., Inglewood 90301 Tel 776-6933 WATS (800) 421-1029 Pres. Lee Tate, Sales Dir. Robert Mayfield (PKG)

Audio: Cassette, open reel, NAB cartridge
Tape Specialty Inc., 13411 Saucy St., North Hollywood 91605 Tel 786-6111 Pres. Steve Feldman, Gen. Mgr. Len Feldman, Chief Eng. Stu Feldman
Audio: 8 tr., cassette

Video: 1/2" Beta cassette
Trans American Video Inc., 1541 N. Vine St., Hollywood 90028 Tel 466-2141 (PKG)
Video: 2" quad

U S Video, 1136 N. Highland Ave., Hollywood 90038 Tel 464-7579 Exec. VP. Dave Hancock, VP Sales Robert Creamer
Video: 2" quad, 1" type C, open reel, 1/2" U-matic cassette, 1/2" Beta & VHS cassette

Valley Video, 4209 W. Burbank Blvd., Burbank 91505 Tel 841-2387 Owner & Chief Eng. Robert Simonton, Sales Mgr. Mary Simonton
Video: 1/2" EIAJ open reel, 1/2" U-matic cassette, 1/2" Beta & VHS cassette

Video Rec. Albums of America/Vine Street Video Centre, 8471 Universal Plaza, Universal City 91608, Tel: 462-1099 Pres. Troy Cory; Gen. Mgr. Baines Prescott, PR Sales: Lynn Mann
Audio: Cassette

Video: 2" quad, 1" helical, 1/2" U-matic cassette, 1/2" Beta & VHS cassette
Virco Rec'g Inc., 700 S. Date Ave., Alhambra 91803 Tel 283-1888 Mktg. Dir. Nyall R. London
Audio: Cassette, open reel

West American Sound, 8120 Webb Ave., North Hollywood 91605 Tel 768-6100 Pres. Frank Oay, VP. Paul Hayes, VP. Mktg. Paul Adams, Reg'l. Sales Mgr. Robert Sheehy (PKG)

Home office: Warren (Detroit Metropolitan Area), Mich., American Sound Corp.
Branches: Atlanta, Ga., American Sound Atlanta, Closter, N.J., American Sound
Audio: 8 tr., cassette, open reel

• MONTCLAIR (Area Code 714)
Phylco Audio, 4709 Brooks St. Zip 91763 Tel 621-9561 Owner Robert Deates, Gen. Mgr. Rick Deates
Audio: Cassette, open reel

• OCEANSIDE (Area Code 714)
Exxel Co., 1907 Apple St. Zip 92054 Tel 439-3020 Pres. J. Richard Lee, Gen. Mgr. Bill Kottcamp (PKG)
Audio: Cassette, open reel

• SACRAMENTO (Area Code 916)
Bill Rase Prod'ns Inc., 955 Venture Court Zip 95825 Tel 929-9181 Owner & Pres. Bill Rase (PKG)
Audio: Cassette, open reel

Video: 1/2" EIAJ open reel, 1/2" U-matic cassette, 1/2" Beta & VHS cassette

• SAN DIEGO (Area Code 714)
Studio West, 5042 Rufner St. Zip 92111 Tel 277-4714
Audio: Cassette

• SAN FRANCISCO & BAY AREA (Area Code 415)
Kenneth A. Bacon Assocs. 216 Montego Key Novato 94947 Tel 883-5041 Owner Kenneth A. Bacon, Prod'n Mgr. Rick Bacon
Audio: Cassette, open reel

Coast Rec'rs, 1340 Mission St. Zip: 94103 Tel 864-5200 (PKG)
Audio: Cassette, open reel
Command Prod'ns, PO Box 26348 Zip 94126 Tel 332-3161 Pres. Warren Weagant; VP. Kitt Weagant, Sales Mgr. John Edwards.
Audio: Cassette, open reel.

Cory Sound Co. 310 Townsend Zip 94107 Tel 543-0440 Contact: Phillip Markinson. (PKG)
Audio: Cassette, open reel.

Fred Fox Music Co., 406 Kehoe Ave., Half Moon Bay 94019. Tel 726-3725 Pres. F.H. Nesbitt, Sales Mgr. V.A. Nesbitt
Audio: 8 tr., cassette, open reel
Video: 1/2" Beta & VHS cassette

Cathy Furniss & Assocs., 680 Beach St., Suite 445 Zip 94109 Tel 885-2807 Pres. Cathy Furniss Adv. Mgr. Isabelle Aggson
Audio: Cassette

The Gate, 351 G St., San Rafael 94901 Tel 777-2700 Pres. Don Geis, Gen. Mgr. Mary Geis, Sales Mgr. Pattie Geis, Chief Eng. John Geis
Audio: Open reel

Highland Labs., 840 Battery St. Zip 94111 Tel 981-5010 (PKG)
Video: 2" quad 1" helical, 1/2" U-matic cassette, 1/2" Beta & VHS cassette

Mann Endless Cassette Inds. Corp., PO Box 1347 Zip 94101 Tel 221-2000 Pres. Donald Mann, Sales Mgr. Robert Wells, Adv. Mgr. Bob Kline
Audio: Cassette (standard & "endless" types)

Harry McCune Sound Serv. Inc., 951 Howard St. Zip 94103 Tel 777-2700 (PKG)
Branch: Anaheim, Calif.
Audio: Cassette, open reel
Video: 1" open reel, 1/2" EIAJ open reel, 1/2" U-matic cassette

New England's LARGEST Duplicator!

(203) 325-1541
TWX-710-474-3334

With your apex printer you'll print label copy right on your cassette.

Save time, money, trouble, space.
Eliminate inventory problems, costly label overruns,
Save 3¢ or more per cassette



Distributed in the U.S.
and worldwide by



1290 Avenue of the Americas
New York, New York 10019
Telephone: 212-582-4870
Telex: 12-6419

Pacific Int'l Magnetics Inc. 185 Berry St. Zip. 94107 Tel. 495 8830 (Sales office only) (PKG—audio & video)
Home office: Richmond, B.C., Canada
Audio: Cassette, open reel.

Recortec Inc., 475 Ellis St., Mountain View 94043 Tel: 962 0220 TWX (910) 379-5022 Pres. Dr. Lester H. Lee; Sales Mgr.: Ron R. Troxell
Audio: Cassette, open reel

Sonic Arts Corp., 665 Harrison St. Zip. 94107 Tel: 781-6307 Pres. Leo de Gar Kulkka; Gen. Mgr.: Herbert P. Haas (PKG)
Audio: Cassette

Stanford Int'l, PO Box 609, 569 Laurel St., San Carlos 94070 Tel: 592 5958 Pres.: Fred Dobbs; Dpns. Mgr.: Jan Dillard (PKG)
Audio: Cassette

Mark Starr Corp., 1609 64 St., Emeryville 94608 Tel: 658 0109 Pres.: Gary W. Wood (PKG)
Audio: Cassette

Television Assocs. Inc., 2410 Charleston Rd., Mountain View 94043 Tel: 967-6040 Pres. Ed Carlstone (PKG)
Video: 2" quad, 1" type C open reel, 1/2" EIAJ open reel, 1/4" U-matic cassette, 1/2" Beta & VHS cassette

● **SAN JOSE (Area Code 408)**
Audodyne Co., PO Box 825 Zip 95106 Tel: 287 3520 Pres.: Louis R. Chiaramonte
Audio: 8 tr., cassette, open reel
M J S, 2514 Seaboard Ave. Zip. 95131 Tel: 262 8793 Dwner: Michael Steiner
Audio: Cassette

● **SANTA CLARA (Area Code 408)**
Shur-Sound & Sight Inc., 3350 Scott Blvd, Bldg No 5, Zip: 95051 Tel: 727 7620 VP & Gen. Mgr.: Glenn Cardon; VP Sales: Lonnie Cory (PKG)
Audio: 8 tr., cassette, open reel.

● **SUNNYVALE (Area Code 408)**
Respond Int'l Recs Inc., 1190 Miraloma Way, Suite Y, Zip: 94086 Tel: 245 1351 Cable: RESPOND TWX (910) 339-9317, Pres.: Ronald L. Akin.
Audio: 8 tr., cassette
Video: 1/2" Beta & VHS cassette

COLORADO

● **DENVER AREA (Area Code 303)**
Aspen Ltd., 77 E. Floyd Ave., Englewood 80110 Tel: 789-2239 Pres. Sid Laks; Sales Mgr.: Bill Bystrom; Adv. Mgr.: K. Davis
Audio: 8 tr.

Soundmark Corp., 4950 Nome St., Unit C Zip: 80239 Tel: 371 3076 (PKG)
Audio: Cassette, open reel

CONNECTICUT

● **DARIEN (Area Code 203)**
George Alexander Group Inc., 1063 Post Rd. Zip: 06820 Tel: 655 7791, NYC (212) 886-5600 (PKG—audio only)

● **NORWALK AREA (Area Code 203)**
Cook Labs. Inc., 375 Ely Ave., South Norwalk 06854 Tel: 853 3641 Pres.

Emory Cook, Adv. Mgr.: Frank Stall (PKG)
Audio: Cassette

● SOUTHPORT (Area Code 203)

Sound Innovations, 290 Bronson Rd. Zip: 06490 Tel: 259-0467 Dwner & Eng.: John Arcotta; Gen. Mgr.: Frank Baldissero; Sales Mgr.: Steve Kru-terine (PKG)

Audio: Cassette, open reel
Video: 1/4" U-matic cassette, 1/2" Beta & VHS cassette

● STAMFORD (Area Code 203)

P & P Studios Inc., 17 Voaduct Rd. Zip: 06907 Tel: 327-9204 Bd. Chm.: Terry L. Puffer; Pres.: John R. Fishback (PKG)

Audio: Cassette, open reel.

Tapecom Inc., 45 Jefferson St. Zip: 06902 Tel: 325-1541 TWX (710) 474-3334 Pres.: Gene Tornatore; VP: Fred Lummo (PKG)

Audio: 8 tr., cassette, open reel.

● UNION CITY (Area Code 203)

A. C. Hampson Printing Co. Inc., PO Box 97 Zip: 06770 Tel: 729-2294 Pres.: Augustus D. Hampson; Sales Mgr.: John W. Berry (PKG only—audio)

DELAWARE

● WILMINGTON AREA (Area Code 302)

E. I. du Pont de Nemours & Co. Inc., Magnetic Prods. Div., Photo Prods. Dept., du Pont Airport, Bldg 1 Zip: 19898 Tel: 774 1000 (PKG only)
Ken Del Prods. Inc., 111 Valley Rd., Richardson Park 19804 Tel: 655 7488 (PKG)

Audio: 8 tr., cassette, open reel
Video: 1/4" U-matic cassette, 1/2" Beta & VHS cassette.

National Tape Dupl'rs, see Ken-Del.

DISTRICT OF COLUMBIA

● WASHINGTON (Area Code 202)

Lion Rec'g Servs. Inc., 1905 Fairview Ave. NE Zip: 20002 Tel: 832-7883 Pres.: Harold H. Lion; Sales & Adv. Mgr.: Jim Fox (PKG)

Audio: Cassette, open reel.

Vidcom Corp./Ari-Gem Dupl'ns, 1101 15 Ave. NW Zip: 20005 Tel: 223-2986

Video: 1/2" EIAJ open reel, 1/4" U-matic cassette, 1/2" Beta & VHS cassette

FLORIDA

● MIAMI METROPOLITAN AREA (Area Code 305)

Allison-Alhambra Recs. Inc., 4380 NW 128 St. Zip: 33054 Tel: 658 8396 Telex: 522178

Audio: 8 tr., cassette, open reel

Miami Tape Inc., 8180 NW 103 St., Hialeah Gardens 33015 Tel: 558 9211 (PKG)

Audio: 8 tr., cassette.

Musical Tapes Inc., 770 W. 27 St., Hialeah 33010 Tel: 885-9156 Pres.: Eliseo C. Valdes

Audio: 8 tr., cassette.

Tape Dupl'rs of Florida Inc., 785 W. 83 St., Hialeah 33014 Tel: 822 7585 (PKG)

Audio: 8 tr., cassette.

● ORLANDO AREA (Area Code 305)

Christian Dupl'ns Inc., 1710 Lee Rd. Zip: 32810 Tel: 299-7363 (PKG)

Audio: Cassette

Magnetix Corp., 770 W. Bay St., Winter Garden 32787 Tel: 656 4494 Pres.: John Lory (PKG)

Audio: 8 tr., cassette, open reel

● POMPANO BEACH (Area Code 305)

Trackmaster Inc., 1310 S. Dixie Hwy. W. Zip: 33060 Tel: 943 2334 Pres.: Roy Parsons; Sec'y-Treas.: Lupe Parsons

Audio: 8 tr., cassette

GEORGIA

● ATLANTA (Area Code 404)

American Sound-Atlanta Corp., 2091 Faulkner Rd. NE Zip: 30324, Tel: 633-4577 Gen. Mgr.: Matt Polakoff; Sales Mgr.: Peter Thomason.

Home office: Warren (Detroit Metro Area), Mich., American Sound Corp.
Audio: 8 tr., cassette (audio & computer)

Atteram Prods. Inc., 212 Roswell Rd. NE, Marietta 30305 Tel: 428-5336 (PKG)

Audio: Cassette

Doppler Studios Inc., 1922 Piedmont Circle NE Zip: 30324 Tel: 873 6941
Audio: Cassette, open reel

Falcone Int'l Inc., 404 Clay St., Marietta 30060 Tel: 427 9496
Video: 2" quad, 1" type C open reel, 1/4" U-matic cassette, 1/2" Beta & VHS cassette

Project 70 Audio Servs. Inc., 1127 Spring St. NW Zip: 30309 Tel: 875 7008 (PKG)

Audio: Cassette, open reel

● LA GRANGE (Area Code 404)

S P C Co. (div. of Shorewood Packaging Corp.), 1707 Shorewood Dr. Zip: 30240 WATS Tel: (800) 241-0186 Plant Mgr.: Ken McCabe. (PKG only—audio & video)

Home office: New York, N.Y., Shorewood Packaging Corp

HAWAII

● HONOLULU (Area Code 808)

Musicassette Dupl'rs of Hawaii, PO Box 22190 Zip: 96822 Tel: 533-4165 (PKG)

Audio: Cassette, open reel

P S C Prods., 985 Waimanu St. Zip: 96814 Tel: 537-5695 Pres.: Michael Tanaka (PKG)

Audio: Cassette, open reel

ILLINOIS

● CHICAGO METROPOLITAN AREA (Area Code 312)

A G I (Album Graphics Inc.), 1950 N. Ruby St., Melrose Park 60160 Tel: 344-9100 TWX (910) 226-0417 Pres.: Donald W. Kosterka; Sales Mgr.: Kevin McKenna (PKG only)

Sales offices: Los Angeles, Calif., New York, N.Y.

Album Graphics Inc., see AGI



Manufacturers
of
Quality
Products
to the
Tape
Industry

**REVIEW
ENTERPRISES,**
(USA), INC.

AUDIO CASSETTES

C-O CASSETTES

BLANK CASSETTES

CASSETTE DUPLICATING TAPE

PRIVATE BRANDING AVAILABLE

VIDEO CASSETTES

C-O CASSETTES

BLANK CASSETTES VHS & BETA

PRIVATE BRANDING AVAILABLE

IMMEDIATE DELIVERY AVAILABLE
FROM OUR REGIONAL WAREHOUSES

R

Contact **MIKE THALER**

REVIEW
ENTERPRISES, (USA), INC.

54 W. 39TH STREET • NEW YORK, NY 10018 • (212) 840-2780

Audio Accessories Co., 38 W 515 Deerpath Rd., Batavia 60510 Tel: 879-5998 Sales Mgr.: John S. Maloney (PKG)
 Audio: 8-tr. cassette, open reel

Audio Artists Ltd., PO Box 7, Wheaton 60187, 429 St. Charles Rd., Carol Streams 60187, Tel: 668-6682 (PKG)
 Audio: Cassette, open reel

Bell & Howell Video Div., 720 Landwehr Rd., Northbrook 60062 Tel: 291-1150 Pres.: T.J. Wheeler, Nat'l Sales Mgr. John Borger (PKG)
 Video: 2" quad, 1" open reel, 1/4" U-matic cassette, 1/2" Beta & VHS cassette

Boulevard Rec'g Studios Inc., 641 Madison St., Oak Park 60302, Tel: 386-5388, Pres.: Hal Kaitchuck
 Audio: Cassette, open reel

Cassette Servs., 815 N. Douglas St., Arlington Heights 60004 Tel: 398-8403, Owner & Pres.: Willis J. Connor, Sales Mgr. Michael Connor (PKG)
 Audio: Cassette, open reel

Century Audio & Development Inc., 1018 Busse Hwy., Park Ridge, Ill. 60068, Tel: (312) 696-0675 (PKG)
 Audio: Cassette

Columbia Pictures Videocassette Servs., 1501 Landmeier Rd., Elk Grove Village 60007 Tel: 640-2350 Telex 206923 Exec. VP. George M. Ricci, Bus. Mgr.: T. Martin Rennels
 Video: 2" quad, 1" helical, 1/4" U-matic cassette, 1/2" Beta & VHS cassette

Columbia Rec. Prod'ns, 630 N. McClurg Court, Zip 60611 Tel: 944-6000
 Midwest Reg'l Sales Mgr.: Dick Hutter (Sales office only)
 Plants: Santa Maria, Calif., Terre Haute, Ind., Pitman, N.J.
 Audio: 8-tr., cassette, open reel.

International Audio Inc., 2934 Malmo Dr., Arlington Heights 60005, Tel: 956-6030 (PKG)
 Audio: 8-tr., cassette, open reel

International Rec'g Co., 1649 W. Evergreen Ave, Zip 60622 Tel: 227-2000 Pres. Leonard March
 Audio: Cassette, open reel

Kiderian Recs. Prod'ns, 4926 W. Gunnison St. Zip 60630 Tel: 545-0861 Pres. Raymond Peck; Gen. & Sales Mgr. George Peck
 Audio: 8-tr. cassette.

M B S Rec'g Studio, 232 E. Ohio Zip 60611 Tel: 828-0225
 Audio: 8-tr., cassette, open reel

Media Int'l Inc., 425 N. Michigan Zip: 60611 Tel: 467-5430 Pres., Duane Lundeen; VP: Margaret Lundeen, Gen. Mgr.: Al Masters (PKG)
 Audio: 8-tr., cassette, open reel

Musical Prods. Inc., 521 W. 26 St. Zip: 60616, Tel: 225-9117, (PKG)
 Audio: 8-tr., cassette, open reel

Poly Com Group, 201 E. Ohio St. Zip: 60611, Tel: 222-9480, Gen. Mgr.: Richard Jablonski; Sales Mgr.: Dave Bertz; Prod'n Mgr.: Carmen Trombetta.
 Video: 2" quad, 1" helical, 1/4" U-matic cassette, 1/2" Beta & VHS cassette

Programming Technologies Inc. 6666 N. Lincoln Ave., Lincolnwood 60645, Tel: 676-9400, Sales Mgr.: Steven Sorkin (PKG)
 Audio: Cassette

Pro I Audio Visual Inc., PO Box 33 Highland Park 60035 Tel: 433-4575 Pres. R.L. Pink, VP: J. Pink; Sales Mgr. M.M. Pink, Adv. Mgr. O.O. Pink (PKG)
 Audio: Cassette
 Video: 1/2" Beta & VHS cassette

Rainbow Bridge Studios Inc., 117 Rockland Rd., Libertyville 60048 Tel: 362-4060 Studio Mgr. Ron Schwartz.
 Audio: Cassette, open reel

Sound Studios, 230 N. Michigan Ave. Zip: 60601 Tel: 236-4814 Pres. Jerry Markham, VP & Gen. Mgr. Dan Tynus (PKG)
 Audio: 8-tr., cassette, open reel

Tono Tapes Inc., 5932 N. Northwest Hwy. Zip: 60631 Tel: 763-0980 (PKG)
 Audio: Cassette, open reel

Vinylwelt, 2011 W. Hastings Zip: 60608, Tel: 243-0606 (PKG only—audio & video)

● **KANKAKEE (Area Code 815)**
 Imperial Int'l Learning Corp., PO Box 548, Zip: 60901 Tel: 933-7735, Chief Exec. Spencer Barnard, Gen. Mgr.: F.R. Ringfelt
 Audio: Cassette, open reel.

● **SPRINGFIELD (Area Code 217)**
 TeleVisual Prod'ns, 1414 S. Fifth, Zip: 62703, Tel: 525-1238
 Audio: 8-tr., cassette, open reel.
 Video: 1" open reel, 1/4" U-matic cassette, 1/2" EIAJ open reel, 1/2" EIAJ cartridge, 1/2" Beta & VHS Cassette

INDIANA

● **GOSHEN (Area Code 219)**
 Precision Audio Inc., 16722 County Rd. 40 Zip: 46526 Tel: 642-3852 Pres. Sanford Swartzendruber; Gen. Mgr.: Jim Clymer Jr. (PKG)
 Audio: Cassette, open reel.

● **INDIANAPOLIS (Area Code 317)**
 Commercial Features Inc., 2330 N. Yandes, Zip: 46205, Tel: 926-4585
 Audio: Cassette, open reel

R C A Recs., 6550 E. 30 St. Zip: 46219 Tel: 267-5000
 Home office: New York, N.Y.
 Audio: 8-tr., cassette

● **MICHIGAN CITY (Area Code 219)**
 Infonics Inc., PO Box 1111, 238 Hwy 212 Zip 46360 Tel: 879-3381 Telex 233111
 Audio: 8-tr., cassette, open reel

● **RICHMOND (Area Code 317)**
 P R C Rec'g Co. (div. of Richmond Rec'g Corp.), 1600 Rich Rd. Zip 47374 Tel: 962-9511 (PKG)
 Home office: New York, N.Y.
 Audio: 8-tr., cassette

● **TERRE HAUTE (Area Code 812)**
 Columbia Rec. Prod'ns, 1400 N. Fruitridge Ave. Zip: 47805 Tel: 466-8111.
 Sales offices: Century City (Los Angeles Metropolitan Area), Calif., Chicago, Ill.; New York, N.Y.; Nashville, Tenn.
 Audio: 8-tr., cassette, open reel.
 Modern Album of Indiana Inc., 1299 Voorhees St. Zip 47808 Tel: 235-6001.
 (PKG only—audio & video)
 Home office: Hauppauge, N.Y., Modern Album & Finishing Co. Inc.

IOWA

● **CARLISLE (Area Code 515)**
 Harold Luck & Assoc., 110 Garfield St. Zip: 50047 Tel: 989-3679 Contact

Harold L. Luck
 Audio: 8-tr.

● **CORALVILLE (Area Code 319)**
 Safeguard Co., PO Box 5555, 108 Second Ave. Zip: 52241 Tel: 351-7830
 Gen. Mgr. (Audio-Visual Prod'ns) Ben Ploof
 Home office: Brookfield (Milwaukee Metropolitan Area), Wis.
 Audio: 8-tr., cassette, open reel

● **COUNCIL BLUFFS (Area Code 712)**
 Moss Rec'g Serv., PO Box 417, 708 W. Broadway Zip: 51502, Tel: 322-4513 (PKG)

● **DES MOINES (Area Code 515)**
 Studio 2000 Ltd., 515 28 St. Zip: 50312 Tel: 282-8306 Studio Orr.: James Shelby; Oup'l'n Mgr. Bryan Jolliffe
 Audio: Cassette, open reel
 Trad Prod'ns Inc., 1910 Ingersoll Zip: 50309 Tel: 243-2125 Pres. Richard Trump, Sales Eng. William Synhorst
 Audio: Cassette, open reel

KANSAS

● **WICHITA (Area Code 316)**
 High Fidelity Rec'g Inc., 1059 Porter Zip: 67203 Tel: 262-6456 Pres. James Strattan (PKG)
 Audio: 8-tr., cassette, open reel
 Video: 1/4" U-matic cassette, 1/2" Beta & VHS cassette.

KENTUCKY

● **LEXINGTON (Area Code 606)**
 Lemco Custom Rec'g, 2518 Southview Dr. Zip: 40503 Tel: 277-1184
 Audio: Cassette, open reel

● **LOUISVILLE (Area Code 502)**
 Allen-Martin Prod'ns Inc., 9701 Taylorsville Rd. Zip 40299 Tel: 267-9658
 Audio: Cassette

MARYLAND

● **KENSINGTON (Area Code 301)**
 Omega Rec'g Servs., 10518 Connecticut Ave. Zip: 20795, Tel: 946-4686
 Owner & Chief Eng.: W. Robert Yesbek
 Audio: 8-tr., cassette, open reel

● **TIMONIUM (Area Code 301)**
 Bradley Ent's. Inc., 108 Galewood Rd. Zip: 21093, Tel: 252-8520, Pres. Joe Bradley; Exec. Ass't: Stephen J. Rosasco
 Audio: Cassette.

MASSACHUSETTS

● **BOSTON METROPOLITAN AREA (Area Code 617)**
 Continental Rec'gs Inc., 210 South St. Zip: 02111, Tel: 426-3131, Pres. L. Daniel Flynn; Mktg. Orr. Stan M. Silverman (PKG)
 Audio: 8-tr., cassette, open reel

ASR RECORDING SERVICES, INC.

Specialists in

CASSETTE and 8 TRACK TAPE DUPLICATING SERVICES

for Music, Education & Industry

WE DO IT ALL!

From your Master Tape to a truck for delivery to your distributors, Personal Care is taken to assure Top Quality Product, On Time, At a Price that is COMPETITIVE!

ON BOTH COASTS

THE ONLY INDEPENDENT QUALITY TAPE DUPLICATOR THAT HAS PLANTS ON BOTH COASTS TO BETTER SERVICE YOUR ENTIRE TAPE NEEDS CROSS COUNTRY!!



RECORDING SERVICES INC.

East Coast:

21 Harristown Road
 Glen Rock, NJ 07452
 (201) 652-5600 • TWX 710-988-5625

South:

13101 Preston Road
 Suite 300 • Dallas, TX 75240
 (214) 239-7171

West Coast:

8960 Eton Avenue
 Canoga Park, CA 91304
 (213) 341-1124 • TWX 910-494-5973

Data Packaging Corp., 205 Broadway, Cambridge 02139 Tel: 868 6200
 Pres. Otto Morningstar Exec. VP Greg Mathus, VP Mktg. Jere R. Hill,
 Sales & Mktg. Mgrs. (audio video) Gene Hull, (consumer) Peggy Har-
 malz (PKG only—audio)
 Fleetwood Communications Co. Inc., 321 Revere St., Revere 02151. Tel:
 289-6800. Pres.: V.P. Giarrusso; Sales Mgr. Victor Mancini. Adv. Mgr.:
 Robin Samora
 Audio: 8 tr., cassette open reel
 Video: ¼" U-matic cassette, ½" Beta & VHS cassette
 Rik Tinory Prods'ns, 180 Pond Rd., Cohasset 02025 Tel: 383-9494. Pres.
 Richard F. Tinory, Artist Relations: Claire L. Babcock
 Audio: 8 tr., cassette, open reel
 ● **CHICOPPEE (Area Code 413)**
 Diectrics Inc., 300 Burnett Rd Zip 01020 Tel: 598 8308 (PKG only)

MICHIGAN

● DETROIT METROPOLITAN AREA (Area Code 313)

American Sound Corp., 3319 E. Ten Mile Rd., Warren 48091 Tel: 539 2900
 Pres. Frank Day, VP & Gen. Mgr. Paul M. Hayes; VP & Sales Mgr. Paul
 E. Adams (PKG)
 Branches: North Hollywood (Los Angeles Metropolitan Area), Calif.; West
 American Sound, Atlanta Ga.; American Sound Atlanta Corp., Closter,
 N.J.; American Sound
 Audio: 8 tr., cassette, open reel
 Arlie Fields Prod'ns, 9430 Woodward Ave Zip 48202 Tel: 873 8900 (PKG)
 Audio: Open reel
 General Television Network 13225 Capital Ave., Oak Park 48237 Tel: 548-
 2500 Pres.: R. Randolph Hippler (PKG)
 Video: 2" quad, 1" helical, ¼" U-matic cassette, ½" Beta & VHS cas-
 sette
 Magnetic Video Corp., 23434 Industrial Park Court, Farmington Hills 48024
 Tel: 476 2250 Pres. Andre A. Blay VP & Gen. Mgr., Consumer Prods.
 Jack K. Dreyer, VP Commercial Prods. Al Eicher, VP Admin. Robert J.
 Vandegriff, VP Mktg. Larry E. Bennett (PKG)
 Video: 2" quad, 1" helical, ¼" U-matic cassette, ½" Beta & VHS cas-
 sette
 Sound Patterns DXM, 38180 Grand River, Farmington Hills 48018 Tel: 477-
 6444
 Audio: Cassette, open reel
 Tape Tronics Inc., 750 E. Mandoline, Madison Heights 48071. Tel: 588-
 8281 TWX: (810) 232-1524.
 Audio: 8 tr., cassette
 ● **MOUNT CLEMENS (Area Code 313)**
 Bazy Electronics Corp., 39 N. Rose Zip 48043 Tel: 463 2592 (PKG)
 Audio: 8 tr., cassette

MINNESOTA

● MINNEAPOLIS-ST. PAUL METROPOLITAN AREA (Area Code 612)

A S I (Audiotek Systems Inc.), 711 W. Broadway, Minneapolis 55411. Tel:
 521 7631 Pres. Dan R. Holmes. Sales Mgr.: Wes Hayne. Adv. Mgr.
 Sandra Milani
 Audio: Cassette, open reel
 Bethany Fellowship Inc., 6820 Auto Club Rd., Minneapolis 55438. Tel: 944-
 2121 Cable BETHANY Pres. T.A. Hegre. Gen. Mgr. M.F. Johnson; Sales
 Mgr.: Bill Lunder (PKG)
 Audio: Cassette
 Communication Arts Inc., 2526 27 Ave. S., Minneapolis 55406 Tel: 721-
 5357
 Audio: Cassette
 E M C Corp., 180 E. Sixth St., St. Paul 55101 Tel: 227 7366. Pres. David E.
 Fernberg, VP Richard T. Stevens Custom Sales Dir. C. Carter (PKG)
 Sales office: Hollywood (Los Angeles Metropolitan Area), Calif.
 Audio: Cassette, open reel
 Metacom Inc., 1401 B W River Rd. N., Minneapolis 55411 Tel: 588-2781.
 Pres. James J. McCann; Sales Mgr. Phillip T. Levyn, Adv. Mgr.: Timothy
 Devillibus (PKG)
 Audio: Cassette, open reel

MISSISSIPPI

● JACKSON (Area Code 601)

Malaco Sound Rec'g (div. of Malaco Inc.), 3023 W. Northside Dr Zip 39213
 Tel: 982 4522
 Audio: 8 tr., cassette, open reel

MISSOURI

● KANSAS CITY (Area Code 816)

Acme Disks, PO Box 8123, 5644 Holmes Zip 64112 Tel: 444-8123 Pres.
 Shirley Black, Sales Mgr.: Ward Black
 Audio: Cassette
 Video: ¼" U-matic ½" Beta & VHS cassette
 Recording Studios 55 (div. of 3 G Inds.), 5500 Troost Zip 64110. Tel: 361-
 8455 Chief Eng. Mike Green, Gen. Mgr. Eugene Gold, Sales Mgr. C.
 King
 Audio: 8 tr., cassette, open reel
 Stage 3 Sound Prod'ns Inc., 12 E. 39 St Zip 64111 Tel: 531 1375 (PKG)
 Audio: Cassette, open reel
 ● **ST. LOUIS METROPOLITAN AREA (Area Code 314)**
 Technisound Studios Inc., 1201 S. Brentwood Blvd Zip 63131 Tel: 727-
 1055 Pres. Edward H. Canter
 Audio: Cassette, open reel
 ● **SPRINGFIELD (Area Code 417)**
 Aard-Vark Rec'g Inc., 335 S. Jefferson Zip: 65806 Tel: 866-4104. Pres.
 John Jacobsen
 Audio: Cassette
 National Audio Co. Inc., Box 3657 GS Zip 65804 Tel: 883-5377
 Audio: Cassette, open reel

MONTANA

● HELENA (Area Code 406)

Vallron Rec'g Studio, 305 Allen St Zip 59601 Tel: 442 0734
 Audio: Cassette, open reel

MONTANA

● HELENA (Area Code 406)

Vallron Rec'g Studio, 305 Allen St Zip 59601 Tel: 442 0734
 Audio: Cassette, open reel

A/V/T-40

NEW JERSEY

● ASBURY PARK (Area Code 201)

Sound-Arts Co. Inc., 5 Cindy Ln Zip 07712 Tel: 493-8666 Pres.: Charles J.
 Gspann, VP Francis M. Gspann (PKG)
 Audio: Cassette, open reel

● CAMDEN (Area Code 609)

Recorded Publ'ns Labs (div. of Recorded Publ'ns Mfg. Co. Inc.), 1100 State
 St Zip 08105 Tel: 963-3000, Phila (215) 922-8558 Pres.: David H.
 Goodman; Sales Mgr. Pat Landon; Adv. Mgr.: Edward J. Goodman (PKG)
 Sales office: New York, N.Y.
 Audio: 8 tr., cassette, open reel, special cartridges for background music
 & audio/visual

● CHERRY HILL (Area Code 609)

Tape Servs Inc., 1 Keystone Ave Zip 08003 Tel: 424-9450 Sales Mgr.
 Michael T. Mulcahy (PKG only—audio only)

● CLOSTER (Area Code 201)

American Sound Corp., 317 Harrington Ave Zip 07624 Tel: 767-9033 VP
 Mktg. Paul E. Adams (Sales office only)
 Home office: Warren (Detroit Metropolitan Area), Mich.
 Audio: 8 tr., cassette, open reel

● CRESSKILL (Area Code 201)

Unaworld Corp., 210 Knickerbocker Rd Zip 07626 Tel: 871-0555 Pres.
 Fred Cooper.
 Audio: 8 tr., cassette

● GLEN ROCK (Area Code 201)

A S R Rec'g Servs Inc., 21 Harristown Rd Zip 07452 Tel: 652-5600 TWX
 (710) 988-5625 (PKG)
 Branches: Canoga Park (Los Angeles Metropolitan Area), Calif.;
 Dallas Tex.
 Audio: 8 tr., cassette

● LEONIA (Area Code 201)

S/T Videocassette Dupl'g Corp., 500 Willow Tree Rd Zip 07605 Tel: 947-
 6450; NYC (212) 239-4653. Gen. Mgr. Stephan J. Ladden; Mktg. & Sales
 Dir. William R. Hitchcock
 Home office: New York, N.Y., Video Corp. of America
 Video: ¼" U-matic cassette, ½" Beta & VHS cassette, ½" EIAJ open reel

● MAPLE SHADE (Area Code 609)

A M P Rec'g's (div. of Intensive Programs Int'l), PO Box 14, 307 W. Main St
 Zip 08052 Tel: 667 1667 Pres. Donald R. Marsh, Gen. Mgr. Gerald
 Tyson
 Audio: Cassette, open reel

● MONTCLAIR (Area Code 201)

Linear Sound Rec'g, 211 Glenridge Ave Zip 07042 Tel: 744-0686. Pres.: M.
 Kroll, Sales Mgr. Tom Steinmann (PKG)
 Audio: 8 tr., cassette, open reel
 Video: Open reel, ¼" U-matic cassette, ½" Beta & VHS cassette

● NORTHVALE (Area Code 201)

Preferred Sounds Inc., 135 Ludlow Ave Zip 07647 Tel: 768-8007 Pres.
 Sal Nastro; VP Ops. & Admin. Dave Goldstein, Exec. VP Sales Al San
 toro, VP Sales, Eastern Div. Bob Schultz, VP Mktg. Baron Lee (PKG)
 Audio: 8 tr., cassette, open reel
 Video: ¼" U-matic cassette, ½" Beta & VHS Cassette

● PARK RIDGE (Area Code 201)

Cadet Recs., 12 Maple Leaf Dr Zip 07656 Tel: 391-3676 VP Sales & Mktg.
 R. K. Herrington (Sales office only) (PKG)
 Home office & plant: Los Angeles, Calif.
 Audio: 8 tr., cassette, open reel

● PITMAN (Area Code 609)

C B S Recs Inc., Lambs & Woodbury Rds Zip 08071 Tel: 589-8000
 Sales offices: Hollywood (Los Angeles Metropolitan Area), Calif., Chicago,
 Ill., New York, N.Y., Nashville, Tenn.
 Audio: 8 tr., cassette, open reel

● RIDGEFIELD (Area Code 201)

American Tape Corp. (div. of VideoVision Inc.), 1116 Edgewater Ave Zip
 07657 Tel: 943 7860 VP Sales Gerry Gottlieb, VP Admin. Cathelyn Ma-
 rani, Mendenhall, Plant Mgr. Francis A. Dermody (PKG)
 Audio: 8 tr., cassette

● SCOTCH PLAINS (Area Code 201)

H M R Prod'ns Inc., 574 W. Court Zip 07076 Tel: 889 1767 Owner Harry
 M. Randel, Pres. Lillian M. Randel
 Audio: Cassette

● UPPER SADDLE RIVER (Area Code 201)

Cassette Prod'ns Inc., 118 Rt. 17 Zip 07458. Tel: 327-1707 (PKG)
 Audio: Cassette

● WEST CALDWELL (Area Code 201)

R K O Tape Corp., 3 Fairfield Crescent Zip 07006 Tel: 575 8484 VP & Gen.
 Mgr. Hugh Wallace, Sales Mgr. Lee Gray. (PKG)
 Audio: Cassette, open reel

● WEST ORANGE (Area Code 201)

House of Music, 1400 Pleasant Valley Way Zip 07052 Tel: 736-3062, NYC
 (212) 964-7444 Pres. C.E. Conrad
 Audio: 8 tr., cassette, open reel

NEW MEXICO

● ALBUQUERQUE (Area Code 505)

Bill Hunter's Rec'g Serv., 118 Alcazar NE Zip 87108. Tel: 268-8442 Gen.
 Mgr. Bill Hunter
 Audio: 8 tr., cassette, open reel

NEW YORK

● CLARENCE (Area Code 716)

Mark Custom Rec'g Serv., 10815 Bodine Rd Zip 14031 Tel: 759-2600
 Pres. & Sales Mgr. Vincent S. Morette
 Audio: Cassette

● FARMINGDALE (Area Code 516)

Pressure Sensitive Tape & Label Corp., 135 Schmit Blvd Zip: 11735 Tel:
 293 7300. (PKG only—video)
 Shorewood Packaging Corp., 55 Engineers Ln Zip 11735 Tel: 694 8230
 (PKG only—audio & video)
 Home office: New York, N.Y.

● FRANKLIN SQUARE (Area Code 516)

Master Sound Prod'ns Inc., 921 Hempstead Trpk. Zip 11010. Tel: 354-
 3374 Owners: Ben Razzi, Maxine Chrem
 Audio: Cassette
 Video: ¼" U-matic cassette, ½" VHS cassette.

● HAUPPAUGE (Area Code 516)

Allison Audio Prods Inc., 1290 Motor Pkwy Zip: 11787 Tel: 234-2010, NYC
 (212) 953-1124 Bd. Chm. Louis Ligator, Pres. Abraham Chayet.
 Audio: 8 tr., cassette

Modern Album & Finishing Co. Inc., Cardinal Ind'l Park, Gilpin Ave. Zip:
 11787 Tel: 234 1100, NYC (212) 291-7600. Pres. G. D. Thomas; Sales
 Mgr. R. A. Froehlig (PKG only—audio & video)
 Branches: Burbank (Los Angeles Metro Area), Calif.; Modern Album of
 California Inc., Terre Haute, Ind.; Modern Album of Indiana Inc., Nash-
 ville, Tenn.; Modern Album of Tennessee Inc.
 Prestige Label Corp., 255 Oser Ave Zip: 11787 Tel: 273-0020. (PKG—audio
 only)

● HICKSVILLE (Area Code 516)

Burlington Audio Tapes Inc., 10 Commercial St Zip 11801 Tel: 433-4466
 Pres. Ruth Schwartz, VP Rudy Schwartz
 Audio: In-cassette dupl'g

● HOLTSVILLE (Area Code 516)

Studio Magnetics Co. Inc., 12 Long Island Ave. Zip 11742 Tel: 289 3400
 Pres. George Clahane, VP: Craig M. Balaban. (PKG only)

● HUNTINGTON STATION (Area Code 516)

Shelley Prods. Ltd., 220 Broadway Zip: 11746 Tel: 423 7090.
 Audio: 8 tr., cassette, open reel

● LE ROY (Area Code 716)

Arlo Recs Inc., 7635 Telephone Rd. Zip 14482. Tel: 584 3040 Pres., Ken
 neth Bearce; Gen. Mgr. James Bearce; Sales Mgr. Jill Welzel.
 Audio: Open reel

● LINDENHURST (Area Code 516)

Coastal Specialty Tapes Inc. (formerly Pratt-Spector Corp.), 274 Bangor St
 Zip 11757. Tel: 226-5900. Opns. Head & Sales Mgr. Dan Dobbs. (PKG
 only—audio)

● MAMARONECK (Area Code 914)

Cine Magnetics Video, 650 Halstead Ave Zip 10543 Tel: 698-3434, NYC
 (212) 542-0700. WATS (800) 431-1102 Contacts Bob Orzak, June
 Johnston.

Video: ¼" U-matic cassette, ½" Beta & VHS cassette

● MASSENA (Area Code 315)

Michele Audio Corp., Andrew Street Rd Zip 13662 Tel: 769-2448 Pres.
 Ginette Cormier, Sales Mgr., Harold Friedman; Adv. Mgr. Jack Daniels
 (PKG)
 Audio: 8 tr., cassette

● MOUNT VERNON (Area Code 914)

Sentry Inds. Inc., 221 N. MacQuisten Pkwy. Zip 10550. Tel: 664-2909
 Cable: SENTIND. Pres.: Harold Rosen, VP: Barry Rosen. (PKG)
 Video: ¼" cassette

● NEW YORK METROPOLITAN AREA (Area Code 212)

A G I (Album Graphics Inc.), 125 W. 55 St Zip: 10019 Tel: 489-0793 TWX
 (710) 581-5597 VP Mktg.: Richard Block. (Sales office only) (PKG only—
 audio & video).

Adwar Video Corp., 100 Fifth Ave. Zip 10011. Tel: 691-0976 Telex 420801
 Pres. Samuel Adwar, Sales Mgr. Mike McKenna, Chief Eng. William
 Claghor
 Video: ¼" EIAJ open reel, ¼" U-matic cassette, ½" Beta & VHS cassette.

Album Graphics Inc., see AGI.
 Andol Audio Prods Inc., 4212 14 Ave., Brooklyn 11219 Tel: 435-7322
 Pres. Anthony A. Maniere; Sales Mgr. Rocco Salvatore, Adv. Mgr. Do-
 menick Salvatore (PKG)

Audio: 8 tr., cassette
 Audio-Tech Labs., 2819 Newkirk Ave., Brooklyn 11226 Tel: 469-7134
 Audio: Cassette

Bert Co. Entcs. Inc. (div. of the Walter Reade Org. Inc.), 241 E. 34 St Zip:
 10016 Tel: 683 6300 Pres. Sheldon Gunsberg, Exec. VP, VP Finance &
 Treas. Christopher W. Preuster (Sales office only) (PKG only)

Branch: Los Angeles, Calif.
 Broadcasting Foundation of America, 52 Vanderbilt Ave., Suite 1810. Zip
 10017 Tel: 986-6448. Acting Exec. Dir. Calvin W. Stillman; Program
 Dir. Catherine Probst (PKG)

Audio: Open reel
 Cassette Rec'g Corp., see National Rec'g Studios
 Columbia Rec. Prod'ns, 51 W. 52 St Zip 10022 Tel: 975 4321. (Sales office
 only)

Plants: Santa Maria, Calif.; Terre Haute, Ind.; Pitman, N.J.; CBS Recs
 Inc.

Audio: 8 tr., cassette, open reel
 Cue Rec'g's, 1156 Ave. of the Americas. Zip: 10036 Tel: 757-3641.
 Audio: 8 tr., cassette, open reel

Delta Rec'g Corp., 16 W. 46 St Zip 10036 Tel: 840 1350
 Audio: 8 tr., cassette, open reel

Devlin Prod'ns Inc., 150 W. 55 St Zip 10019 Tel: 582 5572 Pres. Sandra
 Devlin, VP & Eng'g Dir. Roman Gulka, Gen. Mgr. Tom McCormick, Sales
 Rep. Cecelia Lazarescu

Video: 2" quad, 1" open reel, ¼" U-matic cassette, ½" Beta & VHS cas-
 sette
 Note: Video duplication done in all TV modes (NTSC, PAL, SECAM,
 PAL M)

Direct Recs Inc., 18 E. 50 St Zip 10022 Tel: 759-7979 (PKG)
 Audio: Cassette, open reel
 Disc Communications Ltd., 743 Fifth Ave Zip 10023 Tel: 371 0390 (PKG)
 Audio: 8 tr., open reel

R E H Sales Corp., 221 W. 57 St Zip 10019 Tel: 582 4200 Pres. Lee Hal-
 pern, Gen. Mgr. Michael Halpern, Sales Mgr. Robert Shavelson. (PKG)
 Audio: 8 tr., cassette, open reel

Video: ¼" U-matic cassette, ½" VHS cassette
 E U E/Screen Gems (div. of Columbia Pictures Inds Inc.), 222 E. 44 St Zip
 10019 Tel: 867 4030

Video: 2" quad, ¼" U-matic cassette
 Intercontinental Teletext Corp., 10 W. 66 St., Suite 11-F Zip: 10023 Tel:
 595 9454. Pres. Gerald Citron; VP: Nigel Toovey

Video: ¼" U-matic cassette, ½" Beta & VHS cassette
 M T I, see Modern Telecommunications Inc.
 Marvell Packaging Co., 230 W. 17 St Zip 10011 Tel: 929 8435 VP Barry
 Berman, Sales Mgr. Scott Teich (PKG only—audio & video)

Modern Telecommunications Inc (MTI), 885 Second Ave Zip 10017 Tel 355-0510 (PKG)
Video: All formats
 National Rec'g Studios Inc & National Video Center, 730 Fifth Ave Zip 10019 Tel 757 6440
Audio: 8 tr., cassette, open reel.
Video: 2" quad, 1" open reel, 1/4" U-matic cassette, 1/2" Beta & VHS cassette

National Video Center, see National Rec'g Studios
 Nostalgia Lane Inc, 200 W 57 St Zip 10019 Tel 582-5390
Audio: 8 tr., cassette
 P R C Rec'g Co (div of Richmond Rec'g Corp.), 1185 Ave. of the Americas Zip 10036 Tel 997 1250 Pres. Hugh Landy, VP & Sales Mgr David Grant (PKG)
Plants: Compton (Los Angeles Metropolitan Area), Calif., Richmond, Ind
Audio: 8 tr., cassette
 Queens Lithographing Corp, 52 35 Barnett Ave., Long Island City 11104 Tel 457 7700 Chief Exec Officer Eric Kaitman, Pres Leonard Verebay, Sr VP Sales Richard Roth (PKG only-audio & video)
Branch: Hollywood (Los Angeles Metropolitan Area), Calif
Plant: Indianapolis, Ind., Rutgers Packaging Corp
 R C A Recs., 1133 Ave of the Americas Zip 10036 Tel 930 4000 (Sales office only)
Sales offices: Los Angeles, Calif., Indianapolis, Ind., Nashville, Tenn
Plant: Indianapolis, Ind
Audio: 8 tr., cassette, open reel
 Recorded Publ'ns Labs (div of Recorded Publ'ns Mfg Co Inc.), 2 Penn Plaza, Suite 1500 Zip 10001 Tel 868 3115 Eastern Reg'l Sales Mgr Lee Kallettel (Sales office only) (PKG)
Home office: Camden, N.J.
Audio: 8 tr., cassette, open reel, special cartridges for background music & audiovisual
 Reel Dupl'rs Inc., 723 Seventh Ave Zip 10019 Tel 944 8977
Audio: Cassette, open reel
 Regent Sound Studios Inc., 25 W 56 St Zip 10019 Tel 245 2630 Pres Robert Liftin, Gen Mgr Elissa Kline
Audio: Cassette, open reel
Video: 2" quad, 1" type C open reel, 1/4" U-matic cassette
 Reliance Audio Visual Corp., 550 W 43 St Zip 10036 Tel 736 0700 Pres Gil M Meyer, Gen Mgr Marilyn Pejsach, Tech Dir John Peplow
Audio: Cassette, open reel
Video: 1/4" U-matic cassette, 1/2" Beta cassette
 Romber Sound Corp., 245 W 55 St Zip 10019 Tel 757 3681 Gen Mgr Lucina Hahn, Mktg Dir Joel Willis
Video: 2" quad, 2" helical (IVC), 1" open reel, 1/4" U-matic cassette, 1/2" EIAJ open reel, 1/2" EIAJ cartridge, 1/2" Beta & VHS cassette
 Sadler Rec'g, 118 E 28 St Zip 10016 Tel 684 0960 Pres John Sadler
Audio: Cassette, open reel
Video: 1/4" U-matic, 1/2" Beta & VHS cassette
 Jasper Samuel Advertising & Recs Inc 60 E 42 St, Suite 541 Zip 10017 Tel 490 2787 Pres Jasper Samuel (PKG only-audio & video)
 ServSound Inc., 35 W 45 St Zip 10036 Tel 921-0555 Pres Nat Levy, Gen & Sales Mgr Mike Shapiro (PKG)
Audio: Cassette, open reel
 Shorewood Packaging Corp., 10 E 53 St Zip 10022 Tel 371 1500 Pres Paul Shore, Exec VP Floyd S Glinert; VP Special Projects Marc Shore, VP Nat'l Sales Ken Rosenblum, VP West Coast Sales Jim Palmer (PKG only)
Branches: Los Angeles, Calif., Shorewood Packaging; La Grange, Ga., SPC Co.; Farmingdale, N.Y., Shorewood Packaging
 T V R Inc., 333 W 52 St Zip 10019 Tel 541 4030 VP Mktg. Allen Schultman, Opns Mgr., James C Mahoney
Video: 2" quad, 1" helical, 1/4" U-matic cassette, 1/2" Beta & VHS cassette
 United Research Lab Corp., 681 Fifth Ave Zip 10022 Tel 751-4663 TWX (710) 581 3622 Pres. George Adams, Gen Mgr Anita Adams, Sales Mgr Lee Rand; Chief Eng Jim Lee
Audio: Cassette, open reel
Video: 1/2" Beta cassette
 Video Corp. of America, 231 E 55 St Zip 10022 Tel 355-1600
Branch: Leonia, N.J., S/T Videocassette Dupl'g Corp
Video: 1/4" U-matic cassette, 1/2" Beta & VHS cassette, 1/2" EIAJ open reel, 1/2" EIAJ cartridge
 Visual Information Systems, 15 Columbus Circle Zip 10023 Tel 541 8080 Pres Jay Raeben, VP Prod'n & Programming David Barnhizer, Gen Mgr Paul Gersh, Sales Mgr Joe Scozzari (PKG-audio & video)
Video: 2" quad, 1" helical, 1/4" U-matic cassette, 1/2" Beta & VHS cassette

Windisor Total Video, 565 Fifth Ave Zip 10017 Tel 725-8080 Bd Chm Bob Henderson, Pres Bert Goodman, VP Prod'n & Sales Bert Saperstein; Dpns Mgr Nancy Squire
Video: 2" quad, 1" type C, 1/4" U-matic cassette, 1/2" Beta & cassette

- **NORTH BELLMORE (Area Code 516)**
 Telephone Dynamics Corp., 2473 A Jerusalem Ave Zip 11710 Tel 221 9870
Audio: Cassette.
- **PORT CHESTER (Area Code 914)**
 Associated Audio Servs Inc., 181 Westchester Ave Zip 10573 Tel 937 5129 Pres. D Richard Kraus, VP. Allan Johnson (PKG)
Audio: 8 tr., cassette, open reel
- **ROCHESTER (Area Code 716)**
 Visual Horizons, 180 Metro Park Zip 14623 Tel 424 5300
Audio: Cassette.
- **TROY (Area Code 518)**
 Wildwood Entertainment, 276 Fourth St. Zip 12180 Tel. 273 7660 VP Erich Borden
Audio: Cassette
- **UTICA (Area Code 315)**
 Oneida Video-Audio Tape Cassette Corp., 760 Blandina St Zip 13501 Tel 735-6187 Pres. Stanley Markowski
Audio: Cassette
- **YONKERS (Area Code 914)**
 Video Software & Prod'n Center Inc (VSP), 380 Walnut St Zip 10701 Tel 423-4400 Pres. Kenneth Wise, Sales Mgr John San Pietro, Client Servs. Mgr. Dee Martin
Video: 2" quad, 1" types A & C open reel, 1/2" EIAJ open reel, 1/4" U-matic cassette, 1/2" Beta & VHS cassette

NORTH CAROLINA

● **CANTON (Area Code 704)**

Recording Servs. of Western North Carolina Inc., 10 Penland St Zip 28716 Tel 648 8012 Owner J. Ted Evans Jr., VP Kay Evans
Audio: 8 tr., cassette, open reel

- **CHARLOTTE (Area Code 704)**
 Arthur Smith Studios, PO Box 220551, 5457 Monroe Rd Zip 28222 Tel 536 0424 Pres. Arthur Smith; Sales Mgr Clay Smith, Sales Mgr Wiley Brown (PKG)
Audio: Open reel

OHIO

- **CINCINNATI (Area Code 513)**
 Audiocraft Rec'g Co., 915 W Eighth St Zip 45203 Tel 241 4304 Pres. Earl T Herzog Jr (PKG)
Audio: 8 tr., cassette, open reel
Video: 1/4" U-matic cassette, 1/2" Beta & VHS cassette
 Counterpart Creative Studios Inc., 3744 Applegate Ave Zip 45211 Tel 661 8810 (PKG)
Audio: 8 tr., cassette, open reel
 Rite Rec. Prod'ns Inc., 9745 Mangham Or Zip 45215 Tel 733 5533 Owner Carl J Burkhardt, Pres VP Philip M Burkhardt VP Prod'n Lan A Ackley, VP Graphics Kenneth O Keith Jr., Sales Mgr Dan Burton (PKG)
Audio: 8 tr., cassette, open reel
- **CLEVELAND METROPOLITAN AREA (Area Code 216)**
 Boddie Rec. Mfg & Rec'g Inc., 12202 Union Ave Zip 44105 Tel 752 3440 Pres Thomas R Boddie, Sales Mgr Dennis R Boddie (PKG)
Audio: 8 tr., cassette, open reel
 The Little Warehouse Inc., 4906 Van Epps Rd Zip 44131 Tel 398 0022 (PKG)
Audio: 8 tr., cassette
 Storycraft Inc., 18630 Detroit Ave Lakewood 44107 Tel 221-4722 (PKG)
Audio: Cassette.
- **COLUMBUS (Area Code 614)**
 Magnetic Studios, 4784 N High St Zip 43214 Tel 262 8607
Audio: Cassette, open reel
 Mus I Col Inc., 780 Oakland Park Ave Zip 43224 Tel 267 3133 Owners John W Hull, Boyd P Niederlander
Audio: 8 tr., cassette, open reel
- **NEWARK (Area Code 614)**
 Utopia Sound, 38 40 S Firs St Zip 43055 Tel 345 9426 Owner Robert H Kirk Jr., VP Don Shannon, Gen Mgr Robert H Kirk Sr., Sales Mgr Rose Shannon (PKG)
Audio: 8 tr., cassette
- **YOUNGSTOWN (Area Code 216)**
 United Audio Rec'g Studio, 5947 Stillson Pl Zip 44512 Tel 758 5463 Pres William Warner, Gen & Sales Mgr Ray Nevel
Audio: 8 tr., cassette, open reel

OKLAHOMA

- **OKLAHOMA CITY (Area Code 405)**
 Video One Inc 1216 N Blackwelder, Zip: 73106 Tel 524 2111 Pres. Robert M Howard; Prod'n Mgr Rick A Lippert
Video: 1/4" U-matic cassette, 1/2" Beta & VHS cassette
- **TULSA (Area Code 918)**
 C E S Rec'g Inc., 2500 N Hemlock Circle, Broken Arrow 74012 Tel 627-8474 Pres Basil W Thomas, Gen Mgr Judy McAlister, Mktg Mgr Walter J Mckee Jr (PKG-audio only)
Audio: 8 tr., cassette
Video: 1/2" Beta & VHS

I T T Studios (International Teaching Tapes), 4235 S Memoria Dr Zip 74145 Tel 663 7700 Pres. Meredith R Gray, Sales Mgr Sonny Gray (PKG)
Audio: 8 tr., cassette, open reel
 The Master Sound Inc., 8137 E 46 St Zip 74145 Tel 663 7186 Pres Donald Boshears, Gen Mgr Peter Enns, Sales Mgr Louis Threeton (PKG)
Audio: Cassette
Video: 1/4" U-matic cassette, 1/2" Beta & VHS cassette

OREGON

- **PORTLAND (Area Code 503)**
 Northwestern Inc. (Motion Pictures & Rec'g), 1224 SW Broadway Zip 97205 Tel 226 0170 Pres Robert M Lindahl, Sales Mgr Paul A Buescher (PKG)
Audio: Cassette, open reel

PENNSYLVANIA

- **LANCASTER (Area Code 717)**
 Spectrum Fidelity Magnetics, 49 Glenwood Ave Zip 17602 Tel 295 9275 (PKG)
Audio: 8 tr., cassette
- **PHILADELPHIA METROPOLITAN AREA (Area Code 215)**
 AudioVisual Communications Inc 435 Crooked Ln., King of Prussia 19406 Tel 272 8500 Pres John Ballantyne, VP Sales John Butterworth (PKG)
Audio: Cassette, open reel
 Diskmakers Inc, 925 N Third St Zip 19123 Tel 627 2277, NYC Tel (212) 966 3185 Pres Morris Ballen, VP Larry Ballen
Audio: 8 tr., cassette
 MarketDyne Int'l, 1600 Arch St Zip 19101 Tel 241 2935 (PKG)
Video: 1" open reel, 1/4" U-matic cassette, 1/2" EIAJ open reel, 1/2" EIAJ cartridge
 UniComm Inc., 414 Swedeland Rd., King of Prussia 19406 Tel 275 7100 Pres J L C Ulrich Jr, Gen Mgr Robert G Rowe Jr (PKG)
Audio: Cassette, open reel
- **PITTSBURGH (Area Code 412)**
 Audio Innovators Inc, 216 Blvd of the Allies Zip 15222 Tel 471 6220 Pres Norman J Cleary, Gen Mgr Martha J Wilson
Audio: Cassette, open reel
 George Head Prod'ns & AV Prods, 701 Washington Rd Zip 15228, Tel 561 3399 (PKG-audio & video)
Audio: Cassette, open reel
- **PRIMOS (Area Code 215)**
 E J Stewart Inc., 525 Mildred Ave Zip 19018 Tel 626 6500 Pres Eric R Address, Gen & Adv Mgr Howard S Lipman, Sales Mgr Andy Krenzle (PKG)

Video: 2" quad broadcast, 1" type C, 1/4" U-matic cassette

- **SCRANTON (Area Code 717)**
 Specialty Recs Corp., 210 N Valley Ave., Olyphant 18447 Tel 383 2471 TWX (510) 671 4580 Pres Richard C Marquardt, VP Sales John R Williams
Audio: 8 tr., cassette
- **WARREN (Area Code 814)**
 Loranger Mfg. Corp., Entertainment Prods Div., 10 48 Clark St Zip 16365 Tel 723 8600 VP Robert Loranger (PKG only-audio)

SOUTH CAROLINA

- **GREENVILLE (Area Code 803)**
 Duplication Serv (div of Custom Rec'g & Sound Inc.), PO Box 7647, 1225 Pendleton St Zip 29611 Tel 269 5018 Pres Robert W. Edwards (PKG)
Audio: 8 tr., cassette open reel
Video: 1/4" U-matic cassette, 1/2" Beta & VHS cassette
- **MYRTLE BEACH (Area Code 803)**
 Dee Bee Rec'g Serv 704 Ninth Ave S Zip 29577 Tel 448 8091 Pres Stan Deppen Jr Sales Mgr Kenneth Deppen, Adv Mgr Pat Gerrick (PKG)
Audio: Cassette, open reel

TENNESSEE

- **FAYETTEVILLE (Area Code 615)**
 Kim Pat Ents., PO Box 654, Hillwood Dr Zip 37334 Tel 433 2323/5661 (PKG)
Audio: 8 tr., cassette open reel
- **MEMPHIS (Area Code 901)**
 Shoe Prod'ns Inc., PO Box 12025, 485 N Hollywood Zip 38112 Tel 458-4496 Pres Warren E Wagner, VP & Music Dir Wayne Crook (PKG)
Audio: Open reel
Video: 1/4" U-matic cassette, 1/2" VHS cassette
- **NASHVILLE AREA (Area Code 615)**
 American Sound Recs / Emerald Recs., 62 Music Square W Zip 37203 Tel 327 4538 Pres Cliff Ayers Ostermeyer, Gen Mgr Connie Lynne Wright, Sales Mgr Chris Ostermeyer, PR Alma Lee Combs
Audio: 8 tr.
 Columbia Rec. Prod'ns, 34 Music Square E Zip 37203 Tel 259 4321 (Sales office only)
Plants: Terre Haute, Ind., Pitman, N.J., CBS Recs Inc
Audio: Cassette, open reel
 Custom Tape Dupl'rs Inc., 341 Hill Ave Zip 37210 Tel 256 1728 Pres L C Tant, Sales Mgr Mike Tant (PKG)
Audio: 8 tr., cassette
 Fanta Professional Servs., 1213 16 Ave S Zip 37212 Tel 327 1731 Pres Johnny Rosen
Audio: 8 tr., cassette, open reel
Video: 2" quad, 1" helical "C" format, 1/4" U-matic cassette, 1/2" Beta & VHS cassette
 Globe Rec'g Studio Inc., 1313 Dickerson Rd Zip 37207 Tel 226-0811, Owner & Mgr Jim Maxwell, Sec'y Treas. Glenn Maxwell
Audio: Cassette, open reel
 Gusto Recs. & Tapes, 220 Bosobel St Zip 37213 Tel 256-1656, TWX (810) 371-1055 Pres & Sales Mgr Moe Lytle, Gen. Mgr Steve Kountz-man
Audio: 8 tr., cassette
 Modern Album of Tennessee Inc., 457 Chestnut, Zip 37203 Tel: 255-7461, (PKG only-audio & video)
Home office: Hauppauge, N.Y., Modern Album & Finishing Co Inc Nashville Album Prod'ns Inc., 101 Music City Circle Zip 37203, Tel 883-2153 (PKG)
Audio: 8 tr., cassette
 R C A Recs 30 Music Square W Zip 37203 Tel 244 9880 VP Jerry Bradley
Home office: New York, N.Y
Plant: Indianapolis, Ind
Audio: 8 tr., cassette, open reel
 Sound of Nashville Inc, 305 11 Ave S Zip 37203 Tel. 244 1124 Pres John Ivantis, Sales Mgr Allen Morel
Audio: 8 tr., cassette
 Southern American Rec. Pressing-Tel. 256 2521-see Sound of Nashville, Stargem Recs Inc., 20 Music Square W., Suite 200 Zip 37203, Tel 244-1025 (PKG only-video)
 Studer Revox America Inc., 1425 Elm Hill Pike Zip 37210 Tel 254 5651, Pres Bruno Hochstrasser, Gen Mgr Btl R Muggler, Nat'l Sales Mgr Barry D Evans, Technical Mgrs (Studer) Doug Beard, (Revox) Renaud Delapraz
Branches: Van Nuys (Los Angeles Metropolitan Area), Calif., New York, N.Y
Audio: Open reel

TEXAS

- **AUSTIN (Area Code 512)**
 P S G Rec'g Studio, PO Box 1482, 4322 A N. Lamar Blvd Zip 78767 Tel. 454 5653 Pres Pedro S Gutierrez
Audio: 8 tr., cassette, open reel
- **DALLAS (Area Code 214)**
 A S R Rec'g Servs 13101 Preston Rd., Suite 300 Zip 75240 Tel 239 7171
Home office: Glen Rock, N.J
Audio: 8 tr., cassette
 Electronic Technological Inds of America Inc., PO Box 1580 Zip 75221 Tel 827 8002 Bd Chm John Kanter, Gen Mgr David Coleman, Sales Mgr Larry Pearson (PKG)
Audio: 8 tr., cassette, open reel
 Tapemasters Inc., PO Box 38651 Zip 75238 Tel 349 0081 (PKG)
Audio: 8 tr., cassette, open reel
- **FORT WORTH AREA (Area Code 817)**
 Oakridge Music Rec'g Studio, 2001 Elton Rd., Haltom City 76117 Tel 838 8001 Eng Homer Lee Sewell
Audio: Cassette, open reel
- **SAN ANTONIO (Area Code 512)**
 A S I (Abaddon/Sun Inc.), PO Box 6520, 10330 Kolzebeue Zip 78209 Tel 824 8781 Pres Galen Carol
Audio: Cassette
 Marsal Prod'ns Inc., 1735 Castroville Rd Zip 78237 Tel 433 9351 Pres

TRANS-AM INDUSTRIES

C-0 CASSETTES

Immediate
Delivery
Meets All
Industry Standards
Provides High
Reliability

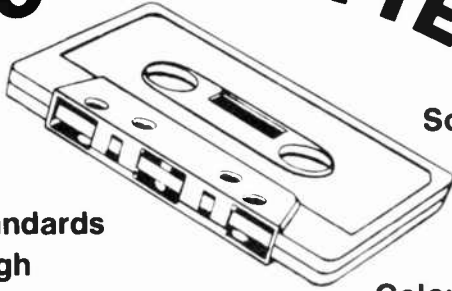

Sonic Sealed
Screw
Type
Tabs In
Tabs Out
Colors Available

CAPACITY 80 MILLION PER YEAR

Call or Send for Price List and Samples

TRANS-AM INDUSTRIES

845 BROAD AVE., RIDGEFIELD, N.J. 07657
Tel: (201) 945-2000 • Telex: 133396

Antonio J. Menendez, Gen. Mgr., Pat Alvarado, Sales Mgr., Felix Elizondo.
Audio: 8 tr., cassette

Texas Rec. Mfg. Inc., 1422 W. Poplar, Zip 78207, Tel. 733 6138, Pres. C. Foy Lee, Gen. Mgr., Jimmy Burton, Sales Mgr., Jeannie Hill. (PKG)
Audio: 8 tr.

• **SAN BENITO (Area Code 512)**

Rio Grande Music Co., 119 S. Sam Houston Blvd., Zip 78586, Tel. 399 5377
Sales Mgr. John F. Phillips
Audio: 8 tr., cassette

• **WACO (Area Code 817)**

Creative Communications Inc. (sub. of SMI), 920 N. Valley Mills, Zip 76710
Tel. 776 6553 (PKG)
Audio: Cassette

UTAH

• **PROVO (Area Code 801)**

Sound Concepts, PO Box 299, 108 W. Center, Zip 84601, Tel. 375 7333
Owner: Michael Jensen. (PKG)
Audio: Cassette

• **SALT LAKE CITY (Area Code 801)**

Bonneville Prod'ns, 130 Social Hall Ave., Zip 84111, Tel. 237 2400, TWX (910) 925 5266
Audio: Cassette, open reel
Chase Media Inc., Busch Park, 5284 S. 320 W., Suite C 166, Zip 84107, Tel. 261 1383, Pres. & Gen. Mgr. Randal S. Chase, Sales Mgr. Irel Chase
Audio: 8 tr., cassette, open reel
Covenant Rec'gs Inc., PO Box 26817, 1345 Major St., Zip 84126, Tel. 487 1096, Pres.: V. Lewis Kofford, Adv. Mgr. Jeff Lund. (PKG)
Audio: Cassette

VIRGINIA

• **MANASSAS (Area Code 703)**

Memory Makers, 9202 Amelia Court, Zip 22110, Tel. 631 9465, Pres. Jim Corrado, VP. Donna Corrado (PKG—audio & video)
Audio: 8 tr., cassette, open reel

WASHINGTON

• **OLYMPIA (Area Code 206)**

Sound Preservers Co., 911 E. Fourth Ave., Zip 98506, Tel. 352 9097, Owner: Allen P. Giles
Audio: 8 tr., cassette, open reel

• **SEATTLE (Area Code 206)**

Cinema Sound Corp., see Investment Technology
Investment Technology Inc., 1940 124 Ave. NE, Bellevue 98005, Tel. 454 7720
Music Farm Inc., 615 E. Pike St., Zip 98122, Tel. 323-6847
Audio: Open reel

WISCONSIN

• **MILWAUKEE (Area Code 414)**

A & B Cassette Dupl'g., 1502 S. 87, West Allis 53214, Tel. 774 7250, Pres.
(Continued on page A/V/T-85)

LENCO OFFERS

PEACE OF MIND



Your tape is no better than the C-0 cassette that contains it. Lenco C-0 cassettes and display boxes are precision engineered for superior, trouble-free use. That's peace of mind from Lenco!

LENCO

Lenco offers a variety of options and accessories, including sonic and five screw C-0 cassettes. Ampex style, soft poly and Norelco display boxes to fulfill your cassette needs. Write or call.

Phone 402/786-7488 Box 160 Waverly, Nebraska 68462

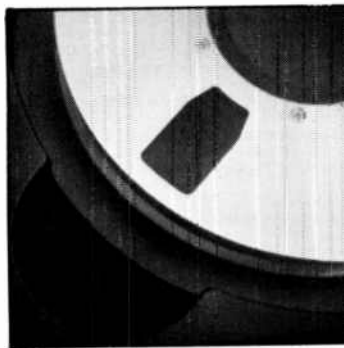

INTERNATIONAL AUDIO VIDEO TAPE DIRECTORY

TAPE SUPPLIES

4 PARTS, CARTRIDGE & CASSETTE, MANUFACTURERS

Alinabul Inc., 28 Woodmont Rd., Milford, Conn. 06460. Tel (203) 877-3241
TWA (710) 462-1178. Pres. V.C. Wichter, VP Ops: C.H. Hunnan, Gen
Sales Mgr. John M. Robertson.
Audio: Liners, pressure pads & shields.
Analyst, sev Pacific Int'l
J.C. Anglam Co. Inc./Tapeponents Inc., Bx 236, 36 Midvale Rd., Mountain
Lakes, N.J. 07046. Tel (201) 263-1442. Pres.: J. Clifford Anglam
Audio: 8-tr. pinch rollers & pressure pads.
Associated Audio Servs. Inc., 181 Westchester Ave., Port Chester, N.Y.
10573. Tel (914) 937-5129. Pres. D. Richard Kraus, VP Allan Johnson
Athena Invis. Inc., 2200 Industrial Way S., Toms River, N.J. 08753. Tel
(201) 244-8500. Pres. Louis Ligator, Sales Mgr. Mark Chayet
Corp. office: Hauppauge, N.Y., 1290 Motor Pkwy. Zip 11787. Tel (516)
234-2010
Audio: All cassette parts

Audio Accessories Co., 38 W. 515 Deerpath Rd., Batavia, Ill. 60510. Tel
(312) 879-5998. Sales Mgr. John S. Maloney
Audio: Plastic cassette hub locks, record tab plugs
Audio Inds. Inc., Broad & Linden Aves., Ridgefield, N.J. 07657. Tel (201)
945-4545
Audio: 8-tr & cassette parts
AudioPak, see Capitol Magnetic Prods
Bazzy Electronics Corp., 39 N. Rose, Mount Clemens, Mich. 48043. Tel
(313) 463-2592
Audio: 8-tr parts
Burlington Audio Tapes Inc., 10 Commercial St., Hicksville, N.Y. 11801. Tel
(516) 433-4466. Pres. Ruth Schwartz, VP Rudy Schwartz
Cadet Recs. Inc., 5810 S. Normandie Ave., Los Angeles, Calif. 90044. Tel
(213) 753-5121. Pres. Jules Biharr; Mgr. Don Macmillan
Branch: Park Ridge, N.J., 12 Maple Leaf Dr. Zip 07656. Tel (201) 391-
3676. VP Sales & Mktg. Robert K. Herrington
Audio: 8-tr
Capitol Magnetic Prods. (div. of Capitol Recs. Inc.), 6902 Sunset Blvd., Hol
lywood, Calif. 90028. Tel: (213) 461-2701. Pres. Edward C. Khoury, VP
Mktg. Admin: John Apsitis, VP Domestic Sales Larry Hockemeyer, VP
Int'l Sales Bud Jackson, Mktg. Coord.: Natalie Goss.
Sales offices: Atlanta, Ga., 1670 NE Freeway Access Rd. Zip 30329. Tel
(404) 321-5441. -Miles, Ill., 6401 Gross Point Rd. Zip 60648. Tel (312)
775-7101. -New York, N.Y., 1370 Ave. of the Americas. Zip 10019. Tel
(212) 757-7470
Int'l branch: Singapore
Audio: 8-tr parts
Brand name: Audio Pak
Custom Cartridge Inc., 341 Hill Ave., Nashville, Tenn. 37210. Tel (615) 244-
5668. Pres. Cliff Tant
Audio: 8-tr

D A K Inds. Inc., 10845 Vanowen St., North Hollywood, Calif. 91605. Tel
984-1559; WATS (800) 423-2636. Cable: DAKENT Telex 651396. Pres.
Drew Alan Kaplan.
Audio: Cassette liners, hubs, housings, pins, rollers & pressure pads
Data Packaging Corp., 205 Broadway, Cambridge, Mass. 02139. Tel (617)
868-6200. TWX (710) 320-0885. Pres. Ditto Morningstar, Exec. VP Greg
Mathus, VP Mktg.: Jere Hill, Sales & Mktg. Mgrs. (audio video) Gene
Hull, (consumer) Peggy Harmatz.
Audio: 8-tr & cassette parts
Delta Magnetos Corp., 1901 McDonald Ave., Brooklyn, N.Y. 11223. Tel
(212) 627-6556. Telex: 642271
Branch: Edison, N.J., PO Box 494. Zip 08817. Tel (201) 287-8907
Audio: Graphite coated cassette shims & roll stock
Dison Inds. Corp. (a Bundy Co.), 386 Metacom Ave., Bristol, R.I. 02809. Tel
(401) 253-2000. Telex: 92-7706. Pres.: Bert Katzanek; Sales Mgr. John
F. McCurdy Jr.
Audio: Cassette shims, acetal post rollers, cartridge top rings & teflon
thrust washers.
Video: U-matic, Beta & VHS cassette tabs, guides & teflon thrust pads.
Donnak Inds., PO Box 422, Ridgefield, N.J. 07657. Tel: (201) 945-6820.
Audio: Cassette hubs, flanged rollers, slip sheets, stainless steel pins,
spring pads, shields, sonic & screw-type shells & windows.
Chet Dunn Assoc. Mfg. Rep., 20 Locke Rd., Billerica, Mass. 01821. Tel:
(617) 663-2000. Telex: 947429. Pres.: Chet Dunn.
Audio: Staking rods, leader locks
Dyna/Day Plastics Inc. (sub. of American Sound), 6270 S. Country Club
Rd., Tucson, Ariz. 85706. Tel: (602) 746-1001. Pres. Frank S. Day, VP &
Gen. Mgr.: Larry Rossier, Sales: Leslie Day.
Sales offices: North Hollywood, Calif. 8120 Webb Ave. Zip 91605. Tel
(213) 768-6100. Sales Dir.: Bill Dawson-Closter, W.J., 317 Harrington
Ave. Zip: 07624. Tel: (201) 767-9033. VP Mktg.: Paul Adams.
Audio: Cassette hubs, rollers & shells.



from our "Short-Order" Department...

• Scratch Resistant • High Impact
NORELCO BOXES
and
SOFT POLY BOXES
No Minimum Order!

Low ... Low ... Prices ...
Our Low Prices Will Put Money
Into Your Pockets!

**SAME DAY
SHIPMENTS**

Orders in by 10:00 A.M.
Shipped out by 4:30 P.M.

Buy Direct From Manufacturer!

CALL TODAY... 201-334-2020

MAX-SOUND

A DIVISION OF JOYCE MOLDING

501 DIVISION STREET • BOONTON, NEW JERSEY 07005

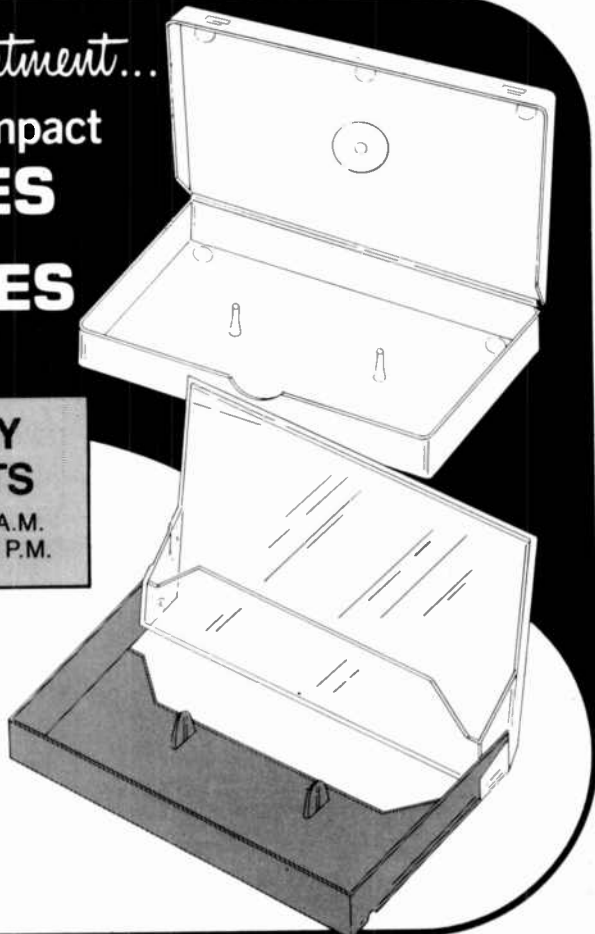

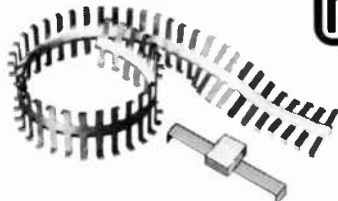
No. 201
Cassette Spring Pad



No. 410 Flat Shield



No. 470M
Cassette Full Shield

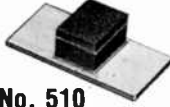

No. 510
Flat-Foam Shield



No. 508
8 Track Foam Pad



No. 208
8 Track Cartridge Spring Pad

Special designs on request
Call or Write
OVERLAND PRODUCTS CO.
P.O. Box 567 • 515 North Pierce Street
Fremont, Nebr. (USA) 68025 • 402 721-7270

El Mar Plastics Inc., 821 E. Artesia Blvd., Carson, Calif. 90746. Tel. (213) 327 3180 Cable ELMAR TWX (910) 346-6940 Pres. Allen Schor
Audio: 8 tr. & cassette parts
 Filam Nat'l Plastics Inc., 13984 S. Drange Ave., Paramount, Calif. 90723 Tel. (213) 630 2500
Audio: Hub locks
 Gabriel Mfg. Co. Inc., 125 S. Liberty Dr., Stony Point, N.Y. 10980 Tel. (914) 942 0100 Pres. Ed Gabriel, VP Richard Gabriel, Gen. Mgr. Vin Tullio Adv. Mgr. Ellen Gabriel
Audio: Hubs, pins, rollers, shells
 Hi-Flex Corp., 404 Artillery Rd., Taylors, S.C. 29687 Tel. (803) 268 2363
Audio: Cassette shims ("punched out" & continuous), pressure pads
 Horan Eng'g Inc., 600 Lake Emma Rd., Lake Mary, Fla. 32746 Tel. (305) 323 2400 TWX (810) 856-0300 Pres. Richard C. Horan, Gen. Mgr. James Horan, Sales Mgr. Robert L. Horan, Adv. Mgr. Sue Coleman
Audio: 8 tr. & cassette shells
 Imco Inc., PD Box 444, Huntington, Ind. 46750 Tel. (219) 356 4810
Audio: Elastomeric pinch rollers
 Joyce Molding Corp., 501 Division St., Boonton, N.J. 07005 Tel. (201) 334 2020
Audio: pinch rollers, pressure pads
Brand name: Max Sound
 Kyrac Corp., 2111 E. 20 St., Tucson, Ariz. 85719 Tel. (602) 624 2408 Pres. & Sales Mgr. Keyvan Mokhtarian
Audio: All cassette parts
 L J S Corp., 1225 Broadway, Main Floor, New York, N.Y. 10001 Tel. (212) 725 0290 Pres. George T. Saddler, Gen. Mgr. H. Johnson, Sales Mgr. Elias Smyrnakis
Audio: All components
 Lenco Co., PD Box 160, 10240 Deerpark Rd., Waverly, Neb. 68462 Tel. (402) 786 7488 Pres. Don Leonhardt, Mktg. Dir. Brad Harse, Sales Mgr. Daryl Chapelle
Audio: Cassette hubs, rollers, tab inserts, hub locks
 Loranger Mfg. Corp., Entertainment Prods. Div., 10 48 Clark St., Warren, Pa. 16365 Tel. (814) 723 8600 VP. Robert Loranger
Audio: 8 tr. & cassette parts
 Mastro Inds. Inc., 3040 Webster Ave., Bronx, N.Y. 10467 Tel. (212) 547 5600 Pres. Mario Maccalenti
Audio: Cassette guide rollers, keyhole hubs
 Max Sound, see Joyce Molding
 Minnesota Rubber Co., 3630 Wooddale Ave. S., Minneapolis, Minn. 55416 Tel. (612) 927 1400
Audio: 8 tr. pinch & drive rollers
 Mission Plastics South Inc., 341 Hill Ave., Nashville, Tenn. 37210 Tel. (615) 244 5668
 Factory: Jackson, Tenn., 74 Mission Dr. Zip 38301 Tel. (901) 423 0810
Audio: Cassette parts
 Dverland Prods. Co. Inc., PD Box 567, 515 N. Pierce St., Fremont, Neb. 68025 Tel. (402) 721 7270 Pres. & Sales Mgr. Howard J. Pearson
Audio: 8 tr. & cassette pressure pads, pins & shields
 Pacific Int'l Magnetics Inc., 185 Berry St., No. 3865, San Francisco, Calif. 94107 Tel. (415) 495 8830
 Home office: Canada
Audio: Cassette components
Brand name: Analyst
 Respond Int'l Recs. Inc., 1190 Miraloma Way, Suite Y, Sunnyvale, Calif.

94086 Tel. (408) 245 1351 Cable RESPOND TWX (910) 339 9317 Pres. Ronald L. Akin
 Rivertone Corp., Dillon Rd., Monticello, N.Y. 12701 Tel. (914) 794 8888
Audio & Video: Plastic & rubber injection molding machines for tape parts
 Roller Corp. of America, 3601 S. Clinton Ave., South Plainfield, N.J. 07080 Tel. (201) 757 7330 Pres. Edward Monett, VP. Jack E. Monett
Audio: 8 tr. pinch rollers
 Shape Inc., PD Box 366, Biddeford Ind'l Park, Biddeford, Me. 04005 Tel. (207) 282 6155 Telex 944325
Audio: Cassette hubs, pins, pressure pads, rollers, shells, shields
 Specially Composites Corp., Delaware Ind'l Park, Newark, Del. 19713 Tel. (302) 738 6800 Sales Mgr. R. Prybutok, Adv. Mgr. J. Welsh
Audio: Pressure pads
 Tapeponents Inc., see J.C. Anglum
 Trans Am Inds. Inc., 845 Broad Ave., Ridgefield, N.J. 07657 Tel. (201) 945 2000
Audio: Cassette hubs, double flanged rollers, slip sheets, stainless steel pins, tabs
 Unique Prods. Inc., 2501 W. 237 St., Torrance, Calif. 90505 Tel. (213) 530 7500 TWX (910) 347 6236 Pres. George Lusko
Audio: Cassette pressure pads, pins, shields & windows, screws, digital pressure pads, continuous reels
 Universal Tape Corp. Inc., 821 E. Artesia Blvd., Carson, Calif. 90746 Tel. (213) 327 3203 Pres. Edward D. Praeger
Audio: 8 tr. -snap & screw type halves, bronze & foam type pressure pads, platforms, cassette-sonic screw & snap type halves, stainless steel pins, pressure pads, mu metal shields, hubs, double flanged idler rollers, window, teflon, graphite & polyester shield gaskets & liners & stainless steel pins

5
EMPTY
CARTRIDGE,
CASSETTE & REEL
MANUFACTURERS

A & E Data Technology Corp., 2945 Airway Ave., Costa Mesa, Calif. 92626 Tel. (714) 549 8353 Pres. Kenneth L. Smith, Nat'l Sales Mgr. Sue H. Carpenter, Prod. Mgr. Walter M. Davenport
Video: 1/4" U-matic cassette, 1/2" VHS cassette
 A/V Paragon, see Universal Tape
 Ampex Corp., 401 Broadway, Redwood City, Calif. 94063 Tel. (415) 367 2011 Telex 348464 TWX (910) 378 5920

**IF YOU WANNA BOX...
AND NOT GET HURT...
CALL EL MAR PLASTICS!**

— because El Mar has boxes — cassette boxes — at prices that won't leave a bruise! All kinds — Norelco style boxes, hinged poly boxes, Ampex style boxes, and 12-pack cassette storage boxes.

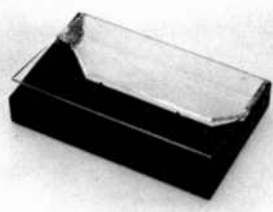

In fact, we've been making more boxes longer than anyone!

We've recently taken some of the sting out of the price fight, by setting up a fully automated line to increase our production of Norelco style boxes by an additional 40 million a year.

And not just any old box! The new El Mar boxes have all rounded corners, molded raised edges

on the lid to reduce scratching and a super strong hinge! Plus, they have been tested and proven on all automatic packaging equipment.

When quality and dependability count, we have a C-O that can't be beaten. Solid 5 screw housing with all the top grade components you've come to expect.

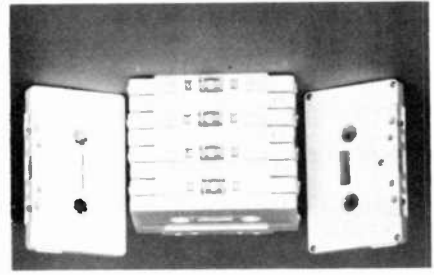

Please call for prompt quotation and samples.

El Mar Plastics, Inc.

821 E. Artesia Blvd., Carson, CA 90746
(213) 327-3180
 Manufacturer of quality C-O cassettes, cassette boxes, tape accessories and 1/4" tape reels.



This cassette sells itself. A million times a week.

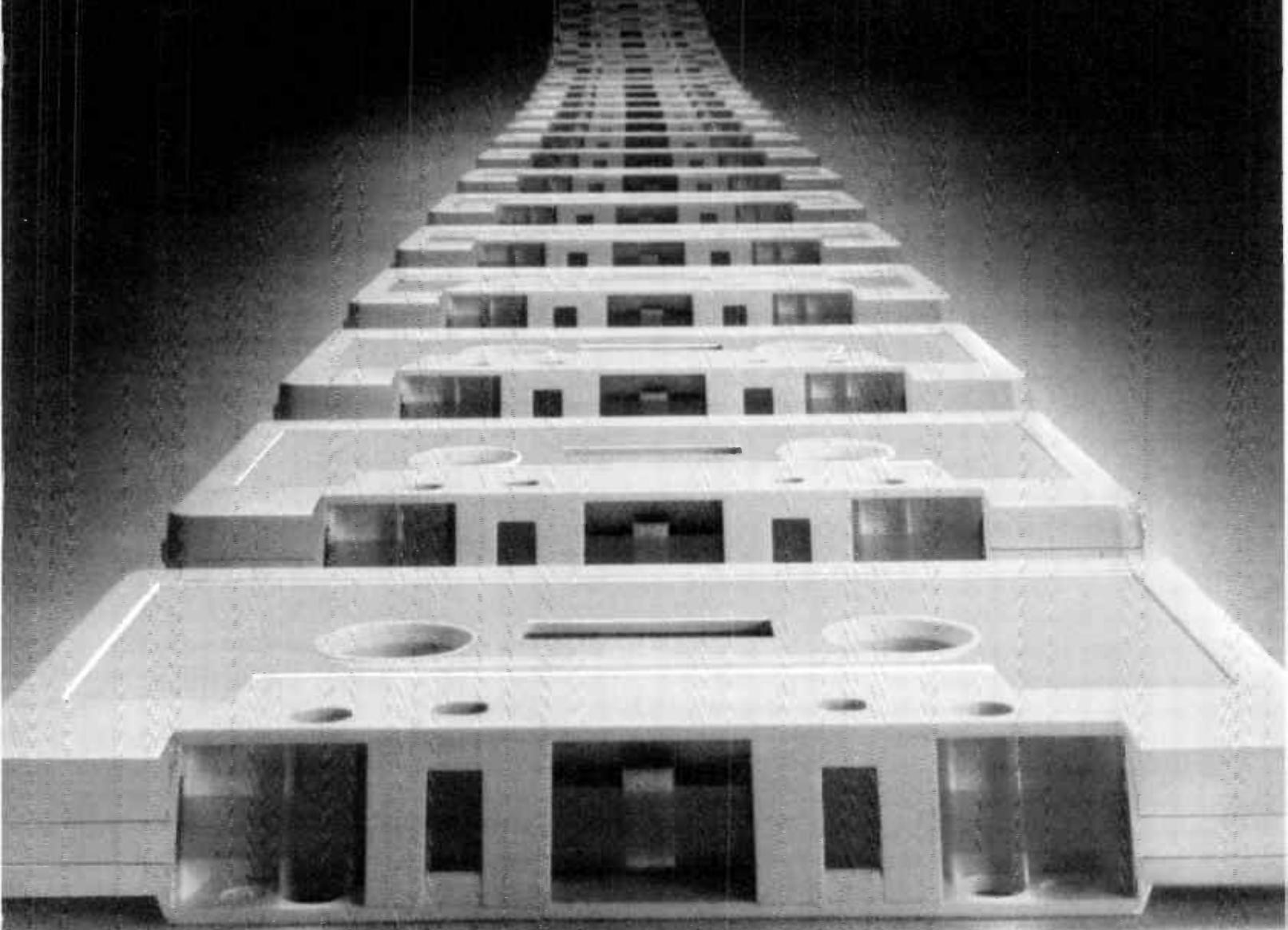

Top quality cassettes ...in quantity.

At Data Packaging, we manufacture, assemble and ship over a million cassettes every week. Our high production capabilities here in the U.S. mean fast delivery to you... but we don't just make cassettes fast. We've shown the marketplace that Data Packaging quality is consistent, whether the order is 500 or 500,000. At Data Packaging, more than 35 years of experience in injection-molding technology works to your sales advantage.

Find out for yourself why Data Packaging quality sells over a million cassettes a week. Call the Audio/Video Division of Data Packaging for more information.

Data Packaging packs quality in every product

- CO cassettes
(weld and screw type)
- mini-cassettes
- micro-cassettes
- 8-track cartridges
- custom tape winding
- storage units for cassettes,
8-tracks and records



 **DATA PACKAGING
CORPORATION**
AUDIO/VIDEO DIVISION
205 Broadway, Cambridge, MA 02139
Corporate Offices: (617) 868-6200
National Sales Office: (317) 776-0066

Sales Offices: Birmingham, Ala. PO Box 845 Zip 35205 Tel (205) 823-6132—Glendale, Calif., 500 Rodier Dr. Zip: 91201. Tel: (213) 240-5000—San Diego, Calif., PO Box 99847 Zip: 92109 Tel: (714) 272-8337—Denver, Colo., 2124 S. Birch. Zip: 80222. Tel: (303) 757-1829/6491—Orlando, Fla., PO Box 15008-B Zip 32808 Tel (305) 423-2962—Atlanta, Ga., 3135 Chestnut Or. Suite 101. Zip 30340. Tel: (404) 451-7112—Honolulu, Hawaii, PO Box 25367 Zip 96825 Tel (808) 395-7144—Elk Grove Village, Ill., 2201 Lunt Ave. Zip 60007. Tel: (312) 593-6000—Overland Park, Kan., PO Box 7282 Zip 66207. Tel: (913) 383-1951—Florence, Ky., Elsenden Bldg. Zip 41042. Tel: (606) 371-1476—Baton Rouge, La., PO Box 14238. Zip: 70808. Tel: (504) 766-6270—Bethesda, Md., 10215 Fernwood Rd. Zip: 20034. Tel: (301) 530-8800—Framingham, Mass., PO Box 1020 Zip 01701. Tel: (617) 877-8060—Minneapolis, Minn., 5200 W. 73 St. Zip: 55435 Tel: (612) 835-5560—Elkhorn, Neb., PO Box 553. Zip 68022. Tel: (402) 556-3400—Hackensack, N.J., 65 Commerce Way. Zip 07601 Tel: (201) 489-7400—Williamstown, N.J., PO Box 513. Zip 08094. Phila Tel: (215) 887-7400—Buffalo, N.Y., PO Box 4 Zip 14221 Tel: (716) 586-2580—Cleveland, Ohio, PO Box 134. Zip 44212 Tel: (216) 225-1262—Nashville, Tenn., PO Box 120532. Zip 37212 Tel: (615) 256-4836—Dallas, Tex., 1615 Prudential Dr Zip 75235. Tel: (214) 637-5100—Houston, Tex., 5300 Telephone Rd. Zip 77087. Tel: (713) 928-3741—Salt Lake City, Utah, 2880 S. Main, Suite 111. Zip 84115. Tel: (801) 487-8181—Seattle, Wash., 628 Industry Or. Bldg 8. Zip 98188. Tel: (206) 575-0156
Audio: 8 tr. cassette, 7, 10½ & 14" reels.
Video: Beta, VHS & U matc cassette, open reel.
 Ampro Prod'n Inc., 150 Fifth Ave., New York, N.Y. 10011. Tel: (212) 243-

7726. Cable TAPEXXRON Telex 425233
Audio: 8 tr. cassette
 Analyst, see Pacific Int'l
 J.C. Anglum Co. Inc./Tapeponents Inc., Box 236, 36 Midvale Rd., Mountain Lakes, N.J. 07046 Tel: (201) 263-1442. Pres. J. Clifford Anglum.
Audio: 8 tr. cassette
 Athena Inds. Inc., 2200 Industrial Way S., Toms River, N.J. 08753. Tel: (201) 244-8500. Pres: Louis Ligator, Sales Mgr: Mark Chayel
Corp. office: Hauppauge, N.Y., 1290 Motor Pkwy Zip. 11787 Tel: (516) 234-2010.
Audio: Cassette & sub assemblies of cassette parts
 Audio Inds. Inc., Broad & Linden Aves., Ridgefield, N.J. 07657 Tel: (201) 945-4545.
Audio: 8 tr. cassette
 Burlington Audio Tapes Inc., 10 Commercial St., Hicksville, N.Y. 11801. Tel: (516) 433-4466. Pres: Ruth Schwartz. VP: Rudy Schwartz
Audio: Reels.
Brand name: Olympic
 Cadet Recs. Inc., 5810 S. Normandie Ave., Los Angeles, Calif. 90044. Tel: (213) 753-5121. Pres: Jules Bihari, Mgr.: Oon Macmillan
Branch: Park Ridge, N.J., 12 Maple Leaf Dr Zip 07656 Tel: (201) 391-3676 VP Sales & Mktg.: Robert K. Herrington.
Audio: 8 tr.
 Carter Corp., 1916 11 St., Rockford, Ill. 61101 Tel: (815) 397-3200 Cable: CARTERCORP. Pres: Robert L. Fleming. VP Sales & Mktg.: Sandra L. Fleming. Plant Mgr.: W. Skip Kruger
Audio: Reels.

Cassette Masters Corp., 2 Bashford St., Yonkers, N.Y. 10701. Tel: (914) 968-1605. Pres: Leonard Ripley.
Audio: Screw-type cassettes, mini-cassettes.
 Certron Corp., 1701 S. State College Blvd., Anaheim, Calif. 92806. Tel: (714) 634-4280. WATS (800) 854-3943. TWX: (901) 593-1611. Pres.: Edwyn Gamson. VP Mktg.: Ray Allen, Adv. Mgr.: Hal Wilde
Audio: 8 tr., cassette
 Custom Cartridge Inc., 341 Hill Ave., Nashville, Tenn. 37210. Tel: (615) 244-5668. Pres.: Cliff Tant.
Audio: 8 tr.
 Custom Dupl'n Inc., 6330-36 Arizona Circle, Los Angeles, Calif. 90045. Tel: (213) 670-5575. Pres.: Leonard Gross, Sales Mgr.: Bob Hvelty, Prod'n Jerr Gonzales
Audio: 8 tr., cassette.
Video: Beta & VHS cassette.
 D A K Inds. Inc., 10845 Vanowen St., North Hollywood, Calif. 91605. Tel: (213) 984-1559. WATS (800) 423-2636. Cable: OAKENT. Telex: 651396. Pres.: Orew Alan Kaplan
Audio: Cassettes, reels.
 Dalsung America Inc., 51 E. 42 St., New York, N.Y. 10017. Tel: (212) 682-6045.
Home office: Korea.
Audio & Video: Cassette
Brand names: Seca, Solfa
 Data Packaging Corp., 205 Broadway, Cambridge, Mass. 02139. Tel: (617) 868-6200. TWX: (710) 320-0885. Pres.: Otto Mornmstar. Exec. VP: Greg Mathus. VP Mktg.: Jere Hill, Sales & Mktg. Mgrs.: (audio-video): Gene Hull, (consumer): Peggy Harmatz.
Audio: 8 tr., cassette
 Dyna/Day Plastics Inc. (sub. of American Sound), 6270 S. Country Club Rd., Tucson, Ariz. 85706. Tel: (602) 746-1001. Pres: Frank S. Day, VP & Gen. Mgr.: Larry Rossier, Sales: Leslie Day
Sales offices: North Hollywood, Calif., 8120 Webb Ave. Zip 91604. Tel: (213) 768-6100. Sales Dir.: Bill Dawson-Closter, N.J., 317 Harrington Ave. Zip 07624. Tel: (201) 767-9033. VP Mktg.: Paul Adams.
Audio: 8 tr., cassette
 E H C. see Electronic Homes
 Electronic Homes Co., 1225 Broadway, Main Floor, New York, N.Y. 10001. Tel: (212) 725-0290. Bd Chm: George T. Saddler, Sales Mgr.: Elias Smyrnakis. Adv. Mgr.: Joe Gary
Audio: Cassette
Brand name: EHC
 El Mar Plastics Inc., 821 E. Artesia Blvd., Carson, Calif. 90746. Tel: (213) 327-3180. Cable: ELMAR TWX: (910) 346-6940. Pres.: Allen Schor
Audio: 8 tr., cassette (5-screw & sonic welded), 3", 5" & 7" open reels.
 Fidelipac Corp., 109 Gaither Dr., Mount Laurel, N.J. 08057. Tel: (609) 235-3511. TWX: (710) 897-0254. Pres.: Roger Thanhauser, Sales & Mktg. Mgr.: Arthur Constantine
Audio: NAB cartridges (A, AA, B & C sizes)
Brand names: Fidelipac, Master Cart
 Filam Nat'l Plastics Inc., 13984 S. Orange Ave., Paramount, Calif. 90723. Tel: (213) 630-2500.
Audio: 8 tr., cassette.
 Gabriel Mfg. Co. Inc., 125 S. Liberty Dr., Stony Point, N.Y. 10980. Tel: (914) 942-0100. Pres.: Ed Gabriel. VP: Richard Gabriel, Gen. Mgr.: Vin Tullo. Adv. Mgr.: Ellen Gabriel.
Audio: Cassette

Funny Looking

No matter how funny they look, you've loved our quality tape hubs, cassette boxes and locks.

Now, look at our new soft cassette box. Unbreakable, clear plastic is molded with four posts to grip the cassette firmly. The unique double locks are placed to insure no damage to tape or pressure pad when box is opened.

See, also, our efficient bulk cassette locks. Simply inserted into holes in the carton sides, they stop tape rotation, and save labor and money.

Still think they look funny?

FILAM NATIONAL PLASTICS INC.
 13984 S. Orange Ave.
 Paramount, Ca. 90723
 Phone: (213) 630-2500

IMPORTANT NOTICE

AUDIO INDUSTRIES
 Announces

- **NORELCO STYLE BOXES**
 40 MILLION PER YEAR
- **C-O CASSETTES**
- **CASSETTE & 8 TRACK TAPE**
- **CASSETTE COMPONENTS**
- **CASSETTE TABS**
- **BLANK CASSETTES**
 C-30, C-60, C-90,
 HEAD CLEANERS

HIGHEST QUALITY • LOW PRICES
 Call or Write

AUDIO INDUSTRIES
 Broad & Linden Aves. • Ridgefield, N.J. 07657
 Tel: 201-945-4545 • Telex 133396



SHAPE VIDEOBOX

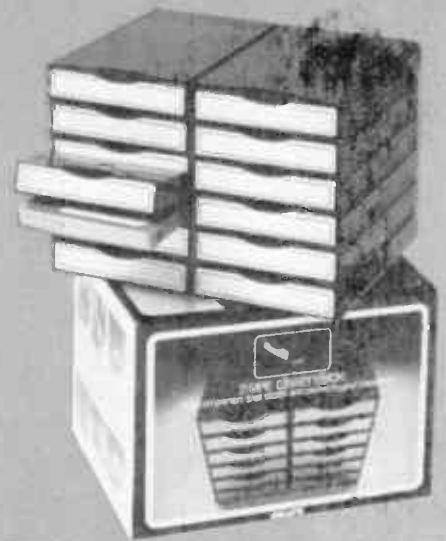

SHAPE CASSETTEBOX



VHS VIDEOCASSETTE

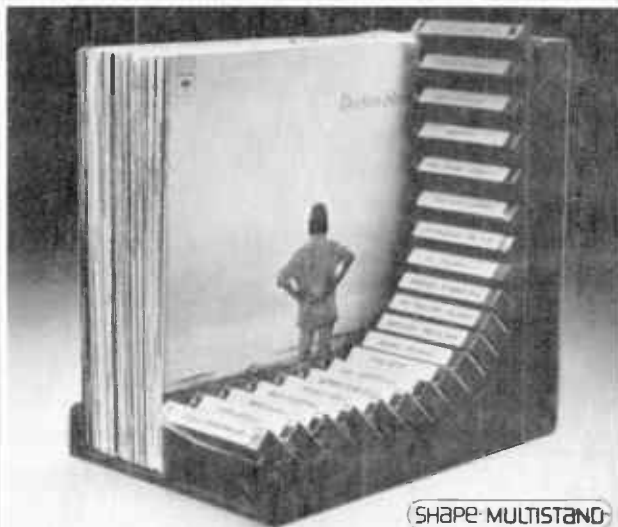

SHAPE MULTISTAND



8-TRACK



C-O CASSETTE



AUTOMATIC CASSETTE HUB LOADER



CASSETTE PACKAGING MACHINE

Creativity • Craftsmanship • Quality • That's SHAPE!

Shape Videobox—The expandable component storage system that interlocks to organize, protect and store both VHS and Beta tapes. Stack them vertically or horizontally to organize a video library.

Shape Cassettebox—The expandable component storage system for audio tapes. Each cassettebox interlocks with another to organize, protect and store cassettes at home, in car, van, boat or plane.

Shape Multistand—Multi-purpose to store cassettes, records, or video discs. Unique sleek design stores 30 records or 20 cassettes.

Automatic Cassette Hub Loader—Automatically feeds, orients and places hubs on spindles. All leader feeding, hub staking, leader winding and ejection are automatic.

C-O Cassette—Craftsmanship and quality control is built-in every 5 screw, sonic weld or computer grade cassette.

8-Track Cartridge—Specifically designed to coordinate the latest developments in molding and assembly.

VHS Videocassette—C-O Cassette or parts will be available to meet the expanding video software marketplace.

C-O Cassette & Packaging Machines—A complete line of machines for automatic and semi-automatic cassette assembly and packaging. Modular design allows all system applications to meet production requirements.

SHAPE®

Biddeford Industrial Park, Biddeford, Maine 04005
207/282-6155 Telex 944325 SHAPE INC. BIFD.

Hi Energy, see Ultra Specialty
 I P S, 107 Bridge Rd., Hauppauge, N.Y. 11787 Tel (516) 234 3322
Audio: Cassette
 I T I, see Investment Technology
 Investment Technology Inc., 1940 124 Ave NE, Bellevue, Wash 98005 Tel (206) 454 7720
Audio: Cassette
Brand name: ITI
 Joyce Molding Corp., 501 Division St., Boonton, N.J. 07005 Tel (201) 334 2020
Audio: 8 tr., cassette
Brand name: Max Sound
 Kyrac Corp., 2111 E 20 St., Tucson, Ariz 85719 Tel (602) 624-2408 Pres & Sales Mgr Keyvan Mokhtarian
Audio: Cassette
 L J S Corp., 1225 Broadway, Main Floor, New York, N.Y. 10001 Tel (212) 725 0290 Pres George T. Saddler, Gen Mgr H. Johnson, Sales Mgr H. Johnson, Sales Mgr Elias Smyrnakis
Audio: 8 tr., cassette
 Lenco Co., PO Box 160, 10240 Deerpark Rd., Waverly, Neb 68462 Tel (402) 786 7488 Pres Don Leonhardt, Mktg Dir Brad Harse, Sales Mgr Daryl Chappelle
Audio: 8 tr., cassette, reels
 Loranger Mfg Corp., Entertainment Prods Div., 10-48 Clark St., Warren, Pa. 16365 Tel (814) 723 8600 VP Robert Loranger
Audio: 8 tr., cassette
 M I P, see Molded Ind'l Plastics
 M J S, 2514 Seaboard Ave., San Jose, Calif 95131 Tel (408) 262 8793 Owner, Michael Steiner
Audio: 8 tr., cassette, reels
 M C C see Magnetic Mktg
 Magnetic Mktg Corp., 29 Valley View Terr., Wayne, N.J. 07470, Tel: (201) 694 3502 Telex 138558 Pres Thomas J. Hofbauer, Sales Mgr Brendan F. Browne, Adv Mgr M. Judge
Audio: 8 tr., cassette
Brand name: MMC
 Magnetic Media Corp., 500 Eastern Pkwy., Farmingdale, N.Y. 11735, Tel (516) 293 1010 Cable MAGMEDIA Telex 143223 Pres Aaron Waserstrom, Gen Mgr John Cristiano, Sales Mgr Paul Mastroianni
Audio: Cassette
 Marmac see Mastro
 Master Cart, see Fidelipac
 Mastro Inds Inc., 3040 Webster Ave. Bronx, N.Y. 10467 Tel (212) 547 5600 Pres Mario Maccatelli
Audio: 8 tr., cassette
Brand name: Marmac
 Max Sound, see Joyce Molding
 Meister Mfg Co., PO Box 633, Downey, Calif. 90241, Tel (213) 861-3198
Audio: 7", 8", 10", 10 1/2" aluminum reels
 Miami Tape Inc., 8180 NW 103 St., Hialeah Gardens, Fla 33015 Tel. (305) 558 9211
Audio: 8 tr., cassette
 Mission Plastics South Inc., 341 Hill Ave., Nashville, Tenn 37210 Tel (615) 244 5668

Factory: Jackson, Tenn., 74 Mission Dr Zip 38301 Tel (901) 423 0810
Audio: 8 tr cassette
 Molded Ind'l Plastics Inc., 151 Wakelee Ave., Ansonia, Conn 06401 Tel (203) 735 2331
Audio & Video: Reels
Brand name: MIP
 Olympic, see Burlington
 P R C Rec'g Co. (div of Richmond Rec'g Corp.), 1185 Ave. of the Americas, New York, N.Y. 10036 Tel (212) 997 1250 Pres Hugh T. Landy, VP Sales David Grant
 Plants: Compton, Calif., 18700 Laurelark Rd Zip 90220 Tel (213) 979 8545 Plant Mgr Dan Huber—Richmond, Ind., 1600 Rich Rd Zip 47374 Tel (317) 962-9511 Plant Mgr George Douglas
Audio: Cassette
 Pacific Int'l Magnetics Inc., 185 Berry St., No. 3865, San Francisco, Calif 94107 Tel (415) 495-8830
Home office: Canada
Audio: Cassette
Brand name: Analyst
 Plastic Reel Corp. of America, 46 Passaic St., Wood Ridge, N.J. 07075 Tel (201) 933 9125 Pres F. Giglio, VP & Gen Mgr Robert A. Miller, Sales Mgr Pat Baccarella
Audio: 2 1/2" 7" reels, hubs
Video: Reels for 1/2", 1" & 2" tape
Brand name: Pho Magic
 Pho Magic, see Plastic Reel
 Polyhne Corp., 1233 Rand Rd., Des Plaines, Ill 60016 Tel (312) 298-5300, Pres John Kaiser
Audio: Plastic reels
 Pro 1 Audio Visual Inc., PO Box 33, Highland Park, Ill 60035 Tel (312) 433 4575 Pres R.L. Pink, VP J. Pink, Sales Mgr Barry M. Pink, Adv Mgr D.D. Pink
Audio: Cassette
Video: Beta & VHS cassette
 Raynor Sales Co. Inc., 2698 W. Pico Blvd., Los Angeles, Calif 90006 Tel (213) 737 3737 Pres & Adv Mgr Ray Abrams Sr., Sales Mgr Ray Abrams Jr
Audio: 8 tr
 Robins Inds Corp., 75 Austin Blvd., Commack, N.Y. 11725 Tel (516) 543 5200 Pres Herman Post, VP Sales Stu Cane,
Audio: Cassette
Brand name: Brand 5
 Scotch, see 3M
 Seca, see Dalsung
 See Hear Inds (div of RJA Inc.), 120 W. 155 St., Gardena, Calif 90248 Tel (213) 516 0315 Pres Ray Jacobs, Sales Mgr Bernadette McNulty
Audio: 8 tr., cassette
Video: 1/2" U-matic cassette, 1/2" Beta & VHS cassette
 Sentry Inds Inc., 221 N. MacQuesten Pkwy., Mount Vernon, N.Y. 10550 Tel (914) 664-2909 Pres Harold Rosen, VP Barry Rosen
Audio: 8 tr., cassette
 Shape Inc., PO Box 366, Biddelford Ind'l Park, Biddelford, Me 04005 Tel (207) 282 6155
Audio: 8 tr., cassette
Video: VHS cassette
 Solfa, see Dalsung
 Studio Magnetics Co. Inc., 12 Long Island Ave., Holtsville, N.Y. 11742 Tel (516) 289 3400 Pres George Clahane, VP Craig M. Balaban
Audio: Screw type cassette
 Studio Quality, see Ultra Specialty
 T D K Electronics Corp., 755 Eastgate Blvd., Garden City, N.Y. 11530 Tel (516) 746 0880 Telex 144535 VP & Gen. Mgr Ken Kohda, Sales Mgr John Schattin, Video Prod. Mgr Ed Pessara
 Branches: Irvine, Calif. 2102 E. Alton St. Zip 92714 Tel (714) 979 5811 WAIS (800) 854-0123 Div. Mgr Lee Adams—Marietta, Ga. 4062 Kingston Court Zip 30067 Tel 952 4600 Reg'l Mgr George Casteel—Des Plaines, Ill., 1011 E. Touhy Ave., Suite 165 Zip 60018 Tel. 297 1341 WAIS (800) 323-5956 Reg'l Mgr. Jack Pender
Audio: 7" & 10" metal reels
 Tape A Thon Corp./CaVox Stereo Prod'ns, 502 S. Isis Ave., Inglewood, Calif 90301 Tel (213) 776 7933 WAIS (800) 421 1029 Pres Lee Tate, Sales Dir Robert Mayfield
Audio: Cassette, open reel, NAB cartridge
 Tapemaker Sales Co., 48 Urban Ave., Westbury, N.Y. 11590 Tel (516) 333 2700 Pres Arthur Brandwein, Office Mgr Karen Stikoff
Video: Beta & VHS cassette
 Tapeponents Inc., see J C Anglum
 Thalco Audio Inc., 2 Dickens Ave., Dix Hills, N.Y. 11746 Tel (516) 667 1616 Chief Exec Michael Thaler
Audio: 8 tr., cassette
Video: Beta & VHS cassette
 3 M Co. Audio/Video Prods Div., 3M Center, St. Paul, Minn 55144 Tel (612) 733 1466 Corp VP P. D. Denham, Div VP J. E. Povolny, Mktg Dir W.J. Madden, Nat'l Sales Mgr J.L. Leon, Mkt Opns Mgr J.B. Hanks Mkt Communications Mgr D.J. Linehan
 Branches: Anchorage, Alaska, 5531 Minnesota Dr Zip 99502 Tel (907) 276 2363—Burbank, Calif., 126 W. Elm Court Zip 91502 Tel (213) 848 5534—Los Angeles, Calif., 6023 S. Garfield Ave Zip 90040 Tel (213) 726-6300—South San Francisco, Calif., 320 Shaw Rd. Zip 94080 Tel (415) 589 2663—Washington, D.C., 1101 15 St. NW Zip 20005 Tel (202) 331 6900—Atlanta, Ga., 2860 Bankers Ind'l Dr Zip 30360 Tel (404) 447 7000—Honolulu, Hawaii, PO Box 30048, 4443 Malaas St Zip 96818—Argo, Ill., 6850 S. Harlem Ave Zip 60501 Tel (312) 496 6500—Needham Heights, Mass., 155 Fourth Ave Zip 02194 Tel (617) 449 0300—Farmington, Mich., 23923 Research Dr Zip 48024 Tel (313) 477 5000—Eagan, Minn., PO Box 33211 St. Paul 55133, 3130 Lexington Ave S Zip 55121 Tel (612) 733 3300—St. Louis, Mo., PO Box 510, 10725 Baur Blvd Zip 63166 Tel (314) 997 8500—West Caldwell, N.J., PO Box 76, 15 Henderson Dr Zip 07006 Tel (201) 575 2000—Cincinnati, Ohio, 4835 Para Dr Zip 45237 Tel: (513) 242 2313—Cleveland, Ohio, 12200 Brookpark Rd Zip 44130 Tel (216) 267 1800—Philadelphia, Pa., 5698 Rising Sun Ave Zip 19120 Tel (215) 728 5300—Dallas, Tex., 2121 Santa Anna Ave Zip 75228 Tel (214) 324 8100—Seattle, Wash., Andover Ind'l Park, 100 Andover Park W Zip 98188 Tel (206) 244-7200
Audio: Reels (1/2", 1/2", 1", 2" & 5", 7", 10", 14")
Video: Reels (2" 1")
Brand name: Scotch
 Trans Am Inds Inc., 845 Broad Ave., Ridgefield N.J. 07657 Tel (201) 945 2000
Audio: Sonic & Screw-type cassette
 U I C, see Universal Tape
 Ultra Specialty Inc., 20700 S. Belshaw Ave., Carson, Calif 90746 Tel (213) 537 8850 Cable ULTRASPEC Telex 194566 Pres Don Wong, Pres. UI

traspec Int'l Gary Lyle
Audio: Cassette
Video: 1/2" Beta & VHS cassette
Brand names: Hi Energy, Studio Quality, Ultra
 Universal Tape Corp. Inc., 821 E. Artesia Blvd., Carson, Calif. 90746 Tel (213) 327-3203 Pres Edward O. Praeger
Audio: 8 tr., cassette, open reel
Brand name: A/V Paragon, UTC, Universal

6 TAPE, BLANK LOADED, MANUFACTURERS

The numbers in parentheses following the 8-track & cassette configurations show recording time in minutes; those following open reel configurations (2", 1" & 1/4") show length of tape in feet.

A A, see Audio Accessories
 A & B Cassette Dupl'g, 1502 S. 87. West Allis, Wis 53214 Tel (414) 774 7250 Pres. Gen & Sales Mgr Judy Benz
Audio: Cassette
Brand name: Audio Max
 A I Pro, see Abbey Tape
 A/V Paragon, see Universal Tape
 Aard Vark Rec'g Inc., 335 S. Jefferson, Springfield, Mo 65806 Tel (417) 866-4104 Pres John Jacobsen
Audio: 8 tr (4.90 min), cassette (0.130 min)
Brand name: jdt
 Abbey Tape Dupl'r's, 5358 Cartwright Ave., North Hollywood, Calif 91601 Tel (213) 985 3136 Pres Norman C. Cooke
Audio: Cassette (2" 120)
Brand name: AI Pro
 Able Turntable & Tape, see AT&T
 Acme Dist. PO Box 8123, 5644 Holmes, Kansas City, Mo 64112 Tel (816) 444-8123 Pres Shirley Black, Sales Mgr Ward Black
Audio: Cassette (custom—1 to 120 min)
Video: 1/2" U-matic & 1/2" Beta & VHS cassette (custom lengths)
 Agra Gevaert Inc., 275 North St., Teherboro, N.J. 07608 Tel (201) 288 4100
Sales offices: Burlingame, Calif., 1633 Old Bayshore Hwy Zip 94010 Tel (415) 692 2432—Los Angeles, Calif., 1801 Century Park E Zip 90067 Tel (213) 552-9622—Atlanta, Ga., 380 Interstate N., Suite 200 Zip 30339 Tel (404) 955 4326—Oak Brook, Ill., 2803 Butterfield Rd., Suite 200 Zip 60521 Tel (312) 242-1915—Lexington, Mass., Lexington Office Center, Hayden Ave Zip 02173 Tel (617) 890-5430—Secaucus, N.J., 24 Meadowlands Pkwy., Suite 300 Zip 07094 Tel (201) 330-1800—New York, N.Y., 1 Penn Plaza, Rm 3527 Zip 10001 Tel (212) 279 2560—Dallas, Tex., 3003 LBJ Fwy., Suite 100, Zip 75234 Tel (214) 243 7315
Video: 2" quad, 1/2" U-matic cassette, 1/2" cassette
 Arko Magnetic Corp., 234 Fifth Ave., No. 304, New York, N.Y. 10001 Tel (212) 689 9332 Pres Elias Smyrnakis, Gen Mgr George T. Saddler, Sales Mgr H. Johnson
Audio: 8 tr., cassette, open reel
Brand names: Audio VU, Marmac, New Symphony, Olympia
 Awa America Inc., 35 Oxford Dr., Moonachie, N.J. 07074, Tel (201) 440-5220
Audio: Cassette (60.90, 120)
 American Sound Corp., 3319 E. Ten Mile Rd., Warren, Mich 48091 Tel (313) 539 2900 Pres Frank S. Day, VP & Gen Mgr Paul M. Hayes, VP & Sales Mgr Paul E. Adams
Branches: North Hollywood, Calif., 8120 Webb Ave Zip 91605 Tel (213) 768 6100 VP Paul Hayes, VP Mktg Paul Adams, Reg'l Sales Mgr William Dawson—Atlanta, Ga., American Sound Atlanta, 2091 Faulkner Rd. NE Zip 30324 Tel (404) 633 4577 Gen Mgr Matt Polakoff, Sales Mgr Peter Thomason—Closter, N.J., 317 Harrington Ave Zip 07624 Tel (201) 767 9033
Audio: 8 tr & cassette (custom lengths), open reel
 American Tape Corp. (div of VideoVision Inc.), 1116 Edgewater Ave., Ridgefield, N.J. 07657 Tel (201) 943-7860 VP Sales Gerry Gottlieb, VP Adm. Kathryn Marani-Mendenhall, Plant Mgr Francis A. Dermody
Audio: 8 tr. (0.80), cassette (0.90)
Brand name: Remington
 Ampex Corp., 401 Broadway, Redwood City, Calif 94063 Tel (415) 367 2011 Telex 348464. TWX (910) 378 5920
Sales Offices: Birmingham, Ala. PO Box 845 Zip 35205, Tel (205) 823 6132—Glendale, Calif., 500 Rodier Dr Zip 91201 Tel (213) 240-5000—San Diego, Calif., PO Box 99847, Zip 92109 Tel (714) 272 8337—Denver, Colo., 2124 S. Birch St Zip 80222 Tel (303) 757 1829/6491—Orlando, Fla., PO Box 15008 B Zip 32808 Tel (305) 423 2962—Atlanta, Ga., 3135 Chestnut Dr. Suite 101 Zip 30340 Tel (404) 451-7112—Honolulu, Hawaii, PO Box 25367 Zip 96825 Tel (808) 395 7144—Elk Grove Village, Ill., 2201 Lunt Ave Zip 60007 Tel (312) 593-6000—Overland Park, Kan., PO Box 7282 Zip 66207 Tel (913) 383 1951—Florence, Ky., Elsened Bldg Zip 41042 Tel (606) 371 1476—Baton Rouge, La., PO Box 14238 Zip 70808 Tel (504) 766 6270—Bethesda, Md., 10215 Fernwood Rd Zip 20034 Tel (301) 530-8800—Framingham, Mass., PO Box 1020 Zip 01701 Tel (617) 877 8060—Minneapolis, Minn., 5200 W. 73 St Zip 55435 Tel (612) 935 5560—Elkhorn, Neb., PO Box 553 Zip 68022 Tel (402) 556 3400—Hackensack, N.J., 65 Commerce Way Zip 07601 Tel (201) 489 7400—Williamstown, N.J., PO Box 513 Zip 08094 Phila Tel (215) 887 7650—Buffalo, N.Y., PO Box 4 Zip 14221 Tel (216) 225 1262—Nashville, Tenn., PO Box 120532 Zip 37212 Tel (615) 256 4836—Dallas, Tex., 1615 Prudential Dr Zip 75235 Tel (214) 637 5100—Houston, Tex., 5300 Telephone Rd. Zip 77087 Tel (713) 928 3741—Salt Lake City, Utah, 2880 S. Main, Suite 111 Zip 84115 Tel (801) 487 8181—Seattle, Wash., 628 Industry Dr. Bldg 8 Zip 98188 Tel (206) 575 0156
Audio: 8 tr. (45.90), cassette (45.60, 90, 120), open reel (1200', 1800', 2500', 3600') broadcast (600', 900', 2500', 3600', 5000')
Video: 2" quad, 1" open reel, 1/2" EIAJ open reel (1250', 2400'), 1/4" U-matic cassette (10-60), 1/2" Beta cassette (30.60, 120)

**CASSETTE-PARTS
STANDARD-SPECIAL
DOUBLED FLANGED ROLLERS
KEYHOLE HUBS
LEADER TAPE WINDOWS
SHIELDS SPRING PADS
STAKING ROD PINS
GRAPHITE COATED LINERS
CASSETTE SHELLS
SONIC - SCREW
RECORD TABS
CASSETTE TAPE
8 TRACK LUBE TAPE**

**DONNAK
INDUSTRIES**
P.O. Box 422
Ridgefield, N.J. 07657
(201) 945-6820
Telex: 133396

Ampro Prod'n Inc., 150 Fifth Ave., New York, N.Y. 10011 Tel. (212) 243 7726 Cable: TAPEXKRON Telex 425233
Audio: 8-tr. (40,60,80), cassette (30,60,90,120)
Analyst, see Pacific Int'l.
Ando Audio Prods. Inc., 4212 14 Ave., Brooklyn, N.Y. 11219 Tel. (212) 435 7322 Pres.: Anthony A. Maniere, Sales Mgr.: Rocco Salvatore, Adv. Mgr. Domenico Salvatore
Audio: 8-tr. & cassette (1-90).
Arista Entls. Inc., 35 Hoffman Ave., Hauppauge, N.Y. 11787. Tel. (516) 234-7000
Audio: 8-tr. (40,45,80,90), cassette (60,90).
Arrow Trading Co. Inc., 1115 Broadway, New York, N.Y. 10010. Tel. (212) 255-7688 (Audio only)
Associated Audio Servs. Inc., 181 Westchester Ave., Port Chester, N.Y. 10573. Tel. (914) 937-5129 Pres. D. Richard Kraus, VP Allan Johnson
Audio: 8-tr., cassette.
Brand name: Crusader
Athana Audio Prods. (div. of Arber Inds.) PO Box 3636, 1815 Mullin Ave., Torrance, Calif. 90510. Tel. (213) 320 1451
Audio: Cassette (custom lengths)
Audio Accessories Co., 38 W. 515 Deerpark Rd., Batavia, Ill. 60510 Tel. (312) 879-5998. Sales Mgr.: John S. Maloney
Audio: 8-tr., cassette, endless loop cassette (custom lengths), "private label" cassettes, open reel (1200").
Brand name: AA
Audiodyne Co., PO Box 825, San Jose, Calif. 95106 Tel. (408) 287-3520
Owner & Pres.: Louis R. Chiaramonte
Audio: 8-tr., cassette, open reel & broadcast (custom lengths)
AudioGraphics (div. of Herald Publ'g House), 3225 S. Noland Rd., Independence, Mo. 64055. Tel. (816) 252 5010
Audio: Cassette (standard & custom lengths)
Audio Inds. Inc., Broad & Linden Aves., Ridgefield, N.J. 07657 Tel. (201) 945-4545
Audio: 8-tr., cassette.
Audio Magnetics Corp., 2602 Michelson Dr., Irvine, Calif. 92716 Tel. (714) 833-0020. Pres.: Isidore Philosophie, VP Ind'l Prods.: Stewart B. Schlosberg, Nat'l Sales Mgr.: Charles Trausch
Audio: 8-tr. (45-90), cassette (45,60,90,120), open reel (1200", 1800", 2400").
Brand names: Tracs, High Performance
Audio Max, see A&B
Audiozap, see Capitol
Auditrack, see Little Warehouse
Audio VU, see Arko
AudioVisual Communications Inc., 435 Crooked Ln., King of Prussia, Pa. 19406 Tel. (215) 272-8500. Pres. John Baltantyne, VP Sales John Buttenworth
Audio: Cassette (custom lengths up to 120 minutes), open reel (up to 10 1/2" reels).
Autek, see Northwestern.
B A S F Systems Corp., Crosby Dr., Bedford, Mass. 01730. Tel. (617) 271 4000. Nat'l Sales Dir.: James S. Walker, Video Prod. Mgr.: Theodore Van Sickle
Branches: Santa Monica, Calif., 1307 Colorado Ave. Zip: 90404. Tel. (213) 451-8781—Atlanta, Ga., 3300 Buckeye Rd., Suite 403. Zip 30341. Tel. (404) 455-4145—Palatine, Ill., 800 E. Northwest Hwy., Suite 220 Zip 60067. Tel. (312) 934-4990—Ridgewood, N.J., 579 Franklin Tpk Zip 07450. Tel. (201) 447-6904
Audio: cassette (60,90), open reel (7"—1800", 2400")
Video: 1/2" Beta cassette (L-500), 1/4" VHS cassette (120)
Kenneth A. Bacon Assoc., 216 Montego Key, Novato, Calif. 94947 Tel. (415) 883-5041. Owner: Kenneth A. Bacon, Prod'n Mgr.: Rick Bacon
Audio: Cassette, open reel.
Brand name: KABA
Bazzy Electronics Corp., 39 N. Rose, Mount Clemens, Mich. 48043 Tel. (313) 463-2592.
Audio: 8-tr., cassette (custom lengths).
Betamax, see Sony.
Bethany Fellowship Inc., 682C Auto Club Rd., Minneapolis, Minn. 55438 Tel. (612) 944-2121. Cable: BETHANY Pres. T.A. Hegre, Gen. Mgr. M.F. Johnson, Sales Mgr.: Bill Linder
Audio: Cassette (custom lengths)
Bonnevillie Prod'n, 130 Social Hall Ave., Salt Lake City, Utah 84111 Tel. (801) 237-2400 TWX (910) 925-5266
Audio: Cassette (30,45,60,90,120)
Bradley Entls. Inc., 108 Galewood Rd., Timonium, Md. 21093. Tel. (301) 252-8520. Pres.: Joe Bradley, Exec. Ass't Stephen J. Rosasco.
Audio: Cassette.
Brand 5, see Robins.
Broadcast Electronics Inc. (a Filmways Co.), 4100 N. 24 St., Quincy, Ill. 62301. Tel. (217) 224-9500. Cable: SPOTMASTER Telex: 250142. Pres.: Lawrence J. Cervon, VP Mktg.: Curtis I. Krngg, Sales Mgr.: J. Engle, Adv. Mgr. Thomas R. Humphrey
Broadcast 1, see RKO.
Burlington Audio Tapes Inc., 10 Commercial St., Hicksville, N.Y. 11801 Tel. (516) 433-4466. Pres.: Ruth Schwartz, VP Rudy Schwartz.
Audio: Cassette, open reel.
Video: 1/2" Beta & VHS cassette
C E S Rec'g Inc., 4960 S. 83 East Ave., Tulsa, Okla. 74145 Tel. (918) 627-8474. Pres.: Basil W. Thomas, Gen. Mgr.: Judy McAlister
Audio: 8-tr., cassette (custom lengths up to 90 min)
Video: 1/2" Beta & VHS cassette
C L C, see International Audio.
Caltron, see Horan Eng'g.
Capitol Magnetic Prods. (div. of Capitol Recs. Inc.), 6902 Sunset Blvd., Hollywood, Calif. 90028. Tel. (213) 461-2701. Pres. Edward C. Khoury, VP Mktg. Adm'n.: John Apsitts, VP Domestic Sales Larry Hockemeyer, VP Int'l Sales: Bud Jackson, Mktg. Coord. Natalie Goss.
Sales offices: Atlanta, Ga., 1670 NE Freeway Access Rd. Zip 30329 Tel. (404) 321-5441—Niles, Ill., 6401 Gross Point Rd. Zip 60648 Tel. (312) 775-7101—New York, N.Y., 1370 Ave of the Americas Zip 10019. Tel. (212) 757-7470.
Int'l brand: Singapore
Audio: Broadcast cartridge (custom lengths)
Brand name: Audiopak
Carter-Craft, see Carter Corp.
Carter Corp., 1916 11 St., Rockford, Ill. 61101. Tel. (815) 397-3200. Cable: CARTERCORP. Pres.: Robert L. Fleming, VP Sales & Mktg.: Sandra L. Fleming, Plant Mgr.: W. Skip Kruger.
Audio: Cassette (10-90)
Brand name: Carter-Craft
Cassette Masters Corp., 2 Bashford St., Yonkers, N.Y. 10701. Tel. (914) 968-1605. Pres.: Leonard Ripley, Gen. & Sales Mgr. V.J. DePaul
Audio: Cassette.

Video: 1/4" U-matic cassette, 1/2" Beta & VHS cassette
Cassette Servs., 815 N. Douglas St., Arlington Heights, Ill. 60004 Tel. (312) 398 8403 Owner & Pres. Willis J. Connor, Sales Mgr. Michael Connor
Audio: Cassette
Brand name: Hi-Q
Century Audio & Development Inc., 1018 Busse Hwy., Park Ridge, Ill. 60068 Tel. (312) 696-0675.
Audio: Cassette (47,62,92,122)
Certron Corp., 1701 S. State College Blvd., Anaheim, Calif. 92806. Tel. (714) 634-4280; WATS (800) 854-3943. TWX (910) 593 1611. Pres.: Edwin Gamson, VP Mktg.: Ray Allen, Sales Mgr. Monica Terrill, Adv. Mgr. Hal Wilde
Audio: 8-tr. (45,65,90), cassette (30,60,90)
Chase Media Inc., Busch Park, 5284 S. 320 W., Suite C 166, Salt Lake City, Utah 84107 Tel. (801) 261-1383 Pres. & Gen. Mgr. Randal S. Chase.
Sales Mgr. Irel Chase
Audio: 8-tr. (standard lengths), cassette, open reel (custom lengths)
Christian Dupl'ns Inc., 1710 Lee Rd., Orlando, Fla. 32810 Tel. (305) 299 7363
Audio: Cassette, open reel (custom lengths)
Colorchrome, see RKO.
Col Tape, see Columbia Pictures
Columbia Pictures Videocassette Servs., 1501 Landmeier Rd., Elk Grove Village, Ill. 60007 Tel. (312) 640-2350 Telex 206923 Exec. VP: George M. Ricci, Bus. Mgr. T. Martin Rennels
Video: 1/2" U-matic cassette
Brand name: Col Tape
Continental Electronics, 4087 Clencoe Ave., Marina del Rey, Calif. 90291 Tel. (213) 822-2045 Sales Mgr. John Adams
Audio: Cassette (45,60,90,120)
Cory Sound Co., 310 Townsend, San Francisco, Calif. 94107 Tel. (415) 543 0440 Contact: Phillip Markinson
Audio: Cassette, open reel (custom lengths)
Creative Communications Inc. (sub of SMI), 920 N. Valley Mills, Waco, Tex. 76710 Tel. (817) 776-6553
Audio: Cassette
Criteron, see Lafayette
Crolyn, see E.I. du Pont.
Crusader, see Associated Audio
Custom Tape Dupl'ns Inc., 341 Hill Ave., Nashville, Tenn. 37210 Tel. (615) 256 1728 Pres. L.C. Tant, Sales Mgr. Mike Tant
Audio: 8-tr. (5-90), cassette (5-12C)
D A K Inds Inc., 10845 Vanowen St., North Hollywood, Calif. 91605 Tel. (213) 984-1559 WATS (800) 423 2636 Cable: OAKENT Telex 651396 Pres. Drew Alan Kaplan
Audio: Cassette (30,60,90)
Daisung America Inc., 51 E. 42 St., New York, N.Y. 10017 Tel. (212) 682 6045
Home office: Korea.
Audio: 8-tr., cassette (30,60,90,120), open reel
Data Packaging Corp., 205 Broadway, Cambridge, Mass. 02139. Tel. (617) 868-6200. TWX (710) 320-0885. Pres. Otto Morningstar, Exec. VP Greg Mathus, VP Mktg.: Jerry Hill; Sales & Mktg. Mgrs. (audio-video): Gene Hull, (consumer) Peggy Harmatz
Audio: 8-tr., cassette (standard mini & micro—custom lengths)
Delta Magnetics Corp., 1901 McDonald Ave., Brooklyn, N.Y. 11223 Tel. (212) 627-6556 Telex 642271
Branch: Edison, N.J., PO Box 494 Zip 08817 Tel. (201) 287-8967
Audio: 8-tr. (40,64,80,100,120), cassette (60,90,120), open reel (7"—1200", 1800", 2400", 3600", 5"—1200", 1800")
Disco Party Prods., PO Box 905, South Bend, Ind. 46624 Tel. (219) 234-9104 Owner & Sales Mgr. Jim Van Zant, Adv. Mgr. Drew Leach
Audio: "Private label" cassettes (50)
Duotone Co. Inc., PO Box 1168, Miami, Fla. 33143 Tel. (305) 665-1121 Pres.: Stephen Nester Sr., Sales & Adv. Mgr. Stephen Gibson Nester
Audio: 8-tr. (35,70,80), cassette (30,60,90,120)
E I du Pont de Nemours & Co. Inc., Magnetic Prods. Div., Photo Prods Dept., du Pont Airport, Bldg. 1, Wilmington, Del. 19898 Tel. (302) 774 1000
Audio: Cassette (60,90,120)
Video: 1/2" U-matic cassette (10-90), 1/4" EIAJ open reel (1250", 1800", 2400", 3600"), 1/2" Beta (60 180 min.) & VHS (60-360 min.) cassette
Brand name: Crolyn.
Duratape, see Mallory.
E M C Corp., 180 E. Sixth St., St. Paul, Minn. 55101 Tel. (612) 227-7366 Pres. David E. Feinberg, VP Richard T. Stevens, Custom Sales Dir. C Carter
Audio: Cassette
Electronic Homes Co., 1225 Broadway, Main Floor, New York, N.Y. 10001 Tel. (212) 725 0290. Chm. George T. Saddler, Sales Mgr. Elias Smyrnakis, Adv. Mgr. Joe Gary
Audio: 8-tr., cassette, mini cassette, open reel
Brand names: Grandmaster, Mr. Cassette, Toyota
El Mar Plastics Inc., 821 E. Artesia Blvd., Carson, Calif. 90746 Tel. (213) 327 3180 Cable: ELMAR TWX (910) 346 6940 Pres. Allen Schor
Audio: 8-tr. (1-90)
Elvirue Rec'g Music Publ'g & Music Makers Network of America Prods., PO Box 3022, Wilmington, N.C. 28401 Tel. (910) 762-4001 Pres. John Lewis Jones, VP Betty F. Scavilla, Sales Mgr. James L. Wheeler, Adv. Mgr. J.D. Johnson
Audio: Cassette, open reel.
Brand name: Excellence.
Emerald, see Irish Magnetic
Exactime, see SSK
Excellence, see Elvirue.
Ferrodyn, see Westtape
Fidelipac Corp., 109 Garther Dr., Mount Laurel, N.J. 08057 Tel. (609) 235-3511 TWX (710) 897-0254 Pres. Roger Thanhauser, Sales & Mktg. Mgr. Arthur Constantine
Audio: Broadcast cartridge (all lengths)
Finebit Mfg. Co. Inc., 931 N. Citrus Ave., Hollywood, Calif. 90038 Tel. (213) 466-9511. Cable: COEXPORT Telex 698393 Pres. Alwin P. Schmid, VP & Tape Sales Mgr.: Joseph Bouzagliou, Sales Mgr. Manuel Munoz.
Audio: 8-tr., cassette, open reel.
Fleetwood Communications Co. Inc., 321 Revere St., Revere, Mass. 02151 Tel. (617) 289-6800. Pres.: V.P. Giarrusso, Gen. Mgr.: Raymond G. Samora, Sales Mgr.: Victor Mancini, Adv. Mgr. Robin Samora
Audio: 8-tr., cassette, open reel.
Video: 1/2" U-matic cassette, 1/4" cassette
4 Starr, see Le-Bo
Fuji Photo Film USA Inc., Magnetic Tape Div., 350 Fifth Ave., 70th Fl., New York, N.Y. 10018. Tel. (212) 736 3335 Cable: FUJIFILM VP & Gen. Mgr.

John Date, Nat'l Sales Mgr. John Bermingham, Adv. Mgr. Margaretha Bystrom
Audio: Cassette (46,60,90,120), "metal" tape cassette (46,60,90) broadcast (2200", 3400", 66600", 9600")
Video: 2" & 1" open reel, 1/4" cassette (10,15,20,30,60), 1/2" Beta cassette (15,30,30/60, 45/90, 60/120, 180/270), 1/4" VHS cassette (30, 60, 90, 120)
Gabriel Mfg Co Inc., 125 S. Liberty Dr., Stony Point, N.Y. 10980 Tel. (914) 942-0100 Pres.: Ed Gabriel, VP: Richard Gabriel, Gen. Mgr. Vin Tullio.
Adv. Mgr.: Ellen Gabriel.
Audio: 8-tr. (10-60), cassette (1-120)
General Cassette Corp., 2311 N. 35 Ave., Phoenix, Ariz. 85009 Tel. (602) 269 3111
Audio: Cassette
Video: 1/2" U-matic cassette, 1/4" Beta & VHS cassette
Grand Master Magnetic Tape Co., 1225 Broadway, Main Floor New York, N.Y. 10001 Tel. (212) 725 0290 Pres. George T. Saddler, Gen. Mgr. John J. Zimmerman, Sales Mgr. Elias Smyrnakis
Audio: 8-tr., cassette, open reel
Heritage, see International Audio
H I Entls Inc., 9537 Telstar Ave., Suite 121, El Monte, Calif. 91731. Tel. (213) 444 9224
Audio: Cassette (1-120).
High Fidelity Rec'g Inc., 1059 Porter, Wichita, Kan. 67203 Tel. (316) 262 6456
Audio: Cassette
High Performance, see Audio Magnetics
Hilo, see Magnetic Mktg
Hi-Q, see Cassette Servs
Hitachi Sales Corp. of America, 401 W. Artesia Blvd., Compton, Calif. 90220 Tel. (213) 774 5151
Audio: Cassette (60,90)
Horan Eng'g Inc., 600 Lake Emma Rd., Lake Mary Fla. 32746 Tel. (305) 323 2400 TWX (810) 856-0300 Pres. Richard C. Horan, Gen. Mgr. James Horan, Sales Mgr. Robert L. Horan, Adv. Mgr. Sue Coleman
Audio: Cassette (60, 90).
Brand name: Caltron.
Infonics Inc., PO Box 11111, 238 Hwy 212, Michigan City, Ind. 46360 Tel. (219) 879 3381 Telex 233111
Audio: 8-tr., cassette, open reel & broadcast (custom lengths)
Brand name: Phoenix
Instart, see Pacific Int'l
Intermagnetics Corp., 1311 Colorado Ave., Santa Monica, Calif. 90404 Tel. (213) 393 9281
International Audio Inc., 2934 Malmo Dr., Arlington Heights, Ill. 60005 Tel. (312) 956 6030
Audio: 8-tr. (45,64,90), cassette (1 1/2), broadcast (10 sec-12 min.)
Video: 1/2" U-matic cassette (5,10,20,30,60)
Brand names: CLC, Heritage, International Audio, Videospot
Irish Magnetic Rec'g Tape (div. of Morhan Nat'l Sales Co. Inc.), 270-78 New Town Rd., Plainville, N.Y. 11803. Tel. (516) 293 5582 Cable: MORHA NEW Telex 96-7880. Pres. G. Zigman, Sales Mgr. George Krug, Adv. Mgr. George Taub
Audio: 8-tr., cassette, open reel
Video: 1/2" EIAJ open reel, 1/4" U-matic cassette, 1/2" Beta & VHS cassette
Brand names: Audio—Emerald, Irish, Video—Irish
Itera Ltd., 1535 Broad St., North Bellmore, N.Y. 11710 Tel. (516) 785 6480
Audio: 8-tr. (35-80), cassette (30 120)
J & I, see Aard Vark
J & I Cassette, 23947 Ventura Blvd., Calabasas, Calif. 91302 Tel. (213) 992 6200 Pres. John F. Brennan, Sales & Adv. Mgr. Ivy Brennan.
Audio: Cassette, open reel (custom lengths)
Video: 1/2" U-matic cassette, 1/4" Beta & VHS cassette (custom lengths)
J V C Inds. Co., 41 Slater Dr., Elmwood Park, N.J. 07407 Tel. (201) 794-3900. Pres. N. Sakoda, Sales Mgr.: Harry Elias, Adv. Mgr. Cliff Shearer.
Video: 1/2" U-matic cassette (15,20,30,60), 1/4" EIAJ open reel, 1/2" VHS cassette.
K A B A, see Kenneth A. Bacon
Ken-Del Prods Inc., 111 Valley Rd., Richardson Park, Del. 19804. Tel. (302) 655 7488.
Audio: Cassette. (custom lengths)
Kim Pat Ents., PO Box 654, Hillwood Dr., Fayetteville, Tenn. 37334. Tel. (615) 433-2323/5661
Audio: 8-tr. (custom lengths)
Kyrac Corp., 2111 E. 20 St., Tucson, Ariz. 85719 Tel. (602) 624-2408. Pres. & Sales Mgr. Keyvan Mokhtarian
Audio: 8-tr., cassette & open reel (custom lengths)
L J S Corp., 1225 Broadway, Main Floor, New York, N.Y. 10001 Tel. (212) 725-0290. Pres.: George T. Saddler; Gen. Mgr. H. Johnson, Sales Mgr. Elias Smyrnakis.
Audio: 8-tr., cassette.
Brand name: Lear Jet Stereo-High Performance
Lafayette Radio Electronics, 111 Jericho Tpk., Syosset, N.Y. 11791 Tel. (516) 921 7700
Audio: 8-tr., cassette, open reel
Brand name: Criterion.
Laser, see Swire Intermagnetics
Lear Jet Stereo, see LJS Corp.
Le Bo Prods Co. Inc. (div. of Peerless VidTronics Corp.), 58-60 Grand Ave., Masspet, N.Y. 11378 Tel. (212) 894 5155 Cable: LEBOPRODUX. Telex 427490. Pres. P. Dayton
Audio: 8-tr. (40-90), cassette (60,90)
Brand name: 4 Starr.
Lecture Brand, see Robins.
Lecturecassette, see Pacific Int'l.
Leda, see Continental Electronics.
Lettercassette, see Pacific Int'l.
Lion Rec'g Servs. Inc., 1905 Franklin Ave. NE, Washington, D.C. 20002. Tel. (202) 832 7883. Pres.: Harold H. Lion, Sales & Adv. Mgr. Jim Fox.
Audio: Cassette, open reel (custom lengths)
Little Warehouse Inc., 1820 W. Schaaf Rd., Cleveland, Ohio 44109 Tel. (216) 398-0022
Audio: 8-tr. (1 1/2), cassette (1 1/2), open reel
Brand name: Audiotrack
M J S, 2514 Seaboard Ave., San Jose, Calif. 95131 Tel. (408) 262-8793
Owner: Michael Steiner.
Audio: 8-tr. (46,60,90,100), cassette (46,62,92,120), open reel (1800"), broadcast (1-22 min.)
M M C, see Magnetic Mktg.
Magnetic Mktg. Corp., 29 Valley View Terr., Wayne, N.J. 07470 Tel. (201) 694-3502 Telex: 138558. Pres.: Thomas J. Hoffbauer, Sales Mgr.: Brendan F. Browne, Adv. Mgr. M. Judge
Audio: 8-tr., cassette (60,90,120), open reel, broadcast
Brand name: Hilo, MMC

Magnetix Corp., 770 W Bay St., Winter Garden, Fla. 32787 Tel (305) 656-4494. Pres: John Lory
Audio: 8-tr., cassette, open reel, broadcast.
Video: 1" open reel, 1/2" EIAJ open reel

Mallory Dist. Prods Co, 3029 E. Washington Ave., Indianapolis, Ind 46201 Tel (317) 636 5353
Audio: 8-tr. (45.90), cassette (30.45.60.90.120)
Brand name: Duratape

Mann Endless Cassette Inds Corp., PO Box 1347, San Francisco, Calif 94101. Tel. (415) 221-2000. Pres. Donald Mann, Sales Mgr. Robert Wells, Adv. Mgr. Bob Kline
Audio: Standard "Philips type" endless cassettes. (10 sec to 20 min lengths)

Marmac, see Airko & Mastro

Mastro Inds. Inc., 3040 Webster Ave., Bronx, N.Y. 10467 Tel (212) 547-5600. Pres: Mario Maccaferri.
Audio: 8-tr. (45.90), cassette (30.45.60.90.120).
Brand name: Marmac

Mazell Corp. of America, 60 Oxford Dr., Moonachie, N.J. 07074 Tel (201) 440-8020. Pres T Okada, Nat'l Sales Mgrs (consumer audio) M Stand ley, (consumer video) D Patrician. (professional/industrial prods) J Ringwood, Adv Mgr Chris Mangiapane
Audio: 8-tr. (46.60.90), cassette (46.60.90.120), open reel (1800")
Video: 1/2" EIAJ open reel (1200", 2400"), 1/4" U-matic cassette (30.60), 1/2" Beta cassette (L 250, L 500, L 750), 1/2" VHS cassette (30.60.90.120 min)

Media Int'l Inc, 425 N Michigan, Chicago, Ill 60611 Tel (312) 467-5430 Pres Duane Lundeen, VP Margaret Lundeen, Gen Mgr Al Masters
Audio: 8-tr., cassette, open reel, broadcast (custom lengths)

Memorex Corp., Consumer Prods. Group, 1600 Memorex Dr., Santa Clara, Calif 95052. Tel (408) 987-1752. Telex 334492. VP & Gen Mgr John R Humphreys, Mktg Mgr. Albert P. Pepper, Nat'l Sales Mgr Jack C Battaglia
Branches: Garden Grove, Calif., 12821 Western Ave., Suite L, Zip 92641 Tel (714) 891-2541—Lombard, Ill., 335 Eisenhower Ln S Zip 60148 Tel: (312) 620-3240—Cincinnati, Ohio, 8170 Corporate Park Dr. Zip: 45242. Tel: (513) 891 3380—King of Prussia, Pa., 741 Fifth Ave Zip 19406. Tel. (215) 337 1050—McLean, Va., 1970 Chain Bridge Rd Zip 22101 Tel (703) 821 3300—Lynnwood, Wash., 4208 198 St. SW, Suite 110 Zip. 98036 Tel (206) 774 6507
Audio: 8-tr. (45.60.90), cassette (30.45.60.90.120)
Video: 1/2" VHS cassette (30.60.90.120), 1/2" Beta cassette (L 250, L 500, L 750).

Memory Media Prods., 1417 E Edinger Ave., Santa Ana, Calif 92705 Tel (714) 835-0317 Pres Edward A Conti, Sales & Adv Mgr Murray L Shackelford.
Audio: Cassette, open reel
Video: 1" open reel, 1/4" U matic cassette, 1/2" EIAJ open reel, 1/2" Beta & VHS cassette
Brand name: Spectrum

Metacorn Inc., 1401 BW River Rd N., Minneapolis, Minn 55411 Tel (612) 588-2781 Pres James I McCann, Sales Mgr Phillip T Levin Adv Mgr Timothy Devilbiss
Audio: Cassette (33.60.63.90.93.120.123)
Brand name: Rezonud

Miami Tape Inc., 8180 NW 103 St., Hialeah Gardens, Fla 33015 Tel (305) 558-9211

Audio: 8-tr (40.60.90), cassette (40.60.90.120)

Michele Audio Corp., Box 566, Andrews Street Rd., Massena N.Y. 13662 Tel (315) 769 2448. Pres Gnette Cormier, Sales Mgr Harold Friedman, Mgr Jack Daniels
Audio: 8-tr (40.60.80.90), cassette (60.90.120)
Brand names: Michele, Michele

Musical Tapes Inc., 770 W 27 St., Hialeah Fla 33010 Tel (305) 885-9156 Pres Eliseo C. Valdes
Audio: 8-tr., cassette

Musicalcassette Dupl'rs of Hawaii, PO Box 22190, Honolulu, Hawaii 96822 Tel (808) 533 4165
Audio: Cassette (30.45.60.90 & custom lengths), open reel (1200", 1800")

Nagra Magnetic Rec'rs Inc. 19 W 44 St New York, N.Y. 10036 Tel (212) 840-0999
Audio: Open reel

Nakamichi USA Corp., 1101 Colorado Ave Santa Monica, Calif 90401 Tel (213) 451-5901 Telex 652429 Pres E Nakamichi, VP & Nat'l Sales Mgr Katsura Izumi
Audio: Cassette (60.90)

Nassau, see Telephone Dynamics

New Symphony, see Airko

North American Tape Dupl'g Co., 15414 Cabrillo Rd., Van Nuys, Calif. 91406 Tel (213) 781 7650 VP & Gen Mgr Norm Teter, Mktg Dir Larry Stagnaro
Audio: 8-tr cassette (45.60.90.120)

Northwestern Inc 1224 SW Broadway, Portland Ore 97205 Tel (503) 226 0170 Pres Robert M Lindahl, Sales Mgr Paul A Buescher
Audio: Cassette (custom loaded)
Brand names: Aulek Northwestern

Olympia, see Airko

P S C Prod'ns, 985 Waimanu St., Honolulu Hawaii 96814 Tel (808) 537-5695 Pres Michael Tanaka
Audio: Cassette (30.45.60.90 & custom lengths), open reel (1200", 1800")

Pacific Int'l Magnetics Inc 185 Berry St No 3865 San Francisco, Calif 94107 Tel (415) 495 8830
Home office: Canada
Audio: Cassette, open reel
Video: 1/2" Beta & VHS cassette
Brand names: Audio-Analyst, Instart Lecturecassette, Lettercassette, & "private" label, Video-Analyst

Panasonic Co (div of Matsushita Electronic Corp of America), 1 Panasonic Way, Secaucus, N.J. 07094 Tel (201) 348 7000
Branches: Duluth, Ga., 2 Meca Way Zip 30136 Tel (404) 448 5683—Elk Grove Village, Ill., 1098 Greenleaf Ave Zip 60007 Tel (312) 593 0710—Irving, Tex., 1825 Walnut Hills Ln Zip 75062 Tel (214) 256 1388
Audio: Cassette (60.90)
Video: 1/2" VHS cassette, 1/2" EIAJ open reel, 1/2" EIAJ cartridge

Park, see Robins

Pentagon Inds Inc 4751 N Olcott Ave., Chicago Ill 60656 Tel (312) 867-9200 Pres Tom Horton, VP Mktg James R Dow, Sales Mgr Joe Holtenkamp
Audio: Cassette (10 120)

Phoenix see Infonics.

Phylco Audio, 4709 Brooks St., Montclair, Calif 91763 Tel (714) 621-9561
Owner: Robert Deates, Gen Mgr Rick Deates.
Audio: Cassette, open reel.

Pro, see Memorex

The Pro, see Utopia Ultra Sound

Programming Technologies Inc., 6666 N Lincoln Ave., Lincolnwood, Ill 60645 Tel (312) 676 9400 Sales Mgr Steve Sorokin
Audio: Cassette

Pro 1 Audio Visual Inc., PO Box 33, Highland Park, Ill 60035 Tel: (312) 433 4574 Pres R L Pink, VP J Pink, Sales Mgr M M Pink, Adv. Mgr D D. Pink
Audio: Cassette

Project 70 Audio Servs Inc., 1127 Spring St NW, Atlanta, Ga. 30309 Tel (404) 875 7008
Audio: Cassette (custom lengths for duplicators)

Quantitape, see Sound Studios.

R K O Tape Corp., 3 Fairfield Crescent, West Caldwell, N.J. 07006 Tel (201) 575 8484 VP & Gen Mgr Hugh Wallace
Audio: Cassette (60.90)
Video: 1/2" Beta cassette (L 250, 500 & 750)
Brand names: Audio—Broadcast 1, Ultrachrome Video—Colorchrome Radio Shack (div of Tandy Corp.), 1 Tandy Center, Fort Worth, Tex. 76086 Tel (817) 390 3272
Audio: 8 tr (45.90), cassette (30.45.60.90.120), open reel (900", 1200", 1800", 2400", 3600")
Brand names: Realistic, Supertape

Bill Rase Prod'ns Inc., 955 Venture Court, Sacramento, Calif 95825 Tel (916) 929-9181 Owner & Pres Bill Rase.
Audio: Cassette (custom lengths)

Raynor Sales Co Inc 2698 W Pico Blvd., Los Angeles, Calif 90006 Tel (213) 737 3737 Pres & Adv Mgr Ray Abrams Sr., Sales Mgr Ray Abrams Jr
Audio: 8 tr

Realistic, see Radio Shack

Recorded Publ'ns Labs (div of Recorded Publ'ns Mfg Co Inc.), 1100 State St., Camden N.J. 08105. Tel (609) 963 3000, Phila (215) 922-8558 Pres David H Goodman, Sales Mgr Pat Landon Adv Mgr Edward J Goodman
Audio: 8 tr cassette open reel (custom lengths)

Recording Servs of Western North Carolina Inc., 10 Penland St., Canton, N.C. 28716 Tel (704) 648 6012 Pres J Ted Evans, VP Kay Evans
Audio: 8 tr, cassette (custom lengths).

Recording Studios 55 (div of 3 G Inds.), 5500 Troost, Kansas City, Mo 64110 Tel (816) 361 8455 Chief Eng Mike Green, Gen Mgr Eugene Cold, Sales Mgr C King
Audio: 8 tr, cassette

Recortec Inc., 475 Ellis St., Mountain View Calif 94043 Tel (415) 962 0220 TWX (910) 379 5022. Pres Or Lester H Lee, Sales Mgr. Ron R Troell
Audio: Cassette (custom lengths)
Video: 1/2" U matic cassette (5 60 min)

Recoton Corp., 46 23 Crane St., Long Island City, N.Y. 11101 Tel (212) 392 6442 Pres Robert Borchardt, Exec VP Peter Wish, VP Sales George Calvi
Audio: 8 tr (40.45.80.90.100), cassette (45.60.90.120), open reel (5" reel—600", 900", 1200", 1800", 7" reel—1200", 1800", 2400", 3600")

THE INCREDIBLE BULK
C A S S E T T E T A P E

CERTRON offers three tape formulas:

FEREX I—Our new premium tape formulation that can be used for recording studio masters. Imagine how extraordinary your duplicated copies will sound!

HIGH ENERGY—for quality music duplication.

LOW NOISE—For economical duplicating and loading.

FEATURES:

- **UNIFORM COATING THICKNESS**
- **PRECISION SLITTING**
- **HEAVY DUTY BINDER**—Virtually eliminates oxide shed
- **CONSISTENT QUALITY**
- **SAME DAY SHIPMENT OF RUSH ORDERS**—All tapes in inventory

Also available.
C-O's, cassette boxes and cassette labels.

certron

CONTACT: Certron Corporation, Industrial Products Division
1701 S. State College Blvd., Anaheim, Ca. 92806
(714) 634-4280 Toll Free: outside Calif. (800) 854-3943 TWX 910-5931611/ANS BACK: CERTRON ANH



the korean connection

Now there is a new source for C-O cassettes and high density cassette tape. It is Magnetic Media's sister company in Seoul, the Media Corporation. Together, they have combined American technology with Korean craftsmanship to bring the duplicator the best tape and cassettes in the world. Add value pricing to these high

performance products, and you also have the best deal around. Plus next day delivery, since ample stock is maintained in our stateside warehouses. Yes, our tape and cassettes are manufactured 10,000 miles away, but they are really only 10 digits away: 516 293 1010. So make this connection, and we'll send you free samples.



MAGNETIC MEDIA



Magnetic Media Corporation, 500 Eastern Parkway, Farmingdale, NY 11735 Tel: 516 293 1010

7 TAPE, BULK RAW, MANUFACTURERS

Remington, see American Tape.
Respond Int'l, 1190 Miraloma Way, Suite Y, Sunnyvale, Calif 94086 Tel (408) 245-1351. Cable: RESPOND TWX (910) 339-9317. Pres: Ronald L. Akin
Audio: 8-tr. (45), cassette (45.60.90), open reel
Reound, see Meta-Com.
Rite Rec. Prod'n Inc., 9745 Mangham Rd., Cincinnati, Ohio 45215. Tel (513) 733-5533. Owner: Carl J. Burkhardt. Pres: Philip M. Burkhardt. VP Prod'n: Lan A. Ackley; VP Graphics: Kenneth D. Keith. Sales Mgr: Dan Burton.
Audio: 8-tr., cassette, open reel (custom lengths)
Robins Inds Corp., 75 Austin Blvd., Commack, N.Y. 11725 Tel (516) 543 5200. Pres: Herman Post; VP Sales: Stu Carne
Audio: 8-tr. (40.64.80), cassette (60.90.120), mini cassette (30)
Brand names: Brand 5, Lecture, Park
S S K Ent's Inc., 2488 Townsgate Rd., Westlake Village, Calif 91361. Tel (805) 889-1831
Audio: 8-tr. (1-99)
Video: 1/2" Beta & VHS cassette (custom lengths)
Brand name: Exactime
Scotch, see 3M.
See Hear Inds (div. of RIA Inc.), 120 W 155 St., Gardena, Calif 90248 Tel (213) 516 0315. Pres: Ray Jacobs. Sales Mgr: Bernadette McNulty
Audio: Cassette (30-120), open reel
Video: 1/2" Beta cassette (L 250, L 500, L 750), 1/2" VHS cassette (120)
Sentry Inds Inc., 221 N MacQuesten Pkwy., Mount Vernon, N.Y. 10550 Tel (914) 664-2909. Cable: SENTIND. Pres: Harold Rosen. VP: Barry Rosen.
Audio: 8-tr. (40.80.100), cassette (30.60.90.120) open reel (1200', 1800', 2400')
Video: 1/2" Beta cassette.
SensuSound Inc., 35 W 45 St., New York, N.Y. 10036 Tel (212) 921 0555. Pres: Nat Levy; Gen & Sales Mgr: Mike Shapiro.
Audio: Cassette.
Shur Sound & Sight Inc., 3350 Scott Blvd., Bldg No. 5, Santa Clara, Calif 95051. Tel. (408) 727-7620. VP & Gen. Mgr: Glenn Cardon. VP Sales: Lonnie Cory
Audio: 8-tr., cassette, open reel (custom lengths)
Sony Corp. of America, 9 W 57 St., New York, N.Y. 10019. Tel. (212) 371-5800. Local branch: 47-47 Van Dam St., Long Island City 11101 Tel 361-8600.
Audio: 8-tr. (40.60.80), cassette (45.60.90.120), open reel.
Video: 2" quad, 1" open reel, 1/2" U-matic cassette, 1/4" EIAJ open reel, 1/4" Beta cassette.
Brand name: Betamax, U-Matic
Soundmark Corp., 4950 Nome St., Unit C Denver, Colo 80239 Tel (303) 371 3076
Audio: Cassette, open reel (custom lengths)
Sound/Pro Inds Inc., 7529 Trade Ave., Playa del Rey, Calif 90291 Tel (213) 822-0510. Pres: Donald K.M. Rotgryn. Nat'l Mktg Dir.: Don Millard; Sales Mgr.: Tom Reed; Adv. Mgr.: Linda Newton
Audio: 8-tr., cassette (custom lengths)
Video: 1/2" Beta cassette.
Sound Studios, 230 N Michigan Ave., Chicago, Ill 60601 Tel (312) 236 4814. Pres: Jerry Markham. VP & Gen Mgr: Oan Tynus
Audio: Cassette, open reel (custom lengths)
Brand name: Quantitape.
Spectrum, see Memory Media
Spectrum Fidelity Magnetics, 49 Glenwood Ave., Lancaster, Pa 17602 Tel (717) 295-9275.
Audio: 8-tr. (1-60), cassette (1-90), open reel
Stanford Int'l, PO Box 609, 569 Laurel St., San Carlos, Calif 94070 Tel (415) 592-5958. Pres: Fred Dobbs. Ops Mgr: Jan Ollard
Audio: Cassette
Mark Starr Corp., 1609 64 St., Emeryville, Calif 94608. Tel (415) 658 0109. Pres: Gary W Wood
Audio: Cassette (custom lengths)
Studio Magnetics Co. Inc., 12 Long Island Ave., Holtsville, N.Y. 11742. Pres: George Clahane; VP: Craig Bababan
Audio: Cassette (custom lengths), open reel
Video: 1/2" U-matic cassette (custom lengths)
Brand names: Studio Magnetics, Studio Master, Studio Pro, Studio Standard
Studio Master, see Studio Magnetics.
Studio Pro, see Studio Magnetics.
Studio Quality, see Ultra Specialty
Studio Standard, see Studio Magnetics.
Super Avilyn, see TOK
Superscope Inc., 22459 Paul Revere Dr., Woodland Hills, Calif 91364 Tel (213) 998-9333. Pres: Joseph Tushinsky. Mktg & Sales Mgr.: Bill Rosen.
Audio: 8-tr. (45.90), cassette (62.92.122)
Supertape, see Radio Shack
Swire Intermagnetics Co., 234 W. 146 St., Gardena, Calif 90248 Tel (213) 515 0494. Telex: 698238. Pres: Irving Katz, Exec. VP Sales & Mktg: James W. Lantz; Gen Mgr: Leonard A. Heming
Audio: 8-tr. (45.90), cassette (45.60.90.120)
Brand names: Laser, XL
T D K Electronics Corp., 755 Eastgate Blvd., Garden City, N.Y. 11530 Tel (516) 746-0880. Telex: 144535. VP & Gen. Mgr.: Ken Kohda; Sales Mgr.: John Schattin. Video Prod. Mgr.: Ed Passara
Branches: Irvine, Calif, 2102 E Alton St. Zip 92714 Tel (714) 979 5811. WATS (800) 854 0123. Div. Mgr.: Lee Adams—Marietta, Ga., 4062 Kingston Court. Zip: 30067. Tel (404) 952-4600. Reg'l Mgr.: George Cas Tel—Des Plaines, Ill., 1011 E. Touhy Ave., Suite 165. Zip 60018. Tel (312) 297-1341. WATS (800) 323-5956. Reg'l Mgr.: Jack Pender
Audio: 8-tr. (45.90), cassette (30.45.60.90.120.180) (labeled & unlabeled), open reel (1200', 1800', 3600')
Video: 1/2" VHS cassette (labeled & unlabeled)
Brand name: Super Avilyn.

T S I, see Tape Specialty
Tapecom Inc., 45 Jefferson St., Stamford, Conn 06902 Tel (203) 325 1541. TWX (710) 474 3334. Pres: Gene Tornatore. VP: Fred Luminoso.
Audio: 8-tr., cassette (custom lengths)
Tape Dupl'rs of Florida Inc., 785 W 83 St., Hialeah, Fla 33014 Tel (305) 822-7585
Audio: 8-tr., cassette (private brands)
Tape Head Co. Inc., 665 S State St., Salt Lake City, Utah 84111 Tel (801) 521 3839. Pres: Stan Schubach; Sales Mgr.: D. Montoya.
Audio: Cassette
Video: Open reel, 1/4" U-matic cassette, 1/2" Beta & VHS cassette
Brand name: Teleprosys
TapeMaker Sales Co. Inc., 48 Urban Ave., Westbury, N.Y. 11590 Tel (516) 333 2700. Pres: Arthur Brandwein; Office Mgr: Karen Sitkoff
Video: 1/2" Beta & VHS cassette
Brand name: Videotime
Tape Masters Inc., PO Box 38651, Dallas, Tex 75238 Tel (214) 349-0081
Audio: 8-tr. (45.60.90), cassette (45.60.90), open reel.
Tape Servs. Inc., Cherry Hill Ind'l Park, 1 Keystone Ave., Cherry Hill, N.J. 08003 Tel (609) 424 9450. Sales Mgr: Michael T. Mulcahy.
Audio: "Private label" 8-tr. (custom lengths)
Tape Specialty Inc., 13411 State City, North Hollywood, Calif 91605 Tel (213) 786-6111. Pres: Steve Feldman, Gen Mgr: Len Feldman, Chief Eng.: Stu Feldman
Audio: 8-tr., cassette (2 122)
Video: 1/2" Beta cassette
Brand name: TSI
Tappette Corp., 7221 Garden Grove Blvd., Suite K, Garden Grove, Calif 92641 Tel (714) 638-7960.
Audio: Cassette (1-94)
Telephone Dynamics Corp., 2473 A Jerusalem Ave., North Bellmore, N.Y. 11710 Tel (516) 221-9470.
Audio: Cassette, open reel (custom lengths)
Brand name: Nassau
Teleprosys, see Tape Head
Texas Rec. Mfg. Inc., 1422 W Poplar, San Antonio, Tex 78207 Tel (512) 733-6138. Pres: C. Foy Lee. Gen Mgr: Jimmy Burton. Sales Mgr: Jeanne Hill
Audio: 8-tr.
Thalco Audio Inc., 2 Dickens Ave., Dix Hills, N.Y. 11746 Tel (516) 667-1616. Chief Exec.: Michael Thaler
Audio: Cassette
Video: 1/2" Beta & VHS cassette
3 M Co. Audio/Video Prods. Div., 3M Center, St Paul Minn 55144 Tel (612) 733 1466. Corp. VP: O.E. Denham. Oiv VP: John Povolny. Mktg Dir: W.J. Madden. Nat'l Sales Mgr: J.L. Leon. Mkt. Opls. Mgr.: J.B. Hanks. Mkt Communications Mgr: O.J. Linehan
Branches: Anchorage, Alaska, 5531 Minnesota Dr. Zip 99502 Tel (907) 276-2363—Burbank, Calif., 126 W Elm Court. Zip: 91502 Tel: (213) 848-5534—Los Angeles, Calif., 623 S. Garfield Ave. Zip 90040 Tel (213) 726 6300—South San Francisco, Calif., 320 Shaw Rd. Zip 94080 Tel: (415) 589 2663—Washington, D.C., 1101 15 St. N.W. Zip 20005. Tel: (202) 331 6900—Atlanta, Ga., 2860 Bankers Ind'l Or. Zip 30360 Tel (404) 447 7000—Honolulu, Hawaii, PO Box 30048, 4443 Malaas St. Zip 96818—Argo, Ill., 6850 S. Harlem Ave. Zip 60501. Tel (312) 496-6500—Needham Heights, Mass., 155 Fourth Ave. Zip: 02194 Tel: (617) 449 0300—Farmington, Mich., 23923 Research Dr. Zip 48024 Tel (313) 477-5000—Eagan, Minn., PO Box 33211, St. Paul 55133, 3130 Lexington Ave. S. Zip 55121. Tel (612) 733 3300—St. Louis, Mo., PO Box 510, 10725 Bar Blvd. Zip 63166 Tel (314) 997 8500—West Caldwell, N.J., PO Box 76, 15 Henderson Dr. Zip 07006. Tel (201) 227-9100—Cincinnati, Ohio, 4835 Para Dr. Zip 45237 Tel (513) 242 2313—Cleveland, Ohio, 12200 Brookpark Rd. Zip 44130 Tel (216) 267-1800—Philadelphia, Pa., 5698 Rising Sun Ave. Zip 19120 Tel (215) 728-5300—Dallas, Tex., 2121 Santa Anna Ave. Zip 75228 Tel (214) 324-8100—Seattle, Wash., Andover Ind'l Park, 100 Andover Park W. Zip 98188 Tel (206) 244 7200
Audio: 8-tr. (45.90), cassette (45.60.90.120), open reel (1200', 1800', 2400', 3600'), broadcast
Video: 2" quad, 1" helical, 1/2" U-matic cassette (5.10.15.20.30.40.50.60), 1/2" VHS cassette (60 120 & 120 240 min.), 1/2" Beta cassette (30.60 & 60 120 min.)
Brand name: Scotch
Trackmaster Inc., 1310 S Dixie Hwy W. Pompano Beach Fla 33060 Tel (305) 943 2334. Pres: Roy Parsons. Sec'y Treas.: Lupe Parsons
Audio: 8-tr., cassette
Tracs, see Audio Magnetics
Tnad Prods Inc., 1910 Ingersoll, Des Moines, Iowa 50309 Tel: (515) 243 2125. Pres: Richard Trump, Sales Eng.: William Synhorst
Audio: Cassette (5.94), open reel
U T C, see Universal Tape
Ultrascope, see RKO
Ultrasound, see Ultra Specialty
Ultrasound, see Ultra Specialty
Ultra Specialty Inc., 20700 S Belshaw Ave., Carson, Calif 90746 Tel (213) 537 8850. Cable: ULTRASPEC. Telex: 194566. Pres: Don Wong. Pres. Ultraspec Int'l: Gary Lytle.
Audio: Cassette
Video: 1/2" U-matic cassette, 1/2" Beta & VHS cassette
Brand names: Audio—Studio Quality, Ultrasound, Video—Ultrasound
ics
U-matic, see Sony
Universal Tape Corp. Inc., 821 E Artesia Blvd., Carson, Calif 90746 Tel (213) 327 3203. Pres: Edward O. Praeger
Audio: 8-tr. cassette & open reel (custom lengths)
Video: 1" open reel, 1/2" U-matic cassette, 1/2" EIAJ open reel, 1/4" EIAJ cartridge (custom lengths), 1/2" cassette
Brand name: A/V Paragon, UTC, Universal
Utopia Ultra Sound, 38 40 S First St., Newark, Ohio 43055 Tel (614) 345 9426. Pres: Robert H. Kirk Jr. VP: Don Shannon. Gen Mgr: Robert H. Kirk Sr. Sales Mgr: Rose Shannon
Audio: 8-tr., cassette
Brand name: The Pro
V T C, see Phylco
Videopost, see International Audio
Videotime, see Tapemaker
Warjo Promos, 145 W 55 St., Suite 2E New York, N.Y. 10019 Tel (212) 245 7179.
Audio: Cassette (30.60.90), open reel
X. L., see Swire Intermagnetics
Zenith Radio Corp., 1900 N Austin Ave., Chicago, Ill 60639 Tel (312) 745 2000
Audio: 8-tr. (45.90) cassette (30.45.60.90.120)

A/V Paragon, see Universal Tape
Agra-Gevaert Inc., 275 North St., Teterboro, N.J. 07008. Tel (201) 288-4100.
Sales offices: Burlington, Calif., 1633 Old Bayshore Hwy. Zip: 94010. Tel: (415) 692-2432—Los Angeles, Calif., 1801 Century Park E. Zip: 90067. Tel: (213) 552-9622—Atlanta, Ga., 380 Interstate N., Suite 200, Zip 30339. Tel: (404) 955-4326—Oak Brook, Ill., 2803 Butterfield Rd., Suite 200. Zip: 60521. Tel: (312) 242-1915—Lexington, Mass., Lexington Office Center, Hayden Ave. Zip: 02173. Tel: (617) 890-5430—Secaucus, N.J., 24 Meadowlands Pkwy., Suite 300. Zip: 07094. Tel: (201) 330-1800—New York, N.Y., 1 Penn Plaza, Rm 3527. Zip: 10001. Tel: (212) 279-2560—Dallas, Tex., 3003 LBJ Fwy., Suite 100. Zip: 75234. Tel: (214) 243 7315
Audio: Cassette, broadcast.
American Tape Corp., (div. of VideoVision Inc.), 1116 Edgewater Ave., Ridgefield, N.J. 07675. Tel (201) 943-7860. VP Sales: Gerry Gottlieb. VP Adm.: Kathryn Marani-Mendenhall; Plant Mgr.: F.A. Oermony.
Audio: 8-tr. cassette
Brand name: Remington
Amplex Corp., 401 Broadway, Redwood City, Calif. 94063. Tel: (415) 367-2011. Telex: 348464. TWX: (910) 378-5920.
Sales Offices: Birmingham, Ala., PO Box 845. Zip 35205. Tel: (205) 823-6132—Glendale, Calif., 500 Roder Dr. Zip: 91201. Tel: (213) 240-5000—San Diego, Calif., PO Box 99847. Zip 92109. Tel: (714) 272-8337—Denver, Colo., 2124 S. Birch. Zip 80222. Tel: (303) 757-1829/6491—Orlando, Fla., PO Box 15008-B. Zip: 32808. Tel: (305) 423-2962—Atlanta, Ga., 3135 Chestnut Or. Suite 101. Zip 30340. Tel: (404) 451 7112—Honolulu, Hawaii, PO Box 25367. Zip 96825. Tel: (808) 395-7144—Eli Grove Village, Ill., 2201 Lunt Ave. Zip 60007. Tel: (312) 593-6000—Overland Park, Kan., PO Box 7282. Zip 66207. Tel: (913) 383-1951—Florence, Ky., Esden Bldg. Zip: 41042. Tel: (606) 371-1476—Baton Rouge, La., PO Box 14238. Zip 70808. Tel: (504) 766-6270—Bethesda, Md., 10215 Fernwood Rd. Zip: 20034. Tel: (301) 530-8800—Framingham, Mass., PO Box 1020. Zip: 01701. Tel: (617) 877-8060—Minneapolis, Minn., 5200 W. 73 St. Zip: 55435. Tel: (612) 835-5560—Elkhorn, Neb., PO Box 553. Zip: 68022. Tel: (402) 556-3400—Hachensack, N.J., 65 Commerce Way. Zip: 07601. Tel: (201) 489 7400—Williamstown, N.J., PO Box 513. Zip: 08094. Phila. Tel: (215) 887-7650—Buffalo, N.Y., PO Box 4. Zip 14221. Tel: (716) 586-2580—Cleveland, Ohio, PO Box 134. Zip 44212. Tel: (216) 225-1262—Nashville, Tenn., PO Box 120532. Zip 37212. Tel: (615) 256-4836—Houston, Tex., 1615 Prudential Or. Zip 75235. Tel: (214) 637 5100—Dallas, Tex., 5300 Telephone Rd. Zip 77087. Tel: (713) 928-3741—Salt Lake City, Utah, 2880 S. Main. Suite 111. Zip 84115. Tel: (801) 487-8181—Seattle, Wash., 628 Industry Or. Bldg. 8. Zip 98188. Tel: (206) 575-0156
Audio: 8-tr., cassette, open reel.
Video: 2" quad, 1" open reel, 1/2" EIAJ open reel, 1/4" U-matic cassette, 1/4" cassette
Andol Audio Prods. Inc., 4212 14 Ave., Brooklyn, N.Y. 11219 Tel (212) 435-7322. Pres: Anthony A. Maniere; Sales Mgr: Rocco Salvatore; Adv. Mgr: Domenico Salvatore.
Audio: 8-tr., cassette
Audio Inds Inc., Broad & Linden Aves., Ridgely, N.J. 07657 Tel (201) 945-4545
Audio: 8-tr., cassette.
Audiotape, see Capitol
B A S F Systems Corp., Crosby Dr., Bedford, Mass 01730. Tel (617) 271 4000. Professional Prods. Mgr: Robert L. Piselli
Branches: Santa Monica, Calif., 1307 Colorado Ave. Zip 90404 Tel (213) 451-8781—Atlanta, Ga., 3300 Buckley Rd. Suite 403. Zip 30341. Tel: (404) 455-4145—Palatine, Ill., 800 E. Northwest Hwy., Suite 220. Zip 60067. Tel: (312) 934-4990—Ridgewood, N.J., 579 Franklin Tpk. Zip 07450 Tel (201) 447-6904
Audio: Cassette
Burlington Audio Tapes Inc., 10 Commercial St., Hicksville, N.Y. 11801 Tel (516) 433-4466. Pres: Ruth Schwartz. VP: Rudy Schwartz
Audio: 8-tr. cassette, open reel, broadcast.
Video: 1" open reel, 1" cartridge, 1/2" cassette, 1/2" EIAJ open reel, 1/4" EIAJ cartridge
Brand name: Olympic
Capitol Magnetic Prods. (div. of Capitol Recs. Inc.), 6902 Sunset Blvd., Hollywood, Calif 90028. Tel (213) 461 2701. Pres: Edward C. Khoury. VP Mktg. Admin.: John Apstis. VP Domestic Sales: Larry Hockemeyer. VP Int'l Sales: Bud Jackson. Mktg. Coord.: Natalie Goss
Sales offices: Atlanta, Ga., 1670 Ne. Freeway Access Rd. Zip 30329. Tel: (404) 321-5441—Niles, Ill., 6401 Gross Point Rd. Zip: 60648 Tel: (312) 775 7101—New York, N.Y., 1370 Ave. of the Americas. Zip 10019 Tel (212) 757-7470
Int'l branch: Singapore
Audio: 8-tr. cassette
Brand name: Audiotape
Cerriton Corp., 1701 S. State College Blvd., Anaheim, Calif 92806 Tel: (714) 634 4280. WATS (800) 854 3943. TWX (910) 593 1611. Pres: Edwin Gamson. VP Mktg: Ray Allen, Adv. Mgr: Hal Wide
Audio: 8-tr., cassette
Columbia Magnetics (div. of CBS Inc.), 15 Great Pasture Rd., Danbury, Conn 06810 Tel (203) 744 3555. NYC (212) 226 2120
Branch: Los Angeles, Calif., 1930 Century Park W. Zip 90067 Tel (213) 556-4836
Audio: 8-tr. cassette, open reel
Cory Sound Co., 310 Townsend, San Francisco, Calif 94107 Tel (415) 543-0440. Contact: Phillip Markinson
Audio: Cassette, open reel
Crolyn, see E.I. du Pont
Custom Dupl'n Inc., 6330 36 Anzonia Circle, Los Angeles, Calif 90045 Tel (213) 670-5575. Pres: Leonard Gross. Sales Mgr: Bob Hively. Prod'n: Jen Gonzalez
Audio: 2" open reel, 1" open reel, 8-tr., cassette, 1/4" open reel
Video: 1/2" Beta & VHS cassette
O A K Inds Inc., 10845 Vanowen St., North Hollywood, Calif 91605 Tel (213) 984-1559. WATS (800) 423 2636. Cable: OAKENT. Telex: 651396. Pres: Drew Alan Kaplan



for Holidays and
everyday for 40 years
1941-1981

Introducing Really Fast Forward.

Cut cassette costs with the new Speed King 790... The Fastest Cassette Loader in the World!

No matter how fast your audio cassette loader is now, the revolutionary, new Speed King 790 will multiply your throughput with amazing cost savings per cassette. Here's how:

The Speed King is at least 2½ times faster than any previous King loader.*

One machine can produce over 2500 C-60 cassettes in one shift, and one attendant can operate three machines. That adds up to more than 7500 C-60's in one shift.



A computerized quality control system stops the 790 when any operator attention is required. And a flashing LED diagnostic readout reminds the operator of the action needed. So in most cases the 790 is back in production in a few seconds, and there's rarely a need to call a technician.

And all operating controls are in a single front panel where they're easy to see and use.

The 790 also has a stacker/stamper that gives you three choices in stacking loaded cassettes. So you select the method most suitable for your labeling/packaging technique. That saves more time and money.

All the incredible features of the new 790 are available at surprisingly low cost. With the 790 you'll be able to meet the most frantic production schedules and control your labor costs at the same time.

**See the full line of
King audio and
video loaders at
AES in Hamburg.**

Tell me about the
Speed King 790. And make it fast.

King Instrument Corporation

80 Turnpike Road
Westboro, Massachusetts 02181
USA

Phone: (617) 366-9141
Cable: KINGINST/Telex 94-8485

Name _____

Company _____

Address _____



KING

World Leader in Tape Tailoring Systems*

*All figures based on factory tests during seven hours of normal operation.

©Copyright 1981
King Instrument Corporation

Audio: Cassette.
Delta Magnetics Corp., 1901 McDonald Ave., Brooklyn, N.Y. 11223. Tel (212) 627-6556. Telex: 642271.
Branch: Edison, N.J., PO Box 494. Zip: 08817. Tel (201) 287-8907.
Audio: 8-tr., cassette, open reel.
Donnak Inds., PO Box 422, Ridgefield, N.J. 07657. Tel (201) 945-6820.
Audio: Cassette.
E. I. du Pont de Nemours & Co. Inc., Magnetic Prods. Div., Photo Prods Dept., du Pont Airport, Bldg. 1, Wilmington, Del. 19898. Tel (302) 774-1000.
Audio: Cassette.
Brand name: Collyn.
Electronic Homes Co., 1225 Broadway, Main Floor, New York, N.Y. 10001. Tel (212) 725-0290. Bd. Chm. George T. Saddler; Sales Mgr.: Elias Smyrnakis; Adv. Mgr.: Joe Gary.
Audio: 8-tr., cassette, open reel.
Brand name: Toyota.
El Mar Plastics Inc., 821 E. Artesia Blvd., Carson, Calif. 90746. Tel (213) 237-3180. Cable: ELMAR. TWX (910) 346-6940. Pres. Allen Schor.
Audio: 8-tr.
Finebilt Mfg. Co. Inc., 931 N. Citrus Ave., Hollywood, Calif. 90038. Tel (213) 466-9511. Pres.: Alwin P. Schmid; VP & Tape Sales Mgr.: Joseph Bouzaglou; Sales Mgr.: Manuel Munoz.
Audio: Cassette, open reel.
Video: 1/2" U-matic cassette, 1/4" EIAJ cartridge.
Gabriel Mfg. Co. Inc., 125 S. Liberty Dr., Stony Point, N.Y. 10980. Tel (914) 942-0100. Pres.: Ed Gabriel; VP: Richard Gabriel, Gen. Mgr.: Vin Tullio.
Adv. Mgr.: Ellen Gabriel.
Audio: Cassette.
H D P, see Magnetic Media.
Hilo, see Magnetic Mktg.
Infonics Inc., PO Box 1111, 238 Hwy 212, Michigan City, Ind. 46360. Tel (219) 879-3381.
Audio: Cassette.
Intermagnetics Corp., 1311 Colorado Ave., Santa Monica, Calif. 90404. Tel (213) 393-9281.
Loranger Mfg. Corp., Entertainment Prods. Div., 10-48 Clark St., Warren, Pa. 16365. Tel (814) 723-8600. VP: Robert Loranger.
Audio: Cassette.
M M C, see Magnetic Mktg.
Magnetic Mktg. Corp., 29 Valley View Terr., Wayne, N.J. 07470. Tel (201) 694-3502. Telex: 138558. Pres.: Thomas J. Hofbauer; Sales Mgr.: Brendan F. Browne; Adv. Mgr.: M. Judge.
Audio: 8-tr., cassette, open reel, broadcast.
Video: 2", 1", 1/2", 1/4", 1/8" Beta & VHS, 1/4" Technicolor.
Brand names: Hilo, MMC.
Magnetic Media Corp., 500 Eastern Pkwy., Farmingdale, N.Y. 11735. Tel (516) 293-1010. Cable: MAGMEDIA. Telex: 143223. Pres.: Aaron Wasserstrom; Gen. Mgr.: John Cristano; Sales Mgr.: Paul Mastroianni.
Audio: Cassette.
Brand names: TM-100, HDP.
Magnetix Corp., 770 W. Bay St., Winter Garden, Fla. 32787. Tel (305) 656-4494. Pres.: John Lory.
Audio: Cassette.
Media Int'l Inc., 425 N. Michigan, Chicago, Ill. 60611. Tel (312) 467-5430. Pres.: Duane Lundeen; VP: Margaret Lundeen; Gen. Mgr.: Al Masters.
Audio: 8-tr., cassette, open reel.
Miami Tape Inc., 8180 NW 103 St., Hialeah Gardens, Fla. 33015. Tel (305) 558-9211.
Audio: 8-tr., cassette.
Dimpic, see Burlington.
Pacific Int'l Magnetics Inc., 185 Berry St., No. 3865, San Francisco, Calif. 94107. Tel (415) 495-8830.
Home office: Canada.
Audio: Cassette, open reel.
Video: 1/2" Beta & VHS cassette.
R J A, see See Hear Inds.
Recortec Inc., 475 Ellis St., Mountain View, Calif. 94043. Tel (415) 962-0220. TWX (910) 379-5022. Pres.: Dr. Lester H. Lee; Sales Mgr.: Ron R. Troxell.
Audio: Cassette.
Remington, see American Tape.
Respond Int'l, 1190 Miraloma Way, Suite Y, Sunnyvale, Calif. 94086. Tel (408) 245-1351. Cable: RESPOND. TWX (910) 339-9317. Pres. Ronald L. Akim.
Audio: 8-tr., cassette, open reel.
See Hear Inds., 120 W. 55 St., Garden City, Calif. 90248. Tel (213) 516-0315. Pres.: Ray Jacobs; Sales Mgr.: Ray Johnson.
Audio: Cassette, open reel.
Brand name: RJA.
Sentry Inds. Inc., 221 N. MacQuesten Pkwy., Mount Vernon, N.Y. 10550. Tel (914) 664-2909. Cable: SENTIND. Pres.: Harold Rosen; VP: Barry Rosen.
Audio: 8-tr., cassette, open reel.
Video: 1/2" Beta cassette.
Soundmark Corp., 4950 Nome St., Unit C, Denver, Colo. 80239. Tel (303) 371-3076.
Audio: Cassette, open reel.
Studio Quality, see Ultra Specialty.
Super Avilyn, see TDK.
T D K Electronics Corp., 755 Eastgate Blvd., Garden City, N.Y. 11530. Tel (516) 746-0880. Telex: 144535. VP & Gen. Mgr.: Ken Kohda; Sales Mgr. John Schattin; Video Prod. Mgr.: Ed Pessara.
Branches: Irvine, Calif., 2102 E. Alton St. Zip 92714. Tel (714) 979-5811. WATS: (800) 854-0123. Div. Mgr.: Lee Adams-Marietta, Ga., 4062 Kingston Court. Zip 30067. Tel (404) 952-4600. Reg'l Mgr.: George Cas-teel-Des Plaines, Ill., 1011 E. Touhy Ave., Suite 165. Zip 60018. Tel (312) 297-1341. WATS: (800) 323-5956. Reg'l Mgr.: Jack Pender.
Audio: Cassette (pancakes).
Video: 1/2" VHS cassette.
Brand name: Super Avilyn.
T M 100, see Magnetic Media.
Tape-maker Sales Co., 48 Urban Ave., Westbury, N.Y. 11590. Tel (516) 333-2700. Pres.: Arthur Brandwein; Office Mgr.: Karen Sitkoff.
Video: 1/2" U-matic cassette, 1/4" Beta & VHS cassette.
3 M Co., Audio/Video Prods. Div., 3M Center, St. Paul, Minn. 55144. Tel (612) 733-1466. Corp. VP: D.E. Denham, Div. VP: J.E. Povolny, Mktg. Dir.: W.J. Madden; Nat'l Sales Mgr.: J.L. Leon, Mkt. Dpns. Mgr.: J.B. Hanks; Mkt. Communications Mgr.: D.J. Linehan.
Branches: Anchorage, Alaska, 5531 Minnesota Dr. Zip 99502. Tel (907) 276-2363-Burbank, Calif., 126 W. Elm Court. Zip 91502. Tel (213) 848-5534-Los Angeles, Calif., 6023 S. Garfield Ave. Zip 90040. Tel (213) 726-6300-South San Francisco, Calif., 320 Shaw Rd. Zip 94080. Tel (415) 589-2663-Washington, D.C., 1101 15 St. NW. Zip 20005. Tel:

(202) 331-6900-Atlanta, Ga., 2860 Bankers Ind'l Dr. Zip 30360. Tel (404) 447-7000-Honolulu, Hawaii, PO Box 30048, 4443 Malaas St. Zip 96818-Argo, Ill., 6850 S. Harlem Ave. Zip 60501. Tel (312) 496-6500-Needham Heights, Mass., 155 Fourth Ave. Zip 02194. Tel (617) 449-0300-Farmington, Mich., 23923 Research Dr. Zip 48024. Tel (313) 477-5000-Eagan, Minn., PO Box 33211, St. Paul 55133, 3130 Lexington Ave. S. Zip 55121. Tel (612) 733-3300-St. Louis, Mo., PO Box 510, 10725 Baur Blvd. Zip 63166. Tel (314) 997-8500-West Caldwell, N.J., PO Box 76, 15 Henderson Dr. Zip 07006. Tel (201) 227-9100-Cincinnati, Ohio, 4835 Para Dr. Zip 45237. Tel (513) 242-2313-Cleveland, Ohio, 12200 Brookpark Rd. Zip 44130. Tel (216) 267-1800-Philadelphia, Pa., 5698 Rising Sun Ave. Zip 19120. Tel (215) 728-5300-Dallas, Tex., 2121 Santa Anna Ave. Zip 75228. Tel (214) 324-8100-Seattle, Wash., Andover Ind'l Park, 100 Andover Park W. Zip 98188. Tel (206) 244-7200.
Audio: 8-tr., cassette, open reel.
Video: 2" & 1" open reel, 1/2" U-matic cassette, 1/4" EIAJ open reel, 1/4" Beta & VHS cassette.
Brand name: Scotch.
Toyota, see Electronic Homes
U T C, see Universal Tape Corp.
Ultramagnetics, see Ultra Specialty
Ultra Specialty Inc., 20700 S. Belshaw Ave., Carson, Calif. 90746. Tel (213) 537-8850. Cable: ULTRASPEC. Telex: 194566. Pres.: Don Wong. Pres. UI traspec Int'l Gary Lyle.
Audio: 8-tr., cassette.
Video: 1/2" U-matic (10,000'), 1/4" Beta & VHS cassette (5,000').
Brand names: Audio-Studio Quality, Ultrasound, Video-Ultramagnet ics.
Universal Tape Corp. Inc., 281 E. Artesia Blvd., Carson, Calif. 90746. Tel (213) 327-3203. Pres.: Edward D. Praeger.
Audio: 8-tr., cassette, open reel.
Video: 1" open reel, 1/2" U-matic cassette, 1/4" EIAJ open reel, 1/4" EIAJ cartridge, 1/2" cassette.
Brand name: A/V Paragon, UTC, Universal

8 DUPLICATING & PROCESSING EQUIPMENT MANUFACTURERS & IMPORTERS

Accurate Sound Int'l Inc., 114 Fifth Ave., Redwood City, Calif. 94063. Tel (415) 365-2843.
Audio: Tape duplicators.
Brand name: Asco.
Air Bin, see Investment Technology
Alpha, see International Audio
Asco, see Accurate Sound.
Associated Audio Servs. Inc., 181 Westchester Ave., Port Chester, N.Y. 10573. Tel (914) 937-5129. Pres.: D. Richard Kraus, VP: Allan Johnson.
Product: 8-tr. winding machines.
Brand name: Dupliquip Auto 8.
Audio Inc., 219 Crossen Ave., Elk Grove Village, Ill. 60007. Tel (312) 640-1030. Pres.: W.R. Hinkle, VP: Sales. Milt Sherman, VP: Mlg. Norman De letzke.
Audio: Cassette loaders, cassette rewinders & timers, cartridge winders.
Video: Loaders & unloaders (1/2", 1/4"), splicers.
Audiodyne Co., PO Box 825, San Jose, Calif. 95106. Tel (408) 287-3520.
Owner & Pres.: Louis R. Chiaromonte.
Audio: 8-tr., cassette & open reel winders, 8-tr. cartridge splice hnder.
AudioGraphics (div. of Herald Publ'g House), 3225 S. Noland Rd., Independ ence, Mo. 64055. Tel (816) 252-5010.
Product: Cassette duplicators & loaders.
Audiomatic Corp., 1290 Ave. of the Americas, New York, N.Y. 10019. Tel (212) 582-4870. Telex: 126419. Pres.: Milton B. Gelfand, VP: Customer Servs.: Marilyn J. Best, Adv. Mgr.: J.P. Lohman. **Local branch:** Audio Mat rix Inc., 915 Westchester Ave., Bronx 10459. Tel 589-3500.
Audio: Cassette duplicators.
Brand name: Electro Sound (Distributor).
Audio/Tek Inc., 502-D Vandell Way, Campbell, Calif. 95008. Tel (408) 378-5586.
Audio: 8-tr., cassette & open reel duplicators, cassette loaders, duplica tor master recorders.
Auto-Tec, see United Research
Bazzy Electronics Corp., 39 N. Rose, Mount Clemens, Mich. 48043. Tel (313) 463-2592.
Audio: Cassette rewinders, in cartridge duplicators.
Beaucart, see UMC
Casseteload, see Shape.
Cetec Gauss (div. of Cetec Corp.), 9130 Glenoaks Blvd., Sun Valley, Calif. 91352. Tel (213) 875-1900. Pres.: W. Mort Fujii.
Audio: High speed tape duplicating systems & quality control repro ducers.
Brand name: Gauss.
Duplicator II, see Recordex.
Dupliquip Auto 8, see Associated Audio
Electrosound Inc. (sub. of Electrosound Group Inc.), 160 San Gabriel Dr., Sunnyvale, Calif. 94086. Tel (408) 245-6600. Pres.: Raymond J. Schaal.
Branch: Omaha, Neb., Electro Sound Midwest, 3528 Dodge St. Zip 68131. Tel (402) 344-4114. Mktg. Mgr.: Jim Cook (Sales office).
Audio: Duplicators, QC reproducers, automatic 8-tr. & cassette winders, loaders, splicers & recorder/reproducers.
Ferrocube Corp., 5083 Kings Hwy., Saugerties, N.Y. 12477. Tel (914) 246-2811.
Audio: 8-tr. & cassette duplicating head assemblies.
Finebilt Mfg. Co. Inc., 931 N. Citrus Ave., Hollywood, Calif. 90038. Tel (213) 466-9511. Pres.: Alwin P. Schmid; VP: Joseph Bouzaglou; Sales Mgr.: Manuel Munoz.
Audio: Magnetic tape coaters & slitters, test equip

Gauss, see Cetec
Gotham Audio Corp., 741 Washington St., New York, N.Y. 10014. Tel (212) 741-7411. Pres.: Stephen F. Temmer; Sales Mgr.: Russell D. Hamm.
Audio: Duplicators, cassette tape winders.
Brand name: Magnetophon, Telefunken.
I E M, see International Electro-Magnetics
I T I, see Investment Technology
Infonics Inc., PO Box 1111, 238 Hwy 212, Michigan City, Ind. 46360. Tel (219) 879-3381. Telex: 233111.
Audio: Duplicators.
Brand names: Infonics, Phoenix
Intermagnetics Corp., 1311 Colorado Ave., Santa Monica, Calif. 90404. Tel (213) 393-9281.
Audio & video: Coaters, slitters, calendars, assembly & test equip.
International Audio Inc., 2934 Malmo Dr., Arlington Heights, Ill. 60005. Tel (312) 956-6030.
Audio: In cassette duplicators.
Brand name: Alpha.
International Electro-Magnetics Inc., 350 N. Eric Dr., Palatine, Ill. 60067. Tel (312) 358-4622. Bd. Chm. John Pretto, Sales Mgr. Tony Pretto.
Audio: Heads, tape transports.
Brand name: IEM
Investment Technology Inc., 1940 124 Ave. NE, Bellevue, Wash. 98005. Tel (206) 454-7720.
Audio: Air driven loop bin.
Brand names: Air Bin, ITI
King Instrument Corp., 80 Turnpike Rd., Westboro, Mass. 01581. Tel (617) 366-9141. Pres.: William H. Anderson, VP: Sales William E. Cline.
Audio: Automatic & semi-automatic cassette loaders.
Video: 1/2" (Beta & VHS) cassette loaders.
M M C, see Magnetic Mktg.
M Q C, see Magnetic Mktg.
M T D, see Magnetic Mktg.
M T I Corp., 124 Montclair Ave., Montclair, N.J. 07042. Tel (201) 744-2220.
Cable: MTICDRP. Pres.: Timothy A. Cole.
Audio: High speed duplicators & loaders.
Brand names: System III, Tapematic
Magnecord, see Telex.
Magnetic Mktg. Corp., 29 Valley View Terr., Wayne, N.J. 07470. Tel (201) 694-3502. Telex: 138558. Pres.: Thomas J. Hofbauer; Sales Mgr.: Brendan F. Browne; Adv. Mgr.: M. Judge.
Audio: In-cassette duplicators & loaders, pancake duplicator, degaussers.
Brand name: MMC, MQC, MTD
Magnetophon, see Gotham Audio
Mini Max, see Recordex Corp.
Dtari Corp., 2 Davis Dr., Belmont, Calif. 94002. Tel (415) 592-8311. Pres. Jack Soma, Mktg. Mgr.: Steven Krampf, Nat'l Sales Mgr.: Michael Bernard, Field Sales Eng. (Industrial Prods.): Michael Pappas.
Audio: Open reel mastering, in-cassette mastering/production, pancake & loop bin duplicators.
Passavant Corp., PO Box 2503, Birmingham, Ala. 35201. Tel (205) 853-6290. Telex: 782118. TWX (810) 733-5547. Adv. Mgr.: Tom Roberts III.
Audio & Video: Unwinders, conditioning units, coaters, dryers, calendars, rewinders, slitters.
Pentagon Inds. Inc., 4751 N. Dicot Ave., Chicago, Ill. 60656. Tel (312) 867-9200. Pres.: Tom Horton, VP: Mktg. James Dow, Sales Mgr.: Joe Hollen-kamp.
Audio: In-cassette, reel-to-reel & reel to cassette duplicators.
B F Perkins (div. of Roehlen Inds.), GPO Box 366, 939 Chicopee St., Chi-copee, Mass. 01021. Tel (413) 536-1311. Telex: 955342.
Audio & Video: Magnetic tape calendars, filled & nylon shell rolls, cooling rolls, unwinds, rewinds, splice jumping & edge guiding.
Phoenix, see Infonics.
Picking Audio Ionics (formerly Ed-Pic Dupl'rs/Recordex Co.), 535 N. Al exandria, No. 104, Los Angeles, Calif. 90004. Tel (213) 669-8243.
Owner: Edward F. Picking (Exported by Singer Prods Co. Inc.).
Product: Tape duplicating systems & tape winders for all audio formats.
Recordex Corp., 1935 Deck Ind'l Blvd., Marietta, Ga. 30067. Tel (404) 955-7368.
Audio: Cassette & reel to cassette duplicators, in cassette duplicating systems.
Brand names: Duplicator II, Mini Max, Super Pro 30.
Recortec Inc., 475 Ellis St., Mountain View, Calif. 94043. Tel (415) 962-0220. TWX (910) 379-5022. Pres.: Dr. Lester H. Lee; Sales Mgr.: Ron R. Troxell.
Audio: Automated cassette duplicators & loaders.
Video: 1/2" & 1/4" automated videocassette loaders.
Rockford Automation, 3381 Forest View Rd., Rockford, Ill. 61109. Tel (815) 398-7601.
Audio & Video: Cassette automatic assembly systems.
S K K Ent's Inc., 2488 Townsgate Rd., Westlake Village, Calif. 91361. Tel (805) 889-1831.
Audio: Reel to cassette, reel to hub & continuous loop to pancake for 8-tr.
See Hear Inds. (div. of RJA Inc.), 120 W. 155 St., Garden City, 90248. Tel (213) 516-0315. Pres.: Ray Jacobs; Sales Mgr.: Bernadette McNulty.
Audio: High speed tape duplicators.
Brand name: Wollensak
Shape Inc., PD Box 366, Biddford Ind'l Park, Biddford, Me. 04005. Tel (207) 282-6155.
Audio: Automatic & semi-automatic cassette & 8-tr. assembly equip., au-tomatic 8-tr. splicers & winders, cassette winders.
Brand names: Casseteload, Shape.
Singer Prods Co. Inc., 875 Merrick Ave., Westbury, N.Y. 11590. Tel (516) 333-2000. (Export only).
Audio: Tape winders & duplicators.
Brand name: Recordex
Sluder Revox America Inc., 1425 Elm Hill Pike, Nashville, Tenn. 37210. Tel (615) 254-5651. Pres.: Bruno Hochstrasser, Gen. Mgr.: Bill R. Muggler, Nat'l Sales Mgr.: Barry D. Evans, Technical Mgrs. (Sluder) Doug Beard, (Revox) Renaud Delapraz.
Branches: Los Angeles, Calif., 14046 Burbank Blvd. Zip 91401. Tel (213) 780-4234. Contact: Bill Van Doren - New York, N.Y., 155 Ave. of the Americas Zip 10013. Tel (212) 255-4462. Contacts: Fred Layn, Tom Mintner.
Product: Master recorders, quality control recorders/reproducers.
Super Pro 30, see Recordex
System III, see MTI
Tapemaker Sales Co. Inc., 48 Urban Ave., Westbury, N.Y. 11590. Tel (516) 333-2700. Pres.: Arthur Brandwein, Office Mgr.: Karen Sitkoff.
Audio: Programmable cassette testing unit, loop bin.
Video: Videocassette loading equip., staking machines.
Tapematic, see MTI
Telectro Systems Corp., 96 18 43 Ave., Corona, N.Y. 11368. Tel (212) 651-8900. Pres.: Harry Sussman

Electro Sound tape duplicators with automatic quality control System 8000 at 64:1/32:1 System 5000 at 32:1/16:1

Superlative audio

From frequency response of $\pm 2\%$ from 40Hz to 15kHz through every individual performance specification, the new System 8000 and System 5000 are outstanding: signal-to-noise, crosstalk rejection, WOW and flutter, harmonic distortion, tape speed accuracy. You've never heard such high audio capability.

Microprocessor architecture

Electro Sound's trend-setting microprocessor is an integral part of the systems' design. It controls and monitors the key process functions, shuts the system down if key functions vary beyond acceptable limits and locates any problem with a built-in diagnostic program. It also counts and displays the number of completed selections and pancakes.

The amazing Electro Sound 4300 Quality Control & Assurance System

Automatic, high speed quality control is available with all-new optional accessories. Eight performance parameters are measured and shown on a hard-copy printout with pass-fail readout, all within seconds. The system uses a digitally-encoded quality control tone which is automatically recorded at the end of each pancake – with no attention from the operator. The tone is then read back, the signals are decoded and the results printed. Any out-of-tolerance specifications are flagged on the readout.

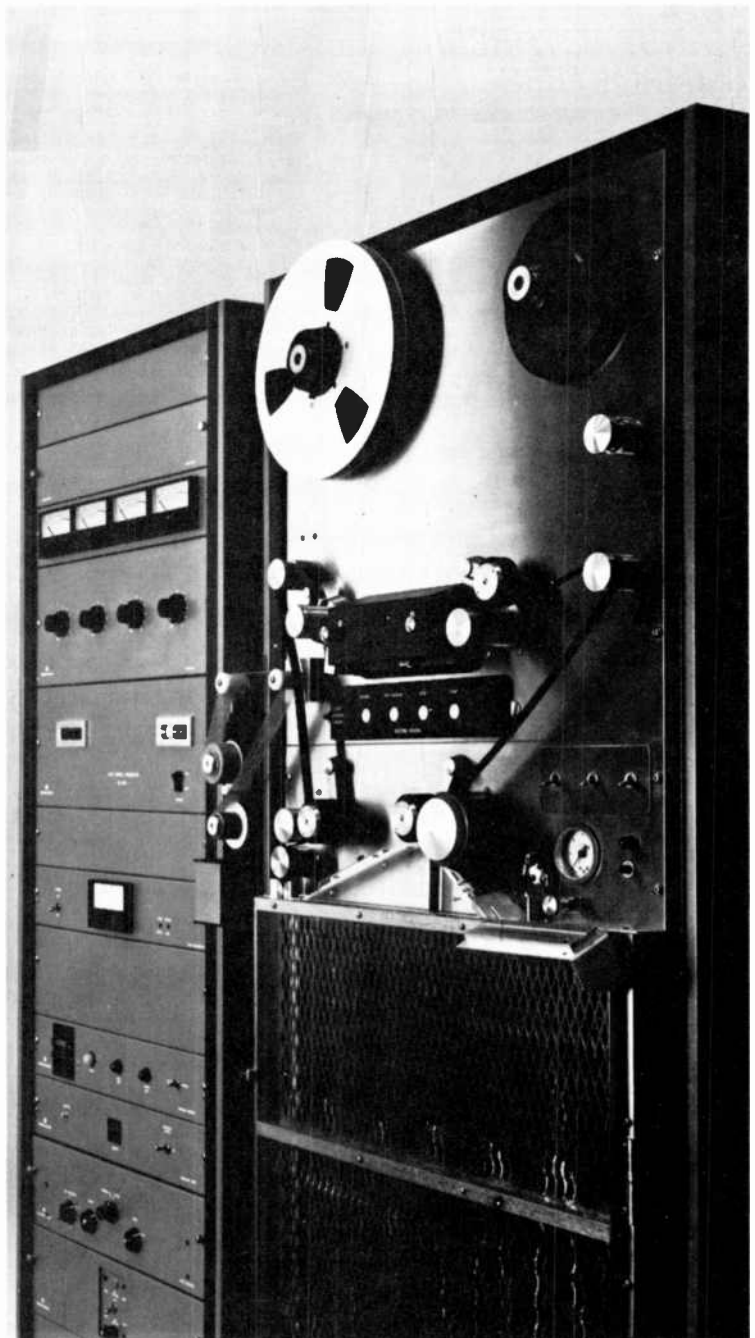
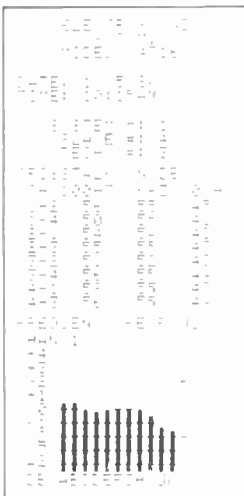

Distributed in the U S
and worldwide by



1290 Avenue of the Americas
New York, NY 10019, USA
Cable: AUDIOMATIC
Telephone: 212-582-4870
Telex: 12-6419

Audio: High speed duplicators
 Telefonken, see Gotham Audio
 Telex Communications Inc., 9600 Aldrich Ave S., Minneapolis, Minn 55420
 Tel. (612) 884 4051 Pres Ansel Kleiman, VP Mktg James S Arrington,
 Adv & Sales Promo Dir Peter Schwarz
Audio: Cassette & open reel modular duplicators/copiers, broadcast reel
 & cartridge recorders/reproducers
Brand name: Magnecord, Telex
 Trackmaster Inc., 1310 S. Dixie Hwy W. Pompano Beach, Fla 33060 Tel
 (305) 943 2334 Pres Roy Parsons, Secy Treas Lupe Parsons
Product: 8 tr & cassette duplicators, verifiers, exercisers
 U M C Electronics Co., 460 Sackett Point Rd., North Haven, Conn 06473
 Tel (203) 288 7731 Telex 963510 Pres James C Leu, Nat'l Sales
 Mgr Bernard H Ribillard
Audio: Broadcast cartridge tape recorders & reproducers
Brand name: Beaucart
 United Research Lab Corp., 681 Fifth Ave., New York, N.Y. 10022 Tel
 (212) 751 4663 TWX (710) 581 3622 Pres George Adams, Sales Mgr
 Lee Rand, Gen Mgr Anita Adams, Chief Eng. Jim Lee
Audio: Exact duplicate replacement parts for professional recorders
Brand name: Auto Tec
 Verbatim Corp., 323 Soquel Way, Sunnyvale, Calif 94086 Tel (408) 245
 4400
Audio: Cassette tension monitors, head & guide gauge, torque tester
 Wollensak, see See Hear

Audico Inc., 219 Crossen Ave., Elk Grove Village, Ill. 60007 Tel (312) 640
 1030 Pres W R Hinkle, VP Sales Milt Sherman, VP Mlg Norman De-
 letzke
Audio: Cassette labels
 Audio Accessories Co., 38 W 515 Deerpath Rd., Batavia, Ill 60510 Tel
 (312) 879 5998 Sales Mgr John S Maloney
Audio: Boxes, labels & printed materials in styro block (book) formats
Brand names: Audiopak, Infopak
 Audio Inds Inc., Broad & Linden Aves., Ridgefield, N.J. 07657 Tel (201)
 945-4545
Audio: Norelco style cassette boxes
 Audiolab Electronics, 3725 Esperanza Dr., Sacramento, Calif 95825 Tel
 (916) 485-0500
Audio: Degaussers
 Audiomatic Corp., 1290 Ave of the Americas, New York, N.Y. 10019 Tel
 (212) 582-4870 Telex 126419 Pres Milton B Gelland, VP Custom
 Servs Marilyn J Best, Adv Mgr J P Lohman Local branch: Audio Ma-
 tria Inc. 915 Westchester Ave., Bronx 10459 Tel 589 3500
Audio: Splicing & leader tapes
 Audiopak, see Audio Accessories
 AudioVisual Communications Inc., 435 Crooked Ln., King of Prussia, Pa
 19406 Tel (215) 272 8500 Pres John Ballantyne, VP Sales John But-
 terworth
Audio: Cassette labels
 Kenneth A Bacon Assocs 216 Montego Key Novato Calif 94947 Tel
 (415) 883-5041 Owner Kenneth A Bacon Prod'n Mgr Rick Bacon
Audio: Cassette labels & box inserts, cartons
 Beau, see UMC
 G Benson & Co Printers Inc., 75 Spring St., New York N.Y. 10012 Tel
 (212) 925 7100 Contact Gerald J Benson
Audio: 8 tr & cassette pressure sensitive labels
 Bogen, see International Rec'g
 W H Brady Co Specialty Tape Prods., PO Box 571, 727 W Glendale Ave.,
 Milwaukee, Wis 53201 Tel (414) 332 8100 Cable BRADYCO Telex
 26677 Gen Mgr John Arnold, Mktg Mgr Ken Vaughn
Audio: 8 tr & cassette leader & splicing tape, 8-tr sensing tape, master
 splicing tape
Video: 1/2" & 3/4" videocassette splicing & sensing tapes, Beta cassette
 leader tape
 Bruce Packaging Co., 8025 N Kenneth Ave., Skokie, Ill 60076 Tel (312)
 583 2818 Pres Joseph Halperin
Audio: Open reel boxes, cassette packaging & boxes, corrugated pack-
 aging
 Burlington Audio Tapes Inc., 10 Commercial St., Hicksville, N.Y. 11801 Tel
 (516) 433-4466 Pres Ruth Schwartz, VP Rudy Schwartz
 Coastal Specialty Tapes Inc., 274 Bangor St., Lindenhurst, N.Y. 11757 Tel
 (516) 226-5900 Dpns Head & Sales Mgr Dan Dobbs
Audio: 8-tr & cassette labels, splicing & sensing tape, splicer, paper
 leader tape
Video: Helical lead in splicing tape
 Columbia Magnetics (div of CBS Inc.), 15 Great Pasture Rd., Danbury,
 Conn 06810 Tel (203) 744 3555 NYC (212) 226 2120
 Branch: Los Angeles, Calif., 1930 Century Park W Zip 90067 Tel (213)
 556-4836
Audio: Splicing & abrasive tape, liquid magnetic pattern detecting kit
 Brand names: Columbia Magnetics, Magna See

Copy-Art Photographers (div. of James J. Kreigsmann), 165 W. 46 St., New
 York, N.Y. 10036 Tel (212) 757-0190
Audio: 8-tr & cassette labels
 Cory Sound Co., 310 Townsend, San Francisco, Calif. 94107. Tel: (415) 543-
 0440. Contact Phillip Markinson
Audio: Cassette labels.
 Custom Rec Mfg. Co., 5810 S Normandie Ave., Los Angeles, Calif 90044.
 Tel (213) 753-5121 Pres Jules Bihari, VP Don Macmillan.
Audio: Cassette labels.
Video: Cassette labels.
 D A K Inds. Inc., 10845 Vanowen St., North Hollywood, Calif 91605 Tel
 (213) 984-1559. WATS (800) 423-2636 Cable DAKENT Telex. 651396.
 Pres Drew Alan Kaplan.
Audio: Cassette labels
 Delta Magnetics Corp., 1901 McDonald Ave., Brooklyn, N.Y. 11223. Tel:
 (212) 627-6556 Telex: 642271
Audio: Norelco style cassette boxes, leader tape (on reels or in web
 form).
 Disc Graphics (div of Pickwick Int'l Inc.), 10 Gilpin Ave., Hauppauge, N.Y.
 11787 Tel (516) 234-1400
Audio: 8-tr & cassette labels
 Dyna/Day Plastics Inc (sub. of American Sound), 6270 Country Club Rd.,
 Tucson, Ariz 85706 Tel (602) 746-1001 Pres Frank S Day, VP & Gen.
 Mgr Larry Rossier, Sales: Leslie Day.
Sales offices: North Hollywood, Calif., 8120 Webb Ave Zip 91605 Tel:
 (213) 768-6100 Sales Dir Bill Dawson-Closter, N.J., 317 Harrington
 Ave Zip 07624. Tel (201) 767-9033 VP Mktg. Paul Adams
Audio: "Norelco style" cassette boxes
 El Mar Plastics Inc., 821 E Artesia Blvd., Carson, Calif 90746 Tel (213)
 327 3180. Cable. ELMAR. TWX (910) 346-6940 Pres: Allen Schor.
Audio: Ampex, Norelco & soft poly style cassette boxes, open reel boxes,
 8 tr & cassette splicing tape
 Fenton Label Co. Coral & Buckius Sts., Philadelphia, Pa 19124. Tel (215)
 288 2910
Audio: 8 tr & cassette labels
 Fidelipac Corp., 109 Gaither Dr., Mount Laurel, N.J. 08057 Tel (609) 235-
 3511 TWX (710) 897 0254 Pres Roger Thanhauser, Sales & Mktg
 Mgr Arthur Constantine
Audio: 8-tr labels.
 Filam Nat'l Plastics Inc., 416 W El Segundo Blvd., Los Angeles, Calif 90061.
 Tel (213) 515-7940
Audio: Norelco & soft-poly style cassette boxes, 3/4" NAB hubs, cassette
 hub locks
 Fuji Photo Film USA Inc., Magnetic Tape Div., 350 Fifth Ave., New
 York, N.Y. 10018. Tel (212) 736-3335 VP & Gen Mgr. John Dale, Nat'l
 Sales Mgr. Ben Birmingham, Adv Mgr. Margaretha Bystrom
Product: Fire retardant plastic shippers for 1" & 2" tape
 G C Electronics, 400 S Wyman St., Rockford, Ill 61101 Tel (815) 968-
 9661 Cable GCELECT VP & Gen Mgr Wayne Timpe, Sales & Special
 Mkts Dir. James E Heighway, Adv. Joyce Donahue.
Audio: Head demagnetizers, bulk erasers, splicing & editing equip., car-
 tridge & cassette head cleaners
Video: head cleaners & demagnetizers, connectors.
 Gabriel Mfg. Co. Inc., 125 S Liberty Tr. Stoney Point, N.Y. 10980 Tel
 (914) 942-0100 Pres Ed Gabriel, VP Richard Gabriel, Gen Mgr Vin
 Tulio, Adv Mgr Ellen Gabriel
Audio: All types of plastic cassette boxes
 Gem Bilt Container Corp., 48-20 50 Ave., Woodside, N.Y. 11377 Tel (212)
 784 8800.
Audio & Video: Corrugated cartons, folders & mailers.
 Georgia Pacific Corp., 290 Ferry St., Newark, N.J. 07105 Tel (201) 344-
 2300
Audio: Cellulose acetate film
Brand name: Xcel
 Golly Co., 2320 E. 26 St., Minneapolis, Minn. 55406. Tel: (612) 721-7466.
 Gen Mgr Les Malmquist, Mktg Scott Birchfield
Audio: Cassette labels
Video: Videocassette labels
 Gotham Audio Corp., 741 Washington St., New York, N.Y. 10014 Tel: (212)
 741 7411 Pres Stephen F Temmer, Sales Mgr Russell O. Hamm.
Audio: Splicing & editing equip (Gotham), precision tape timer (Lyrec).
 H R C Printing, 5252 E Trindle Rd., Mechanicsburg, Pa 17055 Tel (717)
 766 0943 Gen Mgr Donald E Baldwin
Audio: Cassette labels
Video: Videocassette labels
 A C Hampson Printing Co., 168 City Hill St., Naugatuck, Conn. 06770. Tel:
 (203) 729-2294 Pres Augustus D Hampson; Sales Mgr.: John W. Berry.
Audio: Pressure sensitive & heat seal cassette labels, cassette inserts.
Video: Videocassette labels.
 Hi-Flex Corp., 404 Artillery Rd., Taylors, S.C. 29687 Tel (803) 268-2363
Audio: Cassette leader tape
 I C I United States Inc., Plastics Div., New Murphy Rd., Wilmington, Del.
 19897 Tel (302) 575 3000
Audio & video: Polyester film tape base
Brand name: Melinex
 I P S., 107 Bridge Rd., Hauppauge, N.Y. 11787 Tel (516) 234 3322.
Audio: Norelco style cassette boxes
 Image Devices Inc., 1825 NE 149 St., Miami, Fla. 33181. Tel (305) 945-
 1111 Telex 519348 TWX (810) 845-4242 Sales Mgr Bill Reiter
Audio: Pressure sensitive labels
 Infopak, see Audio Accessories.
 Infonics Inc., PO Box 1111, 238 Hwy 212, Michigan City, Ind 46360 Tel.
 (219) 879-3381 Telex 233111
Audio: Alignment tapes, kits, duplicator peripherals.
 International Rec'g Co., 49 Desmond Ave., Bronville, N.Y. 10708 Tel (914)
 337-5726 Pres Claire Rie.
Audio: Recorder & duplicator magnetic heads; replacement parts for Or-
 tofon equipment
Brand names: Heads—Bogen (Germany). Recorder parts—Ortofon (Den-
 mark)
 Joyce Molding Corp., 501 Division St., Boonton, N.J. 07005 Tel (201) 334-
 2020
Audio: Norelco & soft poly style cassette boxes
Brand name: Max Sound
 Ken Del Prod's Inc., 111 Valley Rd., Richardson Park, Del 19804. Tel:
 (302) 655-7488
Audio: Cassette labels
 Keystone Printed Specialties Co. Inc., 321 Pear St., Scranton, Pa. 18505.
 Tel (717) 346 1761 Pres. M C Fischer, Sales & Adv Mgr Martin C.
 Fischer
Audio: 4-tr., 8 tr. & cassette labels
Video: Videocassette labels
 Lafayette Radio Electronics Corp., 111 Jericho Tpk., Syosset, N.Y. 11791.
 Tel. (516) 921 7700.

9 PROFESSIONAL TAPE SUPPLIES MANUFACTURERS & IMPORTERS

Ace Label Systems, 140 Jackson Ave., N Hopkins, Minn 55343 Tel
 (612) 933 3105
Audio: Cassette labels
 Amaray Int'l Corp., 2251 Grant Rd., Suite H, Los Altos, Calif. 94022 Tel
 (415) 968 2840 VP Sales & Mktg Ron Garrett
Audio: Cassette boxes
 J C Anglum Co Inc / Tapeponents Inc., Box 236, 36 Midvale Rd., Mountain
 Lakes, N.J. 07046 Tel (201) 263 1442 Pres J Clifford Anglum
Audio: Cassette boxes
 Athena Inds Inc., 2200 Industrial Way S., Toms River, N.J. 08753 Tel
 (201) 244 8500 Pres Louis Ligator, Sales Mgr Mark Chayot
Audio: Norelco style cassette boxes

WE MAKE GOOD FIRST IMPRESSIONS... again, and again, and again.

Don't waste your time waiting for your cassette labels. We stock a large assortment of blank labels for immediate shipment. Turn-around time on custom orders is equally impressive.

GIVE US A CALL AND IMPRESS YOURSELF

SHEETS • ROLLS • COMPUTER • CUSTOM LABELS
 DISPENSERS • APPLICATORS



Ace Label Systems, Inc.

140 Jackson Avenue North
 Hopkins, Minnesota 55343

612/933-3105

The best in duplicating tapes made one better.

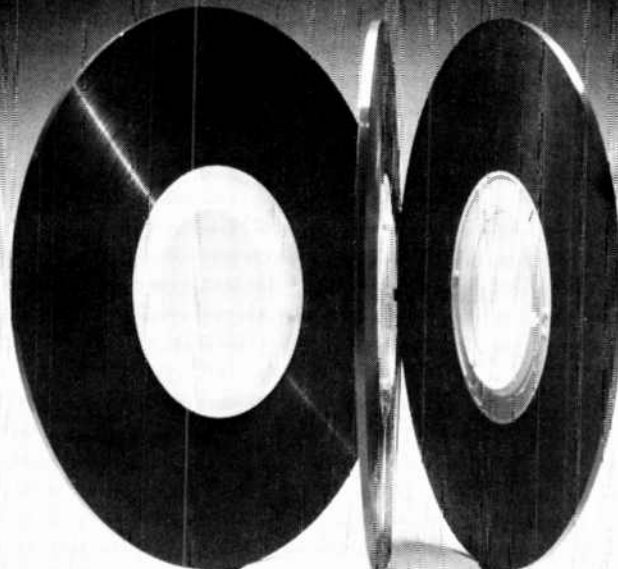

CrO₂

DPS

LHB

BASF, whose calibration tapes have long been the internationally recognized standard in the world, now offers the world's most complete line of high performance duplicating tapes. With the addition of our new CrO₂ chromium dioxide tape to our DPS and LHB oxide tapes, there is now a BASF duplicating tape for every recording need.

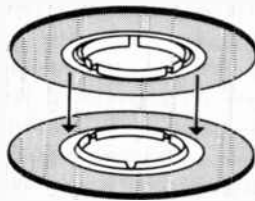

E-Z stack hubs save storage and provide easy handling.

Capable of duplicating at speeds up to 120 IPS, these three tapes offer superior consistency, reliability and exceptional winding characteristics. They're available in 60-minute sizes with lengths of 7,200 and 8,200 feet or 90-minute sizes with lengths of 9,600 or 12,000 feet. And their color-coded, easy-stack hub and package design saves storage and provides easy handling, yet still allows for 40 hubs per master carton. But best of all, these three duplicating tapes all cost less than the competition.

CrO₂ delivers studio master performance.

Our new CrO₂ provides audio performance that is virtually undistinguishable from a studio master recorded at 15 IPS. Its extended high frequency Maximum Output Level (MOL), combined with the world's lowest background noise, makes our CrO₂ the perfect duplicating tape for true audiophile quality recordings. And its true chromium dioxide formulation is extremely clean and stable even at high duplicating speeds.

DPS offers exceptional high frequency output and more.

The BASF DPS is an advanced ferric oxide formula duplicating tape designed for the most demanding recordings. It offers superior high frequency sensitivity, and is bias compatible with LHB formulation so you can easily interchange without rebiasing.

LHB combines consistency, reliability and economy.

While our LHB tape costs less than our DPS, it still offers outstanding performance. Its superior uniformity and controlled slit-edge quality ensures a consistently clean running tape even at the highest speeds.

BASF Calibration Tapes — the World Standard.

Calibration tapes from BASF have long been the world standard. Today, they're available in open reel as well as cassette. BASF not only makes a DIN-Calibration Tape 475 (Cr), they also make a DIN-Calibration Tape 475 (Fe). Both come with flux deviations controlled to within ± 0.5 dB.

To find out how you can get the best duplicating tapes—for less—call us collect at (617) 271-6642 or 271-4000 or at one of our regional sales offices listed below.



East: 579 Franklin Turnpike, Ridgewood, NJ 07450 (201) 447-6904
Central: 800 E. Northwest Highway, Suite 220, Palatine, IL 60067 (312) 934-4990
West: 1307 Colorado Avenue, Santa Monica, CA 90404 (213) 451-8781
South: 3300 Buckeye Road, Suite 403, Atlanta, GA 30341 (404) 455-4145



For the best recordings you'll ever make.

- Audio:** Tape splicers.
- Le Bo Prods Co Inc (div of Peerless VidTronics Corp.), 58 60 Grand Ave., Maspeth, N.Y. 11378 Tel (212) 894 5155 Cable: LEBOPRODUX. Telex 424790 Pres. Peter Dayton
- Audio:** Cassette mailers, cassette labels
- Lee Myles Assocs., 160 E 56 St., New York, N.Y. 10022 Tel (212) 758-3232 Cable: LEE MYLES Pres. Robert M. Miller, VP. Howard Roseff
- Audio:** Cassette labels.
- Video:** Videocassette labels
- Lenco Co., PO Box 160, 10240 Oerperk Rd., Waverly, Neb. 68462 Tel (402) 786 7488 Pres. Don Leonhardt, Mktg. Dir. Brad Harse, Sales Mgr. Oaryl Chappelle
- Audio:** Ampex, Norelco & soft poly style cassette boxes, display boxes, cassette leader tape
- Lion Rec'g Servs. Inc., 1905 Fairview Ave., NE, Washington, D.C. 20002 Tel (202) 832-7883 Pres. Harold H. Lion, Sales & Adv. Mgr. Jim Fox
- Audio:** Cassette labels.
- Lipps Inc., 1630 Euclid St., Santa Monica, Calif. 90404 Tel (213) 450 1324
- Audio:** Magnetic heads.
- Loranger Mfg. Corp., Entertainment Prods. Div., 10 48 Clark St., Warren, Pa. 16365 Tel (814) 723-8600 VP. Robert Loranger
- Audio:** Norelco style cassette boxes
- Lyrec, see Gotham
- M R L, see Magnetic Reference Lab
- Mac Murray Press Inc., 230 W. 17 St., New York, N.Y. 10011 Tel (212) 924-1530 Pres. Bernard Lerman, Sales Mgr. Arnold Kohn
- Audio:** Cassette labels
- Video:** Videocassette labels.
- Magna See, see Columbia Magnetics
- Magnetic Reference Lab Inc., 229 Polaris Ave., Suite 4, Mountain View, Calif. 94043 Tel (415) 965-8187 Pres. John G. McKnight.
- Audio:** Test tapes
- Brand name:** MRL
- Magstro Inds. Inc., 3040 Webster Ave., Bronx, N.Y. 10467 Tel (212) 547-5600 Pres. Mario Maccareri
- Audio:** Ampex & Norelco style cassette boxes, reels for bulk cassette tape
- Melmax, see ICI
- Max Sound, see Joyce Molding
- Media Int'l Inc., 425 N. Michigan, Chicago, Ill. 60611 Tel (312) 467 5430 Pres. Ouane Lunden, VP. Margaret Lunden, Gen. Mgr. Al Masters
- Audio:** Cassette labels
- Mike's Print Shop, 2507 Grim, Waco, Tex. 76707. Tel (817) 752 2321
- Owner: Mike Stanley
- Audio:** Pressure sensitive cassette labels
- Misson Plastics South Inc., 341 Hill Ave., Nashville Tenn. 37210 Tel (615) 244 5668
- Factory: Jackson, Tenn., 74 Mission Dr. Zip 38301 Tel (901) 423 0810
- Audio:** Norelco style cassette boxes
- Modern Album & Finishing Co. Inc., Cardinal Ind'l Park, Gilpin Ave., Hauppauge, N.Y. 11787 Tel (516) 234-1100 NYC (212) 291 7600 Pres. G.O. Thomas, Sales Mgr. R.A. Froehing
- Branches: Burbank, Calif., Modern Album of California Inc., 3116 Vanowen St. Zip 91505 Tel (213) 845 7655 Pres. William S. Pine, Sales Mgr. Raymond Gardocki—Terre Haute, Ind., Modern Album of Indiana, 1299 Voorhees St. Zip 47808 Tel (812) 235 6001—Nashville, Tenn., Modern Album of Tennessee Inc., 457 Chestnut Zip 37203 Tel (615) 255 7461
- Product:** Audiocassette & videocassette labels, "set up" boxes, cartridge & cassette boxes, slip cases
- Molded Ind'l Plastics, 151 Wakelee Ave., Ansonia, Conn. 06401 Tel (203) 735 2331
- Audio:** 5", 7" & 10 1/2" hinged paper reel boxes, hubs for raw or blank tape
- Musicassette Dupl'rs of Hawaii, PO Box 22190, Honolulu, Hawaii 96822 Tel (808) 533 4165
- Audio:** Cassette labels
- N A C, see National Audio
- National Audio Co. Inc., Box 3657 GS, Springfield, Mo. 65804 Tel (417) 883 5377
- Audio:** Cassette boxes, 8-tr & cassette library labels
- Brand name:** NAC
- North American Tape Dupl'g Co., 15414 Cabrito Rd., Van Nuys, Calif. 91406 Tel (213) 781-7650, VP & Gen. Mgr., Norm Teter, Mktg. Dir. Larry Stagano
- Audio:** Cassette labels
- Nortronics Co. Inc., 8101 10 Ave. N., Minneapolis, Minn. 55427 Tel (612) 545-0401 Nat'l Sales Mgr. Ken Lubitz
- Audio:** Magnetic replacement heads, professional recorder maintenance prods. including head cleaners, demagnetizers, bulk erasers, splicing blocks & tabs, alignment tapes & head lapping kits
- Video:** Videotape recorder maintenance supplies
- Brand names:** Audio—Nortronics, Performance Series, Video—Recorder Care
- Olympic, see Burlington Audio
- Orticon, see International Rec'g.
- P S C Prods., 985 Waimanu St., Honolulu, Hawaii 96814 Tel (808) 537 3695, Pres. Michael Tanaka
- Audio:** Cassette labels
- Pacific Int'l Magnetics Inc., 185 Berry St., No. 3865, San Francisco, Calif. 94107 Tel (415) 495 8830
- Home office:** Canada
- Audio:** Cassette labels
- Video:** Videocassette labels
- Pak Wk Corp., 128 Twoli St., Albany, N.Y. 12207. Tel: (518) 465 4556 Pres. Samuel A. Strasser, Sales Mgr. Myron S. Strasser Jr.
- Audio:** Folding cartons for 8 tr. & cassette, 45 RPM record backers
- Video:** Folding cartons for videocassette (Beta & VHS)
- Pauli Prods., PO Box 29, Collingswood, N.J. 08108 Tel (609) 547 8925 Pres. Joseph A. Pauli, VP. Zara May Pauli.
- Audio:** Cassette labels & insert cards
- Pedersen Label Printing Co., 11152 Fleetwood St., Sun Valley, Calif. 91352 Tel (213) 768 3122 Pres. Herman A. Fredriks, Prod. Mgr. S. Kado naga
- Audio:** 8 tr., cassette & box labels, cassette inserts
- Peerless Vid-Tronics Corp., 60 West St., Bloomfield, N.J. 07003 Tel (201) 429 8600 Pres. Herb Ravis, Sales Mgr. Andy Danzico
- Video:** Videocassette packaging
- Permatab Prods. Co. Inc., 105 Quail Valley Rd., Social Circle, Ga. 30279 Tel (404) 787 1910 Pres. W.B. Thompson
- Audio:** Splicing tape & pre-cut tabs.
- Phylco Audio, 4709 Brooks St., Montclair, Calif. 91763 Tel (714) 621 9561
- Owner: Robert Deates, Gen. Mgr. Rick Deates
- Audio:** Cassette labels
- Polyline Corp., 1233 Rand Rd., Oes Plaines, Ill. 60016 Tel (312) 298 5300 Pres. John Kasser
- Audio:** Soft hinged cassette boxes
- Poly Matrix Inc., 40 Downing Ind'l Park, Pittsfield, Mass. 01201 Tel (413) 499-3550 Pres.: William A. Rulo, Mktg. & Sales Dir. Timothy P. Wiley, Molding Mgr. Michael Throver.
- Audio:** Norelco type cassette boxes
- Poly Plastic Packaging Co. Inc., 44-80 11 St., Long Island City, N.Y. 11101. Tel (212) 392-8670
- Audio & Video:** Polypropylene & polyethylene packaging
- Pressure Sensitive Tape & Label Corp., 135 Schmitt Blvd., Farmingdale, N.Y. 11735 Tel (516) 293 7300
- Video:** Labels
- Prestige Label Corp., 255 Oser Ave., Hauppauge, N.Y. 11787 Tel (516) 273-0020
- Audio:** 8 tr. & cassette pressure-sensitive labels & stickers
- Performance, see Nortronics
- Progressive Label & Litho Co., 286 Stanhope St., Brooklyn, N.Y. 11237 Tel (212) 497-2320, Pres. Jerome J. Rood, Gen. Mgr. Bernie Stein
- Audio:** 8 tr. & cassette labels
- Promedeus Arts Inc., 1776 Broadway, New York, N.Y. 10019 Tel (212) 586 3770, Pres. Lew Morris, Sales Mgr. Jerry Present, Adv. Mgr. Ron Parisi
- Audio & Video:** Promotional tape & labels
- Pro 1 Audio Visual Inc., PO Box 33, Highland Park, Ill. 60035 Tel (312) 433 4575 Pres. R.L. Pink, VP J. Pink, Sales Mgr. M.M. Pink Adv. Mgr. D.D. Pink.
- Audio:** Cassette labels
- Q/Splice, see Webtek
- Q A I Inc., 640 Dell Rd., Carlstadt, N.J. 07072 Tel (201) 460 0060, NYC (212) 964 1714 Pres. Steve Dauman, Sales Mgr. George Rafowsky
- Audio:** 8 tr. & cassette labels, cueing & splicing tapes, end tabs
- Video:** Videocassette labels
- Queens Lithographing Corp., 52 35 Barnett Ave., Long Island City, N.Y. 11104 Tel (212) 457 7700 Chief Exec. Officer Eric Kaitman, Pres. Leonard Verebay, Sr. VP Sales Richard Roth
- Branch: Hollywood, Calif., 6290 Sunset Blvd., Suite 304 Zip 90028 Tel (213) 464 7700
- Plant: Indianapolis, Inc., Rutgers Packaging Corp., 620 S. Belmont Ave. Zip 46221 Tel 635 7777 VP & Gen. Mgr. Manny Ungar
- Audio:** 8 tr. & cassette labels, boxes, inserts, slipcases & collars.
- R H M Inds. Ltd., 180 Orville Dr., Bohemia, N.Y. 11716 Tel (516) 567-7222, NYC (212) 895-9344.
- Audio:** 8 tr. labels, cassette labels & inserts
- Video:** Videocassette labels.
- Recorder Care, see Nortronics
- Reliance Plastics & Packaging Div., Reliance Folding Carton Corp., 225 Bellville Ave., Bloomfield, N.J. 07003 Tel (201) 748 2222 Pres. Marshall Weingarden, Sales Mgr. Maron Burleigh
- Audio:** Corrugated mailers for cassette.
- Video:** Corrugated mailers for videocassettes
- Robins Inds. Corp., 75 Austin Blvd., Commack, N.Y. 11725 Tel (516) 543 5200 Pres. Herman Post, VP Sales Stu Carne
- Audio:** Cassette mailers & boxes, open reel boxes
- Rutgers Packaging Corp. (div of Queens Lithographing Corp.), 620 S. Belmont Ave., Indianapolis, Ind. 46221 Tel (317) 635 7777 TWX (810) 341 3457, 341 3400 Pres. Abe Garde, Sales & Adv. Mgr. Morton Shecter
- Audio:** Cassette labels
- Video:** Cassette labels
- S T L, see Standard Tape Lab & Taber Mfg
- Saki Magnetics Inc., 5770 Uplander Way, Culver City, Calif. 90230 Tel (213) 649 5983
- Audio:** Ferrite magnetic recording heads
- Shape Inc., PO Box 366, Biddeford Ind'l Park, Biddeford, Me. 04005 Tel (207) 282 6155
- Audio:** Norelco style cassette boxes
- Shorewood Packaging Corp., 10 E 53 St., New York, N.Y. 10022 Tel (212) 371 1500 Pres. Paul Shore, Exec. VP Floyd S. Ciment, VP Special Proj. Exec. Marc Shore, VP Nat'l Sales Ken Rosenblum
- Branch: Los Angeles, Calif., 1830 Glendale Blvd. Zip 90026 Tel (213) 660 3043 VP West Coast Sales Jim Palmer—La Grange, Ga., SPC Co., 1707 Shorewood Dr. Zip 30240 WATS Tel (800) 241 0186 Plant Mgr. Ken McCabe—Farmingdale, N.Y., 55 Engineers Ln Zip 11735 Tel (516) 694 8230
- Audio:** 6" x 6" 8 tr. & cassette packaging, cassette labels
- Video:** Beta & VHS videocassette packaging
- Sonar Radio Corp., 3000 Stirling Rd., Hollywood, Fla. 33021 Tel (305) 981 8800 Chm. Bernard E. Klein
- Product:** Videocassette bulk eraser
- Brand name:** Videoraser
- Soundmark Corp., 4950 Nome St., Unit C, Denver, Colo. 80239 Tel (303) 371 3076
- Audio:** Cassette labels & custom packaging
- Splicette, see Webtek
- Standard Tape Lab Inc., 26120 Eden Landing Rd. No. 5, Hayward, Calif. 94545 Tel (415) 786 3546 Pres. Frank G. Lenner
- Audio:** Test tapes
- Brand name:** STL
- Stanford Int'l, PO Box 609, 569 Laurel St., San Carlos, Calif. 94070 Tel (415) 592 5958 Pres. Fred Oobbs, Opns. Mgr. Jan Dillard
- Audio:** Cassette labels
- Stephens Electronics Inc., 3513 Pacific Ave., Burbank, Calif. 91505 Tel (213) 842 5116 Pres. John F. Stephens, Sales Mgr. Bobbi Murphy, Adv. Mgr. Gina O'Espoo
- Audio:** Professional 2" editing blocks
- Studio Magnetics Co. Inc., 12 Long Island Ave., Holtsville, N.Y. 11742, Tel (516) 289-3400 Pres. George Clahane, VP. Craig M. Balaban
- Audio:** cassette editing kit, splicing, sensing & leader tape, "soft-plas tic," Ampex & Norelco style cassette boxes, pressure sensitive labels & mailing envelopes
- Super Prods., PO Box 1569, 31 Industrial Park, Hendersonville, Tenn. 37075 Tel (615) 822 5080 Pres. Gordon Cash
- Audio:** Cassette labels
- Video:** Videocassette labels
- Switchcraft Inc., 5555 N. Elston Ave., Chicago, Ill. 60630 Tel (312) 792 2700
- Audio:** Connectors, cable assemblies, adapters, patch cord systems, jacks & plugs
- T O K Electronics Corp., 755 Eastgate Blvd., Garden City, N.Y. 11530 Tel (516) 746-0880 Telex 144535 VP & Gen. Mgr. Ken Kohda, Sales Mgr. John Schattin, Video Prod. Mgr. Ed Pessara
- Branches: Irvine, Calif., 2102 E. Alton St. Zip 92714 Tel (714) 979-5811, WATS (800) 854-0123 Div. Mgr. Lee Adams—Marietta, Ga., 4062 Kingston Court Zip 30067 Tel (404) 952 4600 Reg'l Mgr. George Cas-teel—Des Plaines, Ill., 1011 E. Touhy Ave., Suite 165 Zip 60018. Tel (312) 297 1341 WATS (800) 323-5956 Reg'l Mgr. Jack Pender.
- Audio:** Test tapes, head demagnetizers, labels & index cards
- Taberasers, see Taber Mfg
- Taber Mfg. & Eng'g Co., 2081 Edison Ave., San Leandro, Calif. 94577 Tel (415) 635 3831
- Audio:** Heads, bulk erasers, test tapes
- Brand names:** Taber, Taberaser, STL
- Tapemaker Sales Co. Inc., 48 Urban Ave., Westbury, N.Y. 11590, Tel (516) 333 2700 Pres. Arthur Brandwein, Office Mgr. Karen Sitkoff
- Audio:** Splicing & sensing tape, pre-cut Q tabs, cassette labels.
- Video:** Splicing tabs, leader tape & head cleaning tape for Beta & VHS cassette.
- Thalco Audio Inc., 2 Dickens Ave., Dix Hills, N.Y. 11746 Tel (516) 667-1616 Chief Exec. Michael Thaler
- Audio:** Norelco & soft poly style cassette boxes
- Trackmaster Inc., 1310 S. Dixie Hwy W., Pompano Beach, Fla. 33060 Tel (305) 943 2334, Pres. Roy Parsons, Sec'y Treas. Lupe Parsons.
- Audio:** Cassette labels
- Tri Lon Color Lithographers Ltd., 54 W. 21 St., New York, N.Y. 10010, Tel (212) 255 6140, Pres. Morris Strackler, VP. David Strickler
- Audio:** 8 tr. & cassette inserts & labels
- Tropical Paper Box Co., 7000 NW 25 St., Miami, Fla. 33122 Tel (305) 592 5520
- Audio:** 8 tr. & cassette boxes.
- U M C Electronics Co., 460 Sackett Point Rd., North Haven, Conn. 06473, Tel (203) 288 7731 Telex 963510 Pres. James C. Leu, Nat'l Sales Mgr. Bernard H. Ribillard
- Audio:** Heads, motors
- Brand name:** Beau
- Universal Marking Systems Inc., 2320 E. 26 St., Minneapolis, Minn. 55406 Tel (612) 721 7466
- Audio:** Cassette labels, case liners
- Video:** Cassette labels
- Vaughn Assocs., PO Box 5808, Sarasota, Fla. 33579 Tel (813) 924 3734
- Audio:** Cassette labels
- Veritas Electronics Corp., 22 Grand Ave., Farmingdale, N.Y. 11735, Tel (516) 541 5373
- Audio:** Head demagnetizers, bulk erasers, cassette & open reel splicers
- Videoraser, see Sonar Radio
- W R E, see Wide Range Electronics
- Edward R. White Inc., 18 E. 41 St., New York, N.Y. 10017 Tel (212) 687 2167 Pres. & Sales Mgr. Lawrence Goldstein
- Audio:** Tape envelopes & mailers
- Wide Range Electronics Corp., 2119 Schuertz Rd., St. Louis, Mo. 63141 Tel (314) 567 5366
- Audio:** Bulk erasers, degaussers, magnetic erasing pencil
- Brand name:** V'RE
- Wills Printing Co., PO Box 211, Arlington, Tex. 76010 Tel (817) 572 1414 Pres. Calvin Willis
- Audio:** Cassette labels
- Xcel, see Georgia-Pacific

10 PACKAGING & LABELING EQUIPMENT & SUPPLIES MANUFACTURERS

- A P S, see Autovend
- Audio Accessories Co., 38 W. 515 Deerpark Rd., Batavia, Ill. 60510 Tel (312) 879 5998 Sales Mgr. John S. Maloney
- Product:** Label application machine
- Brand name:** Tuck
- Audiomatic Corp., 1290 Ave. of the Americas, New York, N.Y. 10019 Tel (212) 582-4870 Telex 126419 Pres. Milton B. Gelfand, VP. Customer Servs. Marilyn J. Best, Adv. Mgr. J.P. Lohman Local Branch: Audio Ma-trix, Inc., 915 Westchester Ave., Bronx 10459, Tel. 589 3500
- Product:** "On cassette" printers
- Brand name:** Apex (Orsributor)
- Audiopack, see A.C. Hampson
- Autovend Packaging Systems (APS), PO Box 712, 1275 Bloomfield Ave., Fairfield, N.J. 07006, Tel (201) 575-1040.
- Product:** Solid state shrink film packaging systems
- Kenneth A. Bacon Assocs., 216 Montego Key, Novato, Calif. 94947 Tel (415) 883-5041, Owner: Kenneth A. Bacon, Prod'n Mgr. Rick Bacon
- Product:** Label printing machine
- Bazzy Electronics Corp., 39 N. Rose, Mount Clemens, Mich. 48043 Tel (313) 463-2592
- Product:** Shrink wrap sealer
- Cheshire (a Xerox Co.), 408 Washington Blvd., Mundelein, Ill. 60060 Tel (312) 949-2000.
- Product:** Labeling machines
- Cinema Sound Corp., see Investment Technology
- Coastal Specialty Tapes Inc., 274 Bangor St., Lindenhurst, N.Y. 11757 Tel (516) 226-5900, Opns. Head & Sales Mgr. Dan Dobbs
- Product:** Labeling machines.
- Chet Dunn Assocs. Mfg. Rep., 20 Locke Rd., Billerica, Mass. 01821 Tel (617) 663-2000 Telex. 947429, Pres.: Chet Dunn.
- Product:** Cassette assembly machinery
- E System, see Econocorp.
- Econocorp Inc., 71 Fourth Ave., Needham Heights, Mass. 02194 Tel (617) 444 8070
- Product:** Horizontal loading packaging equip
- Brand name:** E-System, Econoseal

(Continued on page 85)

MAY 23, 1981 BILLBOARD

FIFTEEN
YEARS OF

tape packaging

WITH SCANDIA MACHINERY
AND AUTOMATED SYSTEMS

1960's



Scandia introduced the first fully automatic high-speed *8-track* labeling, cartoning, and wrapping system.

1970's



Scandia introduced the first fully integrated high-speed packaging system for labeling, inserting, and wrapping *audio cassettes*.

1980's



Scandia now introduces the all-new economical, automated cartoning, and wrapping system for *video cassettes*, again leading the way.



SCANDIA

THE TAPE PACKAGING LEADER

Scandia Packaging Machinery Company
P.O. Box 575 Allwood Station
180 Brighton Rd., Clifton, New Jersey 07012
(201) 473-6100 • Telex No. 133513

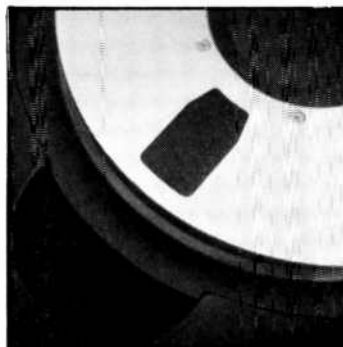

INTERNATIONAL AUDIO VIDEO TAPE DIRECTORY

INTERNATIONAL

Australia

• services

DESIGN & ARTWORK

A T A Sound, 96 Glebe Point Rd., Glebe, NSW 1037 Tel (02) 660 3466
Cable SHDWBIZ. Telex 22429 (wrec only)
concert Rec'g, PD Box 108, 10 Caloola Rd., Wentworthville, NSW 2145 Tel
631 6189

Home office: USA, Los Angeles, Calif.

Copperfield Sound Prod'ns, 127 Carrington Rd., Waverley, NSW 2024 Tel
(02) 389 3043 Mng Dir & Gen Mgr. David Gibson

E M I (Australia) Ltd., 301 Castlereagh St., Sydney, NSW 2000 Tel (02)
20912 Cable EMIRECDRD Telex 24182 Music Opns Mng Dir Peter
Jameson; Mktg Mgr Brian Harris; Nat'l Sales Mgr Alex Coroneos;
Nat'l Promo & A&R Mgr David Gilchrist; Adv Mgr Les Smith
Hadley Recs., Egret Pl., Calala, Tamworth, NSW 2340 Tel (067) 65 7813
Mng Dir Eric W Scott, Gen Mgr. Hilary Scott
Kettle Art. 3 Systum St., Ultimo, NSW 2007 Tel (02) 211 0835 Contact
Rick Godfrey

Klarion Ents Pty Ltd., PD Box 379, 63 Kingsway, South Melbourne, Vic
3205 Tel (03) 61-3801 Telex 34732 Mng Dir B K Horman, Sales
Mgr R Welch (Tape only)

Branches: Artarmon, NSW 2064, 3 Lancelly Pl. Unit 3 Tel (02) 438
1388—Brisbane, Qld. 4000, 199 Elizabeth St. Tel (07) 229 2077—Ade-
laide, SA 5000, 35-37 Halifax St. Tel (08) 212-2217

Muve Recs., PD Box 266, Carlton South 3053 Tel (03) 497-3105 Partners
Nicholas Alexander, Martin Wright

Musicroom Art., 9 Dundas Ln., Albert Park, Vic. 3206 Tel (03) 690 3399
Cable MUSHREC Telex 31738 Mng Dir Michael Gudinski, Gen Mgr
Alan Scholz

Gary Pearson, 42 NW Arm Rd., Gympie, NSW Tel (02) 29 2824, 521 5485

Recording Industry Mktg Servs Pty. Ltd. PD Box 70, 122 Chapel St., St
Kilda, Vic 3182 Tel 531-1588 Mng Dir: Marius Herman Chief Con-
sultant Don Fraser

White & Gillespie (Melbourne) Ltd., 17 Radford Rd. Reservoir, Melbourne,
Vic. 3073 Tel (03) 460 4522 Cable DUALSCALE Dir. R.J. Gillespie,
Gen Mgr A.E. White

PRINTERS & LITHOGRAPHERS

C B S Recs Australia Ltd., 15 Blue St., North Sydney, NSW 2060 Tel (02)
11 0255 Cable CDLRECDRD Telex 21246 Chm. William Smith; Mktg
Mgr William Hagan

E M I (Australia) Ltd., 301 Castlereagh St., Sydney, NSW 2000 Tel (02)
20912 Cable EMIRECDRD Telex 24182 Music Opns Mng Dir Peter
Jameson; Mktg Mgr Brian Harris; Nat'l Sales Mgr Alex Coroneos;
Nat'l Promo & A&R Mgr. David Gilchrist; Adv Mgr Les Smith

Klarion Ents Pty Ltd., PD Box 379, 63 Kingsway, South Melbourne, Vic
3205, Tel (03) 61 3801 Telex 34732 Mng Dir: B K Horman; Sales
Mgr R Welch (Tape only)

Branches: Artarmon, NSW 2064, 3 Lancelly Pl. Unit 3 Tel (02) 438
1388—Brisbane, Qld. 4000, 199 Elizabeth St. Tel (07) 229 2077—Ade-
laide, SA 5000, 35-37 Halifax St. Tel (08) 212 2217
R C A Ltd., 11 Khartoum Rd., North Ryde, Sydney, NSW 2113 Tel (02) 888
5444 Cable RCAAUST Telex 21654 Mng Dir Brian Smith

TAPE CUSTOM DUPLICATORS TAPE PACKAGING & LABELING

The Audio and Video lines indicate the configurations which the firms dupli-
cate. Companies which offer packaging and labeling of tape product are
indicated by: "(PKG)" which appears after the main body of their respec-
tive listings.

Ampex Australia Pty Ltd., 65 Waterloo Rd., North Ryde, NSW 2113 Tel
(02) 887 3333 Cable VIDEOTAPE Telex. 20608 Mgr/Dir Greg Nixon,
Magnetic Tape Div Mktg Mgr Richard Blackett (PKG only—audio &
video)

Branch: Blackburn, Vic. 3030, 21 Terra Cotta Dr. Tel (03) 877-6222

C B S Recs Australia Ltd., 15 Blue St., North Sydney, NSW 2060 Tel (02)
31 0255 Cable CDLRECDRD Telex 21246 Chm. William Smith, Mktg
Mgr William Hagan

Audio: Cassette
Caras Emporium Pty Ltd., 215 Lonsdale St., Melbourne, Vic 3000 Tel (03)
663 3605 Telex 31501. (Manufacturers' rep)

Audio: 8 tr., 8 tr. quadraphonic, cassette, open reel
Brand name: Trackmaster

Copperfield Sound Prod'ns, 127 Carrington Rd., Waverley, NSW 2024 Tel
(02) 389-3043 Mng Dir & Gen Mgr David Gibson

Audio: 8 tr., cassette, open reel, open reel quadraphonic
Video: 4" cassette

E M I (Australia) Ltd., 301 Castlereagh St., Sydney, NSW 2000 Tel (02)
20912 Cable EMIRECDRD Telex 24182, Music Opns Mng Dir. Peter
Jameson; Mktg Mgr Brian Harris; Nat'l Sales Mgr Alex Coroneos;
Nat'l Promo & A&R Mgr David Gilchrist; Adv Mgr Les Smith. (PKG)
Audio: Cassette

Festival Recs Pty Ltd., Festival House, 63-79 Miller St., Pyrmont, Sydney,
NSW 2009 Tel (02) 660 4022 Telex 25686 Mng Dir. Allan Hely, Gen
Mgr Jim White, Sales Mgr Noel Brown

K G C Magnetic Tape Pty Ltd., PD Box 118, 40 Applebee St., St. Peters,
Sydney, NSW 2044 Tel (02) 519-2677 Cable MAGTAP Telex 71659
Gen. Mgr: W F Gordon, Sales Mgr E Black; Audio Sales Mgr Carlo
Ferrante

Audio: Cassette
Video: 4" cassette, 1/2" Beta, VHS & Philips (V 2000) cassette.

Klarion Ents Pty Ltd., PD Box 379, 63 Kingsway, South Melbourne, Vic
3205 Tel (03) 61-3801, Mng Dir: B K Horman; Sales Mgr: R Welch
Branches: Artarmon, NSW 2064, 3 Lancelly Pl. Unit 3 Tel (02) 438
1388—Brisbane, Qld. 4000, 199 Elizabeth St. Tel (07) 229-2077—Ade-
laide, SA 5000, 35-37 Halifax St. Tel (08) 212-2217

Audio: 8 tr., 8 tr. quadraphonic, cassette, open reel
Video: 4" cassette.

R C A Ltd., 11 Khartoum Rd., North Ryde, Sydney NSW 2113 Tel (02) 888
5444 Cable RCAAUST Telex 21654 Mng Dir Brian Smith
Audio: Cassette

Tape Duplicators Pty Ltd., 3 Chard Rd., Brookvale, NSW 2100 Tel (02)
938-1539 Dirs. B M T & L A Frost
Audio: Cassette.

• supplies

CARTRIDGE & CASSETTE PARTS

Greencorp Magnetics Pty Ltd., 80 Perry St., Matraville, NSW 2036 Tel (02)
661 6511 Telex 24761 Mng Dir Jack N Green, Gen Mgr Warren A
Green, Sales Mgr. Stephen L Green, Technical Mgr W Dale Humphriss
Int'l branches: France, Hong Kong, Israel, USA

EMPTY CARTRIDGES, CASSETTES & REELS

Ampex Australia Pty Ltd., 65 Waterloo Rd., North Ryde, NSW 2113 Tel
(02) 887-3333 Cable VIDEOTAPE Telex. 20608 Mgr/Dir Greg Nixon;
Magnetic Tape Div Mktg Mgr Richard Blackett

Branch: Blackburn, Vic. 3030, 21 Terra Cotta Dr. Tel (03) 877-6222
Audio: Cassettes, reels

Greencorp Magnetics Pty Ltd., 80 Perry St., Matraville NSW 2036 Tel (02)
661 6511 Telex 24761 Mng Dir Jack N Green, Gen Mgr Warren A
Green, Sales Mgr. Stephen L Green, Technical Mgr W Dale Humphriss
Int'l branches: France, Hong Kong, Israel, USA

Audio: 8 tr., cassettes, reels
K G C Magnetic Tape Pty Ltd., PD Box 118, 40 Applebee St., St. Peters,
Sydney, NSW 2044 Tel (02) 519 2677 Cable MAGTAP Telex 71659
Gen Mgr W Gordon, Sales Mgr. E Black, Audio Sales Mgr Carlo Fer-
rante

Audio: Cassettes, 5" & 7" reels
Klarion Ents Pty Ltd., PD Box 379, 63 Kingsway, South Melbourne, Vic
3205 Tel (03) 61-3801 Telex. 34732 Mng. Dir B K Horman, Sales
Mgr R Welch

Branches: Artarmon, NSW 2064, 3 Lancelly Pl. Unit 3 Tel (02) 438
1388—Brisbane, Qld. 4000, 199 Elizabeth St. Tel (07) 229 2077—Ade-
laide, SA 5000, 35-37 Halifax St. Tel (08) 212-2217

Audio: Reels

PROFESSIONAL TAPE SUPPLIES

E M I (Australia) Ltd., 301 Castlereagh St., Sydney, NSW 2000 Tel (02)
20912 Cable EMIRECDRD Telex 24182 Music Opns Mng Dir Peter
Jameson, Mktg Mgr Brian Harris, Nat'l Sales Mgr Alex Coroneos,
Nat'l Promo & A&R Mgr David Gilchrist; Adv Mgr Les Smith

Audio: Cassette labels

TAPE, RAW & BLANK LOADED

Agfa-Gevaert Ltd., PO Box 48, Whitehorse Rd. 372-380, Nunawading, Vic
3131 Tel 878-8000 Cable: AGFAGEVAERT Telex 30702 Melbourne
Audio: Blank—compact, cassette, open reel, raw—cassette, broadcast
studio

Video: Cassette, open reel
Ampex Australia Pty Ltd., 65 Waterloo Rd., North Ryde, NSW 2113 Tel
(02) 887 3333 Cable VIDEOTAPE Telex 20608 Mgr/Dir Greg Nixon

Magnetic Tape Div. Mktg Mgr Richard Blackett
Branch: Blackburn, Vic. 3030, 21 Terra Cotta Dr. Tel (03) 877 6222
Audio: Cassette, open reel

Video: 2" & 1" open reel, 1/2" & 1/4" cassette
Audiotape, see Klarion



INTERNATIONAL NEWS BUREAUS

London—Peter Jones, European News Edit-on, 7 Carnaby St, W1V 1PG, 01 439 9411. Ja-
pan—Shig Fujita, Editorial Representative, Utsunomiya Bldg., 19 16 Jingu-mae 6
Chome, Shibuya-ku, Tokyo 150, 03 498-4641.

INTERNATIONAL CORRESPONDENTS

Australia—Glenn Baker, P.O. Box 261, Baulkham Hills, 2153 New South Wales; Bel-
gium—Juul Anthonissen, 27A Oude Goudstraat, 3100 Heist op den Berg, 015 241953.
Canada—David Farrell, Box 201, Station W, Toronto M6S 4T3, 519 925 2982 France—
Michael Way, Chief Correspondent, 12 Rue du Faubourg Poissonniere, 75010 Paris 01
246 8749

Henry Kahn (special assignments), 16 Rue Clauzel, 75009 Paris, 878-4290; Italy—Dan-
iele Caroli, Viale Marche 21, 20125 Milano, 6083412; Mexico—Mary Fisher, Apartado
Postal 11 766, Mexico 11, D.F. 905 531 3907. Netherlands—Willem Hoos, Bilderdijk
aar 28, Hilversum, 035 43137; Switzerland—Pierre Maester, Hasenweld 8 CH 4600 Ol-
ten, 062 215909, West Germany—Wolfgang Spahr, Chief Correspondent, 236 Bad Sege-
berg, An der Trave 67b, Postfach 1153, 04551 81428. Jim Sampson, News Editor,
Lietbersstr. 19, 8000 Munchen 22 089 727746

SALES & PUBLISHING

U.S. Sales Staff: Los Angeles—John Halloran, Sales Administrator; Joe Fleischman,
Ron Wald; Nashville—John McCartney; New York—Mickey Addy, Jim Bender, Norm
Berkowitz, Ron Carpenter.

A/V/T-60

Intl Sales: Australia—Geoff Waller & Associates, 64 Victoria St., North Sydney 2060, S-1
ney 4362033. Canada—Jim Bender, New York Office; Austria, Germany, Netherlan-
s, Switzerland—contact U.K. office; France—Pierre de Choqueuse, 13 Rue De La Com-
e Paris 75007 555 6024; Great Britain—Peter Morkler, Philip Graham, 7 Carnaby 1,
London W1V 1PG, 439 9411. Italy—Germano Ruscitto, Piazzale Loreto 9, Milan, 28 *9
158; Japan—Hugh Nishikawa, Utsunomiya Bldg., 19 16 Jingu-mae 6 Chome, Shibuya-ku,
Tokyo 150 03 498 4641; Mexico—Mary Fisher, Apartado Postal 11 766, Mexico 11, 1)
905 531-3907.

Director of Charts & Research: Bill Wardlow (L.A.); Controller: Don O'Dell (Cincinnati);
Business Affairs Director: Gary J. Rosenberg (L.A.); Circulation Director: Carole Ire and
(N.Y.); Production Manager: John Wallace (N.Y.); License & Permissions Manager: Geor-
gina Ellen Challis (N.Y.); Production Coordinators: Ron Frank, Tom Quilligan (Cincin-
nati).

BILLBOARD PUBLICATIONS, INC.

Chairman And President: W. D. Littleford. Executive Vice President: Jules Perel. Senior
Vice Presidents: Gerald S. Hobbs, Billboard & Amusement Business Groups, Patrick
Keleher, Art & Design Group. Vice Presidents: William H. Evans Jr., Treasurer; Lee Zhto,
Billboard Operations; John B. Babcock, Product Development; Mary C. McGoldrick, Per-
sonnel. Secretary: Ernest Lorch. Corporate Managers: Charles Rueger, General Manager
of Publishers Graphics; Ann Haire, Director of Planning & Market Development

MAY 23, 1981 BILLBOARD

Belgium

• services

DESIGN & ARTWORK

Bizet (Music Group) Prodn's & Publ'n's Ltd. SprL, 13 Rue de la Madeleine, B 1000 Brussels Tel: (02) 511-5120 Pres F R Faecq, Gen Mgr Lu cienne Bizet, Sales Mgrs Jean Pierre & Veronica Bizet
Octus Screenprint, Rymenamseweg 115, B 2840 Haacht
Oruco Printing Office, 273 Beertstraat, B 1500 Halle Tel: (02) 356-3835
Telex 25832 Sales Mgr Jan Neef

Orukkerij Elga, Nieuwstr 14, B 3370 Boutersem
Monopole Recs, Barlow Printing, 7 Kwadenplasstraat, B 3100 Heist o/d Berg Tel: (015) 24-16 25

Music Radio Promos Benelux, Postbus 31 Luchtbal B 2030 Antwerp 3 Tel (031) 64 73-08 Or Louisa Eyckmans, Gen & Sales Mgr, Jozef Segers

PRINTERS & LITHOGRAPHERS

Bizet (Music Group) Prodn's & Publ'n's Ltd. SprL, 13 Rue de la Madeleine, B 1000 Brussels Tel: (02) 511-5120 Pres Felix R Faecq, Gen Mgr Lu cienne Bizet, Sales Mgrs Jean Pierre & Veronica Bizet

C B A Music (Connection Business Artists Inc.), 14 Rue de Turin, B-4020 Lege Tel: (041) 36-85-24 Mng Dir Tomis Chlaren, Sales Mgr Alan Desulter, Promo Dominique Elans

Clown Music NV, PO Box 24, B-3680 Maaseik Tel: (11) 56 59 13 Dir Djamschidi Scharyar

Dictus Screenprint, Rymenamseweg 115 B 2840 Haacht
Druco Printing Office, 273 Beertstraat, B-1500 Halle Tel: (02) 356-3835
Telex 25832 Sales Mgr Jan Neef

Orukkerij Elga, Nieuwstr 14, B 3370 Boutersem
Fabeldis Elpeco SA, (div of Sobelpress), 30 Gossetlaan, B-1720 Groot Bij gaarden Tel: (02) 466 0666 Pres & Gen Mgr E W Pelgrims de Bigard, Sales Mgr Georges Martens

Monopole Recs Barlow Printing 7 Kwadenplasstraat, B-3100 Heist o/d Berg Tel: (015) 24 16 25

TAPE CUSTOM DUPLICATORS

Clown Music NV, PO Box 24, B 3680 Maaseik Tel: (11) 56 59-13 Or Djamschidi Scharyar
Audio: 8-tr., cassette

Elpeco Ltd (div of Oruco Printing Office), 273 Beertstraat, B 1500 Halle Tel: (02) 356 3835 Telex 25832 Sales Mgr Jan Neef

Fabeldis SA (div. of Sobelpress), 30 Gossetlaan, B 1720 Groot Biigaarden Tel: (02) 466 0666 Pres & Gen Mgr E W Pelgrims de Bigard, Sales Mgr Georges Martens

Audio: Cassette

• supplies

PROFESSIONAL TAPE SUPPLIES

Monopole Recs Barlow Printing, 7 Kwadenplasstraat, B-3100 Heist o d Berg, Tel: (015) 24 16 25
Product: Cassette labels

TAPE, RAW & BLANK LOADED

Advent, see BEAM.

Agfa Gevaert NV, Verkooporganisatie Benelux, Septestr 27, B 2510 Mortsel, Tel: (031) 40 59 00 Telex 31223 Magneetband Oept Mng Dir: D van den Broek

Audio: Raw-Cassette, blank-2" 1", cassette, open reel

Video: Blank-2" 1", 1/2", 1/4" Beta & VHS

Amplex SA, 8 Rue de l'Industrie, B-1400 Nivelles, Tel: (067) 22 49 21 Telex 57432

Audio: 2", 1", cassette, open reel

Video: 2", 1", 1/2" cassette, 1/2" Beta & VHS cassette.

B A S F, Audio Video Dept., 14 Av. Hamor, B 1180 Brussels Tel: (02) 375 2400 Cable BASBRU Telex 22016 Sales Mgr Jacky Swaelens. (Blank only)

Audio: 2", 1", cassette, open reel

Video: 1", 1/2", 1/4" Beta & VHS, 1/2" VCC

B E A M Int'l, Leopoldstr 6, B-2000 Antwerp Tel: (031) 33 45 37 Cable BEAMAUDIO Telex 33941 Mng Dir Edward S Savori, Sales Mgr Jimmy Guze, PR Mgr Charles Lipschutz (Importer-blank only)

Audio: Cassette

Brand name: Advent

Blomhof SA (Ets.), 172a Rue Brogniez, B 1070 Brussels Tel: (02) 522 1813 Dir C. Janssen; Hi-Fi Team Sales Mgr W Menge, Maxell Team Mgr C van Canneyl

Audio: 8 tr., cassette, open reel

Brand name: Maxell

De Greef SprL, 367 Chaussee D'Aisemberg, B 1180 Brussels Tel: (02) 345-3918 Cable MATRADIO Telex 24616 Mng Dir F Morris, Gen Mgr P Moutaert. (Blank only)

Audio: Cassette, open reel

Brand name: Pyral

Discosoul Int'l, 31 Nationalstraat, B 2000 Antwerp Tel: (031) 31 11 47 Telex 31635 Dirs H Lelieu, Jeffrey Maes (Importer-blank only)

Audio: Cassette

I C M, see Trialco

Magnex, see Troubadour

Maxell, see Blomhof

Pyral, see De Greef.

Trialco, 25 Rue des Alcyons, B 1080 Brussels (Raw only)

Audio: 8 tr., cassette open reel

Brand name: ICM

Troubadour SprL, 141 Grande Rue au Bois, B 1030 Brussels Tel: (02) 736-7831 Telex 25987 Mng Dir Rene Balanger

Audio: Cassette

Brand name: Magnex

• accessories

Amplex SA, 8 Rue de l'Industrie, B 1400 Nivelles Tel: (067) 22 49 21 Telex 57432

Product: Tape-carrying & storage cases, head cleaners, bulk erasers, demagnetizers, leader tape, splicing tape & equip. (all audio & video)

Avners Radio SA, 10 Pl de l'Yser, B 1000 Brussels Tel: (02) 218 7400 Cable ANRAD Telex 62526 Admin Dir Y Jordans, PR Vidal Miquel (Importer)

B A S F Australia Ltd., 55 Flemington Rd., North Melbourne, Vic. 3051 Tel: 329-9555. Telex: 30448 Sales Mgr. N. Price. (Raw only)

Audio: Cassette, open reel

Caras Emporium Pty. Ltd., 215 Lonsdale St., Melbourne, Vic. 3000 Tel: (03) 663 3605. Telex: 31501 (Manufacturers' rep.)

Audio: 8-tr., cassette

Brand name: Trackmaster

G-tape, see Greencorp.

Greencorp Magnetics Pty. Ltd., 80 Perry St., Matraville, NSW 2036 Tel: (02) 661 6511. Telex: 24761 Mng. Dir Jack N Green, Gen Mgr Warren A Green; Sales Mgr.: Stephen L. Green, Technical Mgr. W Dale Humphriss

Int'l branches: France, Hong Kong, Israel, USA.

Audio: 8-tr., cassette, open reel

Video: 1/2" EIAJ open reel, 1/4" cassette.

Brand names: G-tape, Greencorp, Opus.

Klaron Ents. Pty. Ltd., PO Box 379, 63 Kingsway, South Melbourne, Vic. 3205, Tel: (03) 61-3801. Telex: 34732. Mng. Dir: B.K. Horman; Sales Mgr: R. Welch

Branches: Artarmon, NSW 2064, 3 Lancelly Pl., Unit 3 Tel: (02) 438-1388—Brisbane, Qld. 4000, 199 Elizabeth St. Tel: (07) 229 2077—Adelaide, SA 5000, 35-37 Halifax St. Tel: (08) 212 2217

Audio: Blank—cassette, open reel, raw—8-tr., cassette, open reel

Brand names: Audiotope, Klaron.

Opus, see Greencorp.

Trackmaster, see Caras

TAPE DUPLICATING & PROCESSING EQUIPMENT

B A S F Australia Ltd., 55 Flemington Rd., North Melbourne, Vic. 3051 Tel: 329-9555. Telex: 30448. Sales Mgr.: N. Price

Audio: Pancakes

Caras Emporium Pty. Ltd., 215 Lonsdale St., Melbourne, Vic. 3000 (Manufacturers' rep.)

Audio: Winders, exercisers, 8-tr duplicators, verifiers, 8-tr & cassette loaders

Brand name: Trackmaster.

Klaron Ents Pty Ltd PO Box 379, 63 Kingsway South Melbourne, Vic. 3205 Tel: (03) 61-3801 Telex 34732 Mng Dir B.K. Horman, Sales Mgr R. Welch

Branches: Artarmon, NSW 2064, 3 Lancelly Pl., Unit 3 Tel: (02) 438-1388—Brisbane, Qld. 4000, 199 Elizabeth St. Tel: (07) 229-2077—Adelaide, SA 5000, 35-37 Halifax St. Tel: (08) 212-2217.

Audio: Checkers, duplicators, loaders.

Brand name: Otari

Otari, see Klaron.

Trackmaster, see Caras.

• accessories

Amplex Australia Pty. Ltd., 65 Waterloo Rd., North Ryde, NSW 2113. Tel: (02) 887-3333 Cable VIDEOTAPE Telex: 20608 Mgr /Dir Greg Nixon; Magnetic Tape Div. Mktg. Mgr: Richard Blackett

Branch: Blackburn, Vic. 3030, 21 Terra Cotta Dr. Tel: (03) 877-6222
Product: Tape—head cleaners & demagnetizers, leader & splicing tape & equip

B A S F Australia Ltd., 55 Flemington Rd., North Melbourne, Vic. 3051. Tel: 329-9555. Telex: 30448 Sales Mgr N. Price.

Product: Tape—head cleaners, splicing tape & equip

Bib Hi-Fi Accessories Australia Pty. Ltd., PO Box 755, North Sydney, NSW 2060 Tel: (02) 922-3495. Dir R.A. Archer (Distributor/Importer)

Home office: England

Product: Record-carrying & storage cases, record care prods., Tape—head cleaners & demagnetizers, splicing & editing equipment, test tape

Colossal Recs of Australia, 28 Milton St., West Melbourne, Vic. 3003 Tel: (03) 329-0316. Mng. Dir., Mimmo LoPrete. Sales Mgr.: Sam LoPrete

Product: Record & Tape—carrying & storage cases (audio)

Greencorp Magnetics Pty. Ltd., 80 Perry St., Matraville, NSW 2036 Tel: (02) 661-6511. Telex: 24761. Mng. Dir. Jack N Green, Gen Mgr Warren A Green; Sales Mgr.: Stephen L. Green; Technical Mgr. W. Dale Humphriss.

Int'l branches: France, Hong Kong, Israel, USA

Product: Record-carrying & storage cases, record care prods., 45 rpm adaptors; Tape—carrying & storage cases, head cleaners, demagnetizers, leader & splicing tape

K G C Magnetic Tape Pty. Ltd., PO Box 118, 40 Applebee St., St. Peters, Sydney, NSW 2044 Tel: (02) 519-2677 Cable: MAGTAP. Telex: 71659 Gen Mgr: W Gordon; Sales Mgr: E Black, Audio Sales Mgr: Carlo Ferrante.

Product: Tape—head cleaners, demagnetizers, leader & splicing tape & equip

Klaron Ents Pty. Ltd., PO Box 379, 63 Kingsway, South Melbourne, Vic. 3205, Tel: (03) 61-3801. Telex 34732. Mng. Dir: B.K. Horman, Sales Mgr: R. Welch

Branches: Artarmon, NSW 2064, 3 Lancelly Pl., Unit 3 Tel: (02) 438-1388—Brisbane, Qld. 4000, 199 Elizabeth St. Tel: (07) 229 2077—Adelaide, SA 5000, 35-37 Halifax St. Tel: (08) 212 2217

Product: Tape—head cleaners, demagnetizers, leader & splicing tape & equip.

• store fixtures

Amplex Australia Pty. Ltd., 65 Waterloo Rd., North Ryde, NSW 2113. Tel: (02) 887-3333 Cable VIDEOTAPE Telex 20608 Mgr /Dir Greg Nixon

Magnetic Tape Div. Mktg. Mgr: Richard Blackett
Branch: Blackburn, Vic. 3030, 21 Terra Cotta Dr. Tel: (03) 877 6222

Product: Tape display racks

Colossal Recs of Australia, 28 Milton St., West Melbourne, Vic. 3003 Tel: (03) 329-0316. Mng. Dir., Mimmo LoPrete, Sales Mgr. Sam LoPrete

Product: Display racks

Greencorp Magnetics Pty. Ltd., 80 Perry St., Matraville, NSW 2036 Tel: (02) 661-6511. Telex: 24761. Mng. Dir., Jack N Green, Gen Mgr Warren A Green; Sales Mgr.: Stephen L. Green; Technical Mgr. W Dale Humphriss.

Int'l branches: France, Hong Kong, Israel, USA

Product: Divider cards

• playback / recording equipment

Amplex Australia Pty. Ltd., 65 Waterloo Rd., North Ryde, NSW 2113. Tel: 887 3333. Telex 20608.

Product: Record-carrying & storage cases, record care prods., Tape—carrying & storage cases

Aacor SA, 12 Blvd Sylvain Dupuis, B 1070 Brussels Tel: (02) 521-2370 522 9327 Telex 61450 Mng Dir Werner Huys

Product: Record-carrying & storage cases, record care prods., turntable mats, 45 rpm adaptors, replacement styli, Tape—carrying & storage cases, head cleaners, demagnetizers, leader & splicing tape

Blomhof SA (Ets.), 172a Rue Brogniez, B 1070 Brussels Tel: (02) 522 1813 Cable BLOMRAD Dir: C Janssen, Hi-Fi Team Mgr W Menge, Maxell Team Mgr C van Canneyl

Product: Record—record care prods., turntable mats 45 rpm adaptors, replacement styli

De Greef SprL, 367 Chaussee D'Aisemberg, B 1180 Brussels Tel: (02) 345 3918 Cable MATRADIO Telex 24616 Mng Dir F Morris, Gen Mgr P Moutaert

Product: Record—replacement styli

Brand name: Stanton

Discosoul Int'l, 31 Nationalstraat, B 2000 Antwerp Tel: (031) 31.11 47 Telex 31635 Dirs H Lelieu, Jeffrey Maes

Product: Record-carrying & storage cases

Interclub Belgium (International Rec. & Music Business), 34 Kleine Bare elstraat, B-2800 Mechelen Tel: (015) 41 13 31

Product: Record—record care prods

Trialco, 25 Rue des Alcyons, B 1080 Brussels

Product: Tape-carrying & storage cases, head cleaners

Vogue SA, 35 Blvd Barthelemy, B-1000 Brussels Tel: (02) 511-7991 Telex 22560

Product: Record—carrying & storage cases, Tape—carrying & storage cases, head cleaners, demagnetizers

• store fixtures

Blomhof SA (Ets.) 172a Rue Brogniez, B-1070 Brussels Tel: (02) 522-1813 Dir C Janssen Hi-Fi Team Mgr W Menge, Maxell Team Mgr C van Canneyl

Product: Tape display racks (audio & video)

Discosoul Int'l, 31 Nationalstraat, B 2000 Antwerp Tel: (031) 31 11 47 Telex 31635 Dirs H Lelieu, Jeffrey Maes

Product: Record & tape display racks

• playback / recording equipment

Amplex SA, Rue de l'Industrie, B 1400 Nivelles Tel: (067) 22 49 21 Cable AMPLEX Telex 57432

Eagle Int'l, Rue du Midi 147, B-1000 Brussels Tel: (02) 513 0477 Sales Mgr Jean Pierre Gilbau (Audio & Video)

Tandy Int'l Electronics, PARC Industriel, 5140 Naninne (Namur)

Audio: Realistic

Trialco, 25 Rue des Alcyons B 1000 Brussels Chief Exec G Stricuaert

Canada

• services

DESIGN & ARTWORK

Oynacom Communications Int'l, PO Box 702, Snowdon Sta., Montreal, P Q H3X 3X8 Tel: (514) 342 5200 Pres Dave Leonard (Record only)

Global Prods 350 Sorauren Ave., Toronto Ont M6R 2G8 Tel: (416) 531 5751 Cable GLOBLOPROD (Tape only)

Golden Rec. Mfg. Ltd., 500 Coronation Dr., West Hill, Ont. M1E 4V7 Tel: (416) 281 9522

Bill Hicks Design & Photography, 61 Gerstie St., 2nd Fl., Winnipeg, Man R3A 1B5 Tel: (204) 943 1868

Holborne Dist Co. Ltd., PO Box 9 Mount Albert, Ont. L0G 1M0 Tel: (416) 294 9398 Pres Frank P Swain, Custom Sales Mgr M C Swain.

Intermodal Prodn's Ltd., PO Box 2199, Vancouver, B C V6B 3V7 Tel: (604) 688 1820 Pres & Sales Mgr John Rodney, Adv Mgr Evelyn Rodney

Sheldon Kagan Prodn's, 2555 Cote Vertu, Rim. 100, St. Laurent, P Q H4R 1Z6 Tel: (514) 331-7282 Gen Mgr Sheldon Kagan, Sales Mgr Donny Kagan (Record only)

Lithobac Canada Ltd., 600 Port Royal W., Montreal, P Q H3L 2C5 Tel: (514) 388 1133

Metro Graphic Inc. 2800 Francis Hughes Ave., Laval, P Q H7L 3M4 Tel: (514) 663 0370 Cable METROGRAPH Pres Paul Kizner, Gen. Mgr Sam Ungar, Sales Mgr Marvin Chankowsky (Record only)

Ok! Assocs., PO Box 103, Sta A, Toronto, Ont M5W 1A2 Tel: (416) 481 8995

Pacific Int'l Magnetics Inc., 200 11031 Bridgeport Rd., Richmond, B.C V6X 3A2 Tel: (604) 273 6015/1851 Telex: (04) 357568 Pres Paul B Brown

Branch: Winnipeg, Man., 152 Emerson Postal Code R2G 1E9 Tel: (204) 338 0709

Int'l branch: USA, San Francisco, Calif

Parr's Print & Litho Ltd., 111 Ferner St., Markham, Ont L3R 3K6 Tel: (416) 495 3300 Pres R A Gray; Gen Mgr D Fulton, VP Sales R J Humphreys

Praise Inds. Corp., 6979 Curragh Ave., Burnaby, B C V5J 4V6 Tel: (604) 438 8266 Gen Mgr Paul Yaroshuk

Ross Ellis Ltd., 300 Ann St., Montreal, P Q H3C 2K2 Tel: (514) 861 2411 Telex: (05) 267411

Branch: Markham, Ont., 227 Idema Rd. Postal Code L3R 1B1 Tel: (416) 495 9811 Telex: (06) 986895

Shorewood Packaging Corp of Canada Ltd., 2220 Midland Ave., Scarborough, Ont M1P 3E6 Tel: (416) 292 3990 Telex: (065) 25228

Branch: Montreal, P.Q., 1625 Chabanel St. W., Suite 1070 Postal Code H4N 2S7 Tel: (514) 382 8211

Home office: USA, New York, N.Y

Studio Lorraine, 310 Ann St., Montreal, P Q H3C 2K1 Tel: (514) 861 2759 Telex: (05) 267411

World Recs (div of Shotgun Gimme Holdings Ltd.), PO Box 2000, Baseline Rd W at Courtoise, Bowmanville, Ont L1C 3Z3 Tel: (416) 576 0250, Toronto 686 2828 Pres Bill Hewson, Gen Mgr Bob Stone, Art Dir Doug Powers

PRINTERS & LITHOGRAPHERS

Capitol Recs. EMI of Canada Ltd., 3109 American Dr., Mississauga, Ont. L4V 1B2. Tel: (416) 677-5050. Cable: CAPITOLREC. Telex: (06) 968619. Pres: J.D. Evans.

Branches: Calgary, Alta., 519 Manitou Rd. SE. Postal Code: T2G 4C2. Tel: (403) 287-0823—Vancouver, B.C., Century Plaza, Suite 503, 1015 Burrard St. Postal Code: V6Z 1Y5. Tel: (604) 689-8667—Dorval, P.Q., 9245 Cote de Liesse Rd. Postal Code: H9P 2N9. Tel: (514) 631-9073

Global Prods., 350 Sorauera Ave., Toronto, Ont. M6R 2G8. Tel: (416) 531-5751. Cable: GLOBOLPRODD. (Tape only)

Golden Rec. Mfg. Ltd., 500 Coronation Dr., West Hill, Ont. M1E 4V7. Tel: (416) 281-9522.

Holborne Dist. Co. Ltd., PD Box 9, Mount Albert, Ont. L0G 1M0. Tel: (416) 294-9398. Pres: Frank P. Swain, Custom Sales Mgr. M.C. Swain.

Lithobac Canada Ltd., 600 Port Royal W., Montreal, P.Q. H3L 2C5. Tel: (514) 388-1133.

Modern Album of Canada Ltd., 2450 Finch Ave. W., Unit 7, Weston, Ont. M9M 2E9. Tel: (416) 745-5033.

Pacific Int'l Magnetics Inc., 200-11031 Bridgeport Rd., Richmond, B.C. V6X 3A2. Tel: (604) 273-6015/1851. Telex: (04) 357568. Pres: Paul B. Brown.

Branch: Winnipeg, Man., 152 Emerson. Postal Code: R2G 1E9. Tel: (204) 338-0709.

Int'l branch: USA, San Francisco, Calif.

Par's Print & Litho Ltd., 111 Ferrier St., Markham, Ont. L3R 3K6. Tel: (416) 495-3300. Pres: R.A. Gray, Gen. Mgr.: D. Fulton; VP Sales: R.J. Humphreys.

Prase Inds. Corp., 6979 Curragh Ave., Burnaby, B.C. V5J 4V6. Tel: (604) 438-8266. Gen. Mgr. Paul Yaroshuk.

Ross-Ellis Ltd., 300 Ann St., Montreal, P.Q. H3C 2K2. Tel: (514) 861-2411. Telex: (05) 267411.

Branch: Markham, Ont., 227 Idema Rd., Postal Code: L3R 1B1. Tel: (416) 495-9811. Telex: (06) 986895.

Shorewood Packaging Corp. of Canada Ltd., 2220 Midland Ave., Scarborough, Ont. M1P 3E6. Tel: (416) 292-3990. Telex: (065) 25228

Branch: Montreal, P.Q., 1625 Chabanel St. W., Suite 1070. Postal Code: H4N 2S7. Tel: (514) 382-8211.

Home office: USA, New York, N.Y.

World Recs. (div. of Shotgun Gimme Holdings Ltd.), PD Box 2000, Baseline Rd. W. at Courthouse, Bowmanville, Ont. L1C 3Z3. Tel: 576-0250. Toronto: 686-2828. Pres: Bill Hewson; Gen. Mgr.: Bob Stone, Art Dir.: Doug Powers

TAPE CUSTOM DUPLICATORS TAPE PACKAGING & LABELING

The Audio and Video lines indicate the configurations which the firms duplicate. Companies which offer packaging and labeling of tape product are indicated by (PKG) which appears after the main body of their respective listing.

Capitol Recs. EMI of Canada Ltd., 3109 American Dr., Mississauga, Ont. L4V 1B2. Tel: (416) 677-5050. Cable: CAPITOLREC. Telex: (06) 968619. Pres: J.D. Evans.

Branches: Calgary, Alta., 519 Manitou Rd. SE. Postal Code: T2G 4C2. Tel: (403) 287-0823—Vancouver, B.C., Century Plaza, Suite 503, 1015 Burrard St. Postal Code: V6Z 1Y5. Tel: (604) 689-8667—Dorval, P.Q., 9245 Cote de Liesse Rd. Postal Code: H9P 2N9. Tel: (514) 631-9073.

Audio: 8-tr., cassette.

Cinram Ltd., 2255 Markham Rd., Scarborough, Ont. M1B 2W3. Tel: (416) 298-8190. Telex: (065) 26142.

Audio: 8-tr., cassette.

Eastern Sound Co. Ltd., 48 Yorkville Ave., Toronto, Ont. M4W 1L4. Tel: (416) 920-2211. Mgr. Peter Holcomb.

Audio: Cassette, open reel.

Global Prods., 350 Sorauera Ave., Toronto, Ont. M6R 2G8. Tel: (416) 531-5751. Cable: GLOBOLPRODD (PKG)

Audio: 8-tr., cassette.

Golden Rec. Mfg. Ltd., 500 Coronation Dr., West Hill, Ont. M1E 4V7. Tel: (416) 281-9522 (PKG)

Audio: 8-tr., cassette.

Hardman Inds. Ltd., 34 Greensboro Dr., Rexdale, Ont. M9W 1E1. Tel: (416) 245-7890. Chm: Eric H. Hardman; Pres: Eric S. Hardman; Nat'l Sales Mgr.: Carl Cooley (PKG)

Audio: 8-tr., cassette.

Intermodal Prod'ns Ltd., PO Box 2199, Vancouver, B.C. V6B 3V7. Tel: (604) 688-1820. Pres & Sales Mgr.: John Rodney; Adv. Mgr.: Evelyn Rodney.

Audio: 8-tr., cassette, open reel.

L.S.J. Cassette Corp., 50 Don Park Rd., Unit 14, Markham, Ont. L3R 1J3. Tel: (416) 495-9378. (PKG)

Audio: Cassette.

Magna Tape Mfg. Inc., 34 Greensboro Dr., Rexdale, Ont. M9W 1E1. Tel: (416) 245-7890. Telex: (06) 989393 (PKG)

Audio: 8-tr., cassette.

Pacific Int'l Magnetics Inc., 200-11031 Bridgeport Rd., Richmond, B.C. V6X 3A2. Tel: (604) 273-6015/1851. Telex: (04) 357568. Pres: Paul B. Brown. (PKG—audio & video)

Branch: Winnipeg, Man., 152 Emerson. Postal Code: R2G 1E9. Tel: (204) 338-0709.

Int'l branch: USA, San Francisco, Calif.

Audio: Cassette, open reel.

Piasetzki Recordatape Ontario Ltd. (PRT Tapes), 1489 Merivale Rd., Ottawa, Ont. K2E 5P3. Tel: (613) 224-6692. (PKG)

PolyGram Inc., 6000 Cote de Liesse, St. Laurent, P.Q. H4T 1E3. Tel: (514) 739-2701. Cable: POLYDISC. Telex: (05) 825690.

Branches: Calgary, Alta., 7220 Fisher St. SE, Suite 110. Postal Code: T2H 2H8. Tel: (403) 253-7665. Telex: (03) 821859—Vancouver, B.C., Mezza-mine, 805 W. Broadway. Postal Code: V5Z 1K1. Tel: (604) 873-2466.

Branch: (045) 4410—Winnipeg, Man., c/o Phillips Electronics, 401 Weston St. E. Postal Code: R3E 3H4. Tel: (204) 786-5748. Telex: (07) 57786—Etobicoke, Ont., Etobicoke Tower, Suite 707, 555 Burnhamthorpe Rd. W. Postal Code: M9C 2Y3. Tel: (416) 622-6680. Telex: (06) 967755.

Audio: 8-tr., cassette.

Prase Inds. Corp., 6979 Curragh Ave., Burnaby, B.C. V5J 4V6. Tel: (604) 438-8266. Gen. Mgr.: Paul Yaroshuk.

Audio: 8-tr., cassette, open reel.

Quality Recs. Ltd., 380 Birchmount Rd., Scarborough, Ont. M1K 1M7. Tel: (416) 698-5511. Telex: (06) 219624. Pres. Custom Mfg. & Finance: Terry M. Lynd.

Audio: 8-tr., cassette.

Stereodyne Ltd., 3121 Universal Dr., Mississauga, Ont. L4X 2E2. Tel: (416) 625-8311. (PKG)

Audio: 8-tr., cassette.

A/V/T-62

World Recs. (div. of Shotgun Gimme Holdings Ltd.), PD Box 2000, Baseline Rd. W. at Courthouse, Bowmanville, Ont. L1C 3Z3. Tel: (416) 576-0250. Toronto: 686-2828. Pres: Bill Hewson; Gen. Mgr.: Bob Stone. (PKG) Audio: 8-tr., cassette.

TAPE DUPLICATOR/MARKETER

Piasetzki Recordatape Ontario Ltd. (PRT Tapes), 1489 Merivale Rd., Ottawa, Ont. K2E 5P3. Tel: (613) 224-6692

• supplies

The key to the abbreviations following the company listings is: (M) Manufacturer, (D) Distributor, (I) Importer.

CARTRIDGE & CASSETTE PARTS

Ampeg Canada Inc., 132 East Dr., Bramalea, Ont. L6T 3T9. Tel: (416) 791-3100. VP & Gen. Mgr.: J.L. Major; VP & Nat'l Magnetic Tape Prods. Mgr.: J.R. Pariselli.

Branches: Calgary, Alta., 1116-55 Ave. NE. Postal Code: T2E 6Y4. Tel: (403) 275-3444—Dorval, P.Q., 729 Ave. Meloche. Postal Code: H9P 2S4. Tel: (514) 636-4840.

Audio: 8-tr. & cassette parts

Analyst, see Pacific Int'l.

Capitol Recs. EMI of Canada Ltd., 3109 American Dr., Mississauga, Ont. L4V 1B2. Tel: (416) 677-5050. Cable: CAPITOLREC. Telex: (06) 968619. Pres: J.D. Evans.

Branches: Calgary, Alta., 519 Manitou Rd. SE. Postal Code: T2G 4C2. Tel: (403) 287-0823—Vancouver, B.C., Century Plaza, Suite 503, 1015 Burrard St. Postal Code: V6Z 1Y5. Tel: (604) 689-8667—Dorval, P.Q., 9245 Cote de Liesse Rd. Postal Code: H9P 2N9. Tel: (514) 631-9073.

Audio: 8-tr.

Global Prods., 350 Sorauera Ave., Toronto, Ont. M6R 2G8. Tel: (416) 531-5751. Cable: GLOBOLPRODD.

Audio: 8-tr., cassette.

Pacific Int'l Magnetics Inc., 200-11031 Bridgeport Rd., Richmond, B.C. V6X 3A2. Tel: (604) 273-6015/1851. Telex: (04) 357568. Pres: Paul B. Brown.

Branch: Winnipeg, Man., 152 Emerson. Postal Code: R2G 1E9. Tel: (204) 338-0709.

Int'l branch: USA

Audio: Cassette components & shells

Brand name: Analyst.

Stereodyne Ltd., 3121 Universal Dr., Mississauga, Ont. L4X 2E2. Tel: (416) 625-8311.

Audio: 8-tr. & cassette housings

EMPTY CARTRIOGES, CASSETTES & REELS

Ampeg Canada Inc., 132 East Dr., Bramalea, Ont. L6T 3T9. Tel: (416) 791-3100. VP & Gen. Mgr.: J.L. Major; VP & Nat'l Magnetic Tape Prods. Mgr.: J.R. Pariselli.

Branches: Calgary, Alta., 1116-55 Ave. NE. Postal Code: T2E 6Y4. Tel: (403) 275-3444—Dorval, P.Q., 729 Ave. Meloche. Postal Code: H9P 2S4. Tel: (514) 636-4840.

Audio: 8-tr., cassette, open reel

Analyst, see Pacific Int'l.

Capitol, see Will Farrow.

Data Packaging, see LSJ Cassette.

Will Farrow Assocs. Ltd., 5200 Dixie Rd., Unit 33, Mississauga, Ont. L4W 1E4. Tel: (416) 625-8151. Pres & Gen. Mgr.: Will Farrow, Sales Mgr.: Julie Thomson (Canadian sales office for Capitol Magnetic Tape Div.)

Audio: 8-tr., cassette, open reel

Brand name: Capitol.

Global Prods., 350 Sorauera Ave., Toronto, Ont. M6R 2G8. Tel: (416) 531-5751.

Audio: 8-tr., cassette.

Hardman Inds. Ltd., 34 Greensboro Dr., Rexdale, Ont. M9W 1E1. Tel: (416) 245-7890. Telex: (06) 989393. Chm: Eric H. Hardman; Pres: Eric S. Hardman; Nat'l Sales Mgr.: Carl Cooley.

Audio: 8-tr. shells & S screw cassette shells (sonic welded)

I.P.S., see LSJ Cassette.

L.S.J. Cassette Corp., 50 Don Park Rd., Unit 14, Markham, Ont. L3R 1J3. Tel: (416) 495-9378.

Audio: 8-tr., cassette.

Brand names: Data Packaging, IPS, Lenco.

Lenco, see LSJ Cassette.

Pacific Int'l Magnetics Inc., 200-11031 Bridgeport Rd., Richmond, B.C. V6X 3A2. Tel: (604) 273-6015/1851. Telex: (04) 357568. Pres: Paul B. Brown.

Branch: Winnipeg, Man., 152 Emerson. Postal Code: R2G 1E9. Tel: (204) 338-0709.

Int'l branch: USA

Audio: Cassettes, reels.

Brand name: Analyst.

Pan Canada Magnetics Ltd., 1072 Rangeview Rd., Port Credit, Ont. L5E 1H3. Tel: (416) 278-9851. Telex: (06) 960159.

Audio: All configurations.

Solo Prods., see Stereodyne.

Stereodyne Ltd., 3121 Universal Dr., Mississauga, Ont. L4X 2E2. Tel: (416) 625-8311.

Audio: 8-tr. & cassette.

Brand Name: Solo Prods.

PROFESSIONAL TAPE SUPPLIES

Editral, see McKee Electronics.

Holborne Dist. Co. Ltd., PO Box 9, Mount Albert, Ont. L0G 1M0. Tel: (416) 294-9398. Pres: Frank P. Swain, Custom Sales Mgr. M.C. Swain.

Audio: Cassette labels

McKee Electronics Ltd., PO Box 4054, 780 Bank St., Ottawa, Ont. K1S 5B1. Tel: (613) 236-7242. Telex: (05) 33381.

Audio: Bulk erasers, splicing & editing equip

Brand names: WRE, Editral.

Pacific Int'l Magnetics Inc., 200-11031 Bridgeport Rd., Richmond, B.C. V6X 3A2. Tel: (604) 273-6015/1851. Telex: (04) 357568. Pres: Paul B. Brown.

Branch: Winnipeg, Man., 152 Emerson. Postal Code: R2G 1E9. Tel: (204) 338-0709.

Int'l branch: USA

Audio: Splicing & leader tapes, cassette labels.

Video: Videocassette labels.

Brand names: Analyst, 3M.

Swire Intermagnetics Canada, 77 Steeles Rd. W., Unit C Markham, Ont. L3R 2M4. Tel: (416) 495-0631. VP & Canada: Brian Lundstrom

Home office: USA

Product: "Phillips-style" cassette boxes

W R E, see McKee Electronics

World Recs. (div. of Shotgun Gimme Holdings Ltd.), PD Box 2000, Baseline Rd. at Courthouse, Bowmanville, Ont. L1C 3Z3. Tel: (416) 576-0250. Toronto: 686-2828. Pres: Bill Hewson; Gen. Mgr.: Bob Stone. Audio: Cassette labels.

TAPE, BLANK LOADED

The numbers in parentheses following the 8-track & cassette configurations show recording time in minutes; those following open reel configurations show length of tape in feet.

Ampeg Canada Inc., 132 East Dr., Bramalea, Ont. L6T 3T9. Tel: (416) 791-3100. VP & Gen. Mgr.: J.L. Major; VP & Nat'l Magnetic Tape Prods. Mgr.: J.R. Pariselli.

Branches: Calgary, Alta., 1116-55 Ave. NE. Postal Code: T2E 6Y4. Tel: (403) 275-3444—Dorval, P.Q., 729 Ave. Meloche. Postal Code: H9P 2S4. Tel: (514) 636-4840.

Audio: 8-tr., (45,90) cassette (45,60,90,120), open reel (1500', 2150', 2440', 3000', 3600'), broadcast.

Video: 1" open reel, 1/4" cassette (10,20,30,40,50,60), 1/2" EIAJ open reel (1250', 2400')

Analyst, see Pacific Int'l.

Audio Magnetics Corp. of Canada Ltd., 1180 MartinGrove Rd., Rexdale, Ont. M9W 5M9. Tel: (416) 298 9111.

Audio: 8-tr. (40,80), cassette (45, 60, 90, 120), open reel.

Brand names: Cycles, Tracs, Tracs Plus, XHE.

B A S F (Canada) Ltd., PO Box 430, Ste. St. Laurent, Montreal, P.Q. H4L 4V8. 5850 Cote de Liesse Rd., Town of Mt. Royal, P.Q. H4T 1B2. Tel: (514) 341-5411. Telex: (05) 82777.

Audio: 8-tr., cassette, open reel

Capitol Recs. EMI of Canada Ltd., 3109 American Dr., Mississauga, Ont. L4V 1B2. Tel: (416) 677-5050. Cable: CAPITOLREC. Telex: (06) 968619. Pres: J.D. Evans.

Branches: Calgary, Alta., 519 Manitou Rd. SE. Postal Code: T2G 4C2. Tel: (403) 287-0823—Vancouver, B.C., Century Plaza, Suite 503, 1015 Burrard St. Postal Code: V6Z 1Y5. Tel: (604) 689-8667—Dorval, P.Q., 9245 Cote de Liesse Rd. Postal Code: H9P 2N9. Tel: (514) 631-9073.

Audio: 8-tr., cassette.

Cinram Ltd., 2255 Markham Rd., Scarborough, Ont. M1B 2W3. Tel: (416) 298-8190. Telex: (065) 26142.

Audio: 8-tr., cassette.

Cycles, see Audio Magnetics.

Dynapak, see Stereodyne.

Edmund Scientific Prods. Co., 3500 Bathurst St., Toronto, Ont. M6A 2C6. Tel: (416) 787-4584.

Audio: Endless-loop cassette.

Will Farrow Assocs. Ltd., 5200 Dixie Rd., Unit 33, Mississauga, Ont. L4W 1E4. Tel: (416) 625-8151. Pres & Gen. Mgr.: Will Farrow; Sales Mgr.: Julie Thomson (Canadian sales office for Capitol Magnetic Tape Div.)

Audio: Cassette

Brand name: Ultrasound.

Finetape Canada Ltd., 800 Islington Ave., Toronto, Ont. M8Z 4N7. Tel: (416) 252-7209.

Audio: 8-tr. (40,45,60,90), cassette (30,45,60,90,120), open reel (600', 900', 1200', 1800').

Video: 1/4" cassette, 1/2" Beta & VHS cassette.

Fuji, see Pacific Int'l.

Global Prods., 350 Sorauera Ave., Toronto, Ont. M6R 2G8. Tel: (416) 531-5751. Cable: GLOBOLPRODD.

Audio: 8-tr. (40,45,60,90 & custom lengths), cassette (40,45,60,90 & custom lengths), open reel.

Hardman Inds. Ltd., 34 Greensboro Dr., Rexdale, Ont. M9W 1E1. Tel: (416) 245-7890. Telex: (06) 989393. Chm: Eric H. Hardman; Pres: Eric S. Hardman; Nat'l Sales Mgr.: Carl Cooley.

Audio: 8-tr. (45,90), cassette (60,90)

Instart, see Pacific Int'l.

International Audio Visual Ltd., PO Box 1096. Postal Code: V31 6Z4, 224 Cayer St., Coquitlam, B.C. V3K 5B1. Tel: (604) 522-7955. Pres: Dr. Peter P. Allinger. VP Sales: Philip Allinger.

Audio: Cassette and back loop tape

L.S.J. Cassette Corp., 50 Don Park Rd., Unit 14, Markham, Ont. L3R 1J3. Tel: (416) 495-9378.

Audio: 8-tr., cassette.

Brand name: Media.

Laser, see Swire.

Le-Bo, see Phonodisc.

Lecturecassette, see Pacific Int'l.

Littercassette, see Pacific Int'l.

Magna Tape Mfg. Inc., 34 Greensboro Dr., Rexdale, Ont. M9W 1E1. Tel: (416) 245-7890. Telex: (06) 989393.

Audio: 8-tr., cassette, open reel.

Manell, see Tr Tel Assocs.

Media, see LSJ Cassette.

Memorex, see Phonodisc.

Pacific Int'l Magnetics Inc., 200-11031 Bridgeport Rd., Richmond, B.C. V6X 3A2. Tel: (604) 273-6015/1851. Telex: (04) 357568. Pres: Paul B. Brown.

Branch: Winnipeg, Man., 152 Emerson. Postal Code: R2G 1E9. Tel: (204) 338-0709.

Int'l branch: USA

Audio: Cassette, open reel

Video: 1/2" Beta & VHS cassette

Brand names: Analyst, Lecturecassette, Littercassette, Instart

Pan Can, see Pan Canada Magnetics

Stereodyne Ltd 3121 Universal Dr., Mississauga, Ont L4X 2E2 Tel (416) 625 8311.
 Audio: 8 tr. (40.45,80.90), cassette (60.90)
Brand name: Oynapak
 Teac, see White Electronic
 Tracs, see Audio Magnetics
 Tracs Plus, see Audio Magnetics
 Tri Tel Assocs Ltd 105 Sparks Ave., Willowdale, Ont M2H 2S5 Tel (416) 499-5044 Telex (06) 23443 Pres R B Finkle, Mktg Mgr R W Finkle, Sales Mgr H H Gruenstein
 Audio: 8 tr., cassette, open reel
 Video: 1/2" Beta & VHS cassette
Brand name: Mael
 Ultrasound, see Will Farrow
 White Electronic Development Corp (1966) Ltd., 6300 Northam Dr. Malton, Ont L4V 1H7 Tel (416) 676 9090 Telex (06) 983584 (Importer)
 Branch: Montreal, P.Q., 4750 Blvd des Grandes Prairies Postal Code H1R 1A1 Tel (514) 326 4075
 Audio: Cassette, open reel
Brand name: Teac
 X H E, see Audio Magnetics

TAPE, BULK RAW

Agfa, see Photo Importing
 Ampex Canada Inc., 132 East Dr., Bramalea, Ont L6T 3T9 Tel (416) 791 3100 VP & Gen Mgr J L Major, VP & Nat'l Magnetic Tape Prods Mgr J R Parselli
 Branches: Calgary, Alta., 1116 55 Ave NE Postal Code T2E 6Y4 Tel (403) 275 3444-Dorval, P.Q., 729 Ave Meloche Postal Code H9P 2S4 Tel (514) 636 4840
 Audio: 8 tr., cassette, open reel
 Analyst, see Pacific Int'l
 Audio Magnetics Corp of Canada Ltd., 1180 MartinGrove Rd., Rexdale, Ont M9W 5M9 Tel (416) 298 9111
 Audio: 8 tr., cassette, open reel
 B A S F (Canada) Ltd., PO Box 430, Sta St Laurent, Montreal, P.Q. H4L 4V8, 5850 Cote de Liesse Rd., Town of Mt Royal, P.Q. H4T 1B2 Tel (514) 341 5411 Telex (05) 827777
 Audio: Cassette
 Video: 1/2" cassette
 Capitol, see Will Farrow
 Will Farrow Assocs Ltd., 5200 Dixie Rd., Unit 33, Mississauga, Ont L4W 1E4 Tel (416) 625-8151 Pres & Gen Mgr Will Farrow, Sales Mgr Julie Thomson (Canadian sales office for Capitol Magnetic Tape Div.)
 Audio: 8-tr., cassette
Brand name: Capitol
 Finetape Canada Ltd., 800 Islington Ave., Toronto, Ont M8Z 4N7 Tel (416) 252 7209
 Audio: 8 tr. cassette
 Global Prods., 350 Sorareun Ave., Toronto, Ont M6R 2G8 Tel (416) 531 5751 Cable GLOBOLPROD
 Audio: 8-tr., cassette, open reel
 Instart, see Pacific Int'l
 L S J Cassette Corp., 50 Don Park Rd., Unit 14, Markham, Ont L3R 1J3 Tel (416) 495 9378
 Audio: 8 tr., cassette
Brand name: Media
 Lecturecassette, see Pacific Int'l
 Lettercassette, see Pacific Int'l
 Magna Tape Mfg Inc., 34 Greensboro Dr., Rexdale, Ont M8W 1E1 Tel (416) 245 7890 Telex (06) 989393
 Audio: Cassette
 Media, see LSJ
 Pacific Int'l Magnetics Inc., 200-11031 Bridgeport Rd., Richmond, B.C. V6X 3A2 Tel (604) 273 6015/1851 Telex (04) 357568 Pres Paul B Brown
 Branch: Winnipeg, Man., 152 Emerson Postal Code R2G 1E9 Tel (204) 338 0709
 Audio: Cassette, open reel
Brand names: Analyst, Instart Lecturecassette, Lettercassette
 Pan Canada Magnetics Ltd., 1072 Rangeview Rd., Port Credit, Ont L5E 1H3 Tel (416) 278 9851 Telex (06) 960159
 Audio: 8-tr., cassette, open reel
 Photo Importing Agencies Ltd., 29 Gurney Crescent, Toronto, Ont M6B 1S9 Tel (416) 667 0700 Telex 22631
 Audio: 8 tr., cassette, open reel
Brand name: Agfa
 Praise Inds. Corp., 6979 Curragh Ave., Burnaby, B.C. V5J 4V6 Tel (604) 438 8266 Gen Mgr Paul Yaroshuk
 Audio: 8 tr., cassette
Brand name: Presonic

TAPE DUPLICATING & PROCESSING EQUIPMENT

Ampex Canada Inc., 132 East Dr., Bramalea, Ont L6T 3T9 Tel (416) 791 3100 VP & Gen Mgr J L Major VP & Nat'l Magnetic Tape Prods Mgr J R Parselli
 Branches: Calgary, Alta., 1116 55 Ave NE Postal Code T2E 6Y4 Tel (403) 275 3444-Dorval, P.Q., 729 Ave Meloche Postal Code H9P 2S4 Tel (514) 636 4840
 Product: Bin loop duplicators, master reproducers
Brand names: Ampex, Stencil
 B A S F (Canada) Ltd., PO Box 430, Sta St Laurent, Montreal, P.Q. H4L 4V8, 5850 Cote de Liesse Rd., Town of Mt Royal, P.Q. H4T 1B2 Tel (514) 341 5411 Telex (05) 827777
 Product: Pancakes
 Finetape Canada Ltd., 800 Islington Ave., Toronto, Ont M8Z 4N7 Tel (416) 252 7209
 Product: Audio tape coating, slitting machines
 Global Prods., 350 Sorareun Ave., Toronto, Ont M6R 2G8 Tel (416) 531 5751 Cable GLOBOLPROD
 Product: "In cassette" duplicator
 Pacific Int'l Magnetics Inc., 200 11031 Bndgeport Rd., Richmond, B.C. V6X 3A2 Tel (604) 273-6015/1851. Telex (04) 357568 Pres Paul B Brown
 Branch: Winnipeg, Man., 152 Emerson Postal Code R2G 1E9 Tel (204) 338 0709
 Int'l branch: USA
 Product: Cassette duplicators
Brand names: Pentagon, Sony
 Pentagon, see Pacific Int'l
 Sony, see Pacific Int'l
 Stencil, see Ampex Canada

TAPE PACKAGING & LABELING EQUIPMENT

Graham Fraser Pkg. Machinery Ltd., 50 Don Park Rd., Unit 5, Markham, Ont L3K 1J3 Tel (416) 495 6944 Contact Helmut Woertche
 Product: Tape packaging machines, conveyors, cartons, fully automatic systems, specially designs
 L S J Cassette Corp., 50 Don Park Rd., Unit 14, Markham, Ont L3R 1J3 Tel (416) 495 9378
 Product: Cassette assembly, packaging & winding, Norelco standard, mini & micro cassette loads
 Metro Graphic Inc., 2800 Francis Hughes Ave., Laval, P.Q. H7L 3M4 Tel (514) 663-0370 Pres Paul Kizner, Gen Mgr Sam Ungar, Sales Mgr Marvin Chankowsky
 Product: Label curing oven

• accessories

Ampex Canada Inc., 132 East Dr., Bramalea, Ont L6T 3T9 Tel (416) 791 3100 VP & Gen Mgr J L Major, VP & Nat'l Magnetic Tape Prods Mgr J R Parselli
 Branches: Calgary, Alta., 1116 55 Ave NE Postal Code T2E 6Y4 Tel (403) 275 3444-Dorval, P.Q., 729 Ave Meloche Postal Code H9P 2S4 Tel (514) 636 4840
 Product: Tape-head cleaners & demagnetizers, leader & splicing tape
 Aspen, see Smyth Sound
 B A S F (Canada) Ltd., PO Box 430, Sta St Laurent, Montreal, P.Q. H4L 4V8, 5850 Cote de Liesse Rd., Town of Mt Royal, P.Q. H4T 1B2 Tel (514) 341 5411 Telex (05) 827777
 Product: Tape-carrying & storage cases, head cleaners & demagnetizers, leader & splicing tape
 O C L Micro Electronics 1500 W Georgia St., Suite 1490 Vancouver, B.C. V6G 2T6 Tel (604) 687 7747 Nat'l Sales & Promo Mgr Daniel Rby
 Product: Tape-cassette storage units
 Quotone, see Will Farrow
 Empire Scientific Corp Ltd., 65 Martin Ross Ave., Downsview, Ont M3J 2L6 Tel (416) 661 3910
 Home office: USA
 Product: Record-replacement styli
 Will Farrow Assocs Ltd., 5200 Dixie Rd., Unit 33, Mississauga, Ont L4W 1E4 Tel (416) 625 8151 Pres & Gen Mgr Will Farrow, Sales Mgr Julie Thomson
 Product: Record-carrying & storage cases, record care prods 45 rpm adaptors, replacement styli, Tape-carrying & storage cases, head cleaners & demagnetizers, leader & splicing tape (Duotone)
 Finetape Canada Ltd., 800 Islington Ave. Toronto, Ont M8Z 4N7 Tel (416) 252 7209
 Product: Tape-head cleaners, leader tape
 Global Prods., 350 Sorareun Ave. Toronto, Ont M6R 2G8 Tel (416) 531 5751 Cable GLOBOLPROD
 Product: Record-carrying & storage cases, record care prods., 45 rpm adaptors, replacement styli, Tape-carrying & storage cases, head cleaners & demagnetizers, leader & splicing tape
 Hardman Inds Ltd., 34 Greensboro Dr., Rexdale, Ont M9W 1E1 Tel (416) 245 7890 Telex (06) 989393 Chm Eric H Hardman, Pres Eric S Hardman, Nat'l Sales Mgr Carl Cooley
 Product: Tape-head cleaners (Hi Performance)
 Hi Performance, see Hardman
 International Audio Visual Ltd., PO Box 1096 Postal Code V3J 6Z4, 224 Cayer St. Coquitlam B.C. V3K 5B1 Tel (604) 522 7955 Cable IAVSOUND Pres Or Peter P Allinger, VP Sales Philip Allinger
 Product: Tape-head cleaners & demagnetizers, splicing & editing equip
 L S J Cassette Corp., 50 Don Park Rd., Unit 14, Markham Ont L3R 1J3 Tel (416) 495 9378
 Product: Tape-head cleaners, demagnetizers
 Magna Tape Mfg Inc., 34 Greensboro Dr., Rexdale, Ont M9W 1E1 Tel (416) 245 7890 Telex (06) 989393
 Product: Tape-carrying & storage cases, head cleaners, demagnetizers, leader & splicing tape
 Moss Music Group (Canada) Ltd., 510 Coronation Dr., Unit 17, West Hill, Ont M1E 4X6 Tel (416) 284 0126 Pres & Gen Mgr John Leetham, Sales Mgr Julian Rice
 Product: Record & Tape-carrying & storage cases
 Pacific Int'l Magnetics Inc., 200 11031 Bridgeport Rd., Richmond, B.C. V6X 3A2 Tel (604) 273 6015/1851. Telex (04) 357568. Pres. Paul B. Brown
 Product: Tape-carrying & storage cases, head cleaners, bulk erasers, splicing tape & equip (all audio & video), demagnetizers, leader tape (audio only)
 Pan Canada Magnetics Ltd., 1072 Rangeview Rd., Port Credit, Ont L5E 1H3 Tel (416) 278 9851 Telex (06) 960159
 Product: Tape-carrying & storage cases, head cleaners & demagnetizers, leader tape
 Permostat, see Tri Tel
 Phonodisc Ltd., 30 Malley Rd., Scarborough, Ont M1L 2E3 Tel (416) 751 9610 Telex (06) 963629 Pres JA Trainor, Nat'l Sales Mgr R Lutes, Eastern Sales Mgr J Grobbo, Ont Sales S Harradine, R Caskenette, Que Sales G Kouri, Western Sales Mgr G Gow, Man & Sask Sales G Lipchen
 Branch: Vancouver, B.C., La Go Music Ltd., 3446 Bridgeway St Postal Code V5K 1B6 Tel (604) 294 6226
 Product: Record-carrying & storage cases, record care prods., 45 RPM adaptors replacement styli, Tape-carrying & storage cases, head cleaners, demagnetizers, leader & splicing tape
 Record Care, see Smyth
 Smyth Sound Equip Ltd., 595 Parc Industriel, Longueuil, P.Q. J4H 3V7 Tel (514) 679 5490
 Product: Record-record care prods (Watts, Record Care), replacement styli (Aspen), Tape-head cleaners, demagnetizers (Aspen)
 Sony Of Canada Ltd., 1370 Sony Pl., Winnipeg, Man R3C 3C3 Tel (204) 284 7160
 Home office: Japan
 Product: Tape-head demagnetizers, splicing & editing equip
 Stereodyne Ltd., 3121 Universal Dr., Mississauga, Ont L4X 2E2 Tel (416) 625 8311
 Product: Tape-head cleaners
 Tri Tel Assocs Ltd., 105 Sparks Ave., Willowdale, Ont M2H 2S5 Tel (416) 499 5044 Telex (06) 23443 Pres R B Finkle, Mktg Mgr R W Finkle, Sales Mgr H H Gruenstein
 Product: Record-record care prods (Permostat), turntable mats, replacement styli (Stanton), Tape-carrying & storage cases (audio & video), head cleaners (audio & video), demagnetizers (audio only)
 Watts, see Smyth
 White Electronic Development Corp (1966) Ltd., 6300 Northam Dr., Malton, Ont L4V 1H7 Tel (416) 676 9090

Branch: Montreal, P.Q., 4750 Blvd., des Grandes Prairies Postal Code H1R 1A1 Tel (514) 326 4075
 Product: Record-record care prods., Tape-head cleaners, & demagnetizers

• store fixtures

B A S F (Canada) Ltd., PO Box 430, Sta St Laurent, Montreal, P.Q. H4L 4V8, 5850 Cote de Liesse Rd., Town of Mt Royal, P.Q. H4T 1B2 Tel (514) 341 5411 Telex (05) 827777
 Product: Tape display racks.
 Will Farrow Assocs Ltd., 5200 Dixie Rd., Unit 33, Mississauga, Ont L4W 1E4 Tel (416) 625 8151 Pres & Gen Mgr Will Farrow, Sales Mgr Julie Thomson
 Product: Record & tape display racks (Devon Design)
 Global Prods., 350 Sorareun Ave., Toronto, Ont M6R 2G8. Tel: (416) 531 5751 Cable GLOBOLPROD
 Product: Record & tape browser boxes, record & tape display racks, record & tape divider cards
 Magna Tape Mfg Inc., 34 Greensboro Dr., Rexdale, Ont M9W 1E1 Tel (416) 245 7890 Telex (06) 989393
 Product: Tape Browser boxes, tape display racks
 Pacific Int'l Magnetics Inc., 200-11031 Bridgeport Rd., Richmond, B.C. V6X 3A2 Tel (604) 273-6015/1851 Telex (04) 357568 Pres Paul B Brown
 Branch: Winnipeg, Man., 152 Emerson Postal Code R2G 1E9 Tel (204) 338 0709
 Int'l branch: USA
 Product: Tape display racks (audio)
 Phonodisc Ltd., 30 Malley Rd., Scarborough, Ont M1L 2E3 Tel (416) 751 9610 Telex (06) 963629 Pres JA Trainor, Nat'l Sales Mgr R Lutes, Eastern Sales Mgr J Grobbo, Ont Sales S Harradine, R Caskenette, Que Sales G Kouri, Western Sales Mgr G Gow, Man & Sask Sales G Lipchen
 Branch: Vancouver, B.C., La Go Music Ltd., 3446 Bridgeway St Postal Code V5K 1B6 Tel (604) 294 6226
 Product: Record divider cards
 Praise Inds. Corp., 6979 Curragh Ave., Burnaby, B.C. V5J 4V6 Tel (604) 438 8266. Pres Paul Yaroshuk
 Product: Record browser boxes, record display racks, record divider cards
 Tri Tel Assocs Ltd., 105 Sparks Ave., Willowdale, Ont M2H 2S5 Tel (416) 499 5044 Telex (06) 23443 Pres R B Finkle, Mktg Mgr R W Finkle, Sales Mgr H H Gruenstein
 Product: Tape display racks (audio & video)

• playback / recording equipment

Ampex Canada Inc., 132 East Dr., Bramalea, Ont L6T 3T9 Tel (416) 791 3100 Telex (06) 97627 VP & Gen Mgr J L Major, VP & Nat'l Mgr Magnetic Tape J R Parselli
 Branches: Calgary, Alta., 1116 55 Ave. Postal Code T2E 6Y4 Te. (403) 275 3444-Dorval, P.Q., 729 Ave Meloche Postal Code: H9P 2S4 Tel (514) 636 4840
 Audio & Video
 B S R (Canada) Ltd., 26 Clairville Dr., Rexdale, Ont. M9V 4B3 Tel (416) 675 2425 Pres Oon Henderson, Sales Mgr Chris Grant, Prof. Prods Mgr R W Marsh
 Audio: Otari (Japan)
 Denon, see Tri Tel.
 J V C Canada Inc., 31 Progress Ave., Unit 14, Scarborough, Ont M1P 4S6 Tel (416) 291-7729. Telex 6525394
 Audio & Video: JVC, Victor (both Japan)
 McKee Electronics Ltd., 780 Bank St., Ottawa, Ont. K1S 3V6 Tel (613) 236 7242 Telex (053) 3381
 Audio: Revox (USA), Teac (Japan)
 Rupert Neve of Canada Ltd., 2721 Rena Rd., Malton, Ont L4T 3K1 Tel (416) 677-6611 Telex 983502
 Audio: Lyrec, Neve
 Onkyo, see Tri Tel
 Otari, see BSR
 Sony of Canada Ltd., 1370 Sony Pl., Winnipeg, Man R3C 3C3 Tel (204) 284 7160
 Audio & Video: Sony (Japan)
 Tascam, see White
 Teac, see White
 Tri Tel Assocs Ltd., 105 Sparks Ave., Willowdale, Ont M2H 2S5 Tel (416) 499 5044 Telex (06) 23443 Pres R B Finkle, Mktg Mgr R W Finkle, Sales Mgr H H Gruenstein
 Audio: Denon, Onkyo (both Japan)
 Victor, see JVC
 White Electronic Development Corp Ltd., 6300 Northam Dr., Malton, Ont L4V 1H7 Tel (416) 676-9090 Telex (06) 983584 (Importer)
 Branch: Montreal, P.Q., 4750 Blvd des Grandes Prairies Postal Code H1R 1A1 Tel (514) 326-4075
 Audio: Tascam, Teac (both Japan)
 Video: Teac (Japan)

France

• services

DESIGN & ARTWORK

Adolair, 41 Rue Laugier, 75017 Paris Tel: (01) 227.47.54., 267.22.11
 Amphion, 12 Rue Rougemont, 75009 Paris Tel: (01) 246.24.97
 Carabine Music, 124 Rue La Boetie, 75008 Paris Tel: (01) 225.80.30. Co-
 Pres Raymonde Orouel, Nadege Labrue, Gen Mgr Charles Igbu
 Oillard & Cie., 47 49 Rue Polonceau, 75018 Paris Tel: (01) 255.43.21
 Telex 650123 Dir Jean-Pierre Oillard; Sales Mgr Jean-Marc Oelaye
 Fiesta, 30 Rue du Fr Finlay, 75015 Paris Tel: (01) 578.15.18/24.75, Con-
 tacts Marie & Patrick Chevalier.
 Fleche (Disques), 122 Blvd Exelmans, 75016 Paris Tel: (01) 525.20.73
 Gen Mgr Claude Francois, Admin Dir Nicole Gruyer
 France Imprimerie (div of AGI-Audio Graphic Inds.), 124bis Av. de Villiers,

75017 Paris. Tel: (01) 380.65.70. Telex. 290833. Gen. Mgr. Jean Berge
 Sales Mgr. Philippe Berge; Technical Mgr. Mr. Cournaud
Branch: 28260 Anet, Boite Postale 32, 28520 Sorel Mousseil.
 Alan Grima, 31460 Loubens. Tel: (1661) 83 12 55
 International Shows, 10 Rue Damremont, 75018 Paris Tel (01) 606 88 35
 Iris Television, 9 bis Rue Du Commandant Pilot, 92200 Neuilly Sur Seine
 Tel (1) 624 13 10. Telex 613980.
 Michel Laguens Org., 47 Av. Paul Doumer, 75016 Paris Tel (01) 520 37 53
 Telex: 611650 Pres. Michel Laguens, Gen. Mgr. Monique Dupuy.
 Jean Pierre Leior, 26 Rue Notre Dame des Victoires, 75002 Paris. Tel (01)
 296.27.97. Gen. Mgr. Jean-Pierre Leior
 Michel Meyer & Cie, 8 Rue de l'Est, 92100 Boulogne. Tel (01) 605 43 21
 Telex: 201336. Chief Exec.: Michel Meyer; Gen. Mgr. Philippe Ternier
 (Rec. only)
 Music Imprimerie, 252 Rue du Faubourg Saint Honore, 75008 Paris. Tel
 (01) 563.43.70.
 Plant: 91220 Bondoufle, Zai la Mariniere, Rue G. Eiffel Tel 077 78 39

PRINTERS & LITHOGRAPHERS

A K P Mazarine, 22 Ave. du President Wilson, 94230 Cachan
 Adolar, 41 Rue Laugier, 75017 Paris Tel (01) 227.47.54, 267.22.11
 Amphion, 12 Rue Rougemont, 75009 Paris Tel (01) 246.24.97
 C N A I Fidsound (Compagnie Nationale d'Applications Ind'elles), 19 Rue
 Coysvoix, 75018 Paris. Tel: (01) 228.05.91, 229.24.61 Pres & Dir Gen.
 Jean-Claude Thuel-Chassaingne
 Chaumes, 10 Rue du Dr. Lebel, 94300 Vincennes.
 Clementine Music, 14 bis Av. de l'Abbeville, 94810 Vallangouard Tel
 466.53.26. Gen. Mgr. Michel Vassiliu.
 Dillard & Cie, 47.49 Rue Polonceau, 75018 Paris Tel (01) 255.43.21
 Telex: 650123 Dir.: Jean-Pierre Dillard; Sales Mgr.: Jean-Marc Delaye
 Dorel (Les Procédes), 45 Rue de Tocqueville, 75017 Paris Tel (01)
 227.70.50.
 Fiesta, 30 Rue du Dr Finlay, 75015 Paris Tel (01) 578 15 18/24 75 Con
 tacts: Marie & Patrick Chevalier
 Fleche (Disques), 122 Blvd. Exelmans, 75016 Paris Tel (01) 525 20 73
 Gen. Mgr. Claude Francois, Admin. Dir. Nicole Gruyer.
 France-Imprimerie (div. of AGI-Audio Graphic Inds.), 124bis Av. de Villiers,
 75017 Paris. Tel (01) 380 65.70. Telex 290833. Gen. Mgr. Jean Berge,
 Sales Mgr. Philippe Berge; Technical Mgr. Mr. Cournaud.
Branch: 28260 Anet, Boite Postale 32, 28520 Sorel Mousseil.
 Glory Impression Cartonage, 7 Rue Louis Armand, 92602 Asnieres Tel
 790.62.31 Telex 630110 Pres. Dir. Gen. Marcel Glorieux, Technical Mgr.
 Jacques Lesueur; Sales Mgr. Frederic Bussiére
 Graphicolor, 24 Rue Thomas-Lemaitre, 92000 Nanterre Tel 204.74.50.
 Grenouilleau-Landais & Les Fils, 18 Rue Dom.-Devenne, 33000 Bordeaux.
 Tel (56) 91 49 56
 I M C1, 122 bis Rue Aristide-Briand, 92300 Levallois Perret Tel 737 69 08
 Alan Grima, 31460 Loubens. Tel: (1661) 83 12 55
 Imprimerie de Saint-Michel, 21 Des Granges, 87240 Ambazac. Tel (55)
 56 63 25
 Imprimerie du Nord, 79 Rue du General Leclerc, 78400 Chateau Tel
 071 38.80 Telex 696040 Dir. Jean Robinet, Gen. Mgr. Norman J. Gar
 rod.
 Imprimerie SaintRoch, 144 Rue du Chemin Vert, 75011 Paris Tel (01)
 805.21.98.
 International Shows, 10 Rue Damremont, 75018 Paris Tel (01) 606 88 35
 Iris Television, 9 bis Rue Du Commandant Pilot, 92200 Neuilly Sur Seine.
 Tel (1) 624 13 10 Telex 613980
 Jat (Impremne), 20 Rue Molitor, 75016 Paris. Tel: (01) 651.62.90
 Levain (Eds.), 1 Rue de l'Abbe-Gregoire, 75006 Paris Tel (01) 222 15 84
 M K, 44 Rue Etienne Marcel, 75002 Paris. Tel: 233.07.30. Pres. & Gen. Mgr.:
 Monique Knuchel
 M P O Disques, Rue J. Doitteau, 53700 Villaines la Juhel Tel. 16.43.03.27 /
 35 Pres. Dir. Gen. Pierre de Poix, Sales Mgr. Monique de Poix
 Montreuil Offset, 50 Rue Voltaire, 93100 Montreuil Tel: 374.46.39. Pres. &
 Dir. Gen. Roger Mandin, Gen. Mgr. Maurice Delaunay
 Mood Duplication, RN 307, 78810 Feucherolles. Tel (03) 056.31.08. Telex
 698940. Pres. M. Miller, Sales Mgrs P. Campiot, H. Louchet
 Music Imprimerie, 252 Rue du Faubourg Saint-Honore, 75008 Paris. Tel
 (01) 563.43.70
 Plant: 91220 Bondoufle, Zai la Mariniere, Rue G. Eiffel Tel 077 78 39
 Offset Press, 9 Rue Edouard Renault, 93000 Le Blanc-Mesnil Tel (01)
 931 16.82 Telex 641431. Chief Exec.: Yves Volant; Gen. Mgr. Guy Vo
 lant.
 Photochromie, (La) 79 Av. Raspail, 94250 Gentilly Tel 588.70.71
 Publ. GD, 62 Mail des Charmilles, 10000 Troyes Tel (25) 81.05.62 Gen
 Mgr. S. Delforge
 Resonances, 162 Rue du Faubourg Saint-Denis, 75010 Paris Tel (01)
 607 48 11
 Rojo, 19 bis Allée des Sansonnets, 93320 Pavillon-sous-Bois Tel 738 53 79
 Ricland, 82 Rue de Faubourg-St Martin, 75010 Paris Tel (01) 208.76.83
 Soder, 35 Rue Rene Leynaud, 69000 Lyon Tel (78) 27.30.04
 Studio 92, 3 & 5 Rue Soffierno, 92100 Boulogne Tel 608.03.11
 Studio 621, 31460 Loubens Lauragears. Tel: (1661) 83.12.55
 Verdier (Les Ateliers), 142 Rue de Clichancourt, 75018 Paris Tel (01)
 606.53.97, 606.54.48.
 Vogue MPP (Manufacture de Prod'ns Photographiques), 82 Rue Maurice
 Grandcoing, 93430 Villetaneuse. Tel (01) 826.55.00. Cable VOGDISC.
 Telex 620380
 Voixgrave, 18 Rue Pigalle, 75009 Paris Tel (01) 526.25.93, 874.25.73.

TAPE, CUSTOM DUPLICATORS

The Audio & Video lines indicate which configurations the firms duplicate.
 Companies which offer packaging & labeling services for tape product are
 indicated by: "PKC" which appears after the main body of their listings.
 Audio Magnetics France, 129 Av. Charles de Gaulle, 92200 Neuilly. Tel: (01)
 745.62.62. Telex: 611698. Gen. Mgr.: J. Arrighi de Casanova
Audio & Video.
 B A S F (Compagnie Francaise), 140 Rue Jules Guesde, 92303 Levallois Tel
 739.33.22. Telex 620445. Comm'l Dir.: Robert Kaplan.
Audio: Cassette & open reel
 C I D I S (Polygram Inds. & Messageries), Av. Maurice Ravet, 92160 Antony.
 Tel: (19) 666.21.02. Pres & Dir. Edmond Lang; Sec'y Gen.: Bruno
 D'Orgeval; Int'l Dir. Fernand Pasquier; Comm'l Dir. Jean-Michel Allays;
 Dist'n Dir. Christian March; Factory Dir. Pierre Crapard.
Audio: Cassette.
 C N A I Fidsound (Compagnie Nationale d'Applications Ind'elles), 19 Rue
 Coysvoix, 75018 Paris. Tel: (01) 228.05.91, 229.24.61 Pres & Dir. Gen.:
 Jean-Claude Thuel-Chassaingne
**Audio: 8-tr., 8-tr. quadraphonic, cassette, open reel & open reel quadra
 phonic.**
 Context, 30 Rue de Citeaux, 75012 Paris. Tel (01) 345.73.30, 344.62.25.
 Dir. Gen.: Philippe Doitteau
Audio: 8-tr., 8-tr. quadraphonic, cassette & open reel

A/V/T-64

Disco-France (div. of AGI-Audio Graphic Inds.), Sono Tape Dept., 124 bis
 Av. de Villiers, 75017 Paris Tel (01) 380 65 70 Telex 290833 Gen
 Mgr. Jean Berge
Branch: 28260 Anet, Usine de Saussay
 E D S, 16 Rue Guy Lussac, 94430 Chennevières sur Marne. Tel: 594 21 42
 Dir. J M Simon; Technical Mgr. M Girardot
Audio: Cassette
 Fiesta, 30 Rue du Dr Finlay, 75015 Paris Tel (01) 578 15 18/24 75 Con
 tacts: Marie & Patrick Chevalier
Audio: Cassette
Video: 4" U-matic, 1/2" VHS cassette
 Hi-Fi Diffusion, 19 Rue Tonduti de l'Escarene 06000 Nice Tel (93)
 80 50 50
Audio: Cassette
Video: 4" U-matic, 1/2" Beta & VHS
 Iris Television, 9 bis Rue Du Commandant Pilot, 92200 Neuilly Sur Seine
 Tel (1) 624 13 10 Telex 613980 (PKC)
Video: 1" helical, 4" U-matic, 1/2" Beta VHS & SVR
 Michel Laguens Org., 47 Av. Paul Doumer, 75016 Paris Tel (01) 520 37 53
 Telex 611650 Pres. Michel Laguens, Gen. Mgr. Monique Dupuy, Sales
 Mgr. Francoise Maderon
 M P O Disques, Rue J. Doitteau, 53700 Villaines la Juhel Tel. 16.43.03.27 /
 35 Pres. Dir. Gen. Pierre de Poix, Sales Mgr. Monique de Poix
Audio: 8-tr., 8-tr. quadraphonic, cassette.
 Malfroy, 7 Rue Saint-Vincent, 40103 Dax Cedex Tel (58) 74.65.69 Owner
 Dominique Malfroy
 Michel Meyer & Cie, 8 Rue de l'Est, 92100 Boulogne Tel (01) 605 43.27
 Telex 201336 Chief Exec. Michel Meyer; Gen. Mgr. Philippe Ternier
 (PKC)
Audio: 8 tr., cassette, open reel
Video: 1" helical open reel
 Mood Duplication, RN 307, 78810 Feucherolles Tel (03) 056.31.08 Telex
 698940 Pres. M. Miller, Sales Mgrs P. Campiot H. Louchet
Audio: Cassette, open reel
 Morning Star, 53 Rue du Faubourg St Antoine, 75011 Paris Tel (01)
 346.67.89
 Multi Techniques, 55 bis Rue de Ponthieu, 75008 Paris Tel (01)
 359.25.14 Telex. 650411
Audio: Cassette open reel
 Pathe Marconi EMI, 36 Rue Pierret, 92200 Neuilly Sur Seine Tel
 758 12 48 Telex 613550 Pres. Alain Gerondeau
 Factory: 78400 Chateau, 2 Rue Emile Pathe Tel 071.92.00. Telex
 696768
 Polysonor, 92 Rue de la Pompe, 75116 Paris. Tel (01) 553 47.15 Gen.
 Mgr. Mr. Moureaux Nery
Audio: Cassette, open reel
 Satav Satrape, 44 Rue Pierre Joseph Proudhon, 78800 Houilles Tel (03)
 968.60.95 Telex. 698618
Audio: Cassette, open reel
 Sema, BP 232, 03208 Vichy Cedex Tel (70) 32.08.41
 Societe Francaise de Prod'n, 36 Rue des Alouettes, 75019 Paris Tel (01)
 203.99.04 Telex 240888
Video: Cassette (all formats)
 Stereophonic, 9 Rue Pestalozzi, 75005 Paris Tel (01) 331.08.35.
 010 45 79 Chief Exec. Roger Delongas
Audio: Cassette, open reel
 Studio Hirigoyen Mariarena, Villefranche, 64100 Bayonne Tel (59)
 25 52 50
 Sysmo Recs., 136 Rue Championnet, 75018 Paris Tel (01) 255.64.62
 Tomphorator, 72 Av. du Gal-Leclerc, 75014 Paris
 V D M (Video Duplication Maintenance), 33 Rue des Poissonniers, 92200
 Neuilly sur Seine Tel 745-6667 Telex 612367 Dir. Gen. J B Fetoux
 (Video only)
 Vogue MPP (Manufacture de Prod'ns Photographiques), 82 Rue Maurice
 Grandcoing, 93430 Villetaneuse. Tel 826 55 00 Cable VOGDISC Paris
 Telex 620380
Audio: 8-tr., cassette
 Voixgrave, 18 Rue Pigalle, 75009 Paris Tel (01) 526.25.93, 874.25.73
 (PKC)
Audio: 8-tr., cassette, open reel

• supplies

CARTRIDGE & CASSETTE PARTS

B A S F (Compagnie Francaise), 140 Rue Jules Guesde, 92303 Levallois Tel
 739.33.22 Telex 620445 Comm'l Dir. Robert Kaplan
 C N A I Fidsound (Compagnie Nationale d'Applications Ind'elles), 19 Rue
 Coysvoix, 75018 Paris Tel (01) 228.05.91, 229.24.61 Pres & Dir Gen.
 Jean-Claude Thuel-Chassaingne
 Greencorp Magnetics, 16 Rue Ficatier, 92400 Courbevoie Tel (01)
 333 27 40 Telex 613188 European Sales Mgr. F G Kinney
 Publisound Audio Professional, 7-9 Rue Crespin du Gast, 75011 Paris. Tel (01)
 357 64 07 Dir. Peter Dean; Gen. Mgr. Dany Dean
 Rhone Poulenc Systems, 47 Rue de l'Echat, 94000 Creteil Tel 207 48 90
 Telex: 230742 Chm. & Mgr. Michel Fromont; Dept. Mgr. Christian Yves
 Nomicisio, Int'l Mgr. Louis Delaister

EMPTY CARTRIDGES, CASSETTES & REELS

Agfa-Gevaert, 274 Av. Napoleon Bonaparte, 92500 Rueil Malmaison Tel
 732.02.60 Cable AGFACEVA Telex 203374.
Audio: Reels
 B A S F (Compagnie Francaise), 140 Rue Jules Guesde, 92303 Levallois Tel
 739.33.22 Telex 620445 Comm'l Dir. Robert Kaplan
 C N A I Fidsound (Compagnie Nationale d'Applications Ind'elles), 19 Rue
 Coysvoix, 75018 Paris. Tel: (01) 228.05.91, 229.24.61 Pres & Dir. Gen.
 Jean-Claude Thuel-Chassaingne
 Disco France (div. of AGI-Audio Graphic Inds.) Sono Tape Dept. 124bis Av
 de Villiers, 75017 Paris Tel (01) 380.65.70. Telex 290833 Gen. Mgr.
 Jean Berge
Branch: 28260 Anet, Usine de Saussay.
 Greencorp Magnetics, 16 Rue Ficatier, 92400 Courbevoie Tel (01)
 333 27 40 Telex 613188 European Sales Mgr. F G Kinney
Audio: 8-tr., cassette, open reel
 M P O Disques, Rue J. Doitteau, 53700 Villaines la Juhel Tel: 16.43.03.27 /
 35 Pres. Dir. Gen. Pierre de Poix, Sales Mgr. Monique de Poix
 Ma Co Sarl, 10 Rue Malakoff, 92600 Asnieres Tel 793.37.83 Gen. Mgr.
 Ms. Benard
Audio: Cartridges
 Rhone Poulenc Systems, 47 Rue de l'Echat 94000 Creteil Tel 207 48 90
 Telex 230742 Chm & Mgr. Michel Fromont, Dept. Mgr. Christian Yves
 Nomicisio, Int'l Mgr. Louis Delaister (Audio only)
Brand name: Pylal

PROFESSIONAL TAPE SUPPLIES

Agfa-Gevaert, 274 Av. Napoleon Bonaparte, 92500 Rueil Malmaison. Tel
 732 02 60 Cable AGFACEVA Telex 203374
**Audio: Calibration tapes, splicing & leader tapes, storage & shipping
 cases, NAB & CCIR hubs**

TAPE, RAW & BLANK LOADED

Agfa-Gevaert, 274 Av. Napoleon Bonaparte, 92500 Rueil Malmaison. Tel
 732 02 60 Cable AGFACEVA Telex 203374
Audio: Raw—2", 1", 1/2" & 1/4" open reel, blank—cassette
**Video: Blank—2", 1", 1/2" U-matic, 1/2" Beta, VHS, SV & Video 2000
 cassette**
 Ampex SA, 17 23 Rue du Dome, 92100 Boulogne Tel 609.91.55 Telex
 250025
Audio: 2", 1", cassette, open reel
Video: 2", 1", 1/2", 1/4" Beta & VHS
 Audio Magnetics France, 129 Av. Charles de Gaulle, 92200 Neuilly Tel (01)
 745.62.62 Telex 611698 Gen. Mgr. J. Arrighi de Casanova
 Audio Plus, 20 Av. D'Ivry, 75013 Paris Tel (01) 585.15.99 Telex 201197
 (Raw only)
Audio: Cassette.
Brand name: Domain Magnetics.
 B A S F (Compagnie Francaise), 140 Rue Jules Guesde, 92300 Levallois Tel
 (01) 739.33.22 Audio/Video Mgr. Robert Kaplan, Sales Mgr. Pierre
 Genouen.
Audio: Cassette, open reel
Video: 1" open reel, 1/2" cassette, 1/2" EIAJ open reel, 1/2" EIAJ cartridge
 C N A I Fidsound (Compagnie Nationale d'Applications Ind'elles), 19 Rue
 Coysvoix, 75018 Paris. Tel (01) 228.05.91, 229.24.61. Pres. & Dir. Gen.
 Jean-Claude Thuel-Chassaingne
Audio: 8 tr., cassette, open reel.
 Domain Magnetics, see Audio Plus
 Greencorp Magnetics, 16 Rue Ficatier, 92400 Courbevoie. Tel (01)
 333 27 40. Telex 613188 European Sales Mgr. F G Kinney
Audio: 8-tr., cassette, open reel.
Video: 1/2" EIAJ open reel, 1/2" cassette
Brand names: G-tape, Greencorp, Opus.
 J V C Video France, 138 Av. du President Pompidou, Rueil-Malmaison Tel
 (01) 708.92.12 Telex 203627 (Blank only)
Audio: Cassette (120)
Video: 4" U-matic cassette, 1/2" VHS cassette
 M F P-E M I see Music for Pleasure
 M P O Disques, Rue J. Doitteau, 53700 Villaines la Juhel Tel. 16.43.03.27 /
 35. Pres. Dir. Gen. Pierre de Poix; Sales Mgr. Monique de Poix (Blank
 only)
Audio: 8-tr., cassette
 Magnex, see Sonofradis
 Mood Duplication, RN 307, 78810 Feucherolles Tel (03) 056.31.08 Telex:
 698940 Pres. M. Miller Sales Mgrs P. Campiot, H. Louchet (Blank
 only)
Audio: Cassette, open reel
 Music for Pleasure, 57 Blvd de la Republique, 78400 Chateau Tel: (03)
 071 30 79 Telex 698730 Gen. Mgr. Alain Gerondeau, Sales Mgr. G.
 Durampart, Finance & Admin. M.J. Brown
Audio: Cassette
Brand name: MFP EMI.
 Pathe Marconi EMI, 36 Rue Pierret, 92200 Neuilly Sur Seine Tel (01)
 758 12 48. Telex: 613550. Pres. Alain Gerondeau
 Factory: 78400 Chateau, 2 Rue Emile Pathe Tel 071.92.00 Telex
 696768
Audio: Cassette, open reel
 Publisound Audio Professional, 7-9 Rue Crespin du Gast, 75011 Paris. Tel (01)
 357 64 07 Dir. Peter Dean. Gen. Mgr. Dany Dean
Audio: 8-tr., open reel
Video: Blank—1" open reel, 1/2" EIAJ open reel
Brand names: Pylal, 3M
 Pylal, see Rhone Poulenc.
 Rhone Poulenc Systems, 47 Rue de l'Echat, 94000 Creteil Tel 207 48 90
 Telex 230742 Chm & Mgr. Michel Fromont, Dept. Mgr. Christian Yves
 Nomicisio, Int'l Mgr. Louis Delaister.
Audio: Cassette & open reel.
Brand name: Pylal
 Sonofradis, 61 Rue de Ponthieu, 75008 Paris Tel (01) 359.15.18 Mng
 Dir. Jean Claude Ravier
Audio: Blank—cassette.
Brand name: Magnex

TAPE DUPLICATING & PROCESSING EQUIPMENT

Audio Plus, 20 Av. D'Ivry, 75013 Paris Tel (01) 585.15.99 Telex: 201197
 Product: Duplicators
Brand names: MTI, Telex
 B A S F (Compagnie Francaise), 140 Rue Jules Guesde, 92303 Levallois. Tel
 739.33.22. Telex 620445 Comm'l Dir. Robert Kaplan.
 C N A I Fidsound (Compagnie Nationale d'Applications Ind'elles), 19 Rue
 Coysvoix, 75018 Paris. Tel: (01) 228.05.91, 229.24.61 Pres. & Dir.
 Gen. Jean-Claude Thuel-Chassaingne

• accessories

Ampex SA, 1723 Rue du Dome, 92100 Boulogne Tel 609.91.55. Telex
 250025
 Product: Tape—carrying & storage cases, head cleaners, bulk erasers, de
 magnetizers, leader tape, splicing tape & equip. (all audio & video).
 Audio Plus, 20 Av. D'Ivry, 75013 Paris. Tel (01) 585.15.99. Telex. 201197.
 Product: Tape—splicing blocks & tape (audio) (Brady, X-edit), head
 cleaning tape (TapeMasters)
 B A S F (Compagnie Francaise), 140 Rue Jules Guesde, 92303 Levallois. Tel
 739.33.22 Telex 620445 Comm'l Dir. Robert Kaplan
 Product: Tape—leader & splicing tape
 Delta Magnetics, 41 Quai des Martyres de la Resistance, 78700 Conflans
 Tel 972.69.81.
 Product: Record—replacement styli (Stanton)
 Greencorp Magnetics, 16 Rue Ficatier, 92400 Courbevoie Tel (01)
 333 27 40 Telex 613188 European Sales Mgr. F G Kinney
 Product: Record—carrying & storage cases, record care prods., 45 rpm
 adaptors, Tape—head cleaners, demagnetizers, leader & splicing tape
 Impregna Sarl, 167 Rt. de St. Leu, Epinay Sur Seine Tel (01) 822.64.32
 Contact Jacques Fallard
 Product: Record—record care prods. (anti-static record cleaning mate
 rial)
 Denis Lavaine (Ets.), 62 Rue des Deportes, 45200 Montargis. Tel (38)
 85.24.17
 Product: Record—record care prods.

Ma-Co Sarl, 10 Rue Malakoff, 92600 Asmeres Tel 793 37 83 Gen Mgr Ms. Benadon
Product: Record—record care prods., 45 rpm adaptors, replacement styl, Tape—head cleaners & demagnetizers
 Mageco Electronic, 117 Rue d'Aguesseau, 92100 Boulogne Tel (01) 604.81.90. Telex: 206261.
Product: Record—record care prods., replacement styl (Pickering)
 Publisson Audio Professional, 7-9 Rue Crespin du Gast, 75011 Paris Tel: (01) 357.64.07. Dir.: Peter Dean; Gen. Mgr.: Dany Dean.
Product: Record—carrying & storage cases, Tape—carrying & storage cases, head cleaners, demagnetizers, leader & splicing tape
 Sofradim Rexon, 82 Rue Baudin, 92300 Levallois Perret Tel (01) 270.12.24/91 81. Chief Exec. Michel Marcot, Gen. Mgr. Francois Marcot.
Product: Record—carrying & storage, record care prods., replacement styl; Tape—carrying & storage cases, head cleaners, demagnetizers, leader & splicing tape
 Topods, Le Petit Parc, Zone Industrielle, 78920 Equeville Tel: 475.50 21 Telex. 698074. Gen Mgr. Andre Gervy
Product: Record—carrying & storage cases, record care prods., 45 rpm adaptors, Tape—carrying & storage cases (video), head cleaners, demagnetizers
 Vogue MPP (Manufacture de Prod'ns Phonographiques) 82 Rue Maurice Grandcong, 93430 Villetteuse. Tel: (01) 826.55.00. Cable. VODGISC. Telex. 620380
Product: Record—45 rpm adaptors.

• store fixtures

Etalage SA, Rue Salvador Allende, Zone Industrielle, 91120 Palaiseau, Tel (03) 011 53 20. Dir. T.G. Jamison; Sales Mgr. AW Jamison
Product: "Anti-theft" cassette racks (Focus)
 Glory Impression Cartonage, 7 Rue Louis Armand, 92602 Asmeres Tel: 790.62.31. Telex: 630110 Pres. & Dir Gen. Marcel Glory, Technical Mgr.: Jacques Lesueur; Sales Mgr.: Frederic Bussiere.
Product: Record browser boxes & divider cards
 Greencorp Magnetics, 16 Rue Fratcher, 92400 Courbevoie. Tel. (01) 333.27.40. Telex 613188 European Sales Mgr F G Kinney
Product: Divider cards.
 Topods, Le Petit Parc, Zone Industrielle, 78920 Equeville Tel: 475.50 21. Telex. 698074 Gen. Mgr Andre Gervy
Product: Record & tape browser boxes display racks, divider cards.
 Video Diffusion Int'l, 9 Rue des Bons Enfants, 75001 Paris Tel (01) 261.43.85. Telex: 200695.
Product: Videotape security systems.

• independent video producers

The following is a list of Video Production companies that are involved in the production and recording of video for concerts, record/artist promos and other music related projects. Facilities, equipment, and services listed are intended as a brief description only and may not necessarily reflect a particular company's full capabilities.

Arabvision 78 Rue Joffroy, 75017 Paris Tel 266 34 27 Telex: 640173
 Owners & Prod'rs: R El Chamah, A. Ghandour
Formats: 1/2" Beta & VHS
Facilities: studio—none, mobile/portable— Ikegami & RCA TK 76B cams, 1 2" AVR2 VTR; 2 Sony BVH 1" VTR's; post-prod'n—Grass Valley switcher, Cox mixer
 C I P Video, Palais des Congres, Porte Maillot, 75017 Paris Tel (01) 758 25 04 Telex. 660235 Owner Mr Bessonnet (Note Classical music only)
Formats: 2", 1" (PAL or SECAM modes)
Facilities: studio—2 studios (300 sq. metres, 80 sq metres), mobile/portable—arranged through Paris France Video (see listing), post-prod'n—none
 Costa & Renduf, 58 Rue Charlot, 75003 Paris. Tel: 277 73 10 Telex: 212164 Owners: D Costa, Daniel Renduf. Prod'r: Daniel Renduf
Formats: 2", 1"
Facilities: mobile/portable—1/2" Sony BVU VCR & cam
 Entregistement Personnalise Video, 1 Rue Foutat, 75002 Paris Tel. (01) 261 80 58.
Format: 1/2"
Facilities: mobile/portable—TV reporting of any type, post-prod'n—duplication
 Paris France Video, 75 Blvd. Gouvanst St Cyr, 75017 Paris Mgr M Rignault.
Facilities: mobile/portable—mobile unit
 Unites Mobiles de Television (UMT), 8 Blvd de l'Hospital, 75005 Paris Tel: 707.07.20 Owner & Prod'r Jean Senet
Formats: 1", 1/2", 1/4", 1/8" Beta & VHS
Facilities: studio—1 studio equipped with Chroma key, mobile/portable—ENG-EFP package w/1 cam, van equipped for 2 or 3 cams is available, post-prod'n—Cox mixer, SqueezeZoom effects
 V C I (Video Centre Int'l), see VTF
 V T F (Video Tele France)/VCI (Video Centre Int'l), 13 Rue Beethoven, 75016 Paris. Tel: (01) 524 43 13 Telex 612147, 630487 Contacts Guy Job, Remy Bommelera.
Formats: 2", 1", 1/2", 1/4", 1/8" Beta & VHS
Facilities: studio—3 studios (600 sq. metres, 400 sq metres & 300 sq metres), RCA cams (4-TK 47's, 8-TK-760's, 3-TK 76's), 1 RCA TR-600 2" VTR; 7 1" VTR's (1 Bosch Fernseh BCN 50, 3-Bosch-Fernseh BCN-20's, 2 Ampex VPR-2's; 1 Ampex VPR-20, 3 Sony 1/2" U matic VCR's, mobile/portable—3 single-cam mobile units, 1 double cam mobile unit, post-prod'n—1 Grass Valley switcher w/digital effects; 1 Studer 24-tr. audio recorder; 1 Studer 10-tr recorder, 1 Schlumberger 8 channel mixer, 2 Thomson-CSF Vidifont video synthesizers, Elektronix monitoring system, 4 "on-line" editing rooms, sub titling equip., dubbing, full telecine; other—standards conversion PAL to SECAM or NTSC to PAL or SECAM; videocassette duplication.

• playback/recording equipment

Ampex Sarl, 21 Rue du Dome, 92100 Boulogne Tel (01) 609 91 55 Telex: 250025 Cable VIDEETAPE PARIS
 Comel, 6 Rue Rossignol Dubost, F-92230 Genevilliers, Tel 793.65.12. Telex 630504 Pres Gerard Mori, Sales Mgr Michel Barbier-Lambert, Adv. Mgr. Yannick Chalony. (Audio only)
 Dual, 16 Ave. du Vert Gallant, 95310 Saint Quen l'Aumone Tel 037 40 21 Telex 695761 (Audio only)

Eneretec, PO Box 226, 296 Av. Napoleon Bonaparte, 92503 Rueil Malmaison Cedex Tel: (01) 732 92.23 Telex 203404. Mng. Dir R Senechal; Sales Dir J Schwoeb; Adv Mgr J L Monorville
 Harman-France, BP 135, 94120 Fontenay sous Bois. Tel: (01) 876-11 44. Telex 680780 Dir Jean Paloque. Sales Mgr Roy Christian
Audio: Tascam, Teac (Japan).
 Industrial Tape Applications, 2 Rue des Tennerolles, Paris Chief Exec - P Depierre. (Audio only)
Home office: England
 International Video Corp, 61-63 Rue des Entrepreneurs, F 75015 Paris Tel (01) 579 49 14. Cable: INTERVIDED. Telex: 270477. (Video only)
 J V C Video France SA, 138 Ave du President Pompidou, Rueil-Malmaison Tel (01) 708.92.12. Telex: 203627.
 Mageco Electronic, 117 Rue d' Aguesseau, 92100 Boulogne Tel (01) 604.81.90. Telex: 206261.
Audio: Aiwa (Japan)
 Maffroy, 7 Rue Saint-Vincent, 40103 Dax Cedex. Tel (58) 74.65 69. Dwner Dominique Maffroy
Audio: Brenell (UK), Neal Ferroglyph (UK)
 Mazzanti SA, 26 Rue de Paris, 92100 Boulogne Tel 603.76.23. Dir.: Pierre Mazzanti; Tech. Video M Gellifon (Video only)
 Mediavideo SARL/DA, 135 Ave. de Wagram, 75017 Paris Tel 763.11.33. Dir's J E. Tazartes, Henri Griebbaum
 Nakamichi, see Schaeffer-Riesser.
 Dian, see Reditec.
 Philips SA, Ste. Portenseigne, 50 Rue Roger Salengro, Peripole 14, 94126 Fontenay-Sous-Bois Cedex Tel 876.11 33 Telex 280746 (Audio & Video)
Realistic: see Tandy
 Reditec, 62-66 Rue Louis Ampere, ZI des Chanoux, 93330 Neuilly Sur Marne. Tel: 300.96.30. Telex: 240779.
Audio: Dtari (Japan)
 Revox, see Schaeffer-Riesser
 S D R M Thomson, 67 Quai Paul Doumer, 92400 Courbevoie Tel 788 23 33 Telex 620343 (Video only)
 Schaeffer, Riesser & Co., 14 bis Rue Marbeuf, 75008 Paris Tel (01) 225 00.24. Pres. E Riesser
Audio: Nakamichi (Japan), Revox.
 Simplex Electronique, 48 Blvd. Sebastopol, 75003 Paris Tel (01) 271 53.30. Telex: 230045 Cable SIMETRO.
Audio: Telefunken (Germany)
 Sonetec SA, 21 Ave. du Fort, 92120 Montrouge. Tel 654.07.07 Telex 202347 Dir Jack Magrod (Audio only)
 Sony France SA, 19-21 Rue Madame de Sanzillon, 92111 Cluchy Tel 739 32 06 Telex 620674 (Video only)
 Studer France, 12/14 Rue Desnouettes, 75015 Paris Tel. (01) 533.58.58 Telex 204744 Mng Dir.: D. Mikoska. (Audio only)
 Surmelec Continental Edison, 74 Rue du Surmelin, 75980 Paris Cedex 20 Tel: (01) 360.02.42. Telex 211505 Sales Dir: Jean Pierre Lochereau.
 Tandy Int'l Electronics, 162 Av de Dunkerque, 59000 Lille
Audio: Realistic (USA)
 Tascam see Harman France
 Teac, see Harman-France.
 Techni-Video, 64 bis Blvd. Jean Jaures, 93402 Saint Duen Tel 257 11 30 Telex: 650959 (Video only)
 Telefunken, see Simplex.
 3 A Dist'n, 107 bis Rue des Poissonniers, 75018 Paris Tel (01) 606.86.57, 255 48 30 Dir Alan Chardon (Video only)
 3 M France, 135 Blvd Serurier, 75010 Paris. Tel (01) 202.80.80. (Audio only)
 Video Diffusion Int'l, 9 Rue des Bons Enfants, 75001 Paris Tel (01) 261 43.85. Telex: 200695
Video: JVC (Japan)

PRINTERS & LITHOGRAPHERS

Alcophon Albinger KG, Duenebergerstr 111-113, D-2054 Geesthacht Tel (4152) 4031 Telex 218707. Pres Rolf Albinger, Gen Mgr Manfred von Mangoldt; Plant Mgr.: Hilmar Kumbartzky.
 Amerindian, An Der Alte Muehle 9, D-5067 Wesseling-Berzdorf Tel: (02232) 51780. Chief Exec.: Ingrid Renate Roehre
 Attacca Musikverlag, Dr. Hammacherstr 3, D-4100 Duisburg-Ruhrort. Tel: (02131) 8-13-78.
 Blubber Lips Verlags GmbH, Buergerstr 14, D-6900 Heidelberg 1 Tel: (06221) 78 10-49. Telex (04) 61538 Gen. Mgr.: Ruediger Eggert.
 Cosmic News GmbH, PO Box 850227, D 5000 Cologne 80. Tel: (0221) 68-25 74 Telex (08) 873445 Pres. Rolf Ulrich Kaiser
Branch: D-1000 Berlin 31, Wittelsbacherstr 18
 Druck-Verlag-Werbung, Freiburgerstr. 21, D-6900 Heidelberg 1. Tel: (06221) 3-37-79. Telex. 461538.
 I D S (International Disc Serv.), PO Box 140105, D-8500 Nuernberg 14 Gen. Mgr. Hans-Joachim Rabe; Sales Mgr. W. Ruff.
 Hans Sikorski (Int'l Musikverlage), Johnsallee 23, D-2000 Hamburg 13. Tel (040) 44-62-45 Telex (02) 11027 Co Pres. Dr. Hans & Hanna Sikorski.
 Sonopress Gesellschaft fuer Tontraegerherstellung mbH, Carl Bertelsmannstr. 161, D-4830 Guetersloh 1 Tel: (05241) 801. Cable. SDNDPRESS Telex 933822. Gen Mgr. Dr Uwe Swientek, Sales Mgr. Heinz Kirchberg.
 Tempo (Schallplatten Vertrieb) Meissner & Co., Rotwandstr 16, D-8023 Pfullach-Grosshesselohe. Tel: (089) 79-42-86. Telex (05) 212035. Mng Dir. Kurt Messner
 Tonomatic Tontraeger GmbH, Schwabelstr 2, D-8011 Hoehenkirchen bei Munchen Tel (08102) 81 36. Chief Exec.: Johann Winkler, Sales Mgr. Margarethe Winkler
 The Wurzbürger Music Publ'g Co., Nord-Str-Ring 11, D-7024 Filderstadt/Bernhausen 1 in Tel (0711) 70 27-49 Dir Luciano Wurzbürger; Gen. Mgr Jack Cunningham

TAPE CUSTOM DUPLICATORS

TAPE PACKAGING & LABELING

The Audio and Video lines indicate the configurations which the firms duplicate. Companies which offer packaging and labeling of tape product are indicated by "PKG" which appears after the main body of their respective listings.

Alcophon Albinger KG, Duenebergerstr 111-113, D-2054 Geesthacht Tel (4152) 4031 Telex 218707 Pres Rolf Albinger; Gen Mgr Manfred von Mangoldt; Plant Mgr.: Hilmar Kumbartzky. (PKG)
Audio: Cassette
 Amerindian, An Der Alte Muehle 9, D-5067 Wesseling-Berzdorf. Tel: (02232) 51780 Chief Exec Ingrid Renate Roehre
Audio: Cassette, open reel.
 Attacca Musikverlag, Dr. Hammacherstr 3, D-4100 Duisburg-Ruhrort. Tel (02131) 8 13 78
 Auvis-Asona KG, Stollbergstr 7, D 8000 Munich Tel (089) 22-50-57 Cable ASDNA. Telex: (05) 22084 Dir Alf Kuerzeder
Audio: Cassette, open reel.
 Bauer GmbH & Co KG (Tonstudio), Markgroeningerstr 46, D-7140 Ludwigsburg-Eglosheim 10. Tel (07141) 3 10-97 Telex (07) 264806. Mng Dir Rolf Bauer
Audio: Cassette, open reel.
 Bellaphon Recs GmbH & Co KG, Mainzer Landstr 87-89, D-6000 Frankfurt Tel (0611) 23-08 01. Telex (04) 16046 Pres. Branko Zvanovic. (PKG)
Audio: Cassette.
 Casselton GmbH, Sudetenstr 73, D-8192 Geretsried 2 Tel: (08171) 30-31 3031 33. Telex: (05) 26331. Gen Mgr Stan Zoraatek; Sales Mgr. Horst Piskowski.
Audio: Cassette.
Video: 1/2" Beta & VHS cassette
 Delta Music GmbH, Zur Muehle 2, D-5020 Frechen 4 Tel: (02234) 61015. Cable: DEMUS. Telex: (08) 89299. Pres Dr K.J. Molf; Gen. Mgr P.H. Sautot, Sales Mgr Dr W Ammel
Audio: Cassette
 Eurocassette, Mehringdamm 32/34, D-1000 Berlin 61 Tel: (030) 251-0331 Telex (01) 83366 Chief Exec. Guenter A. Kuefer; Chief Eng., Klaus Mack
Audio: 8-tr. cassette.
Video: 2" & 1" open reel, 1/2" cassette, 1/4" Beta, VHS & V-2000 cassette, 1/4" EIAJ cartridge, LVC, SVR
 I D S (International Disc Serv.), PD Box 140105, D-8500 Nuernberg 14 Gen. Mgr Hans-Joachim Rabe, Sales Mgr. W. Ruff (PKG only)
 I T P Tonband Produktions KG, Riwo Verwaltungen GmbH & Co., Ballinstr. 16 18, D 1000 Berlin 47 Tel (030) 684 80-69 Cable 185320. Gen Mgr Karl Blatz, Label Mgr: Jutta Buschenhagen
Audio: Cassette
 M C S Music & Cassette Supply GmbH, Lenzburgerstr. 2, D-7890 Waldshut. Tel (07751) 32 58. Gen Mgr Mario Taravella
Audio: 8 tr., 8-tr quadruphonic, cassette.
 M D R (Magnetic Disc Rec'g) GmbH Germany, PD Box 140105, D-8500 Nuernberg Tel (0911) 63 64-08, (09122) 8 64-40 Telex (06) 23987 Dir Erich Rabe, Sales Mgr M Rabe (PKG-video only)
 Magna Tontraeger Produktions GmbH, Juliusstr 10 11, D-1000 Berlin 44 Tel (030) 684-80-58. Telex: 183845. Pres. Juergen Freidank. (PKG)
Audio: Cassette
Video: 1/2" Beta & VHS cassette.
 Miller Int'l Schallplatten GmbH, Justus von Liebig Ring 2-4, D-2085 Quickborn. Tel (04106) 50-01 Cable MILIN Telex (02) 12386 Gen Mgr: Harald A. Kirsten (PKG)
Audio: Cassette
 Orchestrola GmbH, PD Box 186, Auf Dem Esch 8, D-2840 Diepholz. Tel: (05441) 2293, 1812 Cable PALAS Telex (09) 41221. Gen & Sales Mgr Rolf Neumann; Ass't: Ingeborg Grossmann.
Audio: Cassette
 Polyband Gesellschaft fuer Tontraeger mbH & Co. KG, Sonnenstr 20, D-8000 Munchen 2 in Tel (089) 59 28-21 Telex 522636 Chief Exec Wolfgang C Winkel.
Audio: Cassette open reel
Video: 1/2" cassette, 1/4" Beta & VHS cassette.
 PolyGram Rec Serv GmbH, PD Box 1409, Podbrleskrstr. 164, D-3000 Hanover 1 Tel (0511) 69-68 1 Telex 922807
 Rhenus Music Fuer Fernseh, Film & Muscproduktion mbH & Co. KG, Otto Hahnstr. D 5000 Cologne 50 Tel (0221) 38-01 47 Telex: 08881404 Gen Mgr. Karl-Heinz Muenchow
 Dietrich Scharschmidt Studioausruestung, Gernotstr 11, D-8000 Munich 40 Tel (089) 30 65 46. Cable PRDSTUDIO Pres. Dietrich Scharschmidt
Audio: Cassette, open reel

German Federal Republic (West)

• services

DESIGN & ARTWORK

Alcophon Albinger KG, Duenebergerstr 111 113, D-2054 Geesthacht Tel (4152) 4031. Telex: 218707 Pres.: Rolf Albinger; Gen Mgr. Manfred von Mangoldt; Plant Mgr.: Hilmar Kumbartzky.
 Blubber Lips Verlags GmbH, Buergerstr. 14, D-6900 Heidelberg 1. Tel (06221) 78 10-49. Telex (04) 61538. Gen Mgr Ruediger Eggert
 Cosmic News GmbH, PD Box 850227, D-5000 Cologne 80 Tel. (0221) 68-25-74 Telex (08) 873445 Pres Rolf Ulrich Kaiser
Branch: D-1000 Berlin 31, Wittelsbacherstr 18
 Druck Verlag-Werbung, Freiburgerstr 21, D-6900 Heidelberg 1 Tel (06221) 3-37 79 Telex 461538
 Dfshorse Spezialversand, Klingelhohl 35, D-5600 Wuppertal 2 Tel: (0202) 50-29 63
 Dhr Musik Produktion GmbH, PD Box 850227, D-5000 Cologne 80. Tel. (0221) 68 25 74. Telex 8873445 Pres Rolf Kaiser
 Rhein-Ruhr-Film Tonstudio, Koengsallee 124, D-4630 Bochum 1 Tel (0234) 3-78 14. Telex: (08) 25729. Chief Exec Helmut Rohlfing, Sales Mgr Erwin Erlenkaemper (Record only)
 Rocamar Music, Gardeschuetzenweg 61 63, D-1000 Berlin 45 Tel: (030) 834 5161 Chief Exec. Eckhard Meier Hardy
 Hans Sikorski (Int'l Musikverlage), Johnsallee 23, D-2000 Hamburg 13 Tel (040) 44 62 45 Telex (02) 11027 Co-Pres Dr Hans & Hanna Sikorski
 Sonopress Gesellschaft fuer Tontraegerherstellung mbH, Carl Bertelsmannstr. 161, D-4830 Guetersloh 1 Tel: (05241) 801. Cable SONDPRESS Telex 933822 Gen Mgr Dr Uwe Swientek; Sales Mgr Heinz Kirchberg.
 Sternenmaedchen (Starmaiden) Media Serv. GmbH, see Cosmic News
 Tonomatic Tontraeger GmbH, Schwabelstr 2, D-8011 Hoehenkirchen bei Munchen. Tel (08102) 81 36. Chief Exec.: Johann Winkler, Sales Mgr. Margarethe Winkler
 Heinz Ulm-Musik GmbH, Voelkstr 34, D-8900 Augsburg, Tel (0821) 51-55-55 Cable: HELMMUSIC Dir Heinz Ulm.
 Videoing GmbH, PD Box 1167, Am Scherenberg 2, D-2106 Bendestorf Tel (04183) 6035 Cable VIDEERING Telex 2189719 Dir's: Paul Woekkel, Mario Villavenceno

Arthur Shishmanian Export-Import, Boeckmanstr. 15, D-2000 Hamburg 1. Tel: (040) 24-67-74
 Sonopress Gesellschaft fuer Tontraegerherstellung mbH, Carl Bertelsmann str. 161, D-4830 Guetersloh 1. Tel: (05241) 801. Cable: SONOPRESS. Telex: 933822. Gen. Mgr.: Dr. Uwe Swientek, Sales Mgr.: Heinz Kirchberg.
Audio: Cassette.
Video: 1/2" Beta, VHS & Video 2000 cassette.
 Teldec Telefonken-Oecca Schallplatten GmbH, Heussweg 25, 0 2000 Hamburg 19. Tel: (040) 40-19-1. Mng. Oirs.: Gerhard Schulze, Kurt Richter.
 Factory: D-2353 Mörntorf/Holstein, Postfach 160, Niedenstr. 3 7 Tel: (04392) 381. Telex: 0299610. Plant Opls. Oir.: John L. Schubach; Technical Opls. Oir.: Herbert Knothe
Audio: Cassette.
 Tonomatic Tontraeger GmbH, Schwabelstr. 2, 0-8011 Hoehenkirchen bei Munich. Tel: (08102) 81.36. Chief Exec.: Johann Winkler. Sales Mgr.: Margarethe Winkler.
Audio: Cassette.
 Heinz Ufm-Musik GmbH, Voelkstr. 34, 0-8900 Augsburg. Tel: (0821) 51-55-55. Cable: HELMMUSIC. Oir.: Heinz Ufm.
Audio: Cassette.
Video: 1/2" Beta & VHS cassette.
 V & C Video & Computer GmbH, Voelkstr. 34, 0-8900 Augsburg. Tel: (0821) 51-68-68.
Video: 1/2" VHS cassette.
 Videoring GmbH, PO Box 1167, Am Schierenberg 2, 0-2106 Bendestorf Tel: (04183) 6035. Cable: VIDEOERING. Telex: 2189719. Oirs.: Paul Moeckel, Mario Villavicencio. (PKG)
Video: 2" & 1" open reel, 1/2" U-matic cassette, 1/2" Beta, VHS & V-2000 cassette.
 W. D. Warren Co. KG, Im Steingrund 5, 0-6072 Dreieich-Buchschlag Tel: (06103) 6-10-51. Cable: WAMESCO. Telex: (04) 185391. Owner: William-Oirk Warren; Exec. VP Eugene Elskens; VP Sales Helmut Rossmairer; VP & Controller: Karl Schoon.
Video: 1/2" cassette, 1/2": EIAJ open reel.

• supplies

CARTRIDGE & CASSETTE PARTS

I C M GmbH, Lenzburgerstr. 2, 0-7890 Waldshut. Tel: (7751) 3075. Telex: 792249 Pres.: Werner Weber; Mng. Oirs.: Heinz Amann, Rolf Sager.
 Magna Produktions GmbH, Juliusstr. 10-11, 0-1000 Berlin 44. Tel: (030) 684-80-58. Telex: 183845. Pres.: Juergen Freidank.
Audio: Compact cassette parts.
 Oietrich Schar Schmidt Studioausruestung, Gernotstr. 11, 0-8000 Munich 40. Tel: (089) 30-65-46. Cable: PROSTUDIO. Pres.: Oietrich Schar Schmidt.
Audio: All cassette parts.
 Schweizer Design Eurosale GmbH, Koenigsweg 3, 0-4973 Vlotho. Tel: (05733) 50-41. Telex: 971217. Mng. Oirs.: G. Deja, Or. M. Gaier.
 Arthur Shishmanian Export-Import, Boeckmanstr. 15, 0-2000 Hamburg 1. Tel: (040) 24-67-74.
 3 M Deutschland GmbH, Carl Schurzstr. 1, 0-404 Neuss 1. Tel: (02101) 141. Gen. Mgr.: Bo Ekman, Sales Mgr.: Juergen Wagner.
 V & C Video & Computer GmbH, Voelkstr. 34, Augsburg, 0-8900 Augsburg. Tel: (0821) 51-68-68.
Audio: Cassette labels.

EMPTY CARTRIDGES, CASSETTES & REELS

Agfa-Gevaert AG, 0-5090 Leverkusen 1 Tel: (0214) 301 Telex 8510420. Chief Exec.: Dr. W. Abeck; Gen. Mgr. W. Blauhut, Sales Mgr. K.W. Rinnebach.
Audio & Video: Cassette.
 Amerindian, An Der Alte Muehle 9, 0-5067 Wesseling-Berzdorf. Tel: (02232) 51780. Chief Exec.: Ingrid Renate Roehre.
 Audio Club, see Magna
 Avecla, see Oietrich Schar Schmidt.
 Eurotape, PO Box 233, 0-2408 Timmendorfer Strand Tel: (04503) 38-49
Audio: 8-tr., cassette.
 I C M GmbH, Lenzburgerstr. 2, 0-7890 Waldshut. Tel: (7751) 3075. Telex: 792249 Pres.: Werner Weber; Mng. Oirs.: Heinz Amann, Rolf Sager.
 Magna Produktions GmbH, Juliusstr. 10-11, 0-1000 Berlin 44. Tel: (030) 684-80-58. Telex: 183845. Pres.: Juergen Freidank
Audio: Open reel.
Video: Videocassette.
Brand names: Audio Club, Magna.
 Oietrich Schar Schmidt Studioausruestung, Gernotstr. 11, 0-8000 Munich 40. Tel: (089) 30-65-46. Cable: PROSTUDIO Pres. Oietrich Schar Schmidt.
Audio: Cassette
Brand name: Avecla.
 Scotch, see 3M.
 3 M Deutschland GmbH, Carl Schurzstr. 1, 0-404 Neuss 1 Tel: (02101) 141. Gen. Mgr.: Bo Ekman; Sales Mgr.: Juergen Wagner.
Audio: 8-tr., cassette, open reel.
Video: Cartridge, cassette, open reel.
Brand name: Scotch.

PROFESSIONAL TAPE SUPPLIES

T O K Electronics Europa GmbH, Georg-Glockstr. 14, 0-4000 Usseldorf Tel: (0211) 43-48-91. Telex: 8584136. Mng. Oir.: Takeshi Shibazaki; Sales Mgr.: Wolfgang Lusch; Adv. Mgr.: Toshinori Kiyose
Audio: Plastic cassette cases & labels.
 Heinz Ufm-Musik GmbH, Voelkstr. 34, D-8900 Augsburg. Tel: (0821) 51-55-55. Cable: HELMMUSIC. Dir.: Heinz Ufm.
Audio & video: Cassette labels.
 V & C Video & Computer GmbH, Voelkstr. 34, 0-8900 Augsburg. Tel: (0821) 51-68-68.
Video: Videocassette labels.

TAPE, BLANK LOADS & RAW

Agfa-Gevaert AG, 0-5090 Leverkusen 1, Tel: (0214) 301 Telex 85 10420. Chief Exec.: Dr. W. Abeck. Gen. Mgr. W. Blauhut; Sales Mgr.: K.W. Rinnebach.
Audio: Blank-2", 1" & 1/2" open reel, cassette, raw-cassette, 1/2" open reel.
Video: Blank-2" & 1" open reel, 1/2" & 1/4" Beta & VHS cassette; raw-1/2" & 1/4" Beta & VHS cassette.
 Alcoplon Albinger KG, Ouenbergerstr. 111-113, 0-2054 Geesthacht. Tel: (4152) 4031. Telex: 218707. Pres.: Rolf Albinger; Gen. Mgr.: Manfred von Mangoldt; Plant Mgr.: Hilmar Kumbartzky. (Blank only)
Audio: Cassette
Brand name: Cross.

A/V/T-66

Amerindian, An Der Alte Muehle 9, D-5067 Wesseling-Berzdorf Tel: (02232) 51780 Chief Exec.: Ingrid Renate Roehre. (Blank only).
Audio: Cassette, open reel.
 Ampex Europa GmbH, Walter Kolbstr. 9-11, 0-6000 Frankfurt 70. Tel: (0611) 60581. Telex: 0413774. Gen. Mgr.: E. Sadeler; Tape Sales Mgr.: B. Schwartz.
Audio: 2", 1" & 1/2" open reel, cassette
Video: Blank-2" open reel, 1" open reel, 1/2" cassette, 1/2" Beta & VHS cassette
 Audio Magnetics GmbH, Borsigstr. 5, D-6054 Rodgau-Niederrodern Tel: (06106) 7971. Telex: 417884.
Audio: 8-tr., cassette, open reel
 Avecla, see Oietrich Schar Schmidt.
 B A S F AG, Gottlieb-Daimlerstr. 10, 0-6800 Mannheim 1 Tel: (0621) 40081 Telex 462621. Chief Exec.: H. Thurn, Gen. Mgr.: H.J. Versemann; Sales Mgr.: H.J. Seitz (Blank only)
Audio: 2", 1" & 1/2" open reel, cassette.
Video: 1" open reel, 1/2" cassette, 1/2" Beta & VHS cassette.
 Cassette GmbH, Sudelenstr. 73, 0-8192 Gertsried 2. Tel: (08171) 3031-33. Telex: (05) 26331. Gen. Mgr.: Stan Zaoralek, Sales Mgr.: Horst Praskowski.
 Cross, see Alcoplon
 E C, see Eurocassette.
 Euro Cassette, Mehningdamm 32/34, D-1000 Berlin 61 Tel: (030) 251-0331. Telex: (01) 83369. Chief Exec.: Guenter A. Kiefer; Chief Eng.: Klaus Mack. (Blank only)
Audio: Cassette.
Brand name: EC.
 Galaxy, see Toka
 Grundig AG, Kurgartenstr. 37, 8510 Furth/Bay. Tel: (0911) 70-31. Telex: (06) 23431.
 I C M GmbH, Lenzburgerstr. 2, D-7890 Waldshut. Tel: (7751) 3075. Telex: 792249 Pres.: Werner Weber; Mng. Oirs.: Heinz Amann, Rolf Sager.
 I O S (International Disc Serv.), PO Box 140105, D-8500 Nuernberg 14. Gen. Mgr.: Hans-Joachim Rabe; Sales Mgr.: W. Ruff.
Audio: Cassette, open reel.
 Inter-Cassette Ltd., Poststr. 14, 0-2000 Hamburg 36. Tel: (040) 35-30-79. (Blank only) (Importer)
Home office: USA.
Int'l branch: Hong Kong
Audio: Cassette
 M C S Music & Cassette Supply GmbH, Lenzburgerstr. 2, D-7890 Waldshut. Tel: (07751) 32-58. Gen. Mgr.: Mario Taravella.
Audio: 8-tr., cassette
 Magna Tontraeger Produktions GmbH, Juliusstr. 10-11, D 1000 Berlin 44. Tel: (030) 684 80 58. Telex: 183845 Pres. Juergen Freidank; Sales Oir.: Jakob Statz; Export Dir.: J.H. Bruett. (Raw only)
Audio: Cassette, open reel.
Video: 1/2" Beta & VHS cassette.
 Maxell Europe GmbH, Emanuel-Leutzstr. 1, 0-4000 Usseldorf 1. Tel: (0211) 59-40-83. Telex: (08) 587288. Oir.: T. Inoue.
Home office: Japan.
Audio: Blank-8-tr., cassette, open reel, raw-8-tr., cassette.
Video: Blank-1/2" cassette.
 Memorex, see W.O. Warren
 Orchestrola GmbH, PO Box 186, Auf Oem Esch 8, D-2840 Diepholz. Tel: (05441) 2293, 1812. Cable: PALAS. Telex: (09) 41221. Gen. & Sales Mgr.: Rolf Neumann, Ass't: Ingeborg Grossman
Audio: Cassette
 Oietrich Schar Schmidt Studioausruestung, Gernotstr. 11, 0-8000 Munich 40. Tel: (089) 30-65-46. Cable: PROSTUDIO Pres. Oietrich Schar Schmidt.
Audio: Cassette, open reel
Video: 1" open reel, 1" cartridge, 1/2" cassette, 1/2" EIAJ open reel, 1/2" EIAJ cartridge.
Brand name: Avecla.
 Scotch, see 3M
 Arthur Shishmanian Export-Import, Boeckmanstr. 15, D-2000 Hamburg 1. Tel: (040) 24-67-74. (Blank only)
 Sony, see W.O. Warren
 T O K Electronics Europe GmbH, Georg-Glockstr. 14, 0-4000 Usseldorf Tel: (0211) 43-48-91. Telex: 8584136 Mng. Oir.: Takeshi Shibazaki; Sales Mgr.: Wolfgang Lusch; Adv. Mgr.: Toshinori Kiyose.
Audio: Cassette, open reel.
Video: 1/2" VHS cassette
 3 M Deutschland GmbH, Carl Schurzstr. 1, 0-404 Neuss 1. Tel: (02101) 141. Gen. Mgr.: Bo Ekman, Sales Mgr.: Juergen Wagner
Audio: 8-tr., cassette, open reel.
Video: 1" open reel, 1" cartridge, 1/2" cassette, 1/2" EIAJ open reel, 1/2" EIAJ cartridge.
Brand name: Scotch.
 Toka Vertreibsgesellschaft mbH, Im Gaesse 13, 0-7250 Leonberg 7 Tel: (0611) 73-20-71. Pres.: Hugo von Blumenthal.
Audio: Cassette
Brand name: Galaxy, Toka.
 Trad Musikverlag, Guntzelstr. 54, D-1000 Berlin 31 Tel: (030) 87-07-40. Chief Exec.: Walter Ruff
Audio: Raw-cassette, open reel
Video: Blank-1/2" cassette.
 W D Warren Co. KG, Im Steingrund 5, 0-6072 Dreieich-Buchschlag. Tel: (06103) 6-10-51. Cable: WAMESCO. Telex: (04) 185391. Owner: William-Oirk Warren; Exec. VP Eugene Elskens; VP Sales Helmut Rossmairer, VP & Controller: Karl Schoon.
Video: 1/2" cassette, 1/2" EIAJ open reel
Brand names: Memorex, Sony.

TAPE DUPLICATING & PROCESSING EQUIPMENT

Asona, see Avis-Asona
 Avis Asona KG, Stollbergstr. 7, D-8000 Munich 22. Tel: (089) 22-50-57. Cable: ASONA. Telex: (05) 22084 Oir. Alf Kuerzeder
Audio: Turnkey cassette duplicating plants, cassette duplicating equip
Brand name: Asona.
 Bellaphon Recs GmbH & Co KG, Mainz Landstr. 87-89, 0-6000 Frankfurt. Tel: (061) 23-08 01. Telex: (04) 16046 Pres. Branko Zivanovic.
 Machi, see Oietrich Schar Schmidt
 Dietrich Schar Schmidt Studioausruestung, Gernotstr. 11, 0-8000 Munich 40. Tel: (089) 30 65-46. Cable: PROSTUDIO. Pres.: Dietrich Schar Schmidt
Audio: Cassette screwing machines.
Brand name: Machi.
 3 M Deutschland GmbH, Carl Schurzstr. 1, 0-404 Neuss 1 Tel: (02101) 141. Gen. Mgr.: Bo Ekman; Sales Mgr.: Juergen Wagner.
Audio: Cassette duplicators
Brand name: Wolfensak

Eberhard Vollmer, Schillerstr. 7, D-7310 Plochingen/N. Tel: (07153) 2-10-04. Cable: VOLLMERWERK. Gen. Mgr. & Eng.: Eberhard Vollmer; Sales Mgr.: Ms. I. Marcon.
 Wolfensak, see 3M.

TAPE PACKAGING & LABELING EQUIPMENT

Avis-Asona KG, Stollbergstr. 7, 0-8000 Munich 22. Tel: (089) 22-50-57. Cable: ASONA. Telex: (05) 22084 Oir.: Alf Kuerzeder.
Product: Labeling equip.
 Heino Iseemann GmbH, Zum Panregel 24, 0-2800 Bremen 44. Tel: (0421) 48-30-83. Telex: 244055. Chief. Exec.: Heino Iseemann.
 Magna Produktions GmbH, Juliusstr. 10/11, 0-1000 Berlin 44. Tel: (030) 684-80-58. Telex: 183845. Pres.: Juergen Freidank.

• accessories

Agfa-Gevaert AG, 0-5090 Leverkusen 1 Tel: (0214) 301. Telex: 8510420. Chief Exec.: Dr. W. Abeck; Gen. Mgr.: W. Blauhut; Sales Mgr.: K.W. Rinnebach.
Product: Tape-leader tape (audio), splicing tape & equip. (audio).
 Alcoplon Albinger KG, Ouenbergerstr. 111-113, 0-2054 Geesthacht. Tel: (4152) 4031. Telex: 218707. Pres.: Rolf Albinger; Gen. Mgr.: Manfred von Mangoldt; Plant Mgr.: Hilmar Kumbartzky.
Product: Tape-head cleaners & demagnetizers.
 Amerindian, An Der Alte Muehle 9, D-5067 Wesseling-Berzdorf. Tel: (02232) 51780. Chief Exec.: Ingrid Renate Roehre.
Product: Record-record care prods., replacement styli; Tape-leader tape, splicing tape & equip.
 Ampex Europa GmbH, Walter Kolbstr. 9-11, 0-6000 Frankfurt 70. Tel: (0611) 60581. Telex: 0413774. Gen. Mgr.: E. Sadeler; Tape Sales Mgr.: B. Schwartz.
Product: Tape-carrying & storage cases, head cleaners, bulk erasers, demagnetizers, leader tape, splicing tape & equip. (all audio & video).
 Avis-Asona KG, Stollbergstr. 7, 0-8000 Munich 22. Tel: (089) 22-50-57. Cable: ASONA. Telex: (05) 22084. Oir.: Alf Kuerzeder.
Product: Tape-bulk erasers (audio), splicing tape & equip. (audio).
 I C M GmbH, Lenzburgerstr. 2, 0-7890 Waldshut. Tel: (7751) 3075. Telex: 792249. Pres.: Werner Weber; Mng. Oirs.: Heinz Amann; Rolf Sager.
Product: Tape-carrying & storage cases.
 I O S (International Disc Serv.), PO Box 140105, 0-8500 Nuernberg 14. Gen. Mgr.: Hans-Joachim Rabe; Sales Mgr.: W. Ruff.
Product: Tape-splicing tape & equip
 Inter-Cassette Ltd., Poststr. 14, 0-2000 Hamburg 36. Tel: (040) 35-30-79.
Home office: USA.
Int'l branch: Hong Kong
Product: Record-record care prods., sweep arms; Tape-head cleaners.
 O Kretz (Automaten-Serv.), Yorckstr. 41, 0-7500 Karlsruhe 1 Tel: (0721) 55-03-95. Pres. Oiethelm Kretz; Sales Mgr.: Gertrud Drost.
Product: Record-carrying & storage cases, record care prods., replacement styli; Tape-head cleaners, demagnetizers.
 Magna Tontraeger Produktions GmbH, Juliusstr. 10-11, 0-1000 Berlin 44. Tel: (030) 684-80-58. Telex: 183845. Pres.: Juergen Freidank
Product: Tape-carrying & storage cases (audio & video), head cleaners (audio), demagnetizers (audio), leader tape (audio & video), splicing tape & equip. (audio & video).
 Maxell Europe GmbH, Emanuel-Leutzstr. 1, D-4000 Usseldorf 1. Tel: (0211) 59-40-83. Telex: (08) 587288. Oir.: T. Inoue.
Home office: Japan.
Product: Tape-head cleaners.
 C. Melchers & Co., Postfach 102560, Schlachte 41, 0-2800 Bremen. Tel: (0421) 316-9323.
Product: Record-replacement styli (Pickering).
 Orchestrola GmbH, PO Box 186, Auf Dem Esch 8, D-2840 Diepholz. Tel: (05441) 2293, 1812. Cable: PALAS. Telex: (09) 41221. Gen. & Sales Mgr.: Rolf Neumann, Ass't: Ingeborg Grossman.
Product: Record-carrying & storage cases, record care prods., 45 rpm adaptors, Tape-head cleaners & demagnetizers.
 Pickering, see C. Melchers.
 Oietrich Schar Schmidt Studioausruestung, Gernotstr. 11, D-8000 Munich 40. Tel: (089) 30-65-46. Cable: PROSTUDIO. Pres.: Oietrich Schar Schmidt.
Product: Tape-head cleaners, demagnetizers, leader tape.
 Schweizer Design Eurosale GmbH, Koenigsweg 3, 0-4973 Vlotho. Tel: (05733) 50-41. Telex: 971217. Mng. Oirs.: G. Deja, Or. M. Gaier.
Product: Record-carrying & storage cases, record care prods., Tape-carrying & storage cases, demagnetizers.
 Stanton, see Teledyne.
 T D K Electronics Europe GmbH, Georg-Glockstr. 14, D-4000 Usseldorf. Tel: (0211) 43-48-91. Telex: 8584136. Mng. Oir.: Takeshi Shibazaki; Sales Mgr.: Wolfgang Lusch; Adv. Mgr.: Toshinori Kiyose.
Product: Tape-head cleaners (audio & video), demagnetizers (audio).
 Teac Tonband-Anlagen-Vertriebs GmbH, Egerstr. 2, 0-6200 Wiesbaden-Erbenheim. Tel: (06121) 742-25. Telex: (04) 186159. Mgr.: Masao Morita.
Product: Tape-head cleaners, demagnetizers.
 Teledyne Acoustic Research, Burgstr. 6-8, 0-6200 Wiesbaden. Tel: (06121) 3-91-71.
Product: Record-replacement styli (Stanton).
 3 M Deutschland GmbH, Carl Schurzstr. 1, D-404 Neuss 1 Tel: (02101) 141. Gen. Mgr.: Bo Ekman; Sales Mgr.: Juergen Wagner.
Product: Tape-leader tape, splicing tape & equip.
 Videoring GmbH, PO Box 1167, Am Schierenberg 2, 0-2106 Bendestorf. Tel: (04183) 6035. Cable: VIDEOERING. Telex: 2189719. Oirs.: Paul Moeckel, Mario Villavicencio.
Product: Tape-carrying & storage cases (video).
 W. O. Warren Co. KG, Im Steingrund 5, 0-6072 Dreieich-Buchschlag. Tel: (06103) 6-10-51. Cable: WAMESCO. Telex: (04) 185391. Owner: William-Oirk Warren; Exec. VP Eugene Elskens; VP Sales: Helmut Rossmairer, VP & Controller: Karl Schoon.
Product: Record-replacement styli; Tape-carrying & storage cases.

• store fixtures

Alcoplon Albinger KG, Ouenbergerstr. 111-113, 0-2054 Geesthacht. Tel: (4152) 4031. Telex: 218707. Pres.: Rolf Albinger; Gen. Mgr.: Manfred von Mangoldt; Plant Mgr.: Hilmar Kumbartzky.
Product: Record & tape display racks, tape divider cards.
 Amerindian, An Der Alte Muehle 9, 0-5067 Wesseling-Berzdorf. Tel: (02232) 51780. Chief Exec.: Ingrid Renate Roehre.
Product: Display racks, divider cards.
 O. Kretz (Automaten-Serv.), Yorckstr. 41, 0-7500 Karlsruhe 1. Tel: (0721) 55-03-95. Pres. Diethelm Kretz; Sales Mgr.: Gertrud Drost.
Product: Display racks.
 Schweizer Design Eurosale GmbH, Koenigsweg 3, 0-4973 Vlotho. Tel: (05733) 50-41. Telex: 971217. Mng. Oirs.: G. Deja, Or. M. Gaier
Product: Record & Tape browser boxes, record display racks.

3 M Deutschland GmbH, Carl Schurzstr. 1, D 404 Neuss 1. Tel: (02101) 141 Gen. Mgr.: Bo Ekman, Sales Mgr.: Juergen Wagner.

Product: Display racks.

W. D. Warren Co. KG, Im Steingrund 5, D-6072 Dreieich-Buchsschlag. Tel (06103) 6-10-51. Cable: WAMESCO Telex: (04) 185391. Owner: William Dirk Warren, Exec VP. Eugene Elskens: VP Sales Helmut Rossmaier, VP & Controller: Karl Schoon. Product: Display racks.

• independent video producers

The following is a list of Video Production companies that are involved in the production and recording of video for concerts, record/artist promos and other music related projects. Facilities, equipment, and services listed are intended as a brief description only and may not necessarily reflect a particular company's full capabilities.

Video Beratung & Forschung, Postbox 44-223, Karl Theodorstr 48, D-8000 Munich 44, Tel: (089) 39-72 30. Owner: Julek Kedzierski. Formats: 2", 1".

Facilities: Rented as needed

Videoing Prods'n, PO Box 1167, Am Schierenberg 2, D-2106 Bendestorf. Tel: (04183) 6035. Cable: VIDEORING. Telex: 2189719. Dirs.: Paul Moeckel, Mario Villavicencio.

Formats: 2", 1", 3/4", 1/2" Beta, VHS & V-2000

Facilities: studio—3 studios (300-1000 sq. m.), audio studio, RCA TK-47 cams: mobile/portable—2-4 RCA TK-760 & TK-47 cams, post-prod/n—two suites with all effects

• playback/recording equipment

A S A Musik Vertrieb GmbH, Friedrichstr 40, D-6000 Frankfurt/Main. Tel: (0611) 72-78-72.

Brand names: SMS, Susi 8

Awa, see W.O. Warren.

Ampex Europa GmbH, Walter Kolbstr. 9-11, D-6000 Frankfurt 70, Tel: (0611) 60581. Telex: (04) 13774. Cable: VIDEO TAPE. Mng. Dir.: E. Saderer. Tape Sales Mgr.: B. Schwartz. Video Sales Mgr.: L. Nietsch; Audio Sales Mgr.: P. Classen; Adv. Co-ord.: Gisela Rosin (Audio & Video). Audio Club, see Magna.

Aurex, see Toshiba.

Denon, see Nippon Columbia

E M I Voxson GmbH, Aachenstr. 312, D-5000 Cologne 41.

Grundig AG, Kurgartenstr. 37, D-8510 Fuerth. Tel: (0911) 7031. Telex: (06) 23431. Mng. Dir.: Max Grundig; Adv. Mgr.: Mr. Stegert; Press Officer: Helmut Reichel.

I D S (International Disc Serv.), PO Box 140105, Auf der Schanz 44, D-8500 Nurnburg 14. Pres.: H.J. Rabe; Sales Mgr.: W. Ruff (Audio only). International Video Corp., Feldbergstr. 40, D-6100 Darmstadt. Tel: (06151) 82131. Telex: 419695. (Video only)

J V C European Liaison Office, Frankfurterstr. 13-15, D-6236 Eschborn/Ts. Tel: 44010. Telex: 418351.

Subsidiaries: D-6236 Eschborn/Ts, JVC Deutschland GmbH, Frankfurterstr. 13-15. Tel: (06196) 48780. Telex: 417499—D-6000 Frankfurt/Main 94, JVC Electronics (Deutschland) GmbH, Breitbacherstr. 96. Tel: 780951. Telex: 413821

Audio & Video: JVC, Victor (both Japan).

Magna Produktions GmbH, Juliusstr. 10-11, D-1000 Berlin 44. Tel: (030) 684-4028. Telex: 183845. Gen. Mgr.: Juergen Freidank. Audio: Audio Club, Magna.

Video: Magna.

Magnetophon, see AEG-Telefunken

Nippon Columbia Co. Ltd., Kaufmannshans 1, Zimmer 126, D-2000 Hamburg 36.

Brand name: Denon (Japan)

O H R Musikproduktion GmbH, PO Box 850227, D-5000 Cologne 80. Tel: (0221) 68 25-74. (Video only)

Realistic, see Tandy.

S M S, see ASA

Oietrich Schar Schmidt Studioausrustung, Gernotstr. 11, D-8000 Munich 40. Tel: (089) 30-65-46. Cable: PROSTUDIO. Pres.: Oietrich Schar Schmidt.

Audio: Sonorex.

Sonorex, see Oietrich Schar Schmidt

Sony, see W.O. Warren & Stiers.

Stiers Unterhaltungselektronik GmbH, Liebigstr. 8-15, D-8000 Munich 22. Tel: (089) 22-16-96. Telex: 0522801. Mng. Dir.: Dennis L. Stiers, Sales Mgr.: Hans Werner Runge; Adv. Mgr.: Mana Weich

Audio: Technics (Japan).

Video: Sony (Japan).

Susi 8, see ASA.

Tandy Int'l Electronics, Luisenstr. 98, D-4000 Dusseldorf 1.

Audio: Realistic (USA).

Teac Tonband-Anlagen-Vertriebs GmbH, Egerstr. 2, D-6200 Wiesbaden-Erbenheim. Tel: (06121) 7 42-25. Telex: (04) 186159. Mgr.: Masao Morita. (Audio only)

Technics, see Stiers

Telefunken Fernseh & Rundfunk GmbH, Goettingen Chaussee 76, D-3000 Hannover 91. Tel: (0511) 41-81. Telex: 923101. Pres.: Dieter Hellmanns; Sales Mgr.: Dr. Kunkel. (Audio only)

3 M Deutschland GmbH, Carl Schurzstr. 1, D-404 Neuss 1. Tel: (02101) 141. (Audio & Video)

Toshiba Deutschland GmbH, Hammerlandstr. 115, D-4040 Neuss. Tel: (02101) 19-81. Cable: TOSHIBA NEUSS. Telex: 8517926. Pres.: T. Kurrose, Sales Mgr.: R.O. Waida; Adv. Mgr.: K.G. Kirchner

Audio: Aurex, Toshiba (Japan)

Video: Toshiba (Japan)

Victor, see JVC.

W. O. Warren Co. KG, Im Steingrund 5, D-6072 Dreieich-Buchsschlag. Tel: (06103) 6-10-51. Cable: WAMESCO. Telex: (04) 185391. Pres.: William Dirk Warren; Audio Sales Mgr.: Ken Bennett; Video Sales Mgr.: K. Ehrmann.

Audio: Awa (Japan).

Video: Sony (Japan)

Konrad Wolf Musikproduktion, Alte Dorfstr. 22, D-2000 Hamburg 65. Tel: (040) 605-2333

Italy

• services

DESIGN & ARTWORK

Mario Convertino, Via Giovannino dei Grassi 3, 20123 Milan. Tel: (02) 808.716

Gianni Greguoli, Via Vincenzo Monti 77, Milan. Tel: (02) 498 9467. Ass't Luca Greguoli

Luciano Tallarini, Via Giannone 2, 20154 Milan. Tel: (02) 316.427. Chief Exec.: Luciano Tallarini

PRINTERS & LITHOGRAPHERS

Ecolina Srl, Via Leopardi 8, 20123 Milan. Tel: (02) 869 0121, 806 125. Chief Exec.: Mourad Sabet. Factory: Via Monviso 21. Tel: (02) 314 766

Factory Technical Mgr.: Ronald F. Goodwin

G T E (General Tape Equip.) Srl, Via Ragusa 8, Milan. Tel: (02) 689 8065. Telex: 333046. Gen. Mgr.: Ottaviano Clerici Bagozzi. (tape only)

TAPE CUSTOM DUPLICATORS

TAPE PACKAGING & LABELING

The Audio & Video lines indicate the configurations which the firms duplicate. Companies which offer packaging & labeling of tape product are indicated by: "PMG" which appears after the main body of their respective listings.

Ampex Italiana SpA, Via Riccardo Gigante 4, 00143 Rome. Tel: (06) 546.991. Cable: AMPLEX. Telex: 610492. Mng. Dir.: Riccardo Crippa, Sales Mgr.: Ono Grossi.

Home office: USA.

Audio: 8-tr., cassette

Audiogramm SpA, Via Vallosa 38, 25050 Passirano (Brescia), Tel: (030) 657 360. Telex: 300826. Owner & Mng. Dir.: Edoardo Cattaneo, Gen. Mgr.: Francesco Nervi; Sales Execs.: Italo Capoferri, Romano DeSalci.

Audio: 8-tr., 8-tr. quadraphonic, cassette, open reel, open reel quadraphonic.

Avelca SpA, Via Emanuella 16, 21047 Saronno (Varese), Tel: (02) 960.5413/3248. Telex: 335884. Admin'r & Gen. Mgr.: Sergio Moretti (PMG)

Audio: Cassette

Avelca Video Rec. SpA, Via Lumiere 4, 20093 Cologno Monzese (Milan), Tel: (02) 253.2524. Telex: 26502. Mng. Dir. & Gen. Mgr.: Luciano Porilli, Mktg. Mgr.: Ambrogio Campanari, Tech. Dir.: Lamberto Milan (PMG).

Audio: Cassette

Video: 1" open reel, 1" cartridge, 3/4" U-matic, 1/2" EIAJ cartridge

Oucaleco Ltd. Musicali SpA, Via Per Cadrezate 5, 21020 Brebbia (Varese), Tel: (0332) 770 784/189. Telex: 380231. Cable: DUCALEMUSIC. Pres. & Gen. Mgr.: Davide Matalon (PMG)

Audio: 8-tr., 8-tr. quadraphonic, cassette, open reel.

Ouplomatic Srl, Via Pietro Oella Valle 20, 20132 Milan. Tel: (02) 256 4770. Gen. Mgr.: Guido Mezzadra, Sales Mgr.: Enrico Mezzadra.

Audio: Cassette, open reel

Oupli Video Sound Snc, Via Pomezia 10/A, Milan. Tel: (02) 285.3517. Mng. Dir.: Franco Venturato, Prod'n Mgr.: Ezio Mazzucato (PMG)

Audio: 8-tr., cassette, open reel.

Duplo Magnetic, Via Leida 8, 37135 Verona. Tel: (045) 504.491

Audio: 8-tr., 8-tr. quadraphonic, open reel, open reel quadraphonic.

Durema (Duplicazioni Registratori Magnetiche) SpA, Via Imperia 28, 20142 Milan. Tel: (02) 843.7344/0740. Mng. Dir., Gen. & Sales Mgr.: Dr. Claudio Occhiena; Technical Mgr.: Paolo Maggiolini

Audio: 8-tr., cassette, open reel

Video: 1" open reel, 3/4" cassette, 1/2" VHS.

Durum SpA, Via Manzoni 40/42, 20121 Milan. Tel: (02) 701.703, 701.705, 701.008. Telex: 333564. Pres. & Mng. Dir.: Krikor Mantangan; Sales Mgr.: Amleto Silvestro; Int'l Dept. Mgr.: Elisabet Mintangan. (PMG)

Audio: Cassette

E M I Italiana SpA, Via Bergamo 315, 21042 Caronno Pertusella (Varese). Cable: EMITAL. SARONNO. Telex: 312679. Mng. Dir.: Alexis Rotelli; Comm'l Mgr.: Roberto Magrini, Mktg. Mgr.: Franco Cabrini; A&R Mgr.: Gianpiero Scussel, Promo. Mgr.: Michele Di Lerna; Financial Controller: Alberto Vignati; Factory Mgr.: Claudio Cattaneo

Audio: 8-tr., cassette, open reel

Ecolina Srl, Via Leopardi 8, 20123 Milan. Tel: (02) 869 0121. Chief Exec.: Mourad Sabet. Factory: Via Monviso 21. Tel: (02) 314 766. Factory Technical Mgr.: Ronald F. Goodwin.

Audio: 8-tr., 8-tr. quadraphonic, cassette, open reel, open reel quadraphonic

Genca (General Cassette) SaS, Via Don Minzoni 16, 20061 Carugate (Milan). Tel: (02) 904 8815. Telex: 31371. 37607

Audio: 8-tr., 8-tr. quadraphonic, cassette.

Gramegna, Via Sago 72, 20100 Milan. Tel: (02) 255.1241. Telex: 321497. API 2308. Pres.: Franco Gramegna (PMG only)

Italyplast Snc, Via Pezzotta 6, Albino (Bergamo), Tel: (035) 752.141. Co-Pres.: Franco Galimberti, Attilio Balduzzi, Giuseppe Mismetti, Mktg. Mgr.: Franco Galimberti, Gen. Affairs Mgr.: Attilio Balduzzi, Technical Mgr.: Giuseppe Mismetti (PMG)

Audio: Cassette

M D A Srl, Via San Giuseppe 137, 21047 Saronno. Tel: (02) 962.0914. Telex: 380426. Chief Exec.: Roberto Macchi, Gen. Mgr.: Pinnuccia Grassi; Sales Mgr.: Eugenia Maffizoni

Audio: 8-tr., cassette

M I P (Music Int'l Prod'n) Srl, Via San Luca 10, Milan. Tel: (02) 837.0908. Mng. Dir.: Marlene Matalon; Gen. Mgr.: David Matalon; Int'l Mgrs.: Daniela & Manuela Matalon (PMG)

Audio: 8-tr., cassette

Mitras di Cappellini Alfredo & Giorgio, Via Cavezzoli 8/A, 20100 Milan. Tel: (02) 289.9206. Gen. Mgr.: Alfredo Cappellini. (PMG only)

Ogem, Via Mecenate 30/26, 20100 Milan. Tel: (02) 506.1281. Gen. Mgr.: G. Guarnerio (PMG only)

Phonotype Rec. Srl, Via Enrico de Marinis 4, 80134 Naples. Tel: (081) 206 642, 205 873. Chief Exec.: Vincenzo Esposito; Gen. Mgr.: Fernando Esposito, Sales Mgr.: Roberto Esposito.

Audio: 8-tr., cassette.

PolyGram Dischi SpA, Viale Regina Giovanna 29, 20129 Milan. Tel: (02) 204 841. Cable: COMINFON. Telex: 334140. Mng. Dir.: Marco Bignotti; Mktg. Mgr.: Bruno Tibaldi; Sales Mgr.: Mario Gabelli, A&R Mgr.: Claudio Fabi; Pub. Mgr.: Bruno Fedetto.

Audio: Cassette.

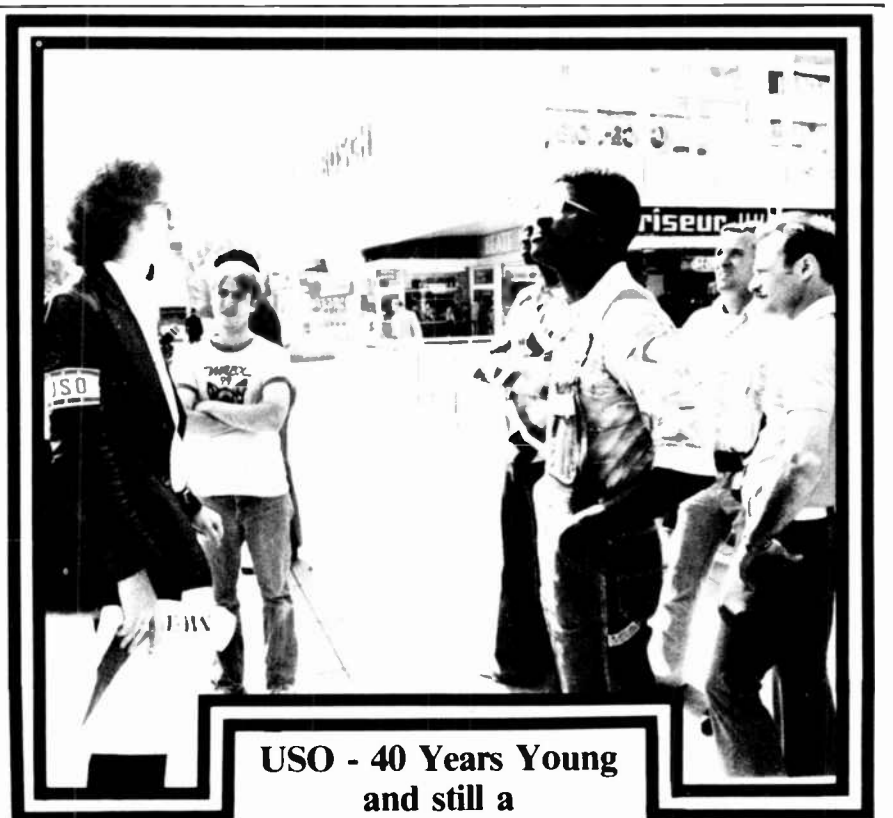

USO - 40 Years Young and still a Home Away From Home

USO does it again, and again, and again. Millions of times over the past 40 years. USO has helped young service families out of 'tight' spots.

Dionne Warwick

Around the world, over 125 USO bring individual and family help, classes, travel and housing assistance and more. Make home seem as close as the nearest USO. Judd Hirsch

A/V/T-67

TO AVOID ANY PRODUCTION PROBLEMS THE SOLUTION IS

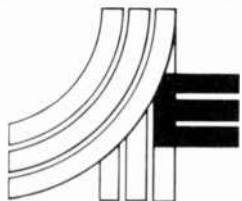

ECOFINA

YOUR CASSETTE CUSTOM DUPLICATOR IN EUROPE Quality-Quantity-Price

Ecofina s.r.l.

Sede e Direzione Generale: 20123 Milano, via Leopardi 8 tel. (02) 806125-8690121
Stabilimento (plant): 20154 Milano, via Manvisa 21 tel. (02) 314766-3182272 - ITALY

INTERNATIONAL COMPACT CASSETTE S.N.C.

DI CAVAGNOLI PIER ANTONIO
VIA LARGA
25024 PORZANO DI LENO
(BRESCIA), ITALY
TELEPHONE: 030/906484 - 9067196
TELEX: 301247 CRALEN I CAVAGNOLI

Sole Agent for UK and Ireland:
R.P.L. EVANS
Tel.: FARINGDON (0367) 20262,
Telex 858623

Sole Agent for Scandinavian
Countries:
STIG LASSEN
Tel.: COPENHAGEN (01) 620488

- C-O COMPACT CASSETTE
- LIBRARY BOXES
- 8-TRACK CARTRIDGES
- BLANK CASSETTES

MAGNEX "hi-fi cassettes"



the bank
for your sound

Distribution worldwide network is going to be established.
Present distributors are covering the following countries:

Belgium, France, Finland, Italy, Spain.
For free areas please contact us by telephone or telex.

Via G.B. Grassi, 97
20157 MILAN - ITALY
Telephone (5 L.) 02/35.55.146
Telex 331269



Ponzone & Vico, Via Marconi 87, 17017 Millesimo (Savona) Tel (019) 56256 Chief Exec Vico Umberto (PKG only)
R-C A SpA, Via San Alessandro 7, Rome Tel (06) 43 661 Telex 610428
Pres.: Giuseppe Ornato, Gen Mgr Ennio Mellis; Comm'l Mgr Luciano Bernacchi
Home office: USA
Audio: 8 tr, cassette
Ricordi SpA (Dischi), Via Barletta 11 20100 Milan, Tel (02) 539 2392
Telex 310177 Admin Mgr Giuseppe Maurelli
Audio: Cassette
Saar S.r.L., Via Gramsci 4, 20016 Pero (Milan) Tel 353 0573/0564 Pres Walter Gurtler
Audio: Cassette
Sirma SpA, Via Vignolesi 85, 41057 Spilamberto (Modena), Tel (059) 78 42 57 Telex 510250 Pres Aris Ballestruzzi (PKG only)
Start Inc., Corso Garibaldi 120, 20030 Seveso (Milan) Tel (0362) 508 701
Cable START Telex 312080 Pres Mario Colombo, Gen Mgr Dario De Benedetti, Sales Mgr Luigi Cane (PKG only-audio).
3 M Italia SpA, San Felice Segrate (Milan) Tel (02) 75 451 Telex 31275, 31159 Mng Dir T Shoop, Sales & Mktg Mgr G Mariano
Audio: 8 tr cassette, open reel
Video: 1" open reel, 1/4" cassette, 1/2" EIAJ open reel, 1/2" EIAJ cartridge

• supplies

CARTRIDGE & CASSETTE PARTS

A T B SpA, Via Palmiro Togliatti 30, 20030 Senago (Milan) Tel (02) 998 9976 Cable ATIBISENAGO Telex 334457 Mng Dir Abramo Bordignon
Audio: Single & band-assembled components for cassettes, digital cassettes & 8 tr., spring pads & antifriction liners, full, flat & flat-foam shields in any magnetic alloy; customer designed supplies
Ampex Italiana SpA, Via Riccardo Gigante 4, Rome Tel (06) 546 991
Cable AMPEX ROME Telex 610492 Mng Dir Riccardo Crippa, Sales Mgr Dino Grossi
Home office: USA
Audio & Video: Plastic cassette parts
Audiogramm SpA, Via Vallosa 38, 25050 Passirano (Brescia) Tel (030) 657 360 Telex 300826 Owner & Mng Dir Edoardo Cattaneo Gen Mgr Francesco Nervi, Sales Execs Italo Capoferrri, Romano De Scalzi
Avelca SpA, Via Emanuella 16, 21047 Saronno (Varese) Tel (02) 960 5413/3248 Telex 335884 Mng Dir & Gen Mgr Sergio Moretti
Bresolin Corrado, Via XXV Aprile 205, 20092 Cinisello Balsamo (Milan) Tel (02) 618 8064 Pres Corrado Bresolin
Audio: All parts
Duplomatic S.r.L., Via Pietro Della Valle 20, 20132 Milan Tel (02) 256 4770
Gen Mgr Guido Mezzadra Sales Mgr Enrico Mezzadra
F I L P (Fabbrica Isolanti Laminati Plastici) SpA, Piazza Giolitti 8, 20133 Milan Tel (02) 235 350, 230 982
Audio: Cassette components, leader & leader personalized, antifriction & antistatic liners, spring pads, flat & flat foam shields
Fraem (Societa Individuale di Gaetani Cesare), Via Niccodemo 5 20154 Milan, Tel (02) 367 693 Gen Mgr Cesare Gaetani
Genca (General Cassette) SaS, Oon Minzoni 16, 20061 Carugate (Milan) Tel (02) 904 8815, Telex 31371, 37607
Audio: Hubs & rollers
G S Ghelfi Via Alberti 8, 20149 Milan Tel (02) 38 14 18 Gen Mgr Paolo Ghelfi
International Compact Cassette SnC, Via Larga, 25024 Porzano di Leno, Brescia Tel (030) 906 484/7196 Telex 301247 Owner, Pier Antonio Cavagnoli
Italyplast SnC, Via Pezzotta 6, Albino (Bergamo) Tel: (035) 752 141 Co Pres Franco Galimberti Attilio Balduzzi, Giuseppe Mismetti, Mktg Mgr Franco Galimberti, Gen Affairs Mgr Attilio Balduzzi Technical Mgr Giuseppe Mismetti
Pelle Lampugnani, Via Mincio 2, 20139 Milan Tel (02) 539 1103 Gen Mgr Raffaele Lampugnani (Audio only)
M O A S.r.L., Via San Giuseppe 137, 21047 Saronno Tel (02) 962 0914 Telex 380426 Chief Exec Roberto Macchi Gen Mgr Pinuccia Grassi Sales Mgr Eugenia Maffizzone
Music Box, Via Adua, 25005 Passirano (Brescia), Tel (030) 65 73 68 Gen Mgr Franco Rossetti
Nuova SIAT (Societa Italiana Articoli Tecnici) S.r.L., Via dell'Orto 21, 21047 Saronno (Varese) Tel (02) 960 7485/7450 Cable NSIAT Telex 335884 Mng Dir Edoardo Benetton
Start Inc., Corso Garibaldi 120, 20030 Seveso (Milan) Tel (0362) 508 701
Cable START, Telex 312080, Pres Mario Colombo, Gen. Mgr Dario De Benedetti, Sales Mgr Luigi Cane
Audio: 8-tr., cassette.
Brand names: Comp Ray, Tecno-Ray

EMPTY CARTRIDGES, CASSETTES & REELS

A T B SpA, Via Palmiro Togliatti 30, 20030 Senago (Milan) Tel (02) 998 9976 Cable ATIBISENAGO Telex 334457 Mng Dir Abramo Bordignon
Ampex Italiana SpA, Via Riccardo Gigante 4, 00143 Rome Tel (06) 546 991, Cable AMPEX Telex 610492 Mng Dir Riccardo Crippa, Sales Mgr Dino Grossi
Home office: USA
Audio: 8 tr cartridge, cassette, reels
Video: 2", 1" reels, 1/4" cassette, 1/2" Beta & VHS cassette
Brand names: Ampex, Shamrock
Audio Devices, see Neumannacustic
Audiogramm SpA, Via Vallosa 38, 25050 Passirano (Brescia) Tel (030) 657 360 Telex 300826 Owner & Mng Dir, Edoardo Cattaneo, Gen Mgr Francesco Nervi, Sales Execs Italo Capoferrri, Romano De Scalzi
Audio: 8-tr, cassette
Avelca SpA, Via Emanuella 16, 21047 Saronno (Varese) Tel (02) 960 5413/3248 Telex 335884 Mng Dir & Gen Mgr Sergio Moretti
Audio: 8 tr, cassette
Bresolin Corrado, Via XXV Aprile 205, 20092 Cinisello Balsamo (Milan) Tel (02) 618 8064 Pres Corrado Bresolin
Audio: 8 tr, cassette
Comp Ray, see Start
Ducale Ind. Musicali SpA, Via Per Cadrezzate 5, 21020 Brebbia (Varese) Tel (0332) 770 784/189 Cable OUCALEMUSIC BREBBIA (VARESE)
Telex 380231 Pres & Gen Mgr. Davide Matalon
Europa Compact Cassette SnC, Via Martiri Della Libertà 53, 25035 Ospitaletto (Brescia) Tel (030) 640 134 Telex 300260 Mng Dir Rinaldo Bianchi
Audio: Cassette
F I L P (Fabbrica Isolanti Laminati Plastici) SpA, Piazza Giolitti 8, 20133 Milan Tel (02) 235 350, 230 982

Fraem (Societa Individuale di Gaetani Cesare), Via Niccodemi 5, 20154 Milan. Tel: (02) 367 693 Gen. Mgr. Cesare Gaetani

G T E (General Tape Equip.) Srl, Via Ragusa 8, 20125 Milan Tel (02) 689-8065. Telex 333046. Gen. Mgr. Ottaviano Clerici Bagozzi

Audio: 8-tr., cassette.

Genca (General Cassette) SaS, Via Don Minzoni 16, 20061 Carugate (Milan). Tel (02) 904-8815 Telex 31371. 37607

Audio: Cassette

Brand name: King Sound

G. S. Ghelfi Via Alberti 8, 20149 Milan Tel (02) 38 14 48 Gen Mgr Paolo Ghelfi

Audio: Cassette

International Compact Cassette SnC, Via Larga, 25024 Porzano di Leno, Brescia Tel (030) 906.484/7196 Telex: 301247. Owner Pier Antonio Cavagnoli

Italyplast SnC, Via Pezzotta 6, Albino (Bergamo) Tel (035) 752 141 Co Pres. Franco Galimberti, Attilio Balduzzi, Giuseppe Mismetti, Mktg Mgr Franco Galimberti, Gen Affairs Mgr Attilio Balduzzi. Technical Mgr Giuseppe Mismetti

King Sound, see Genca

Piella Lampugnani, Via Mincio 2, 20139 Milan Tel (02) 539 1103 Gen Mgr. Raffaele Lampugnani

Audio: Cassette

Lear Jet, see Start

M D A Srl, Via San Giuseppe 137, 21047 Saronno Tel (02) 962 0914 Telex 380426 Chief Exec Roberto Macchi, Gen Mgr Pinuccia Grassi, Sales Mgr Eugenia Maffizoni

Audio: 8 tr., cassette

M I P (Music Ind Prod'ns) Srl, Via San Luca 10, Milan Tel (02) 837 0908 Mng Dir Marlene Matalon, Gen Mgr David Matalon Int'l Mgr Daniela & Manuela Matalon

Audio: Cassettes

Music Box, Via Adua, 25005 Passirano (Brescia) Tel (030) 65 73 68 Gen Mgr Franco Rossetti

Nuova SIAT (Societa Italiana Articoli Tecnici) Srl, Via dell'Orto 21, 21047 Saronno (Varese) Tel (02) 960-7485/7450 Cable NSIAT Telex 335884. Mng. Dir Edoardo Benetton

Audio: 8 tr. cartridge, cassette & reels, boxes

Brand name: SIAT

Pigiemme Srl, Via Colomi 28, 21109 Varese Tel (0332) 311 233

Polimek Srl, Via Pace 64, 20017 Rho (Milan) Tel (02) 930 1742/9484 Telex 330501 Chief Exec Rosario Mandina, Gen. Mgr Girolamo Magotti

Audio: Cassette

S I A T, see Nuova

Scotch, see 3M

Shamrock, see Ampex

Start Inc., Corso Garibaldi 120, 20030 Seveso (Milan) Tel (0362) 508 701 Cable START Telex 312080 Pres Mario Colombo, Gen Mgr Dario De Benedetti, Sales Mgr Luigi Cane

Audio: 8 tr., cassette

Brand names: Lear Jet, Comp-Ray, Techno Ray

Techno-Ray, see Start

3 M Italia SpA, San Felice Segrate (Milan) Tel (02) 75 451 Mng Dir T S Skoog, Sales & Mktg Mgr G. Mariano

Audio: Reels

Brand name: Scotch

Ve Ma, Viale Dell-Industria 57, 20037 Paderno Dugnano (Milan) Tel (02) 918 2713 Sales Mgr Gino Tonelli

Vemas Srl, Via Lavoro Industria, Rudiano (Brescia) Tel (030) 716 211 Telex 30060

PROFESSIONAL TAPE SUPPLIES

Agfa Gevaert SpA, Viale de Gasperi, 20151 Milan Tel (02) 307 401 Telex 37182 Chief Exec Benito Chiucchini, Sales Mgr Giorgio Dordoni, Mktg. Giorgio Regorda

Product: Magnetic film

Musical Instruments, Via Como 19, 22065 Mariano Comense (Como) Tel (031) 749 212

Audio: Cassette boxes

Polimek Srl, Via Pace 64, 20017 Rho (Milan) Tel (02) 930 1742/9484 Telex: 330501 Chief Exec Rosario Mandina, Gen Mgr Girolamo Magotti

Audio: Cassette boxes

Trulzi, Via Valba 56, 20026 Novate Milanese (Milan) Tel (02) 354 1661/1785

Audio: Plastic shelves for cassettes

TAPE, BLANK LOADED & RAW

Agfa Gevaert SpA, Viale de Gasperi, 20151 Milan Tel (02) 307 401 Telex 37182 Chief Exec Benito Chiucchini, Sales Mgr Giorgio Dordoni, Mktg. Giorgio Regorda

Audio: Blank-cassette, open reel, raw-cassette

Video: 1" open reel

Ampex Italiana SpA, Via Riccardo Gigante 4, 00143 Rome Tel: (06) 546.991 Cable AMPLEX Telex: 610492 Mng Dir. Riccardo Crippa, Sales Mgr Dino Grossi

Home office: USA

Audio: Cassette, open reel

Video: Blank-2" quad, 1" open reel, 1/2" cassette, 1/4" EIAJ open reel, 1/2" Beta cassette.

Audiogram SpA, Via Vallosa 38, 25050 Passirano (Brescia) Tel (030) 657 360 Telex 300826 Owner & Mng Dir Edoardo Cattaneo, Gen Mgr.: Francesco Nervi, Sales Execs Italo Capoferri, Romano De Scalzi

Audio: 8 tr., cassette, open reel

Video: 1/2" VHS cassette

Avelca SpA, via Emanuela 16, 21047 Saronno (Varese) Tel: (02) 960.5413/3248 Telex 335884 Mng Dir & Gen Mgr Sergio Moretti

Audio: 8 tr., cassette

Bresolin Corrado, Via XXV Aprile 205, 20092 Cimisello Balsamo (Milan) Tel (02) 618 8064 Pres Corrado Bresolin (Blank only)

Audio: 8 tr., cassette

Diamante, see Start

Duplomatic Srl, Via Pietro Della Valle 20, 20132 Milan Tel (02) 256 4770 Gen Mgr Guido Mezzadra, Sales Mgr Enrico Mezzadra

Audio: Cassette, open reel

Ecofina Srl, Via Leopardi 8, 20123 Milan Tel (02) 869 0121, 806 125 Chief Exec Mourad Sabet **Factory:** Via Monviso 21 Tel (02) 314 766 **Factory Technical Mgr** Ronald F Goodwin (Blank only)

Audio: Cassette

Fraem (Societa Individuale di Gaetani Cesare), Via Niccodemi 5, 20154 Milan Tel: (02) 367 693 Gen Mgr. Cesare Gaetani (Blank only)

Audio: 8 tr., cassette, open reel

PRODUCTION.

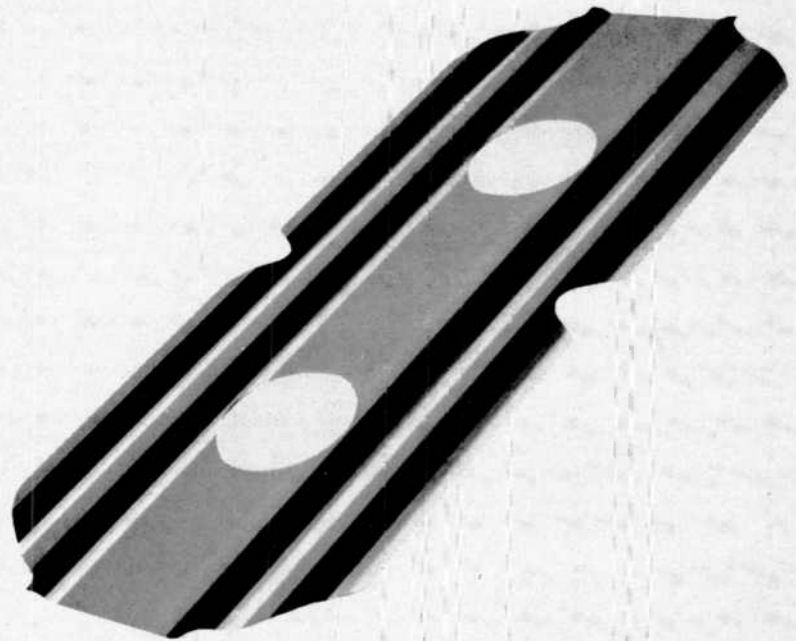

when you
are looking at
the particulars
of technology.



A.T.B. spa
20030 Senago
Milano Italy
30, Palmiro Togliatti
telefono 02 9989976/7/8
TLX 334457 ATIBIX I.

G T E (General Tape Equip.) Srl, Via Ragusa 8, 20125 Milan, Tel: 689 8065 Telex 333046 Gen Mgr: Dttaviano Clerici Bogazzi (Blank only)
Audio: 8-tr., cassette.
 Genca (General Cassette) SaS, Via Don Minzoni 16, 20061 Carugate (Milan) Tel (02) 904-8815 Telex 31371, 37607 (Blank only)
Audio: 8-tr., cassette
 Italyplast SnC, Via Pezzotta 6, Albino (Bergamo) Tel (035) 752.141 Co-Pres Franco Galimberti, Attilio Balduzzi, Giuseppe Mismetti, Mktg Mgr Franco Galimberti, Gen Affairs Mgr Attilio Balduzzi, Technical Mgr, Giuseppe Mismetti
Audio: Cassette
 M D A Cassettes Srl, Via San Giuseppe 137, 21047 Saronno Tel (02) 962-0914 Chief Exec: Roberto Macchi, Gen Mgr Pinuccia Grassi, Sales Mgr Eugenia Maffizoni
Audio: 8 tr., cassette
 Magnex SpA, Via G B Grassi 97, 20157 Milan Tel (02) 355 5146, 357 0946 Cable SELECHIMIT Telex 331269 Pres Dr Luigi Lang, Gen Mgr. Dr. Roberto Sanzone: Plant Mgr., Giorgio Setlun
Audio: Cassette
 Musical Instruments, Via Como 19, 22065 Mariano Comense (Como) Tel (031) 749 212
Audio: Cassette
 Music Box, Via Adua, 25005 Passirano (Brescia) Tel (030) 65 73 68 Gen Mgr Franco Rossetti (Blank only)
Audio: Cassette
 Nuova SIAT (Societa Italiana Articoli Tecnici) Srl, Via dell'Orto 21, 21047 Saronno (Varese) Tel (02) 960 7485/7450 Cable NSIAT Telex 335884 Mng. Dir.: Edoardo Benetton (Blank only)
Audio: 8 tr., cassette
 Polmek Srl, Via Pace 64, 20017 Rho (Milan) Tel: (02) 930 1742/9484 Telex 330501 Chief Exec Rosario Mandina, Gen Mgr Girolamo Magotti (Raw only)
Audio: Cassette
 Racall, see Roje
 Roje Telecomunicazioni SpA, Via Sant'Anatalone 15, 20147 Milan Tel (02) 415.4141 Gen Mgr Ezio Tunesi
Audio: Cassette, open reel
Brand name: Racall
 Scotch, see 3M
 S E C I, see Magnex
 Sonorex Tape SpA, Via Bonfadina 14, 25046 Cazzago San Martino (Brescia) Tel (030) 725 382 Telex 300826 Admin Dir Antonio Magri, Sales Execs I Capoferri, R Descalzi (Raw only)
Audio: 8 tr., cassette, open reel
 Start Inc., Corso Garibaldi 120, 20030 Seveso (Milan), Tel (0362) 508 701, Cable START Telex 312080 Pres: Mario Colombo, Gen Mgr Dario De Benedetti, Sales Mgr Luigi Cane (Blank only)
Audio: Cassette
Brand name: Diamante
 3 M Italia SpA, San Felice Segrate (Milan) Tel: (02) 75 451, Telex 31275, 31159 Mng Dir T S Skoog, Sales & Mktg Mgr G Mariano
Audio: 8 tr., cassette, open reel
Video: 1" open reel, 1" cartridge, 1/4" cassette 1/4" cassette 1/4" EIAJ open reel, 1/4" EIAJ cartridge
Brand name: Scotch

TAPE DUPLICATING & PROCESSING EQUIPMENT

A E G Telefunken SpA, Via Clerici 2, 4, 20099 Sesto S. Giovanni (Milan) Tel (02) 242 7812/8147/9190, 247.1176 Telex 312455 Dept Mgr A Bosco, Sales Mgr G Angeletti
Audio: Duplicators, winders, C D & blank cassette assemblers
Brand name: Telefunken
 Ampex Italiana SpA, Via Riccardo Gigante 4, 00143 Rome Tel (06) 546 991 Cable AMPEX Telex 610492 Mng Dir Riccardo Crippa, Sales Mgr. Dino Grossi
Home office: USA
Audio: Duplicators
 Ducale Ind Musicali SpA, Via Per Cadrezzate 5, 21020 Brebbia (Varese) Tel (0332) 770 784/189 Cable DUCALEMUSIC BREBBIA (VARESE) Telex 380231 Pres & Gen Mgr Davide Matalon (Audio only)
 Fraem (Societa Individuale di Gaetani Cesare), Via Niccodemi 5, 20156 Milan Tel (02) 367 693 Gen Mgr Cesare Gaetani
Audio: Assembling & winding equip
 G T E (General Tape Equip.) Srl, Via Ragusa 8, 20125 Milan Tel 689 8065 Telex 333046 Gen Mgr Dttaviano Clerici Bogazzi
Audio: Automatic semi-automatic & manual tape winders, high speed duplicators, automatic cassette assemblers & automatic cassette screw driver, Ampex compatible slaves
 M D A Srl, Via San Giuseppe 137, 21047 Saronno Tel (02) 962 0914 Chief Exec Roberto Macchi, Gen Mgr Pinuccia Grassi, Sales Mgr Eugenia Maffizoni (Audio only)
Audio: Processing equip
 Magnex SpA, Via G B Grassi 97, 20157 Milan Tel (02) 355 5146 357 0946 Cable SELECHIMIT Telex 331269 Pres Dr Luigi Lang, Gen Mgr Dr Roberto Sanzone Plant Mgr Giorgio Setlun
Audio: Coating & slitting equip
 Roje Telecomunicazioni SpA Via Sant'Anatalone 15 20147 Milan Tel (02) 415 4141 Cable TELERDJE Telex 332202
 Sumat Srl, Via San Giuseppe 137 Saronno (Varese) Tel (02) 962 0915 Gen Mgr Roberto Macchi (Manufacturer/Importer)
Audio: Automatic cassette winders tools
 T T L (Tape Technology Lab) di Rizza Attilio, Via Pirandello 4/A 20144 Milan Tel (02) 469 5213, 498 4371 Pres Attilio Rizza
Audio: Cassette winders
 Tapematic, Via Unione 13, 20050 Mezzago (Milan) Tel (039) 692 359 Telex 340233 Dir Luciano Perego, Technical Mgr Giovanni Brignani
Audio: Tailoring machines w/loaders
 Telefunken, see AEG Telefunken

TAPE PACKAGING & LABELING EQUIPMENT

Comp Ray, see Start
 Ecofina Srl, Via Leopardi 8 20123 Milan Tel (02) 869 0121 806 125 Chief Exec Mourad Sabet, Factory Technical Mgr Ronald F Goodwin
Product: Boxing machines
Brand name: Ponzone & Vico
 G T E (General Tape Equip.) Srl, Via Ragusa 8, 20125 Milan Tel 689 8065 376 4171 Telex 333046
Product: Automatic cassette labeling & boxing machines

I D R A SpA, Via Triumplina 13, 25100 Brescia Tel (030) 30 36 61 39 33 71 Telex 300034 Pres Adamo Pasotti, Sales Mgr Giuseppe Pasotti
Audio: Cassette "shelving" machinery
 M D A Srl, Via San Giuseppe 137, 21047 Saronno Tel (02) 962 0914, Telex 380426 Chief Exec Roberto Macchi, Gen Mgr Pinuccia Grassi, Sales Mgr Eugenia Maffizoni
 Ponzone & Vico, see Ecofina
 S T M (System Transfer Matic), Via Lombardia 20060 Vignate (Milan) Tel (02) 958 0227
Product: Cassette assembly & packaging equip
 Start Inc. Corso Garibaldi 120 20030 Seveso (Milan) Tel (0362) 508 701 Cable START Telex 312080 Pres: Mario Colombo Gen Mgr Dario De Benedetti, Sales Mgr Luigi Cane
 Sumat Srl, Via San Giuseppe 137, 21047 Saronno Tel (02) 962-0915 Gen Mgr Roberto Macchi (Manufacturer/Importer)
Product: Cassette & cartridge plastic shelves pressing machines, boxes pressing machines, cassettes into boxes automatic injectors
 Tapematic Via Unione 13, 20050 Mezzago (Milan) Tel (039) 692 359 Telex 340233 Dir Luciano Perego Technical Mgr Giovanni Brignani (Audio only)
Product: Boxing & labeling machines
 Techno Ray see Start

• accessories

Agfa Gevaert SpA Viale de Gasperi 20151 Milan Tel (02) 307 401 Telex 37182 Chief Exec Benito Chucchini Sales Mgr Giorgio Dordoni, Mktg Giorgio Regoda
Product: Tape-head cleaners demagnetizers leader & splicing tape
 Ampex Italiana SpA, Via Riccardo Gigante 4, 00143 Rome Tel (06) 546 991 Cable AMPEX Telex 610492 Mng Dir Riccardo Crippa Sales Mgr Dino Grossi
Home office: USA
Product: Tape-head cleaners demagnetizers leader & splicing tape
 Audiogram SpA, Via Vallosa 38, 25050 Passirano (Brescia) Tel (030) 657 360 Telex 300826 Dwner & Mng Dir Edoardo Cattaneo, Gen Mgr Francesco Nervi, Sales Execs Italo Capoferri, Romano De Scalzi
Product: Tape-head cleaners, leader tape
 Avelca SpA Via Emanuella 16 21047 Saronno (Varese) Tel (02) 960 5413/ 3248 Telex 335884 Admin'r & Gen Mgr Sergio Moretti
Product: Record-record care prods
 Bresolin Corrado Via XXV Aprile 205, 20092 Cimsello Balsamo (Milan) Tel (02) 618 8064 Pres Corrado Bresolin
Product: Tape-carrying & storage cases, head cleaners, demagnetizers
 Ducale Ind Musicali SpA, Via Per Cadrezzate 5, 21020 Brebbia (Varese) Tel (0332) 770 784/189 Telex 382031 Pres & Gen Mgr Davide Matalon
Product: Tape-leader & splicing tape
 Dupimatic Srl, Via Pietro Della Valle 20 20132 Milan Tel (02) 256 4770 Gen Mgr Guido Mezzadra, Sales Mgr Enrico Mezzadra
Product: Tape-leader & splicing tape
 Dust Jockey see Musica Diffusione
 International Compact Cassette SnC, Via Larga, 25024 Porzano di Leno



CRUBINI
 THE MOST COMPETITIVE
 PRICE IN EUROPE FOR
 LOADED BLANK
 CASSETTES
 ANY LENGTH
 WE CAN OFFER ALSO:
 LIBRARY-BOX
 Via Pezzotta,6 Phone 035/753456
 24021 ALBINO (BERGAMO) - ITALY

ITALYPLAST
 S.N.C.
 THE MOST COMPETITIVE
 PRICE IN EUROPE FOR
 LIBRARY-BOX
 WE CAN OFFER ALSO:
 LOADED BLANK CASSETTES ANY LENGTH
 Via Pezzotta,6 Phone 035/752141
 24021 ALBINO (BERGAMO) - ITALY

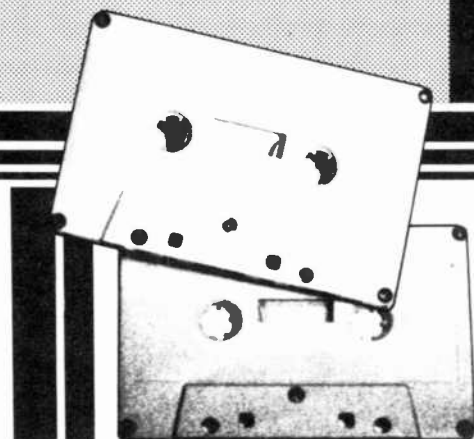

des/renzo maestroni

Brescia Tel (030) 906 484/7196 Telex 301247 Owner Pier Antonio Cavagnoli
Product: Tape—head cleaners, demagnetizers, leader tape
 Italyplast Snc, Via Pezzotta 6, Albino (Bergamo) Tel (035) 752 141 Co
 Pres Franco Galimberti, Attilio Balduzzi, Giuseppe Mismetti, Mktg
 Mgr Franco Galimberti, Gen Affairs Mgr Attilio Balduzzi, Technical
 Mgr Giuseppe Mismetti
Product: Tape—head cleaners, demagnetizers.
 M D A Srl, Via San Giuseppe 137, 21047 Saronno Tel (02) 962 0914
 Telex 380426 Chief Exec. Roberto Macchi, Gen Mgr Pinuccia Grassi,
 Sales Mgr Eugenio Maffizzoni
Product: Tape—head cleaners, demagnetizers, cassette testers, cassette
 tools & moulds, tape certifiers
 M I P (Music Ind. Prod'ns) Srl, Via San Luca 10, Milan Tel (02) 837 0908
 Mng. Dir. Marlene Matalon, Gen Mgr David Matalon, Int'l Mgrs Dan
 iela & Manuela Matalon
Product: Record—carrying & storage cases, Tape—leader tape
 Magnex SpA, Via G B Grassi 97, 20157 Milan Tel (02) 355 5146
 357 0946 Cable SELECHMIT Telex 331269 Pres Dr Luigi Lang,
 Gen Mgr Dr Roberto Sanzone, Plant Mgr Giorgio Serlun
Product: Tape—head cleaners, demagnetizers, leader tape
 Musica Diffusione, Via Del Gambero 30, 00187 Rome
Product: Record—record care prods (Dust Jockey), anti-static turn
 table mat
 New Hobby In Style, Via Gabriele d'Annunzio 15, 20052 Monza Tel (039)
 74.51 02 Cable NEWHOBBOY, Chief Exec. Rosella Sangalli, Gen & Sales
 Mgr Stefano Nocera, Foreign Dept Giancarlo Zanini
Product: Record—carrying & storage cases, record care prods., 45 RPM
 adapters, replacement styli, Tape—carrying & storage cases, head clean
 ers, demagnetizers, splicing tape
 Roje Telecomunicazioni SpA, Via Sant'Anatolone 15, 20147 Milan Tel (02)
 415 4141 Gen Mgr Ezio Tunesi
Product: Tape—leader tape
 S E C I, see Magnex
 Siemens SpA (Societa Italiana Telecomunicazione), Via A Canova 19/A Mi
 lan Tel (02) 43 88 (Importer)
Audio: Record—replacement styli (Stanton)
 Sonorex Tape SpA, Via Bonfadina 14, Cazzago San Martino (Brescia) Tel
 (030) 725 382 Telex 300826 Admin. Dir Antonio Magri, Sales Execs
 I Capoferri, R Descalzi
Product: Tape—head cleaners, demagnetizers, leader tape
 Stanton, see Siemens
 Start Inc., Corso Garibaldi 120, 20030 Seveso (Milan) Tel (0362) 508 701
 Cable START Telex 312080 Pres Mario Colombo Gen Mgr Dario De
 Benedetti, Sales Mgr Luigi Cane
Product: Tape—head cleaners, demagnetizers
 Sumat Srl, Via San Giuseppe 137, 21047 Saronno Tel (02) 962 0915
 Telex 380426 Gen Mgr Roberto Macchi
Product: Tape—head cleaners, demagnetizers
 3 M Italia SpA, San Felice-Segrate (Milan), Tel (02) 75.451 Telex 31275,
 31195 Mng Dir T Skoog, Sales & Mktg Mgr G Mariano
Product: Tape—carrying & storage cases, head cleaners, demagnetizers,
 leader & splicing tape
 Universal Plastics, Via G Di Vittorio 2, Inzago (Milan) Tel (02) 95 40 79 /
 47 55, Telex 321615

Product: Record—storage modules (45 & LP)
 Videosuono di Maurizio Calari, Via Sangallo 30, 20125 Milan Tel (02)
 717 051/351
Product: Record—carrying & storage cases, record care prods., 45 RPM
 adapters, Tape—carrying & storage cases (audio & video), head cleaners
 (audio), bulk erasers (audio), demagnetizers (audio), tape care prods
 (audio)
• store fixtures
 Focchi Display, Via Circonvallazione Ovest 9, 47037 Rimini (Forl) Tel
 (0541) 74 00 55 Telex 550686
Product: Record display racks (Ellepi System)
 New Hobby In Style, Via Gabriele d'Annunzio 15, 20052 Monza Tel (039)
 74 51 02 Cable NEWHOBBOY, Chief Exec. Rosella Sangalli, Gen & Sales
 Mgr Stefano Nocera, Foreign Dept Giancarlo Zanini
Product: Browser boxes, display racks
 Saar Srl, Viale di Porta Vercellina 14, 20123 Milan Tel 469 6251 Pres
 Walter Gurtler, Sales Mgr Sergio Balloni
Product: Browser boxes, display racks

• independent video producers
 The following is a list of Video Production companies that are involved
 in the production and recording of video for concerts, record/artist
 promos and other music related projects. Facilities, equipment, and
 services listed are intended as a brief description only and may not
 necessarily reflect a particular company's full capabilities.
 Inter-TV, Viale Colpidiana 6/A, Milan Tel (02) 837.6951 Owner: E. Regusci
Formats: 2", 1" 1/2"
Facilities: studio—4 studios, 8 broadcast color cams, Ampex 4000 series
 switcher, mobile/portable—3/5 Bosch/Fernseh KCK, Ampex BCC14,
 post-prod'n—2 AVR2 EC2-RES, Chyron IV titling
 Max Mazzanti, 116 Via Archimede, Milan Tel (02) 729 559
Facilities: Studio—2 Aptom cams, Steadicam unit; color monitors, mo
 bile/portable—mobile unit with 4 cameras, VPR1 standard CVTR, PAL
 625, post-prod'n—complete editing facilities
 T V C (Television Videocassettes-Cinema) Srl, Lgo A. Ravizza 16, 00152
 Rome Tel (06) 539 082, 534 9488 Telex 614380 Owners: Bellezza
 Consorti-Loffari, Prod', Leonardo Bellezza
Formats: 2", 1", 1/2", 3/4", 1/4" Beta & VHS, Telecine Rank Cintel
Facilities: Studio—3 Hitachi FP60S cameras, Vinten Tripod, mixer, 2
 chromakeys, mobile/portable—Hitachi FFI020 cam, JVC KY2000, 1/4"
 low band or high band, Sony BVU 1/4" VCR, post-prod'n—SqueeZoom ef
 fects, editing suite, EGS90 convergence, Other—Transcode PAL, NTSC &
 SECAM & vice versa

• playback / recording equipment
 A S C Electronic, see Videosuono

Aloage, see Socofin.
 Ampex Italiana SpA, Via Riccardo Gigante 4, 00143 Rome Tel (06) 546991
 Cable AMPEX RDME, Telex 610492 Mng Dir., Riccardo Crippa, Sales
 Mgr. Domenico Rossi (Audio & Video)
Branch: 20090 Segrate (Milan), Residenza Mestri, Milano 2. Tel. (02)
 213 8181 Telex 321246
 Audio Int'l Srl, Viale Campania 39, 20135 Milan, Tel: (00392) 27.29 51
 Telex 335230 Cable BEPPAMDML. Dir. Roberto Beppato, Sales Mgrs
 G Munato, David Butterworth, Adv. Mgr.: Walter Conti.
Audio: Studer.
 Avelca Srl, V. Emanuela 16, 21047 Saronno Tel: (02) 960.54 13. Telex
 334502. Mng. Dir. & Gen Mgr., Sergio Moretti. (Audio only)
 Crown, see Socofin
 Exhibo Italiana Srl, Via F. Frisi 22, 20052 Monza, Tel: (039) 36.00.21
 Telex 333315 Prod Mgr G Granito, Sales Mgr L Porfirio
Audio: Otari (Japan), Stellavox.
 Grundig Italiana SpA, 38015 Lavis-Trento (Audio only)
 Laboacoustica Srl, Via Luigi Settembrini 9, 00195 Rome Tel (06)
 35.55.06., 38.19.65
Audio: Nagra.
 Linear Italiana SpA, Via Arbe 50, 20125 Milan
Audio: Teac (Japan)
 M C I, see Roje.
 Magnetofoni Castellini, see Remco
 Mincom Wollensak, see 3M.
 Nagra, see Laboacoustica
 Otari, see Exhibo Italiana
 Philips SpA Sistemi Audio Video, Viale F. Testi 327, 20162 Milan, Tel 64.45.
 (Audio & Video)
 Remco Italiana SpA, 20060 San Pedrino di Vignate Tel (02) 956041.
Audio: Magnetofoni Castellini, Remco
 Roje Telecomunicazioni SpA, Via Sant'Anatolone 15, 20147 Milan, Tel (02)
 415.41.41. Telex: 332202 Co-Pres., Camillo Roje, Ezio Tunesi, Sales
 Mgr Alberto Albertini.
Audio: MCI (USA).
 Siemens (Societa Italiana Telecomunicazioni) SpA, Piazzale Zavattari 12,
 20149 Milan Tel: (02) 43.88. (Audio only).
 Socofin Snc, Sala dei Longobardi 2, 20121 Milan Tel (02) 345.22.41
 Telex: 333814, Mng. Dir.: V.I. Totah; Sales & Adv Mgr.: R Totah
Audio: Alpage, Tecsonic.
 Stellavox, see Exhibo Italiana
 Studer Italiana, Via G. Spontini 3, 20131 Milan, Tel (02) 228.120, Cable
 BEPPATOMIL, Telex 32402 Gen Mgrs - Roberto Beppato, Walter Conti,
 Sales Mgr David Butterworth.
Audio: Studer (Switzerland)
 Teac, see Linear
 Tecsonic, see Socofin.
 3 M Italia SpA, Milano San Felice (Segrate), Tel: (02) 75 451 Telex: 31275,
 31159, Mng. Dir.: T Skoog, Sales & Mktg Mgr M Bianchi.
Audio: Mincom-Wollensak (USA)
 Videosuono di Maurizio Calari, Via Sangallo 30, 20125 Milan, Tel (02)
 71 50 51/73 51 Dir & Sales Mgr. Maurizio Calari; Adv Mgr Roberto
 Falsroli.
Audio: ASC Electronic.

FOR ALL YOUR NEEDS
 OF **MUSIC
 INDUSTRY
 PRODUCTS**
 CONTACT US

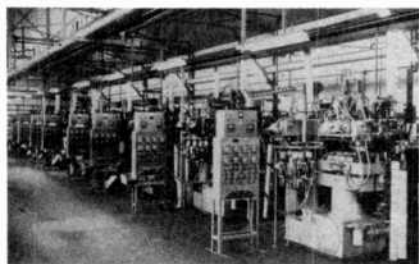

LENED AUTOMATIC PRESSES
 FOR 7" & 12" RECORDS

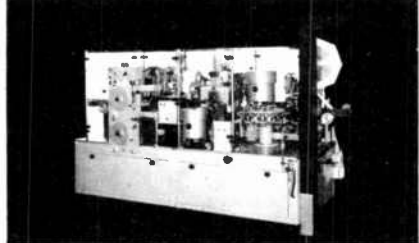

GIMA MU-7
 AUTOMATIC ASSEMBLING
 OF C-O CASSETTES

FROM
 ITALY
 THE
**DAVIDE
 MATALON
 GROUP**
 FOR
 THE
**WORLD
 OF
 MUSIC**



OFFICES & FACTORY
 DUCALE SpA Industrie Musicali
 Via per Cadrezzate, 5
 21020 BREBBIA (Varese) Italy
 Telefon: (0332) 770189 770784
 Telex 380231 Ducale I

OUR LABELS



Japan

• services

DESIGN & ARTWORK

Japan Muscolor Co. Ltd., Higashi-Ueno 6-19-17, Dartho ku, Tokyo 110 Tel (03) 845-3231. Telex 23419 Pres. Yoshio Tamura, Gen Mgr. Shigehiro Ashida. (Record only)

Nippon Columbia Co. Ltd., 4-14-14 Akasaka, Minato-ku, Tokyo 107 Tel (03) 584-8111. Cable: NIPPONCOLUMBIA. Telex: 22591. Pres.: Takami Shobochi. Dir.: Mitsugu Kumamoto

P C C (KK), Shibuya Central Bldg., 5F, 3-14 Udagawa-cho, Shibuya ku, Tokyo Tel: (03) 464-6045

Spirit Ent. Inc., Kojimachi Royal Bldg., 4-7 Kojimachi, Chiyoda-ku, Tokyo 102 Tel: (03) 230-1611. Cable: SPIRITENTER. Telex: 23419. Chief Exec.: Akio Tamura

Teichiku Recs. Co. Ltd., 1-2 Nishi-Shimbashi, Minato-ku, Tokyo 105 Tel: (03) 502-7213. Cable: TEICHIKU. Telex: (02) 224237 Pres. Shigeji Nanko. Gen Mgr. Ichiro Kinoue, Sales Mgr. Minoru Ozaki.

Toyo Kasei Co. Ltd., 2-5-5 Hirakawa-cho, Chiyoda-ku, Tokyo 102 Tel: (03) 264-3041. (Record only)

PRINTERS & LITHOGRAPHERS

Japan Muscolor Co. Ltd., Higashi-Ueno 6-19-17, Dartho ku, Tokyo 110 Tel (03) 845-3231. Telex 23419. Pres. Yoshio Tamura, Gen Mgr. Shigehiro Ashida. (Record only)

Nippon Columbia Co. Ltd., 4-14-14 Akasaka, Minato-ku, Tokyo 107 Tel (03) 584-8111. Cable: NIPPONCOLUMBIA. Telex: 22591. Pres.: Takami Shobochi. Dir.: Mitsugu Kumamoto

Spirit Ent. Inc., Kojimachi Royal Bldg., 4-7 Kojimachi, Chiyoda-ku, Tokyo 102 Tel: (03) 230-1611. Telex 23419. Chief Exec.: Akio Tamura (Tape only)

Teichiku Recs. Co. Ltd., 1-2 Nishi-Shimbashi, Minato-ku, Tokyo 105 Tel: (03) 502-7213. Cable: TEICHIKU. Telex: (02) 224237 Pres. Shigeji Nanko. Gen Mgr. Ichiro Kinoue, Sales Mgr. Minoru Ozaki.

Toyo Kasei Co. Ltd., 2-5-5 Hirakawa-cho, Chiyoda-ku, Tokyo 102 Tel: (03) 264-3041. (Record only)

TAPE CUSTOM DUPLICATORS

TAPE PACKAGING & LABELING

The Audio & Video lines indicate the configurations which the firms duplicate. Companies which offer packaging and labeling of tape product are indicated by: "(PKG)" which appears after the main body of their respective listings.

Apollo Music Ind'l Corp., 1-5 Wakaba-cho, Shinjuku-ku, Tokyo 160 Tel: (03) 353-0191.

C B S/Sony Recs Inc., 1561-2 Aikawa, Ohigawa-cho, Shida gun, Shizuoka ken 421-02. Tel: (05462) 2-1321. Cable: CBSSONY. Pres. Toshio Ozawa. Gen Mgr.: Tokio Sasaki. Audio: 8-tr., cassette.

Eastern Sun Ent. Co. Ltd., Hirasawa Bldg., 34 Motohira-cho, Shiba, Minato ku, Tokyo 105. Tel: (03) 501-0344. Cable: EMPSUNMUSERV. Audio: 8-tr., 8-tr. quadraphonic, cassette, open reel.

Nippon Columbia Co. Ltd., 4-14-14 Akasaka, Minato ku, Tokyo 107 Tel: (03) 584-8111. Cable: NIPPONCOLUMBIA. Telex: 22591. Pres.: Takami Shobochi, Dir.: Mitsugu Kumamoto. (PKG-audio)

PolyGram Rec. Servs. KK, 1000 Kamsukihara, Showa-cho, Yamanashi pref 409-38 Tel: (055275) 44-11. Pres: J. Dieter Bliersbach, VP. Takao Yanagimoto. Audio: Cassette

Spirit Ent. Inc., Kojimachi Royal Bldg., 4-7 Kojimachi, Chiyoda-ku, Tokyo 102 Tel: (03) 230-1611. Cable: SPIRITENTER. Telex: 23419. Chief Exec.: Akio Tamura (PKG-video only)

Audio: Open reel. Video: 2" quad, 1" open reel, 1/4" U-matic cassette, 1/2" Beta & VHS cassette

T B S Serv. Co. Ltd., 5-3-50 Akasaka, Minato ku, Tokyo 107 Tel: (03) 584-7351. Audio: 8-tr., cassette. Video: 1" open reel

T D K Electronics Co. Ltd., 1-13-1 Nihonbashi, Chuo-ku, Tokyo 103 Tel: (03) 278-5111. Cable: TDKCORE. Pres. Fukujiro Sono; Gen. Mgr.: Shohachi Okiyama

Audio: 8-tr., cassette, open reel. Video: 1/2" U-matic cassette, 1/2" VHS & Beta cassette

Teichiku Recs. Co. Ltd., 1-2 Nishi-Shimbashi, Minato-ku, Tokyo 105 Tel: (03) 502-7213. Cable: TEICHIKU. Telex: (02) 224237. Pres.: Shigeji Nanko. Gen Mgr. Ichiro Kinoue, Sales Mgr. Minoru Ozaki, (PKG)

Victor Co. of Japan Ltd., 4-1 Nihonbashi-Honcho, Chuo-ku, Tokyo 103 Tel: (03) 241-7811. Cable: VICTOREXPOR. Telex: 26222. Int'l subsidiaries: Canada, England, France, Germany, Singapore, USA (all JVC).

Audio: Cassette (standard & metal), open reel. Video: 1/4" U-matic cassette, 1/2" VHS cassette.

• supplies

CARTRIDGE & CASSETTE PARTS

Magnadyne Corp., Royal Higashi Azabu Bldg., 2-23 Higashi Azabu, Minato-ku, Tokyo 106 Tel: (03) 583-8335. Home office: USA.

EMPTY CARTRIDGES, CASSETTES & REELS

Magnadyne Corp., Royal Higashi Azabu Bldg., 2-23 Higashi Azabu, Minato-ku, Tokyo 106 Tel: (03) 583-8335. Home office: USA. Audio: 8-tr.

Sony Corp., PO Box 10, Airport PO, Tokyo 149, 6-7-35 Kita-Shinagawa, Shinagawa-ku, Tokyo 141 Tel: (03) 448-2111. Cable: SONYCORP. Telex: 22262, 24666

Int'l branches: Brazil, Canada, England, Germany, Greece, Hong Kong, Panama, Singapore, South Africa, Switzerland, USA. Audio & Video: Reels

PROFESSIONAL TAPE SUPPLIES

B A S F Japan Ltd., Tozan Bldg., 4-9 Nihonbashi-Honcho, Chuo-ku, Tokyo 103. Tel: (03) 270-1461. Telex: 2222130. Pres. Dr. Cantzler; Gen. Mgr.: H. Kreuels; Sales Mgr. K. Suzuki. Audio: D.I.N. calibration tapes.

Namiki Precision Jewel Co. Ltd., 3-8-22 Adachi-ku, Tokyo 123 Tel: (03) 919-0101. Int'l branch: USA.

Product: Magnetic tape heads. Victor Co. of Japan Ltd., 4-1 Nihonbashi-Honcho, Chuo-ku, Tokyo 103. Tel: (03) 241-7811. Cable: VICTOREXPOR. Telex: 26222. Int'l subsidiaries: Canada, England, France, Germany, Singapore, USA (all JVC).

Audio: Test tape, heads, splicing & editing equip. Brand name: JVC.

TAPE, BLANK LOADED & RAW

Ampex Japan Ltd., New Belle Mode Bldg., 3-3 Kojimachi, Chiyoda ku, Tokyo 102. Tel: (03) 264-7331. Cable: VIDEOTAPE. Audio: 2", 1", cassette, open reel. Video: 2", 1", 1/2", 1/4", 1/8" Beta & VHS.

B A S F Japan Ltd., Tozan Bldg., 4-9 Nihonbashi-Honcho, Chuo ku, Tokyo 103 Tel: (03) 270-1461. Telex: 2222130. Pres. Dr. Cantzler; Gen. Mgr. H. Kreuels; Sales Mgr. K. Suzuki. Audio: Cassette, open reel. Video: Blank-1" open reel, 1/4" U-matic cassette, 1/2" cassette reel, raw-1/4" U-matic cassette

Fuji Photo Film Co. Ltd., 2-26-30, Nishi-Azabu, Minato-ku, Tokyo 106. Tel: (03) 406-2409. Cable: FUJIFILM. Telex: 24306. Pres. Minoru Ohnishi; Sales Mgrs. Juntaro Suzuki, Hiroshi Ashizawa. (Blank only)

Int'l branches: Australia, Brazil, Canada, England, Germany, Hong Kong, Korea, Philippines, Singapore, Taiwan, Thailand, USA. Audio: Cassette. Video: 2" quad, 1" open reel, 1/4" U-matic cassette, 1/2" Beta & VHS cassette.

Hitachi Maxell Ltd., Ginza Toho Seimei Bldg., 3-3-1 Ginza Chuo-ku, Tokyo 104. Tel: (03) 567-6221. Cable: MAXELLELEC. Telex: 26391. Int'l Dept. Dir. Ken Kakurai; Sales Mgr. Tom Inoue. Ass't Sales Mgr. Bob Fujiwara. (Blank only)

Int'l branches: Germany, Hong Kong, Kuwait, Singapore, USA. Audio: 8-tr., cassette, open reel. Video: 1/4" U-matic cassette, 1/2" Beta & VHS cassette. Brand name: Maxell

J V C, see Victor. Magnadyne Corp., Royal Higashi Azabu Bldg., 2-23 Higashi Azabu, Minato-ku, Tokyo 106. Tel: (03) 583-8335. (Blank only). Home office: USA. Audio: 8-tr.

Matsushita Electric Ind'l Co. Ltd., 1006 Oaza Kadoma, Kadoma-city, Osaka 571. Tel: (06) 908-1121. Cable: MATSUDEN MORIGUCHI. Telex: 63426. Pres.: Toshihiko Yamashita. (Blank only)

Int'l branches: Germany, USA. Audio: Cassette, open reel. Video: 1/4" U-matic cassette, 1/2" EIAJ open reel, 1/2" EIAJ cartridge, 1/2" VHS cassette, 1/2" VX. Brand names: National/Panasonic, Technics

Maxell, see Hitachi. National/Panasonic, see Matsushita. Nippon Columbia Co. Ltd., 4-14-14 Akasaka, Minato-ku, Tokyo 107. Tel:

(03) 584-8111. Cable: NIPPONCOLUMBIA. Telex: 22591. Pres.: Takami Shobochi. Dir.: Mitsugu Kumamoto. Audio: Cassette, open reel. Video: Blank-Open reel, 1/4" U-matic cassette, 1/2" cassette, raw-1/4" U-matic cassette.

Quasar, see Matsushita. Scotch, see Sumotomo. Sony Corp., PO Box 10, Airport PO, Tokyo 149, 6-7-35 Kita-Shinagawa, Shinagawa-ku, Tokyo 141. Tel: (03) 448-2111. Cable: SONYCORP. Telex: 22262, 24666. (Blank only)

Int'l branches: Brazil, Canada, England, Germany, Greece, Hong Kong, Panama, Singapore, South Africa, Switzerland, USA. Audio: 8-tr., cassette, open reel. Video: 1" open reel, 1/4" cassette, 1/2" EIAJ open reel, 1/2" Beta cassette.

Sumotomo 3M Co. Ltd., 3M Bldg., 2-33-1 Tamagawa-dai, Setagaya-ku, Tokyo 158. Tel: (03) 709-8480. Audio: Blank-2", 1" & 1/2" open reel, raw-8-tr. Video: Blank-2" & 1" open reel, 1/4" cassette, 1/2" Beta & VHS cassette. Brand name: Scotch.

T O K Electronics Co. Ltd., 1-13-1 Nihonbashi, Chuo-ku, Tokyo 103. Tel: (03) 278-5111. Cable: TDKCORE. Pres.: Fukujiro Sono, Gen. Mgr.: Shohachi Okiyama

Int'l branches: Germany, UK, USA. Audio: 8-tr., cassette, open reel. Video: 1/4" U-matic cassette, 1/2" VHS & Beta cassette.

Technics, see Matsushita. Victor Co. of Japan Ltd., 4-1 Nihonbashi-Honcho, Chuo-ku, Tokyo 103. Tel: (03) 241-7811. Cable: VICTOREXPOR. Telex: 26222. (Blank only)

Int'l subsidiaries: Canada, England, France, Germany, Singapore, USA (all JVC). Audio: Cassette. Video: 1/4" U-matic cassette, 1/2" VHS cassette. Brand name: JVC.

TAPE DUPLICATING & PROCESSING EQUIPMENT. Magnadyne Corp., Royal Higashi Azabu Bldg., 2-23 Higashi Azabu, Minato-ku, Tokyo 106. Tel: (03) 583-8335. Home office: USA.

Audio: 8-tr. duplicating equip. Matsushita Electric Ind'l Co. Ltd., 1006 Oaza Kadoma, Kadoma-city, Osaka 571. Tel: (06) 908-1121. Cable: MATSUDEN MORIGUCHI. Telex: 63426. Pres. Toshihiko Yamashita. Int'l branches: Germany, USA.

Video: Duplicators. Brand name: National/Panasonic. Otari Electric Co. Ltd., 4-29-18 Minami Ogikubo, Sugnami-ku, Tokyo 167. Tel: (03) 333-9631. Cable: OTARIDENKI. Telex: 26604. Pres.: Masayuki Hosoda; Sales & Adv. Mgr. Takao Aoki.

Audio: High speed tape duplicators (8x, 16x, 32x, 64x), tape winders. Video: Tape winders. Sony Corp., PO Box 10, Airport PO, Tokyo 149, 6-7-35 Kita-Shinagawa, Shinagawa-ku, Tokyo 141. Tel: (03) 448-2111. Cable: SONYCORP. Telex: 22262, 24666.

Int'l branches: Brazil, Canada, England, Germany, Greece, Hong Kong, Panama, Singapore, South Africa, Switzerland, USA. Audio & Video: Duplicators.

• accessories. Akai Electric Co. Ltd., 2-12-14 Higashi-Kojima, Ohta-ku, Tokyo 144. Tel: (03) 742-5111. Product: Tape-head cleaners, demagnetizers.

Ampex Japan Ltd., New Belle Mode Bldg., 3-3 Kojimachi, Chiyoda-ku, Tokyo 102. Tel: (03) 264-7331. Cable: VIDEOTAPE. Product: Tape-carrying & storage cases, head cleaners, bulk erasers, demagnetizers, leader tape, splicing tape & equip. (all audio & video)

Clarion Co. Ltd., 1-22-10 Dogenzaka, Shibuya-ku, Tokyo 150. Tel: (03) 463-6161. Int'l branches: Germany, Hong Kong, USA. Product: Carrying & storage cases.

Hitachi Maxell Ltd., Ginza Toho Seimei Bldg., 3-3-1 Ginza Chuo-ku, Tokyo 104. Tel: (03) 567-6221. Cable: MAXELLELEC. Int'l Dept. Dir.: Ken Kakurai; Sales Mgr.: Tom Inoue; Ass't Sales Mgr.: Bob Fujiwara. Int'l branches: Germany, Hong Kong, Kuwait, Singapore, USA. Product: Tape-cassette head cleaners (audio & video).

Magnadyne Corp., Royal Higashi Azabu Bldg., 2-23 Higashi Azabu, Minato-ku, Tokyo 106. Tel: (03) 583-8335. Home office: USA. Product: Record-record care prod., Tape-storage cases, splicing tape.

Nagaoaka Seiki, 3-16-3 Kita-Otsuka, Toshima-ku, Tokyo 170. Product: Record-replacement styl. Namiki Precision Jewel Co. Ltd., 3-8-22 Adachi-ku, Tokyo 123. Tel: (03) 919-0101.

Int'l branch: USA. Product: Record-replacement styl. Nippon Chikusin, 3-9-35 Tozuka-cho, Shinjuku-ku, Tokyo 160. Product: Record-replacement styl.

Nippon Columbia Co. Ltd., 4-14-14 Akasaka, Minato-ku, Tokyo 107. Tel: (03) 584-8111. Cable: NIPPONCOLUMBIA. Telex: 22591. Pres.: Takami Shobochi; Dir.: Mitsugu Kumamoto. Product: Tape-demagnetizers.

Ogura Jewell Ind. Co. Ltd., 5-7-12 Omori Kita, Ohta-ku, Tokyo 143. Tel: (03) 763-3111. Tel: (03) 02466048. Product: Record-replacement styl.

Sharp Corp., 2-22-22 Nagaike-cho, Abeno-ku, Osaka 545. Tel: (06) 621-1221. Cable: LABOMET. Sony Corp., PO Box 10, Airport PO, Tokyo 149, 6-7-35 Kita-Shinagawa, Shinagawa-ku, Tokyo 141. Tel: (03) 448-2111. Cable: SONYCORP. Telex: 22262, 24666.

Int'l branches: Brazil, Canada, England, Germany, Greece, Hong Kong, Panama, Singapore, South Africa, Switzerland, USA. Product: Record-replacement styl; Tape-head cleaners, demagnetizers, splicing tape.

Sumotomo 3M Co. Ltd., 3M Bldg., 2-33-1 Tamagawa-dai, Setagaya-ku, Tokyo 158. Tel: (03) 709-8480. Product: Tape-leader & splicing tape.

T D K Electronics Co. Ltd., 1-13-1 Nihonbashi, Chuo-ku, Tokyo 103. Tel: (03) 278-5111. Cable: TDKCORE. Pres.: Fukujiro Sono; Gen. Mgr.: Shohachi Okiyama

Int'l branches: Germany, UK, USA. Product: Tape-head cleaners, demagnetizers, leader & splicing tape. Tamradio, see Tamura.

Tamura Sesausho Co. Ltd., Han-Ei Daichi Bldg., 1-10-3 Shinjuku, Shinjuku-ku, Tokyo 166. Tel: (03) 356-7211. Product: Tape-bulk erasers (audio).



USO Doesn't Play Around

USO is a champion. Every day they bring a little bit of home to our servicemen and women who are away from home.

Wes Unseld

There's a group that helps our servicemen and women climb out of their feelings of depression and loneliness — the USO and its 40,000 volunteers are always there.

Sugar Ray Leonard

The USO — helping the service person feel a part of his surroundings.

Carl Eller

The USO. They're at over 145 locations worldwide helping our servicemen and women when there's a problem, an emergency or just some spare time and nothing to do.

Rod Carew

Support USO through the United Way OCFC or local USO campaign

Teac Corp., 3-7-3 Naka-cho, Musashino-shi, Tokyo 180. Tel: (0422) 53-1111. Cable: TEAC MITAKA. Telex: 2822551. Pres.: Noboru Yanase; Audio Div. Gen. Mgr.: Yukio Koide; Int'l Dept. Gen. Mgr.: Masao Morita
 Int'l branches: Australia, USA.
 Product: Tape-carrying & storage cases, head cleaners, bulk erasers, demagnetizers (all audio).
 Victor Co. of Japan Ltd., 4-1 Nihonbashi-Honcho, Chuo-ku, Tokyo 103. Tel: (03) 241-7811. Cable: VICTOREXPORT. Telex: 26222
 Int'l subsidiaries: Canada, England, France, Germany, Singapore, USA.
 Product: Record-replacement styl.

• playback/recording equipment

Aiwa Co. Ltd., 1-11-9 Ueno, Taiho-ku, Tokyo 110. Tel: (03) 835-1201. Cable ELCTAIWA. Telex: 24562. Pres.: Yusuke Sambe; Sales Mgr.: H. Tsuchida; Adv. Mgr.: J. Fujii. (Audio only)
 Ampex Japan Ltd., New Belle Mode Bldg., 3 Kojimachi, 3-chome, Chiyoda-ku, Tokyo 102. Tel: (03) 264-7331. Cable: VIDEOTAPE.
 Denon, see Nippon Columbia.
 J V C, see Victor
 Lux Corp., 1-1-1 Shinrenri-Nishimachi, Toyonaka, Osaka. Tel: (06) 834-0004. Pres.: H. Hayakawa. (Audio only)
 Matsushita Electric Ind'l Co. Ltd., PO Box 51, Osaka Central; 1006 Oaza Kadoma, Kadoma City, Osaka 571. Tel: (06) 908-1121. Cable: MATSUDEN MORIGUCHI. Telex: 63426. Pres.: Toshihiko Yamashita.
 Int'l branches: Germany, USA.
 Audio: Technics.
 Video: National, Panasonic.
 National, see Matsushita.
 Nippon Columbia Co. Ltd., 4-14-14 Akasaka, Minato-ku, Tokyo 107. Tel: (03) 584-8111. Telex: 22591. Pres.: Takami Shobochi; Sales Mgr.: S. Wake.
 Audio: Denon.
 Otari Electric Co. Ltd., 4-29-18 Minami Ogikubo, Suginami-ku, Tokyo 167. Tel: (03) 333-9631. Cable: OTARIDENKI. Telex: 26604. Pres.: Masayuki Hosoda; Sales & Adv. Mgr.: Takao Aoki. (Audio only)
 Panasonic, see Matsushita.
 Sansui Electric Co. Ltd., 2-14-1 Izumi, Suginami-ku, Tokyo 168. Tel: (03) 323-1111. (Audio only)
 Int'l branches: Belgium, USA.
 Sony Corp., 6-7-35 Kitashinagawa, Shinagawa-ku, Tokyo 141. Tel: (03) 448-2111. Cable: SONYCORP. Telex: 22262, 24666. (Audio & Video)
 Int'l branches: Brazil, Canada, England, Germany, Greece, Hong Kong, Panama, Singapore, South Africa, Switzerland, USA.
 Tascam, see Teac.
 Teac Corp., 3-7-3 Naka-cho, Musashino-shi, Tokyo 180. Tel: (0422) 53-1111. Cable: TEAC MITAKA. Telex: 2822551. Pres.: Noboru Yanase, Sales Mgr.: Masao Morita.
 Int'l branches: Australia, USA.
 Audio: Tascam, Teac.
 Video: Teac.
 Technics, see Matsushita.
 Victor Co. of Japan Ltd., 4-1, Nihonbashi-Honcho, Chuo-ku, Tokyo 103. Tel: (03) 241-7811. Cable: VICTOREXPORT. Telex: 26222. Pres.: Ichiro Shinji; Gen. Mgr.: F. Uchida; Adv. Mgr.: T. Kikuchi.
 Int'l subsidiaries: Canada, England, France, Germany, Singapore, USA.

Mexico

• services

DESIGN & ARTWORK

C B S/Columbia Int'l SA, Av. 16 de Septiembre 784, Naucalpan. Tel: (905) 576-0333. Pres.: Jose Manuel Villareal P.; VP & Gen. Dir.: Armando de Llano Arana.
 Centro Musical de Tijuana SA, PO Box 292, San Ysidro, Calif. 90273, USA; 917 Constitucion Ave., Tijuana, B.C. Tel: (706) 685-1322. Pres.: Luis B. Alonso; VP: Tessa Alonso; Sales Mgr.: Manuel Magdaleno C.
 Coro SA, Bahía de Perula 80, Mexico 10, D.F. Tel: (905) 531-2900. Pres. & Gen. Mgr.: Federico E. Rhojas; Sales Mgr.: Gloria Escobar.
 Fabricaciones Fonograficas SA, Nubia No. 40, Isidro Fabela S/N Parque Ind. Santiago Tanquistengo, Mexico 16, D.F. Gen. Mgr.: Javier Franco
 Laminados & Acabados Especiales SA, Olivar 27, Colonia Alfonso XIII, Mexico 19, D.F. Tel: (905) 563-9625.
 Mexicanos SA (Discos)/Orfeon Videovox SA, Alice Blanco 26, San Bartolo, Naucalpan. Tel: (905) 576-1500.
 Musart SA (Discos), Av. Cuiclahuac 2335, Mexico 16, D.F. Tel: (905) 399-2332. Cable: MUSART. Pres.: Eduardo L. Baptista; VP: Andreas Baptista; Gen. Mgr.: Eduardo A. Baptista; Sales Mgr.: Francisco Llopis.
 Promofon SA (Promotora Fonografica), Calle Colima 25-B, Mexico 7, D.F. Tel: (905) 514-7941. Owner: Gabriel Gonzalez de la O.; Gen. Mgr.: Guillermina Lozano.
 R C A SA de CV, Av. Cuiclahuac 2519, Col. Xochimanca, Mexico 16, D.F. Tel: (905) 527-6020.
 Sonomedios SA, Av. Vallarta 2590, Guadalajara, Jal. Tel: (9136) 16-56-10. (Record only)

PRINTERS & LITHOGRAPHERS

C B S/Columbia Int'l SA, Av. 16 de Septiembre 784, Naucalpan. Tel: (905) 576-0333. Pres.: Jose Manuel Villareal P.; VP & Gen. Dir.: Armando de Llano Arana.
 Coro SA, Bahía de Perula 80, Mexico 10, D.F. Tel: (905) 531-2900. Pres. & Gen. Mgr.: Federico E. Rhojas; Sales Mgr.: Gloria Escobar.
 Fabricaciones Fonograficas SA, Nubia No. 40, Isidro Fabela S/N Parque Ind. Santiago Tanquistengo, Mexico 16, D.F. Gen. Mgr.: Javier Franco.
 Guitarra SA (Discos), Nilo No. 50, Mexico 16, D.F. Tel: (905) 527-9163. Dir.: Luis Alberto San Martin; Sales Mgr.: Carlos Levi
 I M Ed. SA, Sanctorum 86, Mexico 17, D.F.
 Laminados & Acabados Especiales SA, Olivar 27, Colonia Alfonso XIII, Mexico 19, D.F. Tel: (905) 563-9625.
 Mexicanos SA (Discos)/Orfeon Videovox SA, Alice Blanco 26, San Bartolo, Naucalpan. Tel: (905) 576-1500.
 Musart SA (Discos), Av. Cuiclahuac 2335, Mexico 16, D.F. Tel: (905) 399-2332. Cable: MUSART. Pres.: Eduardo L. Baptista, VP: Andres Baptista;

Gen. Mgr.: Eduardo A. Baptista; Sales Mgr.: Francisco Llopis. (Record only)
 Peerless SA (Fabrica de Discos), Laguna de Mayran 232, Mexico 17, D.F. Tel: (905) 531-3320, 545-7215. Telex: (017) 77606. Exec. Pres.: Heinz Minckwort; Gen. Dir.: Peter Ulrich; Gen. Mgr.: Juergen Ulrich; Commercial Mgr.: Reinhard Kruska; Int'l Dir.: Frank J.P. Segura.
 R C A SA de CV, Av. Cuiclahuac 2519, Col. Xochimanca, Mexico 16, D.F. Tel: (905) 527-6020. (Record only)
 Stereo Jet de Mexico SA, Calle Dos 13-B, Naucalpan. Tel: (905) 576-6866. (Tape only)

TAPE CUSTOM DUPLICATORS TAPE PACKAGING & LABELING

The Audio and Video lines indicate the configurations which the firms duplicate. Companies which offer packaging and labeling of tape product are indicated by: "PKG" which appears after the main body of their respective listings.

A V Sistemas SA, Saltillo No. 90, Mexico 11, D.F. Tel: (905) 515-0918, 562-7972. Pres.: Eduardo Serrato B.; Gen. Mgr.: Adolfo de la Muerta S.; Sales Mgr.: Sergio Martinez M.; Technical Dir.: David Baisht L. (PKG)
 Audio: Cassette.
 C B S/Columbia Int'l SA, Av. 16 de Septiembre 784, Naucalpan. Tel: (905) 576-0333. Pres.: Jose Manuel Villareal P.; VP & Gen. Dir.: Armando de Llano Arana. (PKG)
 Audio: 8-tr., cassette.

Coro SA, Bahía de Perula 80, Mexico 10, D.F. Tel: (905) 531-2900. Pres. & Gen. Mgr.: Federico E. Rhojas; Sales Mgr.: Gloria Escobar.
 Audio: 8-tr., cassette.
 Duplicaset SA, Jose Vasconcelos 218, Mexico 11, D.F. Tel: 553-12-06, 286-14-97. Gen. Mgr.: Roberto J. Benitez; Maintenance Eng.: Gustavo Castellano B.
 Audio: 8-tr., cassette, open reel.
 E M I-Capitol de Mexico SA de CV, Rio Balsas 49, Mexico 5, D.F. Tel: (905) 525-1700. Cable: CAPRECORD. Telex: (017) 77406. Pres.: Roberto D. Lo-

USO and JOSE FELICIANO

Adjusting to a new culture and language can be hard work, as you well know. But did you know about my amigos at the USO? They're there to help. USO has orientation tours, travel assistance, intercultural understanding programs, recreation and much more.

Support USO through the United Way, OCF, or local USO Campaign

C-O CASSETTES & HEAD CLEANERS

SUPER HIGH QUALITY - TABS
IN OR TABS OUT - ANY
QUANTITY



SUMMIT MAGNETICS LIMITED
E Tat Factory Building, 21st Fl.,
Heung Yip Road, Wong Chuk Hang,
Aberdeen. Hong Kong.
Telex: 76264 SMTAP HX

pez Prado; Sales Mgr.: Salvador Esparza Barrera, Mfg. Dir.: Arturo Quiroz Ramirez; Rec'g Dir.: Roberto F. Figueroa.
Audio: 8-tr., cassette.
 Laminados & Acabados Especiales SA, Olivar 27, Colonia Alfonso XIII, Mexico 19, D.F. Tel: (905) 563-9625.
Audio: Cassette.
 Matrices SA (Discos), Lago Chalco 122, Mexico 17, D.F. Tel: (05) 250-1499.
 Cable: MELMEX.
 Campero.
Audio: 8-tr., cassette.
 Mexicanos SA (Discos)/Orleon Videovox SA, Alce Blanco 26, San Bartolo, Naucalpan. Tel: (905) 576-1500.
Audio: 8-tr., cassette, open reel.
 Multitrack SA, Nubia No. 40, Isidro Fabela S/N Parque Ind. Santiago Tanqustengo, Mexico 16, D.F. Gen. Mgr.: Olga San Martin.
Audio: Cassette.
 Musart SA (Discos), Av. Cuiclahuac 2335, Mexico 16, D.F. Tel: (905) 399-2332. Cable: MUSART. Pres.: Eduardo L. Baptista; VP: Andres Baptista; Gen Mgr. Eduardo A. Baptista, Sales Mgr.: Francisco Llopis. (PKG)
Audio: Cassette, open reel.
 Peerless SA (Fabrica de Discos), Laguna de Mayran 232, Mexico 17, D.F. Tel: (905) 531-3320, 545-7215. Telex: (017) 77606. Exec. Pres. Heinz Klinkworth; Gen. Dir. Peter Ulrich; Gen. Mgr.: Juergen Ulrich; Commercial Mgr.: Reinhard Kruska; Int'l Dir.: Frank J.P. Segura.
Audio: 8-tr., cassette.
 Promofon SA (Promotora Fonografica), Calle Colima 25 B, Mexico 7, D.F. Tel: (905) 514-7941, 521-8741. Owner: Gabriel Gonzalez de la O.; Gen. Mgr.: D. Guillermina Lozano.
Audio: Cassette.
 Sonomedios SA, Av. Vallarta 2590, Guadalajara, Jal. Tel: (9136) 16-56 10
Audio: Cassette, open reel.
 Sovi SA, Arquimedes 98, Mexico 5, D.F. Tel: (905) 250 6000/6200
Audio: 8-tr., cassette, open reel.
 Stereo Jet de Mexico SA, Calle Dos 13-B, Naucalpan. Tel: (905) 576-6866.
Audio: 8-tr., cassette, open reel

• supplies

CARTRIDGE & CASSETTE PARTS

Musart SA (Discos), Av. Cuiclahuac 2335, Mexico 16, D.F. Tel: (905) 399-2332. Cable: MUSART. Pres.: Eduardo L. Baptista; VP: Andres Baptista, Gen Mgr. Eduardo A. Baptista; Sales Mgr.: Francisco Llopis.

TAPE, BLANK LOADED & BULK RAW

Agfa Gevaert de Mexico SA, Apdo. 7256, Mexico 1, D.F., Ing. Zapadores 1, Naucalpan, Tel. 761 800. Telex. (017) 74479.
Audio: Blah—compact cassette, open reel; raw—cassette, broadcast, studio.
Video: Cassette.
 Ampex de Mexico SA de CV, Div. Del Norte 1832, Col. Portales, Mexico 13, D.F. Tel: (905) 539-6870, 532-5126. Telex. (01) 773951. Gen. Dir.: Miguel A. Hernandez; Admin. Mgr.: Isaias Trujillo; Audio Prods. Sales Mgr.: R. Garcia; Video Prods. Sales Mgr.: Oscar Luna; Tape Prods. Sales Mgr.: M. Santillana.
Audio: 8-tr., cassette, open reel.
Video: 2" quad, 1" open reel, 1/4" U-matic cassette, 1/2" Cassette
 Montage Mexico SA, PO Box 244, Ciudad Ind'l El Framboyan, Lotes 1, 2 & 3, Veracruz, Tel: 3-42 00.
Audio: 8-tr., cassette, open reel.
 Musart SA (Discos), Av. Cuiclahuac 2335, Mexico 16, D.F. Tel: (905) 399-2332. Cable: MUSART. Pres.: Eduardo L. Baptista; VP: Andres Baptista, Gen Mgr.: Eduardo A. Baptista; Sales Mgr. Francisco Llopis.
Audio: Cassette.
Brand name: Prosonic.
 Prosonic, see Musart.
 Sovi SA, Arquimedes 98, Mexico 5, D.F. Tel: (905) 250-6000/6200.
Audio: 8-tr., cassette, open reel

TAPE DUPLICATING & PROCESSING EQUIPMENT
 Ampex de Mexico SA de CV, Div. del Norte 1832, Col. Portales, Mexico 13, D.F. Tel: (905) 539-6870, 532-5126. Telex: (01) 773951. Gen. Dir. Miguel A. Hernandez; Admin. Mgr.: Isaias Trujillo; Audio Prods. Sales Mgr.: R. Garcia; Video Prods. Sales Mgr. Oscar Luna; Tape Prods. Sales Mgr.: M. Santillana.
Audio: Recorders.
Video: Recorders, cameras & switchers
 Musart SA (Discos), Av. Cuiclahuac 2335, Mexico 16, D.F. Tel: (905) 399-2332. Cable: MUSART. Pres.: Eduardo L. Baptista; VP: Andres Baptista; Gen. Mgr.: Eduardo A. Baptista; Sales Mgr.: Francisco Llopis.

TAPE PACKAGING & LABELING EQUIPMENT
 Musart SA (Discos), Av. Cuiclahuac 2335, Mexico 16, D.F. Tel: (905) 399-2332. Cable: MUSART. Pres.: Eduardo L. Baptista; VP: Andres Baptista; Gen Mgr. Eduardo A. Baptista; Sales Mgr. Francisco Llopis

• accessories

Ampex de Mexico SA de CV, Div. del Norte 1832, Col. Portales, Mexico 13, D.F. Tel: (905) 539 6870, 532-5126. Telex: (01) 773951. Dir. Miguel A. Hernandez; Admin. Mgr. Isaias Trujillo; Audio Prods. Sales Mgr. R. Garcia; Video Prods. Sales Mgr.: Oscar Luna; Tape Prods. Sales Mgr. M. Santillana
Product: Tape—head cleaners & demagnetizers, leader & splicing tape
 Aurex SA de CV, Calzada Tulyehualco 3370, Mexico 23, O.F. Tel: (905) 845-2268, 670-0277. Chm.: Federico Valdes; Gen. Mgr.: Ernesto Valdes; Sales Mgr.: Ramiro Gamboa.
Product: Tape—head cleaners, demagnetizers, leader tape
 Centro Musical de Tijuana SA, PO Box 292, San Ysidro, Calif. 92073, USA, 917 Constitucion Ave., Tijuana, B.C. Tel: (706) 685-1322. Pres.: Luis B. Alonso, VP: Tessa Alonso, Sales Mgr. Manuel Magdaleno C
Product: Record—carrying & storage cases, record care prods., 45 rpm adapters, replacement styli, Tape—carrying & storage cases
 Sovi SA, Arquimedes 98, Mexico 5, D.F. Tel: (905) 250-6000/6200
Product: Tape—leader tape

• playback/recording equipment

Accurate Sound Int'l de Mexico de SA de CV, Av. Mexico Coyoacan 389, Local 8, Col. Gral. Anaya, Mexico 13, O.F. Tel: (905) 524 1075. Branch Mgr. Mary Capilla
Home office: USA
Audio: ASCO
 Ampex de Mexico SA de CV, Apdo. 13 615, Div. del Norte 1832, Col. Por

tales, Mexico 13, D.F. Tel: (905) 539-6870, 532-5126. Telex (017) 73951. Gen. Dir. MA Hernandez; Audio Prods. Sales Mgr. R. Garcia; Video Prods. Sales Mgr.: O. Luna; Tape Prods. Sales Mgr.: M. Santillana
 Coro SA, Bahua de Perula 80, Mexico 17, D.F. Tel: (905) 531 2900. Pres. Federico E. Rojas, Gen. Mgr.: Gloria Oliveros.
Audio: Ocean (Japan).

Netherlands

• services

DESIGN & ARTWORK

Almere Printing BV, Draaibrugweg 19, 1300 AA Almere. Tel: (03240) 2-05 54. Telex: 70442 Mng. Dir. Koert Bolhuis, Sales Mgr. Wim Trouw
 Benelux Music Inds., PO Box 70, 6000 AB Weert; Uilenweg 38, 6006 SK Weert. Tel: (04950) 3-56-40. Telex: 37576. Dir. Johnny Hoes; Gen. Mgr. Jacques Hoes; Sales Mgr. Adrian Hoes, Prod. Mgr. Sjaayr Djamschidi
 C B S Grammofoonplaten BV, Nijverheidsweg 32-36, 2031 CP Haarlem. Tel: (023) 31 94-10. Cable: COLRECORD. Telex: 41538. Gen. Mgr. Peter P. Bouwens, Sales Mgr. W.F. Arens
 Continental Sound, PO Box 81065, Rotterdam. Tel: (010) 21 10-98, 21-48 28. Pres.-Dir. Gen. Leen La Riviere; Dir.: Nico Zwarts, Gen. Mgr. Kees Klaassen
 Drukkerij van de Steeg BV, Postbus 110, 7500 AC Enschede. Tel: (053) 61 33-44. Sales Mgr. H.H. Smit
 E & E Prods. PO Box 1525, 1000 BM Amsterdam. Tel: (020) 16 32 42. Gen. Mgr. Peter Rensen
 EMI Servs. Benelux BV, PO Box 333, 5400 AH Uden, Industrielaan 24, 5406 XC Uden. Tel: (04132) 6-81-55. Cable: EMI HP. Telex: 50477. Dir. & Gen. Mgr. Dr. U.R. Mueller
 Munich Recs. BV, Albert Schweitzerlaan 9, 6721 AW Bennekom. Tel: (08389) 67 77. Pres. Job C. Zomer, Gen. & Sales Mgr. Wybo Baron, Adm. Mgr. Huub Trautwein
 Nederlandse Normaal Drukkerij BV (Bramson Groep), PO Box 191, 3800 AD Amersfoort, Nijverheidsweg Noord 126 128, Amersfoort. Tel: (033) 3 16 64. Telex: 79448
 P C M P Inc. Holland, PO Box 479, 3130 AL, Vlaardingen. Tel: (010) 35 71 20
 Polydor BV, Albertus Perkstraat 35, 1217 NL Hilversum. Tel: (035) 234941. Telex: 73352. Mng. Dir. Nico van Biemen
 Ring Workshop BV, Orchdeest 19a, Hilversum. Tel: (02150) 4 38-41. Gen. Mgr. Theo de Vos; Prod'n Mgr. Nick P. Lucas, Creative Dir.: Joop Dodder; Coordination Mgr. Mrs. Rietje Riedijk
 Universe Prods., Spaansdijk 33, Leeuwarden. Tel: (05100) 2-01-94, 2-45-22. Pres.: Wobbe van Seijen, Sales Mgr. Wim de Vries.
 Wax-Europe, Kattengat 2, 1012 SZ Amsterdam. Tel: (020) 25-48 14. Pres. Morton D. Wax; European Mgr.: Jules Farber

PRINTERS & LITHOGRAPHERS

Almere Printing BV, Draaibrugweg 19, 1300 AA Almere. Tel: (03240) 2 05 54. Telex: 70442. Mng. Dir. Koert Bolhuis; Sales Mgr. Wim Trouw
 Amsterdam Drukkerij, N. Berchemstraat 1, Amsterdam. Tel: (020) 79-10 45, 13-52-02.
 Benelux Music Inds., PO Box 70, 6000 AB Weert, Uilenweg 38, 6006 SK Weert. Tel: (04950) 3-56-40. Telex: 37576. Dir. Johnny Hoes, Gen. Mgr. Jacques Hoes, Sales Mgr. Adrian Hoes, Prod. Mgr. Sjaayr Djamschidi
 Bijetdrukkerij Nederland, Binnenkant 40, Amsterdam. Tel: (020) 22 16 31
 C B S Grammofoonplaten BV, Nijverheidsweg 32-36, 2031 CP Haarlem. Tel: (023) 31-94-10. Cable: COLRECORD. Telex: 41538. Gen. Mgr. Peter P. Bouwens, Sales Mgr. W.F. Arens
 Joh. de Heer & Zn. BV (Handelmij), Rozenlaan 113, Rotterdam. Tel: (010) 22-09-88. Mng. Dir. J.A. de Heer, Sales Mgr. S.J. de Heer.
 Drukkerij van de Steeg BV, Postbus 110, 7500 AC Enschede. Tel: (053) 61 33-44. Sales Mgr. H. H. Smit
 EMI Servs. Benelux BV, PO Box 333, 5400 AH Uden, Industrielaan 24, 5406 XC Uden. Tel: (04132) 6-81-55. Cable: EMI HP. Telex: 50477. Dir. & Gen. Mgr. Dr. U.R. Mueller
 Habo/Dacosta Grafische Industrie, Coloradodreef 18, 3565 BT Utrecht. Tel: (030) 61 68 21. Telex: 47315. Mng. Dir. J.A. Meijer, Sales Mgr.: R. Meijer
 Moonlight, Hurwenestr. 5, Rossum. Tel: (04182) 790
 N N D, PO Box 191, Amersfoort. Tel: (033) 3 16 64
 Nederlandse Normaal Drukkerij BV (Bramson Groep), PO Box 191, 3800 AD Amersfoort, Nijverheidsweg Noord 126 128, Amersfoort. Tel: (033) 3 16 64. Telex: 79448
 P C M P Inc. Holland, PO Box 479, 3130 AL, Vlaardingen. Tel: (010) 35 71 20
 Polydor BV, Albertus Perkstraat 35, 1217 NL Hilversum. Tel: (035) 234941. Telex: 73352. Mng. Dir. Nico van Biemen
 Arno van Orsouw BV, Oostenburgervoorst 71 73, Amsterdam. Tel: (020) 22 28-98, 25 21 13. Telex: 13442. Chief Exec. Arno van Orsouw

TAPE CUSTOM DUPLICATORS TAPE PACKAGING & LABELING

The Audio and Video lines indicate the configurations which the firms duplicate. Companies which offer packaging and labeling of tape product are indicated by "PKG" which appears after the main body of their respective listings.

Audio Studio & Magnetronics BV, de Welstr. 10-12, Arnhem. Tel: (085) 22 91 23. Telex: 75037. Pres. Gert van der Garde, Gen. Mgr. Alfred van der Garde, Chief Eng., Charles van Cattenburch
Audio: Cassette, open reel
 Benelux Music Inds., PO Box 70, 6000 AB Weert, Uilenweg 38, 6006 SK Weert. Tel: (04950) 3-56-40. Telex: 37576. Dir. Johnny Hoes, Gen. Mgr. Jacques Hoes, Sales Mgr. Adrian Hoes, Prod. Mgr. Sjaayr Djamschidi (PKG—video only)
Audio: 8-tr., cassette
 C B S Grammofoonplaten BV, Nijverheidsweg 32-36, 2031 CP Haarlem. Tel: (023) 31 94-10. Cable: COLRECORD. Telex: 41538. Gen. Mgr. Peter P. Bouwens, Sales Mgr. W.F. Arens.
Audio: Cassette
 EMI Servs. Benelux BV, PO Box 333, 5400 AH Uden, Industrielaan 24, 5406 XC Uden. Tel: (04132) 6-81-55. Cable: EMI HP. Telex: 50477. Dir. & Gen. Mgr. Dr. U.R. Mueller
Audio: Cassette

M C R Prods. NV, Hooglandseweg 62, 3813 AS Amersfoort. Tel: (033) 723401. Telex: 79388. Mng. Dir. Foppe Damste, Chief Eng.: Ben Uy tjens
Audio: Cassette
 Polydor BV, Albertus Perkstraat 35, 1217 NL Hilversum. Tel: (035) 234941. Telex: 73352. Mng. Dir.: Nico van Biemen
Audio: Cassette
 Sonortape Nederland BV, PO Box 113, Zonnebaan 42, 3600 AC Maarssen. Tel: (030) 43 11 44. Telex: 40354. Chief Exec. M.C. Groeneveld
Audio: Cassette
 Van der Garde's Audio Studios BV, De Welstr. 10-12, 6814 AP Arnhem. Tel: (0031) 85 22 91 23. Dir. Gert van der Garde
Audio: Cassette

• supplies

EMPTY CARTRIOGES, CASSETTES & REELS

Benelux Music Inds., PO Box 70, 6000 AB Weert, Uilenweg 38, 6006 SK Weert. Tel: (04950) 3-56-40. Telex: 37576. Dir. Johnny Hoes, Gen. Mgr. Jacques Hoes, Sales Mgr. Adrian Hoes, Prod. Mgr. Sjaayr Djamschidi
 E & E Prods. PO Box 1525, 1000 BM Amsterdam. Tel: (020) 16 32-42. Gen. Mgr. Peter Rensen

PROFESSIONAL TAPE SUPPLIES

Benelux Music Inds., PO Box 70, 6000 AB Weert, Uilenweg 38, 6006 SK Weert. Tel: (04950) 3-56-40. Telex: 37576. Dir. Johnny Hoes, Gen. Mgr. Jacques Hoes, Sales Mgr. Adrian Hoes, Prod. Mgr. Sjaayr Djamschidi
Product: Cassette labels
 Nederlandse Normaal Drukkerij (Bramson Groep), PO Box 191, 3800 AD Amersfoort, Nijverheidsweg Noord 126 128, Amersfoort. Tel: (033) 3-16 64. Telex: 79448
Audio: Inlays
Video: Boxes
 Arno Van Orsouw BV, Oostenburgervoorst 71, 1018 MP Amsterdam. Tel: (020) 22-28-98, 25-21-13. Telex: 13442. Dir. Arno Van Orsouw.
Product: Cartridge labels

TAPE DUPLICATING & PROCESSING EQUIPMENT

Audio Studio & Magnetronics BV, de Welstr. 10-12, Arnhem. Tel: (085) 22 91 23. Telex: 75037. Pres. Gert van der Garde, Gen. Mgr. Alfred van der Garde, Chief Eng. Charles van Cattenburch
Audio: Duplicators, loaders
Brand name: Telefonken

TAPE, RAW & BLANK LOADED

Agfa Gevaert NV, Polakweg 10 11, Ryswyk. Tel: (070) 90 66-80. Mng. Dir. J. Davignon, Sales Mgr. D. van den Broek
Audio: Cassette, open reel
Video: 1" open reel, 1" cartridges, 1/4" cassette
 Ampex BV, PO Box 9026, 3506 GA Utrecht, Zamenholdreef 65A, 3562 JV Utrecht. Tel: (030) 61 29 21. Cable: AMPLEX. Telex: 47856. Mgr. G.C.A. de Jong
Audio: 2", 1", cassette, open reel
Video: 2", 1", 1/4", 1/2", Beta & VHS
 Audiocript BV, Postbus 82, Loosdrechtse dijk 107, Loosdrecht. Tel: (02158) 5104. Dirs. P. De Ruig, J.L. Cluysenaar (Blank only)
Audio: Cassette
Brand name: Luxman
 Audio Studio & Magnetronics BV, de Welstr. 10-12, Arnhem. Tel: (085) 22 91 23. Telex: 75037. Pres. Gert van der Garde, Gen. Mgr. Alfred van der Garde, Chief Eng. Charles van Cattenburch
Audio: Cassette, open reel.
Video: 1/2" EIAJ cartridge
 B A S F Nederland BV, PO Box 1019, Kadest. 1. Tel: (085) 71 71 71. Telex: 45111. Sales Mgr. Willem van Workum
Audio & video: Cassette & open reel
 P C M P Inc. Holland, PO Box 479, 3130 AL, Vlaardingen. Tel: (010) 35 71 20. (Raw only)
Audio: Cassette, open reel
 P D Magnetics, Magneetband Fabriek Oosterhout BV, PO Box 82, Molensluis 37, 4900 AB Oosterhout NB. Tel: (016) 205 59-10

• accessories

Ampex BV, PO Box 9026, 3506 GA Utrecht, Zamenholdreef 65A, 3562 JV Utrecht. Tel: (030) 61 29 21. Cable: AMPLEX. Telex: 47856. Mgr. G.C.A. de Jong
Product: Tape—carrying & storage cases, head cleaners, bulk erasers, de-magnetizers, leader tape, splicing tape & equip. (all audio & video)
 Audiocript BV, Postbus 82, Nieuw Loosdrechtse dijk 107, Loosdrecht. Tel: (02158) 5104. Dirs. P. de Ruig, J.L. Cluysenaar
Product: Record—replacement styli
 Drukkerij van de Steeg BV, Postbus 110, 7500 AC Enschede. Tel: (053) 61 33-44. Sales Mgr. H.H. Smit
Product: Tape—carrying & storage cases
 Inelco Nederland BV, Turfsteekstr. 63, 1431 GO Aalsmeer. Tel: (02977) 28855. Cable: INTELECT. Telex: 14683
Product: Record—replacement styli (Pickering)
 Munich Recs. BV (VHB Munnkendam's Groothandel NV) Albert Schweitzerlaan 9, 6721 AW Bennekom. Tel: (08389) 67 77. Cable: MUREC. Pres.: Job C. Zomer, Sales Mgr. Wybo Baron, Mktg. Mgr. Huub Trautwein
Product: Record—replacement styli
 P C M P Inc. Holland, PO Box 479, 3130 AL, Vlaardingen. Tel: (010) 35 71 20
Product: Record—replacement styli. Tape—leader & splicing tape
 Pico Recs., Ganzenhoef 28, Amsterdam. Tel: (020) 99 47 36. Dir. Hans Douw, Gen. Mgr. Kees Kuiper, Sales Mgr. Alma Ramchalaan
Product: Record—carrying & storage cases, record care prods., 45 rpm adapters, replacement styli
 Weton Wesgram BV, Veerlaan 84 92, 3072 ZZ Rotterdam. Tel: (010) 86 11 66. Telex: 28798. Exec. MA Eygelsheim, Gen. Mgr. W. van Oum.
Product: Record—carrying & storage cases, record care prods., Tape—carrying & storage cases

• store fixtures

Almere Printing BV, Oraaibrugweg 19, 1300 AA Almere. Tel: (03240) 2 05 54. Telex: 70442. Mng. Dir. Koert Bolhuis, Sales Mgr. Wim Trouw
Product: Record & tape browser boxes, display racks, divider cards

• **playback/recording equipment**

Ampex BV, PO Box 9026, 3506 GA Utrecht, Zamenhofdreef 65A, 3562 JV Utrecht Tel (030) 61 29 21 Telex 47856 Mgr GCA de Jong
 Audiocript BV, Postbus 80, Nieuw Loosdrechtsejdijk 107, Nieuw Loosdrecht, Tel (02158) 5104. Dirs P de Ruig, J.L. Cluysenaer.
 Audio: Luxman.
 Audio Studio & Magnetronics BV, de Wetstr 10 12, Arnhem Tel (085) 22 91-23 Telex 75037 Pres Gert van der Garde, Gen Mgr Alfred van der Garde, Chief Eng Charles van Cattenburch
 Audio & Video: Magnetronic
 Audiotechnics, see Selectronic
 Chairros BV, Mensinge 51, Amsterdam Tel (020) 44 13-77 Telex 18118 Pres. W.F. Harrems, Gen Mgr Mrs. B. Harrems
 Audio: Motorola (USA), Shibuya (Japan)
 Luxman, see Audiocript
 Magnetronic, see Audio Studio
 Motorola, see Chairros
 Realistic, see Tandy
 Revox, see Selectronic
 Selectronic BV, 1 Zydelyri, 1420 CA Uithoorn Tel (02975) 60 600/562 Telex 15728 Pres. G.J. Mühlenbaumer, Sales Mgr R. Mühlenbaumer, Adv. Mgr. F. Maaswinkel
 Audio: Audiotechnics, Revox, Tiffen
 Shibuya, see Chairros
 Tandy Int'l Electronics, Vijzelgracht 7, Amsterdam
 Audio: Realistic (USA)
 Tiffen, see Selectronic

Switzerland

• **services**

DESIGN & ARTWORK

Ackeret Design Studios, Schaffhauserstr 15, Zurich Tel (01) 60 38 72
 E Schweizer Design AG, Spaltenweg 54 CH 4051 Basel Tel (061) 22 17 65 Gen Mgr Peter Krummenacher
 Int'l branches: Germany, USA
 Sonographic Rec'g Co AG, Kampstr 16, CH 8952 Schlieren Tel (01) 730 22 29 Pres R Egl, Gen Mgr WA Wettler, Sales Mgr A Brand

TAPE CUSTOM DUPLICATORS

TAPE PACKAGING & LABELING

Atlantida SA, Chemin Morse Duboule 49, CH 1211 Geneva 28 Tel (022) 98 33 22 Cable ASAINTER
 Cross Ltd, PO Box 44, Aegeristr. 2, CH 6340 Baar Tel (042) 31.64.88 Telex 865152 Mng Dir Rolf Albinger (PKG only-audio)
 Intertape Ltd (International Tape Drg.), Spinnerestr. 21, CH 8753 Mollis Tel (058) 34 31 34 Telex 75162 Gen Mgr Peter Baumgartner, Sales Mgr Louis Bischof
 Audio: Cassette, open reel
 Video: 1" helical open reel, 3/4" U matic cassette, 1/2" Beta & VHS cassette
 M C S (Music & Cassette Supply Ltd.), Schufelistr., CH 8863 Buttikon SZ Tel (055) 67 14 14 Telex 75144 Pres Werner Weber, Gen Mgr Mario Taravella, Sales Mgr Ulrich Plocher
 Int'l branch: Germany
 Audio: 8 tr. cassette, open reel
 Musicland AG, Althardstr 224, CH 8105 Regensdorf/Zurich Tel (01) 840 60 40 Telex 56359 Pres & Gen Mgr Gian Carlo Astore
 Audio: 8 tr. cassette, open reel
 Ruba, Beerli & Co /Arthook Ch. E. Beerli, PO Box 300, Claragraben 78, CH 4000 Basel Tel (061) 33 23 94
 Unifon Studios E Heers Schulstr 56 CH 8105 Regensdorf
 Werbomatic, Gramatt 4 CH 8862 Schuebelbach Tel (055) 64 41 43 Gen Mgr Eugene Tiel
 Video: 1/2" Beta & VHS cassette

• **supplies**

CARTRIDGE & CASSETTE PARTS

Alchemo AG, Althardstr 224, CH 8105 Regensdorf Tel (01) 840 66 06 Telex 56359 Pres & Gen Mgr Gian Carlo Astore, Sales Mgr Alfred K Eggl, Admin Supervisor Walter R Lang
 Audio: Cassette bodies, hubs, rolls, foils pads, shields, all cartridge plastic parts library cases
 C T (Compact Cassettes Trading AG), Birmensdorferstr 55, CH 8036 Zurich Tel (01) 241 47 11 Telex 58975 Pres. Hugo von Blumenthal
 I C M Ltd., Muehlebachstr 27, CH 8800 Thalwil Tel (01) 720 29 42 Telex 53759 Pres Werner Weber, Gen Mgr Andy Baur, Sales Mgr Rolf Sager
 Lake County Recs., Fritz Courvoisier 15 CH 2300 La Chaux de Fonds Tel (039) 22 63 03 Chief Exec Michel Cattin, Gen & Sales Mgr Eliane Cattin
 Lenco Moulding SA, rue de l'Industrie, CH 1781 Courtaman Tel (037) 34 19 15 Gen Mgr Gerard Koerberle, Sales Mgr Zita Koerberle
 Toka AG, see CCT

EMPTY CARTRIDGES, CASSETTES, & REELS

Alchemo AG, Althardstr 224, CH 8105 Regensdorf Tel (01) 840 66 06 Telex 56359 Pres & Gen Mgr Gian Carlo Astore, Sales Mgr Alfred K Eggl, Admin Supervisor Walter R Lang
 Audio: Cassettes, cartridges, digital cassettes
 C T (Compact Cassettes Trading AG), Birmensdorferstr 55 CH 8036 Zurich Tel (01) 241 47 11 Telex 58975 Pres Hugo von Blumenthal (Video only)
 I C M Ltd., Muehlebachstr 27, CH 8800 Thalwil Tel (01) 720 29 42 Telex 53759 Pres Werner Weber, Gen Mgr Andy Baur, Sales Mgr Rolf Sager
 Lake County Recs., Fritz Courvoisier 15 CH 2300 La Chaux de Fonds Tel (039) 22 63 03 Chief Exec Michel Cattin, Gen & Sales Mgr Eliane Cattin
 Lenco Moulding SA, rue de l'Industrie, CH 1781 Courtaman Tel (037) 34 19 15 Gen Mgr Gerard Koerberle, Sales Mgr Zita Koerberle
 Audio: C D cassettes
 Musicland AG, Althardstr 224 CH 8105 Regensdorf Zurich Tel (01) 840.60.40 Telex 56359 Pres & Gen Mgr Gian Carlo Astore

MAY 23, 1981 BILLBOARD

... they say
 we are
 the best...

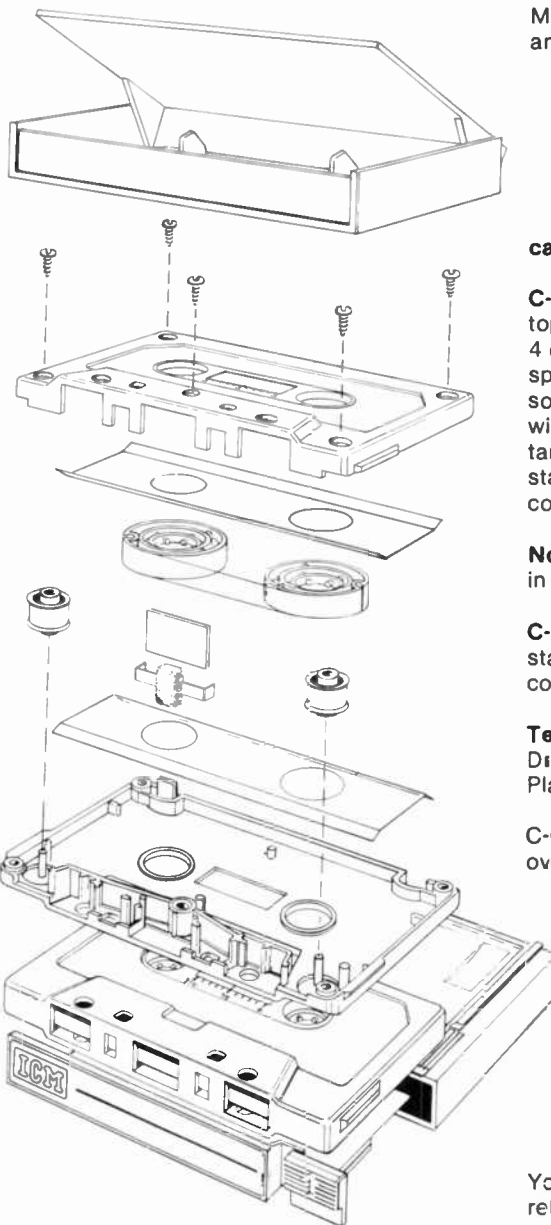

Manufacturer and supplier of:

cassette parts

C-O cassettes
 top performance
 4 or 5 screws or sonic welded
 special liner
 soft or hard window
 with plastic or steel pin
 tabs in or out
 standard or Cro 2 type
 colors

Norelco style box
 in different colors

C-Box storage system
 standard or with transparent
 cover

Testequipment
 Drop-Out tester DO 2000
 Play + wind tester 7804

C-O Production:
 over 60 million per year

Your partner for quality and reliability

ICM Ltd.
 Muehlebachstr. 27
 CH-8800 Thalwil
 Switzerland
 Tel. 01/720 29 42
 Telex 53759

ICM
 SWITZERLAND

A/V/T-75

PROFESSIONAL TAPE SUPPLIES

Cross Ltd., PO Box 44, Aegerster 2, CH-6340 Baar Tel (042) 31 64 88
Telex 865152. Mng. Dir.: Rolf Albinger
Product: Cassette labels

TAPE, RAW & BLANK LOADED

Agfa-Gevaert AG/Sa, Stettbachstr 7, CH-8600 Duebendorf, Tel Zurich
821.02.40 Telex 56961 Zurich Mng Dir R Klett, Sales Mgr H
Mueller

Audio: Blank—Compact-cassette, open reel, raw—cassette, broadcast,
studio
Video: Cassette

Alchemo AG, Althardstr 224, CH-8105 Regensdorf Tel (01) 840 66 06
Telex: 56359. Pres. & Gen. Mgr. Gian Carlo Astore; Sales Mgr Alfred K.
Eggl; Admin Supervisor Walter R. Lang

Audio: Raw—8-tr, cassette, open reel, blank—8-tr, cassette
Ampex World Dpns SA, Rt. des Arsenaux 9, CH-1701 Fribourg Tel (037)
81.31 11. Cable VIDEOTAPE. Telex: 36196. Tape Sales Mgr J.D.
Renevey

Audio: 2", 1", cassette, open reel.
Video: 2", 1", 1/2", 1/4" Beta & VHS.

Audio-Electronic AG, Raffelstr 25 CH-8045 Zurich Tel (01) 66 26 90
Telex 56556. Chm. Manfred Frank. Sales Mgr. Ed Isenring (Importer)
(Blank only)

Audio: Cassette, open reel.
Brand name: Fuji

Audio Magnetics SA Geneva, 2 Rue des Acacias, CH 1217 Geneva 24 Tel
(022) 43 51 15. Telex 27152. Gen. Mgr Jean-Pierre Murbach; Sales
Mgr: Werner Meier; Mktg Mgr Jean-Jacques Eschenmoser

Int'l subsidiaries: England, France, Germany, Portugal (All Audio
Magnetics)

Audio: 8-tr, cassette & open reel.
B A S F (Switzerland) AG, Appital, CH-8820 Waedenswil Tel (01)
783.91 11 Telex (08) 75275

Home office: Germany.
Audio: Blank—2", 1", cassette, open reel
Video: Raw—1", Blank—1", 1/2" U-matic cassette, 1/2" Beta & VHS

B B H Videocopy Ltd., Spinnerenstr 21, CH-8753 Mollis Tel (058) 34.31.36
Telex: (08) 75162. Gen. Mgr. Peter Baumgartner. Sales Mgr. Louis
Bischof (Blank only)

Video: 1/2" U-matic cassette, 1/2" Beta & VHS cassette
Cross Ltd., PO Box 44, Aegerster 2, CH-6340 Baar. Tel: (042) 31 64.88.
Telex 865152. Mng. Dir.: Rolf Albinger (Blank only)

Audio: Cassette
Fuji, see Audio-Electronic.
I C M Ltd., Muehlebachstr 27, CH-8800 Thalwil Tel: (01) 720.29.42 Telex:
53759. Pres: Werner Weber; Gen. Mgr. Andy Baur; Sales Mgr. Rolf
Sager (Raw only)

Lenco Moulding SA, rue de l'Industrie, CH 1781 Courmaman. Tel: (037)
34 19 15. Gen. Mgr. Gerard Koerberle. Sales Mgr. Zita Koerberle (Blank
only)

Audio: Cassette
M C S (Music & Cassettes Supply Ltd.), Schufelistr., CH-8863 Buttikon SZ.
Tel: (055) 67 14 14. Telex: 875144. Pres: Werner Weber; Gen. Mgr.
Mario Taravella. (Blank only)

MagneTec Inc., Schwarztorstr. 36, CH-3007 Berne. Tel (031) 25.44.74.
Telex: 32923. Gen. Mgr.: Dr. P.J. Wymann. (Consulting & Engineering)

Musicaland AG, Althardstr 224, CH-8105 Regensdorf/Zurich. Tel (01)
840 60 40 Telex 56359. Pres. & Gen. Mgr. Gian Carlo Astore

Audio: 8-tr, cassette, open reel.
Pyral (Produits) SA, 3 Rue Beau-Site, CH-1211 Geneva Tel 44 65.50 Telex
23756. (Blank only)

Home office: France
Revox-ELA AG, Althardstr. 146, CH-8105 Regensdorf Tel (01) 840.26.71
Pres.: Willi Studer; Gen. Mgr. Michel Ray (Blank only)

Audio: Open reel
Sony Overseas SA, Baarerstr. 59, CH-6301 Zug. Tel: (042) 23.31.21. (Blank
only)

Audio: Cassette, open reel
Video: 1" open reel, 1/2" cassette, 1/2" EIAJ cartridge

TAPE DUPLICATING EQUIPMENT
Alchemo AG, Althardstr 224, CH-8105 Regensdorf Tel (01) 840 66 06
Telex: 56359. Pres. & Gen. Mgr. Gian Carlo Astore; Sales Mgr Alfred K.
Eggl; Admin Supervisor: Walter R. Lang

Audio: Quality control equipment for CC production, cassette winders,
audio acoustical equipment.

Audio Magnetics SA Geneva, PO Box 54, 2 Rue des Acacias, CH-1227
Geneva Tel (022) 43 51 15 Telex 27152 Gen Mgr Jean-Pierre
Murbach, Sales Mgr Werner Meier, Mktg Mgr Jean Jacques
Eschenmoser

Int'l subsidiaries: England, France, Germany, Portugal (All Audio
Magnetics)

Audio: 8-tr, cassette & open reel copiers & duplicators
Brand name: Pentagon.
Cetec Int'l Ltd., Steinbachstr. 3, CH-6317 Oberwil/Zug. Tel (042)
21 53 32 Telex 78806

Audio: High speed duplicators
Brand name: Gauss.
Gauss, see Cetec Int'l

Intertechnika (div. of Nichibe Technical Consultants Ltd.), Case Postale
475, 4 Rue Ami-Lullin, CH-1211 Geneva 3

Audio: Design & implementation of facilities
Sony Overseas SA, Baarerstr. 59, CH 6300 Zug Tel (042) 23 31 21

TAPE PACKAGING & LABELING EQUIPMENT
Cross Ltd., PO Box 44, Aegerster 2, CH-6340 Baar. Tel (042) 31 64.88
Telex: 865152. Mng. Dir.: Rolf Albinger.

Product: Cassette boxing & labeling machines

• accessories
Alchemo AG, Althardstr. 224, CH-8105 Regensdorf. Tel: (01) 840 66 06
Telex: 56359. Pres. & Gen. Mgr. Gian Carlo Astore; Sales Mgr Alfred K.
Eggl; Admin Supervisor: Walter R. Lang

Product: Tape—carrying & storage cases, head cleaners, demagnetizers,
leader & splicing tape
Ampex World Dpns SA, Rt. des Arsenaux 9, CH-1701 Fribourg Tel (037)
81.31 11. Cable VIDEOTAPE Telex: 36196. Tape Sales Mgr J.D. Renevey

Product: Tape—carrying & storage cases, head cleaners, bulk erasers, de-
magnetizers, leader tape, splicing tape & equip (all audio & video).

Dynavox Electronics, route de Villars 105, CH 1700 Fribourg Tel: (037)
24.55.30.
Product: Record—replacement styli.

Brand name: Picking
I C M Ltd., Muehlebachstr 27, CH-8800 Thalwil Tel (01) 720.29.42 Telex:
53759. Pres.: Werner Weber; Gen. Mgr.: Andy Baur; Sales Dir.: Rolf Sa-
ger

Product: Tape—carrying & storage cases
Lake County Recs., Fritz Courvoisier 15, CH-2300 La Chaux-de-Fonds Tel.
(039) 22.63.03. Owner: Michel Cattin; Gen. & Sales Mgr.: Eliane Cattin.

Product: Record—45 RPM adapters, replacement styli
M C S (Music & Cassette Supply Ltd.), Schufelistr., CH-8863 Buttikon SZ
Tel (055) 67.14.14. Telex: 75144. Pres.: Werner Weber; Gen. Mgr.: Mario
Taravella; Sales Mgr.: Ulrich Plocher.

Int'l branch: Germany
Product: Tape—head cleaners.

Musicaland AG, Althardstr. 224, CH-8105 Regensdorf/Zurich. Tel: (01)
840 60.40. Telex: 56359. Pres. & Gen. Mgr. Gian Carlo Astore

Product: Tape—carrying & storage cases, head cleaners & demagnetiz-
ers.
Revox ELA AG, Althardstr 146, CH-8105 Regensdorf. Tel: (01) 840.26.71
Pres. Willi Studer; Gen. Mgr. Michel Ray

Product: Tape—carrying & storage cases, head cleaners
E. Schweizer Design AG, Spaltenweg 54, CH 4051 Basel. Tel: (061)
22.17.65. Telex: 63403. Gen. Mgr.: Peter Krummenacher

Int'l branches: Germany, USA.
Product: Record—carrying & storage cases, record care prods., Tape—
head cleaners.

Thorens-Franz AG, Hardstr 41, CH-5430 Wettingen Tel: (056) 26 28 61
Mng. Dir. Remy A. Thorens. Sales Dir.: Armin Graf.

Product: Record—record care prods., 45 RPM adapters, replacement
styl

• store fixtures
Alchemo AG, Althardstr 224, CH-8105 Regensdorf/Zurich Tel: (01)
840 66 06 Telex: 56359. Pres. & Gen. Mgr. Gian Carlo Astore; Sales
Mgr Alfred K. Eggl; Admin. Supervisor: Walter R. Lang.

Product: Tape display racks.
Musicaland AG, Althardstr 224, CH-8105 Regensdorf/Zurich. Tel (01)
840 60.40. Telex: 56359. Pres. & Gen. Mgr. Gian Carlo Astore.

Product: Tape display racks.
E Schweizer Design AG, Spaltenweg 54, CH-4051 Basel Tel (061)
22.17.65 Telex 63403 Gen Mgr Peter Krummenacher

Int'l branches: Germany, USA.
Product: Browser boxes, display racks.

• playback/recording equipment
Ampex World Operations SA, Rt. des Arsenaux 9, CH-1700 Fribourg Tel.
(037) 81.31.11. Telex: 36196. Cable: VIDEOTAPE (Audio & Video)

Cetec Switzerland, Steinbachstr. 3, CH-6317 Oberwil/Zug Tel (042)
21 53.32 Telex: 78806
Home office: USA.
Audio: Gauss (USA)

Harrison & Sons (London) Ltd., Printing House Ln., Hayes, Middx UB3 1HQ.
Tel: (01) 573-3828. Telex: 23744. Mng. Dir.: J.A. Modlock; Comm'l Dir.:
B.L. Hibbit; Sales Dir.: D.S. Robinson; Prod. Mgr.: M.S. Fritzerger
John Harwood-Bee Assocs., The Folly, Folly Island, Hertford, Herts. Tel:
(0992) 551233. Telex: 817861. Mng. Dir.: John Harwood-Bee.

Immediate Sound Servs. Ltd., 6 Drsmn Rd., London N1 5QJ. Tel: (01) 739-
9672. Telex: 914382. Mng. Dir.: J.W. Hart.

Independent Rec. Co., 39 Harmer St., Gravesend, Kent. Tel. (0474) 65687.
Chief Exec.: J.W. Dram.

Industrial Recs. Ltd., 10 Martello St., London E8. Tel: (01) 254-9178. Mng
Dir: Peter Christopherson. Gen. Mgr. Coasey P. Orridge; Sales Mgr.: David
Brooks; Gen. Exec.: Joyce Sinclair.

J S D Group of Cos., 62 Berners St., London W1P 3AG. Tel: (01) 580-4720.
Telex: 261298. Mng. Dir.: Joseph R. Stanley; Gen. Mgr.: N.P.J. Murray
Jab Org Ltd., 100 Wardour St., London W1. Dir. John Bright
Ellie Jay (Prod's) Ltd., 97 Judd St., London WC1. Tel: (01) 388-5771. Mng.
Dir.: Jack Applebaum; Prod'n Mgr.: Andrew Sopot; Prod'n Co-Ord.: Paul
Heeren

T. Richard Johnson Ltd., MAM House, 24/25 New Bond St., London W1. Tel:
(01) 493-7535. Chm.: Terry Johnson; Mng. Dir.: Alan Smith.

Jubilee Graphics, 101 Wardour St., London W1 Tel (01) 437-8572
Keenpac Polyhene Supplies Ltd., Coronation Place, Guildhall Ln.,
Leicester. Tel: (0533) 20084, 537806.

Krystal Promos., 48 Abbeville Rd. S., Millhouses, Sheffield. Tel: (042)
365638

Steve Lane Musical & Publicity Servs., 12 Slough Ln., Kingsbury, London
NW9 8QL. Tel: (01) 205-2587. Owner: Steve Lane; Gen. Mgr.: K.C. Sear
Leader Sound Ltd., 209 Rochdale Rd., Greentland, Halifax, West Yorks. HX4
8JE. Tel: (0422) 76161. Mng. Dir.: Bill Leader. Sec'y: Helen Leader
Lindsey's Colour Serv., 88 Teedale St., London E2. Tel: (01) 729-5462.

Mng. Dir.: Ray Mack; Sales Dir.: David Wall.

London Features Int'l Ltd., Dorset Lodge, 8 Dorset Square, London NW1
6PU. Tel: (01) 723-4204. Cable: LDNPX. Telex: 25884. Mng. Dir.: John
M. Halsall. (Photo library & studio facility repro servs.)

M H G Recs., 40 Gunter Grove, London SW10 0UJ. Tel: (01) 352-2886. Chief
Exec.: Mary Harrison-Goudie. Gen. Mgr.: Rui De Castro

Metropolitan Communications, 8a Frolgar Gardens, London NW3 6UX. Tel:
(01) 435-8803. Mng. Dir.: Mark R.F. Hanau; Sales Mgr.: R. Hanau;
Admn.: A. Lohmeyer.

Modern Pub., New Ibernia House, Winchester Walk, London SE1. Tel (01)
403-6332. Chief Exec.: Alan Edwards. Gen. Mgr.: Eugene Manz.

Mushroom Studios, 18 W. Mill, Clifton, Bristol BS8 4BG. Tel: (0272) 35994,
35867. Chief Exec.: D. Ackerman; Gen. Mgr.: S.A. Ackerman (Rec only)

Music Radio Promos., PO Box 400, Kings Langley, Herts. Tel: (09277)
64014. Mng. Dir. & Gen. Mgr.: Mike Baron; Sales Mgr.: Peter Duncan;
Publ'g Dir.: Nik Oakley

Nelson Rec'g Studio, Nelson House, 93 Castle Hill Rd., Hindley, Wigan,
Lancs. WN2 4BH. Tel: (0942) 58777. Contacts: S. M. Millard, W. Leyland
P D Graphics Ltd., 14 Forest Rd., Woodford Green, Essex S04. Tel: (01) 504-
1549. Mng. Dir. Philip Duffy. Gen. Mgr.: John Copeman

Panda Recs., 2 Catherine St., Seaside, Llanelli, Dyfed, South Wales. Tel:
(05542) 58913, 52490. Dir.: Paul Adams; Sales Mgr.: Alan Phillips.

Pan-Graphics (Edinburgh) Ltd., 21 A Grosvenor St., Edinburgh, Scotland
EH12 5ED. Tel: (031) 225-9502. Creative & Art Dir. Jonathan F. Field
Phonogram Ltd., 50 New Bond St., London W1Y 9AA. Tel: (01) 491-4600.

Cable PHONDREC. Telex: 261583. Mng. Dir.: K.N. Malphant, Mktg. Mgr.:
T. Powell; A&R Dir.: B. Shepherd.

Pinnacle Recs., 9 Dean St., London W1V 5RL. Tel: (01) 734-4543 Telex &
896141. Drington. Chm.: Terry Scully. Gen. Mgr. Tony Berry. Sales Mgr.:
George Holloway

Pasces Publicity & Design, 4 Did Mill Rd., Hunton Bridge, Herts. Tel: Kings
Langley 64049.
Porter & Pocock Assocs Ltd., 72 Westfields Ave., London SW13 0AU. Tel:
(01) 878-4366/2595. Mng. Dir.: R. Alexander Porter

Chess Creative Servs. Ltd., 14A Shouldham St., London W1 Tel (01) 723-
8233. Partners: A. Smith, P.J. Lacy.

Coach House Studio Div./Ice Recs. Ltd., 81-A Dsbaldeston Rd., Stamford
Hill, London N16. Tel: (01) 806-3252. Mng. Dir.: Eddy Grant. Gen. Mgr.
Alpine Grant. Sales Mgr.: Rudolph Grant; Financial Controller: Stan
Blackburn.

Brian Cooke Photography, 19 Shorts Gardens, London WC2H 9AT. Tel: (01)
836-3004. Chief Exec.: Brian Cooke (Photography)

Cooke Key Assocs (Mktg) Ltd., 19 Shorts Gardens, London WC2H 9AT. Tel:
(01) 240-1846/1926. Mng. Dir.: Tony Hutchinson; Gen. Mgr.: Marcus
Anley (Rec. only)

Coombe Music Ltd., Hurston House, Stoke Rd., Kingston-upon-Thames,
Surrey. Tel: (01) 942-6240 Telex 22914

Cream Creative Mktg. Ltd., The Cloisters, 11 Salem Rd., London W2. Tel:
(01) 221-5155

Crownmum Recs., 15 Trafalgar Dr., Walton-on-Thames, Surrey KT12 1MY.
Tel: (073-784) 3932. (09322) 42160. Chm.: Jim Grahame; Gen. & Sales
Mgr.: Raphael Wise (Recs only)

Crownmums, 51 Court Lodge Rd., Horley, Surrey. Tel: (073) 784-3932. (01)
588-8846. Chief Exec.: Jim Grahame; Sales Mgr.: Peter Kunzler; Chief
Exec.: Tim Woods.

D T P Inc., 3 Alfred St., Weston-Super-Mare, Avon BS23 1PZ. Tel: (0934)
21932. Mng. Dir.: Don Todd.

Beryl Davis Assocs., 24 Beresford Rd., Wallasey, Merseyside L45 0JJ. Tel:
(051) 639-2265/3559. Chief Exec.: Beryl Davis; Sales Mgr.: Eunice
Williamson.

Delga Press Ltd., Ongwall House, 8 Marlborough Rd., Bromley, Kent. BR2
9NH. Tel: (01) 450-0112. Telex: 8951346. Mng. Dir.: R.E. Edwards; Gen
Dir.: R.N. Roadnight; Dr.: R.G. Froment; Sales Dir.: P.H. Grey.

Duplitape, 1/7 Harewood Ave., London NW1 6LE. Tel: (01) 724-2497. Chief
Exec. & Gen. Mgr.: B. Lambden; Sales Mgr.: R. Jackson-Moore. (Tape
only)

Edrad Creative Services, Radio House, Old Mill Rd., Kings Langley, Herts.
Tel: (09277) 67479.

Electronic Mfg. (Sales) Ltd., Devonshire House, High St., Birmingham B12
0LP. Tel: (021) 772-7145. Cable: FIESTA. Telex: 336409. Dirs.: R.W.
Thomas, L.L. Loney.

Golden Era Recs Ltd., 1099-A Finchley Rd., London NW11. Tel: (01) 455-
6620. Dir.: Bert Wilcox.

Grampan Recs. Ltd., Airport Ind'l Estate, Wick, Caithness, Scotland. Tel:
(0955) 2787. Telex: 75107. Dir.: J. Johnston; Gen. Mgr.: John Hunter.

Halstan & Co. Ltd., Plantation Rd., Amersham, Bucks HP6 6JH. Tel: (02403)
5525. Cable: HALSTANSIC. Mng. Dir.: R.E. Smith; Sales Mgr.: W.
Shrimpton; Ass't Sales Mgr.: L. Thorpe; Sec'y: R. Yerby.

E. Hannibal & Co. Ltd., Pinfold Rd., Thurmarston, Leicestershire. Tel: (0533)
695413. Telex: 34627. Mng. Dir.: Chris Hetherington; Ass't Mng. Dir.:
Roger Stewart; Music Div. Sales Dir.: Derek Deighton.

Happy Face Music, The Old Smithy, Post Office Ln., Kempsey, Worcs. Tel:
(0905) 820659. Cable: SMITHYSOUND. Chief Exec.: Muffi Murfin; Gen.
Mgr.: V.B. Murfin.

Harrison & Sons (London) Ltd., Printing House Ln., Hayes, Middx UB3 1HQ.
Tel: (01) 573-3828. Telex: 23744. Mng. Dir.: J.A. Modlock; Comm'l Dir.:
B.L. Hibbit; Sales Dir.: D.S. Robinson; Prod. Mgr.: M.S. Fritzerger

John Harwood-Bee Assocs., The Folly, Folly Island, Hertford, Herts. Tel:
(0992) 551233. Telex: 817861. Mng. Dir.: John Harwood-Bee.

Immediate Sound Servs. Ltd., 6 Drsmn Rd., London N1 5QJ. Tel: (01) 739-
9672. Telex: 914382. Mng. Dir.: J.W. Hart.

Independent Rec. Co., 39 Harmer St., Gravesend, Kent. Tel. (0474) 65687.
Chief Exec.: J.W. Dram.

Industrial Recs. Ltd., 10 Martello St., London E8. Tel: (01) 254-9178. Mng
Dir: Peter Christopherson. Gen. Mgr. Coasey P. Orridge; Sales Mgr.: David
Brooks; Gen. Exec.: Joyce Sinclair.

J S D Group of Cos., 62 Berners St., London W1P 3AG. Tel: (01) 580-4720.
Telex: 261298. Mng. Dir.: Joseph R. Stanley; Gen. Mgr.: N.P.J. Murray

Jab Org Ltd., 100 Wardour St., London W1. Dir. John Bright
Ellie Jay (Prod's) Ltd., 97 Judd St., London WC1. Tel: (01) 388-5771. Mng.
Dir.: Jack Applebaum; Prod'n Mgr.: Andrew Sopot; Prod'n Co-Ord.: Paul
Heeren

T. Richard Johnson Ltd., MAM House, 24/25 New Bond St., London W1. Tel:
(01) 493-7535. Chm.: Terry Johnson; Mng. Dir.: Alan Smith.

Jubilee Graphics, 101 Wardour St., London W1 Tel (01) 437-8572
Keenpac Polyhene Supplies Ltd., Coronation Place, Guildhall Ln.,
Leicester. Tel: (0533) 20084, 537806.

Krystal Promos., 48 Abbeville Rd. S., Millhouses, Sheffield. Tel: (042)
365638

Steve Lane Musical & Publicity Servs., 12 Slough Ln., Kingsbury, London
NW9 8QL. Tel: (01) 205-2587. Owner: Steve Lane; Gen. Mgr.: K.C. Sear
Leader Sound Ltd., 209 Rochdale Rd., Greentland, Halifax, West Yorks. HX4
8JE. Tel: (0422) 76161. Mng. Dir.: Bill Leader. Sec'y: Helen Leader
Lindsey's Colour Serv., 88 Teedale St., London E2. Tel: (01) 729-5462.

Mng. Dir.: Ray Mack; Sales Dir.: David Wall.

London Features Int'l Ltd., Dorset Lodge, 8 Dorset Square, London NW1
6PU. Tel: (01) 723-4204. Cable: LDNPX. Telex: 25884. Mng. Dir.: John
M. Halsall. (Photo library & studio facility repro servs.)

M H G Recs., 40 Gunter Grove, London SW10 0UJ. Tel: (01) 352-2886. Chief
Exec.: Mary Harrison-Goudie. Gen. Mgr.: Rui De Castro

Metropolitan Communications, 8a Frolgar Gardens, London NW3 6UX. Tel:
(01) 435-8803. Mng. Dir.: Mark R.F. Hanau; Sales Mgr.: R. Hanau;
Admn.: A. Lohmeyer.

Modern Pub., New Ibernia House, Winchester Walk, London SE1. Tel (01)
403-6332. Chief Exec.: Alan Edwards. Gen. Mgr.: Eugene Manz.

Mushroom Studios, 18 W. Mill, Clifton, Bristol BS8 4BG. Tel: (0272) 35994,
35867. Chief Exec.: D. Ackerman; Gen. Mgr.: S.A. Ackerman (Rec only)

Music Radio Promos., PO Box 400, Kings Langley, Herts. Tel: (09277)
64014. Mng. Dir. & Gen. Mgr.: Mike Baron; Sales Mgr.: Peter Duncan;
Publ'g Dir.: Nik Oakley

Nelson Rec'g Studio, Nelson House, 93 Castle Hill Rd., Hindley, Wigan,
Lancs. WN2 4BH. Tel: (0942) 58777. Contacts: S. M. Millard, W. Leyland
P D Graphics Ltd., 14 Forest Rd., Woodford Green, Essex S04. Tel: (01) 504-
1549. Mng. Dir. Philip Duffy. Gen. Mgr.: John Copeman

Panda Recs., 2 Catherine St., Seaside, Llanelli, Dyfed, South Wales. Tel:
(05542) 58913, 52490. Dir.: Paul Adams; Sales Mgr.: Alan Phillips.

Pan-Graphics (Edinburgh) Ltd., 21 A Grosvenor St., Edinburgh, Scotland
EH12 5ED. Tel: (031) 225-9502. Creative & Art Dir. Jonathan F. Field
Phonogram Ltd., 50 New Bond St., London W1Y 9AA. Tel: (01) 491-4600.

Cable PHONDREC. Telex: 261583. Mng. Dir.: K.N. Malphant, Mktg. Mgr.:
T. Powell; A&R Dir.: B. Shepherd.

Pinnacle Recs., 9 Dean St., London W1V 5RL. Tel: (01) 734-4543 Telex &
896141. Drington. Chm.: Terry Scully. Gen. Mgr. Tony Berry. Sales Mgr.:
George Holloway

Pasces Publicity & Design, 4 Did Mill Rd., Hunton Bridge, Herts. Tel: Kings
Langley 64049.
Porter & Pocock Assocs Ltd., 72 Westfields Ave., London SW13 0AU. Tel:
(01) 878-4366/2595. Mng. Dir.: R. Alexander Porter

United Kingdom

• services

DESIGN & ARTWORK

A M C (Associated Mktg. Co.), The High St., Hatfield Broad Dak, Essex. Tel:
(0279-70) 671. Telex: 817606. Contacts: Don Morris, Janet Verdon

A P Creative Servs Ltd., 26/28 Brewer St., London W1R 3FW. Tel: (01) 734-
9823. Mng. Dir.: Anthony Palk; Gen. Mgr.: Steve Walker; Sales Exec.:
Gillian Bowman

Album Graphics (UK) Ltd., 2 Goodwin's Court, 55 St. Martin's Ln., London
WC2. Tel: (01) 240-1319. Telex: 21879, 25247 UK Rep., Linda Halpin.
(Record only)

Home office: USA, Chicago Ill.
Alfa Display & Design, 28 Beechwood, Fordingbridge, Hants. Tel: (0425)
53943. Chief Exec.: Colin Knagman.

Amazing Exhibitionists Ltd., 52/56 Church Path, London W4 5BN. Tel: (01)
995-3555. Telex: 21792. Ref. 3595. Dirs.: Janet Lamport, Lawrence
Miler, Alec Forbes.

Amberlec Rec

"Would you laugh out loud if I told you that by this time next year Track Tape Audio Cassettes will be as well known as Sony or Memorex?"

Start Laughing:

PART I

I'm Ingegerd Engfelt from Malmoe, Sweden.

I've just finished building the world's most modern magnetic tape plant, geared to produce as fine cassettes as the present state of the art permits. (Since the plant includes a research laboratory perhaps we can even advance the state of the art somewhat.)

This built-in audio quality is only the first reason why, by this time next year, I expect Track Tape to be mentioned in the same breath as Sony or Memorex; perhaps even a breath ahead.

But building a better mousetrap isn't enough any more. You have to build a better marketing strategy as well.

My marketing strategy for Track Tape

First, my design team has given Track Tape Cassettes an ultra-modern look to reflect their ultra-modern sound quality. So Track Tape Cassettes will look as beautiful as they sound.

Next, I'm attaching beautiful price tags to Track Tape Cassettes so that they'll sell beautifully as well.

Next, here comes the unique part of my strategy

A minute ago I said that I'm going to produce as fine cassettes as the state of the art permits, and perhaps even advance the state of the art.



But anybody can say this.

Talk is cheap. I'm putting my money where my mouth is.

I'm going to produce *only one quality* of each of the following kinds of cassettes:

1. Iron oxide low biased tape — *only the top quality.*
2. Chrome equivalent high biased tape — *only the top quality.*
3. Metal tape — *only the top quality.*

Here's why I chose this strategy

The major advantage of this marketing strategy is that it allows me to concentrate all my engineers' skills and experience on one quality only thus making the most of these skills — instead of diluting all this engineering over the conventional range of cassette qualities.

(But even if it wasn't good marketing strategy, this is what I would do anyhow. I *don't feel like* producing anything but the best. Period!)

Track Tape summed up so far:

• Track Tape's new, ultra-modern plant is geared to produce sound as superb as the state of the art permits.

• Track Tape is designed to look as superb as it sounds.

• Track Tape is priced to gratify all concerned including buyers of web and pancakes.

• Track Tape will stand for top quality only.

Now comes the most important part of all which I'll tell you about in the June 13th issue of Billboard."

Ingegerd Engfelt,
General Manager.

TRACK

Track Tape AB, Bronsåldersgatan 7,
Box 9031, S-200 39 Malmö, Sweden.
Tel. 40-22 45 60. Telex 33553 Track.

Distributors. Please read this before you write or call:

For each European country or region I prefer a small but highly professional distributor who is presently working with cassette hardware and/or non-competitive cassette lines. No one else will do.

Ingegerd Engfelt.

Positive Designs, Infotex House, Suite 6, 682 London Rd., Thornton Heath Surrey Tel (01) 680 9551 Chief Exec & Sales Mgr Steve Hutchins. Gen Mgr David Lucy

Real Custom Prod's. The Camp, Montgomery, Powys SY15 6LU Tel (068681) 427 Chief Exec Richard G Davies, Sales Mgr George B Pryce

Realmhealth Ltd., 15/23 Porteus Rd., London W2 Tel (01) 723 8495 Dir Bryan Whitman

Rock Art Studios, 10 Barley Mow Passage, Chiswick, London W4 Tel (01) 994 6477 Telex: 8811418 Mng Dir Peter Small, Mktg Mgr Mal Burns

Rooster Recs., PO Box 148, London W9 1DY Tel (01) 286 2993

S R T Rec. Prod's Ltd., 987 High Rd, Finchley London N12 Tel (01) 446 3218 Mng Dir George Bellamy, Gen Mgr J Townsend, Sales Mgr Dave Richardson

Sams Recs Servs (SRS), 78 Durham Rd., London SW20 Tel (01) 947 9000 Chief Exec Max Wright, Gen Mgr Andy Titcombe, Sales Mgr Barry Wright, Office Mgr Pat Savage

Seabrook/Graves/Aslett Assocs Ltd., 25 Dover St., London W1 Tel (01) 492 0451

Sea Cruise Prod's (UK), 35 Great Russell St., London WC1 Tel (01) 636 3925 Gen Mgr Terry Waghorne (Record only)
Home office: USA, Ken Keene Int'l

Senol Printing Ltd., 4 Hardwick Way, London SW8 4AJ Tel (01) 874 5775 Mng Dir M M Gunn, Dirs P L Smith, J H Rolfe

Shadow Creative Design, 17 Beaminster House, Dorset Rd London SW8 1EL Tel (01) 582 3510 Chief Exec Nigel Harris, Gen Mgr Colin Brown

Sound 1 Ogden's Mews, Maidenhead, Berks Tel (0628) 33011 Mng Dir I S Webb, Sales Mgr M Lloyd, Adv Mgr C McVie

Sound Conception, 85 Ashley Rd., Montpellier, Bristol 6 Tel (0272) 554 721 Chief Exec Chris David, Gen Mgr Kenny Wheeler (Rec only)

Simon Stable Promos., 46 West End, Launton, Oxfordshire Tel (08692) 2831 Mng Dir: Count S de la Bedoyere; Gen Mgr Judy Dyble, Sales Mgr Simon Stable

Steelguard Security Tape Display Systems, Pembroke Studios, 3A Bensham Ln West Croydon, Surrey Tel (01) 689 1877/7878 Mng Dir Paul Holmes, Gen Mgr Phillip Harrison, Sales Mgr Brian Forscutt

Storm Rec Studios, 133 Park Rd., Blackpool, Lancs FY1 4ET Tel (0253) 27357 23095 Mng Dir Wayne Paul, Gen Mgr Lenny Harris

Strathclyde Sound & Video Ltd., PO Box 59 Buchanan St Glasgow Scotland G2 1LR Tel (041) 221 2222 Telex 779047

Superstat Ltd., 17/18 Great Pulteney St., London W1R 3DG Tel (01) 437 4173 Mng Dir D Reade

T R J, see T Richard Johnson

Target Promos., The Studio, 1 Bensham Ln, Croydon, Surrey CRD 2RU Tel (01) 689 6618 Chief Execs A T Gregory, L J Adams, Sales Mgr & Sec'y Mrs M Souter, Export Mgr W Wright

Visualives Ltd., 19 Shorts Gardens, London WC2H 9AT Tel (01) 836 3004 Mng Dir Brian Cooke, Gen Mgr Allan Jones (Photography)

Wardour Motion Picture Co. Ltd., 11 Wardour Mews, London W1 Tel (01) 439 4313 Dir M J Sutton, Gen & Sales Mgr Christie Gillingham

West Central Printing Co. Ltd., 33/34 Rathbone Pl., London W1P 1AD Tel (01) 636 8572 Mng Dir H Leonard Temple, Gen Mgr Stan Heiser, Print Ed John Barry

Xanadu Constructional & Mechanical Eng's., 79 Fitzneal St., East Acton London W12 Tel (01) 743 3402 Mng Dir Paul Gadd, Co Dir & Sales Mgr Don Arden; Gen Mgr: Jeff Lynne (Rec only)

James Yorke Ltd., Oak House, High St., Northleach, Gloucestershire GL54 3ET Tel (04516) 666 Telex 858623 858393 Chief Exec J Scarlett, Sales Dir Peter Fanshawe, Studio Mgr Peter Rinne

Ziver Soker Sales, 74 Newman St., London W1P 3LA Tel (01) 580 3237

PRINTERS & LITHOGRAPHERS

A M C (Associated Mktg Co.), The High St Hatfield Broad Oak Essex Tel (0279 70) 671 Telex 817606 Contacts Don Morris, Janet Verdon

Album Graphics (UK) Ltd., 2 Goodwin's Court, 55 St Martin's Ln London WC2 Tel (01) 240 1319 Telex 21879, 25247 UK Rep Linda Halpin (Record only)
Home office: USA Chicago Ill

Amberlee Recs Ltd., 387 Harrow Rd., London W9 Tel (01) 866 7748 Mng Dir John Peters, Sales Mgr Dilean Lamas

Francis Antony Ltd., Trenance Mill, Blowinghouse Hill St Austell Cornwall PL25 5AH Tel (0726) 3476 61264

Arnold Reproduction Co., 77/79 Dudden Hill Ln., London NW10 1BD Tel (01) 459 6194 Dwner Stan Kitchen Gen Mgr Peter Hunt

Arrowtabs Ltd., Humber Rd., London NW2 6EP Tel (01) 450 2411 Telex 923034 Mng Dir Maurice Mindel Sales Mgr Alex Murray Prod Mgr Paul Rinne

Audicore Recs 387 Harrow Rd., London W9 Tel (01) 866 7748 Chief Exec K Mellor

Audiogenic Ltd., 34 36 Crown St., Reading, Berks RG1 2SN Tel (0734) 595647 Dir Martin Maynard

Radge Sales, 48 Carnaby St., London W1V 1PF Tel (01) 437 5121 Mng Dir William Smith, Gen Mgr Oscar Zanello Sales Mgr David Kerry

Balantyne Advertising Ltd., 11 Talbot Square London W2 Tel (01) 723 4439

Capricorn Graphics PO Box 1 Offerton Ind Estate Hemphash Ln Stockport SK2 5TX Tel (061) 480 8241

Caroline Exports Ltd., 56 Standard Rd., London NW10 6ES Tel (01) 961 2919 Cable BUMBLEBEE Telex 21264 Mng Dir A T Rose Studio/Electronics Exec C Stylianou

Cassette Developments (Audioisonic) Ltd., Micra House 138 Lower Mortlake Rd Richmond, Surrey TW9 2JZ Tel (01) 940 8186 Cable MICRONETICS Telex 8813481 Gen Mgr D Dixon (Tape only)

Cassette & Rec Servs Ltd., Eastcotts Rd., Bedford Tel (0234) 56317 Mng Dir P J Norbury Works Dir P Moore

Clout & Baker Ltd Chalkin Works, Parkwood Ind Estate Bircholt Rd Maidstone, Kent Tel (0622) 673261 Chm DP Chalkin Sales Dir John Benoy, Works Dir Robin Burr

Coach House Studio Div Ice Recs Ltd., 81 A Osbaldeston Rd Stamford Hill London N16 Tel (01) 806 3252 Mng Dir Eddy Grant Gen Mgr Alpine Grant Sales Mgr Rudolph Grant Financial Controller Stan Blackburn

Condor Litho Ltd 35 Sylvan Grove London SE15 Tel (01) 639 9911 Mng Dir Michael J Andrews Gen Mgr George Moss

L A Cousins & Ltd., 26 Grandson Ave., Hackney London E8 Tel (01) 985 4211 Owner L A Cousins, Gen Mgr S Franks

Cream Creative Mktg Ltd The Cloisters, 11 Salem Rd., London W2 Tel (01) 221 5155

Delga Press Ltd., Ongival House 8 Marlborough Rd Bromley Kent BR2 9NH Tel (01) 460 0112 Telex 8951346 Mng Dir R E Edwards Gen Dir R N Roadnight Dir R G Froment Sales Dir P H Grey

A/V/T-78

Duplitape 1 7 Harewood Ave London NW1 6LE Tel (01) 724 2497 Chief Exec & Gen Mgr B Lambden Sales Mgr R Jackson Moore

E C Graphics Ltd (div of Tinsley Robor Group Ltd.) 67 Rosoman St London E1 Tel (01) 278 8054 Telex 267985 Mng Dir R D Vickers, Sales Mgr T D Stevens

Elie Jay (Prod) Ltd 97 Judd St London WC1 Tel (01) 388 5771 Mng Dir Jack Applebaum, Prodn Mgr Andrew Sogel, Prodn Co Ord Paul Heeren

Finn Grafiks Ltd., 8 Marlborough Rd., Bromley, Kent Tel (01) 658 3029

Format (Sussex) Ltd (div of Tinsley Robor Group Ltd.), Jubilee Rd, Burgess Hill Sussex Tel (04446) 45245 Telex 87322 Mng Dir Ted Light

Garrod & Lofthouse Ltd., Chaldon Rd., Caterham on the Hill, Surrey Tel (01) 878 45266 Telex 262554 Chm & Mng Dir Norman J Garrod, Sales Mgr Christopher Garrod

Golden Era Recs Ltd., 1099 A Finchley Rd London NW11 Tel (01) 455 6620 Dir Bert Wilcox

Gramplan Recs Ltd Airport Ind'l Estate, Wick, Caithness, Scotland Tel (0955) 2787 Telex 75107 Dir J Johnston, Mgr John Hunter

Halstan & Co Ltd., Plantation Rd Amersham, Bucks HP6 6HJ Tel (02403) 5525 Cable HALSTANSIC Mng Dir R E Smith, Sales Mgr W Shrimpton, Ass't Sales Mgr L Thorpe, Sec'y R Yerby

H Annibal & Co Ltd., Pinfold Rd., Thurleston, Leicester LE4 8AP Tel (0533) 695413 Telex 34627 Mng Dir Chris Hetherington, Ass't Mng Dir Roger Stewart, Music Div Sales Dir Derek Deighton

Harrison & Sons (London) Ltd Printing House Ln, Hayes Middx UB3 1HQ Tel (01) 573 3828 Telex 23744 Mng Dir J A Modlock, Comm'l Dir B L Hibbit Sales Dir D S Robinson, Prod Mgr M S Fitzgerald

John Harwood Bee Assocs The Folly Folly Island Hertford Herts Tel (0992) 551233 Telex 817861 Mng Dir John Harwood Bee

Howards (Slough) Printers Ltd Mill St Slough Berks SL2 5DT Tel (0753) 32271 Sales Dir Tony Thompson

Independent Rec Co., 39 Harmer St Gravesend Kent Tel (0474) 65687 Chief Exec J W Oram

Jab Dag Ltd 100 Wardour St., London W1 Dir John Bright

Jubilee Graphics, 101 Wardour St London W1 Tel (01) 437 8572

K K Tape Servs., Norfolk Street Studio Norfolk St., Worthing Sussex BN11 4BB Tel (0903) 205053

Keepac Polythene Supplies Ltd Coronation Place Guildhall Ln Leicester Tel (0533) 20084, 537806

Steve Lane Musical & Publicity Servs 12 Slough Ln Kingsbury London NW9 8QL Tel (01) 205 2587 Owner Steve Lane Gen Mgr K C Sear

Lindsey's Colour Serv 88 Teesdale St London E2 Tel (01) 729 5462 Mng Dir Ray Mack, Sales Dir David Wall

Nelson Rec'g Studio, Nelson House, 93 Castle Hill Rd Hindley, Wigan, Lancs WN2 4BH Tel (0942) 58777 Contacts S M Millard, W Leyland

Nightingale Music Ltd., Berkeley Square House, 12 Berkeley Square, London W1 Tel (01) 491 3070 Telex 25460 Mng Dir John Gaydon

Porter & Pocock Assoc. Ltd., 72 Westfields Ave., London SW13 0AU Tel (01) 878 4366 2595 Mng Dir R Alexander Porter

Production Express Int'l 19 Kynaston Rd, Bromley Kent Tel (01) 857 2713 Telex 8813831 Mng Dir Bobbie Dahdi

Real Custom Prod's The Camp, Montgomery, Powys SY15 6LU Tel (068681) 427 Chief Exec Richard G Davies Sales Mgr George B Pryce

Realmhealth Ltd., 15/23 Porteus Rd., London W2 Tel (01) 723 8495 Dir Bryan Whitman

Rock Art Studios, 10 Barley Mow Passage, Chiswick London W4 Tel (01) 994 6477 Telex: 8811418 Mng Dir Peter Small, Mktg Mgr Mal Burns

Rooster Recs., PO Box 148, London W9 1DY Tel (01) 286 2993

Sea Cruise Prod's (UK) 35 Great Russell St., London WC1 Tel (01) 636 3925 Gen Mgr Terry Waghorne (Record only)
Home office: USA, Ken Keene Int'l

Senol Printing Ltd 4 Hardwick Way London SW18 4AJ Tel (01) 874 5775 Mng Dir Mrs M M Gunn Dirs P L Smith J H Rolfe

Shalford Press Ltd 85b Bradford St Braintree, Essex CM6 6AU Tel (0376) 2125 Mng Dir R Capon

Shorewood Packaging Co Ltd, Colledge Rd, Aston Clinton, Bucks HP2 5EZ Tel (0296) 630421 Telex 83495 Gen Mgr Denis Rex, Sales Mgr Lionel Rose, Works Mgr Reg Ward
Home office: USA, New York, N Y

Sound, 1 Ogden's Mews, Maidenhead, Berks Tel (0628) 33011 Mng Dir I S Webb Sales Mgr M Lloyd, Adv Mgr C McVie

Robert Stace & Co Ltd, Chalkin Works, Longfield Rd, Tunbridge Wells, Kent Tel (0892) 24225 Telex 95577 Chm & Mng Dir P W Barker Ass't Mng Dir A G Long, Sales Dir D Brewer

Steelguard Security Tape Display Systems, Pembroke Studios 3A Bensham Ln, West Croydon Surrey Tel (01) 689 1877 7878 Mng Dir Paul Holmes, Gen Mgr Phillip Harrison, Sales Mgr Brian Forscutt

Templering Ltd 29 Wates Way, Mitcham, Surrey Tel (01) 640 3025 Sales Mgr Henry Dyson

Vineyard Prod's, 56 Standard Rd London NW10 Tel (01) 961 2919 Cable BUMBLEBEE Chief Exec Brian Leate

West Bros Printers Ltd., 12 Milton Rd, Aylesbury, Bucks Tel (0296) 23211 Telex 837216 Mng Dir Peter G West Gen Mgr H E V Pinnell Sales Mgr Derek Higgs

West Central Printing Co Ltd 33/34 Rathbone Pl London W1P 1AD Tel (01) 636 8572 Mng Dir H Leonard Temple Gen Mgr Stan Heiser Print Ed John Barry

P G Wood & Son (Printers) Ltd 32 Church St., Dagenham Essex RM10 9UU Tel (01) 595 5115 Telex 897417 Mng Dir Peter Wood, Gen Mgr Chris Sanford Sales Mgr Phil Douglas, Works Mgr Greg Bell

James Yorke Ltd., Oak House, High St., Northleach, Gloucestershire GL54 3ET Tel (04516) 666 Telex 858623 858393 Chief Exec J Scarlett, Sales Dir Peter Fanshawe, Studio Mgr Peter Rinne

Ziver Soker Sales, 74 Newman St London W1P 3LA Tel (01) 580 3237

TAPE CUSTOM DUPLICATORS

TAPE PACKAGING & LABELING

The Audio and Video lines indicate the configurations which the firms duplicate. Companies which offer packaging and labeling of tape product are indicated by "(PKG)" which appears after the main body of their respective listings.

Aardvark Design & Publicity 145 Croydon Rd., Beckenham, Kent BR3 3RB Tel (01) 658 4386 Mng Dir Paul Smith (PKG)

Ablex Ltd (sub of Decca Ltd.) Harcourt, Halesfield 14, Telford Salop TF7 4QR Tel (0952) 584131 Telex 35649 Mgr Peter Banks
Audio: Cassette

Amberlee Recs Ltd., 387 Harrow Rd London W9 Tel (01) 866 7748 Mng Dir John Peters, Sales Mgr Orlean Lamas (PKG)
Audio: Cassette, open reel

Anemone Sound Facilities Ltd 10A Poland St London W1 Tel (01) 439

9611 Telex 8812286 Mng Dir Aaron Gershfield, Gen Mgr Derek Hanlon Sales Mgr Simon Patrick (PKG)
Audio: 8 tr. cassette

Audicore Recs., 387 Harrow Rd London W9 Tel (01) 866 7748 Chief Exec K Mellor (PKG)
Audio: Cassette, open reel

Audiogenic Ltd., 34 36 Crown St., Reading, Berks RG1 2SN Tel (0734) 595647 Dir Martin Maynard. (PKG-audio & Video)
Audio: Cassette, open reel

Audio + Video Ltd., Video House, 48 Charlotte St., London W1P 1LX Tel (01) 580 7161 Telex 22345 Mng Dir Irvin C Pannaman, Sales Mgr Andrew Bourne, Adv Mgr D Ubsdell (PKG)

Garrod: 2" quad, 1" helical, 1/2" cassette, 1/4" Beta & VHS cassette

Ivan Berg Assocs (Audio Publi) Ltd., 35A Broadhurst Gardens London NW6 3QT Tel (01) 624 7785 Mng Dir Ivan Berg (PKG-audio only)
Audio: Cassette

Bibr Magnetics Ltd., 101/105 Plough Rd., London SW11 2BJ Tel (01) 223-5955 Telex 917732 Dir K H Bourke Borrowes, Gen Mgr M Shepherd
Audio: Cassette

Bird Sound Studios, 4 Welton Rd., Wedgwood Estate, Warwick CV34 5YA Tel (0926) 45214 Owner Sheila L. Bird, Gen Mgr David Crawlings, Sales Mgr Dave Sheriff, Promo Dave Ling
Audio: Cassette

Harvey Bual, 84 Church St., London NW8. Tel (01) 724 3711 Chief Exec Alan Taub
Audio: Cassette

C B S Mfg (div of CBS (UK) Ltd.) 17/19 Soho Square London W1V 6HE Tel (01) 734 8181 Cable COLRECMAN Telex 24203 Mng Dir John A Wheeler (PKG)
Audio: Cassette

Ca Va Rec's Studios, 201 St Vincent St., Glasgow, Scotland Tel (041) 221 9407 Cable CAVA Chief Exec Brian Young, Sales Mgr Alson Bye, Ass't Studio Mgr Cy Jack
Audio: Cassette

Caroline Exports Ltd., 56 Standard Rd., London NW10 6ES Tel (01) 961 2919 Cable BUMBLEBEE Telex 22164 Gen Mgr Dave Loader, Projects Programs C Stylianou (PKG only)

Cassette Developments (Audioisonic) Ltd., Micra House 138 Lower Mortlake Rd Richmond, Surrey TW9 2JZ Tel (01) 940 8186 Cable MICRONETICS Telex 8813481 Gen Mgr D Dixon (PKG)
Audio: Cassette

Cassette Rec'g Co (UK) Ltd., Unit 2, Riverway, Harlow, Essex CM20 2DN Tel (0279) 39256 Mng Dir H L Collins; Gen Mgr Michael Newton, Mktg Dir C J Sanford
Audio: Cassette

Castle Studio, 93 Castle Hill Rd, Hindley, Wigan, Lancs WN2 4BH Tel (0942) 58777 Chief Exec Simon Paul Millard
Audio: Cassette, open reel
Video: 1/2" cassette, VHS

Cintron Group, Grove House, 551 London Rd., Isleworth Middx TW7 4DS Tel (01) 568 0131 Telex 935054
Video: 1" helical open reel, 1/2" U matic, 1/4" Beta & VHS cassette

Club Video Ltd., 120 Marylebone Ln., London W1M 5FZ Tel (01) 935 2464 Telex 23733
Video: 1/2" U matic, 1/4" VHS

Coach House Studio Div Ice Recs Ltd., 81-A Osbaldeston Rd., Stamford Hill, London N16 Tel (01) 806 3252 Mng Dir Eddy Grant, Gen Mgr Alpine Grant, Sales Mgr Rudolph Grant, Financial Controller Stan Blackburn
Audio: Cassette

Contek Magnetics Ltd 90 Walnut Tree Close, Guildford Surrey GU1 4UJ Tel (0483) 503222 Telex 859403 Mng Dir Gerald P Creagh, Comm'l Mgr Fred MacDonald
Audio: Cassette

Cream Creative Mktg Ltd The Cloisters, 11 Salem Rd London W2 Tel (01) 221 5155 (PKG only-audio & video)

D T P Inc., 31 Alfred St., Weston Super Mare, Avon BS23 1PZ Tel (0934) 21932 Mng Dir Don Todd
Audio: Cassette, open reel
Video: 1" open reel

Decca Rec Co Ltd, see Ablex

Discussions Ltd., 36 Crescent Rd., Tunbridge Wells, Kent TN11 2LZ Tel (0892) 26397 Mng Dir Robert F Hardcastle, Gen Mgr Anthony James
Audio: Cassette, open reel

Duplitape 1 7 Harewood Ave., London NW1 Tel (01) 724 2497 Telex 21879 Chief Exec & Gen Mgr B Lambden Sales Mgr R Jackson Moore
Audio: Cassette

E M I Recs (UK) Ltd., 1/3 Uxbridge Rd., Hayes, Middx UB4 0SY Tel (01) 561-8722 Mng Dir R Lopez, Ass't Dir R Shenton, Special Projects Mgr DL Watson
Audio: Cassette

Evangelical Rec's, 152 Rowledge Rd., Rowledge Colchester, Essex CO5 7JP Tel (0206) 865769 Dir M Lear
Audio: Cassette

Fraser Peacock Assocs Ltd., 94 High St., Wimbledon Village, London SW19 5EG Tel (01) 947 7551 Dirs David R Tuckman, G F Peacock
Audio: Cassette

Free Range Rec Studios, 22 Tavistock St London WC2A 7PH Tel (01) 836 7608 Chief Exec Marsha Abson, Gen Mgr D B Grisdale, Sales Mgr Neville Willis
Audio: Cassette
Video: 1/2" U matic cassette, 1/4" Beta & VHS cassette

Garrod & Lofthouse Ltd., Chaldon Rd., Caterham on the Hill, Surrey Tel (01) 878 45266 Chm & Mng Dir Norman J Garrod, Sales Mgr Christopher Garrod (PKG only)

Golden Era Rec's Ltd., 1099 A Finchley Rd London NW11 Tel (01) 455 6620 Dir Bert Wilcox (PKG)
Audio: 8 tr. cassette, open reel

Gramplan Recs Ltd., Airport Ind'l Estate, Wick, Caithness Scotland Tel (0955) 2787 Telex 75107 Dir J Johnston Mgr John Hunter
Audio: Cassette

H & R, 255 Liscard Rd., Wallasey, Merseyside Tel (051) 639 9270 Mng Dir David Crosby, Gen Mgr Roger Baskeyfield, Ass't Gen Mgr Peter Coleman (PKG-audio only)
Audio: Cassette

Happy Face Music, The Old Smithy, Post Office Ln., Kempsey, Worcs WR5 3NS, Tel (0905) 820 659, 820 566 Cable SMITHYSOUND Chief Exec Muff Murfin, Gen Mgr Y B Murlin
Video: 1/2" Beta & VHS cassette

Humberside Studios Grimsby Rd., Laceby, Grimsby South Humberside Tel (0472) 40152 71582 Chief Exec L A Johnson

Audio: Cassette, open reel.
B C Sound Rec'g Studios Ltd., 35 Portland Pl., London W1N 3AG. Tel (01) 637-2111. Telex. 264413 Mng Dir John D. Tucker. Technical Dir Dennis King; Studio Mgr Michael Claydon. (PKG)
Audio: Cassette, open reel
Immediate Sound Servs Ltd., 6 Orsman Rd., London N1 5QJ. Tel (01) 739-9672 Telex 914382 Mlg Mgr J W Hart (PKG)
Audio: 8-tr. cassette
Independent Rec Co., 39 Harmer St., Gravesend, Kent Tel (0474) 65687.
Chief Exec.: J W Dram.
Audio: 8-tr. cassette, open reel
Industrial Recs. Ltd., 10 Martello St., London E8. Tel (01) 254 9178 Mng. Dir.: Peter Christopherson, Gen Mgr. Cosy P-Orridge. Sales Mgr. David Brooks; Gen. Exec. Joyce Sinclair.
Audio: Cassette
Elite Jay (Prod'ns) Ltd., 97 Judd St., London WC1. Tel (01) 388-5771 Mng Dir. Jack Applebaum. Prod Mgr. Andrew Sopol. Prod'n Co-Ord Paul Heeren
Audio: Cassette, open reel
Intervision Video Ltd., McKay Trading Estate, Unit 1, Kensal Rd., London W10. Tel (01) 969-8210 (PKG)
Video: 1" helical, 1/2" U-matic
J S O Group of Cos., 62 Berners St., London W1P 3AG Tel (01) 580 4720 Telex: 261298. Mng Dir Joseph R. Stanley; Gen. Mgr.: N P J Murray
Video: 1" cartridge, 1/2" U-matic cassette, 1/2" EIAJ cartridge
K K Tape Servs., Norfolk Street Studio, Norfolk St., Worthing, Sussex. BN11 4BB Tel (0903) 205053.
Audio: Cassette
Kay Labs. Ltd., 22 Soho Square, London W1V 5FJ Tel (01) 437-7811. Telex 28483 (Video only)
S Kemper Ltd., 498 Honeyoil Ln., Stanmore, Middx HA7 1JZ Tel (01) 952-5262. Telex: 21400 Sales Dir Paul R.S. Rogers; Sales Mgr. Aidan Coles (PKG only-audio & video)
L T S. see London Transcription Servs
Leader Sound Ltd., 209 Rochdale Rd., Greetland, Halifax, West Yorks HX4 8JE Tel (0422) 76161 Mng. Dir. Bill Leader; Sec'y Helen Leader
Audio: Open reel
Lingaphone Institute Ltd., Trading Estate, 252/253 Argyle Av. Slough, Berks SL1 4HA, Tel Slough 23200. Telex 849377 Div Mgr. John King
Audio: Cassette
London Transcription Servs., 23 Denmark Pl., London WC2H 8NL Tel (01) 836-7148
Audio: Cassette, open reel
Magnetic Video UK. 1 Pervale Park, Greenford, Middx Tel (01) 997 2552 Sales Dir J R Daly
Video: 1/2" Beta, VHS & V 2000 videocassette
Metropolitan Communications. 8a Frolgal Gardens, London NW3 6UX Tel (01) 435-8803 Mng Dir: Mark R.F. Hanau. Sales Mgr R Hanau, Admn A Lohmeyer.
Audio: Cassette
Video: 1/2" cassette
Mushroom Studios. 18 W Mall, Clifton, Bristol BS8 4BG. Tel: (0272) 35994, 35867 Chief Exec D. Ackerman, Gen Mgr S A Ackerman
Audio: 8 tr. cassette, open reel.
Nelson Rec'g Studio, Nelson House, 93 Castle Hill Rd., Hindley, Wigan, Lancs WN2 4BH. Tel (0942) 58777 Contacts S M Millard, W Leyland
Audio: Cassette
Video: 1/2" cassette, 1/2" VHS cassette
Old Smyth Rec'g Studio, Old Smyth Post Office Ln., Kempsey, Worcs Tel (0905) 820659 Chief Exec Muff Murlin, Gen Mgr Val Biddle, Engs Colin Owen, Paul Robbins, Robin Sidebotham.
Audio: Cassette
Video: 1/2" Beta & VHS cassette
P M S Mail Order Handling, The High St., Hatfield Broad Dax, Essex Tel (0279) 70671. Telex 817606. Mgr. Lynda Murphy. (PKG only)
Pebble Recs Ltd., 46 Maddox St., London W1 Tel (01) 629 3266, 491 4140. Telex 25247. Mng. Dir. James Pollard. Gen Mgr. Julia Slocombe.
Audio: 8-tr. cassette, open reel
Phonogram Ltd., 50 New Bond St., London W1Y 9HA. Tel (01) 491-4600 Cable PHONREC Telex 26:583 Mng Dir K N Maliphant, Mktg Mgr T Powell, A&R Dir. B. Shepherd, Tape Mgr Roy Wilkins
Audio: Cassette
Plant Life Recs Ltd., Edison Chambers, 109A Bancroft, Hitchin, Herts Tel (0462) 58555 Chm Nigel Pegrum, Gen Mgr. Geoffrey Ide, Sales Mgr John Garrad
Audio: 8-tr
PolyGram Rec. Dpns. Ltd., Walthamstow Ave., London E4 8SZ. Tel (01) 527 2300 Telex 896383 Tech Dir W W Bryant, Factory Mgr. V Gowland, Tape Prods. Mfg Mgr. F W. Street
Audio: Cassette
Production Express Int'l., 19 Kynaston Rd., Bromley, Kent Tel (01) 857 2713 Telex 8813831 Mng. Dir Bobbie Dahdi
Audio: Cassette
Real Custom, The Camp, Montgomery, Powys SY15 6LU Tel (068681) 427 Mgr G.R. Davies.
Audio: Cassette
S R T Rec. Prod'ns Ltd., 987 High Rd., Finchley, London N12 Tel (01) 446-3218 Mng Dir George Bellamy. Gen Mgr J Townsend. Sales Mgr Dave Richardson.
Audio: Cassette
Scorpio Sound Ltd., 19/20 Euston Centre, London NW1 3JH Tel (01) 388 0263 Telex 8814427 Mgr. Peter Hoskins (Video only)
Sentinel Recs (Cornwall) Ltd., Paul, Penzance, Cornwall, Tel. (0736) 73246 Telex 45608 Chief Exec & Gen Mgr. Job Morris
Audio: Cassette
Sound, I Dgdershaw Mews, Maidenhead, Berks Tel (0628) 33011 Mng Dir. I.S. Webb; Sales Mgr M Lloyd, Adv Mgr. C. McVie
Audio: Cassette.
Video: 1/2" U-matic cassette, 1/2" VHS cassette.
Soundpost Studios, Fircliff House, Portishead, Bristol, Avon BS20 9HQ Tel (0272) 842209. Dir.: Peter Kennedy
Audio: Cassette
Spaceward Ltd., 34 35 Clarendon St., Cambridge CB1 1JP. Tel (0223) 64263 Mng Dir Gary Lucas
Audio: Cassette, open reel.
Video: 1/2" cassette, 1/2" Beta & VHS cassette
Spot Recs Ltd., 64 S. Molton St., London W1. Tel: (01) 499-7173. Gen. & Studio Mgr. Kate Hudson Local branch: 11A Sharpshill St., London NW1. Tel: (01) 586-7746
Audio: Cassette, open reel
Video: 1" helical.
Storm Rec'g Studios, 133 Park Rd. Blackpool, Lancs FY1 4ET Tel (0253) 27357, 23095 Mng Dir: Wayne Paulo; Gen. Mgr. Lenny Harris
Audio: Cassette.

Strathclyde Sound & Video Ltd., PO Box 59, Buchanan St., Glasgow, Scotland G2 1LR. Tel: (041) 221-2222 Telex: 779047
Audio: Cassette, open reel
Video: 1/2" Beta & VHS cassette, 1/2" Philips 2000 cassette
T O Rec'gs. 1 Cleveland Park Crescent, Waltham Forest, London E17 Tel (01) 520-0414
T R A D Electronics Sales Ltd., 149B St Albans Rd., Watford, Herts WD2 5BB Tel: (023) 47988 Telex: 262741. Mng. Dir.: J.E. Southard.
Audio: Cassette
Tape Copying Servs Ltd., 199A Gloucester Pl., London NW1 6BU. Tel: (01) 723 6301 Dirs. Robert Austin, Linda Curtis, John Groves
Audio: Cassette.
The Tape Dupl'g Co. Ltd., 4-10 North Rd., Islington, London N7 9HN Tel (01) 609-0087 Telex: 264773. Mng. Dir.: Peter Robey (PKG)
Audio: Cassette
Television Int'l Opns. Ltd. (TVI). 9-11 Windmill St., London W1P 1HF. Tel: (01) 637-2477 Cable: INCOLOUR. Telex. 268208
Video: 2" quad & helical, 1" helical, 1/2" U-matic cassette, 1/2" Beta & VHS cassette
Theatre Projects Servs. Ltd. Rec'g Studio. 11/13 Neals Yard, Monmouth St., London WC2 Tel (01) 836-1168. Cable THEATRELIT Telex 27522 Mng Dir John Ball. Studio Mgr.: Roger Norwood.
Audio: Open reel
Wardour Motion Picture Co. Ltd., 11 Wardour Mews, London W1 Tel (01) 439-4313. Dir. M J Sutton. Gen & Sales Mgr.: Marc Eskenazi (PKG)
Video: 1/2" VHS cassette.
World of Video 2000 Ltd., Cassette House, 329 Hunslet Rd., Leeds LS10 1NJ Tel: (0532) 706066. Telex 55293 Mng Dir Raymond Linton; Gen Mgr. Yusuf Nurgat. Sales Dir. Colin W Marler (PKG-video only)
Video: 1/2" Beta & VHS cassette, 1/2" cassette
James Yorke Ltd., Oak House, High St Northleach, Gloucestershire GL54 3ET. Tel (04516) 666 Telex 858623, 858393 Chief Exec. J Scarlett; Sales Dir. Peter Fanshawe. Studio Mgr Peter Rinne (PKG)
Audio: Cassette

TAPE DUPLICATOR/MARKERS

Metropolitan Communications. 8A Frolgal Gardens, London NW3 6UX Tel (01) 435-8803 Mng Dir Mark R.F. Hanau. Sales Mgr.: R. Hanau; Admn A Lohmeyer.
Labels: Belmont, Talkie Tapes, Venus.
Pebble Recs Ltd., 46 Maddox St., London W1 Tel (01) 629-3266, 491-4140. Telex. 25247. Mng. Dir.: James Pollard. Gen Mgr. Julia Slocombe.

• supplies

CARTRIDGE & CASSETTE PARTS

C S B Ltd., 5/7 Carnaby St., London W1V 1PG Tel (01) 439 9281 Telex 896691 Mng Dir Mafalda Hall. Dir & Prod'n Mgr: Mike Shaw; Sales Mgr Paul Cumming. Int'l Caroline Lacy-Thompson
Cosmocord Ltd., Eleanor Cross Rd., Waltham Cross, Herts EN8 7NX Tel Lea Valley 716-666 Cable ACDS WALTHAM CROSS Telex 24294 Mng Dir V J Snyer. Sales & Mktg Dir G E Brewin
E M I Tape Ltd., Tape House, Dawley Rd., Hayes, Middx UB3 1BT Tel (01) 573 3888 Cable EMITAPE LONDON Telex 932161 Mng Dir E A Naef. Comm'l Controller P K Mitchell. Gen Sales Mgr P Sollitt, Mktg Mgr M W Cross
Audio: Cassette parts
Landmark (Precision Mouldings) Ltd., 2 Albone Way, Langford Rd., Biggleswade, Beds. Tel (0767) 314-231 Telex 23384 Mng Dir David Ritchie. Prod'n Dir George Jardine. Works Dir Don Pearson
Branch: Potters Bar, Herts., Deneway House, Darkes Ln
Audio: Plastic molded parts
Musonicon, see Ziphurst
Professional Tapes Ltd., Cassette House, 329 Hunslet Rd., Leeds LS10 1NJ Tel (0532) 706066 Telex 55293 Mng. Dir. Raymond Linton. Gen Mgr Yusuf Nurgat. Sales Dir. Colin W Marler
Audio: Screws for cassette assembly
Pyral Magnetics Ltd., Courtlands Rd., Eastbourne, Sussex Tel (0323) 638 965. Mng Dir H J Hutchings. Sales Mgr. James Hutchings
S & B Export Servs. see Ziphurst
S & B Trading, see Ziphurst
Thorn Consumer Electronics Ltd., 284 Southbury Rd., Enfield, Middx EN1 1TJ Tel (01) 366-1155. Telex: 263201 Mng Dir, R.E Norman, Sales Dir J Ross, Adv Mgr M I Doman
Audio: Cassette mechanisms
Ziphurst Ltd., Stylus House, 34/38 Verulam Rd., St Albans, Herts AL3 4DF Tel (0727) 50611 Telex: 28675 Mng. Dir. P.H. Blank, Gen Mgr Stephen H Blank, Sales Dir B Blank, Warehouse Mgr. D N Lever
Audio: Cassette parts

EMPTY CARTRIDGES, CASSETTES & REELS

Ablex Ltd (sub of Decca Ltd). Harcourt, Halesfield 14, Telford, Salop TF7 4QR Tel (0952) 584131 Telex 35649 Mgr Peter Banks.
Audio: Cassette
Akai (UK) Ltd., Haslemere Heathrow Estate, Unit 12, Silver Jubilee Way, Hounslow TW4 6NF Tel (01) 897 7171 (Video only)
Audiopak/EMI, see Lee
Avcom Systems Ltd., Newton Works, Stanlake Mews, London W12 7HA Tel (01) 749 2201 Cable CINEPRD Telex 892513. Mng. Dir.: Eric R. Bas tm. Sales Dir Nick Gillieron. Adv Mgr Bridget King
Audio: Cassette
C B S Mfg (div of CBS (UK) Ltd.), 17/19 Soho Square, London W1V 6HE Tel (01) 734 8181 Cable COLRECMAN. Telex 24203 Mng Dir John A Wheeler
Audio: Cassette
C S B Ltd., 5/7 Carnaby St., London W1V 1PG Tel (01) 439-9281 Telex 896691 Mng Dir Mafalda Hall. Dir & Prod'n Mgr: Mike Shaw; Sales Mgr Paul Cumming. Int'l Caroline Lacy-Thompson
Copel, see Cosmocord
Cosmocord Ltd., Eleanor Cross Rd., Waltham Cross, Herts. EN8 7NX Tel Lea Valley 716-666 Cable ACDS WALTHAM CROSS. Telex 24294 Mng Dir V J Snyer. Sales & Mktg Dir G E Brewin
Audio: 8 tr. cassette, open reel
Audio: Brand name: Copel
E M I Tape Ltd., Tape House, Dawley Rd., Hayes, Middx UB3 1BT Tel (01) 573 3888 Cable EMITAPE LONDON Telex 932161 Mng Dir E A Naef. Comm'l Controller P K Mitchell. Gen Sales Mgr P Sollitt, Mktg Mgr M W Cross (Audio & Video)
Fidelipac, see SIS
Fraser Peacock Assocs Ltd., 94 High St., Wembleton Village, London SW19 5EG Tel (01) 947 755 Dir David R Tuckman
Audio: Cassette
Video: Cassette
Landmark (Precision Mouldings) Ltd., 2 Albone Way, Langford Rd., Biggles

wade, Beds Tel (0767) 314-231. Telex 23384 Mng Dir David Ritchie. Prod'n Dir George Jardine; Works Dir. Don Pearson.
Branch: Potters Bar, Herts., Deneway House, Darkes Ln
Audio: 8-tr. cassette
Lee Eng'g Ltd., Napier House, Bridge St., Walton-on-Thames, Surrey KT12 1AP Tel: Walton-on-Thames 43124. Cable: LEETECH. Telex: 928475 Mng Dir. Thomas Lee. Gen Mgr.: Chris Welsh, Sales Eng J Trevnor
Audio: NAB Cartridge.
Brand name: Audiopak/EMI
Musonicon, see Ziphurst
National Panasonic (UK) Ltd., 300-318 Bath Rd. Slough, Berks SL1 6JB Tel (0753) 34522. Cable. PANASDNIC Telex: 847652. Mng. Dir.: A. Imura. Sales Mgr T Nishigaki; Adv. Mgr.: P Hamblin.
Branches: Falkirk, Stirlingshire, Scotland, Etna Rd. Tel: (0324) 20821. Reg'l Sales Mgr. A. Douglas-Normanton, Wakefield, Yorks., Don Pedro Ave. Tel: (0924) 890980. Reg'l Sales Mgr.: K. Spencer.
Video: 1/2" U-matic, 1/2" VHS cassette, 1/2" EIAJ open reel, 1/2" EIAJ cartridge.
Brand name: Panasonic
Panasonic, see National Panasonic
Professional Tapes Ltd., Cassette House, 329 Hunslet Rd., Leeds LS10 1NJ Tel (0532) 706066. Telex: 55293 Mng Dir Raymond Linton. Gen Mgr Yusuf Nurgat. Sales Dir. Colin W Marler
Audio: Cassette
S & B Export Servs. see Ziphurst.
S & B Trading, see Ziphurst
S I S Ltd., 57 St Andrews Rd., Northampton NN1 2PB Tel. (0604) 32965, 30559. Mng. Dir. O.P.D. Mitchell. Sales Mgr.: I. Brown.
Audio: NAB "A" & "C"
Brand name: Fidelipac.
Scotch, see 3M
Start, see Tape Dupl'g Co
The Tape Dupl'g Co. Ltd., Freedex House, 4 10 North Rd., Islington, London N7 9HN Tel (01) 609-0087. Telex 264773 Mng Dir Peter Robey
Audio: Cartridge, cassette.
Brand name: Start (Italy)
3 M United Kingdom Ltd., PO Box 1, 3M House, Bracknell, Berks. RG12 1JU Tel (0344) 26726 Telex 849371 Mng Dir: Donn Osmon, Ov. Dir.: P G Hutchings. Sales & Mktg Mgr C Hobbs, Mktg Co-ord P A Stockwell Jones
Reg'l sales offices: Belfast BT1 5JE, Northern Ireland, 11 Oonegall Square S Tel (0232) 42811, 42926-Birmingham B3 3EL, Edmund House, 12 22 Newhall St. Tel (021) 236-5077-Glasgow G4 0AY, Scotland, 3M House, 9 Canal St. Tel (041) 332-9622-London SE20 7TR, PO Box 38, Yeoman House, 63 Croydon Rd., Penge Tel (01) 659 2323-Manchester M15 4PA, 3M House, 28 Great Jackson St. Tel (061) 236 8500
Audio: 8 tr. cassette & open reel
Video: Open reel, cassette
Brand name: Scotch.
Ziphurst Ltd., Stylus House, 34/38 Verulam Rd., St Albans, Herts AL3 4DF Tel (0727) 50611 Telex: 28675 Mng Dir P H Blank; Gen Mgr: Stephen H Blank, Sales Dir: B Blank, Warehouse Mgr: O N Lever
Audio: Cassette
Brand name: Musonicon

PROFESSIONAL TAPE SUPPLIES

A T (Associated Tape) Ltd., 214 Bowes Rd., Southgate, London N11 Tel (01) 368 2309 (Importer)
Audio: Automatic 8-tr changer
Brand name: Telex.
Amos of Exeter Ltd., Wercliffe Court, Exwick, Exeter, Devon EX4 2AG Tel (0392) 72 132 Cable AMDS EXETER Telex 42786. Mng. Dir. R E Amos
Audio & Video: Bulk tape erasers
Brand name: Wercliffe
Balantime Advertising, 11 Talbot Square, London W2. Tel. (01) 723-4439
Audio: Cassette labels
Cream Creative Mktg. Ltd., The Cloisters, 11 Salem Rd., London W2. Tel (01) 221 5155
Audio: Cassette labels
Video: Cassette labels
Edittal, see Scenic Sounds
Elite Jay (Prod'ns) Ltd., 97 Judd St., London WC1 Tel (01) 388 5771 Mng Dir Jack Applebaum, Prod'n Mgr Andrew Sopol, Prod'n Co-ord.: Paul Heeren
Audio: Cassette labels
Video: Cassette labels
A C Farnell Ltd., Kenyon Ltd., Sheffield S1 4BD Tel (0742) 78901.
Audio: Bulk erasers
Format (Sussex) Ltd. (div of Tinsley-Robor Group). Jubilee Rd., Burgess Hill, Sussex Tel (04466) 45245
Audio: Cassette inlay cards
Golden Era Recs Ltd., 1099-A Finchley Rd., London NW11 Tel (01) 455 6620 Dir Bert Wilcox
Audio: Cassette labels
K K Tape Servs., Norfolk Street Studio, Norfolk St., Worthing, Sussex. BN11 4BB Tel (0903) 205053
Audio: Cassette labels
Lindsey's Colour Serv., 88 Teesdale St., London E2 Tel (01) 729 5462 Mng Dir Ray Mack, Sales Dir. David Wall
Audio: Cassette labels
Video: Cassette labels
Robor Ltd (div of Tinsley-Robor Group). Churchill Ind't Estate, Lancing, Sussex BN15 8TX Tel (09063) 5381.
Video: Video packaging materials
S S E. see Scenic Sounds
Scenic Sounds Equip., 97 99 Dean St., London W1 Tel (01) 734 2812 Telex 27939.
Audio: Splicing & editing equip
Brand names: Edittal, SSE, Xedit
Scotch, see 3M
Shalford Press Ltd., 85b Bradford St., Braintree, Essex. Tel (0376) 21125. Mng Dir R Capon
Audio: Cassette labels
Simon Stable Promos., 46 West End, Launton, Dorsetshire Tel (08692) 2831. Mng. Dir Count S.C de la Bedoyere, Gen. Mgr. Judy Dyble, Sales Mgr Simon Stable
Audio: Cassette labels
Telex, see AT
Tinsley Robor Labels Ltd (div of Tinsley Robor Group). 31 Rea St. S. Birmingham B5 6LB Tel (021) 692 1171
Audio: Cassette labels
Vintage Jazz Music Society Recs., 12 Slough Ln., Kingsbury, London NW9

8QL Tel (01) 205 2587 Partners Steve Lane Trevor Benwell, John Wadley, Secy Steve Lane
Audio: Cassette labels
Weircliffe, see Amos of Exeter
Kedit, see Scenic Sounds
James Yorke Ltd, Oak House, High St, Northleach, Gloucestershire GL54 3ET Tel (04516) 666 Telex 858623, 858393 Chief Exec J Scarlett, Sales Dir Peter Fanshawe, Studio Mgr Peter Rinne
Audio: Cassette labels

TAPE, BLANK LOADED & BULK RAW

Ablex Ltd (sub of Decca Ltd), Harcourt, Halesfield 14, Telford, Salop TF7 4QR Tel (0952) 584131 Telex 35649 Mgr Peter Banks
Audio: Cassette
Brand: Decca

Acoustic Dynamic, see TDK
Adastra Electronics Ltd, Cricklewood Trading Estate, Unit N22, Claremont Rd, London NW2 1TU Tel (01) 452 6288 Cable WESTQUIP Mng Dir Michael Leaver, Gen & Sales Mgr B Marks
Audio: Cassette, open reel
Brand name: Synchronette, Synchronotape

Agla Gevaert Ltd, 27 Great West Rd, Brentford, Middx TW8 9AX Tel (01) 560 2131 Cable ARTOVEG Telex 28154 Mng Dir R P Dickinson, Magnetic Prods Div Mgr W M May, Mktg Mgr EA Bowden
Home office: Germany
Audio: Blank-Cassette, open reel, raw-cassette
Video: Blank-1" open reel, 1/2" cassette

Awa Sales & Serv (UK) Ltd, 30/32 Concord Rd, Westwood Park Trading Estate, Western Ave, London W3 0TH Tel (01) 993-1672 Telex 936239 Mng Dir S R Chorley, Sales Mgr D J Wright, Adv & Press Officer T D Sprio
Amplex Great Britain Ltd, Acre Rd, Reading, Berks, RG2 0QR Tel (0734) 852000 Cable AMPLEX READING Telex 847611 Gen Mgr W Scullion, Tape Sales Mgr J Cripps, Adv Mgr P Vaughan
Audio: 2", 1", cassette, open reel
Video: 2" broadcast, 1" open reel, 3/4" U matic cassette, 1/2" Beta & VHS cassette

Audiogenic Ltd, 34 36 Crown St, Reading, Berks RG1 2SN Tel (0734) 595647 Dir Martin Maynard, Gen Mgr Mary Thomas Sales Mgr Henry Smithson (Blank only)
Audio: Cassette
Audio Magnetics Inc (UK) Ltd, 121 Loverock Rd, Reading, Berks RG3 1JZ Tel (0734) 598036 Telex 849113 Mng Dir Nigel W Bryden, UK Sales Mgr Hugh Smith
Audio: 8 tr., cassette, open reel
Audiopak/EMI, see Lee Eng
Audiosonic, see Cassette Developments
Audiua, see TDK

Avcom Systems Ltd, Newton Works, Stanlake Mews, London W12 7HA Tel (01) 749 2201 Cable CINEPRO Telex 892513 Mng Dir Eric R Bastin, Sales Dir Nick Gillieron, Adv Mgr Bridget King (Blank only)
Audio: Cassette (custom lengths)

B A S F UK Ltd, 4 Fitzroy Square, London W1P 5AD Tel (01) 388 4200 Telex 28649 Div Mgr H C Pattinson, Prof Prods Mgr RM Hine (Blank only)
Audio: 2", 1", cassette, open reel

F W D Bauch Ltd, 49 Theobald St, Boreham Wood, Herts Tel: (01) 953-0091 Telex 27502 Mng Dir John Bauch, Sales Mgr Vaughan Waller, Press Officer David Neal
Audio: Dpen reel
Brand name: Revox

Bib Magnetics Ltd, 101/105 Plough Rd, London SW11 2BJ Tel (01) 223 5955 Telex 917732 Dir K H Bourke Borrowes, Gen Mgr M Shepherd
Audio: Cassette
Harvey Buat, 84 Church St, London NW8 Tel (01) 724-3711 Chief Exec Alan Taub
Audio: Cassette
Brand name: Miles Gregory

Cambrasound Ltd, Freedex House, 4/10 North Rd, Islington, London N7 9HN Tel (01) 607 8141 Cable METRDS G Telex 264773 Mng Dir David Mason, Peter Eden, Sales Mgr Peter Welsh (Blank only)
Audio: Cassette
Brand name: Cambra

Capitol Magnetics (div of EMI Tape Ltd), Tape House, Dawley Rd, Hayes, Middx UB3 1BT Tel (01) 573 7860 Cable EMITAPE LONDND Telex 932161 Mng Dir EA Naeel, Gen Mgr P Solitt
Audio: 8 tr., Cassette, open reel
Brand name: Blank-The Master Tape, raw-Capitol

Cassette Developments (Audiosonic) Ltd, Micra House, 138 Lower Mortlake Rd, Richmond, Surrey TW9 2JZ Tel (01) 940 8186 Cable MICRD NETICS Telex 8813481 Gen Mgr D Dixon
Audio: Cassette
Brand name: Audiosonic

Cassette Rec'g Co (UK) Ltd, Unit 2, Riverway, Harlow, Essex CM20 2DN Tel (0279) 39256 Mng Dir H L Collins, Gen Mgr Michael Newton, Mktg Dir C J Sanford (Blank only)
Audio: Cassette
David Cavalier Ltd, 75 Holloway Rd, London N7 8JZ Tel (01) 359 5305 Telex 21120 Pres David Cavalier (Blank only)
Audio: Cassette, open reel
Brand name: Yashima

Certron, see Lallax
Contek Magnetics Ltd, 90 Walnut Tree Close, Guildford, Surrey GU1 4UJ Tel (0483) 503222 Telex 859403 Mng Dir Gerald P Creagh, Comm'l Mgr Fred MacDonald
Audio: Cassette
Brand names: Audio Gold Int'l, Contek UHE

D & B Tape Servs, 23 Croydon Rd, Reigate, Surrey RH2 0LY Tel 49505 Dwner E G Dowley
Audio: 8 tr., cassette broadcast
Decca, see Ablex & Selecta
Duphtape, 1/7 Harewood Ave, London NW1 Tel (01) 724 2497 Telex 21879 Chief Exec & Gen Mgr B Lambden, Sales Mgr R Jackson Moore (Blank only)
Audio: Cassette
Brand name: ITD

Dynamic, see TDK
E M I Tape Ltd, Tape House, Dawley Rd, Hayes, Middx UB3 1BT Tel (01) 573 3888 Cable EMITAPE LONDND Telex 932161 Mng Dir EA Naeel, Comm'l Controller P K Mitchell Gen Sales Mgr P Solitt, Mktg Mgr M W Cross
Audio: 2", 1", 8 tr., cassette, open reel
Video: Blank-1/2" Beta & VHS cassette

Eagle Int'l, Precision Centre, Heather Park Dr, Wembley, Middx HA0 1SU Tel (01) 902 8832 Cable EAGLINT Telex 922131 Mng Dir W Morrow Mktg Dir R Woolf
Audio: Cassette
Brand name: New Int'l

Ferrotape, see North East Audio
Fidelipac, see SIS Rec'g
Fuji, see Pysler
Golding Audio Ltd, 26 Hylthe Quay, Colchester, Essex Tel (0206) 77224 Mng Dir AB Golding, Dir D P Golding, Gen Mgr P Walsh Sales Mgr R K Golding (Blank only)
Audio: 8 tr., cassette

Grampan Recs Ltd, Airport Ind'l Estate, Wick, Caithness Scotland Tel (0955) 2787 Telex 75707 Dir J Johnston, Mgr John Hunter (Blank only)
Audio: Cassette
I T D, see Duplitape

International Video Corp (UK) Ltd, 10 Portman Rd, Reading, Berks RG3 1JR Tel (0734) 585421 Cable INTERVIDEO Telex 847579
Video: 2" & 1" open reel
JVC (UK) Ltd, Staples Corner London NW2 7AF Tel (01) 450 2621 Telex 923320 Mng Dir Kurt Lowy, Sales Dir G Barc, Adv & Press Officer Geoff Fleming
Video: 1/2" VHS cassette

Lallex & Co Ltd, Lallex House, 1 Canal St, Manchester M60 4AX Tel (061) 236 8186 Cable ALMIGHTY Telex 669431 Dirs R J Mulchand, K C Bhavnani (Blank only)
Audio: Cassette
Brand names: Certron, Monatone, Winthronics

Lee Eng'g Ltd, Napier House, Bridge St, Walton on Thames, Surrey KT12 1AP Tel Walton on Thames 43124 Cable LEETECH Telex 928475 Mng Dir Thomas Lee, Gen Mgr Chris Welsh, Sales Eng J Trevnor (Raw only)
Audio: 2", 1", 8 tr., cassette open reel
Brand name: Audiopak/EMI

The Master Tape, see Capitol
Maxell, see Natural Sound
Mayfair, see Professional Tapes
Media Sound, see Metropolitan Communications
Memorex (UK) Ltd, Memorex House, 94 106 Church St, Staines, Middx TW18 4XU Tel Staines 51488 Cable MRXLDN Telex (851) 935013 Mng Dir M Kitching, Gen Mgr James W Dulgar, Sales Mgr L Galion (Blank only)
Audio: Cassette
Video: 1/2" Beta & VHS cassette

Metropolitan Communications, 8a Froggall Gardens, London NW3 6UX Tel (01) 435 8803 Mng Dir Mark RF Hanau, Sales Mgr R Hanau, Admn A Lohmeyer (Blank only)
Audio: Cassette
Brand name: Media Sound
Miles Gregory, see Harvey Buat
Monatone, see Lallex
Musonnic, see Ziphurst

National Panasonic (UK) Ltd, 300 318 Bath Rd, Slough, Berks SL1 6JB Tel (0753) 34522 Cable PANASONIC Telex 847652 Mng Dir A Imura, Sales Mgr T Nishigaki, Adv Mgr P Hambin (Blank only)
Branches: Falkirk, Stirlingshire, Scotland, Etna Rd Tel (0324) 20821 Reg'l Sales Mgr A Douglas-Normanton, Wakefield, Yorks., Don Pedro Ave Tel (0924) 890980 Reg'l Sales Mgr K Spencer
Video: 1/2" U matic cassette, 1/2" VHS cassette, 1/2" EIAJ open reel, 1/2" EIAJ cartridge
Brand name: Panasonic

New Int'l, see Eagle
North East Audio Ltd, Smonsie Works, South Shields, Tyne & Wear NE34 9NX Tel (0632) 566321 Mng Dir A J Helliwell, Gen Mgr Tom Baley, Sales Mgr Jim Farrer
Brand name: Ferrotape
J Dsawa & Co (UK) Ltd, 10 Forge Court, Reading Rd, Yateley, Camberley Surrey Tel (0252) 875 919 Telex 858917 Bus Mgr L G Roberts (Blank only)
Audio: Cassette
P T L, see Professional Tapes
Paragon Int'l Prods, 16 Holmes St, Belfast, Northern Ireland Tel (0232) 48260 Dir John DP McCourt, Gen Mgr Anne Heaps, Sales Mgr Edwina Heaps
Audio: Cassette, open reel
Pebble Recs Ltd, 46 Maddox St, London W1 Tel (01) 629 3266, 491 4140 Telex 25247 Mng Dir James Pollard, Gen Mgr Julia Slocombe
Audio: 8 tr., cassette
Philips Electrical Ltd, City House, London Rd, Croydon Surrey Tel (01) 689 2166 Telex 946169
Audio: Cassette, open reel
Video: 1/2" EIAJ open reel, 1/2" V 2000 cassette

Products 2000 The Maltings, 63 High St, Ware, Herts SG12 9AD Tel (0920) 66242 Mng Dir R C Bays, Gen Mgr C W Bays (Blank only)
Audio: Cassette
Brand name: Sonorex/Audiogram

Professional Tapes Ltd, Cassette House, 329 Hunslet Rd., Leeds LS10 1NJ Tel (0532) 706066 Telex 55293 Mng Dir Raymond Linton, Gen Mgr Yusuf Nurgat, Sales Dir Colin W Marler
Audio: Cassette
Brand name: PTL, Professional, Mayfair

Pyral Magnetics Ltd, Courtlands Rd, Eastbourne Sussex Tel (0323) 638965 Mng Dir H J Hutchings, Sales Mgr James Hutchings
Audio: Cassette, open reel
Pysler Ltd, Fircroft Way, Edenbridge, Kent TN8 6HA Tel (0732) 864111 Telex 95527 Mng Dir J P Tilt, Sales Dir J R Carpenter
Audio: Cassette (90)

Brand name: Fuji
Racal Zonal Ltd, Station Hill, Pound Hill, Crawley, Sussex RH10 4AZ Tel (0293) 34982 Cable CASSETTES CRAWLEY Telex 87651 Mng Dir D S Worman, Gen Sales Mgr John Rooke, A/V Sales Mgr Eric Mould, Cassette Div Sales Mgr Michelle Jones
Audio: Cassette, open reel

Revov, see F W D Bauch
Ross Electronics 32 Rathbone Pl., London W1P 1AD Tel (01) 580 7112 Cable ROSSLECT Telex 22747 Pres Ross I L Marks, Gen & Sales Mgr A C Murphy (Blank only)
Audio: Cassette

S & B Export Servs, see Ziphurst
S & B Trading, see Ziphurst
S I S Ltd, 57 St Andrews Rd, Northampton NN1 2PB Tel (0604) 32965, 30559 Mng Dir D P D Mitchell, Sales Mgr I Brown
Audio: NAB A" & "C"

Brand name: Fidelipac
S R T Prods Ltd, 987 High Rd, Finchley, London N12 Tel (01) 446 3218 Mng Dir George Bellamy, Dir David Richardson
Audio: Cassette

Scotch, see 3M
Selecta (London) (div of Decca Rec Co Ltd), 125/127 Lee High Rd, Lewisham, London SE13 5NX Tel (01) 852 9171 9191 Telex 896029 Gen Mgr J D Roberts, Sales Mgr D Barsby, Sales Co ord E Packham (Blank only)
Audio: Cassette

Brand name: Decca
Sonorex/Audiogram, see Products 2000
Sony (UK) Ltd, Pyrene House, Sunbury Cross Sunbury on Thames, Middx Tel (76) 87644 Telex 266371 London Pres W H Fulton, Sales Mgr D W Reeves (Blank only)
Video: 1" open reel ("C" format), 3/4" U matic cassette, 1/2" EIAJ open reel, 1/2" Beta cassette

Soundrider, see James Yorke
Super Avilyn, see TDK
Synccassette, see Adastra
Synchronotape, see Adastra

T D K Tape Dist (UK) Ltd, 341 Brighton Rd, South Croydon, Surrey CR2 6EQ Tel 688 7372 Telex 946727 Mng Dir J C Buchan, Sales Mgr Derek Huthwaite
Audio: Blank-8 tr., cassette, open reel raw-cassette
Brand names: Acoustic Dynamic, Audua, Dynamic, Super Avilyn

T R A D Electronics Sales Ltd, 149B St Albans Rd, Walford Herts WD2 5BB Tel (92) 47988 Telex 262741 Mng Dir J E Southard
Audio: Cassette, open reel
The Tape Duplg Co Ltd, Freedex House, 4 10 North Rd, Islington, London N7 9HN Tel (01) 609 0087 Telex 264773 Mng Dir Peter Robey
Audio: Blank-cassette, Raw-8 tr

3 M United Kingdom Ltd, PO Box 1, 3M House, Bracknell, Berks RG12 1JU Tel (0344) 26726 Telex 849371 Mng Dir Donn Osmon, Dir Dir P G Hutchings, Sales & Mktg Mgr C Hobbs, Mktg Co ord P A Stockwell Jones
Reg'l sales offices: Belfast BT1 5JE, Northern Ireland, 11 Donegal Square S Tel (0232) 42811, 42926-Birmingham B3 3EL, Edmund House, 12 22 Newhall St Tel (021) 236 5077-Glasgow G4 0AY, Scotland, 3M House, 9 Canal St Tel (041) 332 9622-London SE20 7TR, PO Box 38, Yeoman House, 63 Croydon Rd, Penge Tel (01) 659 2323-Manchester M15 4PA, 3M House, 28 Great Jackson St. Tel (061) 236 8500

Audio: 8 tr. cassette, open reel
Video: 1" open reel, 1" cartridge, 3/4" cassette, 1/2" EIAJ open reel, 1/2" EIAJ cartridge, 1/2" VHS cassette, 1/2" open reel
Brand name: Scotch
Winthronics, see Lallex

World of Video 2000 Ltd, Cassette House, 329 Hunslet Rd, Leeds LS10 1NJ Tel (0532) 706066 Telex 55293 Mng Dir Raymond Linton Gen Mgr Yusuf Nurgat, Sales Dir Colin W Marler (Blank only)
Video: 1/2" cassette, & 1/2" Beta & VHS cassette
Yashima, see David Cavalier

James Yorke Ltd, Oak House, High St, Northleach, Gloucestershire GL54 3ET Tel (04516) 666 Telex 858623, 858393 Chief Exec J Scarlett, Sales Dir Peter Fanshawe, Studio Mgr Peter Rinne
Audio: Cassette
Brand names: Soundrider, James Yorke

Ziphurst Ltd, Stylus House, 34/38 Verulam Rd, St Albans, Herts AL3 4DF Tel (0727) 50611 Telex 28675 Mng Dir P H Blank, Gen Mgr Stephen H Blank, Sales Dir B Blank, Warehouse Mgr D N Lever
Audio: 8 tr. cassette, open reel
Brand name: Musonic

TAPE DUPLICATING & PROCESSING EQUIPMENT

Avis Asona, see Lennard
Avcom Systems Ltd, Newton Works, Stanlake Mews, London W12 7HA Tel (01) 749-2201 Cable CINEPRD Telex 892513 Mng Dir Eric R Bastin Sales Dir Nick Gillieron, Adv Mgr Bridget King
Audio: Cassette duplicators & high speed copiers
Brand name: Telex

Cartplant, see Sound
Cetelec Int'l, North Field Ind'l Estate, Unit 15, Beresford Ave., Wembley, Middx HA0 1YB Tel (01) 900 0355 Telex 935847 Mng Dir Brian CA Walls
Audio: High speed duplicators
Brand name: Gauss

Cintron Group, Grove House, 551 London Rd, Isleworth, Middx TW7 4DS Tel (01) 568 0131 Telex 935054
Audio: Duplicators
Brand name: Pentagon Telex

Digitrax, see Sound
Duplitape, 1/7 Harewood Ave., London NW1 Tel (01) 724 2497 Telex 21879 Chief Exec & Gen Mgr B Lambden, Sales Mgr R Jackson Moore
Audio: Duplicators
Brand name: Dtari (Japan)

Gauss, see Cetelec
Hayden Labs Ltd, Hayden House, Chiltern Hill, Chalfont St Peter, Gerrards Cross, Bucks SL9 9UG Tel (02813) 88447 Telex 849469 Chm K E Owens, Mng Dir E J Barrett, Sales Mgr D Hughes, Technical Mgr R Hull, Adv Mrs A C Sandrey
Audio: Cassette duplicators & loaders
Brand name: Telefunken

Industrial Tape Applications, 1/7 Harewood Ave., London NW1 Tel (01) 724 2497 Telex 21879 Dir M Parment, Gen Mgr B Lambden, Sales Mgr P Leader
Audio: Cassette duplicators.
Brand name: Dtari (Japan)

International Video Corp (UK) Ltd, 10 Portman Rd, Reading RG3 1JR Tel (0734) 585421 Cable INTERVIDEO Telex 847579
Video: Duplicators
Lennard Developments Ltd, 206 Chase Side, Enfield, Middx EN2 0QX Tel (01) 363 8238 Cable LENNARD ENFIELD Mng Dir E G Lennard
Audio: Cassette loaders
Brand name: Avis Asona

B H Morris & Co (Radio) Ltd, Precision Centre, Heather Park Dr, Wembley, Middx HA0 1SU Tel (01) 902 9422 Telex 922131 Mng Dir K Lasky, Mktg Mgr B T Cochran, Sales Dir A Allenstein
Brand name: Trio

Dtari, see Duplitape & Industrial Tape
Philips Electrical Ltd, City House, London Rd, Croydon Surrey Tel (01) 689 2166 Telex 946169
Audio: Cassette duplicators
Video: Videocassette duplicators

Scotch, see 3M
 P & J Sibert & Co., 161 Fimborough Rd., West Brompton, London SW10 9AP
 Tel: (01) 373-9509. (sales) 330 0770. Technical Sales Alan & Paul Sibert
 Chief Product: Tape head inspection & photographing equipment
 Brand name: Tape Photo Microscope
 Sony (UK) Ltd., Pyrene House, Sunbury Cross, Sunbury-on-Thames, Middx
 Sonny (UK) Ltd., Pyrene House, Sunbury Cross, Sunbury-on-Thames, Middx
 Tel: (76) 87644. Telex: 266371 London Pres WH Fulton, Sales Mgr
 D.W. Reeves (Video only)
 Sound, 1 Dogdshaw Mews, Maidenhead, Berks Tel: (0628) 33011 Mng
 Dir.: I.S. Webb; Sales Mgr M. Lloyd, Adv. Mgr. C. McVie
 Audio: Duplicators, winders.
 Brand name: Cartplant, Digitrax
 Telefonken see Hayden
 Telex, see Avcom.
 3 M United Kingdom Ltd., PD Box 1, 3M House, Bracknell, Berks RG12 1JU
 Tel: (0344) 26726. Telex: 849371 Mng Dir Donn Dsmon, Div Dir P G
 Hutchings, Sales & Mktg Mgr C Hobbs, Mktg Co ord PA Stockwell
 Jones.
 Reg'l sales offices: Belfast, BT1 5JE, Northern Ireland, 11 Donegal
 Square S Tel: (0232) 42811, 42926--Birmingham B3 3EL, Edmund
 House, 12 22 Newhall St Tel: (021) 236 5077--Glasgow G4 4AY, Scot-
 land, 3M House, 9 Canal St. Tel: (041) 332 9622--London SE20 7TR, PO
 Box 38, Yeoman House, 63 Croydon Rd., Penge. Tel: (01) 659 2323--
 Manchester M15 4PA, 3M House, 28 Great Jackson St Tel: (061) 236
 8500.
 Audio: Cassette pancakes.
 Brand name: Scotch
 Tno, see B.H. Morris.

TAPE PACKAGING & LABELING EQUIPMENT

S. Kempner Ltd., 498 Honeygot Ln., Stamord, Middx, HA7 1JZ Tel: (01)
 952-5262 Telex: 21400 Sales Dir Paul R S Rogers, Sales Mgr Aidan
 Coles.
 Product: Shrinkwrapping machines
 Lennard Developments Ltd., 206 Chase Side, Enfield, Middx EN2 0QX Tel
 (01) 363-8238 Cable: LENNARD ENFIELD Mng. Dir.: E G Lennard
 Product: Cassette labelling machines (Avis-Asona)
 Professional Tapes Ltd., Cassette House, 329 Hunslet Rd., Leeds LS10 1NJ
 Tel: (0532) 706066. Telex: 55293. Mng Dir Raymond Linton, Gen
 Mgr: Yusuf Nurgat; Sales Dir: Colin W Marler
 Product: Cassette labeling machines

• accessories

Ablex Ltd. (sub. of Decca Ltd.), Harcourt, Halesfield 14, Telford, Salop TF7
 4QR. Tel: (0952) 584131 Telex: 35649. Mgr Peter Banks
 Product: Tape-head cleaners (audio)
 Adastral Electronics Ltd., Cricklewood Trading Estate, Unit N22, Clarendon
 Rd., London NW2 1TU Tel: (01) 452-6288. Cable: WESTQUIP LDNDDN
 NW2. Mng Dir Michael Leaver, Gen & Sales Mgr B Marks
 Product: Tape-carrying & storage cases, head cleaners, demagnetizers
 Agla-Gevaert Ltd., 27 Great West Rd., Brentford, Middx, Tel: (01) 560-2131
 Cable: ARTDVEG Telex: 28154 Mng Dir: R P Dickinson, Magnetic
 Prods Div Mgr: W M May, Mktg Mgr EA Bowden
 Home office: Germany

Product: Tape-splicing & editing equip
 Alisop 3, see Network Mktg
 Ampex Great Britain Ltd., Acre Rd., Reading, Berks RG2 0QR Tel (0734)
 85200 Cable: AMPEX READING Telex: 847611 Gen Mgr W Scullion
 Tape Sales Mgr J Cripps, Adv Mgr P Vaughan
 Product: Tape-carrying & storage cases, head cleaners, bulk erasers, de-
 magnetizers, leader tape, splicing tape & equip. (all audio & video)
 Arrowlabs Ltd., Humber Rd., London NW2 6EP Tel: (01) 450-2411 Telex
 923034 Mng Dir Maurice Mindel, Sales Mgr Alex Murray, Prod Mgr
 Paul Rinne
 Product: Record-record care prods., Tape-carrying & storage cases,
 head cleaners, demagnetizers, leader & splicing tape
 Audio Magnetics Inc (UK) Ltd., 121 Loverock Rd., Reading, Berks RG3 1JZ
 Tel: (0734) 598036 Telex: 849113 Mng Dir Nigel W Bryden, UK Sales
 Mgr. Hugh Smith
 Audio: Tape-cassette hubs
 Avdio Technica Ltd Hunslet Trading Estate, Low Rd., Leeds LS10 1DL Tel
 (0532) 771-441 Telex: 557991
 Product: Record-record care prods., cleaners, replacement styli
 Audio + Video Ltd., Video House, 48 Charlotte St., London W1P 1LX Tel
 (01) 580-7161 Telex: 22345 Mng Dir Irvin C Pannaman, Sales Mgr
 Andrew Bourne, Adv Mgr Don Udsell
 Product: Tape-bulk erasers (video)
 B A S F UK Ltd., 4 Fitzroy Square, London W1P 5AD Tel: (01) 388-4200
 Telex: 28649 Div Mgr H C Pattinson, Prod Prods Mgr R M Hme
 Product: Record-record care prods. Tape-head cleaners, leader tape,
 splicing tape & equip. (all audio)
 Berrester Music Co Ltd., 50 Bute St., Luton, Beds LU1 2EP Tel (0582)
 29335 Telex: 825115 Mng Dir John Barratt
 Product: Record-record care prods., turntable mats, Tape-carrying &
 storage cases
 F W D Bauch Ltd., 49 Theobald St., Boreham Wood, Herts. Tel (01) 953-
 0091 Telex: 27502 Mng Dir John Bauch, Sales Mgr Vaughan Waller;
 Press Officer David Neal
 Product: Tape-head cleaners, demagnetizers, leader & splicing tape
 (Revox)
 Bib Hi Fi Accessories Ltd., Kelsey House, Wood Ln End, Hemel Hempstead,
 Herts HP2 4RQ Tel (0442) 61291 Telex: 826437 Chm & Mng Dir
 P B Arbib; UK Sales Dir J Embley, Int'l Sales Dir R G Everett
 Product: Record-record care prods., Tape-carrying & storage cases,
 head cleaners, bulk erasers, demagnetizers, splicing tape & equip., audio
 cassette winder, video maintenance kit
 Bibi Magnetics Ltd., 101/105 Plough Rd., London SW11 2BJ Tel (01) 223
 5955 Telex: 917732. Dir K H Bourke Borrowes, Gen Mgr M Shep-
 herd
 Product: Tape-head cleaners, demagnetizers.
 Book Binders of London, 11 Ronalds Rd., Highbury, London N5 1XJ, Tel
 (01) 607-3361
 Product: Video storage cases (book style)
 Harvey Burt, 84 Church St., London NW8 Tel (01) 724 3711 Chief Exec
 Alan Taub
 Product: Tape-carrying & storage cases, head cleaners, demagnetizers
 E B S Mfg. (div. of CBS (UK) Ltd.), 17/19 Soho Square, London W1V 6HE.
 Tel (01) 734 8181 Cable: CDLRECMAN Telex: 24203 Mng Dir John A
 Wheeler.
 Product: Tape-cassette library cases

Cambrasound Ltd., Freedex House, 4/10 North Rd., Islington, London N7
 9HN Tel (01) 607 8141 Cable: METROS G Telex: 264773 Mng Dir
 Gerald Ambrose; Sales & Mktg Dir: Peter Eden, Sales Mgr: Peter Welsh.
 Product: Record-carrying & storage cases, record care prods., turntable
 mats, 45 rpm adaptors, replacement styli, Tape-carrying & storage
 cases (video), head cleaners, bulk erasers, demagnetizers, leader tape,
 splicing tape.
 Cassette Developments (Audiosonic) Ltd., Micra House, 138 Lower Mortlake
 Rd., Richmond, Surrey TW9 2JZ Tel: (01) 940 8186 Cable: MICRD
 NETICS Telex: 8813481 Gen Mgr D Dixon
 Product: Tape-head cleaners, demagnetizers
 Cintron Group, Grove House, 551 London Rd, Isleworth, Middx TW7 4DS
 Tel (01) 568-0131 Telex: 935054
 Product: Tape-demagnetizers
 Clendisc (Mail Order), Ltd., 7 Trinity Court, Grays Inn Rd., London WC1 Tel
 (01) 837 9088. Pres: Erna Smith, Gen. Mgr Beatrice Parker
 Product: Record-record care prods
 Colclene, see Future Film
 Condor Electronics Ltd., Woodman Works, 204 Durnford Rd., London SW19
 8DR. Tel (01) 947 9511 Telex: 928502 Mng Dir: CA Wolff.
 Product: Record-record care prods., replacement styli, Tape-head
 cleaners, demagnetizers
 Contek Magnetics Ltd., 90 Walnut Tree Close, Guildford, Surrey GU1 4UJ
 Tel (0483) 503222 Telex: 859403 Mng. Dir. Gerald P. Creagh; Comm'l
 Mgr. Fred MacDonald
 Product: Tape-head cleaners (audio)
 Cosmocord Ltd., Eleanor Cross Rd., Waltham Cross, Herts EN8 7NX. Tel. Lea
 Valley 716-666. Cable: ACDS. Telex: 24294 Mng Dir V J Snyer; Sales
 & Mktg Dir G E Brewin
 Product: Record-record care prods., 45 rpm adaptors, replacement styli,
 Tape-carrying & storage cases, head cleaners, demagnetizers
 Crown Arrow Co., 8 Gate Lodge Close, Round Spinney, Northampton NN3 4RJ
 Tel (0604) 48744 Telex: 311165 Dwner Robert J Parfitt
 Product: Record-carrying & storage cases. Tape-carrying & storage
 cases (audio & video), head cleaners
 D & B Tape Servs., 23 Croydon Rd., Reigate, Surrey RH2 0LY Tel 49505.
 Dwner E G Dowley
 Product: Tape-head cleaners demagnetizers
 Discleaner, see Vac D Rec
 E M I Tape Ltd., Tape House, Dawley Rd., Hayes, Middx, UB3 1BT Tel (01)
 573-3888 Cable: EMITAPE LDNDDN Telex: 932161 Mng Dir E A
 Naef, Comm'l Controller P K Mitchell, Gen Sales Mgr P Sollitt; Mktg
 Mgr M W Cross
 Product: Tape-head cleaners, leader tape (both audio)
 Eagle Int'l, Precision Centre, Heather Park Dr., Wembley, Middx HA0 1SU
 Tel (01) 902-8832 Cable: EAGLINT Telex: 922131 Mng Dir W Mor-
 row, Mktg Dir R Woolf
 Product: Record-replacement styli, Tape-bulk erasers demagnetizers
 Editall, see Scenic Sounds
 Edwards Construction Co., 4 Brunswick Dr., Harrogate, North Yorks HG1
 2PZ Tel Harrogate 60921 Local plant: The Chapel, 282 Skipton Rd
 Tel 500442
 Local plant: The Chapel, 282 Skipton Rd Tel 500442
 Product: Record-record & hi fi cabinets (Superflex), Tape-video cabi-
 nets (Videoflex)
 Filcon Magnetek, see Pro-Bel

THE MUPPET MOVIE RETURN OF THE PINK PANTHER SATURN 3 AUTUMN SONATA JESUS OF NAZARETH PARTS 1-4 THE EAGLE HAS LANDED THE BOYS FROM BRAZIL CAPRICORN ONE

THE DOMINO KILLINGS LOVE & BULLETS FAREWELL MY LOVELY BRIEF ENCOUNTER VOYAGE OF THE DAMNED RISING DAMP



PRESENTING PRECISION VIDEO.

We go from the comic genius of Peter Sellers (RETURN OF THE PINK PANTHER) to the musical genius of Elton John (TO RUSSIA WITH ELTON). From the epic drama of JESUS OF NAZARETH to the high adventure of THE EAGLE HAS LANDED; from the light-hearted comedy of THE MUPPET MOVIE to the artistry of Laurence Olivier (THE MERCHANT OF VENICE). Our collection is available in both VHS and Betamax formats and uniquely packaged in impact-resistant library boxes. Apart from the vast and varied range of titles that we have from I.T.C. we also distribute the video catalogues of: DERRAN FILM SERVICES L.P.C. VIDEO MOUNTAIN FILMS MUSIC UNLIMITED VIDEVIEW VAMPX RAMPIX VIDEO LANGUAGE COURSES AND A RANGE OF VIDEO ACCESSORIES

It's the best (and the best-dressed) video catalogue.
 The only one to join if you want to make your mark in the video market.
 CONTACT PRECISION VIDEO NOW

- ★ PRODUCT PRODUCED TO HIGH QUALITY TECHNICAL STANDARDS
- ★ UNIQUE PACKAGING SUITABLE FOR RE-SALE OR RENTAL
- ★ AGGRESSIVE MARKETING, MERCHANDISING, PROMOTION
- ★ TWO SPECIALIST SALES FORCES
- ★ LARGE FULLY COMPUTERISED DISTRIBUTION DEALER NETWORK

THE BEST IN HOME ENTERTAINMENT.

PORRIDGE TO RUSSIA WITH ELTON GISELLE MERCHANT OF VENICE DESTINATION MOONBASE ALPHA MOSES THE LAW GIVER

PV PRECISION VIDEO LTD.
 19 Upper Brook Street London W1P 1PD Tel: 01-439 3277
 Telex: 267350 Answerback Code ACCUBS

ALIEN ATTACK CASSANDRA CROSSING ESCAPE TO ATHENA MOVIE MOVIE GREAT EXPECTATIONS ALL QUIET ON THE WESTERN FRONT HMS PINAFORE ANTONY & CLEOPATRA

Emerald Recs. Ltd., 120 Coach Rd., Templepatrick, Ballyclare, Co. Antrim, Northern Ireland BT39 0HB Tel: (08494) 32711 Telex 747293 Mng Dir Mervyn Solomon, Gen Mgr Les R Paterson, Sales Mgr Noel A Spiller
Product: Record-replacement styli

Entre, see Lentek

Ferrogaph, see North East Audio

N & S B Field & Co. Ltd./Record Housing, 17-A Newham Rd., Wood Green N22 Tel: (01) 888 7487 Chm. N Field, Gen Mgr F Davis, Sales Mgr J Edwards, Promo Dir M L Field
Product: Record-carrying & storage cases

Fittall Prods Ltd., Coastguard Rd., Larne, Northern Ireland Tel (0574) 3015 Telex 747386 Mng Dir C Rumble
Product: Tape-storage cases

Future Film Developments (Allotrope Ltd.), 36/38 Lexington St., London W1R 3HR Tel: (01) 437 1892 Cable ALLDTRDPE LDNDDN W1 Telex 21624 Dirs C S Young, Tim Blackham, Sales Mgr John Dent
Product: Tape-head cleaners (Colteche)

Golding Audio Ltd., 26 Hythe Quay, Colchester, Essex Tel: (0206) 77224 Mng Dir A B Golding, Dir D P Golding, Gen Mgr P Walsh, Sales Mgr R.K. Golding
Product: Tape-carrying & storage cases, head cleaners, demagnetizers

C E Hammond & Co Ltd., 105/109 Dyster Ln, Byfleet, Surrey KT14 7JH Tel: (09323) 51051 Telex 262525 Mng. Dir., Peter M. Hammond, Sales Mgr Tony Smith, Co. Sec'y Edgar A Thomson
Product: Record & Tape-storage cases

Hi-Fi Pro, 22/24 Buckingham Palace Rd., London SW1 Tel: (01) 834 9382 Telex: 929679 Dir Mrs. M.H. Ling, Gen Mgr Jeff Hill
Product: Record-45 rpm adaptors, replacement styli, Tape-head cleaners, demagnetizers, leader & splicing tape

Highgate Acoustics, 38 Jamestown Rd., London NW1 7EJ Tel: (01) 267-4936
Product: Record-replacement styli

Immediate Sound Servs. Ltd., 6 Drsmar Rd., London N1 5QJ Tel: (01) 739-9672, Telex: 914382 Mlg Mgr J W Hart
Product: Record-carrying & storage cases, record care prods

Istead Audio Visual, 38 The Thytng, Worcester Tel: (0905) 29713 Telex 335294
Product: Tape-videocassette storage cabinets

K-tel Int'l (UK) Ltd., 620 Western Ave., London W3 Tel: (01) 992 8000 Cable, KAYTELE. Telex: 934195, Mng. Dir.: Tony Johnson, Sales Mgr Colin Ashby
Product: Record & Tape-carrying & storage cases

Knownn (UK) Ltd., 37 Churchill Way, Fleckney, Leics Tel: (0533) 40331 Telex: 342467
Product: Record-carrying & storage cases record care prods, Tape-carrying & storage cases (audio & video), head cleaners (audio & video), demagnetizers (audio)

L G R Prods., 105 Eastern Esplanade, Southend-on-Sea Essex Tel: (0702) 65695 Owner L G Raven
Product: Carrying & storage cases.

Landmark (Precision Mouldings) Ltd., 2 Albone Way, Langford Rd., Biggles wade, Beds Tel: (0767) 314-231 Telex 23384 Mng Dir David Ritchie, Works Dir.: Don Pearson, Prod'n Dir.: George Jardine
Branch: Potters Bar, Herts., Deneway House, Darkes Ln
Product: Tape-head cleaners, demagnetizers, cassette library cases

Lee Eng'g Ltd., Napier House, Bridge St., Walton-on-Thames, Surrey KT12 1AP, Tel: 43124, Cable LEETECH Telex 928475 Mng. Dir. Thomas Lee, Gen Mgr Chris Welsh, Sales Eng J Trevnor
Product: Tape-carrying & storage cases, head cleaners, demagnetizers, splicing tape (Nortronics).

Leavers-Rich Equip Ltd., Ltd., 319 Trinity Rd., Wandsworth, London SW18 3SL Tel: (01) 874-9054, Cable, LEEMAG Telex 923455
Product: Tape-bulk erasers (audio & video), demagnetizers (audio & video).

Lennard Developments Ltd., 206 Chase Side, Entfeld, Middx EN2 0QX Tel: (01) 363-8238, Cable: LENNARD ENFIELD Mng Dir E G Lennard
Product: Record-record care prods., 45 RPM adaptors, replacement styli, Tape-carrying & storage cases, head cleaners, demagnetizers, splicing tape.

Lentek Audio Ltd., Ind'l Estate, Edison Rd., St. Ives, Huntingdon, Cambs PE17 4LF Tel: (0480) 62225 Telex 32303 Dir L.W. Scofield
Product: Record-replacement styli (Entle)

Lightning Recs. Ltd., 841 Harrow Rd., Harlesden, London NW10 5NH, Tel: (01) 969-7155/5255, Telex 927813 Mng Dir: Raymond Laren, A&R & Mktg. Dir: Keith Yershon; Dist'n & Jukebox Dir: David Powell, Commercial Dir: Siad Reza
Product: Record-45 rpm adaptors

Liverwise Bindery, 9/12 Zennor Rd., London SW12 Tel: (01) 673 1216
Product: Tape-videocassette slip cases

Lugton & Co. Ltd., PD Box 182, Cross Ln., Hornsey, London N8 7SB Tel: (01) 348-8211, Mng. Dir. Walter Ficker, Gen & Sales Dir John Sulby
Product: Record-carrying & storage cases, record care prods., 45 rpm adaptors, replacement styli; Tape-carrying & storage cases, head cleaners, demagnetizers, leader & splicing tape

Milly Prods. Ltd., New Mansion House, 173/191 Wellington Rd S., Stockport, Cheshire, Tel: (061) 480-8142, Cable, PDWMAR, Telex 667700.
Product: Record-record care prods. (Pxaill, Permosta)

Musac (Scotland) Ltd., Baltic Chambers, 50 Wellington St., Glasgow, Scotland G2 6HJ, Tel: (041) 221-1948 Mng. Dir. Angus McDonald, Sales Mgr.: Douglas MacLeod.
Product: Record-carrying & storage cases, replacement styli, Tape-carrying & storage cases, head cleaners, demagnetizers

Musicaise Ltd., Camberwell Ind'l Estate, Unit 6, Denmark Rd., London SE5 Tel: (01) 737-0480, Mng. Dir. John Hardman; Prod'n Mgr. Martyn Ward
Product: Record-carrying & storage cases, record care prods. Tape-carrying & storage cases, head cleaners, demagnetizers.

Musonic, see Ziphurst

Network Mktg Ltd., Middlesex House, 29-45 High St., Edgware, Middx HA8 7HH, Tel: (01) 952-6225, Telex 261341
Product: Tape-"non-abrasive" type head cleaning cassettes (audio & video) (Allsp3)

North East Audio Ltd., Simonside Works, South Shields Tyne & Wear NE34 9NX, Tel: (0632) 566321, Mng. Dir.: A J Hellwell, Gen. Mgr. Tom Batey, Sales Mgr Jim Farrer
Product: Tape-head demagnetizers, test tapes (Ferrogaph)

Nortronics, see Lee

J Osawa & Co (UK) Ltd., 10 Forge Court, Reading Rd., Yateley, Camberley Surrey Tel: (0252) 875-919 Telex: 858917 Bus Mgr L G Roberts
Product: Record-record care prods., replacement styli, Tape-head cleaners, demagnetizers, splicing tape

Osmabet Ltd., 46 Kenilworth Rd., Edgware, Middx HA8 8YG Tel: 958-9314 Mng Dir D Greenick
Product: Tape-bulk erasers, head demagnetizers

P T T Developments Ltd., Fulving Mill Ln., Welwyn, Herts Tel: (043871) Welwyn 4088 Chief Exec R C Bayes
Product: Record & Tape-carrying & storage cases

Parostatik, see Cecil Watts.

Phlips Electrical Ltd., City House, London Rd., Croydon, Surrey Tel: (01) 689 2166 Telex 946169
Product: Tape-cassette head cleaning tape, leader & splicing tape

Pinnacle Recs., 371/375 Kenning Ln., London SE11 Tel: (01) 582 2338 Telex 896141 Drington Chm Terry Scully, Gen Mgr Tony Berry, Int'l Newton Wells
Product: Record-carrying & storage cases, record care prods., replacement styli, Tape-head cleaners, demagnetizers

Plastic Sales Leicester Ltd, 10/12 Dartford Rd Leicester LE2 7PQ Tel: (0533) 833691 Chief Exec T.H. Winfield, Gen Mgr Mrs B E Flude
Product: Carrying & storage cases

Pro-Bel Ltd, Terrace Rd Binfield Bracknell Berks Tel: (0344) 56969 Telex 848314 Mng Dir Derek Owen, Press Officer K Bryan
Product: Tape-2" & 1" tape cleaner/profiler (Elcon Magnetek)

Professional Tapes Ltd., Cassette House, 329 Hunstet Rd., Leeds LS10 1NJ Tel: (0532) 706066, Telex 55293 Mng Dir Raymond Linton, Gen Mgr Yusuf Nurgat; Sales Dir Colin W Marler
Product: Tape-head cleaners, splicing tape

Purpas Plastics Ltd, 138 Miles Rd., Epsom, Surrey Tel: Epsom 21644 40322 Telex 925207, Mng. Dir. J M Fuller, Sales Mgr M. Pink, Prod'n Dir. R B Dunbar
Product: Carrying & storage cases

Pyral Magnetics Ltd., Courtlands Rd Eastbourne, Sussex Tel: (0323) 638965 Mng Dir: Harry Hutchings, Sales Mgr James Hutchings
Product: Tape-leader tape

Pyser Ltd., Fircroft Way, Edenbridge, Kent Tel: (0732) 864111 Telex 95527 Mng Dir J P Tilt, Sales Dir Malcolm Blockley
Product: Record-record care prods. preservative (Sound Guard) Tape-head cleaners & demagnetizers

Quality Audio Supplies, Wollaton Rd., Beeston, Notts Tel: (0602) 25 22 22
Product: Tape-head cleaners

Quality Plastic Supplies, 13 Summerstown, Wandswoth, London SW17 Tel: (01) 946-8388
Product: Tape-plastic video albums, protective cases for videocassette

R I Audio Kernick Rd., Penryn Cornwall TR10 9DQ Tel: (0326) 72753
Cable RIMICRON Sales Dir A Lee
Product: Record-record care prods

Racal Zonal Ltd., Station Hill Pound Hill, Crawley Sussex RH10 4AZ Tel: (0293) 34982 Cable CASSETTES CRAWLEY Telex 87651 Mng Dir D S Worman; Gen Sales Mgr John Rooke, A/V Sales Mgr Eric Mould
Product: Tape-head cleaners, leader tape

Record Holding Soundmaster, 17A Newham Rd Wood Green N22 Tel: (01) 889-0139 Co Chm M L Field, Gen. Mgr J Cohen, Sales Mgr J Devan, Prod'n/Buyer F Davis
Product: Record & Tape-carrying & storage cases, storage racks cabinets, trolleys

Revox, see F.W.D. Bauch

Riverside Ltd., 107 High St., Evesham Worcs Tel: (0386) 47766 Contact Harry Dixon
Product: Record-carrying & storage cases

Ross Electronics, 32 Rathbone Pl., London W1P 1AD Tel: (01) 580 7112 Cable RDSSILECT Telex 22747 Pres Ross I L Marks, Gen & Sales Mgr A C Murphy
Product: Record-record care prods

S & B Export Servs., see Ziphurst

S & B Trading, see Ziphurst.

Scenic Sounds Equip Ltd., 97-99 Dean St., London W1V 5RA Tel: (01) 734-2812 Telex 27939
Product: Tape-splicing, editing equip (Editall, Xedit)

Scullthorp Plastics Ltd., 248 Walton Rd., East Molesey, Surrey Tel: (01) 941-2929 Mng Dir R H Scullthorp, Gen Mgr J Pointon, Sales Mgr Miss M Winter, Export Mgr. Mrs A Wade
Product: Carrying & storage cases.

Securette Ltd., Bluebridge Ind'l Estate 5 First Ave., Halstead, Essex CO9 2EX Tel: (0787) 475912 Mng Dir Bruce J Samson, Dir Mary B Radcliffe
Product: Tape-storage cases

P & J Sibert & Co., 161 Finborough Rd., West Brompton, London SW10 9AP Tel: (01) 373 9509 Technical Sales Alan & Paul Sibert
Product: Record-Stylus inspection equip., Tape-head inspection equip

Solomon & Peres Ltd., 120 Coach Rd., Templepatrick Ballyclare, Co Antrim, Northern Ireland BT39 0HB Tel: (08494) 32711 Telex 747293 Mng. Dir.: Mervyn A Solomon, Gen Mgr: Les Paterson, Rec/Tape Mgr. Michael H Ross, Sales Mgr Noel A Spiller
Product: Record-record care prods., replacement styli, Tape-head cleaners, demagnetizers

Sound Guard, see Pyser.

Stanton, see Wilmes

Superflex, see Edwards

T D K Tape Dist. (UK) Ltd., 341 Brighton Rd., South Croydon, Surrey CR2 6EQ Tel: (01) 688-7372 Telex 946727 Mng Dir J C Buchan, Sales Mgr Derek Huthwate
Product: Tape-head cleaners, demagnetizers.

3 M United Kingdom Ltd., PO Box 1, 3M House, Bracknell, Berks RG12 1JU Tel: (0344) 26726 Telex 849371 Mng Dir. Donn Osman, Div Dir P G Hutchings, Sales & Mktg. Mgr. C. Hobbs, Mktg Co-ord P.A. Stockwell-Jones.
Reg'l sales offices: Belfast BT1 5JE, Northern Ireland, 11 Donegall Square S, Tel: (0232) 42811, 42926-Birmingham B3 3EL, Edmund House, 12-22 Newhall St Tel: (021) 236-5077-Glasgow G4 0AY, Scotland, 3M House, 9 Canal St Tel: (041) 332-9622-London SE20 7TR, PO Box 38, Yeoman House, 63 Croydon Rd., Penge Tel: (01) 659 2323-Manchester M15 4PA, 3M House, 28 Great Jackson St Tel: (061)236-8500
Product: Record-tunable mats, Tape-head cleaners, leader & splicing tape

V D R Int'l. Unit 16F, Randles Rd., Knowsley, Merseyside L34 9EZ Tel: (051) 548 7400 Telex 627791 Mng Dir Jim Thornton
Product: Record-record care prods (Discleaner, Vac D Rec)

Vac-D Rec, see VDR

Videoflex, see Edwards

Cecil E Watts Ltd., Darby House, Lower Hampton Rd., Sunbury on Thames Middx Tel: Sunbury 83252 Cable DUSTBUG Telex 27750 Mng Dir Mrs A H Watts Gen Mgr D W Luxford-Watts Sales Mgr Mrs S A C Luxford-Watts
Product: Record-record care prods "Dust Bug," Disc Preener, Manual Parastat, Hi-Fi Parastat, Parostatik, X static, Humd Mop, Trade Parastat, Stylus cleaner

West 4 Tapes & Recs., 169 Chiswick High Rd., London W4 2DR Tel: (01) 994-5879

Product: Record-polythene lined covers, cardboard (master bags) for LP's & singles

Wilmes Ltd., Compton House New Malden, Surrey KT3 4DE Tel: (01) 949 2545.
Product: Record-replacement styli (Stanton)

World of Video 2000 Ltd., Cassette House 329 Hunstet Rd Leeds LS10 1NJ Tel: (0532) 706066, Telex 55293 Mng Dir Raymond Linton, Gen Mgr Yusuf Nurgat, Sales Dir Colin W Marler
Product: Tape-video head cleaners

Wynd Up Recs Ltd., Greengate Ln, Prestwich, Manchester Tel: (061) 798 9252/0533 Mng Dir Colin Reilly, Gen Mgr & Dist'n Dir B Patchett, Sales Dir L J D'Meara Local Branch: Accessories Div., 14 Birch Ln Longsight, Manchester Tel: (061) 224 2823
Branch: Glasgow, Scotland, Tradeston Ind'l Estate, 7 Kilburnie Pl Tel: (041) 429 5155
Product: Record-carrying & storage cases record care prods., 45 rpm adaptors, replacement styli, Tape-head cleaners, demagnetizers, leader & splicing tape

Xanadu Constructional & Mechanical Eng's, 79 Fitzneal St East Acton, London W12 Tel: (01) 743 3402 Mng Dir Paul Gadd, Co. Dir. & Sales Mgr Don Arden; Gen Mgr Jeff Lynne
Product: Record-45 rpm adaptors, replacement styli
 Xedit, see Scenic Sounds
 X-static, see Cecil Watts

M Young & Co., Industrial Estate, Southgate Ave., Mildenhall Suffolk IP28 7AT Tel: Mildenhall 712553 Partner: M Young
Product: Record-polythene lined covers, master bags, cardboard record covers, Tape-cassette master bags

Zeepra Instruments Ltd, 15 Richmond Grove Surbiton Surrey KT6 6AH Tel: (01) 399-0966 Cable ZEEPA SURBITDN Telex 929679, Mng Dir W Ling, Sales Mgr: R S English
Audio: Record-carrying & storage cases, record care prods replacement styli, Tape-head spray demagnetizers, bulk erasers

Zerostat Components Ltd., Burrell Road Ind'l Estate, St Ives, Huntingdon Cambs Tel: (0480) 62225 Telex 32303 Dir R F Wookey
Product: Record-record care prods

Ziphurst Ltd., Stylus House, 34/38 Verulam Rd., St. Albans, Herts AL3 4DF Tel: (0727) 50611 Telex 28675 Mng Dir P H Blank, Mng Dir Sphen H Blank, Sales Dir B Blank, Warehouse Mgr D N Lever
Product: Record-carrying & storage cases, record care prods., 45 rpm adaptors replacement styli, Tape-head cleaners, demagnetizers leader & splicing tape (Musonic)

• **store fixture manufacturers**

Alfa Display & Design, 28 Beechwood, Fordingbridge, Hants LP6 1DB Tel: (0425) 53943
Product: Record & tape browser boxes, record & tape display racks

Amazing Exhibitions Ltd., 20 Gloucester Place, Wexham, London W1H 3PD Tel: (01) 486 3977, Dirs: Arastou Azar, Lawrence Miller, Frances Mgr Janet Lampont
Product: Browser boxes, display racks, divider cards

Arjay Shopfitters Ltd, 54 Lower Marsh Ln Kingston upon Thames, Surrey KT1 3BJ Tel: (01) 590 2101 Chief Exec P E Champion, Sales Mgr R J Jarrett
Product: Browser boxes, display racks

Ateka Tape Racks, 23 Station Rd Ind'l Estate Hailsham East Sussex BN27 2ER Tel: (0323) 843191 Mng Dir P H Blank, Mng Dir J Willamowski
Product: Record & tape (audio & video) display racks

Ballantine Advertising, 11 Talbot Square, London W2, Tel: (01) 723 4439.
Product: Record-cassette displays

Bilabel, 3 Speedwell Close, Chandlersford Ind'l Estate, Eastleigh, Hants Tel: (04215) 63434, Gen Mgr & Mktg Dir: Malcolm Paton, Sales Mgr Martin Bennett
Product: Browser boxes, display racks, divider cards

Broomhall Joinery Co. Ltd., 222 High St., Uxbridge, Middx Tel: 37311 Mng Dir S J Hurley, Gen Mgr R F Allen
Product: Record browser boxes, record display racks

Caroline Exports Ltd., 56 Standard Rd., London NW10 6ES Tel: (01) 961 2919 Cable BUMBLEBEE Telex 22164 Mng Dir AT Rose, Studio/Electronics Exec C Stylianou
Product: Browser boxes, displays racks, divider cards

Chess Creative Servs. Ltd., 14A Shoultham St., London W1 Tel: (01) 723 8233 Partners A Smith, P J Lacy
Product: Browser boxes, display racks, divider cards

Crown Merton (div of T.J. Corfield & Buckle Ltd.), Trafalgar Works, Station Rd Merton Abbey, London SW19 2NJ Tel: (01) 542 1144
Product: Hi-Fi tube & wire storage equip

Decor Shopfitting Servs. Ltd., Horton Bank Top Mills, Cooper Ln., Bradford Tel: 76109
Branch: Cuper, Fife, Scotland, G Walker Audio The Studio, South Bridge Tel 2400

Film & Television Prod'n Servs., Pinewood Studios, Iver Heath, Bucks
Product: Tape display racks

Fittall Prods Ltd., Coastguard Rd., Larne, Northern Ireland Tel: (0574) 3015 Telex: 747386, Mng. Dir.: C Rumble
Product: Tape display racks

Format (Sussex) Ltd., Jubilee Rd., Burgess Hill Sussex Tel: (04446) 45245 Telex 87322, Mng Dir Ted Light
Product: Record & tape (audio & video) browser boxes

Gray & Butt Ltd., 45 King St, Stanford Le Hope, Essex Tel: (03756) 3041 Sales Dir: Peter Butt, Gen. Mgr Russell Butt.
Product: Browser boxes, display racks

E Hannibal & Co Ltd, Pinfold Rd., Thurmaston, Leicester Tel: (0533) 695413 Telex 34627 Mng Dir Chris Hetherington, Ass't Mng Dir. Roger Stewart, Music Div Sales Dir Derek Deighton
Product: Browser boxes, divider cards

Howards Silk Screen (Slough) Ltd (div of Tinsley-Robor Group), Albon Close, Petersfield Ave., Slough, Berks Tel: (0753) 31442
Product: Point of purchase materials

Hunt-Leigh (Showcard & Display Co.), 119 Alterburg Gardens London SW11 1JQ
Jubilee Graphics, 101 Wardour St., London W1 Tel: (01) 437-8572
Product: Record & tape (audio & video) browser boxes, record & tape (audio & video) divider cards

S Kemper Ltd., 498 Honeyput Ln, Stanmore, Middx HA7 1JZ Tel: (01) 952 5262 Telex 21400 Sales Dir Paul R S Rogers Sales Mgr Aidan Coles
Product: Record & tape (audio & video) security systems

Lightning Recs Ltd, 841 Harrow Rd., Harlesden, London NW10 5NH Tel: (01) 969 7155 5255 Telex 927813 Mng Dir Raymond Laren, A&R & Mktg. Dir. Keith Yershon, Dist'n & Jukebox Dir David Powell, Commercial Dir Siad Reza

HELP PRESERVE AMERICAN KNOW-HOW.

The technology our country needs to help solve its problems — inflation, energy, foreign imports — isn't going to come out of thin air.

A lot of it's going to come from our colleges and universities. Most of the research done in this country is done on university campuses. And most of our technology is based on that research.

But many colleges and universities are having serious financial problems. They need your company's help to survive.

The free booklet shows how your company can help higher education — and promote corporate objectives, too.

Please write for it. America can't afford to depend on foreign countries for the know-how it needs.

GIVE TO THE COLLEGE OF YOUR CHOICE.



Council for Financial Aid
to Education, Inc.
630 Fifth Avenue New York
N. Y. 10019

Please send me a copy of your booklet "How to Develop an Effective Program of Corporate Support for Higher Education."

Name _____
Title _____
Company _____
Street _____ City _____
State _____ Zip _____ Tel. _____

COUNCIL FOR FINANCIAL AID TO EDUCATION, INC. CFE Ad 630 FIFTH AVENUE, NEW YORK, N. Y. 10019

Product: Record display racks, browser boxes, divider cards.
Lugton & Co. Ltd., PO Box 182, Cross Ln., Hornsey, London N8 7SB. Tel: (01) 348-8211. Mng. Dir.: Walter Ficker; Gen. & Sales Dir.: John Sully
Product: Record browser boxes, tape display racks

Metropolitan Communications, 8a Froggnal Gardens, London NW3 6UX. Tel: (01) 435-8803. Mng. Dir.: Mark R.F. Hanau; Sales Mgr.: R. Hanau; Admin.: A. Lohmeyer.
Product: Audio sampler.
Musonic, see Ziphurst.

Plastic Sales Leicester Ltd., 10/12 Dartford Rd., Leicester LE2 7PQ. Tel: (0533) 833691. Chief Exec.: T. H. Winfield; Gen. Mgr.: Mrs. B.E. Flude.
Product: Record & tape divider cards.

Realth Health Ltd., 15/23 Porteus Rd., London W2. Tel: (01) 723-8495. Dir.: Bryan Whitman.
Product: Browser boxes, display racks, divider cards.

Royco Designs Ltd., Coastguard Rd., Larne, Northern Ireland. Tel: (0574) 3015. Telex: 747386.
Int'l branch: Canada
Product: Tape display racks for 8-tr., cassette, & Beta & VHS videocassette (Space Saver).

Securette Ltd., Bluebridge Ind'l Estate, 5 First Ave., Halstead, Essex CO9 2EX. Tel: (0787) 475912. Mng. Dir.: Bruce J. Samson. Dir.: Mary B. Radcliffe.
Product: Record & tape display racks, record divider cards, tape security systems.

Securivision Ltd., Securivision House, Scholes Ln., Prestwich, Manchester. Tel: (061) 798-9525, (01) 202-0102.
Product: Security Systems (closed circuit TV).

T D K Tape Dist. (UK) Ltd., 341 Brighton Rd., South Croydon, Surrey CR2 6GQ. Tel: (01) 688-7372. Telex: 946727. Mng. Dir.: J.C. Buchan. Sales Mgr.: Derek Huthwaite.
Product: Display racks.

Trade Distributors Northern, 400 Great Horton Rd., Bradford, West Yorks. Tel: (0274) 76809.
Product: Browser Boxes.

Wynd-Up Recs. Ltd., Greengate Ln., Prestwich, Manchester M25 7HW. Tel: (061) 798-9252/0533. Mng. Dir.: Colin Reilly; Gen. Mgr. & Dist'n Dir.: B. Patchett; Sales Dir.: L.J. D'Meara. Local branch: Accessories Div., 14 Birch Ln., Longsight, Manchester. Tel: (061) 224 2823.
Branch: Glasgow, Scotland, Tradeston Ind'l Estate, 7 Kilbirnie Pl. Tel: (041) 429-5155.
Product: Browser boxes, display racks, divider cards.

Ziphurst Ltd., Stylus House, 34/38 Verulam Rd., St. Albans, Herts. AL3 4DF. Tel: (0727) 50611. Telex: 286750. Mng. Dir.: P.H. Blank; Gen. Dir.: D.N. Lever; Sales Dir.: B. Blank; Prod'n Dir.: S.H. Blank.
Product: Browser boxes, display racks, divider cards (Musonic).

• Independent video producers

The following is a list of Video Production companies that are involved in the production and recording of video for concerts, record/artist promos and other music related projects. Facilities, equipment, and services listed are intended as a brief description only and may not necessarily reflect a particular company's full capabilities.

Atlantic Video Servs., 180 Princes Ave., Palmers Green, London N13 6HL. Tel: (01) 889-1415, 888-3275. Dwners: John Mills, D. Todd; Prod'r: John Mills.
Facilities: 1/2", 1/4" Beta & VHS
Facilities: studio—1/4" VCR; lighting equip.; mixing facilities; mobile/portable—1/4" Beta or 1/2" U-matic VCR's; sound & lighting equip.; post-prod'n—none.

Bonsor Video Prod'n, 449 Rayleigh Rd., Thundersley, Essex. Tel: (0268) 776037. Dwner: Keith Bonsor.
Facilities: 1", 1/2"
Facilities: studio—3000 sq. ft. studio; full sound & light package; special effects; mobile/portable—multi-cam setup; sound & lighting rig; post-prod'n—1/4" U-matic editing suite; voice over & captioning facilities.

C T V C, Hillside, Merry Hill Rd., Bushy, Watford WD2 1DR. Tel: (01) 950-4426. Prod'rs: Chris Pettit, Bill Stevenson, Pam Chance.
Facilities: 2", 1/2", 1/4" Beta, VHS & Philips cassette.
Facilities: studio—2" quad & helical VTR's; TV & Music studios; mobile/portable—hand-held cam & mobile sound control unit; post-prod'n—edit suite w/time coding; 16-tr. audio facilities; other—film unit; film editing facilities.

Channel One Video Ltd. (div. of DB&P Video), 52 Matham Rd., East Molesey, Surrey KT8 0SU. Tel: (01) 941-2277. Telex: 926194. Prod'rs: David Baker, Dawn Leith.
Facilities: 1/2", 1/4" Beta & VHS.
Facilities: studio—none; mobile/portable—1 & 2 cam mobile units; post-prod'n—1/4" edit suite; telecine; other—dupl'n.

Lindsey Clennell Videofilm Ltd., 22 Earham St., London WC2. Tel: (01) 836-9211. Prod'r: Lindsey Clennell.
Facilities: 2", 1", 1/2", 1/4" Beta & VHS.

Coe Audio Visual Ltd., 13-A Castle Meadow, Norwich, Norfolk. Tel: 611491. Prod'r: S. Bloomfield.
Facilities: 1/2", 1/4" Beta & VHS.
Facilities: studio—"drive in" studio, 4-tr. audio; mobile/portable—2 cams, 1/4" U-matic VCR, 4-tr. audio; post-prod'n—1/4" U-matic edit suite; transfer facilities.

D S D M & Co., 7 Goodwin's Court, St. Martin's Ln., London WC2. Tel: (01) 379-3286. Dwner & Prod'r: D. Morphet
Facilities: 1", 1/2", 1/4" Beta & VHS.
Facilities: All rented as needed.

Eel Pie Sound (div. of Eel Pie Publ'g Ltd.), PD Box 10, Shepperton Studios, Studio Rd., Shepperton Tel: (09328) 60926. Telex: 932577.
Facilities: 1", 1/2", 1/4" VHS.
Facilities: studio—Shepperton studio stages, multi-track audio facilities; mobile/portable—3 cam demonstration package for multi-cam "E.N.G. style" shoots; post-prod'n—subcontracted.

Ellie Jay (Prod'n) Ltd., 97 Judd St., London WC1. Tel: (01) 388-5771. Dwner & Prod'r: Jack Applebaum.
Facilities: 2", 1", 1/2", 1/4" Beta & VHS.
Facilities: studio—1/4" U-matic VCR, Sony BVU VTR; broadcast cams; mobile/portable—same as studio, post-prod'n—full edit facilities.

Guerrilla Ltd., 32-34 Wellington St., Covent Garden, London WC2E 7BD. Tel: (01) 836-7342. Telex: 262284. Ref. 1907. Prod'r: Roland D. Kemp.
Facilities: 1", 1/2"
Facilities: studio—75' x 35' studio w/white cyc. foldback PA; mobile/portable—8 & 16-tr. audio; 12 seat Landrover; cams, VTR's, lights; post-prod'n—1/4" U-matic edit suite; monitors; sound dubbing facilities.

Kamel Int'l Films Ltd., Robeck House, Victoria Rd., Huddersfield HD1 3RB.

Tel: (0484) 46790. Telex: 51458. Dwners: L. Brooksbank, A. Dwen, K. Hardy, M. Fairless; Prod'r: L. Brooksbank.
Facilities: 1/2", 1/4" VHS.
Facilities: studio—30' x 12' studio; 1 cam; lanrio lighting; mobile/portable—2 camera cars; portable cams; VTR's; lighting; post-prod'n—"Df-line" automatic editing suite; 10 channel sound mixing/dubbing.

Keefco, 302 Fulham Rd., London SW10. Tel: (01) 370-2758. Telex: 262284. Ref. 2564. Dwner: Keith Macmillan; Prod'rs: Keith Macmillan, Philip Davey.
Facilities: 2", 1"
Limelight Film & Video Prod'n, 16 Ingestre Pl., London W1R 3LP. Tel: (01) 734-2228. Dwner: Steve Barron.
Facilities: 2", 1", 1/2", 1/4" Beta & VHS.

Mallet-Godfrey Mulcahy Prod'n, 6 D'Arby St., London W1. Tel: (01) 439-7681. Dwners: David Mallet, Russell Mulcahy, Lexi Godfrey; Prod'r: Lexi Godfrey.
Facilities: 2", 1"
Mandala Films, 35 Beechdale Rd., London SW2 2BN. Tel: (01) 674-1799. Dwner & Prod'r: Kevin DeVillie.
Facilities: 2", 1", 1/2", 1/4" Beta & VHS.
Facilities: studio—rented as needed; mobile/portable—various cams, portable VHS cam & VCR; post-prod'n—facilities for all videocassette formats, sound mixing & transfer facilities.

Mike Mansfield Ent's Ltd., Enterprise House, 9 Great Chapel St., London W1V 3AL. Tel: (01) 434-2021. Telex: 881232. Dwner: Mike Mansfield; Prod'rs: Mike Mansfield, Hillary Tipping.
Facilities: 2", 1", 1/2"
Facilities: studio—none; mobile/portable—1 Ampex VPR 20 1" VTR, Ikegami HL 79 cam; Volkswagen truck w/full complement of sound & lighting equip.; post-prod'n—3X Quad mastering, other—all format videocassette dupl'g & copying.

Millaney-Grant Prod'n, 12 Star St., London W2. Tel: (01) 723-5515, 262-5570/5579. Dwners: Brian Grant, Scott Millaney; Prod'rs: Scott Millaney, Christine Smith; Creative Dirs.: Brian Grant, Godley & Creme.
Facilities: 2", 1"
Picture Palace Prod'n Ltd., 71 Beak St., London W1. Tel: (01) 439 9882. Telex: 27212. Dwners: Malcolm Craddock, John Crome, Des Good, Malcolm Paton, Roy Baird; Prod'r: Des Good.
Facilities: 2", 1", 1/2", 1/4" Beta & VHS.

Precision Video Ltd. (div. of Associated Communications Corp.), 19 Upper Brook St., London W1Y 1PD. Tel: (01) 409-3277. Telex: 267310.
Facilities: 1/2" Beta & VHS

Red Tape Prod'n Ltd., 5 Avery Row, London W1. Tel: (01) 629-3406, 491-7283. Cams: REDTAP. Dwners & Prod'rs: Martin Denning, Robin Tarsnane.
Facilities: 1", 1/2", 1/4" Beta & VHS.
Facilities: Rented as needed.

Rockfilms Ltd., 22 Tavistock St., London WC2. Tel: (01) 836-4901. Dwner: Nick Abson; Prod'r: Felicity Wilson.
Facilities: 2", 1", 1/2"
Facilities: studio—50' x 50' studio; 24-tr. audio; mobile/portable—none; post-prod'n—16mm film cutting facilities.

Jon Roseman Television, 8 Poland St., London W1V 3DG. Tel: (01) 439-8248. Telex: 896559. Dwner & Prod'r: Jon Roseman.
Facilities: 2", 1", 1/2", 1/4" Beta & VHS.
Facilities: studio—caption studios; mobile/portable—none; post-prod'n—2-3 machine high & low band U-matic editing; Vital mixing desk; Datatone computer; Sony 1" & 2" VTR's; Sony color cams.

Studio Weeks/CA Visual, 4 Spencer St., Carlisle CA1 1BG. Tel: (0228) 32325. Dwner: Roger Weeks.
Facilities: 1/2", 1/4" VHS.
Facilities: Rented as needed.

Trytel Int'l Video Ltd., PD Box 181, Acton, London W3 7YF. Tel: (01) 740-5522. Telex: 893540.
Facilities: 2", 1", 1/2", 1/4" Beta & VHS.

Videobands Ltd., 49/53 Kensington Gardens Square, London W2 4BA. Tel: (01) 229-3221. Telex: 28604. Dirs.: Nick Lewin, Terry Bedford, Alan Blake, John Hall, Adrian Lyne, Tony Halton; Prod'r: Gower Frost.
Facilities: 2", 1", 1/2"
Facilities: Rented as needed.

The Video Co. Ltd., 91-93 High St., Edgware, Middx. Tel: (01) 951-0466. Contact: Mel Noonan.
Facilities: 1/2", 1/4" Beta & VHS
Facilities: studio—none; mobile/portable—1/4" U-matic VCR w/cam; post-prod'n—1/4" U-matic edit facilities.

Video for Industry & Promotion Ltd., Eclipse Works, Lime Grove, London W12 8TB. Tel: (01) 743-7752. Dwners: M. Joseph & Son; Prod'r: Jake Bernard.
Facilities: 1/2"
Facilities: studio—600 sq. ft. studio; single cam; mobile/portable—FP-1020-A color cam; Sony BVU-100 VTR; lighting; post-prod'n—2 machine Sony BVU edit suite; visual & audio mixing.

Vintage Television Ltd., 35 Pelergate, Bradford, Yorks. Tel: (0274) 29691. Prod'r: 339416. Prod'r: Paul Hargreaves.
Facilities: 1/2", 1/4" Beta & VHS
Facilities: studio—600 sq. ft. studio, control room & facilities for up to 3 cams; mobile/portable—ENG to broadcast standards on low or high band 1/4" U-matic VCR; post-prod'n—low or high band 1/4" U-matic editing w/ hme base correction; special effects generator & mixer; colorizer; MP controlled capstan generator.

Visnews Ltd., Cumberland Ave., London NW10 7EH. Tel: (01) 965 7733. Telex: 22678.
Facilities: 2", 1", 1/2", 1/4" Beta & VHS.
Facilities: studio—2 cam presentation studio w/Sony BVU editing facilities; mobile/portable—1" mobile facilities; post-prod'n—full post-prod'n facilities.

Zoetrope Ltd., 93 Union Rd., London SW4. Tel: (01) 720 8513. Dwners: Derek & Kate Burbidge; Prod'r: Helen Pritchard.
Facilities: 1"
Facilities: studio—small insert studio; mobile/portable—8-tr. mobile audio unit; post-prod'n—"Df-line" edit facilities.

• playback/recording equipment

A M S Trading (Amstrad) Ltd., 89 Ridley Rd., Dalston, London E8. Tel: (01) 249-5237. (UK)
Awa Sales & Serv. (UK) Ltd., 30/32 Concord Rd., Westwood Park Trading Estate, Western Ave., Acton, London W3 0TH. Tel: (01) 993-1672. Telex: 936239.
Audio: Awa (Japan).
Aka! (UK) Ltd., Haslemere Heathrow Estate, Unit 12, Silver Jubilee Way, Hounslow TW4 6NF. Tel: (01) 897-7171. (Video)

Alpha, see Highgate Acoustics.
Amcron, see Macinnes Labs.
Ampeg Great Britain Ltd., Acree Rd., Reading, Berks. RG2 0QR. Tel: (0734) 85200. Cable: VIDEOTAPE. Telex: 847611. Gen. Mgr.: W. Scullion; Mktg. Servs. Supervisor: C. Murphy-D'Connor; Sales Mgr.: J. Leeson; Adv. Mgr.: P. Vaughan.
Audio & Video: Ampex (USA).
Ampro/Scully, see Lee.
Audiodecks Ltd., PD Box 7, Sandback Way, Wetherby, West Yorks. LS22 4YS. Tel: (Wetherby) 5477.
Audio: Dual.
Auxil Ltd., Station Rd., Wenden, Saffron Walden, Essex CB11 4LR. Tel: (0799) 40888. Cable: AUDIX SAFWALDEN. Telex: 817444. (Audio only).
B A S F UK Ltd., Haddon House, 2/4 Fitzroy St., London W1P 5AD. Tel: (01) 637-8971. Telex: 286449. Div. Mgr.: H.C. Pattison; Prof. Prods. Mgr.: R.M. Hine.
B I C, see British Inds Co.
Bang & Olufsen UK Ltd., Eastbrook Rd., Gloucester GL4 7DE. Tel: (0452) 21591. Telex: 43215. Mng. Dir.: John Portlock; Promos. Mgr.: Malcolm Savill; Adv. Mgr.: R.J. Stockwell.
Audio: Beocord (Denmark).
F W D. Bauch Ltd., 49 Theobald St., Boreham Wood, Herts. WD6 4RZ. Tel: (01) 953-0091. Cable: BAUCH. Telex: 27502. Mng. Dir.: John Bauch, Revex Sales Mgr.: Vaughn Waller; Adv. Mgr.: David Neal.
Audio: Revox.
Bell & Howell A.V. Ltd., Alpertown House, Bridgewater Rd., Wembley, Middx. Tel: (01) 902-8812. Telex: 261378. Cable: BEHDW. Mng. Dir.: D.M. Coupe, Mktg. Mgr.: A. Gell; Pub. Mgr.: B. Clark. (Audio)
Beocord, see Bang & Olufsen.
Binatone Int'l Ltd., Binatone House, 1 Beresford Ave., Wembley, Middx. HA0 1YX. Tel: (01) 903-5211. Cable: BINATDNE WEMBLEY. Telex: 923810. Mng. Dirs.: I.T. & P.T. Lavani; Sales Mgr.: John Lock; Adv. Mgr.: Paul Stranks.
Audio: Binatone Empress.
Blaupunkt, see Robert Bosch.
Robert Bosch Ltd., PD Box 166, Rhodes Way, Station Estate, Watford, Herts. WD2 4LB. Tel: (0923) 442-33.
Video: Bosch Fernseh.
Brenell, see Allen & Heath.
British Inds. Co., 60/61 Leslie Park Rd., Croydon, Surrey CR0 6TP. Tel: (01) 656-2631. Telex: 947912. European Dpns. Dir.: V.L. Parrett.
Audio: BIC.
Broadcast Audio (Equip) Ltd., PD Box 31, Douglas, Isle of Man. Tel: (0624) 4701. Telex: 267900. (Audio).
Carltone, see C.F. Fraser.
Cetelec Int'l Ltd., 15 Northfield Ind'l Estate, Unit F, Beresford Ave., Wembley, Middx. HA0 1YB. Tel: (01) 900-0355. Telex: 935847.
Audio: Gauss.
Connevals Ltd., 1 Norbury Rd., Reigate, Surrey. Tel: (07372) 47571. Pres.: M.H. Evans; Sales Mgr.: D.M. Evans. (Audio only)
Crown Int'l, see Macinnes Labs.
Crown Radio Co. Ltd., Russell Gardens, Wickford, Essex SS11 8RT. Tel: Wickford 634-14. Telex: 995109. (Audio only)
Cuemaster, see Granet.
D J Electronics (Hackney) Ltd., 83 Queens Rd., Southend-on-Sea, Essex SS1 1PY. Tel: (0702) 353033. Telex: 99181. Mng. Dir.: George Sheppard; Sales Mgr.: Jim Sheppard. (Audio)
Decca Radio & Television Ltd., Neachells Ln., Willenhall, Wolverhampton, Staffs. Tel: (Wolverhampton) 67367. (Audio only)
Denon, see Eumig.
Dual, see Audiodecks & Hayden Labs.
Duplitape, 1-7 Harewood Ave., London NW1. Tel: (01) 724-2497. Pres. & Adv. Mgr.: B. Lambden; Sales Mgr.: R. Jackson Moore
Branch: Aylesbury, Bucks., Rabens Lane Ind'l Estate. Tel: Aylesbury 27211. Dir.: Mike McLaughlan.
Audio: Dtrari (Japan)
E S Electronics, 2 Upper Fant Rd., Maidstone, Kent. Tel: 673-355. Telex: 966140. Pres. & Adv. Mgr.: Eric Snowball. (Audio only)
Eagle Int'l, Precision Centre, Heather Park Dr., Wembley HA0 1SU. Tel: (01) 902-8832. Cable: EAGLINT. Telex: 922131. Mng. Dir.: Warren Morrow; Sales Mgr.: Peter Hewitt; Adv. Mgr.: Richard Woolf. (Audio)
Enerlec, see Clive Green.
Eumig (UK) Ltd., 14 Priestley Way, London NW2 7TN. Tel: (01) 450-8070. Telex: 923812. Mng. Dir.: D. Vaughan.
Audio: Denon, Eumig.
Eurotronic Ltd., 178 Pinner Rd., Harrow, Middx. Tel: (01) 863-9898. Mng. Dir.: A.J. Bradshaw-White; Sales Dir.: R. Dyer.
Branch: Manchester, High Bank Trading Estate, Dgden Ln., Dpnsah. Tel: (061) 223-8272. Dir.: D. Tyas (Audio only)
Ferguson, see Thorn.
Ferrograph, see North East Audio & Neal-Ferrograph.
C. F. Fraser Ltd., 21 Princess Rd., London NW1 8JR. Tel: (01) 722-6633.
Audio: Carltone.
Goodmans Loudspeakers Ltd., Downley Rd., Havant, Hants. Tel: (0705) 486344. Telex: 86296. Sales Mgr.: R.A. Hawkes; Mktg. Exec.: Nigel Bain. (Audio only)
Granet Communications Ltd., 39 Beechcroft Manor, Daltdans Dr., Weybridge, Surrey KT13 9NZ. Tel: (0932) 47785.
Audio: Cuemaster, Sparta.
Clive Green & Co. Ltd., Britannia House, Leagrave Rd., Luton, Beds. LU3 1RU. Tel: (0582) 411513. Chief Exec.: Clive Green.
Audio: Enerlec (France).
Grundig Int'l Ltd., Newlands Park, London SE26 5NQ. Tel: (01) 659-2468. Telex: 22854. Mng. Dir.: A.H. Baumes. Sales Mgr.: R.P. Cope; Adv. Mgr.: Leo Stephens; Mktg. Mgr.: R.W. Shingleton (Audio & Video)
C. E. Hammond & Co. Ltd., 105/109 Dyster Ln., Byfleet, Surrey KT14 7LA. Tel: (91) 51051. Cable: APRAN BYFLEET. Telex: 262525. Mng. Dir.: R.L. Higgin, Mktg. Mgr.: R.J. Sharpe.
Audio: Lenco, Otari (Japan)
Harman UK, St. John's Rd., Tyters Green, High Wycombe, Bucks. HP10 8HR. Tel: (049) 481-5331. Telex: 837116. Mng. Dir.: B. Pam; Sales Dir.: J. Reddington, Adv. Mgr.: Frank Hughes.
Audio: Teac (Japan)
Hayden Labs Ltd., Hayden House, Chiltern Hill, Chalfont St. Peter, Gerrard's Cross, Bucks. SL9 9UG. Tel: Gerrards Cross 88447, 89221. Cable: HAYLAB. Telex: 849469.
Audio: Dual, Nagra, Telefunken.
Highgate Acoustics, 38 Jamestown Rd., London NW1 7EJ. Tel: (01) 267-4936. Cable: HINANCO. Mng. Dir.: W.D. Baker, Gen. Mgr.: H. Rimington.
Audio: Tungsram.
Hitachi Sales (UK) Ltd., Hitachi House, Station Rd., Hayes, Middx. UB3 4DR. Tel: (01) 848-8787. Telex: 933611. Mng. Dir.: R. Mor; Adv./Mktg. Mgr.: R.P. Bennett. (Audio only)

Hyosung UK, 7/8 Savile Row, London W1. Tel: (01) 734-1562. (Audio)
 I T T Consumer Prods. (UK) Ltd., Chester Mall Ln., Basildon, Essex SS14
 3BW. Tel: (0268) 3040. Telex: 99101. (Audio & Video)
 I V C, see International Video Corp.
 Image Transform Inc./Compact Video Systems, 17 Old Church Ln., Kings-
 bury, London NW9 8TG. Tel: (01) 205-3231. Telex: 896616. European
 Rep.: D. Werschler. (Audio only)
 Industrial Tape Applications, 1/7 Harewood Ave., London NW1. Tel: (01)
 724-2497. Telex: 21879. Mng. Dir.: B.R. Lambden; Sales Mgr.: M.E. Par-
 miter. (Audio only)
 Int'l branch: France.
 International Video Corp. (IVC) Ltd., 10 Portman Rd., Reading, Berks RG3
 1JR. Tel: (0734) 585421. Cable: INTERVIDEO. Telex: 847579. Mng. Dir.
 John D. Jeffery; Sales Mgr.: Gary J. Glover; Adv. Mgr.: Elizabeth Ling.
 Video: IVC (USA)
 J V C (UK) Ltd., Eldonwall Trading Estate, Staples Corner, 6-8 Priestley Way,
 London NW2 7AF. Tel: (01) 450-2621. Telex: 923320. Mng. Dir.: Kurt
 Lowy; Sales Mgr.: G. Barc; Adv. Mgr.: Geoff Fleming.
 Audio & Video: JVC, Victor (both Japan)
 Lee Eng'g Ltd., Napier House, Bridge St., Walton-on-Thames, Surrey KT12
 JAP. Tel: (01) 833-4324. Cable: LEETECH. Telex: 928475.
 Mng. Dir.: Thomas Lee; Gen. Mgr.: E.E. Welsh
 Audio: Ampro/Scully (USA)
 Lenco, see C.E. Hammond.
 M C I (Professional Studio Equip.) Ltd., MCI House, 54/56 Stanhope St.,
 London NW1 3EX. Tel: (01) 388-7867. Telex: 261116. Mng. Dir.: Dag
 Fellner (Audio only)
 Macinnes Labs. Ltd., Macinnes House, Carlton Park Ind'l Estate, Saxmund-
 ham, Suffolk IP17 2NL. Tel: (0728) 2262. 2615. Cable: MACLABS IPSW-
 ICH. Mng. Dir.: L.M. Marshall; Sales Mgr.: C.R. Flack.
 Audio: Amcron, Crown Int'l (USA)
 Magnetophon, see AEG-Telefunken.
 Marantz Audio UK Ltd., Debmarch House, 193 London Rd., Staines, Middx.
 Tel: (0784) 50132. Telex: 935196. Exec. Dir.: John A. Walker; Prod. Mgr.:
 Steve Harris.
 Audio: Marantz, Superscope.
 Marconi Communication Systems Ltd., Marconi House, Chelmsford, Essex
 CM1 1PL. Tel: (0245) 353221. Cable: EXPANSE. Telex: 99201. Mng. Dir.:
 T. Mayer; Studio Sales Mgr.: A. O. Moore. (Video only)
 Mincom, see 3M.
 Mitsubishi Electric (UK) Ltd., Otterspool Way, Watford, Herts WD2 8LD Tel
 (092) 40566.
 B. H. Morris & Co. (Radio) Ltd., Precision Centre, Heather Park Dr., Wem-
 bly, Middx. HA0 1SU. Tel: (01) 902-9422. Telex: 922131. Mng. Dir.: K.
 Lasky; Mktg. Mgr.: B.T. Cockram; Sales Dir.: A. Allenstein.
 Audio: Tno.
 N A D Sales Ltd., Colonial Way, Unit 3, Watford, Herts (0923) 27737 Telex:
 892478 Pres.: Malcolm Blockley; Sales Mgr.: Stuart Thurston.
 Audio: Fisher, NAD.
 N E A L, see North East Audio Ltd.
 Nagra, see Hayden Labs.
 Nakamichi, see Natural Sound.
 National Panasonic (UK) Ltd., 308 Bath Rd. Slough, Berks. Tel: Slough
 34522 Cable: PANASONIC Telex: 848761. Mng. Dir.: A. Imura. Sales &
 Adv. Mgr.: J. Cox.
 Audio: Technics (Japan)
 Video: Panasonic (Japan).
 Natural Sound Systems Ltd., Strathcona Rd., North Wembley HA9 8QL. Tel:
 (01) 904-0141.
 Audio: Nakamichi, Yamaha.
 Neal-Ferograph, Simonside Works, South Shields, Tyne & Wear NE34 4XF.
 Tel: (0632) 566-321. Telex: 537227. Cable: BRITFERRO. Dir.: T. Batey
 Audio: Ferograph, Neal.

Neve Electronics Int'l Ltd., Cambridge House, Melbourn, Royston, Herts.
 SG8 6AU. Tel: (0763) 60776.
 Audio: Lyrec, Neve.
 North East Audio Ltd., Simonside Works, South Shields, Tyne & Wear NE34
 9NX. Tel: (0632) 566321. Cable: BRITFERRO. Mng. Dir.: A.J. Helliwell;
 Comm'r Dir.: Tom Batey.
 Audio: Ferograph, NEAL.
 Otari, see Dupktape & C.E. Hammond.
 John Page Ltd., Wesley House, Wesley Ave., London NW10. Telex: 24224
 Ref. 568. Mng. Dir.: John Page.
 Audio: Stellavox.
 Panasonic, see National Panasonic.
 Pandamatic, see James Yorke.
 Philips Electrical Ltd., City House, 420 London Rd., Croydon, Surrey. Tel:
 (01) 689-2166. Telex: 946169. (Audio & Video)
 Pioneer High Fidelity (GB) Ltd., Pioneer House, The Ridgeway, Iwer, Bucks.
 Tel: (0753) 652222. Telex: 847533. Mng. Dir.: R. Todd, K. Ito; Sales
 Mgr.: M. Emery; Sales Promo. Exec.: R.G. Church.
 Pye Business Communications Ltd., Cromwell Rd., Cambridge CB1 3HE. Tel
 (0223) 45191. Cable: PYBUSCOM. Telex: 81547 Mng. Dir.: A. Cowie;
 Sales Mgr.: C. Robbins; Adv. Mgr.: E. Huggins.
 Audio & Video: Philips.
 Pye Ltd., 137 Dilton Walk, Cambridge, Cambs. Tel: (02205) 2781. Telex:
 81701. Sales & Adv. Mgr.: J. Coupe. (Audio & Video)
 R C A Ltd., Lincoln Way, Windmill Rd., Sunbury-on-Thames, Middx. Tel: Sun-
 bury-on-Thames 85511. Telex: 24246 (Audio)
 Rank Radio Int'l Ltd., Power Rd., Chiswick, London W4. Tel: (01) 994-6491
 Video: Bush.
 Realistic, see Tandy.
 Revox, see F.W.O. Bauch.
 Rotel HiFi, 2/4 Erica Rd., Stacey Bushes, Milton Keynes. Tel: (0908) 317-
 707. Telex: 826618. Pres.: G. Duffy; Sales Mgr.: Barry Young; Adv. Mgr.:
 Mike Bartlett.
 S I S Ltd., 57 St. Andrews Rd., Northampton NN1 2PB. Tel: (0604) 32965
 Telex: 31499. Pres.: David Mitchell; Sales Mgr.: Ian Brown. (Audio only)
 Saba Radio & Television Ltd., 10/12 Cornbrook Park Rd., Manchester M15
 4EE. Tel: (061) 872-7661. Telex: 669131. Mng. Dir.: R.C. Medford. (Audio
 only)
 Sansui Audio Europe S.A., 39/41 Maple St., London W1P 5FU. Tel: (01) 580-
 5353. (Audio only—distributed by Verntrom)
 Scully, see Lee.
 Sharp Electronics (UK) Ltd., Sharp House, Thorpe Rd., Manchester M10
 9BE. Tel: (061) 205-2333. Telex: 668380. Sales Mgr.: P.A. Dix.
 Branch: Southall, Middx., 357 Uxbridge Rd. Tel: (01) 571-2157. Office
 Mgr.: D.W. Cook.
 Skantic (UK) Ltd., Station Rd., Edenbridge, Kent. Tel: (0732) 865231.
 Tel: 957149. Mng. Dir.: George J. Korbel; Sales Dir.: Dennis Swannack.
 (Audio & Video)
 Sonifex Sound Equip., 15 College St., Irthingborough, Northants. Tel
 (0933) 650-700. Mng. & Sales Dir.: P. Brooke; Adv. Mgr.: Mrs. D. Brooke.
 (Audio only)
 Sony (UK) Ltd., Pyrene House, Sunbury Cross, Sunbury-on-Thames, Middx.
 Tel: (76) 87644. Pres.: W.H. Fulton; Sales Mgr.: P.R. Newell. (Audio &
 Video)
 Soundcraft Electronics Ltd., 5 Great Sutton St., London EC1V 0BX. Tel: (01)
 251-3631. Cable: SOUNDSCRAFT. Telex: 21198. Pres. & Mktg. Mgr.: Philip
 S. Dudderidge. Sales Mgr.: Dave Dearden. (Audio)
 Sou West Sound-Wild West Show, 35 Morrison House, High Trees, Tulse Hill,
 London SW2 3PP. Tel: (01) 674-2892; 422-3462. Pres.: Stuart Wester;
 Sales Mgr.: Roy Williams; Adv. Mgr.: Max Needham. (Audio only)
 Sparta, see Grant.
 Stellavox, see John Page.
 Superscope, see Marantz.
 Tandberg (UK) Ltd., 81 Kirkstall Rd., Leeds, Yorks. LS3 1HR. Tel: (0532)
 35111. Cable: TANBERG LEEDS. Telex: 557611. Mng. & Adv. Dir.: John
 Farnell; Sales Dir.: Bill Harrison. (Audio)
 Tandy Corp. (UK) Ltd., Tameway Tower, Bridge St., Walsall, West Midlands
 WS1 1LA. Tel: (0922) 648181. Telex: 339423. Mng. Dir.: James Nicholas;
 Sales Dir.: John Sayers; Adv. Mgr.: Ray Sawstter
 Audio: Realistic (USA).
 Teac, see Harman.
 Technics, see National Panasonic.
 Telefunken, see AEG-Telefunken & Hayden Labs.
 Thorn Consumer Electronics Ltd., 284 Southbury Rd., Enfield, Middx. Tel:
 (01) 363-5353. Telex: 263201. Sales Dir.: J. Ross; Adv. Mgr.: M.L. Do-
 man.
 Video: Ferguson.
 3 M United Kingdom Ltd., PO Box 1, 3M House, Bracknell, Berks. RG12 1JU.
 Tel: (0344) 26726. Telex: 849371. Mng. Dir.: D.R. Osmon; Mktg. Co-ord.:
 P.A. Stockwell-Jones; Sales & Mktg. Mgr.: D.J. Pacy; Adv. Mgr.: R. Rippon.
 Reg'l sales offices: Belfast BT1 5JE, Northern Ireland, 11 Donegal
 Square S. Tel: (0232) 42811, 42926—Birmingham B3 3EL, Edmund
 House, 12-22 Newhall St. Tel: (021) 236-5077—Glasgow G4 0AY, Scot-
 land, 3M House, 9 Canal St. Tel: (041) 332-9622—London SE20 7TL, PO
 Box 38, Yeoman House, 63 Croydon Rd., Penze. Tel: (01) 659-2323—
 Manchester M15 4PA, 3M House, 28 Great Jackson St. Tel: (061) 236-
 8500.
 Audio: Mincom, Wollensak (both USA).
 Toshiba (UK) Ltd., Toshiba House, Gilling Way, Great South West Rd., Fel-
 tham, Middx. Tel: (01) 751-1281. Cable: TOSHIBA FELTHAM Telex:
 935162. Pub. Mgr.: Michael Hales. (Audio only)
 Trident Audio Developments Ltd., Shepperton Studio Centre, Post No. 38,
 Studios Rd., Shepperton, Middx. TW17 0QD. Tel: (09328) 60241. Telex:
 8813982. Mng. Dir.: Malcolm Toft; Sales Mgr.: Ken Bray. (Audio)
 Trio, see B. H. Morris.
 Tungram, see Highgate Acoustics.
 Uher Sales & Servs. Ltd., 24 Market Pl., Falloden Way, London NW11. Tel:
 (01) 458-8491, 455-1771. Telex: 8812807. Pres.: R.F. Sims; Sales Mgr.:
 R.L. Campbell. (Audio)
 Verntrom Ltd., Thornhill, Southampton SO9 5QF. Tel: (0703) 444811.
 Audio: Sansui (Japan).
 Victor, see JVC.
 Waltham Electronics (UK) Ltd., 155/159 Queens Rd., Watford, Herts. WD1
 2QH. Tel: Watford 24543. Cable: TELERENT. Telex: 923071. Mng. Dir.: M.
 Raymond; Sales Mgr.: A.J. Spector. (Audio only)
 Wollensak, see 3M.
 Wye Audio Prods. Ltd., 27 Station Rd., Brimington, Chesterfield, Derbys. Tel:
 (0246) 70297. Telex: 54284. (Audio).
 Yamaha, see Natural Sound
 James Yorke Ltd., Oak House, Northleach, Gloucestershire GL54 3ET. Tel:
 (04516) 509. Chief Exec.: J. Scarlett. Sales Mgr.: Peter Fanshawe. Studio
 Mgr.: Peter Rinne.
 Audio: Pandamatic, James Yorke.

Tape Supplies

Continued from page A1V/T-58

Econoseal, see Econocorp.
 Gopher Prods. Corp., PO Box 1812, 2201 Lockheed Way, Carson City, Nev.
 89701. Tel: (702) 882-9333. WATS: (800) 648-0958. Pres.: Warren Per-
 luns.
 Product: Labelers.
 Brand names: Rotex, Umline.
 I T I, see Investment Technology.
 Investment Technology Inc., 1940 124 Ave. NE, Bellevue, Wash. 98005. Tel:
 (206) 454-7720.
 Product: Cassette labeler, label printing equip.
 Brand name: ITI.
 M. Latter Mfg. & Sales, 3208 W. Jefferson Blvd., Los Angeles, Calif. 90018.
 Tel: (213) 737-0440. Owner: Mel Latter.
 Product: Shrink packaging machinery.
 M I P, see Molded Ind'l Plastics.
 M M C, see Magnetic Mktg.
 M T I Corp., 124 Montclair Ave., Montclair, N.J. 07042. Tel: (201) 744-2220.
 Cable: MTICORP. Pres.: Timothy A. Cole.
 Product: Labeling & inserting machines.
 Brand name: Tapematic.
 Magnetic Mktg. Corp., 29 Valley View Terr., Wayne, N.J. 07470. Tel: (201)
 694-3502. TELEX: 138558. Pres.: Thomas J. Hofbauer. Sales Mgr.: Bren-
 dan F. Browne; Adv. Mgr.: M. Judge.
 Product: Cassette labeler.
 Brand name: MMMC.
 N J M Inc., 6 Commerce Rd., Fairfield, N.J. 07006. Tel: (201) 227-8300.
 TWX: (710) 734-4353. Pres.: A.R. Schaefer; Mktg. & Sales Dir.: Malcolm
 Smith; Nat'l Sales Mgr.: H.L. Jepson.
 Branches: San Mateo, Calif., 307 S. B St. Zip: 94401. Mgr.: T.A. Paul-
 Des Plaines, Ill., 2720 Des Plaines Ave. Zip: 60018. Tel: (312) 296-1021.
 Mgr.: E. Kristensen.
 Product: Pressure sensitive labeling equip.
 Brand name: Pony Label-ORI, Pony Pacer, Pace Setter.
 Pace Setter, see NJM.
 Pony Label-ORI, see NJM.
 Pony Pacer, see NJM.
 Rotex, see Gopher.
 Rutgers Packaging Corp., see Queens Lithographing.
 Scandia Packaging Machinery Co., 180 Brighton Rd., Clifton, N.J. 07012.
 Tel: (201) 473-6100. Sales Coord.: W.B. Bronander III.
 Product: Packaging machinery for labeling, cartoning, & shrinkwrapping
 8-tr.: labeling, Norelco box inserting, shrinkwrapping for audio cassettes,
 and cartoning & shrinkwrapping for video cassettes. (Complete systems
 available.)
 Shape Inc., PO Box 366, Biddford Ind'l Park, Biddford, Me. 04005. Tel
 (207) 282-6155.
 Product: Automatic cassette assembly & packaging machines.
 Tapematic, see MTI.
 Tuck, see Audio Accessories.
 Umline, see Gopher.

Tape Services

Continued from page A1V/T-42

Gen. & Sales Mgr.: Judy Benz
 Audio: Cassette.
 Audio Cassette Dupl'r's of Wisconsin, 159 E. Silver Spring Dr. Zip: 53217.
 Tel: 961-1635. Pres.: J. Shutter; Gen. Mgr.: G. Miller; Sales Mgr.: J.
 Stoecker. (PKG)
 Audio: Cassette, open reel.
 Video: 1/2" U-matic cassette, 1/4" Beta & VHS cassette.
 Dave Kennedy Rec'g Studios, 231 W. Wisconsin Ave. Zip: 53203. Tel: 273-
 5720. Pres.: Dave Kennedy; Chief Eng.: Larry Drydyk. (PKG—labeling
 service only)
 Audio: 8-tr., cassette, open reel.
 Orange Prod'n House, 6055 W. Fond du Lac. Zip: 53218. Tel: 461-3600.
 Pres.: Larry Lee Hansen; Gen. Mgr.: Jack Shaw; Sales Mgr.: Cindy Gould.
 (PKG)
 Audio: 8-tr., cassette, open reel.
 Video: 1" open reel, 1/2" U-matic cassette, 1/4" Beta & VHS cassette.
 Safeguard Co., PO Box 33, Brookfield 53005. Tel: 782-6430. Pres.: Richard
 A. Rehic; Gen. Mgr.: Barbara Page.
 Branch: Coralville, Iowa.
 Audio: 8-tr., cassette, open reel, 2-tr. cartridge.

3 DUPLICATOR/ MARKETERS OF 8-TR., CASSETTE & OPEN REEL

Ampro Prod'n Inc., 150 Fifth Ave., New York, N.Y. 10011. Tel: (212) 243-
 7726. Cable: TAPEXRON. Telex: 425233.

Tape lines: Apro, Omega.

Barclay-Crocker, 11 Broadway, New York, N.Y. 10004. Tel: (212) 952-0068.

Partner: Henry A. Barclay Jr.

Open reel: Argo, Desmar, Entr'acte, Malcyon, L'Oiseau-Lyre, Mercury,

Musical Heritage Society, Philips, Spectrum, Telefunken, Unicorn, Van-

guard.

Kim Pat Ent's., PO Box 654, Hillwood Dr., Fayetteville, Tenn. 37334. Tel.

(615) 433-2323/5661.

Tape lines: Blaze, Davis Unlimited, MSE, JSJ, Jima, Ken-Tone, Kim-Pat,

Sav-All, Su-Ann.

Utopia Ultra-Sound, 38-40 S. First St., Newark, Ohio 43055. Tel: (614) 345-
 9426. Pres.: Robert H. Kirk Jr.; VP: Don Shannon. Gen. Mgr.: Robert H.

Kirk Sr.; Sales Mgr.: Rose Shannon

8-tr.: Jessup, Mac, SAM, Shelds, UUS.

Big Dreams Start Small

Each of these children and many more are patients at the world's leading childhood cancer research center - St. Jude Children's Research Hospital. Help put an end to childhood cancer.

Support the research and help make dreams come true. Write to St. Jude at P.O. Box 3704, Memphis, Tennessee 38103, or call 1-800-238-9100.

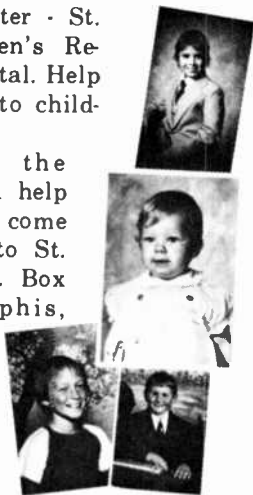

ST. JUDE CHILDREN'S RESEARCH HOSPITAL
 Danny Thomas Founder



**INTERNATIONAL
AUDIO
VIDEO
TAPE
DIRECTORY**

INDEX TO ADVERTISERS

A	
Ace Label Systems.....	56
Agfa-Gevaert Inc.....	7
ASR Recording Services Inc.....	39
ATB SPA.....	69
Audio Industries.....	46
Audiomatic Corporation.....	37, 55
B	
BASF.....	58
Brady Co., W.H.....	25
C	
Certron.....	50
Cetec/Vega.....	15
Custom Cartridge.....	16
D	
Danolin Manufacturing.....	15
Data Packaging Corp.....	45
DCL Products.....	15
Distec Inc.....	32
Donnak Industries.....	48
Duotone.....	22
E	
Ecofina S.R.L.....	68
ElMar Plastics.....	44
F	
Filam National Plastics Inc.....	46
I	
ICM Ltd.....	75
International Compact Cassette.....	68
Italyplast S.R.L.....	70
K	
King Instrument Corp.....	53
L	
Lenco Company (Nebraska).....	42
Liberty Fixture Inc.....	32
M	
Magnetic Media Corp.....	51
Magnex SPA.....	68
Maxell Corp.....	Cover 2
Max Sound Division.....	43
Media Home Entertainment.....	17
Memorex Corporation.....	5
MIP≠Ducale.....	71
MTV Productions.....	18
O	
Otari Corporation.....	13
Overland Products.....	44
P	
Pauli Products.....	31
Precision Video.....	81
R	
Recoton Corp.....	Cover 4
Review Enterprises.....	38
Rosenthal Associates Inc., A.I.....	29
S	
Scandia Packaging Machinery Co.....	59
SHAPE, Inc.....	47
Sound Guard Corp.....	27
Sound Unlimited.....	17
Summit Magnetics.....	73
T	
Tapecom.....	36
TDK Electronics Corp.....	Cover 3
Teac/Tascam.....	11
Track Tape AB.....	77
Trans-Am Industries.....	42



TDK brings two new standards to open reel.

Raising sound standards is nothing new to TDK. For years, TDK cassettes have set reference standards. Now TDK offers two breakthroughs in open reel—GX and LX. Both are bound to cause quite a stir among your open reel customers. Like all TDK products, they're formulated for the finest audio reproduction and fast turnaround.

TDK GX is perfect for the critical demands of music mastering. Equally impressive LX will please the most discriminating audiophile. The way they sell will certainly please you. Their high visibility packaging lets customers know that GX and LX aren't just another couple of open reel tapes. They're TDK. It means their outstanding

formulations are going to get the most out of open reel. All the full, rich sound. And a smooth, reliable performance.

GX is available in four different lengths, all with a special graphite and carbon backcoating that prevents static and reduces modulation noise while providing stable winding. LX is available in six configurations, four available with backcoating for semi-professional and audiophile use.

If you think open reel has gone as far as it can go, introduce your most demanding customers to TDK GX and LX. You could open up a whole new standard for their recording. And a whole new area of sales.

 **TDK**
MUSIC LIVES ON TDK

Now
over 100
products!

RECOTON VIDEO LEADS!

**Profit from our
VCR and Video Disc
bestsellers:**

- Gold Connection™ Cables**
(exclusive low loss engineering)
- Installation Accessories**
- Video Maintenance Products**
- Video Home Storage Cabinets**
- Video "Director"**
- Picture Improvement Products**
- Dust Covers**
- Dubbing and Recording Kits**
- Head Cleaners**
- Camera Accessories**
- Storage Boxes**



Recoton leads again with a new full line Video Accessoryware program. Packaged to sell, each eye-catching package has complete usage details.

Our best seller display assortments of Video maintenance and individual accessory items will complement your company's hardware sales effort.

Profit from experience! In Video as in Audio, Recoton means Accessoryware. "The Only Accessory Source Your Company Ever Needs".

For full catalog information call (212) 392-6442 or write (on business letterhead, please):

Recoton Corporation, Department
46-23 Crane St., Long Island City, N.Y. 11101
Please send your new, expanded 2nd edition Video catalog to:

NAME _____

ADDRESS _____

CITY _____ STATE _____ ZIP _____

SEE US AT THE CES BOOTH 516

World Radio History