



# RADIOWORLD

AUGUST 2, 2017

The News Source for Radio Managers and Engineers

\$5.00

RADIOWORLD.COM

NewBay



Puzzle image: Shutterstock.com/soc5daily

## "Come on, Radio Is Fun!"

Ahead of CBS Merger, Gaviria says  
Entercom focuses on events and localism

BY SCOTT FYBUSH

When Ruth Gaviria came to Entercom last year as chief marketing officer, she arrived with a corporate background that included stints at Procter & Gamble, Colgate Palmolive

and Time Inc. and a media background that included Meredith Corporation's Hispanic-targeted magazines and Univision television and radio. Within a few months of her arrival, her new job grew considerably with the announce-

*(continued on page 3)*

## Making a Marriage Work

Four veteran tech executives share thoughts  
on the challenges of technical integration

BY RANDY J. STINE

**BALA CYNWYD, PA.** — If anyone has a playbook on how to combine technical operations of two major radio broadcast groups smoothly, John Kennedy and Paul Donovan likely will want to see it.

Kennedy, corporate director of technical operations for Entercom Communications, and Donovan, vice president of engineering for CBS Radio, are overseeing the complex integration of engineering staff and technologies pending federal approval of the marriage between Entercom and CBS Radio. The new entity will have a total

of 244 stations in 47 markets with operations in 23 of the top 25 markets in the United States.

The success of the combined company, which will become the second-largest radio broadcaster in the United States based on revenue, will depend in part on the combined work of the engineering, IT and digital departments responsible for the backbone of the broadcast group's technical operations.

The estimated \$2.5 billion deal, being scrutinized by the U.S. Justice Department, could close by the end of this year, according to those familiar with the agreement. That leaves little time to plan out such a herculean effort.

*(continued on page 8)*

ABXNR70T \*\*\*\*\*AUR704\*3-DIGIT 604  
#0007189 # RDM 0007189 E1702  
THOMAS BRAXTON  
PROJECT ENGINEER  
SHURE INC  
201 BURL LN  
BOLINGBROOK IL 60490-2520  
P0001



## Audio Console Meets App

A new way to manage audio at your station



Learn more at [logitekaudio.com](http://logitekaudio.com)



## Make Them Sound Great

Push your talent's voice beyond the limits and dominate the airwaves

Wheatstone Voice/Mic processors give you everything you need to make voices grab listeners by the ears.

For our SQ (Super Quiet) mic pres, we emulated and hot-rodged legendary studio preamps to sound incredible for modern radio.

Our compressors, limiters, & EQs are maximized for vocal smoothness, allowing your talent to stand out on-the-air.

Wheatstone's Graphical User Interfaces give you deep, intuitive control to tweak our world-class presets and save those you create.

The result? Voices that can sound superhuman.

### Wheatstone M-Series Voice/Mic Processors

**M-1:** single channel with knobs and buttons • **M-2:** dual channel with multiband compression • **M4-IP USB:** four-channel networkable BLADE-3

Learn more at [wheatstone.com/superhuman-voices](http://wheatstone.com/superhuman-voices)

**Wheatstone**  
BROADCAST AUDIO PERFECTIONISTS®

Designed and built in the USA. Phone +1-252-638-7000 | [wheatstone.com](http://wheatstone.com) | [sales@wheatstone.com](mailto:sales@wheatstone.com)

## EDITORIAL STAFF

EDITOR IN CHIEF, U.S. Paul J. McLane  
SENIOR EDITOR & TECHNOLOGY EDITOR Brett Moss  
TECHNICAL ADVISER Thomas R. McGinley  
TECHNICAL EDITOR, RWEE W.C. "Cris" Alexander  
PRODUCTION EDITOR, RWEE Karen Lee  
CONTRIBUTING EDITOR Emily Reigart  
CONTRIBUTING EDITOR John Bisset  
WEB EDITOR Michael Balderston  
INTERNATIONAL EDITOR IN CHIEF Marguerite Clark

## EDITORIAL CONTRIBUTORS

Chris Alexander, Susan Ashworth, James Careless, Harry Cole, Ken Autsch, Mark Durenberger, Charles Fitch, Christopher Friesen, Harold Alkainen, Donna Halper, Craig Johnston, Alan Jurison, Paul Kaminski, John Kean, Peter King, Larry Langford, Mark Lapidus, Daniel Mansergh, John Merit, Jim Peck, Mark Persons, Stephen M. Poole, Carl Lindemann, James O'Neal, Tom Osenkowsky, Rich Rarey, John Schneider, Randy Line, Richard Strickland, James G. Withers, Tom Vernon

## ADMINISTRATION & PRODUCTION

PUBLISHER John Casey  
EDITORIAL DIRECTOR Paul J. McLane  
PRODUCTION MANAGER Karen Lee  
ADVERTISING COORDINATOR Caroline Freeland

## AUDIENCE DEVELOPMENT

VICE PRESIDENT | CORPORATE DIRECTOR OF AUDIENCE DEVELOPMENT Meg Estevez  
CIRCULATION MANAGER Kwentin Keenan  
ASSOCIATE CIRCULATION MANAGER Michele Fonville

## SUBSCRIPTIONS

Radio World, P.O. Box 282, Lowell, MA 01853  
TELEPHONE: 888-266-5828 (USA only 8:30 a.m.-5 p.m. EST)  
78-667-0352 (Outside the US) FAX: 978-671-0460  
WEBSITE: www.myRWNews.com  
EMAIL: newbay@computerfulfillment.com

## CORPORATE

NewBay Media LLC  
PRESIDENT AND CEO Steve Palm  
CHIEF FINANCIAL OFFICER Paul Mastrorand  
CONTROLLER Rick Ng  
VICE PRESIDENT OF DIGITAL MEDIA Robert Ames

## IDEO/BROADCAST GROUP

EXECUTIVE VICE PRESIDENT Carmel King  
VICE PRESIDENT / SALES DIRECTOR Eric Trabb

## ADVERTISING SALES REPRESENTATIVES

U.S. REGIONAL & CANADA: John Casey, jcasey@nbmedia.com  
T: 212-378-0400, ext. 512 | F: 330-247-1288  
U.S. REGIONAL: Michele Inderrieden, minderrieden@nbmedia.com  
T: 212-378-0400, ext. 523 | F: 301-234-6303  
EUROPE, AFRICA & MIDDLE EAST:  
Raffaella Calabrese, rcalabrese@nbmedia.com  
T: +39-320-891-1938 | F: +39-02-700-436-999  
LATIN AMERICA: Susana Saibene, susana.saibene@gmail.com  
T: +34-607-31-40-71  
APAC: Eiji Yoshikawa, callems@world.odn.ne.jp  
T: +81-3-3327-5759 | F: +81-3-3322-7933  
SIA-PACIFIC: Wengong Wang, wwg@imaschina.com  
T: +86-755-83862930/40/50 | F: +86-755-83862920  
CLASSIFIEDS: Michele Inderrieden, minderrieden@nbmedia.com  
T: 212-378-0400, ext. 523 | F: 301-234-6303

Radio World Founded by Stevan B. Dana

Radio World (ISSN: 0274-8541) is published bi-weekly with additional issues in February, April, June, August, October and December by NewBay Media, LLC, 28 East 28th Street, 12th floor, New York, NY 10016. Phone: (703) 852-4600, Fax: (703) 852-4582. Periodicals postage rates are paid at New York, NY 0079 and additional mailing offices. POSTMASTER: Send address changes to Radio World, P.O. Box 282, Lowell, MA 01853.

For custom reprints & eprints please contact our reprints coordinator at Wright's Media: 877-652-5295 or newbay@wrightsmedia.com  
List Rental: 914-368-1024, jganis@meritdirect.com

Stock photo ©iStockphoto.com / Edward Grajeda

Copyright 2017 by NewBay Media, LLC.  
All rights reserved.  
Printed in the USA



## GAVIRIA

(continued from page 1)

ment of the company's impending acquisition of CBS Radio's portfolio of major-market stations.

Until that deal closes, Gaviria can't talk about any of Entercom's specific plans for those signals and those new markets. But she spoke to Radio World this spring about what the company is doing and how she and Entercom CEO David Field see the future of the radio business.

**Radio World:** What's the message Entercom is sending to the radio industry right now?

**Gaviria:** It's a very optimistic message. We believe in the power of radio. It has the opportunity and ability to connect brands with fans. It's a growing medium, the least disruptive medium. It's evolved as the number-one reach medium. We reach 240 million people a month, which is really amazing. We are really bullish about radio.

**RW:** David Field has been traveling the country to visit Entercom's local markets. What are some of the things he's seeing? What's he picking up on his visits?

**Gaviria:** Our business model is about local marketing, so local is at the core of everything we do. The listener is at the center of our business model. So our investment in local personalities, local

**"As you look at advertisers, there's a renewed commitment to mass media, there's renewed commitment to the massive scale that radio has, and in our case the local connection we can provide."**

brands, the events that connect communities and help them thrive is really the core business model that we have. David and [Chief Operating Officer] Weezie Kramer going around to local markets, they're even more optimistic about the power of local connections and how brands can benefit from that. When you start looking at a media-mix model, and when you look at the power of each medium, and when you look at automotive for example, you see the importance of media that has a day in, day out relationship with the consumer and that can translate that relationship to a brand. So for us, it's an incredible time. I also think that as you look at advertisers, there's a renewed commitment to mass media, there's renewed commitment to the massive scale that radio has, and in our case the local connection we can provide.

**RW:** What will it mean to add CBS Radio's stations and markets to that mix?

**Gaviria:** I can only speak to my life right now, to what Entercom is right now. We are continuing to invest in local relentlessly. What does that mean? We continue to do the research, to ensure we have the best local personalities, and continue to work collaboratively in each of the markets to make sure we offer multi-market plays and national plays. I can see the opportunity of what this can be, but for right now what I'm focused on is how I can serve my advertisers and my listeners today.

**RW:** For several groups, event promotion has become a big part of their business model. What does it mean for Entercom?

**Gaviria:** Entercom produces 4,000 events a year, and it's from small farm-to-table events or custom-crafted events to massive events where we have audiences of 10,000 and more like Riptide [Music Festival] in Miami or Pain in the Grass in Seattle. Events are parts and parcel of the connectivity we have with the community. It's an integrated play, right? So from a consumer perspective, we want to make sure our that local brand is touching that consumer "360." Events and digital are part of that conversation.

The inflection point is, the radio brand and the on-air personalities that have that relationship, how do you extend that? We extend it through events

that make sense organically. One of the things you'll see Entercom doing is custom local events. We do not have that cookie-cutter, all events are named one thing. When an advertiser comes to us, we say, "We can give you access to that consumer, but it's going to look a little different in each market." Because we want to make sure that we are really connecting with that audience. So it's a major part of this business and something we want to continue to grow. And it's fun! Come on, radio is fun!

**RW:** Let's talk about that fun part, because that sometimes gets lost, especially in groups that don't have a lot of local personality to work off of. How important is it to keep that feeling of excitement going in the business?

**Gaviria:** You're talking my language. Radio reaches 92 percent of millenni-



**Ruth Gaviria.** "We want to be a champion for the radio industry, we are poised to continue to connect with local communities and build our enterprise in that way."

als, 95 percent of Generation X. If we weren't cool and fun, we wouldn't be reaching that many. Ninety-two percent translates to 67 million millennials. The way we do that is music discovery — we are committed to new artists, to new music. Bacon and bourbon events, that's fun, right? We are launching a new beer in one of our markets. We're able to have that agility, to have that kind of connectivity to consumers to be able to respond, to take risks in the right places. That's a super millennial thing, and it's super fun. And I think that's part of what radio can offer, and one of the reasons radio keeps young, because of the audience it serves and because we have the ability to do so many fun things.

**RW:** What about the role of digital media? Where are the digital plays right now, and what is some of the non-traditional revenue you can generate in that space?

**Gaviria:** Digital is an imperative, and the new reality is that we have to have integrated enterprise, and we do.

What we've done is to ensure each of our broadcast brands has its own digital frame. The inception point of content and the inception point of relationship is the broadcast, but then we continue that conversation on digital, on social, on podcast, and also on loyalty programs. So on a weekly basis, for example, across our footprint we have 55 million shares a week. We have over 10 million monthly listening hours on streams. We also have 12 million podcast downloads a month. And we are able to offer that to advertisers. I don't think there is any longer just a discrete broadcast play, there is an integrated play.

(Continued on page 5)

**FREE Orban**  
OR \$1,000 \$2,000 \$3,000  
Discounts on all VS Series  
nautel.com/OrbanFree123 nautel

# Programs Nourish Engineering Talent

iHeartMedia's COOP approach brings new blood into radio engineering

## RADIO EMPLOYMENT

BY JAMES CARELESS

"Radio needs engineers!" is the battle cry of station managers across North America, and has been for years. The problem is where to find this new blood. And as baby boomer engineering directors retire, colleges graduates seem even more likely to seek uber-profitable 9-to-5 IT office jobs rather than more "realistically compensated" positions in radio that may involve 'round-the-clock responsibilities and multiple working locations.

Of course, as many a radio engineer will tell you, an engineering job — particularly one involving RF — offers a level of variety and adventure that a desk IT job can't. So the challenge for radio engineering directors is to expose college technical students to the romance and quirkiness of the profession. Once they have been exposed, many such students become hooked and

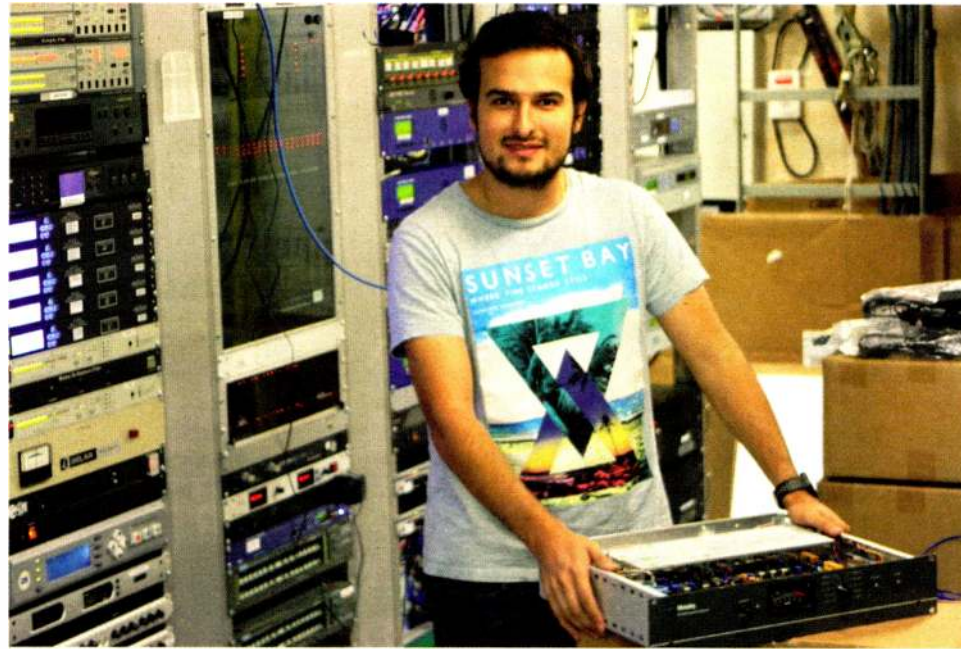

Virgilio Martinez Sanchez

commit to it for life.

iHeartMedia is one company that has grasped this truth and run with it. Under the company's COOP program,

electrical engineering students at the University of Cincinnati, Philadelphia's Drexel University and other U.S. colleges spend part of their education as

paid interns at iHeartMedia.

"The typical pattern is that an electrical engineering student alternates a semester in college, then a semester working for us as an iHeartMedia COOP engineering intern," said Jeff Littlejohn, iHeartMedia's EVP of engineering and systems.

"Typically, they join us for two semesters in total. During that time, these interns get hands-on experience with our engineers; working on our radio studio and transmission facilities, and gaining real skills."

### ONE-TWO COMBINATION

Under its COOP program, iHeartMedia typically hires and trains eight to 12 interns annually.

"Our goal is for them to experience the diversity and challenges of RF engineering firsthand, and to get caught up in the romance of radio," said Littlejohn. "As anyone who has worked in radio knows, no two stations' facilities are exactly alike. That's one thing that makes maintaining, troubleshooting and upgrading them challenging, but also interesting for RF engineers. The work

(continued on page 6)

## ARC Solo

All-in-one remote control.



Nothing else to buy.



ARC Solo is loaded with the powerful features you have come to expect from Burk. Features like Jet™ Active Flowcharts, custom email templates and the Recordable Speech Interface. And all the I/O is conveniently located on the rear panel, with connections for up to 16 status, meters and relays. With ARC Solo there's nothing else to buy.

**BURK**  
TECHNOLOGY

www.burk.com | sales@burk.com | 978-486-0086 x700

SOLUTIONS YOU CAN USE. EXPERIENCE YOU CAN TRUST.

**SUMMER SPECIAL!**  
Save \$995 when you buy an ARC Solo with AutoPilot®.  
Offer ends September 22, 2017

AUGUST 2, 2017

NEWS

"Come on, Radio Is Fun!" ..... 1  
 Making a Marriage Work ..... 1  
 Programs Nourish Engineering  
 Talent ..... 4  
 In Case You Missed It ..... 8

FEATURES

End the Mystery of the  
 Transmitter Site ..... 12  
 TAB Event Attracts Beyond  
 Lone Star State ..... 14



SUMMER OF PRODUCTS  
 ..... 18, 19, 22, 24

BUYER'S GUIDE

Comrex Keeps on Working  
 for VPR ..... 26  
 Tech Updates ..... 27, 28, 30, 31  
 Channel 4 and Telos Team Up ..... 28  
 BBN Spreads Message With  
 GatesAir ..... 29  
 Barix Delivers for New World  
 Radio Group ..... 30  
 AEQ Outfits La Xarxa ..... 32  
 Tieline Climbs New Heights in  
 Colorado ..... 34



OPINION

EAS Is Still Relevant as WEA  
 Works Out Kinks ..... 37  
 Reader's Forum ..... 38

GAVIRIA

(continued from page 3)

But you need to make sure you have permission from that and you need to make sure digital delivers, that it's something that actually doubles down and delivers. So we are very committed to having a completely integrated enterprise. And we are very listener-led. Listeners want to continue this conversation on digital, it's really a mobile platform. And it needs to be digital, and we are.

**RW:** How did you get into radio?

**Gaviria:** I worked at Univision, and that enterprise was very TV-focused. But we did have a radio piece, and we had an opportunity to rebrand radio and integrate radio into the full picture of how we touched consumers. I got recruited into radio.

At the time, I didn't really understand Entercom's play. I call Entercom the hidden gem, a hidden brand about to be not so hidden. In talking to David and hearing his vision, for me it was serving local communities and that what we do matters. And when you have a values-driven and a mission-driven company, where the CEO is committed to serving communities. One day a quarter, we're allowed to fundraise for anything that we think makes sense for the community. You have to find meaning in your job, and it's very meaningful for what we can provide to the community and by default be able to provide to advertisers. I got hooked! And then you go to a few concerts, you go to "Bourbon and Bacon" in Denver, you go to Miami for Riptide, it's not a bad job!

**RW:** While you can't talk about the details of your plans for CBS Radio, it's been publicly announced that the merged company will keep the Entercom name. Will we be seeing a higher profile for Entercom in the industry?

we have a balanced message out there, so that advertisers can make a decision to include radio as part of the mix.

We want to be a champion for the radio industry, we are poised to continue to connect with local communities and

**"The inception point of content and the inception point of relationship is the broadcast, but then we continue that conversation on digital, on social, on podcast, and also on loyalty programs."**

**Gaviria:** From a business-to-business perspective, absolutely. We made the decision. David has shared that this will be "Entercom." I know we will be much more vocal as a business enterprise, representing the value of radio, stepping up to the plate in terms of how to educate advertisers on what radio can do, investing in the marketing of radio, investing in research, in radio impact studies, so that

build our enterprise in that way. I think radio is going to be important to the vitality of the media industry. We need to offer advertisers an easier way to participate in events and have this 360 experience. It's really about experiential marketing, and when you harness the power of radio, you harness the consumer in a way that you can get more share of mind.

**eBooks: Tools for Strategic Technology Decision-Making**



Radio World's growing library of eBooks can assist you in maximizing your investment in an array of platforms and tools: licensed transmission, online streaming, mobile apps, multicasting, translators, podcasts, RDS, metadata and much more. The eBooks are a huge hit with readers. They help engineers, GMs, operations managers and other top radio executives — radio's new breed of digital, cross-platform decision-makers — understand this new world and thrive in it.

**Visit [radioworld.com/ebooks](http://radioworld.com/ebooks)**



**RADIOWORLD  
 INDUSTRY  
 INNOVATOR  
 Awards 2017**

**Do You Know an Innovator? Salute Them!**

NewBay, parent of Radio World, has announced the first annual NewBay Industry Innovator Awards, honoring people who make a difference in radio/audio technology, TV/video technology, streaming, content production/delivery and government video.

Everybody knows someone who innovates in these fields and whose role deserves more appreciation. Perhaps it's a director of engineering, a manufacturing product designer, a consultant or technical researcher ... anyone on the cutting edge of great content — your customer, your employee, your boss. It could be you!

Learn more at [tinyurl.com/rw-innovator](http://tinyurl.com/rw-innovator).

## COOP

(continued from page 4)

is always creative and different.”

Once these COOP students graduate, the best of them are offered full-time jobs with iHeartMedia. But the educational opportunities don't end there: Since 2014, Littlejohn has run a two-year Market Engineering Manager Development Program, “MEM-Dev,” that uses a mix of online and hands-on training (including complex group projects) to bring assistant engineers up to full management capabilities. As with COOP, the company's goal is to put eight to 12 people through the MEM-Dev program every year.

**The typical pattern** is that an electrical engineering student alternates a semester in college, then a semester working for us as an iHeartMedia COOP engineering intern.

— Jeff Littlejohn

“An electrical engineering student who has taken two years' of our COOP program in college and then gone through two years of MEM-Dev while on the job at iHeartMedia has enough skills and experience to support a medium market radio station or group of stations,” said Littlejohn.

“This one-two combination works: We've been able to fill a number of our RF engineering positions this way with young, motivated engineers.”

### THE INTERNS' VIEW

Chris Herlinger, Virgilio Martinez Sanchez and Drake Spivey have three things in common.

First, all were college students being trained as electrical engineers and decided to do COOP terms with iHeartMedia. Second, they are now full-time RF engineers working in various iHeartMedia markets. Third, all three all love being RF engineers, even though they hadn't entered college with radio as a career choice.

Herlinger is director of engineering for iHeartMedia in Waco/Killeen, Texas. Martinez is a broadcast transmission engineer who serves Austin and San Antonio, and Spivey is chief engineer for Milwaukee and Madison.

In each of these former interns' instances, their colleges and iHeartMedia made an effort to attract them to RF engineering as COOP options.

“I heard about the iHeartMedia COOP program from a woman in our engineering department at University of Texas at Arlington,” said Martinez. “Then, right out of the blue, I got a phone call from iHeartMedia Senior Vice President of Engineering Tom Cox, asking if I was interested in an interview. I went to Dallas for that interview, got accepted, and soon enough was doing actual field work with iHeartMedia engineers.”



Drake Spivey

Taking part in the iHeartMedia COOP program presented these interns with novel, hands-on assignments from the get-go, under the expert guidance of iHeartMedia engineers.

“I got to build a box full of relays, that would switch between a station's main and backup transmitters automatically in emergencies,” said Herlinger. “I was working with high-power lines and multi-kilowatt transmitters; the stakes were really high.”

Once these three had graduated, full-time radio jobs awaited all of them.

“As soon as I was finished school in February 2016, iHeartMedia asked me to take over RF engineering for a six-station group in Madison, Wis.,” said Spivey. “I am now based in Milwaukee, working as chief engineer for four AM and two FM stations.”

As full-time employees at iHeartMedia, these former interns have access to the MEM-Dev program. Herlinger and Spivey are enrolled: “Besides online learning, we get to take part in group exercises that matter, such as rebuilding one of our AM station's transmission facilities,” said Spivey. “How cool is that?”

For these former interns, taking part in iHeartMedia's COOP program steered them to lifelong careers in radio. “This is such a varied and different business to be in,” said Martinez. “Without taking part in the iHeartMedia COOP course, I would never have considered radio as my profession of choice.”

From iHeartMedia's perspective, the company's COOP and MEM-Dev programs have provided a practical, effective answer to the question of where to find new technical staff.

“The system works,” said Littlejohn. “COOP allows us to interest young engineers into coming into radio,



Chris Herlinger

while MEM-Dev gets them up to speed fast to serve our medium- and small-market stations.”

*Does your organization have a program to develop radio engineers? Tell us about it at radioworld@nbmedia.com.*

# RUNNING A LIVE BROADCAST

## ACCESS 2USB

Ultra-portable IP audio codec designed for versatility

On May 23rd, 2016, Belgian broadcaster Jonathan Vanooteghem went the distance to conquer an unprecedented feat — he completed a live broadcast while running the City Run of Ghent with the help of his Comrex ACCESS 2USB Portable.

I wanted to combine my two favorite hobbies: athletics and making radio. Why shouldn't I do them both at the same time?

Jonathan Vanooteghem



Contact Us Today to Learn More  
1-800-237-1776 | [info@comrex.com](mailto:info@comrex.com)



# COMREX

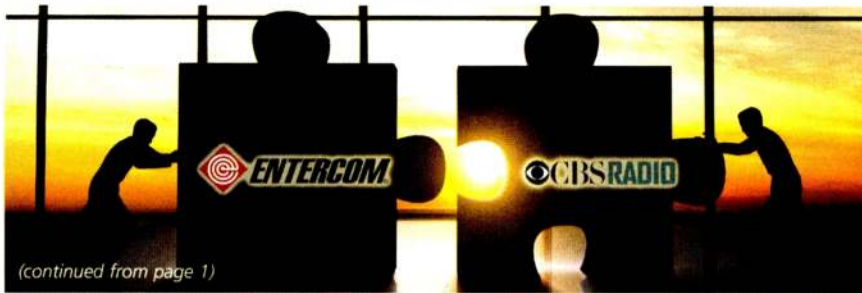

(continued from page 1)

It's not clear exactly how many people in the engineering and technical staffs at the two companies will be affected, though there is some market overlap between them. Entercom has announced it is placing 14 FMs in a trust for future spinoffs.

Execution of their integration work will be scrutinized by those inside and outside the company, according to people who have been through complicated mergers.

Kennedy declined to be interviewed for this story while a CBS Radio spokesperson declined on behalf of Donovan. Given that we were unable to speak directly with them, we asked four expert outsiders, former corporate engineering executives who have been through a variety of mergers and acquisitions, to comment on what a technical game plan for such a huge merger might look like and the potential pitfalls. Respondents were Gary Kline, former VP of engineering for Cumulus; Milford Smith, longtime director of engineering for Greater Media; Bert Goldman, one-time

VP of engineering for ABC Radio; and Andy Laird, former vice president and chief technology officer for Journal Broadcast Group.

**RW:** *What are some of the first engineering management issues that come to mind when merging broadcast companies?*

**Kline:** I typically start with the big-picture outline and then narrow things. The big picture may include departments you are not directly responsible for but somehow may touch. For example, HR systems may be on the engineer's list because there's interaction with IT or access in the local markets — things which engineering should be involved with but more in a support role. In the early stages of a business deal, you may not be permitted to discuss anything with the other party or their employees, even though you may know them well. Radio is a small business, especially in the engineering ranks. So in the beginning, I'd form a list of questions

that the business development and legal teams can request.

**Smith:** Whereas it might seem like equipment, budgets, procedures and the like would be first up, I would make a case for people being the first priority. Such transactions are fraught with anxiety, fear of the unknown and insecurity on the part of all the staffs involved, technical staffs included. Good broadcast engineers are extraordinarily difficult to find and more challenging

and to provide positive assurances is very much time well spent.

**Laird:** Both companies are very successful, so job one is do no harm!

If there is a broadcast engineering technical mandate that needs to be understood, ask: What technical procedures and records are in place at each company? How good is the physical diligence for the properties? What are the reporting structures for each technical group and how do they differ? How

**Such transactions** are fraught with anxiety, fear of the unknown and insecurity on the part of all the staffs involved, technical staffs included.

— Milford Smith

still to "lure away" in the event of an opening. Thus, it's my opinion that the number one priority is to immediately get acquainted with the new folks suddenly joining the organization and to allay their fears and concerns going forward. It's important, too, to make sure "your" people have any concerns addressed relative to the merged entity. These are unsettling times, and efforts made to make the situation less scary

do the two companies differ concerning FCC related issues, representation? How do each of the companies handle expert technical work — in-house, consultants? Since one company is mostly major market and the other large and medium market, does it make sense to consolidate technical management across the combined group? Major changes take time for personnel buy in, for trust to develop.

(continued on page 10)

## IN CASE YOU MISSED IT

Radio World and our NewsBytes e-newsletter complement one another. The magazine brings you news analysis, features and deep-dive coverage 26 times a year; the newsletter provides a snapshot of a day's regulatory and technology headlines in near-real time. To receive the free newsletter, click the **Subscribe** tab at radioworld.com, then choose **Newsletters**.

Here's a sampling of headlines from recent weeks:

### ► **House Bill Would Give FMs Some Repack Relief**

A bill introduced in Congress by Rep. Frank Pallone (D-N.J.) asking for more money to help TV stations includes a pledge to assist radio stations that experience service interruptions.

### ► **FEMA Schedules Next National EAS Test**

Mark your September calendar for Wednesday Sept. 27 at 2:30 p.m. (ET) — and note the backup date one week later.

### ► **Broadcast Engineer Jack Layton Passes Away at 76**

A broadcast engineer and consultant, his written work included "Directional Broadcast Antennas" and "Directional Antennas Made Simple."

### ► **NAB: Main Studio Rule Actually Impedes Service**

The association said a slew of comments overwhelmingly support eliminating the longstanding requirement for stations to maintain staffed main studios near their communities of license.

### ► **Weller Returns as AFCE Board President**

All officers are reprising the roles they held during the prior term: Bob Weller returns as president; John Lyons will serve as vice president; Chris Horne was elected as secretary; and Ron Chase fills the role of treasurer. David Layer will step down from the board, and Anne Goodwin Crump joins.

### ► **19 Ways to Make the FCC Rules Better**

Several large U.S. radio entities — including the largest one, as well as an influential public broadcaster — want the FCC to change a bunch of familiar management and technical rules under which broadcasters have operated for years. Their proposals touch on issues from station IDs and ownership reports to AM proofs and single-sideband FM stereo carriers.

### ► **Public Broadcasters Ask FCC to Reevaluate Channel 6 Protections**

The current rules mean that "NCE FM stations have been forced to limit their service coverage



areas so as to avoid interfering with non-existent analog television receivers," they wrote.

### ► **Broadcasters Have Call Option for Stake in NextRadio App**

Is the ownership structure of NextRadio and TagStation about to change?

### ► **Nebraska SECC Chair: Handle Blue Alerts Differently**

Rodney Zeigler thinks that the Blue Alerts plan is overreach and suggests they be treated more like Silver Alerts.



# More than just an IP Codec...

**“ViA’s touch screen is a game changer for us. It allows you to access what you want quickly and this is particularly useful when connecting over Wi-Fi.”**

- John Herath, Director of Operations, Farm Journal Radio

AgriTalk is a live talk radio program focusing on agriculture and rural America which airs on 98 affiliate stations throughout the Midwest. The show is on the road for over 100 days a year and they rely on ViA for remotes over Wi-Fi, LAN and cellular connections.

- Full duplex stereo program plus separate full duplex IFB communications
- 5 input digital mixer and configurable matrix router (3 x XLR inputs, plus stereo analog line in, or stereo digital in/out)
- Built-in dual band Wi-Fi with integrated web-browser
- Dual LAN & USB ports & optional ISDN or POTS modules
- Schedule, dial, manage & hangup connections automatically
- Adjustable input EQ & compression, plus AGC limiting
- 6.5 hours of power with one internal battery



Join the #ViARevolution

## ((( ViA )))

**Tieline**   
The Codec Company

317-845-8000 | sales@tieline.com | tieline.com



(continued from page 8)

Certainly the merger improves capital purchasing leverage. How can communication among CEs be fostered for sharing best practices? The collaboration tools we have today are a great help.

**RW:** How is redundancy in technical operations typically handled?

**Goldman:** There are two kinds of redundancies.

Technical equipment redundancies is the first type. As part of the overall planning, office/studio and transmitter leases should be evaluated as to cost, lease restrictions and term. If it makes sense, and as part of the due diligence budget, any potential consolidation should be examined and budgeted. FCC allotments should be checked to see if consolidation of tower sites and/or facility upgrades should be considered. The lease terms for studio and transmitter seldom line up with the acquisition schedule, so there's usually some period of time when operations remain separate and redundant.

Personnel redundancy is the second type. This is tough and varies considerably by company culture and overall needs. From a corporate standpoint, the corporate engineer of the company being acquired is seldom retained, at least not in the same capacity. Regarding local station staff, questions come up very soon after the merger announcement as to what the new company's intentions are both from incumbent and by the engineers being acquired. In my experience, however, unfortunately, I've found that the engineering personnel are the last to be considered when companies are merging. Ultimately, upper management and imposed budgets make hard decisions necessary.

**Smith:** I think communication with staff is the key. There will obviously be some painful changes that will ultimately have

to be made — and I can speak from personal experience! — but if humane measures are put in place as to any reductions in staff the potential pain can be considerably eased and the negative turned into at least a partial positive. For those unfortunate enough to be RIF-ed [slang for fired], there are new opportunities out there. Any severance arrangements should allow the individual impacted time to seek them out.

**RW:** What kind of technical issues must be laid out and managed? How are legacy networks and various brands of equipment dealt with?

**Laird:** Any technical issues that can put a license in jeopardy require immediate attention. Do all the stations have established procedures that are followed daily, weekly, monthly and yearly with record keeping? Example: tower inspections, history of transmitter and antenna parameters, server back-ups, testing

of back-ups, etc. How are the ongoing inspection results reported to the station manager and to corporate technical management? Legacy technical networks and various brands of equipment within an enterprise of this size are normal. This is not necessarily a bad thing as long as proper IT structure and security is in place to protect them. The need to change is sometimes driven to get new features or because of discontinued hardware and/or software support. With the merger, station technology changes may be needed to support back office initiatives, centralized traffic, billing and IT management. Considering audio programming, will file sharing and voice tracking be expanded?

**Kline:** The first higher-level engineering things that come to mind are the major backend systems for each. Then

there are lots of questions to be answered about HR/payroll, accounting, CRM, billing/traffic, music scheduling, streaming, etc.

**Goldman:** Regarding legacy networks and equipment, I advise folks not to move too quickly. If the stations are all being consolidated into a new facility, I'd wait until then to make major changes. All involved staffs should have a hand in deciding what brands of equipment are purchased. Some equipment by necessity must be the same, but many equipment items can remain specific to the needs of the individual stations or even specific people, such as preferred production equipment. When deciding on a common equipment platform, like consoles and automation, solicit input from everyone. It may not change the ultimate choice if there's a company preference, but it may prompt some tweaks to make it more user-friendly to the newcomers on the chosen platform.

**RW:** There are likely culture differences between the companies. How does a manager handle operational differences?

**Smith:** Likely, at the outset, the right way to do things, the right way to structure the organization, management wise, and the right level of staffing is pretty

ing mechanical systems, real property issues, roofs, electrical panels, fire suppression, etc. There should be procedures specific to FCC, such as tower lights, EAS, Part 101 license renewals not associated with the station license. And what about OSHA compliance issues, noise, personal protection, physical hazards and RF exposure? Standardized reporting helps corporate engineering properly oversee technical management responsibilities. This is usually not a big issue with technical personnel, especially if they know they get support when issues arise.

**RW:** How much time is given to deciding who reports to whom and can you describe the process?

**Goldman:** Usually, the acquiring company and people associated with the acquiring company take the upper hand in the reporting process. I think it's simply a trust issue. The corporate staff knows and trusts the local station manager, who knows and trusts the department heads. That's why I suggest waiting for a while before making any particular staff cuts or organizational changes until more is known about the people coming into the company. Speaking for myself, I have experienced being forced to make decisions before I could properly get to know the new people I was managing. As a result I didn't make the best choices.

**RW:** What little things tend to bog you down when planning a merger? From your experiences what potholes can be avoided?

**Smith:** Trying to focus on the minutiae right out of the box is, I believe, a mistake. That can tie you up in knots and result in noting much of consequence being accomplished.

**Laird:** Many potholes with technical staff can be avoided by establishing a clear path for technical communication on closing day. The first day communication package is critical for reducing those problems. If there's a lack of information the void will be filled with bad speculation. Anticipate likely questions by starting a FAQ. Have the org chart available with contact numbers.

**Goldman:** The biggest potential pothole I'd say that a technical manager must keep in mind when going through a merger is that you must minimize future surprises. Corporate managers really hate surprises. Learn as much as you can as fast as you can about the technical facilities and the people managing those facilities to provide good intelligence and minimize surprises after closing.

**In my experience ... unfortunately, I've found that the engineering personnel are the last to be considered when companies are merging.**

— Burt Goldman



# *First Invent. Then Innovate.*



## **Meet the Axia IP-Tablet!**

Axia® invented AoIP for broadcast in 2003. Fourteen years later, Axia users enjoy the largest network of AoIP broadcast equipment companies—the 100+ Axia Livewire® partners. When you have Axia gear, you are part of a growing, innovation-driven ecosystem—not locked to just one company’s vision of the future.

Now users are choosing the latest invention from Axia: The award-winning IP-Tablet, designed by our partner IP-Studio. IP-Tablet removes cumbersome monitors from the studio by virtualizing the monitoring and control of your gear on a conveniently mounted touchscreen, whether across the table or across the room.

Add value to your Axia console purchase by putting your most-used console functions right at your fingertips!

***Invent. Innovate. Repeat.***

[TelosAlliance.com/Axia/IP-Tablet](http://TelosAlliance.com/Axia/IP-Tablet)



# End the Mystery of the Transmitter Site

You take pictures of transmitters — so share them with nontechnical staff

## WORKBENCH

by John Bisset

Read more Workbench articles online at radioworld.com

**R**andall Rocks leads the engineering team at Cumulus' Boise, Idaho, cluster. Along with his associate Bill Frahm, they make it a point to keep their staff informed.



Fig. 2: Visual in the TOC help dispel some of the mystery about off-site transmitter and tower facilities.

Figs. 1 and 2 are examples. Equipment racks in the Boise technical operations center have solid front doors and are organized by station. So the staff can see what each transmitter site looks like, Randall and Bill have posted pictures of each station's site. Further, tours of the site are available for employees. This is also helpful for new employees to see what a transmitter site actually looks like.

Non-technical folks hear about a transmitter site or tower but really have no idea what it means. In the age of smartphone technology, snapping transmitter site pictures and posting them gives your staff a better idea of what you do and takes little effort.

One creative engineer I know posts a weekly "What is it?" picture in the staff break room. Photos of burned components, snakes or other animals and other curious things found at the remote site help bring your staff into the world of engineering.

If you maintain an AM and invite the sales staff to visit, bring along a fluorescent tube. As the tube illuminates because of the RF in the room, you can demonstrate how the signal weakens as the tube is moved further away from the RF source. This demonstration will stick with them for years! I still remember the first time I saw it done as a lad of 12.

**B**ill Frahm shared a solution to a problem common in studios: the chair banging into equipment mounted in the vertical rack space to the left and right of the console.

In his picture, Bill mounted a



Fig. 3: A blank panel mounted on long standoffs prevents switches or other front-panel components from being bumped by the studio chair.



Fig. 4: Daniel Hyatt found another use for the vinyl used to wrap station vehicles: Apply it to your studio furniture.



Fig. 5: A sleek but inexpensive studio tabletop.

blank panel on standoffs. Long bolts with nuts will also work. Seen in Fig. 3, the panel absorbs any shock from the studio chair, but allows fingers to slip in and access the switches, if needed.

**R**emodeling studios can include furniture changes, too. But if you don't have the budget for wholesale studio furniture replacement, you might want to consider what Daniel Hyatt of Denver's Max Media did.

Taking a cue from the vinyl wrap we often see used on station vehicles, Daniel had his console furniture wrapped. Fig. 4 shows the results.

Speaking of furniture solutions, Eric Ostlund is assistant engineer for One Putt Broadcasting in Fresno, Calif. Eric recently completed a new facility build; when it came to studio furniture, Eric found that simple was better.

Since there's not as much equipment in today's AoIP studio, the simple curved tabletop, shown in Fig. 5, looks sleek and is supported by a brushed aluminum post.

(continued on page 14)

**YOUR ULTIMATE SUPPLY & SERVICE SOLUTION**

www.LightnerElectronics.com

**From our Facility to yours**      **Design & Integration**      **Repairs & On-Site Service Calls**

**LIGHTNER ELECTRONICS** www.lightnerelectronics.com  
Toll Free 1-866-239-3888 | Shop online www.broadcastavsales.com

THERE'S A NEW MEMBER TO THE AARON FAMILY

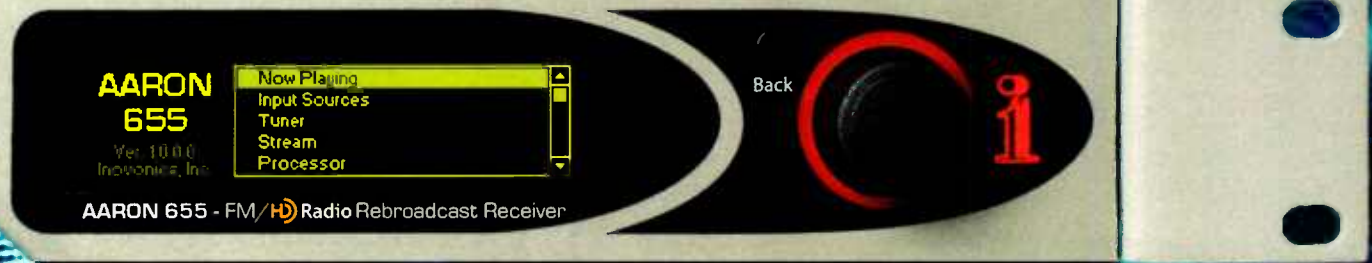

# INTRODUCING THE AARON 655 REBROADCAST/TRANSLATOR RECEIVER

The **AARON 655** is the first of its kind—combining an FM/HD Radio Receiver with an Audio Processor, Dynamic RDS Encoder, and IP-Streaming. With premium features and unparalleled performance, the AARON 655 excels in the most challenging reception conditions.

FEATURES

- ▶ Uncompromising DSP-based (SDR) receiver
- ▶ Program Sources: HD 1-8, FM, IP-streaming, Analog/AES Line Inputs
- ▶ RDS Encoder: Converts HD Pad Data, IP-Stream Meta Data or IP Telnet Data
- ▶ Audio Processor: Powerful 3-band, 10 factory resets, Dayparting
- ▶ No Dead Air: Assignable failover audio backup
- ▶ Dynamic Web Interface for remote control & monitoring
- ▶ Alarms & Notifications via email, SMS messages, SNMP support

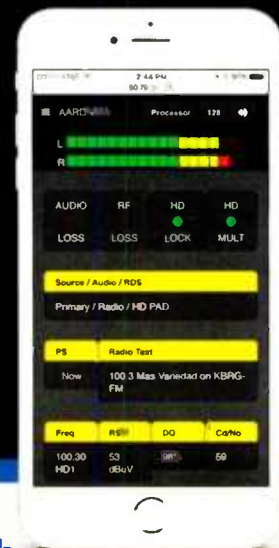

Join us at TAB 2017 - Austin, Aug. 9-10. See you at RF Specialties booth



[www.inovonicsbroadcast.com](http://www.inovonicsbroadcast.com) | [sales@inovonicsbroadcast.com](mailto:sales@inovonicsbroadcast.com) | tel: 831-458-0552

# TAB Event Attracts Beyond Lone Star State

Highlights include radio's foray into smart-home technology, regulatory changes and ever-present AM revitalization



Photos by Beth Bobbit

## REGIONAL EVENT

BY TOM VERNON

When it comes to over-the-top broadcast trade shows, the NAB's annual event in Las Vegas wins hands down. Conventional wisdom holds that if you can't find it at NAB Show, you're probably far better off without it. That said, some find the scale of the event to be a bit intimidating, and getting any amount of face time with the exhibitors can be difficult.

And that's where state and regional trade shows enter the picture. The smaller setting and relaxed atmosphere is more conducive to focus on the sessions and to find opportunities for complete conversations with the vendors.

It should be no surprise that the Texas Association of Broadcasters hosts the largest state broadcast association convention in the nation. RW spoke with TAB President Oscar Rodriguez about what to expect at this year's gathering.

According to Rodriguez, the event will host around 1,300 attendees, including station owners, managers, engineers and sales executives. He adds that there is a growing out-of-state contingent.

"We don't track numbers, but we're seeing a larger number of registra-

tions from outside Texas, particularly among engineers. Many are with groups who have stations in the state," said Rodriguez.

The one-and-a-half-day event will take place Aug. 9 and 10 at the Renaissance Austin Hotel, and will feature 40 sessions and 45 speakers divided among three tracks: engineering, management, and sales and marketing. "We pack a lot into a day and a half," said Rodriguez. "It's pretty intense and fast-paced, but people tend to enjoy it."

## WORKBENCH

(continued from page 12)

**R**ychard Withers is general manager for KFCF(FM), also in Fresno, Calif. "Free Speech Radio for Central California" depends on both listener contributions and community volunteers to generate 20 percent local programming. The station is involved heavily with the community, giving many on-air guests their first broadcast experience.

To improve microphone technique, Rychard ditched the typical mic stands and headphones and invested in the Audio-Technica combination headphone/boom mic, seen in Fig. 6.

Once on the guest's head, and after adjustment, it doesn't matter if the guest turns to speak to a host or another guest during a roundtable discussion — the adjustable boom ensures they are always "on mic."

Rychard also painted a small dot on the end of the boom mic, shown in Fig. 7, so operators can be sure the guest is speaking right into the element.

For more information, head to [www.audio-technica.com](http://www.audio-technica.com).

*Workbench* — Radio World's iconic and most popular column — relies on your good, practical ideas and those of your colleagues. Send in tips big or small; help your fellow engineers and qualify for SBE recertification credit. Email [johnpbisset@gmail.com](mailto:johnpbisset@gmail.com). You can even (gasp) fax them to (603) 472-4944. And discover a trove of past tips by clicking on the Columns & Views tab at [radioworld.com](http://radioworld.com), then choosing *Workbench*.

John is SBE-certified and is a past recipient of the SBE's Educator of the Year Award.

### SESSIONS

Among the sessions of interest to radio is "Putting Amazon's Alexa to Work for Your Station." Robert Meisse, president and general manager of Mid-State Multimedia Group in Mansfield, Ohio, will share his stations as a case study for employing Amazon's Echo and Alexa devices to serve viewers and listeners. Meisse will explain how to do



Wayne Pecena shares his IT knowledge during a 2016 session.

it, what it costs and how it's helping this local broadcaster bring their programming to the latest in-home and in-car media platforms.

"It's Your Turn Now: Radio's Transition to all Online Public File" will explain the steps that radio stations in markets 51+ need take to be ready for the new all-online era. The session will



### IF YOU GO

**What:** Texas Association of Broadcasters 64th Annual Convention & Trade Show

**Where:** Renaissance Austin Hotel

**When:** Aug. 9–10

**How:** [www.tab.org](http://www.tab.org)

**How Much:** \$115 for TAB members for full conference. See website for exhibits-only, educational and other packages.

be hosted by legal counsel Scott Flick.

Patrick McFadden, associate general counsel at the National Association of Broadcasters; Joe Seccia, manager of market and product development strategy for the TV transmission products at GatesAir; and Christine Zuba, national TV sales manager at Dielectric will co-host "Navigating the Spectrum Repack." Radio and TV stations alike must prepare for the biggest technical challenge of this century. This session will bring attendees up to speed on the

(continued on page 16)



Fig. 6: Eliminate the problem of guests sounding "off mike" by switching to a headphone/boom mic combination.

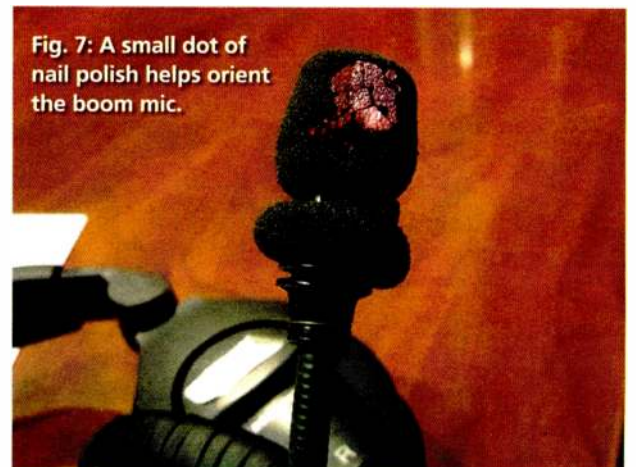

Fig. 7: A small dot of nail polish helps orient the boom mic.

**NXSeries**  
3 kW – 50 kW AM  
HD Radio  
Outstanding Control  
86-88% Efficiency  
Compact  
[nautel.com/NX](http://nautel.com/NX) nautel



# Leave Your Competitors in the Dust

Introducing VOLT, the hotrod new processor from Omnia that gives you more processing power and sonic performance in one rack unit than others give you in three. Sharing technological lineage with top-of-the-line Omnia products like the Omnia.11, VOLT drives you faster, with exciting sound that will take you from zero to 100 in seconds! In the race for electrifying, competitive, market-leading sound, VOLT puts the competition squarely in the rearview.

[TelosAlliance.com/VOLT](http://TelosAlliance.com/VOLT)



**TAB2017***(continued from page 14)*

latest in this still-unfolding plan, and what it means for coordinating with other stations, the wireless industry, vendors, engineers and, of course, securing federal reimbursements for related costs.

The session "Next Steps for AM Revitalization" will be led by Rick Greenhut and Gregg Skall. With initial work on AM revitalization already underway, learn what's next and what might be possible, from transferring AM daytimers to translators, to possibly going all-digital and beyond.

For sales executives, there's "Why do Clients Buy From Us?" Pat Bryson looks at the motivations buyers have for advertising on stations. This session examines the "buy cycle" of the buyer, as well as how to recognize what part of the cycle prospects are in, and how to move them through the marketing channel to reach a positive conclusion.

**ON THE FLOOR AND MORE**

The trade show portion of the event will include 124 vendors — read the full list in the sidebar.

The event will wind down with the awards gala, which includes presentations of Texas broadcasting's leadership honors.

"They have helped shape 21st Century Texas by practicing lifesaving journalism, holding public officials accountable, inspiring future leaders and enhancing the technology infrastructure that undergirds all that radio and TV stations do. Each has earned the respect and admiration of legions of fellow broadcasters, community leaders and everyday Texans," said Rodriguez.

Wendell Mayes, Jr. will be recognized with the association's Lifetime Achievement Award. Bob White of Corpus Christi has been chosen as the TAB Pioneer of the Year. Brian Purdy of CBS Radio Dallas has been selected as Broadcaster of the Year. Errol Coker of KHCB Radio Network was named George Marti Award for Engineering Excellence. Dan Sessler of RF Specialties was also tapped as Associate of the Year.

Rodriguez emphasizes the advantages a state show — like TAB's — has over larger conventions.

"Because this is a smaller event, there are greater opportunities for meaningful interactions with session presenters and vendors. We have organized the event so that the trade show is the central focus, and we try and make it easy for people to do everything that they need to. We also keep it affordable for members."

He adds that the member registration fee for the full conference is \$115; the early bird discount period closed in June.

A testament to the popularity of TAB's annual Convention and Trade Show comes from the many attendees, who have requested that a third day be added.

"It wasn't something we had been thinking about," said Rodriguez. "But now that the suggestion has been made, we'll be giving it serious consideration."



**Wendell Mayes Jr.**



**Brian Purdy**

**EXHIBITORS**

*These are TAB exhibitors as of press time; see on-site program materials for full final list.*

360 Systems Inc.  
Accelerated Media Technologies Inc.  
AccuWeather Inc.  
AJA Video Systems  
Alive Telecommunications Inc.  
Beck TV  
Bitcentral Inc.  
Broadcast Electronics / Commotion  
Broadcast Pix  
Broadcast Supply Worldwide (BSW)  
Broadcast Works  
Broadcasters General Store  
Burst Communications Inc.  
ChyronHego  
Cineo Lighting  
Cobalt Digital Inc.  
Comrex Corporation  
Continental Electronics Corporation  
Cool-Lux  
Dalet Digital Media Systems USA Inc.  
DeSisti Lighting



Dialight Corporation  
Dielectric LLC  
Digital Resources Inc.  
DoubleRadius Inc.  
DPA Microphones  
ENCO Systems  
ERI — Electronics Research Inc.  
Evertz  
Florical Systems  
FLUOTEC  
Frontline Communications  
Fujifilm North America Corporation,  
Optical Devices Division  
G&D North America Inc.  
GBS — Giesler Broadcasting Supply Inc.  
Grass Valley, a Belden Brand  
Harmonic Inc.  
Heartland Video Systems  
Hitachi Kokusai Electric Comark  
IHSE USA  
ikan Corporation  
Ikegami Electronics  
Imagine Communications  
IMT-Vislink  
JAMPRO Antennas Inc.  
JB&A  
Joseph Electronics  
JVCKENWOOD USA Corporation  
Lectrosnics, Inc.  
LiveU Inc.  
Lubbock Audio Visual Inc.  
Marshall Electronics



Show floor photos by Beth Bobbit

Middle Atlantic Products Inc.  
Miller Camera Support LLC  
Mobile Power  
Myat Inc.  
Nautel  
Nemal Electronics Intl. Inc.  
NVERZION  
Octopus Newsroom Americas Inc.  
Omega Broadcast Group  
Orbital Media Networks Inc. (OMNi)  
Osee Americas Ltd.  
Panasonic  
Pebble Broadcast Systems  
Persistent Systems LLC  
Precision Camera and Video  
Quantum  
RCS  
RF Specialties of Texas  
Riedel Communications Inc.  
Rio Steel & Tower Ltd.  
Rohde & Schwarz USA Inc.  
Ross Video Limited  
RTS Intercom Systems  
RUSHWORKS  
Sabre Industries  
SAM — Snell Advanced Media  
Satellite Engineering Group  
SCMS Inc.  
Sencore Inc.  
Shively Labs  
Slatercom-WCD  
Software Generation Limited  
Solid State Logic  
Sony Electronics Inc.  
SWIT Electronics USA LLC  
Telescript West Inc.  
Telestream  
Teradek 61  
Texas Media Systems  
Texas State Networks  
Tieline Technology  
TitanTV Inc  
TM Television  
Total Channel Media Inc.  
Triveni Digital Inc.  
TVU Networks  
Utah Scientific Inc.  
Vizrt Inc.  
Weather Metrics  
Wheatstone Corporation  
WideOrbit  
ZVS-Media LLC



# REAL. VIRTUAL. RADIO.



## ruby – the radio console with a whole new viewpoint.

Meet ruby, the new radio console from Lawo. So elegant and uncluttered, you might think something's missing — and you'd be right. We've moved most of the controls that litter the faces of other radio consoles onto an intuitive context-sensitive touchscreen, while essential controls like faders and monitor selectors are right where you'd expect them to be. ruby gives you the best of both worlds: familiar physical operations, and a modern graphical interface.



ruby's powerful visual interface is designed for fast-paced radio, with fingertip access to source, bus, and mix-minus assignments, as well as EQ and dynamics processing — freeing your talent to perform instead of searching for settings. You can even use ruby's GUI-building app to centralize control of studio software and peripherals. With intelligent AutoMix hands-free

mixing and one-touch AutoGain mic calibration, your operators will tackle the most complex shows with ease. Even voice-tracking while on the air takes only the push of a button. Be prepared: your talent may actually thank you! And because ruby is engineered and built in Germany, it might just be the last console you'll ever need to buy.

ruby, from Lawo. The console with a refreshingly new point of view.



Join us @ IBC, #8.B50

[www.lawo.com](http://www.lawo.com)



It's new equipment season again! Radio World's "Summer of Products" feature is all about new gear that has come onto the market in recent months, especially during spring convention season. Over several issues we are featuring equipment that caught our eye. Send ideas to radioworld@nbmedia.com with "Summer of Products" in the subject line.

## DEVA INTRODUCES DB4402 DUAL FM MONITORING RECEIVER

The new DB4402 dual FM monitoring receiver is based on a dual-FM tuner design to allow simultaneous monitoring of a single or round-robin multiple FM signals, while simultaneously looping back an uninterrupted audio stream from the station of choice.



The system is designed so that streaming and measurement activities do not interfere each other. While streaming back the received FM signal of choice, measurement and logging take place in the background. Users can set custom alarms for RF, MPX, pilot and RDS signals and receive warning messages via email, SMS or SNMP.

TCP/IP and GSM connectivity provides remote control, monitoring and listening to the radio signal from any location. DEVA says the DB4402 is DSP-based, with a built-in oscilloscope for left, right and MPX signals and an RDS/RBDS decoder with a BER meter. The DB4402 also features MPX power measurement with data history, RF spectrum analyzer to check the RF carrier parameters, and selectable de-emphasis (50µs or 75µs).

Info: [www.devabroadcast.com](http://www.devabroadcast.com)



on bandwidth, while facilitating content delivery within the group and increasing time-to-air ratios.

Info: [www.netia.com](http://www.netia.com)

## WAVEART FM TRANSMITTERS ARE UPGRADED

The WaveArt series of medium-power FM transmitters from Italy, ranging from 600 W to 3 kW output power, have been upgraded with a new generation of power semiconductors. This was done with the aim of ensuring a futureproof design and improving overall transmitter efficiency.

An embedded RDS encoder features a dynamic mode capable of retrieving RDS data from a satellite feed through the built-in satellite receiver. Models in the WaveArt product line



integrate a set of analog and digital input interfaces and feature DDS direct digital modulation and the capability to monitor the operating parameters continuously for predictive maintenance purposes. This means that each unit can recommend the proper actions required to extend lifespan. The company says customers complying with the preventive actions suggested by each unit are eligible to receive a free warranty extension up to five years.

Info: [www.waveart.it](http://www.waveart.it)

## NETIA OFFERS MULTIMEDIA HUB

Netia says its Media Assist software suite acts as a multimedia hub for content production and delivery in any format.

The cloud-ready system enables radio stations to deploy their back-office applications in a dedicated SAN or host them securely outside the station's premises. By offering safe access to outside entities, the station can exchange with its affiliates.

Now available for Media Assist is a monitoring tool that provides radio staff with a single interface for managing multisite workflows. The module allows staff to monitor priority levels on all launched processes to help minimize their impact

## ALTEROS DEBUTS WIRELESS MIC SYSTEM

Audio-Technica's Alteros wireless microphone system offshoot is launching an Ultra Wideband wireless mic system, the GTX series.



The GTX series operates in the license-free 6.5 GHz spectrum. It is planned to provide up to 24 channels of 24-bit/48 kHz digital audio. According to a release, the system is designed to minimize interference.

"The GTX Series operates far beyond the UHF and VHF television bands, requires no frequency coordination, license, database registration or STA, and does not cause interference or create intermodulation products. The system is ideal for studio-to-studio operation since it emits less intentional radiation than the typical PC and will not interfere with surrounding signals."

It debuts with the GTX3224 control unit, GTX24 bodypack transmitter and GTX32 transceiver.

"The unit features MADI, Dante and AES67 digital outputs that are all available simultaneously and allow for seamless integration with IP-based infrastructures. A single-mode fiber output supports long-distance runs."

A 7-inch front-panel touchscreen provides access to system settings, monitoring tools, performance reports and other controls.

Up to 32 transceivers can be connected to the controller via Cat-5 cable.

The controller has dual power supplies for redundancy and can be remotely operated.

Info: [www.alteros.tech](http://www.alteros.tech)



## NM-250 MKII - Newsroom Mixer

### Features:

- Built In Talkback System with 2 Send and Receives
- 1 Unbalanced Input /Output for computer Sound Card
- 1 Unbalanced Stereo Front Panel Jack Input
- 1 Balanced Mono Line Input for Telephone Hybrid
- 2 Balanced +4 dBm Stereo Line Inputs
- 2 Balanced Mono Mic Inputs
- Monitor Select (Mixer Output or Off Air)
- LED Meter Display
- Phantom Power Built In (48v)
- Built In Cue System with Dimming

**Dixon Systems**  
800-779-7575  
[www.ram68.com](http://www.ram68.com)

## ORBAN ROLLS OUT 5.1 SURROUND SOUND MONITOR

DaySequerra's acquisition of Orban began to bear fruit in the shape of a nifty rack-mounted headphone surround sound monitor for higher-end broadcast operators.

The iMix 5.1 Headphone Monitor features Orban's patent-pending DSX Headphone Surround algorithm. It utilizes the ITU-R BS.1770 loudness measurement system.

"Designed for accurate rendering of a discrete 5.1 soundstage in the users' headphones, the iMix 5.1



Monitor does not require artificial ambience or special encoding to accurately reproduce multichannel audio," a release explained.

"No proprietary surround encoding is required; test tone locations are rendered with precise image integrity, including BLITS tones and SWOOP tests without artificial ambience that masks the program audio."

Orban President David Day said the iMix 5.1

addresses the needs of the company's HDTV and radio broadcast customers for a 5.1 surround headphone monitor that will allow them to monitor and QC 5.1 broadcasts outside a specially-designed and expensive audio control room.

control room.

He added, "This robust, cost-effective solution allows users to work with their preferred type of headphones, achieving the sonic accuracy they need without special setup or calibration."

Basic I/O is AES digital audio with an options for HD/SDI inputs. Other options planned are AES67-Dante input and balanced analog I/O.

Info: [www.orban.com](http://www.orban.com)

## BURK UNVEILS CAPTURES CAPABILITY AND DIGITAL TEMPERATURE UNIT

Burk Technology is adding features to its remote control platforms.

A feature for the ARC Plus Touch (shown) and SL remote control systems is called Captures. It allows station engineers to track changes in critical site parameters over time. Sample rate and the



number of channels captured can be adjusted to tailor operations to meet a range of analysis needs. Captures can also be triggered by events, creating a record of site conditions at the time of occurrence. Captured values are directly stored on the ARC Plus and can be data can be accessed or downloaded through the AutoPilot software. Captures is standard on currently shipping ARC Plus Touch and SL units and is optional for v.5 models in the field.

Also new is the BTU-4D Digital Temperature Unit. The BTU-4D connects up to four digital temperature sensors to the ARC Plus or ARC Solo remote control system. The unit supports sensor cables up to 1,000 feet long. Line voltage telemetry is also built in. The digital temperature sensors available for use with the BTU-4D include general purpose, wall-mount, stack-mount and exterior installation. The sensors can also be used with Plus-X EM and Climate Guard Environmental Monitors.

Info: [www.burk.com](http://www.burk.com)

**ARRAKIS SYSTEMS INC.**

## 'ALL' Arrakis Consoles are now AoIP !!!

under \$1,000



ARC-15BP  
\$3,799\*



ARC-10BP  
\$2,599\*



ARC-8X  
\$849\*



**SIMPLE-IP**

DANTE enabled

Simple-IP is a one rack unit AoIP box using the world standard DANTE ethernet AoIP protocol. It is plug and play with CAT5e wiring to all Arrakis ARC or MARC series consoles. And Simple-IP isn't just a proprietary AoIP solution, it is plug and play with more than 600 products from over 200 other manufacturers from mics to speakers. For under \$1,000 per studio, you too can be AoIP from the world leader!

**Simple-IP solves wiring problems in old and new facilities alike !!!**

**Better by Design...**

\* Console list price... add Simple-IP for \$999 each

[www.arrakis-systems.com](http://www.arrakis-systems.com)

**970.461.0730**



## The Forever Console...Wheatstone LXE

Adapt to new technology, new techniques, and new workflows with LXE. Completely configure/reconfigure your console – every button, knob, and display on the surface is fully programmable using our intuitive ConsoleBuilder™ GUI/scripting interface.

With ScreenBuilder™ LXE, you can design dynamic custom touchscreen interfaces to augment LXE's extensive screen set. Beautiful to see and use.

Need more input faders? Enable up to four layers to double/triple/quadruple the number (up to 32) in the same footprint.

LXE is built to last in every way.

Learn more: [wheatstone.com/lxe](http://wheatstone.com/lxe)



 **Wheatstone**  
BROADCAST AUDIO PERFECTIONISTS®

## THE High Performance Standard for Radio Broadcast

What makes Wheatstone consoles best-of-class? Breakthrough technology with award winners like WheatNet-IP Intelligent Network with bus-minus\*. Unique design ingenuity. Precision production/starship-grade materials. Obsessive Wheatstone quality. FullTime support†. What does all that get YOU? Absolutely spoiled...



### LX-24 - This Really Changed Everything

THE standard in radio today. Exceptional console at every level. fully loaded and completely modular.



### L-8 & L-12 - Full-Featured, Smaller Size

Outstanding companions to the LXE and LX-24. Perfectly sized for newsrooms, etc.



### IP-12 & IP-16 - Best \$ Per Channel Ratio

Precisely designed and engineered for peak performance at mid-size stations.



### Intelligently Network Your Consoles

Each powerful BLADE-3 (point-of-use interface) contains a map of the entire WheatNet-IP Intelligent Network to route I/O, access sources, add processing, mix to/from any device. Plus routable logic, silence sensing, gain control, automated mixing, discovery/control, and much more. Format agile: MADI, AES/EBU, TDM, Analog, and AoIP. AES67 compatible.

Learn more: [wheatstone.com/consoles](http://wheatstone.com/consoles)



NEW!



## VoxPro Crushes It In The Ratings Thing

Getting rid of ALL your dead air makes better shows. Research shows that tighter programming dramatically retains listeners. Retained listeners = higher ratings. Download our free white paper, "The Business Case for VoxPro" at the link below.

### Speed To Air

VoxPro's software tools let you edit, remove silence, re-record your voice, add effects, and be ready to go...in seconds.

### Obsessive Organization

Hot buttons put a library of clips and tracks at your fingertips. Have your entire LIVE show programmed before you even start.

### Creative Controller

With VoxPro hardware, you control every aspect of the software. Designed and laid out for maximum speed and agility.

VOX 7 PRO

RECORD/EDIT/PLAYBACK AUDIO LIVE, IN REAL-TIME, ON THE AIR

Learn more: [voxpro.wheatstone.com](http://voxpro.wheatstone.com)

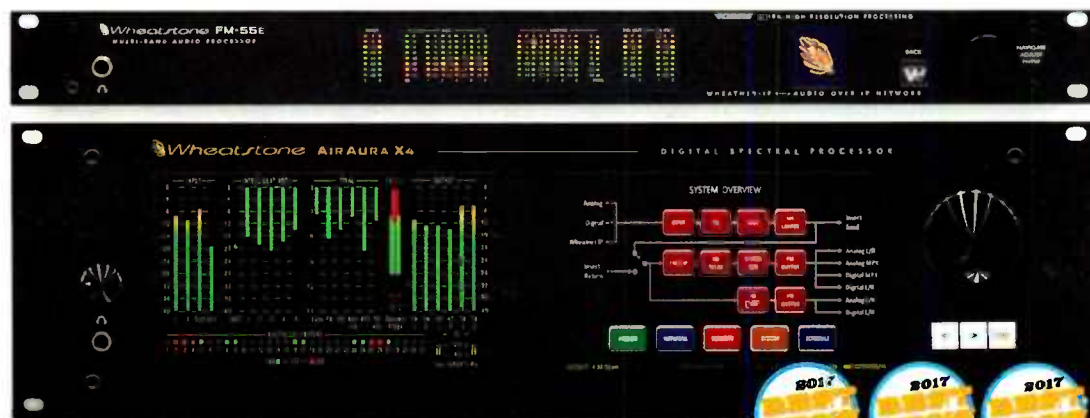

NEW!



## Bring Your Sound Into This Century with Phase Linear Audio Processing, RDS, & Built-In HD Time Alignment

Wheatstone crafts powerful, persuasive modern sound by developing integrated processing tools like: Mastering Limiters, Intelligent AGC, BassTools, Multipath Control, and Baseband 192 for the all-digital processor-to-transmitter chain. All algorithms share data interactively, constantly optimizing your settings for remarkable consistency, track after track. Our new flagship, the AirAura X4, has a built-in HD tuner for automatic Time Alignment as well as full RDS capabilities. New Phase Linear processing delivers detail and transparency unheard of in on-air processors. Brilliantly modern.

Learn more: [wheatstone.com/processing](http://wheatstone.com/processing)

\*Includes on-site commissioning, in-factory total system proof-of-performance testing, installation support, and real 24/7/365 service. We don't mess around.

Designed and built in the USA | Phone +1-252-638-7000 | [wheatstone.com](http://wheatstone.com) | [sales@wheatstone.com](mailto:sales@wheatstone.com)



## ERI HAS NEW AXIOMS

Antenna maker Electronics Research Inc. recently launched a new pair of Axiom antennas.

The Axiom is a side-mount master FM antenna utilizing the company's well-known Rototiller design. The two new models are the LPA and MPA (shown) series, with power ratings at 15 kW and 39 kW, respectively. They'll be available in 4-, 8-, 12- and 16-bay versions.

A release explains: "The Axiom is a specially designed antenna system which provides high input power handling capability and can provide service as an auxiliary master FM antenna

for systems that are limited to a band width requirement of up to 18 MHz of the FM Band (88 MHz to 108 MHz). The antenna can be designed with a single RF input or can be configured as separate upper and lower antennas for higher power handling capability and redundancy."

Info: [www.eriinc.com](http://www.eriinc.com)

## ORBITAL LAUNCHES OMNISTRREAMER

Orbital Media Networks, known for its satellite services, is branching out with an IP-based network delivery box, the OMNiStreamer.



According to Orbital it is a dual network-path HTTP Live Streaming and Real-time Transport Protocol audio appliance. Control and operation features include regionalized spot insertions, automation control relays, PAD Data pass-through, high-quality AAC audio, scheduled program playback, and local content layout.

In addition it offers balanced analog outputs, eight N.O. relays, serial and UDP delivery of program data. The company says that it has polished error correction schemes and path length accommodation algorithms to optimize the public internet/WAN or LAN performance of the box.

AES digital audio is an option.

Info: [www.orbitalmedianetworks.com](http://www.orbitalmedianetworks.com)



## OMNIA ELECTRIFIES WITH VOLT

Omnia Audio has rolled out Volt, a processor in one rack unit that the company says shares technological lineage with its top-of-the-line products like the Omnia.11.

The Volt features a clipper designed by founder Frank Foti and dynamics from processing algorithm guru Cornelius Gould. There are six separate AGC sections (one wide-band, five multiband); five time-aligned limiter sections; deep bass, warmth and stereo enhancers.

Omnia says that its QuickTweak function will take away much of the mystery of mastering a processor and provide simpler adjustments and settings that are also pleasing. In addition, the Volt is multifaceted, able to handle AM, FM and HD Radio/DRM duties.

Info: [www.telosalliance.com](http://www.telosalliance.com)

## MAGIX RELEASES SOUND FORGE PRO MAC 3

For Sound Forge DAW users who may have felt abandoned, Magix promises that you are not forgotten.

Magix purchased the Sonic Foundry properties from Sony last year. First out of the chute is an upgrade of the Mac version. New tools in Sound Forge Pro Mac 3 include loudness metering, iZotope Plug-ins RX Elements and Ozone 7 Elements. Magix lists SF Pro Mac 3 as native 64-bit, 32-channel, 24-bit/192 kHz and Red Book-qualified.

Also expected this summer is a new 64-bit Windows versions of the platform. Magix's Gary Rebholz said that developer teams in Madison, Wis. (where the old Sonic Foundry was based) and Berlin were working on the new iterations, including a Sound Forge Pro 12.

Info: [www.magix-audio.com](http://www.magix-audio.com)

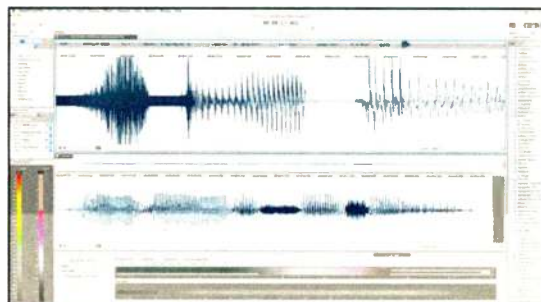

## AUDINATE ON BROADWAY

Dante IP technology specialist Audinate has a new chip available for original equipment makers into IP or looking into networking their audio equipment via IP.

The Broadway chip handles 16 I/O channels of up to 96 kHz audio, with latency as low as 0.25 ms and Gigabit Ethernet. Interface options include SPI, UART and GPIO interfaces.

The company says the chip is aimed at "mid-tier" equipment such as multi-channel amplifiers, smaller DSP sections, hardware interfaces, compact mixing consoles and conferencing systems.

According to Audinate, Broadway has "significant performance enhancements over the low channel-count Dante Ultimo solution."

Info: [www.audinate.com](http://www.audinate.com)



## STREAMGUYS DELIVERS PODCASTING SAAS SERVICE

StreamGuys is launching a service to turn video into an audio podcast. The cloud-based SGrecast live streaming repurposing platform adds to its audio podcast recording capabilities by enabling broadcasters and video professionals to automatically transform live, linear video streams into podcasts and side channels.



SGrecast uses StreamGuys' transcoding technology to automatically convert audio to the formats and bitrates appropriate for use in live syndication; it also has a new recording mechanism to record audio streams in their native format. The transcoding technology can also be applied to video for live syndication and is capable of recording live RTMP, RTSP and HLS streams for conversion to MP4 files. In addition, the system offers a suite of scheduling tools that enable unattended operation, while integrated publishing to RSS feeds, automated delivery and compatibility with syndication services are also available.

Additional features of the SGrecast for audio include rebroadcasting tools and social media integration. These capabilities are expected to be included in the video application in the future.

Info: [www.streamguys.com](http://www.streamguys.com)

# HIGH CAPACITY EVENT STUDIO TRANSMITTER LINKS

outdoor unit

## TAKE ADVANTAGE OF WIRELESS HIGH PAYLOAD STL/TSL CAPACITY

Moseley EVENT STL/TSL systems provide up to 155 Mbps combined IP, T1/E1 payloads. Multi-station clusters can convey multiple linear uncompressed audio pairs for a truly cost-effective STL/TSL link. Connect your existing T1/IP audio hardware directly into the EVENT system, or use Moseley Rincon for your audio payloads. An optional DVB-ASI module is available for full duplex video.

EVENT systems are fully bi-directional including a Software Defined Indoor Unit (SDIDU) and Outdoor Unit (ODU), eliminating the need for costly waveguide hardware. The ODU is available in the license free 5.8 GHz band, or licensed 11, 18, or 23 GHz bands. Appropriate external antennas are selected based on path length.

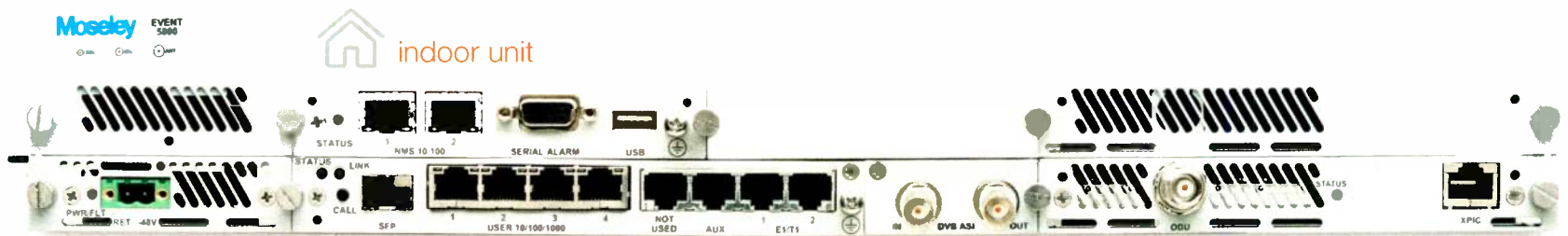

indoor unit

## INTELLIGENT SYSTEM DESIGN

Spectrum-scalable digital radios with user-selectable data rates enable broadcasters to have greater flexibility in STL planning and future growth. The integrated T1/E1 and Ethernet interfaces allow for a combination of T1/E1 and IP packet data.

### IP APPLIANCES AND APPLICATIONS

Offer IP transmitter control, surveillance security, and site monitoring to reduce downtime, and protect valuable station assets while saving travel time to the site.

### REMOTE MIRRORED SERVERS

From the transmitter site, offers backup of business records and programming content to get you back on the air quickly in the event of a studio outage.

### EMAIL AND INTERNET ACCESS FROM THE TRANSMITTER SITE

Saves engineers time accessing manuals or technical support from manufacturers during maintenance sessions.

### SIMPLE NETWORK MANAGEMENT PROTOCOL (SNMP)

Full SNMP package with GUI provides easy monitoring and configuration changes.

Contact The Moseley Sales Team to Custom Configure Your EVENT STL/TSL Today!

[moseleysb.com](http://moseleysb.com)

## WHEATSTONE REVS AOIP WITH DMX

Wheatstone wasted no time this spring getting a new PR&E product out after acquisition of the brand from GatesAir.

The DMX, shades of PR&E's BMX and RMX lines, is dedicated to IP technology. It does not require an external Ethernet switch since a Gigabit Ethernet network card is built in.

Eight-fader and 16-fader models are available. A 1RU rackmounted I/O box is part of the system.

Features include talkback and cue functions, EQ and dynamics, LED meters, timer along with control room, studio and headphone monitoring. Each channel strip has pan, mode and input control knobs.

Wheatstone Director of Sales Jay Tyler called it "an ideal setup for the two- or three-studio facility where each studio can act independently as a separate standalone entity, but the studios are linked together through an IP network."

Info: [www.wheatstone.com](http://www.wheatstone.com)



## DIELECTRIC CROSS-COUPLES FILTERS

Building on its product introductions over the last year, Dielectric announced the addition of cross-couplings to its FM combiner filters.

Dielectric explains that the couplings allow "less frequency separation for combined channels. Since fewer cavities are used, efficiency is improved and operational costs are reduced."

Senior Engineer Derek Small said, "Higher-order filters have been required for channel combiners and IM reduction due to the crowded FM spectrum, and have a tendency to reduce efficiency ... Higher-order filters with large amplitude rolloff and delay can add asynchronous AM, and reduce stereo separation in the FM signal. From a classic design standpoint, the use of constant-impedance FM combiners means twice as many filters and components and raise both initial and operational costs.

"Our new cross-coupled designs tackle these problems with much less complex architecture in shared FM facilities."

Info: [www.dielectric.com](http://www.dielectric.com)



## DAC SYSTEM OFFERS TOWER MONITORING SOLUTIONS

Switzerland-based DAC System rolled out the latest version of its DAC Monitoring System, v1.3.

The system is designed to monitor radio frequency signals at an antenna input and at the power splitter/divider used for distribution.

As part of this update, v1.3 offers support for new products and a number of new key features, enhancing the DAC Monitoring System for indoor applications.

Among the new supported products for v1.3 are the indoor RF detector, a temperature detector for indoor application and the Indoor Junction Box 4.x, which connects sensors, temperature and RF detectors.

The version also offers support for the outdoor/indoor sensor in the sizes of 3-1/8 inches, 4-1/2 inches and 6-1/8 inches.

New features for the updated system include support for SNMP v2c and v3; enhanced alarm and system monitoring; support for Wi-Fi/WLAN hot spot functionality; a "Maintenance Mode" that suspends alarm forwarding; and the ability to scale the system from zero to 250 monitoring points per data logger.

The DAC v1.3 of its monitoring system is available now.

Info: [www.dacsystem.ch](http://www.dacsystem.ch)

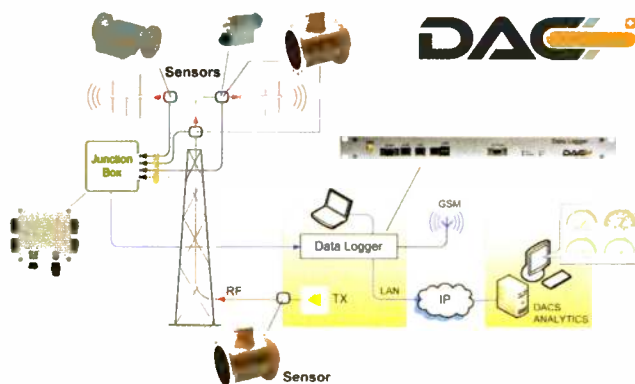

## DIGITAL ALERT SYSTEMS UPGRADES ONE-NET & DASDEC

Monroe Electronics and its Digital Alert Systems subsidiary have issued a software upgrade to the One-Net and DASDEC platforms for advanced Emergency Alert Systems and Common Alerting Protocol messaging compliance. The new Version 3.1 of the One-Net and DASDEC platforms provides the latest compliance mandates, operational improvements and security features.



A new feature is MPEG-DASH message payout. Customers can add MPEG-DASH to One-Net SE and DASDEC-II devices. In addition, the internal MPEG-2 encoder now includes an option switch to provide a constant stream to maintain continuity with downstream encoders and other devices.

The upgrade features an update for emergency alert authentication to address changes made by U.S. and Canadian authorities. This includes the latest FEMA IPAWS and Pelmorex NAAD digital certificates, which are required to ensure proper validation and authentication of emergency alert messages.

More features that make up Version 3.1 include a selector to normalize radio and CAP alert audio output levels; an upgraded Alert Agent with improved handling of rare alert cases; enhancement to the network settings; an addition of a RSYSLOG function; and support for the new upgrades to Custom Message Pro.

Previous users of Version 3.0 will be able to upgrade to Version 3.1 for free. Customers upgrading from older versions will need to purchase a Version 3.0 enabling key before installing Version 3.1.

Info: [www.digitalalertsistemas.com](http://www.digitalalertsistemas.com)



## NEUTRIK CLEANS UP

It might seem surprising, but cleaning and inspecting fiber-optic connectors can be difficult. Contrary to first impulse, they should not be wiped with a cloth, clothing, paper towel or air blaster, according to manufacturer Neutrik; such materials can scratch or leave lint, the smallest of which can wreak havoc with a cable's performance or damage the connector.

To bring proper fiber-optic inspection and cleaning techniques to the public as the cable becomes common within broadcast facilities, Neutrik said, it has created a set of cleaning accessories for its opticalCon Advanced high-performance cables. These connector-like attachments hold the shutter open, allowing for the use of professional optical connector cleaners. This alleviated the need to jiggle the shutter open or remove it to get at the ferrules.

Neutrik USA President Peter Milbery stated, "For anyone using fiber optic cables outfitted with Neutrik's opticalCON Advanced cable connectors, these new cleaning tools are an invaluable accessory."

Info: [www.neutrik.us](http://www.neutrik.us)



# SUMMERTIME SPECIAL



**Flexiva 3kW (analog power) solid-state FM transmitter with Flexiva Integrated FM Exciter**

Designed for low- and high-power requirements, up to 40 kW, Flexiva has the most compact design on the market today. Flexiva takes FM transmission to the next level.

- Power levels up to 3850 W Analog FM, 3100 W FM+HD
- Broadband, frequency agile design 87.5 to 108 MHz needs no tuning or adjustments
- Best-in-class power efficiency for lowest operating costs
- Compact, space-saving, 2, 3 or 4RU design
- State-of-the-art, direct-to-carrier digital modulator
- Operation at up to 1.5:1 VSWR with proportional foldback
- Full remote control capability

### The Burk ARC Solo and Autopilot

The all-in-one remote control, brings you powerful features like Jet™ Active Flowcharts, smartphone control, custom email templates and the Recordable Speech Interface. All the I/O is conveniently located on the rear panel, with connections for up to 16 status, meter and control channels. Add AutoPilot and your remote sites come to life with customized graphical views, automated logging and scheduled reports that take the drudgery out of FCC compliance.



**Package includes the Burk Arc Solo and Autopilot with the GatesAir FAX3kINT for one hot price!**

**\$16,990.\***

regular price for this package is \$36,990.

\* Offer available till August 30th

Another great deal from SCMS!  
**call 1-800-438-6040**  
[www.scmsinc.com](http://www.scmsinc.com)



<b>Latin America</b> 760-650-1427	<b>Western Mountain States</b> 303-674-6566	<b>West Coast</b> 818-398-7314	<b>Central</b> 315-623-7655	<b>North Central</b> 573-478-3737	<b>Southern Gulf</b> 866-205-6905	<b>Mid-West</b> 844-436-4327	<b>North-East</b> 315-623-7655	<b>Mid-South</b> 877-391-2650	<b>Pro Audio/South-East</b> 877-640-8205	<b>Bradley Division</b> 800-732-7665
--------------------------------------	--	-----------------------------------	--------------------------------	--------------------------------------	--------------------------------------	---------------------------------	-----------------------------------	----------------------------------	---	---

# Comrex Keeps on Working for VPR

BRIC-Links keep all 14 of Vermont Public Radio's transmitters on 24/7

## USERREPORT

BY FRANK ALWINE  
Broadcast Engineer  
Vermont Public Radio

COLCHESTER, Vt. — Vermont Public Radio is Vermont's NPR station. We supply local programming and news across the state of Vermont. I've been a broadcast engineer at VPR for two years now, focused on the studio engineering side of things. I'm responsible for everything in the path from the microphone to the STL that delivers our programming. It's my job to oversee the broadcast chain at the main studio in Colchester, along with our outlying satellite studios in Norwich and Montpelier.

My predecessor installed and designed our current STL setup in 2010, and I inherited it when I took over the job. VPR has 14 full-powered transmitters, used by two networks (VPR News and VPR Classical), and we have more than 30 Comrex BRIC-Links handling all of our STLs.

For our network, we use private ELAN from our local internet provider, Fairpoint. It's a 40 Mbps-outgoing connection here at the studio, and then each transmitter site gets a 3 Mbps bidirectional link. For all of those connections, we use the BRIC-Link. We also use a backhaul on our BRIC-Links, to transmit an off-air back feed.

For confidence monitoring, we have a profiler system that lets us record our programming. This feed is sent back to the studio over the BRIC-Link in a lower quality stream. It

enables us to get actual audio back to the sites, and gives us some confidence. We use the AAC Stereo D8 codec to transmit from the studio to the transmitter, and for our return feed, we use the HE-AAC v2 codec. It works beautifully.

Talking with my colleagues before writing this story, we were at a loss as to what we should say. It's kind of boring — our BRIC-Links simply work, and that's pretty much all there is to it.

But as I was thinking about it, I realized that's the best endorsement I could give. I don't have to worry about these things — they just plain work all the time. Once or twice a year we'll have to disconnect one and reconnect it, but since we purchased them in 2010, not a single unit has failed. That means 24/7, every single day, for the past seven years, these units have just been working. From a broadcast engineer's standpoint, you can't get much better than that.

For information, contact Chris Crump at Comrex in Massachusetts at (978) 784-1776 or visit [www.comrex.com](http://www.comrex.com).



## ABOUT BUYER'S GUIDE

Radio World publishes User Reports on products in various equipment classes throughout the year to help potential buyers understand why colleagues chose the equipment they did. A User Report is an unpaid testimonial by a user who has already purchased the gear. A Radio World Product Evaluation, by contrast, is a freelance article by a paid reviewer who typically receives a demo loaner. Do you have a story to tell? Write to [bmoss@nbmedia.com](mailto:bmoss@nbmedia.com).

# DEVA<sup>®</sup>

BROADCAST

Available in stock from  
Broadcast Depot, Call: 800-313-7592  
[www.devabroadcast.com](http://www.devabroadcast.com)



POWER FM 91.10  
PTA TODAY'S BEST MUSIC  
91.10MHz 95.70MHz 99.90MHz 105.90MHz

DEVA<sup>®</sup>  
BROADCAST  
MODEL DB4004

Price: \$3200



U7: Rock  
Input Process Output Presets

DEVA<sup>®</sup>  
BROADCAST  
MODEL DB6400

Price: \$2450



POWER FM 91.10  
PTA POWER FM - TODAY'S BEST MUS  
91.10MHz 95.70MHz 99.90MHz 105.90MHz

DEVA<sup>®</sup>  
BROADCAST  
MODEL DB7007

Price: \$2350

**TECHUPDATES**

**AETA μSCOOP FACILITATES STL TASKS**

AETA's μScoop full-duplex IP audio codec, available with analog or digital input/outputs, is designed to utilize IP connections over wired IP networks.



According to the company, μScoop offers many advantages to ensure a permanent link between two codecs.

Transmission is ensured by two types of packet duplication functions, which AETA calls an exclusive. This makes it possible to improve the resistance to packet losses, and thus increasing connection reliability.

The auto redial feature lets users configure the number of redial attempts in case of a connection loss along with the waiting time before each attempt. If the link is dropped, the codec relaunches the call and sets the link up again. This feature is also effective in case of a power failure with μScoop recalling the remote unit as soon as it restarts.

In addition, μScoop features multicast transmission; Ethernet remote control from its embedded HTML server; configurable status and control relays (GPIO) that inform users when the remote μScoop is synchronized; a choice of encoding algorithms including Opus and MPEG AAC; and SIP or direct RTP modes.

For information, contact AETA Audio in France at +33-1-41-36-12-01 or visit [www.aeta-audio.com](http://www.aeta-audio.com).

**APT IP CODECS ADD FEATURES**

WorldCast Systems says the latest release in its IP audio codec line features scalable MPX transmission, new NTP alignment and support for Dante, the multichannel digital media networking technology.

The APT IP Codec range consists of the stereo IP Audio Codec and the Multichannel IP Audio Codec, which transports multiple channels of audio or MPX content over IP links. Systems are DSP-based and feature SureStream technology for AoIP over public internet connections.



A new multichannel I/O board on the slimline APT Multichannel AoIP Codec offers users the ability to connect from the codec to a Dante or an AES67 network. This enables the codec to become integrated into in-house network ecosystem, which the company says ensures interoperability with near-zero latency and synchronization.

Also new in the APT Codec range is the NTP time-alignment feature, which enables latency control when distributing programming across multiple decoders. Suitable for multiple-frequency networks, NTP timing ensures playout alignment on each decoder with constant link latencies.

Last, the MPX capabilities of APT codecs have been enhanced with the launch of a new limited MPX transmission mode. In addition to the 192 kHz sampling rate, which enables transmission of the full MPX spectrum, APT codecs support 128 kHz sampling, transmitting the audio and RDS signals but limiting the MPX bandwidth to 64 kHz. This bandwidth limitation saves network capacity, reducing the requirement of 3.2 Mbps for 16-bit audio at 192 kHz to just 2.048 kbps at 128 kHz.

For information, contact APT/WorldCast Systems in Florida at (305) 249-3110 or visit [www.worldcastsystems.com](http://www.worldcastsystems.com).

**From analog FM to best-in-class HD Radio on your schedule and budget**

**Flexiva™ Gen4 Engine HD Radio Solution**

- High-efficiency transmitters with industry-leading performance, compliance
- End-to-end management for multichannel program transport and delivery
- Industry's most advanced quality and diagnostics with robust Flexiva exciters

Transition to superior digital with exceptional ease and affordability

**95 YEARS**  
**GATESAIR**  
Since 1922

Connecting What's Next  
[www.gatesair.com](http://www.gatesair.com)

**ib 2017**  
**Stand 8.C30**

# Channel 4 and Telos Team Up

## Z/IP One takes part in world's longest underwater broadcast

### USERREPORT

BY MUHAMMED RAFAQE  
Channel 4 FM Dubai

**DUBAI, UNITED ARAB EMIRATES** — One of the greatest things about being in radio is that you occasionally have a chance to be involved in some unique broadcasts. While some broadcasts are unique for the events they cover, others are so memorable that the broadcasters themselves become the story.

Such was the case recently with our crew at Channel 4 FM in Dubai, when the marketing team thought it might be fun to do a live 5- to 10-minute broadcast segment from the Ambassador's Lagoon outside the iconic Atlantis the Palm Resort. This was to be more or less as a publicity stunt to promote the exotic location. We're not talking poolside, mind you, but broadcasting from within the pool — an underwater broadcast from a pool that hosts a variety of sea life.

#### UNDERWATER

This might have been interesting enough, though such an aquatic broadcast had been done before. Our plan soon evolved into something much more when our Station Producer Lucas Poole suggested that Stu Tolan, host of the "Celebrate Mornings" breakfast show, not only broadcast underwater but attempt to break the record for longest underwater broadcast.

We then learned that this would mean staying on-air and underwater for

nearly five hours — no small amount of time to broadcast live while wearing scuba gear. Our team was up for the challenge and preparations began to break the record.

One question on all of our minds was if the tech could hold up for such a stunt. There were a number of challenges ahead of us, and the engineering team initially didn't feel prepared for the record-breaking broadcast.

We were informed that one of the requirements to set the record was that the broadcast crew could not disconnect from the studio for more than two minutes, so we would need to ensure a stable link from the site of the broadcast to the main broadcast studio at all times. In addition, the broadcast hosts would

need to remain in communication with a representative from the Guinness Book of World Records.

These requirements presented some challenges for our technical crew to ensure these lines of communication would remain stable throughout the broadcast, and that any delays in communications or getting callers on the air would be minimal.

Complicating things, the resort could not provide a stable internet connection because it is reserved for guests, so the only access would be via cables. As such,



Stu Tolan



The equipment rack with the Telos Z/IP One in the center.

a good bit of equipment would need to be hauled to the broadcast site so everything would be at the ready.

As a solution, we used a router that connected to a Telos Z/IP One IP audio codec, and then to the main broadcast studio. The studio features 100 percent Livewire infrastructure, so getting the audio feed into the studio would be easy using the Z/IP One, especially with sufficient backups. We assigned two Z/IP Ones to the studio, so if one failed, the second one would take over and the broadcast could remain live. For this broadcast it was all about convenience, quality and low latency — Livewire fit the bill perfectly for that.

All the coordination paid off, and on May 13, Stu and the Channel 4 "Celebrate Mornings" went live from underwater. Everything went smoothly, and various guests joined our team underwater during the show including news reporters and our own program director, while our co-presenter presented poolside throughout the event. With the help of the engineering staff and the marketing team, the broadcast came off without a hitch.

In the end, the record was not only broken but shattered; the broadcast went well beyond the five-hour mark, giving future underwater broadcast hopefuls a high bar to shoot for. It certainly wasn't your everyday broadcast, but at a place like Atlantis the Palm, "A World Away from the Everyday" is the norm.

We have more pictures of our record-breaking event at our website — [www.channel4fm.com](http://www.channel4fm.com).

For information, contact Cam Eicher at Telos in Ohio at (216) 241-7225 or visit [www.telsoalliance.com](http://www.telsoalliance.com).

### TECHUPDATE

#### DAWNCO OFFERS NEW FOUR-PETAL DISH

Dawnco is offering a new four-petal design for its 3.7-meter/12-foot satellite antenna. The company says that this offers advantages in performance and cost, plus it's easier to ship and install than the older one-piece design.

The dish uses aluminum that is twice as thick as competitors, the company says. It is spun into a reflector shape, and then cut into four petals. The machined reflector edge support beams are bonded to the edges of all four reflector petals, creating an accurate 2-degree spacing-compliant dish shape. The assembled four-petal reflector is mounted onto a strong steel back structure, on a steel mounting post.

Petals can be lifted by one person, and the four petals can be lifted one-at-a-time onto the mount for an easy two-man installation process.

Dawnco's reflector blocks adjacent satellite interference when receiving programs from the new AMC18 satellite, and prevents the drop-outs and distortions that plague users of old imprecise dishes. Radio networks on AMC18 are recommending our 2-degree-compliant 3.7-meter dish size.

The four-petal 3.7-meter dish has been priced low, and the crated design can be shipped quickly using economical common carrier trucking. In the last few months, over 200 stations have purchased Dawnco's four-petal aluminum 3.7-meter satellite antennas to replace their older small-sized dishes.

For information, contact Dawnco in Michigan at (248) 391-9200 or visit [www.DAWNco.com](http://www.DAWNco.com).

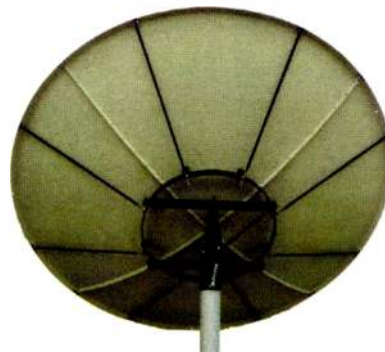

# BBN Spreads Message With GatesAir

Bible Broadcasting uses Intraplex IP Link 100 for radio network distribution



## USERREPORT

BY ROY BECKER  
Senior Engineer  
Bible Broadcasting Network

CHARLOTTE, N.C. — Bible Broadcasting Network grew from a single station that we owned and operated in Norfolk, Va., to our present-day network, which consists of 45 full-class radio sta-

tions and 90 translators in 31 states and Bermuda.

Using this 24/7 radio network infrastructure, we're able to reach a potential audience of about 50 million people with our program mix of Bible programs and Christian music. We also reach a worldwide audience by streaming media in eight languages over the internet to mobile and other connected devices.

With respect to radio distribution, we deliver our program signal — as well as

the commands for transmitting relay closures for PSAs and IDs — to the vast majority of our stations via a Galaxy 16 satellite transponder.

However, about four years ago, we found one of our radio stations couldn't be reached effectively via satellite due to interference caused by our transmitter.

### IP DISTRIBUTION

Since we couldn't reach that station via satellite, and our internet bandwidth

at our Charlotte, N.C., network operations center is plentiful, we decided to deliver the audio stream over IP to just that one station. To do this, we installed a GatesAir Intraplex IP Link 100 network, with an encoder/decoder box in our main server room and a similar unit deployed at the receiving station.

Intraplex audio codecs give radio broadcasters an array of audio coding options for sending signals over studio-to-transmitter links using IP. While Intraplex is bidirectional, our encoder/decoder "send" box multicasts the audio as two identical HE-AAC v2 compressed streams to the receiving site for redundancy.

We later consolidated our studio and transmitter facilities where there was not sufficient space to accommodate a satellite dish. Then we acquired yet another station where our satellite signal was adversely affected by too much external interference. Since satellite delivery was not an option for these stations, we deployed additional Intraplex IP 100 units to those locations and added them to our Intraplex audio over IP network.

I can monitor all of the Intraplex sites, including the home base and field units, remotely using a web browser. In fact, once they're installed in the rack,

*(continued on page 31)*

# got all these features in your DA?

The **NEW**  
Radio Systems ADA-2X8SS

**2 STUDIO Stereo INPUTS** to eight **isolated OUTPUTS**

with **Front Panel VU METERS**, **Headphone AMP** and **sets**

plus **Silence SENSE** with **EMERGENCY Switch-Over**, **Remote Control**

and full **Studio Hub + Connectivity.**

**radio SYSTEMS**  
ADA-2x8SS

**radio SYSTEMS**

601 Heron Drive • Logan Township, NJ 08085 • (856) 467-8000 phone • (856) 467-3044 fax • www.radiosystems.com

# Barix Delivers for New World Radio Group

Simplicity and savings sell multicultural broadcaster

## USERREPORT

BY BRIAN C. EDWARDS  
Vice President  
New World Radio Group

**WASHINGTON** — New World Radio Group has been broadcasting international radio content since 1992, and now it encompasses a trio of stations: WNWR(AM)/1540 in Philadelphia, WCRW(AM)/1190 in Leesburg, Va., and our flagship station, WUST(AM)/1120 in Washington. WUST is known as “the multicultural voice of the nation’s capital,” providing foreign language and English programming to the region’s diverse ethnic communities.

I’ve been a fan of audio over IP for years now, and moved our infrastructure away from traditional telco solutions. With the bandwidth available today, moving to IP just made total sense, as it offers greater scalability and virtually unlimited flexibility. We want to stay on the forefront of technology, and for our paying clients who are supplying programs, we want to get their audio into our studios at the best possible quality.

We chose Barix audio over IP devices, which are distributed in the U.S. by LineQ, to connect our stations and our remote contributors. We were attracted to Barix because of how much functionality their products offer at a cost-effective price point. Beyond affordable pricing for the equipment itself, our IP-based links provide ongoing cost savings versus alternative distribution methods.

The primary application for our Barix units is enabling our client programmers to do remote shows from their own studios, while delivering studio-quality audio into our stations. With numerous Barix units deployed across multiple clients, the cost savings are amplified. We use additional Barix units as backup studio-transmitter links to our transmitter sites, and to backhaul satellite audio inexpensively from WUST to our other two stations. In this latter case alone, we realize big cost savings by not needing an expensive satellite installation at

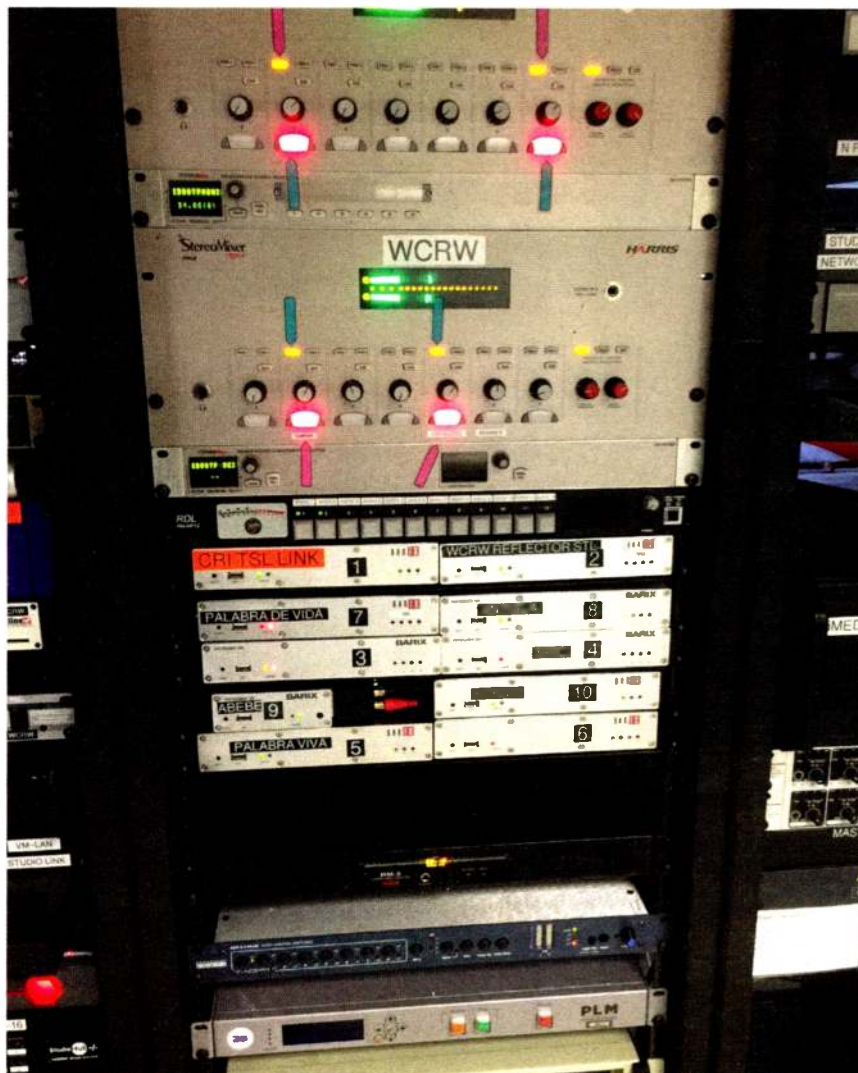

each location.

We use a Barix Instreamer at WUST to encode audio for distribution to our other sites, and Barix Exstreamer 500s to receive and decode the resulting IP audio streams. For connecting clients’ remote studios, we use Exstreamer 500s at both ends. We chose the Exstreamer 500 because it’s a broadcast-grade model with balanced audio inputs and outputs, which is important given some of the environments we’re installing them in such as transmitter sites. We also have a handful of Exstreamer 1000s for deployments that require AES/EBU digital audio.

The Exstreamer 500 and 1000 are versatile, able to function as either encoders or decoders. That flexibility comes in handy when we get new program producers, as I can grab a Barix unit off the shelf to supply to the client without worrying about its specific capabilities.

Security is crucial to us, and again, Barix gives us the tools we need. There has been lots of press attention given to hacked radio stations in recent months, but they all shared a common fault — the users had never configured a password on the STL devices. The Barix units do offer security; you just need to use it, which is easy. It takes literally five seconds to set up a password and secure the device.

While the Exstreamer units could be connected point-to-point with static IP addresses, I use the cloud-based Reflector service — offered by Barix in partnership with streaming specialists StreamGuys — for almost all our Barix-driven links. The Reflector ser-

(continued on page 32)

## TECHUPDATE

### DIGIGRAM IQOYA \*SERV/LINK SERVES NATIONAL BROADCASTER

Digigram reports that at a single national master control room an Iqoya \*Serv/Link decodes, transcodes and routes all incoming regional streams for in-house use (MAM, production, logging, etc.), for distribution to transmitters and to web radio CDNs. All the ingested metadata remains unchanged throughout the network.

The Iqoya \*Serv/Link incorporates multiple distribution codec instances and the company’s FluidIP technology on one hardware-based processing platform to simplify transport of multiple audio programs over IP networks in a high-density format.

Designed for radio broadcasting and for intercom and commentary for radio or TV, the Iqoya \*Serv/Link codec allows users to configure multiple-stereo or multichannel solutions for studio-to-transmitter links, studios-to-studio links, DVB operators, or content delivery networks.

In its compact 1 RU version, the solution can handle up to eight stereo analog channels, or 16 stereo AES/EBU channels, or 64 stereo MADI channels and/or 64 stereo

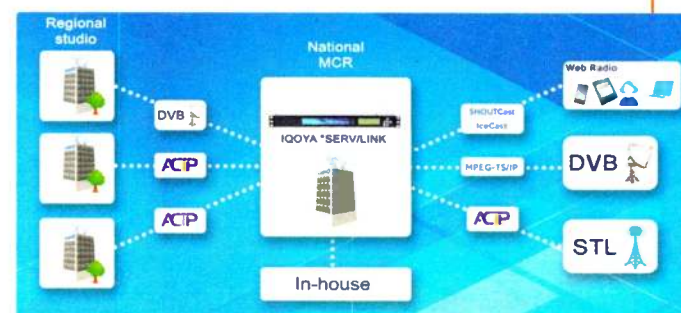

AES67/Ravenna IP channels, and up to 64 stereo codecs instances with multiple GPIOs and RS-232 ports for auxiliary data tunneling. The scalability of the system allows users to expand the supported audio I/Os, and a larger 4 RU version provides higher channel density.

The solution supports multiple audio codecs (PCM, MPEG Layer II and Layer III, AAC, Opus, and aptX Enhanced), and the company says it is one of the few audio over IP codecs that can simultaneously stream raw RTP, HTTP and MPEG-TS/IP streams.

For information, contact Digigram/Point Source Audio in California at (415) 226-1122 or visit [www.point-sourceaudio.com](http://www.point-sourceaudio.com) or [www.digigram.com](http://www.digigram.com).

**7,000+ AUI Tx Installed**

**AVOID TRIPS  
SAVE TIME  
SAVE MONEY**

**nautel**  
nautel.com

## MOSELEY TRANSPORTS FOUR STATIONS ON ONE STL FREQUENCY

Moseley Associates Inc. has added features and models to its digital RF STL lineup to provide flexibility and high payload capacity.

The new eight-channel Starlink (shown) features four stereo audio streams and a one-way Ethernet channel for HD Radio. This means the user can transport up to four stereo radio stations on a single STL frequency. The eight-channel model features AES and analog I/O. Choices of audio coding from linear uncompressed to AAC compression provide flexible bandwidth usage while delivering clear digital audio. It sports metering, diagnostics and control of all parameters from the front panel, as well as a web browser interface for networked monitor and control.

The Topanga Digital Composite STL provides operators the opportunity

to keep processing at the studio and deliver the stereo MPX stream to the transmitter or multiple transmitter sites. Topanga's digital platform offers greater than 20 dB system gain advantage over old analog composite systems, which the company says benefits audio performance through improved signal to noise and stereo



separation. In addition to the digital MPX, Topanga carries a simplex Ethernet channel for HD Radio data stream plus RS-232 channels for RDS.

Starlink and Topanga models have a new 5 W power output for

improved robustness in challenging RF environments. Moseley's open architecture offers for customization and adaptability to changing requirements and technologies.

Moseley offers wireless solutions from 9.6 kbps to 3 Gbps covering the 250 MHz to 90 GHz spectrum for both point-to-point and point-to-multi-point applications for the broadcast, carrier, broadband enterprise, and service provider marketplaces.

For information, contact Moseley Associates in California at (978) 373-6303 or visit [www.moseleysb.com](http://www.moseleysb.com).

## GATESAIR

(continued from page 29)

there isn't much I need to do. This makes system maintenance simple.

### WORKFLOW

Our radio broadcast workflow produces a single program signal that is split in two directions for distribution. One path travels over coax cable to our satellite uplink, while Intraplex delivers the other signal as two simultaneous, redundant streams that are carried over Ethernet enroute to the Internet.

Our Intraplex network has the capacity to multicast signals to a total of six receivers. We are currently only delivering the stream to four receive sites. These include the three full-class radio stations, as well as to a broadcast translator site, which happens to have two other translators associated with it that extend its reach even further.

Since we have no other way to deliver our live programming to these four broadcast sites, Intraplex has become a vital link to these four points of distribution. Today, as we are close to acquiring our 46th radio station, having the GatesAir Intraplex IP Link 100 available as a reliable means of program distribution is an important factor in the future growth and expansion of our radio network.

For information, contact Keith Adams at GatesAir in Ohio at (513) 459-3447 or visit [www.gatesair.com](http://www.gatesair.com).

# BEST OF SHOW AWARDS 2017

@IBC2017, 15th – 19th September, Amsterdam

Recognising and rewarding the achievements and innovations in product and service development

## ENTER NOW!

ENTRY DEADLINE: 4TH SEPTEMBER 2017

[www.newbaybestofshow.com](http://www.newbaybestofshow.com)

SHORTLIST ANNOUNCED: 8th September

WINNERS ANNOUNCED: 18th September

Brought to you by:

**TVB Europe** **Installation** **PS EUROPE** **TV Tech Global** **Audio Visual** **RADIO WORLD**  
INTERNATIONAL EDITION

#newbaybos

NewBay

# AEQ Outfits La Xarxa

Phoenix Venus codecs send and receive programming for more than 125 affiliates

## USERREPORT

BY XAVIER CABESTANY  
Head of Technical Infrastructures  
La Xarxa Audiovisual Local

**BARCELONA, SPAIN** — La Xarxa Audiovisual Local (XAL) is a public audio and video programming producer, created by the Deputation of Barcelona. It generates contents for local broadcast for approximately 125 associated radio stations. The programming provided to these stations is combined with locally produced material. The stations also contribute content to the lead studios in Barcelona for the creation of programming that can be distributed across the network.

La Xarxa's distribution scheme had been satellite-based. In 2015, it was decided to migrate to an IP network, for which XAL contracted with Telefónica, the Spanish telecom.

As part of that project AEQ provided audio codecs and control software.

### CODECS

In total, nearly 150 AEQ Phoenix Venus audio codecs have been supplied, and software has been designed for control and monitoring of all audio codecs from any PC connected to the internet; program connection and disconnection; integration with an existing audio matrix; creation and activation of local or regional broadcast groupings; and management of point-to-point contribution connections from the central location.

The satellite links were replaced by terrestrial IP connections using Phoenix Venus IP audio codecs. Multicast groupings were created to which all local stations subscribe. Main and backup codecs send the audio to multicast IP codecs that in turn broadcast the audio to the remote devices subscribing to the multicast.

There is a Phoenix Venus codec at each local station. Channel 1 receives the multicast audio, with Opus encoding. The signal is stereo, 20 Hz–20 kHz with very low latency.

The existing broadcast automation system generates GPOs for the multicast main and backup Venuses' GPI, which sends to the selected codec the transporting orders to switch to the remote audio source or live console control.

The control server continuously monitors the status of the main and backup codecs and if the active fails, it resets the connection to the other. The audio input is distributed to both units from the matrix.

There are also multicast groups of reduced size and limited duration. Another five dual-channel Venus codecs are programmed for these missions.

In addition, there are also groups with fewer receivers or subscribers, where the "main station" is a local station sharing its program feed.

In both cases, these groups are controlled with scheduling software that creates groups, defines the time slots and automatically controls the connections of any of the involved codecs. If a codec is switched from the main group to a regional or local group, once finished its connection, it automatically deactivates and returns to its previous state and continues receiving the main program.

Channel 2 of the local Venus sends contributions back to the main studio. For this, in the main station there are five Venus codecs for contribution reception, each with two channels. This allows for up to 10 simultaneous contributions from various associated stations. These 10 bidirectional stereo channels are connected to the facility's AEQ BC 2000D matrix. Calls are manually placed from central control in the main station using a phone book and SmartRTP to establish the communication.

By February 2017, more than 85 stations were connected. The savings with regards to operating costs compared to the previous satellite infrastructure are considerable and, in addition the

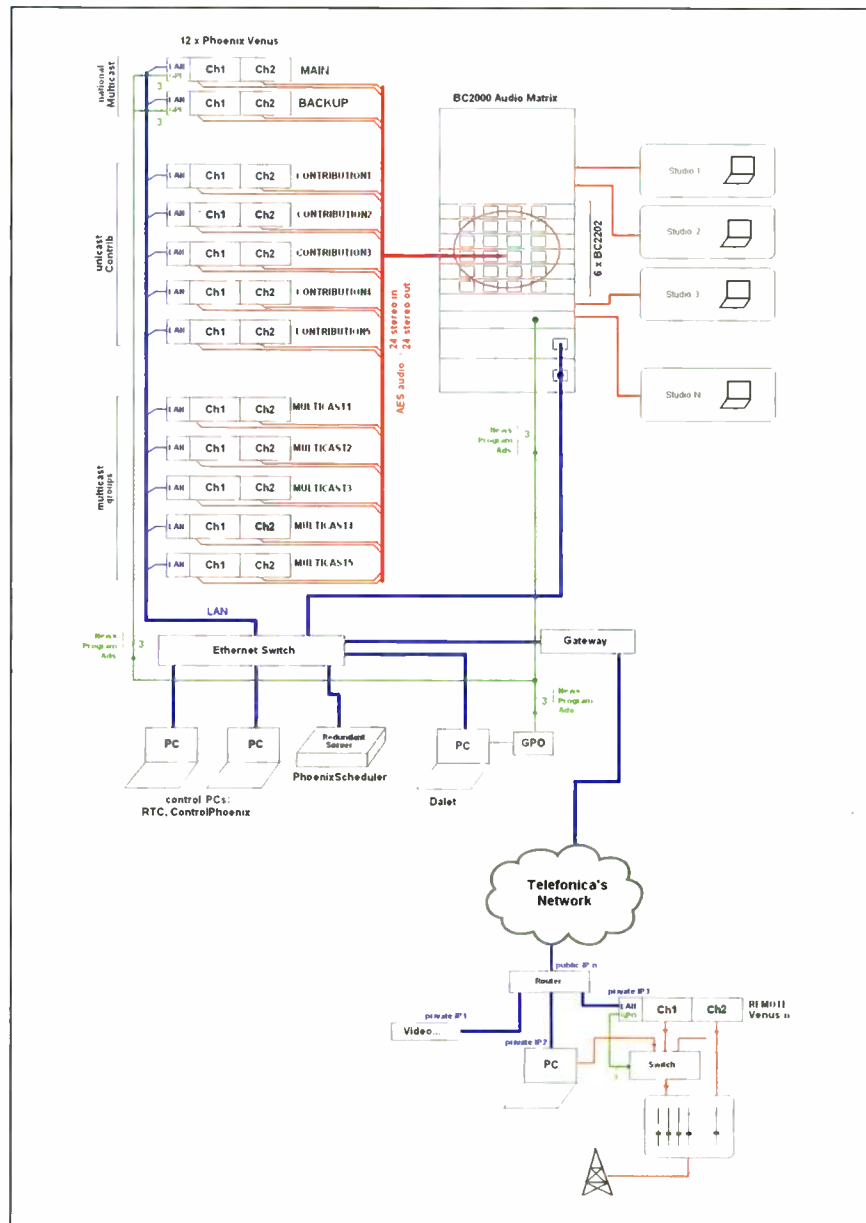

network is benefitting from greater flexibility, very low latency and fully bidirectional links.

It has been necessary to deal with challenges concerning the traffic distribution (IP multicast), QoS and bandwidth management, centralized control of all equipment and management tools, adaptation of the software to specific needs, documentation and configuration, training, etc.

Using the Opus algorithm, Phoenix

Venus codecs provide a clean audio signal with practically transparent quality and no data/audio loss. The software is being used daily and, together with the integration with the BC 2000D matrix, allows us great flexibility to produce and broadcast programs with the affiliated stations.

**For information, contact Peter Howarth at AEQ Broadcast International in Florida at (800) 728-0536 or visit [www.aeqbroadcast.com](http://www.aeqbroadcast.com).**

## BARIX

(continued from page 30)

vice makes setup plug-and-play, without having to manually configure network and streaming parameters.

This simplicity is particularly valuable when supplying Barix encoders to our contributors. I can set up a Barix unit to use Reflector, configure its security and hand it to the client, and they can take it to their studio. They essentially just plug their studio output into the Barix box, connect it to their internet service, and they're on the air, with Reflector taking care of the details.

We also like the monitoring functions of the Reflector

service, which give me visibility of the performance of the system and notify me of any issues. Like the Barix units themselves, I can access the Reflector service through a browser-based interface, letting me remotely manage and control the equipment at multiple stations from anywhere I go.

From STL to connecting remote studios and occasional on-location remote broadcasts, the Barix Instreamer and Extreamer devices and Reflector service have securely delivered studio-grade audio with great reliability and remarkable ease of use, all while saving us money.

**For information, contact Brenda Stadheim at LineQ/Barix at (866) 815-0866 or visit [www.barix.com](http://www.barix.com).**







## The hottest ticket this fall is in Austin. Get a front row seat for all the action!

- **Radio Luncheon** with FCC Chairman Ajit Pai and Entercom CEO David Field, National Radio Award recipient
- **Advertiser Breakfast**
- **Pillsbury Broadcast Financial Forecast**
- **Opening Session** on the connected car
- **The NAB Marconi Radio Awards Dinner & Show** with host Rickey Smiley
- **Customized Sessions** covering every facet of radio
- **The Marketplace** with exhibits, the latest technology and BMI artist performances
- **Music and Mimosas** - Hot new artists you don't want to miss
- **Unbeatable ROI** - revenue generating ideas and guaranteed results

Visit [RadioShowWeb.com](http://RadioShowWeb.com) and **REGISTER TODAY!**

# Tieline Climbs New Heights in Colorado

Bridge-IT XTRA links remote mountaintop transmitters to studios

## USERREPORT

**BY BRYAN WATERS**  
Chief Engineer  
Cheyenne Mountain Public  
Broadcast House and  
KIL0(FM), KRXP(FM)

**COLORADO SPRINGS, COLO. —** Think of Colorado and you think of mountains, and in a broadcast sense this presents challenges. As a broadcaster, you learn to work within the confines of what's possible based on the rugged terrain and inhospitable weather conditions encountered.

### MOUNTAINTOP CHALLENGES

One such example is how we transport STL audio from KCME(FM)'s studio in Colorado Springs to three remote mountaintop locations. These include Breckenridge in Summit County, Methodist Mountain above Salida, and Cripple Creek. KCME has an "all-classical" radio format, so we need to achieve great quality audio. None of these sites has wired network available; previously we used an expensive high-bandwidth satellite receiver to transport audio to each transmitter site. At around \$17,000 per year, this was prohibitively



expensive for a member-supported station. Plus, the connections experienced frequent dropouts due to poor weather conditions.

I first started using Tieline codecs

years ago at Citadel Communications (now Cumulus Colorado Springs), and I have broadcast with them in just about every way imaginable; they are versatile and reliable. For KCME, I believed we

## REPORT-IT FOR TEMPORARY STLs

When I speak of versatility, I have to mention that I once ran a station for around four hours using Tieline's Report-IT Enterprise smartphone app while I performed some transmitter site servicing tasks. To achieve this, I fed audio from the studio down the return path of a Report-IT smartphone connection and fed this into a Matchbox D.I. box and then into the transmitter. It worked solidly and proved to me that with a bit of lateral thinking, anything is possible in the world of broadcast.

could improve our results by installing Tielines, so in 2016 we purchased a six-input Tieline Genie Distribution codec with WheatNet-IP and installed it at KCME in Colorado Springs. We also installed a Tieline Bridge-IT XTRA codec at each remote transmitter site. To transport the audio we are using satellite IP data service attached to the codecs at Salida and Cripple Creek. Breckenridge uses a different service provided by the owners of the translator site on Mount Baldi, in Summit County, and is maintained by engineer Gary Peterson.

This has been a complete transformation for us. The connections are so much more reliable. We are not bothered too much about latency, so have employed conservative fixed jitter strategies with remarkable results. Our bandwidth is limited, so we connect using HE-AAC v2 at 64 kbps and the audio sounds much better than before. Lots of listeners have called and written to us to remark about how much better the station sounds which is extremely pleasing.

The other benefit is the cost savings. With lower bandwidth satellite links, we now save significantly on data costs, in fact we recouped the cost of the codecs in less than a year. The ongoing savings are also huge.

The codecs have to be reliable because we are unable to get to the mountaintop transmitter sites for around three months out of the year due to the weather conditions. They haven't missed a beat and we can remotely log-in to the codecs using the Toolbox web browser configuration tool to effect any configuration changes.

The studios for KIL0(FM) and KRXP(FM) are at the foot of Pikes Peak, the most visited mountain in North America and reaching 14,000 feet above sea level. Our transmitter for KIL0 and KRXP is situated at the top of Cheyenne Mountain and we feed audio to the transmitter over multiple paths.

## PRODUCTS & SERVICES SHOWCASE

### GORMAN REDLICH DIGITAL ANTENNA MONITOR



**MODEL CMR — Remote Controllable  
Digital Antenna Monitor — 2 tower  
Price \$3950  
additional towers \$200 each**

The Model CMR is a state of the art instrument of unequalled accuracy and stability. With typical modulation, the CMR's true ratio readout is a factor of 10 more stable than instruments that measure normalized amplitude. With a 15kc IF for the measuring circuit, this monitor is ideal for diplexed arrays.

- True Ratio reading. Non-Reference and Reference amplitudes are separately measured and divided electronically to give an accurate digital reading.
- Stable, accurate phase reading with automatic phase sign.
- Amplitude or True Ratio may be selected for measurement with a front panel switch.
- Dual Surge Protection.

**GORMAN REDLICH 257 W. Union Street Athens, Oh 45701**  
Phone: 740-593-3150 jim@gorman-redlich.com  
www.gorman-redlich.com

We use a Moseley 900 MHz STL encoder to feed linear audio directly up the mountain to a Moseley decoder for both stations. As a backup, we use a Genie Distribution codec at the studio to stream two stereo feeds over a 5.8 GHz Ubiquiti link to a Genie Distribution codec top side. Inputs 5 and 6 of the Genie Distribution top side are used to feed an older Marti RF transmitter, which is used to bring audio down as a remote broadcast backup for each station. There is also

a transmitter for KCFM on Cheyenne Mountain. We use a Moseley Starlink 900 MHz STL for the primary HD system into a BE FMi703 transmitter.

As a sidenote, Pikes Peak is not too far from Summit House, the purveyor of world-famous Pikes Peak doughnuts. So if time allows, it is definitely worth the trip!

For information, contact Dawn Shewmaker at Tieline USA in Indiana at (317) 845-8000 or visit [www.tieline.com](http://www.tieline.com).



# BROADCAST EQUIPMENT EXCHANGE

RADIOWORLD August 2, 2017

### Broadcast Engineering Software

- Create stunning "real-world" coverage maps, interference studies, and population reports with Probe 4™
- Find STL broadcast auxiliary and Part 101 microwave frequencies and generate PCN letters with Microwave Pro™
- AM Pro 2™, used daily by FCC engineers, performs skywave and groundwave allocation studies and AM coverage mapping
- Map FM stations and discover upgrade possibilities using FCC minimum separations and contour-to-contour methods with FMCommander™

**V-Soft COMMUNICATIONS**  
R.F. Communications Software and Engineering Consulting

[www.V-Soft.com](http://www.V-Soft.com) (800) 743-3684

**WANT TO BUY**  
RCA 77-DX's & 44-BX's, any other RCA ribbon mics, on-air lights, call after 3PM CST, 214 738-7873 or [sixtiesradio@yahoo.com](mailto:sixtiesradio@yahoo.com).

### MISCELLANEOUS

**WANT TO SELL**  
I'm selling between 150 and 200 cassette tapes that consist of old-time radio shows, sports shows, some local New York radio talk shows, etc... Must take entire collection and the price is negotiable. Please call me for details and, my phone number is 925-284-5428.

Radio broadcasts of Major League Baseball, NFL, and some college football games that are on cassette tapes, approx 100 to 125 games, time period of entire collection os from the 1950's - 1970's, BO. Must purchase entire collection. Contact Ron, 925-284-5428 or [ronwtamm@yahoo.com](mailto:ronwtamm@yahoo.com)

WYBG 1050, Messina, NY, now off the air is selling: 250' tower w/building on 4 acres; collection of very old 78s dating back to 1904; 12' satellite dish on concrete base; prices drastically slashed. 315-287-1753 or 315-528-6040

**WANT TO BUY**  
Collector wants to buy: old vintage pro gears, compressor/limiter, microphone, mixing consoles, amplifiers, mic preamps, speakers, turntables, EQ working or not, working transformers (UTC Western Electric), Fairchild, Western Electric, Langevin, RCA, Gates, Urei, Altec, Pultec, Collins. Cash - pick up 773-339-9035 or [ilg821@aol.com](mailto:ilg821@aol.com).

2" plastic "spot" reels 6.5 or 8" diameter, as used for quad video. Wayne, Audio Village, 760-320-0728 or [audiovlg@gte.net](mailto:audiovlg@gte.net).

## CONSULTANTS

**OWL ENGINEERING, INC.**  
Consulting Communications Engineers  
5844 Hamline Ave. N., Shoreview, MN 55126  
**651-784-7445**

- AM/EM/NCI Applications
- Allocation and Upgrade Studies
- Insurance - Investigation & Claims
- ANSI and NRSC Measurements
- AM Directional Arr. Design, Tuning and Proof using Method of Moments
- Tower Detuning
- Intermodulation Studies
- Radiation Hazard Evaluation and Measurements

Fax (651) 784-7541 E-mail: [info@owleng.com](mailto:info@owleng.com) "Member AI CCI"

**GRAHAM BROCK, INC.**  
BROADCAST TECHNICAL CONSULTANTS  
Full Service From Allocation to Operation AM/EM  
Field Work, Antenna and Facilities Design  
Over 45 years engineering and consulting experience  
**912-638-8028**  
**202-393-5133**  
[www.grahambrock.com](http://www.grahambrock.com)

**Equipment Wanted: obsolete, or out of service broadcast and recording gear, amplifiers, processing, radio or mixing consoles, microphones, etc. Large lots preferred. Pickup or shipping can be discussed. 443-854-0725 or [ajkivi@gmail.com](mailto:ajkivi@gmail.com).**

I'm looking for KTIM, AM, FM radio shows from 1971-1988. The stations were located in San Rafael, Ca. Ron, 925-284-5428.

I'm looking for San Francisco radio recordings from the 1920's through the 1980's. For example newscast, talk shows, music shows, live band remotes, etc. Stations like KGO, KFRC, KSFO, KTAB, KDIA, KWBR, KSF, KOB, KCBS, KQW, KRE, KTIM, KYA, etc, I will pay for copies... Feel free to call me at 925-284-5428 or you can email me at [ronwtamm@yahoo.com](mailto:ronwtamm@yahoo.com).

Looking for a broadcast excerpt of a San Francisco Giant's taped off of KSFO radio from 1959, interviews with Willie Mays, Dusty Rhodes & some play by play excerpts, also features a homerun by Willie Mays and Felipe Alou stealing second base, running time is 18:02, also looking for SF Giants games and/or highlights from 1958-1978 also taped off KSFO Radio. Ron, 925-284-5428 or [ronwtamm@yahoo.com](mailto:ronwtamm@yahoo.com).

Looking for KFRC signoff radio broadcast from 1930

Andy Potter, running time is 0:22 & also the KLX kitchen the program guest is Susanne Caygill, a discussion of women's affairs with a long promotion for Caygill's appearance at a local store. Anne Truax, Susanne Caygill, running time is 13:44. Ron, 925-284-5428 or email [ronwtamm@yahoo.com](mailto:ronwtamm@yahoo.com).

Looking for KSF radio shows, Disco 104 FM, 1975-1978. R Tamm, 925-284-5428.

Looking for KTIM FM radio shows from 1981-1984 if possible unscoped. R Tamm, 925-284-5428 or [ronwtamm@yahoo.com](mailto:ronwtamm@yahoo.com).

### RECEIVERS/ TRANSCEIVERS

**WANT TO SELL**  
Johnson Electronic SCA880 module, 67/92 Khz, 417-881-1846.

**WANT TO BUY**  
AM Stereo radio. Call 417-881-1846.

### RECORDING & PLAYBACK HARDWARE

**WANT TO BUY**  
1960s-vintage MacKenzie Repeater machines, magazines, spare parts and manuals, complete or "parts" machines considered, James, 870-777-4653.

Large or small collections of 16" transcriptions or 12" transcriptions, not commercial LPs. Bill Cook, 719-684-6010.

Schnader telecriptions 16 mm musical films produced in the early 50 s. Bill Cook, 719-684-6010.

Standard Short-tune series. Bill Cook, 719-684-6010.

### STATIONS

**WANT TO SELL**  
AM, Kentucky, Cheap! Group deal. [wrecktech@yahoo.com](mailto:wrecktech@yahoo.com), 478-741-1710.

(2) LPFM radio stations for sale, located in the NW part of central Florida on the gulf coast, covers the county, get out of the cold weather, come to Florida, call or write for particulars, 352-613-2289 or email [boceey@hotmail.com](mailto:boceey@hotmail.com) or Bob, PO Box 1121, Crystal River, FL 34423.

**WANT TO BUY**  
I will buy your distressed FM, AM or LPFM radio station even if you are "silent" as long as there is time left before you lose your license, Northeast, FL or GA. Please call Michael, 401-942-8341, if no answer please leave message and I will get back to you.

### ACOUSTICS

**AcousticsFirst!**  
Materials to Control Sound & Eliminate Noise  
Sonaoro, BlockAid, AriDiusor  
Toll-Free **888-765-2900**

### ANTENNAS/ TOWERS/CABLES

**WANT TO SELL**  
CCA FM8000G Trans 107.9, great cond; 4-Bay Jampro antenna w/deicers; 3-bay Shively antenna FM. D Brockman, 606-965-3436.

### AUDIO PROCESSING (INCLUDES ON-AIR)

**WANT TO BUY**  
Teletronix LA-2A's, UREI LA-3A's & LA-4's, Fairchild

660's & 670's, any Pultec EQ's & any other old tube compressor/limiters, call after 3PM CST - 214 738-7873 or [sixtiesradio@yahoo.com](mailto:sixtiesradio@yahoo.com).

Wanted: real plate reverb. [abgrun@gmail.com](mailto:abgrun@gmail.com).

### AUTOMATION EQUIPMENT

**WANT TO BUY**  
Western Electric 25B input console & amplifier (speaker). Li, [vanhanli@yahoo.com](mailto:vanhanli@yahoo.com).

### MICROPHONES/ HEADPHONES/ SPEAKERS/AMPS

**WANT TO SELL**  
1934 RCA 77A double ribbon microphone, originally used by Arthur Godfrey at WFBR Baltimore. 100% perfect condition. Contact Bill Cook, 719-684-6010.



## Rebuilt Power Tubes 1/2 the cost of New!

Se Habla Español

# ECONCO

Se Habla Español

Tel: 800-532-6626 Web: [www.econco.com](http://www.econco.com)  
 Intl +1-530-662-7553 Fax: +1-530-666-7760



### TRANSMITTERS/EXCITERS/TRANSLATORS

**TRANSCOM CORPORATION**  
*Serving the Broadcast Industry Since 1978*  
**Transmitters and Broadcast Equipment for Radio & Television**

#### Used FM Transmitters

55W	2000	Harris DIGIT CD
3.5 KW	2000	Harris Z3.5CD, solid-state
1.3/3.5 KW	2006	Harris Z6HD- Tri-Mode HD
5KW	1988	BE FM5A
5 KW	1995	Harris HT5 w/DIGIT
5 KW	1992	BE FM5B
10 KW	1988	BE FM10A, Dual 5 KW
10 KW	1998	Nautel FM10, Solid State
10 KW	2004	Harris Z10, Solid State
20 KW	1998	Nautel FM20, 2 X FM10 Combined
35 KW	1990	Continental 816R5B, SS IPA
25 KW	1982	Harris FM25K with DIGIT
35 KW	1991	BE FM35B

#### Used AM Transmitters

5 KW	2003	BE AM5E
10 kW	2001	Nautel XL12, solid-state
60 kW	2007	Nautel XL60

#### Exciters & Miscellaneous Equipment

Exciters->DIGIT, CE802B, BE FX50  
 Bird Model 8932, 10 kW air-cooled RF Load  
 Harris N + 1 Controller

Please visit our website,  
[www.fmamtv.com](http://www.fmamtv.com), for additional listings.



**HARRIS nautel**

**CROWN BROADCAST**

Used TV Transmitters DTV & ATV  
 \*\*Rohde & Schwarz\*\* Harris Maxiva\*\*

New TV Transmitters- DTV & ATV  
 Anywave, OMB, and Technologix

\*\*1KW Special w/4 channel encoder\*\*  
 VHF and UHF TV Antennas  
 (10 W to 10 KW) TV STL

800-441-8454 • 215-938-7304 • FAX: +1-215-938-7361

[www.fmamtv.com](http://www.fmamtv.com) • E-mail: [transcom@fmamtv.com](mailto:transcom@fmamtv.com)

RETUNING & TESTING AVAILABLE • CALL US FOR A QUOTE!

### AM Ground Systems Co

- Has your AM station lost coverage?
- Is your AM ground system over 30 years old?
- Has your ground system been damaged or vandalized?

[amgroundsystems.com](http://amgroundsystems.com)  
 866-22RADIO

[www.radioworld.com](http://www.radioworld.com)

# EMPLOYMENT

### POSITIONS WANTED

Are you a small market station needing a good nuts & bolts engineer in the Los Angeles area? I will make your station shine! CET, fully FCC Licensed. Available for Full/Part-time/Contract work. Available immediately. Mitchell Rakoff, 909-446-6820, [mitchellrakoff@yahoo.com](mailto:mitchellrakoff@yahoo.com).

Experienced radio station manager seeks new management opportunity. More than 39 years experience in radio. Willing to relocate. Family-friendly format(s) preferred. Send details about your management opening to: [radiogm@hotmail.com](mailto:radiogm@hotmail.com).

Extremely knowledgeable and articulate racing writer/talk show host Adam Amick is available for shows, correspondent, features, etc. Check out [www.bleacherreport.com](http://www.bleacherreport.com) for samples. Call 214-384-5812 or email: [adam@rubbinsracingshow.com](mailto:adam@rubbinsracingshow.com).

Australian broadcast technologist authorized to work in the USA seeking employment in NY, NY. My background is in IT, Radio and TV. I worked as a Senior Engineer in Australia covering all technical aspects of the broadcast chain, from the front door to the TX and of course OBs.

My skills include both hands on and project managing network design and config, studio design, rack planning, migration, install and commissioning, analog and digital facilities, playout systems, Cisco IP voice and data, desktops and servers, and help desk as well as good knowledge in solid state and valve TX equipment. I enjoy working in a team environment and work well under pressure. Excellent references available upon request. I live in Manhattan and can start immediately. If you would like to know more, please contact me at [tech@numeralla.com](mailto:tech@numeralla.com) or read by CV at [www.numeralla.com](http://www.numeralla.com).

### TAX DEDUCTIBLE EQUIPMENT

Donations Needed: All Volunteer, Non-profit Low Power community radios need Equipment. Will offer tax deduction letter, You determine donation value, We will pay shipping. Equipment shared between three Wisconsin stations. Looking for Mics, Mixers, field equipment, etc. You name it. Email: [Dan@WIECradio.org](mailto:Dan@WIECradio.org).

## DISTRIBUTOR DIRECTORY

The following distributors serving the broadcast industry would be glad to help you with any of your requirements.

CORNELL-DUBILIER  
 MICA CAPACITORS

FROM STOCK

JENNINGS VACUUM  
 CAPACITORS

FROM STOCK

HIGH ENERGY CERAMIC  
 CAPACITORS

**SURCOM ASSOCIATES**

567 E El Camino Real, Suite K  
 Carlsbad, California 92008  
 (760) 438-4420 Fax (760) 438-4759  
 e-mail: [info@surcom.com](mailto:info@surcom.com) web: [www.surcom.com](http://www.surcom.com)

## TUNWALL RADIO

SWITCH AND TRANSMITTER CONTROLLERS

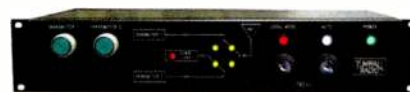

AM/FM/MULTI-SWITCH AND CUSTOM DESIGNS

330.995.9642

[www.tunwallradio.com](http://www.tunwallradio.com)

### TUBES



Keeping you on the  
 air since 1934!

ISO 9001 Certified

**NEW POWER TUBES**

Triodes  
 Tetrodes  
 Pentodes

**NEW SOCKETS &  
 REPLACEMENT PARTS**

Worldwide Availability

Made in the U.S.A.

Call (800) 414-8823  
 Int'l (650) 846-2800  
 Fax (650) 846-3795

Visit our Website at  
[www.cpii.com/eimac](http://www.cpii.com/eimac)



Run your  
 employment ad  
 on our website  
 for only  
**\$2 per word!**

[www.radioworld.com](http://www.radioworld.com)

Call Michele  
 for all the details at  
**212-378-0400**  
 ext. 523

[minderrieden@nbmedia.com](mailto:minderrieden@nbmedia.com)

# EAS Is Still Relevant as WEA Works Out Kinks

WEA alerts should direct citizens to tune into local stations

## COMMENTARY

BY KEVIN CURRAN

Whether it was CONELRAD, the Emergency Broadcast System or today's Emergency Alert System, broadcasters have been tasked with responsibility for mass notification for 66 years.

You can count me among those broadcasters who have wondered if the audience would be aware in the event of an actual emergency. A study I conducted and recently published in the peer-reviewed Journal of Emergency Management provided support for those skeptical of the effectiveness of the EAS. But it may also present a sobering reality to emergency managers, who might expect more from both media and cellular notification systems than they are likely to receive.

Today's EAS covers over-the-air TV and radio, satellite radio, DBS and

an Amber Alert. The "connected cars" rolling off assembly lines will only decrease the likelihood of drivers making an audio choice that could receive an EAS activation.

### INSTRUCTIONS AND OFFICIAL INFORMATION

An assessment of warning systems for the Federal Emergency Management Agency determined six actions need to be taken for a warning to be effective:

1. Hearing it
2. Understanding its message
3. Believing the accuracy and credibility of the warning
4. Personalizing the warning
5. Confirming the warning is true and others are taking action
6. Taking their own action

An advantage of EAS is that viewers or listeners are not likely to doubt the accuracy or credibility. However, personalizing the warning may be a challenge.

**Broadcasters should be pushing for a procedure where a WEA message refers to local stations by frequency so users would know where to tune for official information.**

cable systems. As the number of media options has increased, the chance of an EAS message reaching a critical mass of its intended audience has decreased.

Veteran engineer James O'Neal wrote in TV Technology in 2014. "It's not the same world that existed a few decades ago."

Time-shifted television viewing has been around since the advent of the VCR. One study of cable subscribers found 45 percent were using DVRs to time-shift viewing, 8 percent of those waiting eight to 15 days to view the recorded shows, long after the useful life of a severe thunderstorm warning. With Hulu and similar video on demand services available, there is no way for broadcasters to reach those viewers with timely alerts.

The view is not much better on the radio side, where one survey found more than a quarter of drivers were listening to internet audio streams through a smartphone connected to the vehicle's audio system. That self-curated Pandora playlist is not going to be interrupted by



"One of the drawbacks of the current EAS system is that it tends to send warning messages to a much larger area than is actually at risk from the hazard," according to Mike Smith, a warning coordination meteorologist at the National Weather Service storm prediction center in Norman, Okla.

TV stations in markets such as Wichita-Hutchinson, Kan., are tasked with providing service over large territories, perhaps of more than one state. An EAS alert on a tornado warning would reach not only those potentially affected, but others far from the warning area.

Another challenge for EAS is the

source of the warnings.

The NWS generates the most EAS activations, would be recognized as a credible source and has decades of experience with mass notifications. That may not be the case with local emergency officials. Most broadcasters have heard the tale of the Minot, N.D.,

This "system of systems" approach has a goal of issuing an alert within 10 minutes that will reach 85 percent of a potentially affected population. WEA messages are supposed to override other cellular traffic with a 90-character message accompanied by a distinctive tone and vibration to all properly equipped and programmed cellphones in a designated area.

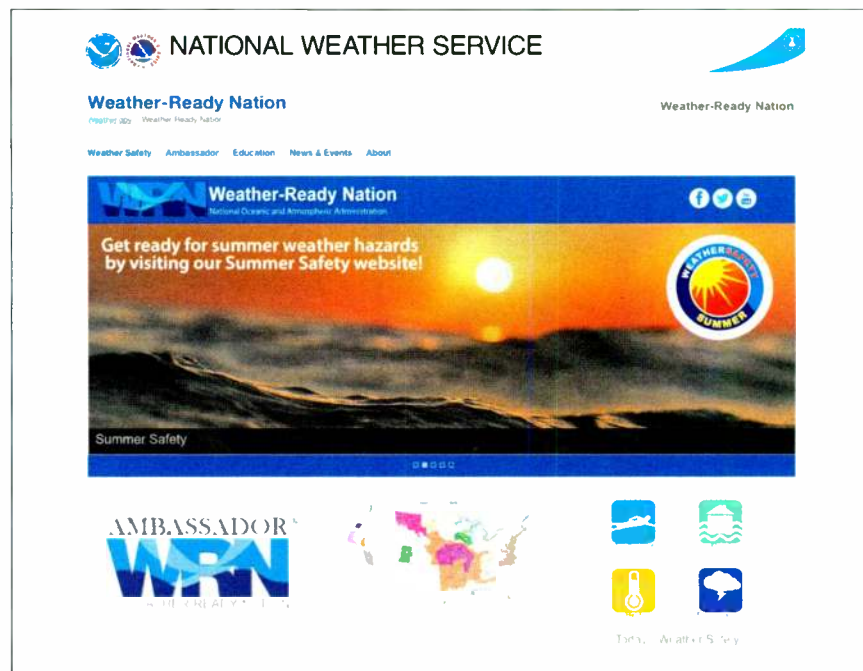

train wreck and the lack of an EAS alert that a toxic cloud was spreading through part of the city. Many reports blamed the absence of an alert on the unattended operation of the local radio stations because police officials said they could not reach anyone in the studio. A post-event investigation found that officers were calling an EBS phone line that had been disconnected when the stations gave the dispatch center an EAS encoder. That encoder had never been installed.

### THE CELLULAR OPTION

In 2013, Warren Schulz, a veteran Chicago engineer and former Illinois EAS chair, suggested in Radio World, "EAS cannot be fixed and should be closed down. Rely on cellphone text alerts. If desired, reserve the EAS radio daisy chain for long-form messages."

FEMA and the FCC sought to address some of these concerns with the Integrated Public Alert and Warning System. It includes the EAS and what is now called Wireless Emergency Alerts (formerly known as the Commercial Mobile Alert System and the Personal Localized Alerting Network).

This is a development welcomed by Morgan Hoaglin at the Arizona Department of Emergency Management, who noted, "IPAWS does not depend on any one technology."

With cellphones in just about everyone's pocket, it would seem that WEA could replace the other mass notification systems. An update to that old saying may go, "You can lead a person to information that could save their life, but you can't make them receive it."

Immediately after one of the first WEA messages in Phoenix, my Twitter stream was full of users asking what had just happened to their phones — and how to prevent it from happening again. Later tweets explained how the settings could be adjusted to turn off two of the three alert categories (national alerts cannot be disabled).

A 2013 study of post-alert Twitter comments for FEMA's parent agency, the Department of Homeland Security, showed this user reaction was not unusual. The DHS consultants admit their anecdotal evidence points to a need for further study of message content, geo-targeting and both understanding and improving the response to the

(continued on page 38)

**EAS***(continued from page 37)*

warnings by phone users. The report mentioned support from government websites, but little mention of the system from carriers or retailers.

On Sept. 9, 2016, the FCC issued report & order as well as a further NPRM FCC 16-127. The R&O required alert messages to expand from a maximum 90 characters to a maximum of 360 characters on 4G-LTE and future networks. It added a "Public Safety Messages" category, required cell carriers to allow embedding phone numbers and/or URLs placed in WEA messages and support WEA messages in Spanish. The carriers must also maintain a log of the messages, narrow geo-targeting as possible, and send the messages without delay. The R&O concluded with enhanced provisions for testing, exercising, and raising awareness of the WEA system.

The Further NPRM included a study of ways to keep WEA consistent with advancing technology, such as multimedia, multilingual and geo-targeting possibilities.

**WHERE DOES EAS FIT IN?**

Even if the expectation of EAS as a first alert source is overestimated, it is still the best option for continuing information. A WEA message cannot convey information about evacuation routes or shelter locations; the information Schulz wrote about would be a proper continuing use for the EAS. Radio stations manage to find ways to stay on the air in the direst circumstances.

Broadcasters should be pushing for a procedure where a WEA message refers to local stations by frequency so users would know where to tune for official information. With the 90-character limit, an alert may only be able to say, "Check local media." Directing people to the proper local media could prove to be a lifesaver.

*The author is a Ph.D. student at the University of Oklahoma's Gaylord College of Journalism and Mass Communication. He has held a variety of radio and television news and management positions in New York, Washington, Los Angeles and Phoenix. Reach him at kevin\_curran@ou.edu.*

*Comment on this or any story to radioworld@nbmedia.com with "Letter to the Editor" in the subject field.*

**READER'S FORUM****AM IMPROVEMENT**

One of the biggest problems confronting AM stations in this era has yet to be addressed by the FCC. Putting low-power FMs on the air to duplicate AMs is a nice Band-Aid but not really a solution. AM radio does still have advantages, but its biggest disadvantage is the one besetting virtually all but the Class A clear channel stations: having to be directional, especially at night (if they have much or any power to broadcast with at night), to prevent skywave interference.

George Frese, PE, the legendary engineer from Wenatchee, Wash., long ago came up with what appears to be a solution to the dual problems of siting AM towers and avoiding nighttime directionalization and nighttime skywave interference for AM stations. He did so inadvertently, with one elegant solution to a different, difficult problem.

A new AM CP issued in the breakdown of the clear channels, decades ago, was for 660 kHz — but because of FAA issues at the location and the CP's proximity to Canada, the station could not put up a tall tower for its nondirectional operation.

George, who also invented almost all of modern audio processing with his unpatented 1950s Frese Audio Pilot (about which I could tell many amazing stories), came up with an imaginative and unorthodox solution drawn from shortwave: A Parantenna. It worked, and the station is licensed, and all these years later it still does just what it is supposed to — using 110-foot-high towers! Yes, it's a four-tower nondirectional; the station is KAPS in Mt. Vernon, Wash. I have seen these short towers, visible from Interstate 5 well north of Seattle. It exists.

The principle is that four short towers are arranged in a box shape, and all four have grounded bases. The tops of the towers are star fed from a central point in the center of the array. The station operates with 10 kW day and 1 kW night from this nondirectional antenna system.

First, solving the transmitter-site problem: If 110-foot towers work at 660 kHz, imagine how short and closely-spaced the towers could be at 1500 kHz? You could fit it in a residential back yard, and it would not stick up above the house! And even at 540 kHz the towers probably still would not be high enough even to require tower lights!

Second, as for avoiding directionalization (at least at night) and skywave interference from nondirectional operation: George decided, based on his own observation and reports, that there is not much if any skywave coming out of this array; the skywave seems to be suppressed, with the signal simply extending out along the ground. (And it does do have a good groundwave; I have heard it in the daytime nearly 300 miles away on a GE SuperRadio, across land the conductivity of which officially is listed as 4 mhos.) At night, I have never heard it from my same location on the same radio.

George thought he had solved the AM skywave problem, which would open a new world for AM stations at night — but he had no money to hire a helicopter for a vertical pattern plot around the KAPS antenna system, and as far as I know nobody has since.

Bear in mind that this is just one of the several novel and unique antenna systems for AM that George put on the air over the years, for each of which the FCC demanded a full "directional proof of performance," despite in this case its lack of directionality. The KAPS antenna system performance (minimum field at one mile, lack of directionality) was proven, and was accepted, and was licensed by the FCC. This is not speculation. It is licensed, and it works.

Perhaps Radio World would like to undertake such a vertical plot pattern measurement at KAPS and see if George was right; this solution could be presented to the FCC as a future part of AM revitalization, spurred by your magazine!

*Eric Norberg  
Editor, The Adult Contemporary Music Research Letter  
Author, "Radio Programming: Tactics and Strategy"  
Portland, Ore.*

**CORRECTION**

In the June 21 letter "Too Much Competition," we misstated Ed DeLaHunt's location. He was writing from Park Lake, Minn., not Park Lake, Mich.

**ADVERTISER INDEX**

This listing is provided for the convenience of our readers. Radio World assumes no liability for inaccuracy.

PAGE	ADVERTISER	WEBSITE/URL
19	Arrakis Systems Inc.	www.arrakis-systems.com
11	Axia - The Telos Alliance	www.telosalliance.com/axia
4	Burk Technology	www.burk.com
7	Comrex Corporation	www.comrex.com
39	DAWNco	www.dawnco.com
26	Deva Broadcast Ltd	www.devabroadcast.com
18	Dixon Systems	www.dixonsystems.com
1	ENCO	www.enco.com
27	GatesAir	www.gatesair.com
34	Gorman Redlich Mfg	www.gorman-redlich.com
13	Inovonics Inc	www.inovonicsbroadcast.com
17	Lawo	www.lawo.de
12	Lightner Electronics	www.lightnerelectronics.com
1	Logitek	www.logitekaudio.com
23	Moseley Associates	www.moseleysb.com
3, 10, 14, 22, 30, 32	Nautel Ltd.	www.nautel.com
15	Omnia - The Telos Alliance	www.telosalliance.com/omnia
33	Radio Show	www.radioshowweb.com
29	Radio Systems Inc	www.radiosystems.com
25	SCMS	www.scmsinc.com
9	Tieline Technology	www.tieline.com
2, 20-21, 40	Wheatstone Corporation	www.wheatstone.com

**HOW TO****COMMENT ABOUT ONLINE STORIES:**

Post your opinions about any Radio World story using the DISQUS commenting tool. Just scroll down to the bottom of any story on the Radio World website: **radioworld.com**.

**CONTRIBUTE FREELANCE ARTICLES:**

Email **radioworld@nbmedia.com** and request our Writer's Guidelines.

**FLEXtest METER TO IDENTIFY SATELLITES & PEAK DISHES**

Customers report that they can boost EbNo performance by several dB, when using the FLEXtest meter to perfectly peak their satellite dishes. Base unit with SAT module will display satellite names, and show precise signal quality feedback for every adjustment to antennas. Portable unit with neck strap to allow hands-free adjustment of the dish. Much more precise than a spectrum analyzer, plus it powers the LNB during work. USA tech support. Ask about option to add measurement of Cable TV & Off Air.



**FLEXtest-XR3 meter + VSAT module CALL**  
**Option: Add cable TV/OffAir module & case**

**TI FILTER TO PREVENT TERRESTRIAL INTERFERENCE**

Block local radar before it enters your dish-mounted LNB. Rhythmic drop-outs and degraded satellite reception often occurs near airports, harbors, or military bases. The filter also blocks interference from the newly FCC authorized 3.65 Ghz Wimax transmitters. Pass the desired 3.7 to 4.2 Ghz satellite channels with super-low .4 dB insertion loss. Block out-of-band interference by up to 70 dB.

**TI Filter, best grade CALL for special price**



**DAWNflex LOW-LOSS CABLE, BOOST SIGNAL LEVEL FROM DISH**

Improve signal quality on satellite downlink, by increasing signal level without using noisy amps. Reduce loss on signal cable run from dish to building. Flexible coax passes satellite L band signals from LNB. Flooded for direct burial, quad shielded for best protection from signal ingress. Connectors with lightning protection on both ends.

**DAWNflex cable \$1.29 per foot**



**FIBER OPTIC LINK FOR LONG DISTANCES PASS SATELLITE OR CABLE TV SIGNALS**

500 feet to fifty miles is no problem using fiber. Place a transmitter (TX) on one end, and receiver (RX) unit on the other end. The TX and RX units will convert your signals to light, which will pass your important information over a long distance of SingleMode fiber optic cable. Choose the SATELLITE fiber link to pass the L band 700-2800 Mhz output from one LNB. Choose the CABLE TV fiber link to pass Cable TV channels in the 45 to 860 Mhz band. Call for help choosing the best system for your needs.

**SATELLITE fiber TX/RX link #FSS-95F13T&R \$1599**

**CABLE TV fiber TX/RX link #FBS-870F6T&R CALL for Price**



**STATIONARY 3.7M DISH PACKAGE FOR RADIO-SAT-MOVE**

Best stationary 3.7 meter satellite antenna package, to ensure great reception of programming for the RADIO-SAT-MOVE. The 3.7 meter antenna package includes: One 4-petal aluminum satellite "dish" antenna, one 2-port C band fixed feedhorn, one cover plate to fit over one of the unused ports, and one top grade C band LNB with best-in-industry specs for maximum reception quality. New dish and parts ship in crate directly to the site, and fit onto customer provided 5.5 inch OD pipe. Call DAWNco to discuss options for: ground mount, roof mount, long distance cable run, option for high wind protection for hurricane areas.

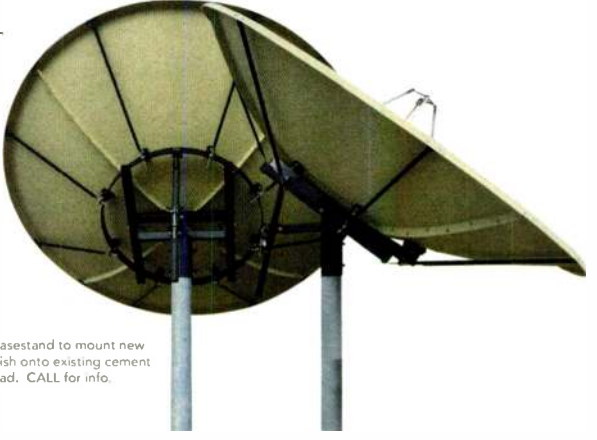

**Stationary 3.7m sat dish package for Radio-Sat-Move \$2471**

**Stationary 3.7m satellite antenna-only, #D37F48-4PC-5.5 \$1999**



Basestand to mount new dish onto existing cement pad. CALL for info.

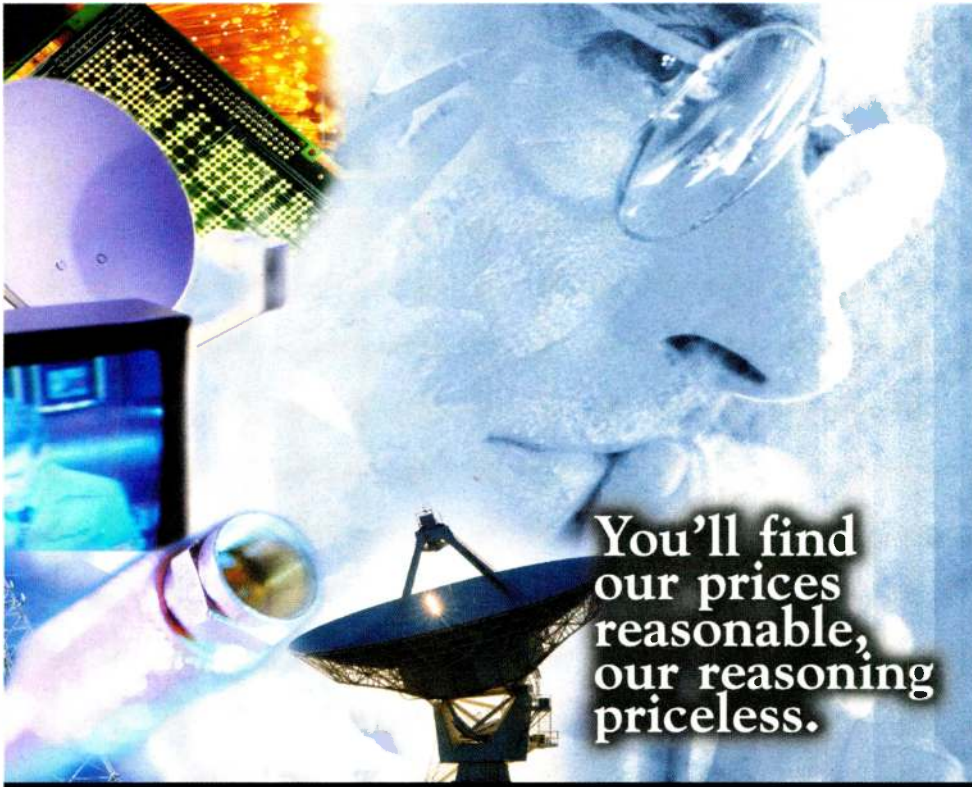

**You'll find our prices reasonable, our reasoning priceless.**

We can help you choose the best SATELLITE and FIBER OPTIC products to suit your needs. Our advice can help you get what you need, without paying for features you won't need. DAWNco high-gain satellite antennas will give you great reception, and our top-grade LNBs will optimize the reception quality of your finicky digital channels. Check out our web site, or give us a call today.



**DAWNco**

**www.DAWNco.com • PHONE 248-391-9200 • EMAIL sales@DAWNco.com**

**PREVENT SIGNAL OUTAGES IN WINTER**

Winter can be bad for reception of satellite signals. Snow and ice can pile onto your dish, which can cause a shift in the focal point and extra signal attenuation. Block the winter snow pile-up with DAWNco covers and heaters, and keep your signals strong.

**COVERsat** for protection under most conditions. Heavy vinyl cover is wrapped over the front face of your dish, to create a steep slippery surface that will prevent accumulation of ice & snow.

**COVERsat for 3.0m dish \$399 other sizes... CALL**



**HEATsat** completely stops snow outages. Electric HEATING system arrives as a kit for customer installation on a new or existing satellite antenna. Kit includes custom sized sheets of heater matting, plus sensors for precipitation and temp.

**HEATsat for 3.0m dish \$2400 other sizes... CALL**

**TOP-GRADE LNBs for C & Ku BAND**

Try our new generation of LNBs, and watch for improved EbNo readings on your digital satellite receivers. Mandatory upgrade for HD and 8PSK satellite channels. Best-specs for "gain compression" and "phase noise." Stability rating of ±2 KHz will prevent video picture tiling and signal outages when outdoor temps fluctuate.

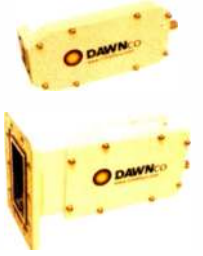

**C band LNB, high grade \$219**  
**C band LNB, best grade CALL**  
**Ku band LNB, best grade CALL**



**SIGNAL SPLITTER & POWER FOR LNBs**

All signal wires go into this amplified splitter. 1 LNB can feed signal to up to 9 receivers, or 2 LNBs can each feed 5 receivers. 18 vdc power to LNBs.

**DIVINSUP-2-1X5A \$219**

**LNB POWER SUPPLY**

Insert 18v dc power via coax cable for 1 or 2 LNBs

**DCP7A \$77**



**SAT SIGNAL SPLITTER**

high quality to pass L band

**2x DED772A \$18**  
**4x DED774A \$24**



**SURGE SUPPRESSOR for LIGHTNING**

Stop lightning surge on signal cable from damaging equipment. Units can take multiple hits, with no need for resetting.

**LNB-ZAP-Stop \$122**





## Solid Precision... Raw Metal to Heavy Metal

(or pop, jazz, classical, hip-hop, AOR, CHR, top 40, oldies, talk, etc)

Ultra-precise metalwork and fabrication using lightspeed-class materials and techniques. Advanced surface-mount technology for flawless circuitry. Meticulously assembled by people who've made their careers crafting these consoles for years. From concept to delivery, each Audioarts AIR Series console is a Wheatstone thoroughbred, designed and built to be the centerpiece of your studio.



**AIR-1 USB**

Compact 8-channel powerhouse, 2 mics/6 Lines.  
Great for small stations and remotes.



**AIR-4**

Remarkable 12-channel console, A/B, & Mix Minus.  
Major market features at a small market price.

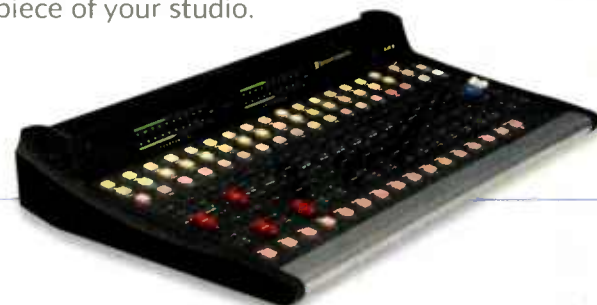

**AIR-5**

Phenomenal 16-channel console, built for studios that have a lot of inputs. Sometimes you need a fader for everything.

Super Quiet mic preamps, built-in USB, hybrid-ready phone input channels, talkback, and much more.  
Perfect for any professional broadcast studios, remotes, LPFMs, podcasters, and streamers.

### AIR Series Consoles: Hardcore Pro From Start to Finish

Learn more at [audioarts.com/air](http://audioarts.com/air)

