



RADIOWORLD

DECEMBER 3, 2014 | The News Source for Radio Managers and Engineers | \$2.50 | RADIOWORLD.COM

Skotdal: AM Band Needs Drastic Change

Frank talk from a station owner about migration, all-digital, shutdown incentives, analog sunset

COMMENTARY

BY ANDREW SKOTDAL

The author is licensee of 50 kW AM stations KRKO and KKXA in the Seattle market, incoming chair of the Washington State Association of Broadcasters and a former NAB board member. He participated in the recent NAB Labs driving tests of all-digital on the AM band. Opinions expressed are his own.

All-digital transmissions on the AM band are better than analog. However, all-digital operation, if adopted, would only be a Band-Aid for the unstoppable rising tide of electromagnetic erosion that ultimately will wash away the coverage and signal improvements of digital.

History weighs against achieving the consumer receiver adoption levels necessary to realize the benefits of all-dig-

ital ahead of this electromagnetic tide. Further, a majority of directional AM licensees will be unable to participate in its benefits for reasons unrelated to the technology.

For those who seek a permanent solution, migrating occupants of the band to vacated VHF spectrum remains the only option anyone should consider truly "permanent."

TIME IS AGAINST US

In the 1920s, our station's signal, then at 250 watts, received daytime reception reports from Vancouver, B.C., to Portland, Ore. Today, we need 50,000 watts to reach 60 miles from our studios in Everett to listeners in Tacoma and Bellingham. Electromagnetic noise in the AM band is getting worse. In-car cell phone chargers, computers, LED lighting and a host of other electronics interfere with the band and shrink coverage areas.

Digital overcomes some of these

(continued on page 6)

Pecena: Excellence in Education

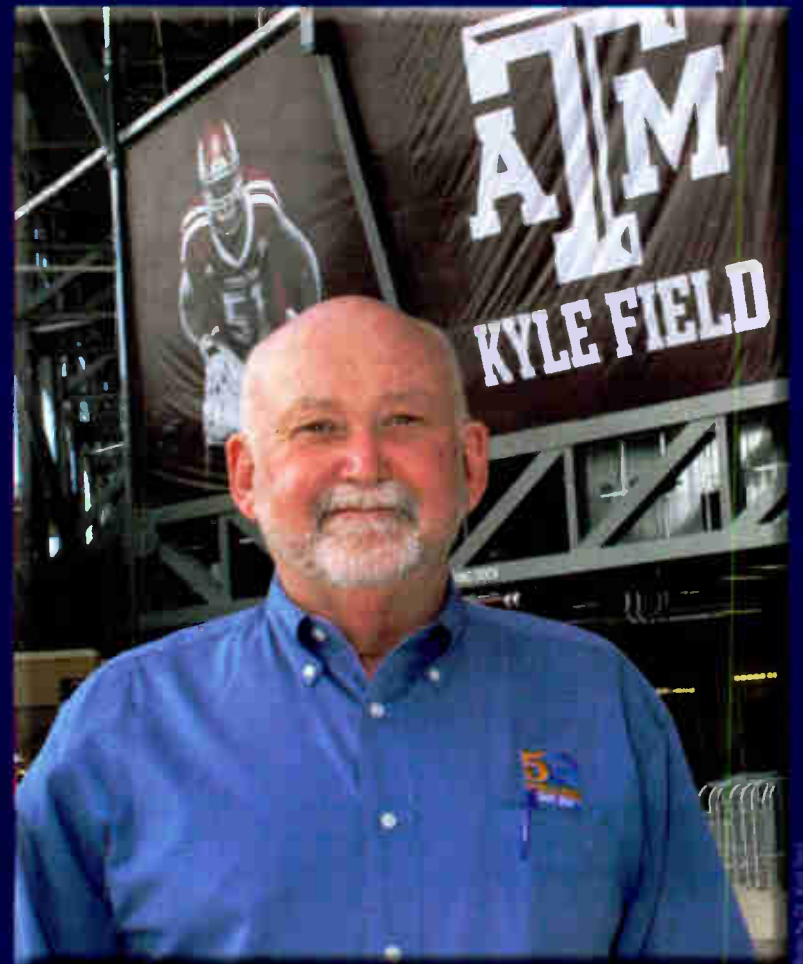

If our industry had a master faculty, Wayne Pecena, recipient of the Radio World Excellence in Engineering Award, would be a tenured professor. **Page 4**

693-1SD1 000005707
TUCSON AZ 85710-7905 2033 S AUGUSTA PL
KOHK
ASSISTANT CHIEF ENGINEER
TOM MILLER
#BXNR1QT *****AUTO*****SCH 3-DIGIT 856
#0009383 1# RDWA 0009383 E1401

DAD

THE World's Most Powerful
AND
Flexible Radio
Automation Software

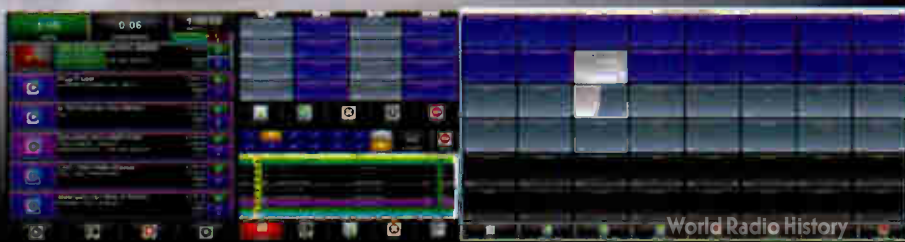

ENCO

ENCO.COM
800-ENCO-SYS

[@encosys](https://twitter.com/encosys) [fb.com/encosys](https://facebook.com/encosys)

WHEATSTONE
THE INTELLIGENT NETWORK

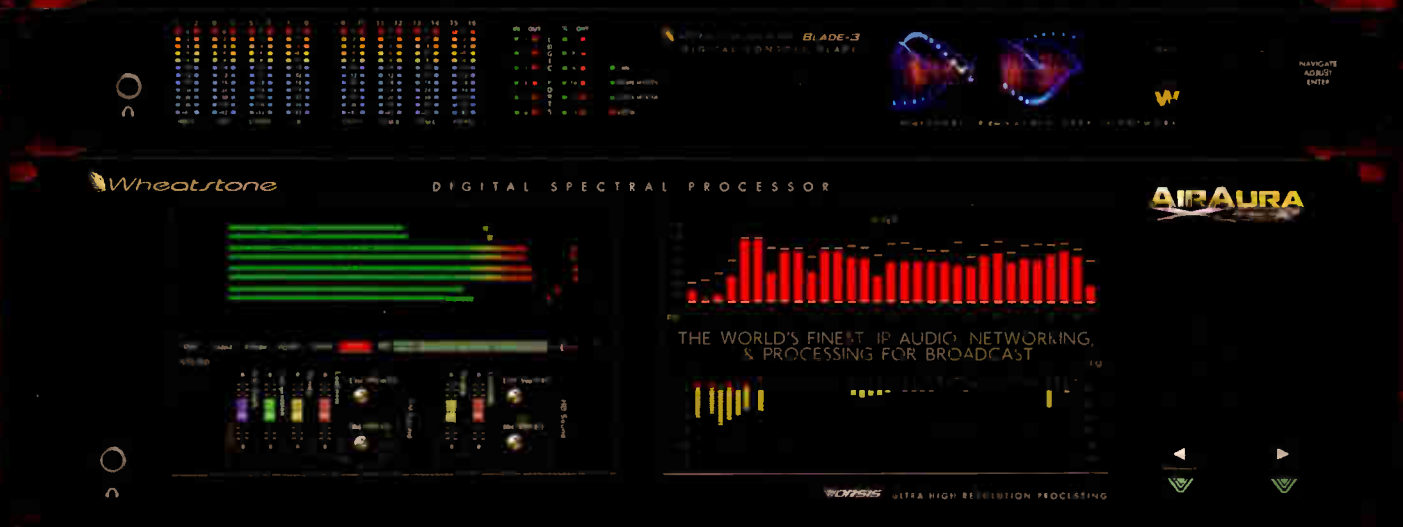

GO AHEAD... BLOW SOME MINDS...

THE WORLD'S FINEST IP AUDIO NETWORKING & PROCESSING FOR BROADCAST

 **Wheatstone**
BROADCAST AUDIO PERFECTIONISTS

WE'VE BEEN HERE SINCE 1953

World Radio History

For address changes and subscription renewal, please visit radioworld.com and click on the "Subscription" button. To submit letters or story proposals, to request writer's guidelines, or for other editorial matters, email the editor at radioworld@nbmedia.com.

EDITORIAL STAFF

EDITOR IN CHIEF, U.S. Paul J. McLane
 NEWS EDITOR/WASHINGTON BUREAU CHIEF Leslie Stimson
 GEAR & TECHNOLOGY EDITOR Brett Moss
 TECHNICAL ADVISER Thomas R. McGinley
 TECHNICAL EDITOR, RWEE Michael LeClair
 PRODUCTION EDITOR, RWEE Karen Lee
 CONTRIBUTING EDITOR John Bisset
 INTERNATIONAL EDITOR IN CHIEF Marguerite Clark
 LATIN AMERICA EDITOR IN CHIEF Rogelio Ocampo
 ASSISTANT EDITOR Emily Reigart

EDITORIAL CONTRIBUTORS

W.C. Alexander, Barry Blesser, James Careless, Harry Cole, Ken Deutsch, Mark Durenberger, Charles Fitch, Christopher Friesen, Harold Hallikainen, Craig Johnston, Alan Jurison, Paul Kaminski, John Kean, Peter King, Mark Lapidus, Daniel Mansergh, John Merli, Laura Mir, Jim Peck, Mark Persons, Stephen M. Poole, Carl Lindemann, James O'Neal, Tom Osenkowsky, Rich Rarey, John Schneider, Randy Stine, Richard Strickland, James G. Withers, Tom Vernon

ADMINISTRATION & PRODUCTION

PUBLISHER John Casey
 EDITORIAL DIRECTOR Paul J. McLane
 PRODUCTION DIRECTOR Davis White
 PRODUCTION PUBLICATION COORDINATOR Karen Lee
 ADVERTISING COORDINATOR Caroline Freeland

CIRCULATION

GROUP DIRECTOR, AUDIENCE DEVELOPMENT Meg Estevez
 CIRCULATION MANAGER Kwentin Keenan
 ASSOCIATE CIRCULATION MANAGER Michele Fonville

SUBSCRIPTIONS

Radio World, P.O. Box 282, Lowell, MA 01853
 TELEPHONE: 888-266-5828 (USA only 8:30 a.m.–5 p.m. EST)
 978-667-0352 (Outside the US) FAX: 978-671-0460
 WEBSITE: www.myRWNews.com
 EMAIL: newbay@computerfulfillment.com

CORPORATE

NewBay Media LLC
 PRESIDENT AND CEO Steve Palm
 CHIEF FINANCIAL OFFICER Paul Mastronardi
 CONTROLLER Jack Liedke
 VICE PRESIDENT OF AUDIENCE DEVELOPMENT Denise Robbins
 VICE PRESIDENT OF DIGITAL MEDIA Robert Ames

VIDEO/BROADCAST GROUP

EXECUTIVE VICE PRESIDENT Carmel King
 VICE PRESIDENT / SALES DIRECTOR Eric Trabb

ADVERTISING SALES REPRESENTATIVES

US REGIONAL & CANADA: John Casey, jcasey@nbmedia.com
 T: 212-378-0400, ext. 512 | F: 330-247-1288
 US REGIONAL: Michele Inderrieden, minderrieden@nbmedia.com
 T: 212-378-0400, ext. 523 | F: 301-234-6303
 EUROPE, AFRICA & MIDDLE EAST:
 Raffaella Calabrese, rcalabrese@broadcast.it
 T: +39-02-9288-4940 | F: +39-02-7004-36999
 LATIN AMERICA: Susana Saibene, susana.saibene@gmail.com
 T: +34-607-31-40-71
 JAPAN: Eiji Yoshikawa, callems@world.odn.ne.jp
 T: +81-3-3327-5759 | F: +81-3-3322-7933
 ASIA-PACIFIC: Wengong Wang, wwg@imaschina.com
 T: +86-755-83862930/40/50 | F: +86-755-83862920
 CLASSIFIEDS: Michele Inderrieden, minderrieden@nbmedia.com
 T: 212-378-0400, ext. 523 | F: 301-234-6303
 LIST RENTAL: 914-925-2449, danry.grubert@lakegroupmedia.com

Radio World Founded by Stevan B. Dana

Radio World (ISSN: 0274-8541) is published bi-weekly with additional issues in February, April, June, August, October and December by NewBay Media, LLC, 28 East 28th Street, 12th Floor, New York, NY 10016. Phone: (703) 852-4600, Fax: (703) 852-4582. Periodicals postage rates are paid at New York, NY 10079 and additional mailing offices. POSTMASTER: Send address changes to Radio World, P.O. Box 282, Lowell, MA 01853.

For custom reprints & eprints please contact our reprints coordinator at Wright's Media: 877-652-5295 or NewBay@wrightsmedia.com

Globe graphic ©iStockphoto.com / Edward Grajeda

Copyright 2014 by NewBay Media, LLC.
 All rights reserved.
 Printed in the USA



New Program Codes for RBDS, HD

More tuners should recognize Spanish-language, hip-hop formats

BY ALAN JURISON

More engineers would like to use some of the new format codes adopted as part of the Radio Broadcast Data System standard in the United States in 2011.

The standards document for RBDS in the United States was revised that April when NRSC-4-B was finalized. As part of that, the new Program Type (PTY) codes 24 (Spanish talk), 25 (Spanish music) and 26 (hip-hop) were introduced.

Full adoption of these three codes requires participation of three major groups:

Receiver Manufacturers should be encouraged by broadcasters to review NRSC-4-B to see the changes. The new PTY codes are important because as the demographics of the United States change, so too does radio programming to serve growing ethnic populations.

An increasing number of stations are airing programs in Spanish. Similarly, the hip-hop format is very popular.

also other non-owned partner stations, there were approximately 124 terrestrial stations that identified as in the hip-hop and R&B category in late November. This category includes hip-hop, urban AC, R&B and stations that provide a mix of this genre. Of those 124, 57 (46 percent) identified themselves as primarily hip-hop stations in their positioning statements.

Radio receiver manufacturers are key here. With limited radios on the marketplace supporting the new codes, broadcasters lack significant incentive to transmit them. Stations are ready to implement the codes but need the help of receiver manufacturers to provide a better experience for their customers and our listeners.

Broadcast Equipment Manufacturers should update their product designs to support these codes, including those that manufacture RDS/RBDS encoders, HD Exporter/Importer equipment and broadcast monitoring receivers. Confirming that the equipment can transmit and decode PTY codes 24, 25 and 26 properly is important.

Similarly, manufacturers should



In Figs. 1 and 2, the station is transmitting PTY=26 for hip-hop. Notice in Fig. 1 that the area circled in red is blank because the older JVC KW-NT3HDT receiver was made before PTY Codes 24, 25 and 26 were defined in NRSC-4-B. The newer model JVC KW-NT810HDT, Fig. 2, shows hip-hop because it supports the new codes.

This update also affects HD Radio, for HD SIS Program types 0-31, NRSC-5C (document SY_IDD_1020s) states: "See the RBDS Standard, NRSC-4." Thus, NRSC-5 will always be in sync with the PTY codes in RBDS. Obtain a copy of the NRSC-4-B standard at <http://nrsccstandards.org/standards.asp>.

It's been more than three years since the new Program Type codes were adopted, so I set out to do some limited testing of this support. Even in some of the latest receivers I have available for testing, support for these new formats seems to be limited. That's not to say some receiver manufacturers haven't implemented the new PTY codes, but like many things, it takes a while for changes to standards to be adopted by the industry. Receivers that do not support these new PTY codes often show a blank, no information, in place of the station format, as shown in Fig. 1.



In the United States, there were 11,339 total licensed commercial AM/FM radio stations in 2013, according to the FCC. Of those, 956 were Hispanic-formatted in 2013, according to BIA/Kelsey. That compares to 853 five years ago and 696 in 2003.

Industrywide numbers for the hip-hop format are harder to locate, mainly because the industry traditionally has considered hip-hop as R&B. But, over the years the hip-hop genre has come to be a major part this category, thus why stations were asking for a hip-hop PTY code.

On the iHeartRadio streaming platform, which contains owned and operated stations from iHeartMedia, and

update setup programs or the graphical user interface to include these formats. Since many station engineers refer to their product manuals when configuring devices, the associated documentation/manuals should be updated to help broadcasters transmit these codes.

I have found that many encoders can easily be set to the new codes, but much of the documentation aspect of this has not been updated. That being said, I encourage equipment manufacturers to conduct full end-to-end testing to ensure products are NRSC-4-B compliant.

Broadcasters should request that their equipment vendors support these

(continued on page 5)

This Educator Is an Aggie Over IP

Wayne Pecena is recipient of Radio World Excellence in Engineering Award

We often hear that radio broadcast engineers must expand their IT literacy.

I know of no person who has helped others make that happen in recent years more than Wayne M. Pecena, recipient of the 2014 Radio World Excellence in Engineering Award.

He is director of engineering at Educational Broadcast Services in the Office of Information Technology at Texas A&M University. It operates KAMU(TV) and KAMU(FM); but if you know Wayne's name, it's probably through his diligent efforts to educate engineering colleagues about the basics and nuances of networking technology.

TRAINING

Pecena was already active locally in the Society of Broadcast Engineers, but his career took a turn a few years back when the organizer of an SBE Ennes Workshop in Dallas called in a panic after a presenter dropped out. The chapter chairman asked if Pecena could help find someone to talk for three hours about IP networking; he volunteered.

In the audience that day were Fred Baumgartner, who has long been active in

SBE education efforts, and Kimberly Kisel, then the society's education director.

"I guess they liked what I did," Pecena told me.

Over the subsequent several years, Pecena has created or led more than 30 educational events about networking technology and IPv6 for broadcasters. He's given short online tutorials and webinars. He has led in-person presentations that last up to a day and a half. When I spoke to him, he had just completed one for the SBE chapter in Miami.

This is all part of a larger expanded effort by SBE to create educational resources for its members. He now serves on the society's national board and executive committee, and he chairs its education committee.

BACKGROUND

Wayne Pecena was born in Paris, Texas, in "Tornado Alley," near Oklahoma on the West Gulf Coastal Plain. He grew up listening to the big AM signals of stations like KLIF in nearby Dallas and WLS from distant Chicago. His interest was piqued in high school when he worked in a local radio/TV repair

shop and became a ham radio operator.

"My 'Elmer' was David Ward, a gentleman whose family owned a broadcast station in northeast Texas," he told me. Ward's father Winston owned KIMP as well as a station in Idabel, Okla.

"I didn't per se work there, but I hung around there a lot. It was pretty fascinating. One of the treats was going to Oklahoma to do the annual proofs. Also doing Marti remotes. That was really fun stuff. I still enjoy going on remotes."

After high school, he moved to College Station in 1971, a drive of some 280 miles to the south, to attend Texas A&M. He wasn't planning to stay there long-term, but the choice of school turned out to be his choice of career.

In 1973, he joined the university's public broadcast station KAMU(TV) as a student worker; he eventually became full-time and obtained his FCC First Phone. When he graduated with a business degree, the job market was soft, so he decided to keep the university job and work on a Master of Science in industrial technology.

Over the years, and with mentoring from people like local engineer Casey

FROM THE
EDITOR



Paul McLane

HONOR ROLL

Recipients of the Radio World Excellence in Engineering Award represent the highest ideals of the U.S. radio broadcast engineering profession and reflect those ideals through contributions to the industry.

2014 Wayne Pecena
2013 Marty Garrison
2012 Paul Brenner
2011 Barry Thomas
2010 Milford Smith
2009 Gary Kline
2008 Jeff Littlejohn
2007 Clay Freinwald
2006 John Lyons
2005 Mike Starling
2004 Andy Andresen

Jones, he would rise to become the station's chief engineer, then director of engineering.

(continued on page 5)

So many consoles, products and platforms all support the StudioHub+ plug-and-play solution for fast and easy integration.

StudioHub+ inside

Radio Systems, Inc • 601 Heron Drive, Logan Township, NJ 08085 • 856-467-8000 www.studiohub.com

ARRAKIS

AXIA

VistaMax

AUDIOARTS

AUDIOSCIENCE

Wheatstone

SAB

radio SYSTEMS

LAWO

Logitek

FE

BROADCAST TOOLS

DECEMBER 3, 2014

NEWS

Skotdahl: AM Band Needs Drastic Change	1
New Program Codes for RBDS, HD	3
This Educator Is an Aggie Over IP	4
News Roundup	8

**FEATURES**

Keep Computer Towers Cool, Accessible	10
Repair a High-Voltage Blocking Capacitor	12
Check Out These Hot Audio Apps	14
RW Excellence in Engineering Award 2014	15
Gurenberger Finalizes His E-book About AT&T and Radio	18
Who's Buying What	18
Wendell Morrison and the "Antennalyzer"	19

GM JOURNAL

Step Up and Be a Trailblazer	21
Monte Sieberns Paints Auditory Pictures	22
People News	23

**STUDIO SESSIONS**

Does Microphone X Have It All?	24
Herb Goldberg Devices	26

OPINION

Go West, Young Broadcaster!	29
-----------------------------------	----

(continued from page 4)

DISTANCE LEARNING

His first major facility project was to put the university's FM station on the air starting in the late 1970s.

In later years KAMU went through the digital TV transition. It would eventually add HDTV and HD Radio; indeed KAMU was first in its market to air digital TV or digital radio.

But his interest in networking grew through building a distance learning system.

In the 1980s, Texas A&M (the former Texas Agricultural and Mechanical College) developed an interest in distance learning, spurred by the availability of grant money from the Department of Agriculture. Other land-grant institutions were doing the same.

In such a system, a campus TV station would distribute specialized educational video content via a satellite uplink; students could view the content at remote sites equipped with receivers, giving feedback and sending questions by phone or fax.

"That put us into the distance learning business fairly early on," Pecena said.

The network evolved as video conferencing began to mature; terrestrial data networks evolved into ATM networks, which evolved into an IP environment. Because he was hands-on, creating these networks, "I had to learn this stuff if I was going to keep doing what I was doing."

A core group of three technical managers led the effort. Pecena was one; another came from a telecom background; a third handled administrative and financial matters.

The network that began as a distance learning system today is essentially the intranet of the Texas A&M system, with 12 remote campuses and approximately 160 sites, supported by a large multi-gigabit IP backbone. The system was called the Integrated Services Network; it later became the Trans Texas Video Conferencing Network. Now it's TTVN. But what had begun as a distance learning/video conferencing network has grown into a large IP network.

PROGRAM CODES

(continued from page 3)

new codes and raise awareness of their desire to transmit these new PTY codes on applicable stations. Similarly, broadcasters that communicate with receiver manufacturers should encourage them to look at the new codes and consider updating their designs.

I think in time, as information about these new PTY codes continues to spread, we will see increased adoption from receiver manufacturers. Once a

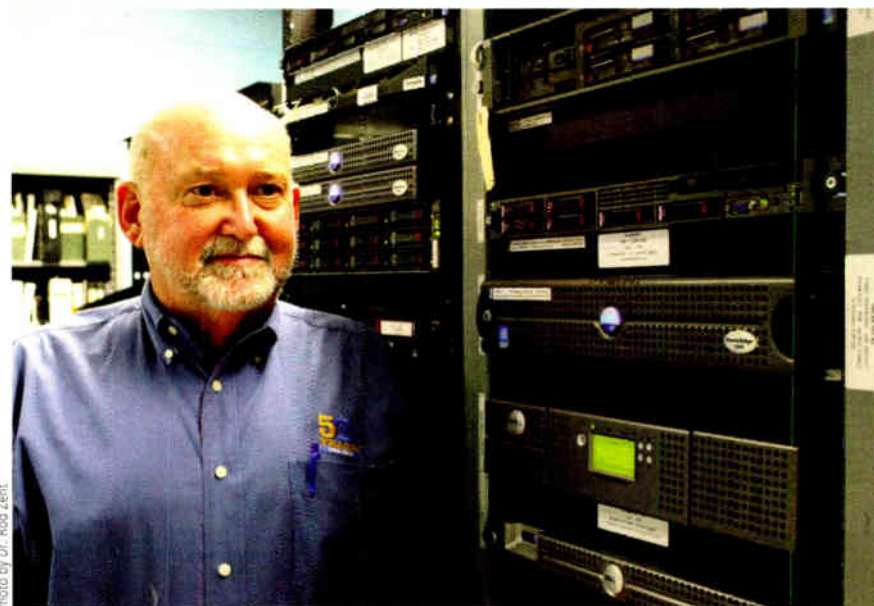
**Wayne Pecena in a familiar environment: a room full of servers**

"We do videoconferencing, H.323 style stuff, broadcast-grade video between different campuses. We feed programming. There are several radio stations within the A&M system; we feed audio around that backbone." Each campus has its own IT department, and Pecena's operation acts as something like an internal ISP.

Today he oversees a staff of 14 engineering and operations people, including a radio/TV chief engineer position, currently vacant. The operation also employs student workers.

Professionally, the educational environment tends to be more stable than commercial broadcasting. Still, "The industry has changed for everyone. If I look around town, the way things changed from 20 years to now, there are more radio station licensees on the air in this area, but at the same time there are fewer entities operating those stations due to consolidation."

Are students today interested in radio, and in radio engineering? "There are a lot of bright, sharp students out there," said Pecena, who isn't teaching but works around students frequently. "We don't seem to have the technical-oriented stu-

critical mass of updated receivers is on the market, broadcasters can transmit the new codes that are more appropriate for the growing number of stations for these radio formats.

This is a continuation of our series "Get the Most Out of RDS." Read past articles at www.radioworld.com/rds.

Alan Jurison, CSRE CBNE AMD DRB, is a senior operations engineer for iHeartMedia's Engineering and Systems Integration Group. He chairs the NRSC RDS Usage Working Group. His opinions are not necessarily those of iHeartMedia, the NRSC or Radio World.

dents that we did at one point in time; but from the production standpoint, radio/TV is still showbiz. That part hasn't really changed.

"You have the few who rise to the top, that have an interest in the tech as well as the art and skills of the production side — whether it's radio or TV or both." Still, gone are the days when everyone on the engineering staff was a ham radio operator.

FUTURE ENGINEERS

He also senses a shift in the makeup of the broadcast engineering community, which has implications for the SBE. Much of the society's focus has been to educate traditional broadcast engineers, who typically have backgrounds in RF, audio and video, about IT and IP networking.

"If you look forward, I think you'll see the next generation of broadcast engineers coming from a traditional IT background." He sees this as an opportunity for the society to educate that generation in certain basics that seasoned broadcast engineers may take for granted, having learned about them from mentors or on-the-job experience.

Yet if the new generation is going to come from IT ranks, broadcast managers may have a wakeup call coming about the cost. "Salaries for entry-level IT people in some cases exceed the salaries of seasoned broadcast engineers," he notes.

FUTURE INFRASTRUCTURE

I asked Wayne where he sees our industry going next.

"I think the next tech shift is going to be the radio station in the cloud, where the technical infrastructure we take for granted is in the cloud, and connected to that cloud is the terrestrial transmitter. ... I don't have a good crystal ball; but I can see a time when what we think of

(continued on page 8)

SKOTDAL

(continued from page 1)

issues for now; but how long will it last against an electromagnetic barrage that is indifferent to analog or digital on the AM band? The industry appears poised to forge ahead with AM digital, as opposed to VHF migration; so, the next question becomes whether consumer adoption can occur quickly enough to realize the benefits.

We tried to buy consumer tabletop AM HD Radio receivers ahead of our all-digital test broadcasts. None were available — not at Best Buy, not on Amazon, nor were any used radios available. Zero. And there has never been a portable HD Radio-enabled AM receiver.

No digital AM band receivers (let alone analog) will ever appear in cell phones because of chip interference and lack of real estate for an antenna.

Meanwhile, in Seattle, receivers with HD Radio technology of any kind represent only 5 percent of the market after 10 years of effort.

Consider that for analog FM, consumer adoption and receiver penetration took nearly five decades. Given the current trajectory of HD Radio-enabled receivers — and absent a digital receiver chipset mandate, or at least an FM digital transmission mandate that brings AM chipsets on its coattails — we likely would need three decades to achieve critical receiver mass so AM stations could go all-digital with a sufficient installed base of receivers.

DIRECTIONAL ISSUES

Further, even if 100 percent of Americans today had a radio with an HD Radio chip, a mandated conversion to all-digital on the AM band would be an immense burden on licensees of directional stations.

Compared to omnidirectional stations, AM digital implementation on directional stations is far more costly depending upon the age of the facilities and the number of radiating elements in the array.

And digital implementation costs are asymmetrical from one directional facility to the next. For example, there are directional AM stations with short-spaced radiators that would have to relocate their radiators physically to

The author is shown in 2010 conducting an inspection at the top of KRKO's newly replaced radiator. The year prior, two towers had been brought down by a vandal using an excavator.

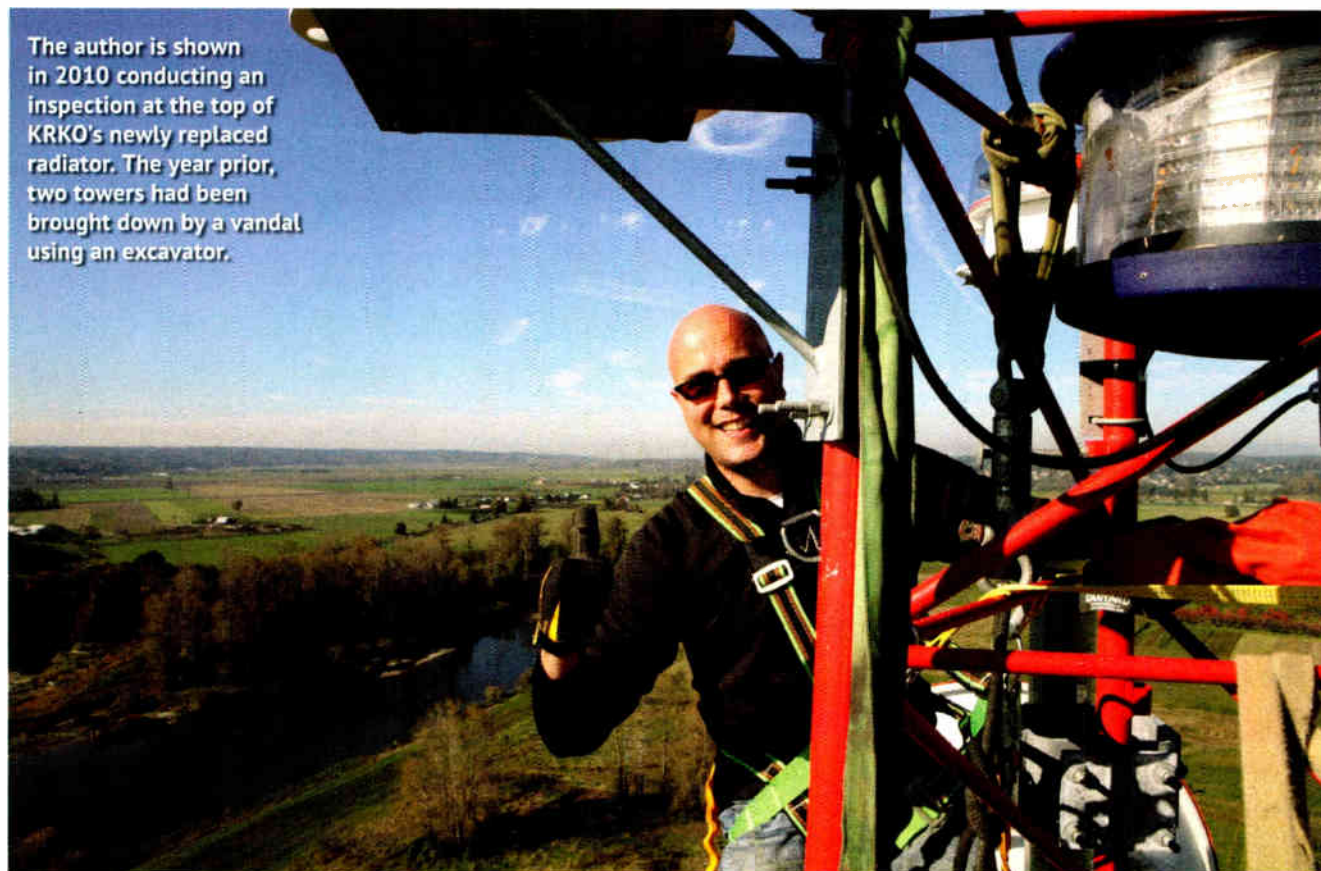

make digital work. That's like building a new directional antenna from scratch, an awful proposition.

These issues are not insurmountable; but a mandated all-digital implementation could cause a significant number of directional licensees to turn their stations off when faced with the specter of investing to make their facilities ready to pass digital.

SUNRISE OR MIGRATION?

What about an AM "digital sunrise" process, in which all-digital stations would operate on the band alongside analog signals, at least for some period of time?

This would be a mixed bag at best. All-digital is far more robust than current hybrid transmissions. But the sunrise scenario could make the band sound worse to listeners with analog-only radios and could hasten audience flight.

All-digital signals on the AM band sound like 1990s phone modem noise to analog radios (remember the "whoosh" sound after the handshake?). The sound is audible in the sidebands of stations using the technology now. The benefits of stereo separation, better coverage and signal consistency would be realized only by the small portion of the population capable of receiving the all-digital transmissions.

A more elegant solution would be to use the next four decades to migrate occupants of the AM band to abandoned VHF spectrum, meaning current Channels 1–6, and simplify the user experience.

How might this work? The commission could require licensees to broadcast in digital on the FM band from the moment they turn on their new transmitters as the "spectrum cost" of migration. Stations would be allowed to simulcast their AM signals until some future day that the FCC retires the AM band. This would provide further

chipsets). This can set the stage for addressing the needs of the AM band. While the commission is at it, AM auction windows should be ended permanently.

An all-digital mandate on the AM band could push a large number of directional operators — half or more — out of business, depending on the timing;

If vacant VHF is off the table for licensees of the senior band, there are some ways to get AM to the all-digital altar.

incentive to receiver manufacturers to produce chipsets capable of receiving HD Radio or Digital Radio Mondiale, a topic for a later discussion.

FM ANALOG SUNSET

But if vacant VHF is off the table for licensees of the senior band, then we need to pursue the idea of an all-digital transition, and there are some ways to get AM stations to the all-digital altar.

An "analog sunset shot clock" for the FM band is the fastest way to drive receiver manufacturer implementation and FM adoption. Digital technology works really well on the FM band and takes little to implement. How does this help AM stations? A mandate that all FM stations go digital would facilitate more rapid receiver deployment (presumably with mandated digital AM

because the bulk of AM stations in the United States are running with worn-out equipment and transmitter sites, and the revenue supporting those stations is too thin in many markets to justify new investment. The mandate would cull those who can't or won't make the upgrade, helping the transition.

But while all-digital on AM will make the band competitive, licensees shouldn't be forced into bankruptcy to do it; incentives would be required.

If we decide digital is the future of the band, we will need to craft a plan to push for significant tax incentives or other rewards for licensees who don't wish to go digital to turn in AM licenses. We can't bifurcate the AM band into digital and non-digital stations.

Perhaps the incentive is some form of

(continued on page 8)



STAC VIP

VoIP TELEPHONE TALKSHOW SYSTEM



Change is inevitable. Antiquated POTS phones are being replaced by smartphones and VoIP. This is a great thing for radio provided that you have a caller management system designed to take advantage of the new technology. Enter the STAC VIP Telephone Talkshow System. With features like PBX integration, advanced web-based call screening and high-quality (HD Voice) caller audio, STAC VIP brings heroic performance and value to your station. Take traditional POTS calls while allowing VoIP and SIP callers to sound like they're in the studio with you. *Contact a COMREX dealer to learn more!*

19 Pine Road Devens, MA 01434 www.comrex.com

COMREX
BROADCAST RELIABLE
World Radio History

www.comrex.com 1.800.237.1775



SKOTDAL

(continued from page 6)

deferrable, dollar-for-dollar reduction in tax payments, predicated upon the population of listeners within the daytime 0.1 mV/m contour of a station based on M3 conductivity multiplied by a cost-per-listener based on FM valuations. AM licensees would turn in their licenses for this kind of lucrative incentive. Licensees who turn in their licenses deserve meaningful compensation to exit.

Licensed AM spectrum surrendered for tax incentives should never be used for radio again. When the surrender period is over, remaining stations should be allowed to improve their facilities by increasing power or moving where possible. And it's been suggested some kind of low-cost industry financing could be put in place to get the equipment out to stations and facilitate upgrades.

With these kinds of plans in place and with national digital receiver penetration presumably by that time above 75 percent, an analog AM sunset could be implemented 20 to 30 years from now and licensees could weigh which way they want to go, meaning they'd have a choice of migrating or taking the incentive to go silent.

Frankly, if we got lucky and went from

PEGENA

(continued from page 5)

as the radio station is nothing more than a sales office, and audio production is done on something as simple as an iPad or some kind of computer device. You need that local microphone; but that infrastructure, that rack room we all have? I can see that not existing anymore."

He expects corporate broadcast operators to continue to push for regionalization and centralization, "even to the point of a service-type provider offering that radio station in the cloud."

PERSONAL LEARNING

Preparing this article, I touched base with Fred Baumgartner of SBE, himself a leader in industry training.

"Lifelong educators, people who honed their skills teaching in the classroom and focused on broadcast engineering — the Jim Wullimans, the Jay Adricks, the John Battisons — are extraordinarily rare," Baumgartner told me.

He recalls sitting "mesmerized" by Pecena's tutorial on networking for broadcast engineers. "Each year, Wayne has stepped up the level and intensity of the educational effort. All I know is that I don't ever remember learning more, in any manner, place or time, than when Wayne was in front of the house or on a webinar. Moving education for broadcast engineering forward has been a long road with many contributors. Wayne's contributions are exceptional ... and we are grateful."

4,700 AM stations down to 700 stations, the AM band, and radio, will be more sustainable.

BETTER IDEA

Sounds a little crazy doesn't it? Getting to an all-digital AM band is crazy, and it's why we should advocate for migration, and a digital mandate on the other end. Once you get FM spectrum for your AM, you should be required to implement HD; it can be HD the way it is now, with an analog main and digital HD1; but digital has to be baked-in from the start.

There is no doubt after our experiences with the testing that digital on AM is better than analog AM, for reasons you'll learn at the NAB Show in April. But the question remains: How long will that advantage last?

We'll continue our digital broadcasts because the warm sound quality, stereo separation and consistency of the digital signal benefit our listeners who have HD Radio-enabled receivers; but as an industry, we should only "go there if we must" because a better, truly permanent solution is before us in migration.

What do you think? Comment via email to radioworld@nbmedia.com with "Letter to the Editor" in the subject field.

Wayne Pecena still lives in College Station with his wife "Slyck," a former broadcaster, as well as "a four-legged Beagle daughter named Jill who lets me live in the house." In addition to his day job and SBE work, he is the vice-chair of the Public Broadcasting Service Engineering Technology Advisory Committee.

While he has more than four decades of broadcast, telecom and network engineering experience — and is a past recipient of the SBE Educator of the Year Award — Pecena puts his belief about education into ongoing practice. He holds five certifications from the society, including Certified Professional Broadcast Engineer and, yes, Certified Broadcast Network Engineer; he also has completed specialist certifications in 8-VSB, AM Directional Antennas and Digital Radio Broadcast.

And he continues to soak up what's around him. "I'm out doing classes at different levels, but at the same time I'm still learning too. Each class I do is an opportunity to reinforce how much I don't know. I hope some of the people who endure me for an hour or more get something in return. I know that I do.

"My first love is broadcasting; but as the broadcast world moves into the IT world, I seem to have ended up at the right place at the right time."

If you appreciate Wayne's efforts, you can tell him in person at the spring NAB Show; he's slated to give the opening tutorial at the SBE Ennes Workshop on Saturday April 11 in Las Vegas. Or write to me here at radioworld@nbmedia.com.

NEWSROUNDUP

CCSS: iHeartMedia has told clients that its satellite arm Clear Channel Satellite Services will stop providing satellite distribution services to other companies. Existing customer contracts will not be renewed, and CCSS is not accepting new customers, according to the company. "In the coming weeks, our team will be working with the existing customers to discuss the best way for a smooth transition to a new provider," stated a note to clients shared with Radio World. "Customers with soon-expiring contracts will have the option to continue their service on a month-to-month basis until we've found a suitable assignee for the business." A spokeswoman characterized the change as a strategic business decision. She declined to elaborate on this or further questions.

WSJ: Dow Jones will shutter The Wall Street Journal Radio Network, including the MarketWatch Radio Network, Dec. 31. In a memo distributed to employees, Dow Jones CEO William Lewis said the company "must do fewer things that are not core to our business." The company is moving away from terrestrial radio and expanding digital audio and print offerings. The WSJ Radio network is carried on some 470 radio stations, according to the programmer.

SPOTIFY: BMW and Mini drivers can now get music streaming service Spotify in their vehicles.



When iOS users of Spotify, both free and premium, download it from the Apple App Store, the Spotify app will be compatible with BMWs equipped with the BMW Apps option. After connecting a smartphone to the car and launching the app, a user must specify the BMW ConnectedDrive Services or Mini Connected option.

SPOTIFY/UBER: Premium Spotify users now can play their music through Uber car speakers in certain cities. In the Uber app, the user connects their Spotify account and requests a ride. He or she is paired with a Spotify-enabled Uber ride and can select music from Uber's playlists or from Spotify within the Uber app.

CRB: Pandora believes its webcasting rate proposal to the Copyright Royalty Board is fair and "will appropriately compensate recording artists," according to Pandora CFO Mike Herring and VP Business Affairs/Associate General Counsel Chris Harrison. Speaking to Wall Street analysts in November, they said the process is in an early stage and that a rate decision is likely around December 2015. Pandora says it has paid more than \$1 billion in webcasting royalties to SoundExchange. Its current licensing cost per ad-supported track is \$0.0013, which will rise to \$0.0014 in calendar 2015.

It proposes a new system under which it would pay the greater of the following two options each year: either 25 percent of annual revenue; or a flat rate per performance that in 2016 would start at \$0.0011 for a non-subscription performance and \$0.00215 for a subscription performance, increasing slightly over the next four years.

Herring said SoundExchange is proposing 55 percent of revenue. "In response to these exorbitant rates, Pandora would be forced to limit music play by approximately 75 percent to survive," said Herring.

GRACENOTE: Tribune Media subsidiary Gracenote wants to link traditional radio and online radio more elegantly in auto infotainment systems. Gracenote has developed software to unify various music sources including AM/FM, CDs, satellite and streaming radio onto a unified center-stack display. The software helps identify what songs

are being played and the source in real time; that helps Gracenote provide the correct metadata to the display. Gracenote technology is in 65 million cars as part of automotive platforms like Ford Sync, Chevy MyLink, Toyota Entune and Hyundai BlueLink. The company says the new technology will be available for 2017 model-year cars.



From one Environment to another



Connect your Tieline Codec to the WheatNet-IP Environment*

Genie Distribution and Merlin PLUS codecs with WheatNet-IP seamlessly integrate with Wheatstone's WheatNet-IP Environment to deliver multiple mono or stereo IP channels.

The codec features a WNET LAN interface for connecting directly to a WheatNet-IP network and distributing audio over external IP networks like the public internet. Tieline WheatNet-IP codecs are also fully compatible with the AES67 standard for AoIP.

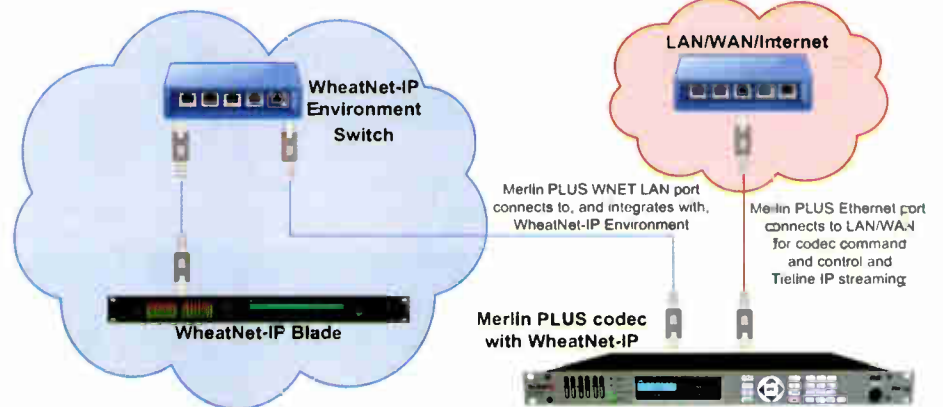

Contact Tieline today to find out more at 317-845-8000

Townsquare
Media's Mike
Hutchens



“ This simplifies
integration
making it easier
to set up
mix-minus
feeds. ”

Tieline 
The Codec Company

 **Wheatstone**

www.tieline.com

317-845-8000

* Only available with Merlin PLUS with WheatNet and Genie Distribution with WheatNet product range. Existing Genie Distribution and Merlin PLUS products are not upgradeable.

Keep Computer Towers Cool, Accessible

Also, a tip to help prevent damage caused by falling ice

WORKBENCH

by John Bisset

Read more Workbench articles online at radioworld.com

Bryan Waters, chief engineer for Colorado Springs' KIL0(FM) and KRXP(FM), was tired of heat killing his computers.

Most engineers mount computer towers inside rack cabinets or under the console, but the buildup of heat can cause eventual failure. Crawling around on the floor to get at the unit is just as much hassle.



Fig. 1: This sturdy bracket supports a computer shelf.

Bryan found some sturdy L brackets with sleek angled support arms and mounted them to the back side of the console cabinetry, seen in Fig. 1. The computer tower rests on the shelf, which is supported by the brackets. He can access the computer easily for any IT work; it's out in the open, so there is no heat buildup, and it's mounted high



Fig. 2: If the computer tower is enclosed, the shelf helps avoid cooling problems.



Fig. 3: The Swopper is a rugged office chair.

enough so you don't have to crawl on the floor to access it, as shown in Fig. 2. Since the computer is mounted at the rear of the console cabinetry, it's out of sight.

Bryan included a picture of cushioned bouncy stools used in each studio, Fig. 3. Found at the Relax the Back store (online at www.relaxtheback.com), the Swopper Office Chair comes from Germany. It can be adjusted for height, shock absorption (bounce) and lateral movement. It is an ideal jock chair, built

to withstand weights up to 290 pounds. There is also a Swopper on wheels. At an MSRP of \$699 the cost may seem a bit steep, but if you are going through multiple control room chairs in a year, it's worth considering.

If you've found a reliable chair model for your jocks (or your own workshop), send me the information to share with other engineers. Email johnpbisset@gmail.com and include a couple of high-resolution photos.

Reach Bryan Waters at bwaters@kilo94.3.com.

In the last column, we touched on the damage that can result from ice falling from a tower.

Since then, I've heard from several engineers who have used steel or aluminum stair treads to form an inexpensive, yet effective, ice bridge in order to protect their transmission lines.

Seen in Fig. 4, the treads are available from a number of sources.

Visit www.fsindustries.com and search for "stairs and stair treads." The site lists dimensions and pricing for the stair treads.

One in particular comes in a wide variety of styles and materials. Plus,

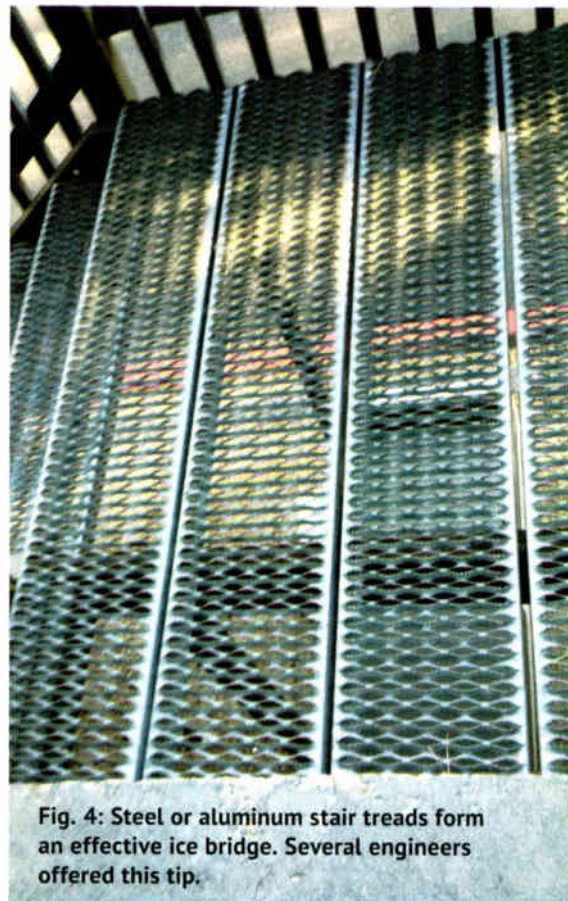

Fig. 4: Steel or aluminum stair treads form an effective ice bridge. Several engineers offered this tip.

many of the treads have bolt slots on each end, so the treads can be ganged together to form any length ice bridge.

Some tips are about the barest of basics.

Here's one from Townsquare Media's Andy Soule. A \$3 investment at Dollar Tree yields two packages of pencils and a pair of sharpeners, shown in Fig. 5.

Andy was annoyed by having pens and markers at his transmitter sites dry out, so he placed pencils at all of the



Fig. 5: Nothing is more basic, but a pencil in the right place can be a big help.

sites. He keeps personal logs and notes on equipment at each site. Basic? Yes, but having these pencils at hand saves time and annoyance in running back to the truck merely to grab a working pen.

The pencils also are good for making temporary marks on things. Reach Andy Soule at andy.soule@townsquaremedia.com.

Workbench wants your facility, project and workbench ideas. You'll help your fellow engineers and qualify for SBE recertification credit. Send tips to johnpbisset@gmail.com. Fax to (603) 472-4944.

Author John Bisset has spent 45 years in the broadcasting industry and is still learning. He handles West Coast sales for the Telos Alliance. He is SBE certified and is a past recipient of the SBE's Educator of the Year Award.



Radio Ahead
Digital AM & FM

On the road to HD Radio broadcasting?
Nautel has you COVERED.

nautel.com/HDradio 

Need a Little Extra?



Increase your reach with AARON 650.

Today's radio listeners demand more than ever: a cleaner signal, and in increasingly hard to reach locations. So what do you do when the average translator receiver just can't quite "grab it"?

Meet AARON 650, Inovonics' all-new premium FM Rebroadcast Receiver built to handle the most challenging reception scenarios. Boasting sensitivity, selectivity, and reception tools superior to even the most elite professional and consumer receivers, AARON's pristine off-air signal allows you to rebroadcast in new and far reaching places like never before.

Watch a live **YouTube** demo at:

www.inovonicsbroadcast.com/model/650

More input/output options:



AARON 650 Premium FM
Rebroadcast Receiver



- ✓ Unparalleled SDR (Software Defined Radio) receiver performance.
- ✓ Composite Pass-Through & Baseband Regeneration modes.
- ✓ Advanced Metering including an FFT Baseband Spectrum Analyzer, BandScanner™ and Left/Right XY Plots over time.
- ✓ Active reception processing for Bandwidth, Stereo Blend, HF Blending, Multipath mitigation and more.
- ✓ Remote Web access with off-air listening over IP.
- ✓ Failover audio via SD Card and Web-stream backup.

Repair a High-Voltage Blocking Capacitor

What to do when there's no spare

TECHTIPS

BY MARK PERSONS

What do you do when a high-voltage blocking capacitor in an FM transmitter fails?

We are talking about the large cylinder that surrounds a tube. It is actually one aluminum cylinder within another, with insulating (dielectric) material in between. The purpose is to transfer RF energy from the tube anode to the

output-tuning network without shorting high-voltage DC to ground. That direct current often is connected directly to the tube via a clip on the anode.

So there you are with a shorted blocking capacitor and no replacement on the shelf. (Why would the station have a spare when they fail only once in 20 years or so?)

My story goes back to a cold day in January, when it took a farm snowplow to clear a road to a transmitter site (Fig. 1). Such is life in Minnesota during the winter.

Fig. 2 shows the charred remains of a PA tube, a driver tube and a high-voltage blocking capacitor from a CCA FM2500B FM Transmitter. The normal tube appearance is of nickel-plating, not brown-red. The blower motor quit, but the transmitter kept running when the airflow switch stayed in the on position. The switch worked normally when tested a year before, so I can only assume it stuck from being on for a long time.

NO SPARES

This transmitter normally runs 2,200 watts using a 3CX400A driver tube and 3CX3000A7 PA tube. The client keeps

spare tubes on the shelf so that was not a problem, but who keeps an extra blocking capacitor? Since there was no spare, the only option to avoid two days of off-air time was to rebuild the original capacitor. This particular type of capacitor was not designed for rebuilding, but what else was there to do?

It's not rocket science!

I took the capacitor to the shop and used a hacksaw to cut through the outer cylinder and just into the dielectric between the outer and inner cylinders.

After unwrapping and exposing the original dielectric, I found an arc-over spot. Now the real work began.

Plenty of cleaning was needed to get sharp edges and other blemishes down

(continued on page 14)

Images courtesy Mark Persons



Fig. 1: It's cold here in Minnesota.



Fig. 4: Note the arc-over spot.



Fig. 7: Measure capacitance to confirm it is right.



Fig. 2: These items have overheated.



Fig. 5: Clean to smooth rough edges.



Fig. 8: Here's the reassembled blocking capacitor ...



Fig. 3: Hacksaw the outer cylinder.



Fig. 6: Use some of the Kapton material you keep on the shelf.



Fig. 9: ... and the blocker is back in the transmitter.

HIGH CAPACITY EVENT STUDIO TRANSMITTER LINKS



outdoor unit



TAKE ADVANTAGE OF WIRELESS HIGH PAYLOAD STL/TSL CAPACITY

Moseley EVENT STL/TSL systems provide up to 155 Mbps combined IP, T1/E1 payloads. Multi-station clusters can convey multiple linear uncompressed audio pairs for a truly cost-effective STL/TSL link. Connect your existing T1/IP audio hardware directly into the EVENT system, or use Moseley Rincon for your audio payloads. An optional DVB-ASI module is available for full duplex video.

EVENT systems are fully bi-directional including a Software Defined Indoor Unit (SDIDU) and Outdoor Unit (ODU), eliminating the need for costly waveguide hardware. The ODU is available in the license free 5.8 GHz band, or licensed 11, 18, or 23 GHz bands. Appropriate external antennas are selected based on path length.

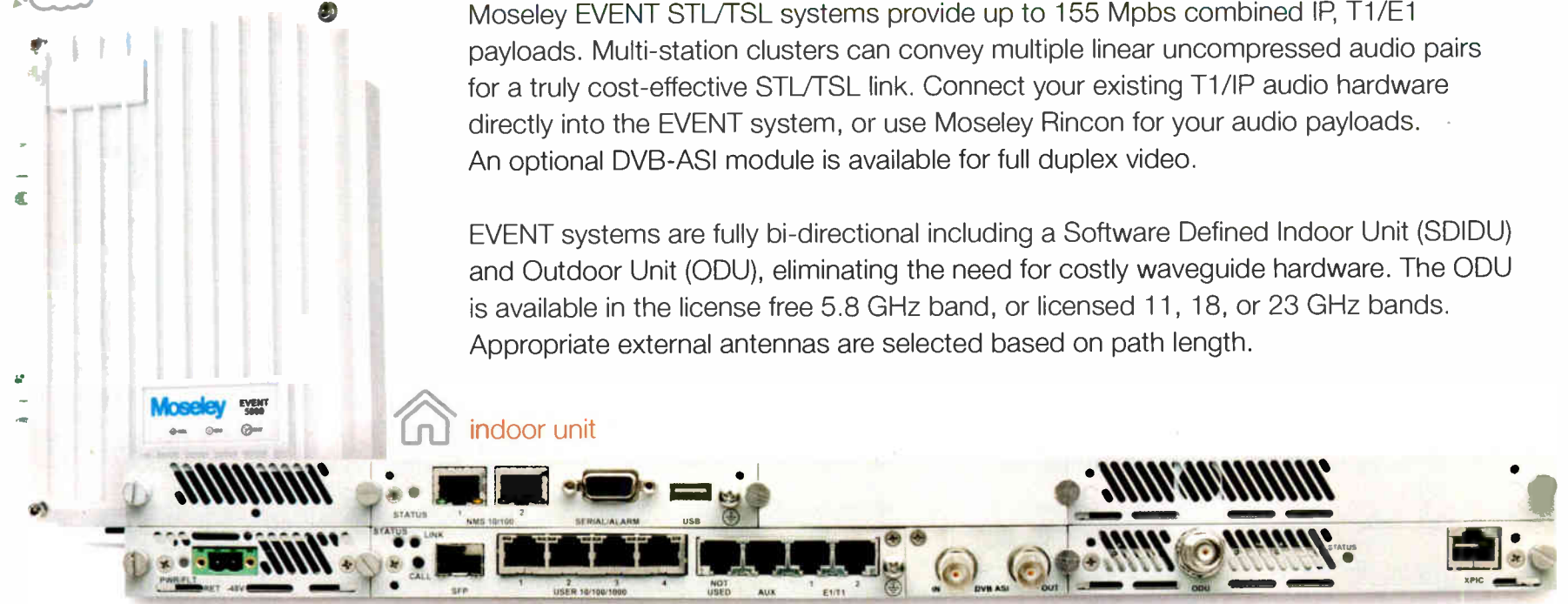

indoor unit

INTELLIGENT SYSTEM DESIGN

Spectrum-scalable digital radios with user-selectable data rates enable broadcasters to have greater flexibility in STL planning and future growth. The integrated T1/E1 and Ethernet interfaces allow for a combination of T1/E1 and IP packet data.



IP APPLIANCES AND APPLICATIONS

Offer IP transmitter control, surveillance security, and site monitoring to reduce downtime, and protect valuable station assets while saving travel time to the site.

REMOTE MIRRORED SERVERS

From the transmitter site, offers backup of business records and programming content to get you back on the air quickly in the event of a studio outage.



EMAIL AND INTERNET ACCESS FROM THE TRANSMITTER SITE

Saves engineers time accessing manuals or technical support from manufacturers during maintenance sessions.



SIMPLE NETWORK MANAGEMENT PROTOCOL (SNMP)

Full SNMP package with GUI provides easy monitoring and configuration changes.

Contact The Moseley Sales Team to Custom Configure Your EVENT STL/TSL Today!

moseleybroadcast.com

Check Out These Hot Audio Apps

Technology innovations provide more than new platforms

WHAT'S NEXT

by James Careless

Audio apps are a hot trend that radio broadcasters need to know about, not just because they stream radio content. Thanks to their interactivity and wide availability, audio apps are becoming a popular platform for experimenting with new content delivery ideas and models — the best of which could potentially be incorporated into effective radio apps.

TALK BACK TO YOUR RADIO

Many radio listeners talk back to the ads they hear. Now XAPPmedia (xappmedia.com) has found a way to harness this backtalk with XAPP Ads.

An XAPP Ad combines the audio of a conventional radio ad with smartphone interactivity: At certain times, the listener using a mobile audio app — such as that of XAPPmedia client NPR — is played an ad, then asked if they want to respond to it by saying phrases such as “call now,” “download app” or “send email.” The user’s smartphone microphone is turned on at that point, and any verbal responses go to XAPPMedia’s servers for immediate action.

“It is difficult for traditional radio ads to generate or even measure direct engagement or conversion for advertisers,” said XAPPmedia Chief Marketing Officer Bret Kinsella. “XAPP ads are so simple that consumers interested in offers convert instantly. Consumers don’t have to stop what they are doing to make a phone call or do something else to claim an offer. They simply speak.”

MORE SPORTS THAN EVER

College sports is a natural niche media application and is suited to audio apps. This fact has not been lost on streaming audio provider TuneIn Radio (www.tunein.com). Their audio apps for Android/Blackberry/iPhone/Windows smartphones, Amazon Kindle/Android/iPad tablets and Logitech/Panasonic/Roku/Samsung/Sonos SmartTV systems now carry every play-by-play broadcast and additional college football content from 19 Learfield Sports’ university partners, including Alabama, Wisconsin, Louisville, Texas A&M and Penn State, ultimately increasing TuneIn’s coverage to some 85 college teams.

“We acquire and distribute the audio very much like a standard radio affili-

ate, with one exception: All our stations are digital-only, of course,” said TuneIn spokeswoman Siobhan Murphy. “Through the first eight weeks of the season, we have seen over 3.7 million

or Apple iTunes directly in their tweets.

“With a single tap, the Twitter Audio Card lets you discover and listen to audio directly in your timeline on both iOS and Android devices,” wrote Twitter

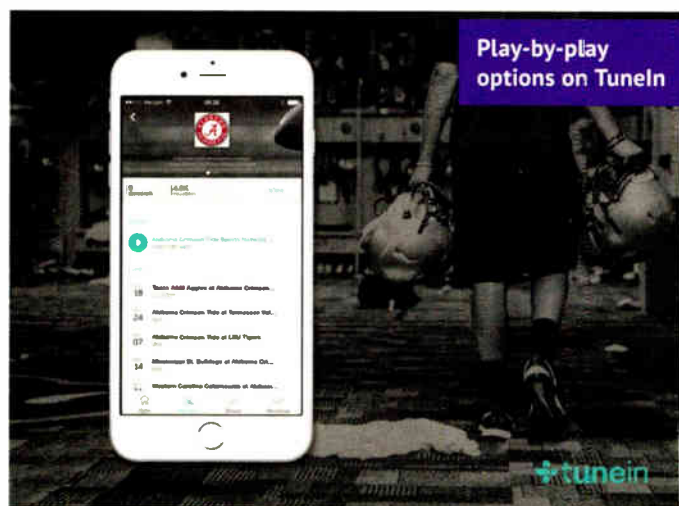

session starts, over 2.8 million unique listeners and over 1.6 million listening hours. Our 85 stations are now followed by more than 200,000 users in total from all over the world.”

TWEET ME AUDIO

Apparently 140 characters is not enough: Twitter has added tappable audio capability to its app, courtesy of the Twitter Audio Card. The idea is simple: Twitter users can now directly embed audio content from SoundCloud

Product Manager Richard Slatter on the Twitter blog. “Throughout your listening experience, you can dock the Audio Card and keep listening as you continue to browse inside the Twitter app.” This feature is being employed by Coldplay, the White House and the BBC World Service to share audio content.

OLD DOG DOES NEWS TRICK

The cliché is wrong: You can teach an old dog news tricks.

The proof: The 138-year-old Farm

Journal is launching an app called My Farm Radio, which will serve as a ‘round-the-clock source of news, weather, markets and talk aimed at farmers and ranchers. The app will connect listeners to live and on-demand content.

“All the latest research indicates that, for a growing number of farmers and ranchers, mobile devices are rapidly becoming the go-to choice for news and



Twitter audio cards

information,” said Brian Conrady, senior vice president/general manager of Farm Journal Radio. “While this totally new offering will be a first for agriculture, we expect our audience — and clients — will quickly associate My Farm Radio as the Pandora-type app for agriculture.”

The app is being offered for Android and Apple platforms and can be downloaded at www.myfarmradio.com.

James Careless is a longtime contributor. Send ideas for What’sNext to radioworld@nbmedia.com

REPAIR

(continued from page 12)

to prevent future arc-overs. A file and 3M Scotch-Brite scouring pads worked well here. I remember hearing of someone who replaced dielectric material without removing the sharp edges, only to have the same arc problem immediately again!

I found new Kapton dielectric material on the shelf at a nearby station and wound it onto the inside cylinder of the blocking capacitor; then the outer cylinder was put back on. This thin Kapton sheet is 4-3/4 inches wide and is used by Continental Electronics in its transmitter blocking capacitors. At less than \$90 from Continental, it is worth keeping some on the shelf. A complete blocking capacitor, which includes the two metal cylinders, costs \$450 to \$1,500 depending on which transmitter and manufacturer you order one from. Kapton has a reddish-brown color, as opposed to the original clear-white, which was probably Teflon, in this case.

The original capacitor had six turns of dielectric sheet, but capacitance testing, using a Sencore Z Meter, showed that was one turn too many with this new material.

TESTING

The proof is in the capacitance of the assembly. Here the rebuilt blocking capacitor measures very close to the

original 550 pf. Yes, I was able to determine the capacitance of the original shorted capacitor because testing was with just a few volts, rather than the normal 4,000 volts in the transmitter.

Two stainless steel hose clamps were used to hold the outer cylinder tight on the dielectric. Stainless is not ferromagnetic. I pointed this out in a December 2013 article in Radio World (“Fix a Transmitter Tube Socket,” radioworld.com, keyword Socket). This is important as anything that is attracted by a magnet in a high RF field will tend to vibrate at the RF frequency and sometimes melt. Use an ordinary small magnet to verify that nothing in the RF area is attracted magnetically.

Fig. 9 shows the final assembly, back in the transmitter, just before high voltage was turned on. Yes, the outer parts of the blocking capacitor have an oxidized appearance. They are silver-plated and get to look that way from years of exposure to air. The oxidation does not hurt transmitter performance.

Success ... no arcs and the operating parameters came back to normal.

This is a permanent fix for the problem and the blocking capacitor is more repairable if this should happen again in the future. It makes perfect sense.

Mark Persons, WØMH, CPBE, has over 30 years experience. He has written numerous articles for industry publications over the years. His website is www.mwpersons.com.



RADIOWORLD

EXCELLENCE IN ENGINEERING AWARD

2014

PRESENTED TO

WAYNE M. PECENA

TEXAS A&M UNIVERSITY



Comrex commends you for your service to the SBE and broadcasters everywhere. Thanks for making IP accessible. We need more good guys like you!



Congratulations, Wayne! It is much deserved; we admire your lifetime dedication and passion for the broadcast industry.



The entire team at GatesAir salutes your dedication to radio, and your passion and unique talent as a speaker, educator and IT engineer. We're a better industry with your presence!



Congratulations from the SBE, Wayne, for your leadership and dedication in providing educational opportunities for broadcast engineers.



Congratulations Wayne on your successful career in broadcasting, from your friends at Tieline, The Codec Company



It has been said that "a teacher affects eternity; he can never tell where his influence stops." Thank you for all you do, Wayne.



YOU COULD GET THESE VOICE PROCESSING TOOLS OF THE TRADE...



a



b



c



d



e

OR JUST CUT TO THE CHASE...



M4IP

a. GATES • b. DE-ESSERS • c. COMPRESSOR/LIMITERS • d. EQS • e. MIXERS & MORE x 4

ANYWHERE YOU NEED THEM ON YOUR NETWORK – FROM A SINGLE RACK SPACE

ALSO AVAILABLE: M-1, A SINGLE CHANNEL VERSION WITH ANALOG INTERFACE (BUT STILL WORKS WITH OUR GUI IF YOU LIKE)
AND M-2, A TWO-CHANNEL VERSION THAT WORKS ONLY FROM OUR GREAT GUI



Oh, The Voices - Part I: Tidying Up Talent Vocals

by Steve Dove, Minister of Algorithms

What you need to know about getting the most out of talent, from solving sibilance and noise issues to how to outsmart those tricky microphones.

The microphone processor has long been important but in recent years it has become vital. Mainly this is due to the recent trend of referencing audio to 0dBfs (the maximum signal level in a digital system) rather than the cozy old nominal 0dB VU. Most popular music releases are "normalized" or processed so that their highest peaks are at 0 dBfs, if they're not totally squashed and clipped to blazes up against that limit. Compared to a playout system crammed full of this and typed-up commercials, an unprocessed announcer's voice can seem quite wimpy and out of place.

Consider also the entire radio air-chain. Sitting ahead of the transmitter is usually a Very Serious Processor, which is generally set up (in a music format) to be optimal for music secondarily for voices. Presenting a processed voice that better suits the "big guy" can pay large benefits in on-air voice sound.

Other program distribution chans such as that produced by highly bit-reduced streaming codecs benefit from attention to the voice, whilst talk radio lives and dies by - voices. A good mic processor brings much to all these scenarios.

Let's run through the sorts of things we might want to do to a voice to tidy it up, improve listenability, and better integrate with today's technological expectations.

Get to the real meat of Steve's article...

Go to: INN17.wheatstone.com

It's a MAD, MAD, MAD, MADI World

MADI can act as a common transport mechanism between two systems that use different native formats. Our MADI interface seamlessly integrates WheatNet-IP audio network into an existing Wheatstone TDM router system so you can have the best of all worlds!

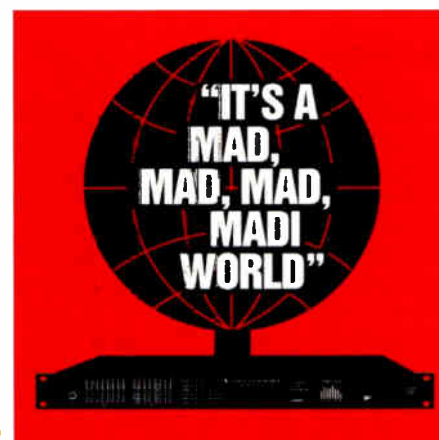

MADI's been around for a long time, so it's understandable if you have forgotten what this acronym actually stands for (which is, Multichannel Audio Digital Interface, also known as AES10).

But, don't lose track of how useful MADI can be to broadcasters. The list is fairly long, and getting longer. After all, there are very few alternatives for sending up to 64 channels of digital audio (48kHz sample) over one 75-ohm coaxial cable. Not only does this digital audio routing standard by AES make it possible to send a lot of channels through hundreds of feet of cable, it delivers lossless audio through all those channels. That lends itself to some practical applications.

Learn how MADI is making it possible to bridge the old and new worlds.

Go to: INN17.wheatstone.com



IPv6 and Networking

Your WheatNet-IP audio network will never require as many IP addresses as what's needed for the public internet. But the migration to IPv6 is something our technology partner Teline says you should keep in mind as you consider bringing in audio contributions from outside the studio.



We can say with certainty that you'll never run out of IP addresses for your private WheatNet-IP audio network.

The same can't be said for the public internet, which is migrating to IPv6 to keep it in IP addresses. The length of an IPv6 address is 128 bits, compared to 32 bits for existing IPv4 addresses - or that unique numerical string that's needed by every device to connect to the internet. Who would have thought that the internet would blow through 4.29 billion available IPv4 addresses, the last and final block of which was allocated not so long ago? IPv6 will give us, well, a whole lot more. It's the difference between being able to fill a golf ball versus the sun with IP addresses!

What does IPv6 mean to networked IP Audio?

Go to: INN17.wheatstone.com



Durenberger Finalizes His E-book About AT&T and Radio

BY PAUL McLANE

Our colleague Mark Durenberger has published the final version of his e-book "Connecting the Continent."

You may recall that Mark had produced an essay documenting AT&T's contributions to radio, inspired by an article by Radio World contributor James O'Neal.

"I came to realize that, while many of us grew up in a broadcast industry created in part by AT&T, there's no easily accessible access to the full detail of AT&T's contributions," Mark said then. "Furthermore, those with first-hand experience in an earlier analog world were retiring, and the heritage of experience with AT&T methodology was being lost. This might be a way to secure factual and anecdotal input from those who were part of that picture."

He made his e-book available for free and actively sought comments and suggestions for improvements. Now the final version is out, incorporating feedback from readers and an improved format.

Topics include the founding of AT&T; the introduction of "Long Lines;" the development of wireless; AT&T's broadcasting "experiment;" the evolution of national broadcasting networks; alternative methods of getting programming from station to station; the evolution of the VU meter; and the use of true "high-fidelity" audio transmission through the use of "carrier."

Mark spent 55 years in broadcast and satellite technology and is now supporting the technology/broadcast initiatives of the Minnesota Twins Baseball Club. He tells me his interest in "Ma Bell" was jump-started by a wide-eyed visit to a local "Toll Test" office at a time when the world was all wire. He adds that he is

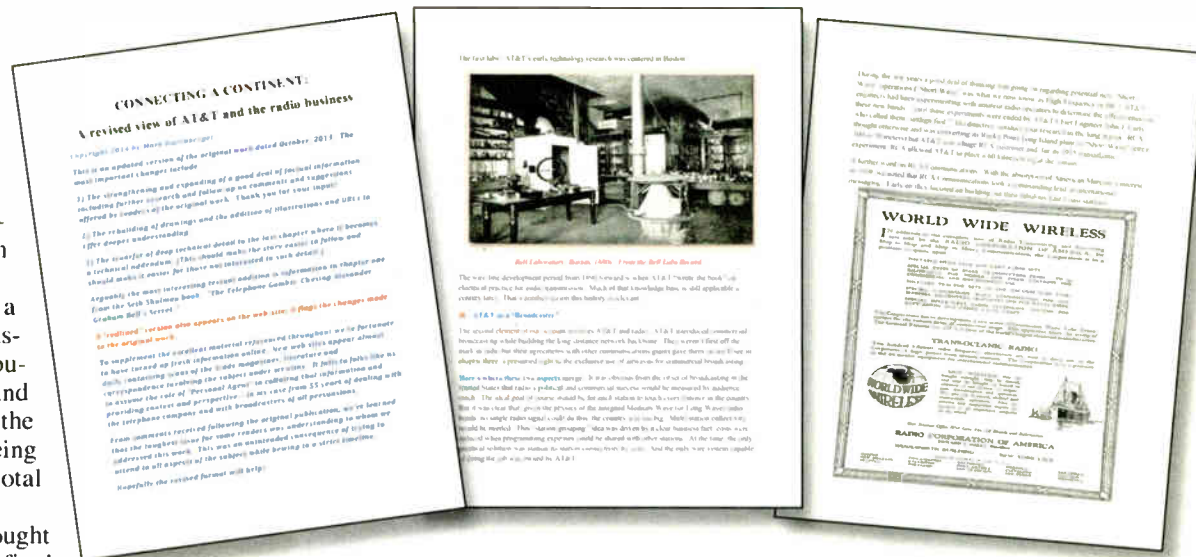

beginning work on a book demonstrating in detail the mechanics of distributing propaganda 1930 to 1950, from the Russo-Japanese War through "Duck and Cover."

Get a copy of the e-book at www.durenberger.com.

USB AUDIO IS THIS EASY WITH USB MATCHBOX II



HE HENRY ENGINEERING
USB MATCHBOX II™
 USB MULTI-MODE PROFESSIONAL CODEC

ON HEADPHONES INPUT OUTPUT

LEFT IN RIGHT IN LEFT OUT RIGHT OUT AES OUT

USB 48KHZ 24V For correct operation, set computer's "volume control" to MAXIMUM. PIN 5400

TO YOUR PC **TO THE REAL WORLD**

The ease of USB audio without hum, buzz, or sound-card headaches! Get true professional levels with lots of headroom, and an AES digital output too.

NO WALL WARTS!

DIGITAL SOLUTIONS. ANALOG SOLUTIONS. FUNCTIONAL. RELIABLE. AFFORDABLE.

HE HENRY ENGINEERING
 Visit www.henryeng.com for all of Henry's solutions!
 NEW Phone: 562.493.3589 • email: Info@henryeng.com



WHO'S BUYING WHAT

KFMC(FM) in Fairmont, Minn., this summer installed a 30 kW Flexiva transmitter made by GatesAir; now the manufacturer is highlighting the station's savings in operational costs. It said KFMC "has significantly reduced energy use and utility costs" since the install. The new solid-state unit replaced a tube transmitter that was put in about 30 years ago. Apparently, the local power company also gave the station a \$1,200 rebate because it could document "significant" long-term energy reduction.



KFMC's kW Flexiva transmitter

Lagniappe Broadcasting's KZRZ(FM), KXRR(FM), KQLQ(FM), KMYY(FM) and KJMG(FM) in Monroe, La., are the latest affiliates of Envision Networks' SpotVO and ExpressVO, a spot and voice production service that offers next-day, fully-produced radio commercials.

Digram will supply ATC Labs, a maker of codecs and audio processors, with sound cards from its lineup. The cards to be used by ATC are Digigram's VX222e and VX222HR cards and UAX220v2 USB interface. They will be used in ATC's Perceptual SoundMax hardware processors and ALCO Blue rackmount codecs.

Are you making changes to your studio or control room? Radio World wants to know! Send Who's Buying What news to radioworld@nbmedia.com.

Wendell Morrison and the “Antennalyzer”

Remembering a pioneer in joining computers and broadcasting

ROOTS OF RADIO

BY JAMES E. O’NEAL

Ever hear of an “Antennalyzer?”

No, I’m not referring to the popular little boxes used by ham operators to check antenna characteristics and impedance matching, but rather to an early analog computing device designed in the 1940s by Wendell C. Morrison, a career engineer at the Radio Corporation of America.

While Morrison was closely involved with a lot of broadcast product-related engineering work, including the development of a backwardly compatible color television system, it was his “Antennalyzer” that created headlines, not only in broadcast engineering trade publications, but even in popular magazines.

Simply put, the Antennalyzer was a device that took much of the drudgery out of designing multi-tower directional antenna systems for AM radio.

DIRECTIONAL ANTENNAS

It wasn’t long after radio entered the home in the early 1920s that broadcasting became very popular — actually suicidally popular, as so many players raced to get a signal on the air that they crowded existing spectrum and began to drown each other out. The government stepped in, but the only solutions that could be offered to keep some semblance of peace were limiting licenses and helping broker time-sharing agreements that allowed multiple entities to use a common frequency on a rotating basis.

A more eloquent approach for keeping broadcaster signals separated had to wait a few years. This was in the form of a highly directional transmitting antenna or multi-antenna array.

Directional arrays got their start in the early 1930s, with the first recorded installation occurring at WFLA in Clearwater, Fla. Some frequency sifting by the Federal Radio Commission put both WFLA and Milwaukee’s WTMJ on a common frequency, and while all was fine in the daytime, skywave interference from WFLA eroded WTMJ’s nighttime coverage, eventually leading to a court challenge. WFLA either had to curtail nighttime broadcasting or cut power rather drastically. The WFLA/WTMJ case was just the tip of a rapidly growing iceberg, as more and more stations attempted to squeeze into the already crowded medium wave spectrum.

That radio signals could interfere with each other either constructively or destructively was nothing new then, but it took the ingenuity of Raymond Wilmotte, an engineer at the United Kingdom’s National Physical Laboratory, to make a practical application of this principle. He was brought in as a consultant

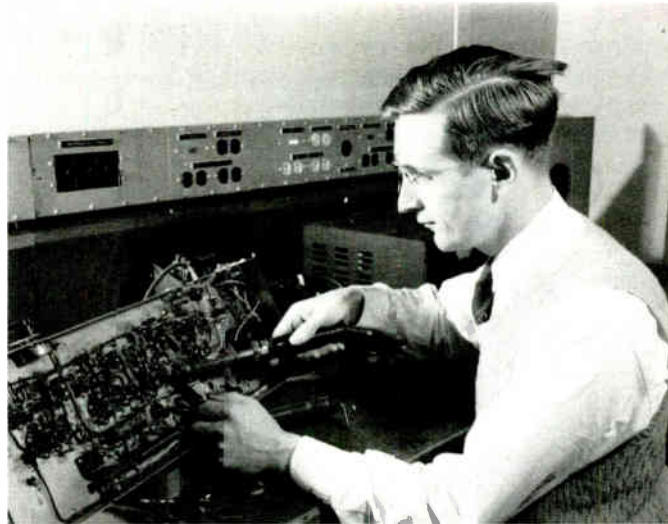

As evidenced by this RCA photo, Wendell Morrison was definitely a “hands-on” engineer.

Photo courtesy The David Samoff Library

to assist WFLA in maintaining its nighttime coverage, and he designed and implemented the first directional array at that station.

It should be noted that the move from conventional horizontally oriented “flattop” and “cage” transmitting antennas to vertical radiators by broadcasters in the early 1930s enabled radiation patterns to be tailored fairly easily. Individual antenna elements could be spaced apart, angular relationships between them established and networks created for sending RF current with differing intensities and phase relationships to these radiating elements. This vertical radiator technology trend was used to advantage by Wilmotte in the WFLA installation.

As the 1930s ended, AM directional arrays had become commonplace, allowing new stations to take to the air and existing ones to increase operating power without worries of interference to co-channel neighbors. As a result, consulting firms were called upon

to engineer increasingly tighter and uniquely shaped patterns, mandating the use of more and more radiating elements.

NO FINGER MATH HERE

To appreciate what consultants had to cope with in producing their designs, it’s time to introduce the multivariable equation that has to be solved to construct a directional array. As set forth in the fifth edition of the “NAB Engineering Handbook,” the mathematical expression for calculating directional antenna parameters for a two-tower array is given as:

$$E = 2E_2 \cos\left(\frac{S_2}{2} \cos\phi + \frac{\psi_2}{2}\right)$$

Where:

E = The inverse field strength at one mile in mV/m
 E_2 = The inverse field strength at one mile for each tower acting alone in mV/m

$\frac{S_2}{2}$ = The spacing from a reference point midway between the two towers in degrees

ϕ = The azimuth angle in degrees measured clockwise from the line of towers

$\frac{\psi_2}{2}$ = The electrical “time phase” of tower #2 and the negative “time phase” of tower #1 (in degrees)

The handbook notes that this directional antenna equation only shows what’s happening in the horizontal plane and that the terms were specially defined to simplify the equation. It further notes that an assumption is made that tower heights are equal and that the spacing from tower #1 to tower #2 (S_2) and the phase value (ψ_2) is the phase of the current in tower #2 with respect to that in tower #1.

This is the number crunching necessary for just a two-stick array; each additional radiator brings in its own multivariable equation, making the math progressively more onerous.

Note too that in the late 1930s and early ‘40s, the only tools available for number crunching were pencil and paper, slide rules and printed trig tables. If you or your firm were well-heeled, then there may have been a Marchant mechanical calculator available to speed

some of the math ordeal. However, these were limited to addition, subtraction, multiplication and division; no trig functions or powers.

Given these tools, it could take an engineer anywhere from days to several weeks to do all the math involved in designing a multi-tower array (and to double check it).

In trying to make the directional design task a little easier, a few individuals created mechanical or electro-mechanical “computers” for generating antenna patterns, with changes in tower spacing/angular position and RF current intensity/phase relationship simulated through the use of gears and chains or pulleys and belts.

The designer of one such machine was Carl E. Smith, a Cleveland-based consultant and chief engineer/vice president of radio station WHK. Smith was also one of the authors of

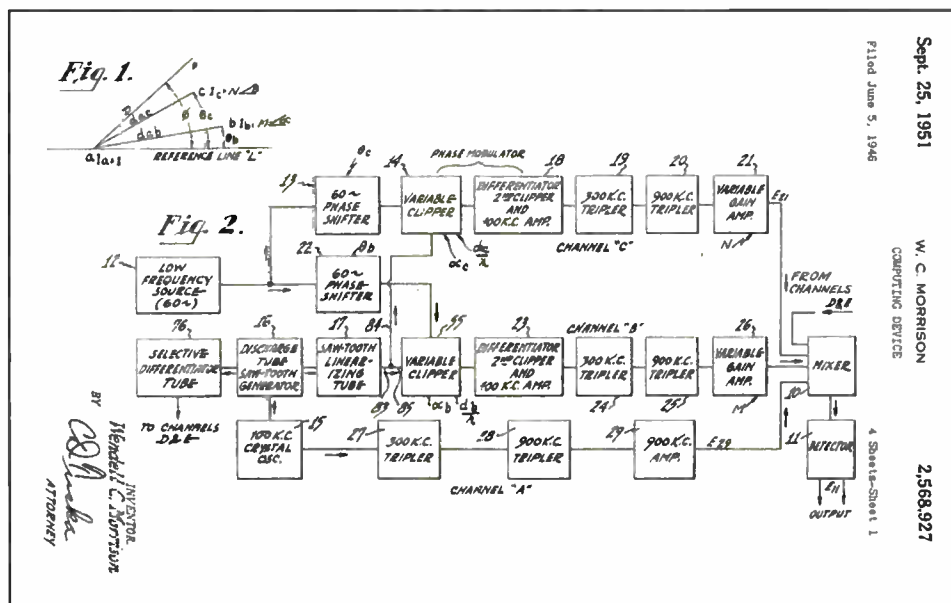

Morrison’s analog computer was constructed with more than 50 vacuum tubes. This block diagram submitted with his patent application for the device provides some insight into how it worked.

(continued on page 20)

ANTENNALYZER

(continued from page 19)

the Standard Broadcast Antenna Systems chapter in the "NAB Engineering Handbook."

He described his work with the mechanical computer/plotter in his book "Directional Antenna Patterns": "Due to the lack of systemized directional antenna patterns an electro-mechanical calculator was completed prior to World War II. In the fall of 1941, the machine was completed and the work was started to systemize two and three tower directional patterns."

Smith generated and cataloged several thousand "model" patterns and these formed the basis for his book.

He observed, "It is believed that if the patterns in this book are used merely as a guide to show trends, and not necessarily to show precise patterns that the systematization will have served its purpose."

In other words, the directional designer could use one of the polar plots generated by these early systems and try to fit it into what he or she wanted to accomplish in terms of an antenna pattern.

ENTER WENDELL MORRISON

While Smith's mechanical computer speeded up the work of the directional array design, there was still a lot of effort required just to go through the printed patterns to find one that "might" fit your particular need and there was still a lot of work to do to go from a textbook pattern to the equation solving needed to derive the numbers needed to actually construct the array and build the phasor. (Also, Smith kept his information to himself early on — he didn't get around to publishing his book until 1958.)

It remained for someone else to move this directional design from gears and chains to electronic circuits. That individual was RCA's Wendell C. Morrison and the "Antennalyzer."

Exactly where his device got its start may be debatable.

George H. Brown, one of the movers and shakers at RCA's Camden, N.J. broadcast division, recalls in his autobiography "And Part of Which I Was": "During the war [WWII] I thought of a batch of electrical signals which were identical in form with the equation of a directional antenna. After World War II, I asked Wendell Morrison, because his skill with electronic circuitry far exceeded mine, to develop and construct an analogue device which followed my concept and which I named 'Antennalyzer.' The result was an instrument with knobs for each of the variables of the equation for as many as five tower antennas with the radiation pattern displayed on the face of a cathode-ray tube."

It may have been Brown who hit upon the idea of moving from the world of gears and pulleys to vacuum tubes and potentiometers, but it took Wendell Morrison to make it happen.

Brown admitted that he did not possess the circuit design skills required for translating equations to wired connections and handed off the task to Morrison. The latter accepted the challenge and eventually produced a device to do what Brown had envisioned.

He filed for a patent on the new design tool, calling it rather deceptively just a "Computing Device."

His device became known as the "Antennalyzer" and consisted of a large box containing 50+ vacuum tubes and an array of front-panel pots. It was connected to a CRT display device that painted waveform changes brought about by manipulations of the Antennalyzer controls as a polar pattern on the tube. Its operation was



For its time, the Antennalyzer was such a revolutionary device that it moved out of the world of scholarly journals and onto the pages of "popular" magazines.

almost deceptively simple.

As described by Brown: "When one twisted the knobs at random, a myriad of lirioidendron-shaped figures were produced. The operator first traced the desired pattern on the face of the cathode-ray tube with a crayon and then adjusted the knobs at random but with a little skillful insight until the cathode-ray trace coincided with the crayon markings. Then the positioning of the knobs gave the location of the tower antennas and all of the other operating parameters."

Morrison's electronic computer made life much, much easier for the antenna designer. This was reflected by Brown as he recalled designing the directional array for Norfolk, Va., station WTAR in 1935.

"As a test of the instrument [Antennalyzer], we traced the WTAR pattern. 10 years too late, on the cathode-ray tube and asked a young lady who was then my secretary to adjust the knobs to achieve the desired coincidence of the traces. In less than 15 minutes she had a perfect match and the readings on the knobs agreed with the numbers which I had produced so arduously 10 years earlier."

REVOLUTIONARY, BUT NOT A GAMECHANGER

While Morrison's invention was certainly revolutionary, it was not destined to put the antenna designers out of business.

News of the device formed the cover story for the June 1946 issue of RCA's house publication "Broadcast News."

While praising the Antennalyzer, the publication's editor noted: "Incidentally, Brown and Morrison are very modest about the possibilities of the Antennalyzer. They don't think it will put consultants out of business, or even make mechanical computers obsolete ... The idea is that the Antennalyzer should be used to determine approximately the type of array required to produce the desired pattern — after which a mechanical computer would be used to determine the exact constants. ...

"At the present time it is not our intention to manufacture Antennalyzers for sale since it is felt that the cost would be prohibitive. However, one of the two which have been built in Dr. Brown's Laboratory will be set up at Camden and will be for the use of consultants and other qualified engineers."

True to the editor's words, the Antennalyzer never became a stock item in RCA's catalog of broadcast gear; however it did lead the way out of the use of slide rules and mechanical calculators and into modern digital computers for designing directional arrays.

Today, consulting firms use a number of software programs to crank out multi-tower designs in a matter of minutes on ordinary PCs.

IT'S STILL ALL ABOUT PROTECTING YOUR NEIGHBORS

However, as explained by John Hidle, a consulting engineer with the Carl T. Jones engineering firm, today, just as in Morrison and Brown's time, calculating antenna array values is not really the most difficult part of designing a directional array.

"The most critical and time-consuming part of the process remains in establishing protection requirements that you need in fitting in the directional pattern," Hidle said. "This still requires a lot of time and has to be done by the engineer with the computer's assistance. If someone came to me and said he desired to build a directional AM station in a particular location, the actual time for calculating the array values wouldn't take long. However, it could require several days for the engineer to think out how he's going to set up things in establishing protection requirements."

Nonetheless, Morrison's analog computer was something of a watershed event when it was revealed to the engineering community and the public at large. The device was written up in the December 1946 "Proceedings of the IRE" for the engineering community and a description of it even made the pages of "Popular Mechanics."

Morrison remained with RCA for more than 40 years, working at both the company's Camden, N.J., broadcast division and Princeton research lab, focusing initially on antenna analysis and later UHF transmission and color TV terminal and test equipment products. He served as chief engineer of the broadcast and communications division and also worked in the company's communications and controls division, as well as the RCA's defense electronics division.

Morrison was involved heavily in RCA's early 1950s push to develop a backwardly-compatible color television system and a few years later, in 1956 was part of the team that worked to "reverse engineer" Ampex's newly developed videotape recorder. (RCA had attempted to develop a VTR of its own, but gave up when Ampex unveiled a much more practical approach to recording video at the 1956 NARTB show. RCA entered into a cross-licensing arrangement with Ampex and used Ampex's electronic and mechanical designs to develop their own version of the recorder to ensure interchange of recordings between machines produced by both companies.)

Morrison may also have set a record for length of membership in the IEEE and its precursor organization, the Institute of Radio Engineers. That association spanned 72 years. He joined in 1940, became an IEEE Fellow in 1964 and was named a Life Fellow in 1981.

Morrison was 97 when he died in October 2012.

James O'Neal is the technology editor for Radio World's sister publication TV Technology. He wrote in February about "R.J. Rockwell and His Cathode Rig."

Step Up and Be a Trailblazer

Ditch the canned audio in favor of real opinions — from real people

The internationally successful Reuters news website has removed reader commenting from news stories. The editor stated that their audience has gone to “social media and online forums.”

The note continued, “Those communities offer vibrant conversation and, importantly, are self-policed by participants to keep on the fringes those who would abuse the privilege of commenting.” Readers will still be able to make comments on opinion pieces and blog posts.

Reuters joins a growing list of sites that have removed article commenting, including Popular Science and the Chicago Sun Times.

When commenting began, it was hailed as an innovation, finally allowing a former print audience to be immersed in real-time interaction with content publishers. So why are sites starting to turn off comments?

The Chicago Sun-Times said that commenting led to a “morass of negativity, racism, hate speech and general trollish behaviors that detract from the content.”

And — not that they publicize this part — commenting on articles is expensive to curate. Due to the large volume and round-the-clock nature of commenting, top sites had to outsource editing and deletion of comments.

In other words, news sites asked for audience involvement and three things happened: The audience showed up in large numbers; commenters did

not always behave; and there was no financial model to support expenses.

AUDIENCE ENGAGEMENT

What can the radio industry learn from this experience?

When given the opportunity, the active part of an audience will engage, often with powerful emotion.

When radio harnesses emotion on-air, it becomes meaningful and memorable.

And when we don't offer our audience the opportunity to express feelings and opinions, we become boring, stale and irrelevant.

I'd like to suggest something radical. Regardless of music, talk or news format, consider hiring producers specifically to seek out sentiment. Let's go after greater involvement by engaging local people to air to their views and experiences.

It has never been easier to record, edit and schedule audio for broadcast, and yet, outside of public radio, I don't hear many real people speaking. Voice tracking is the norm for so many music

stations, and while it can be perfect, it is also mostly sterile.

MAKE IT HAPPEN

Create a weekly content calendar related specifically to your format. Then capture the sound you need in your local community and put a good measure of this audio expression on-air. Go to



Use the voice memo iPhone app to collect sound from real people.

shopping malls, universities, houses of worship, sports fields, concerts, events, community organizations, gyms and bars. Ask a lot of questions and let people have their say.

Music stations have fewer than a hundred core artists. Get sound about each artist from people who care about them and have stories or opinions. Get thoughts about songs they love and what they mean to them; concerts they've seen; appearances they've watched of music celebs on television and in film. For

authenticity, encourage people identify themselves, if only by first name.

Get birthday wishes from husbands for their wives and broadcast them on the actual dates.

What's going on in your community

PROMO POWER



Mark Lapidus

that's controversial? Is there a debate about a new highway, school system, crime, safety or sports team?

With the proper short setup, these drops between songs, shows or news elements will add a whole new dimension to your station.

This engagement requires a new kind of radio producer who can hear this in their head before hitting the street. A producer has to be creative, fearless, friendly and highly interested in people.

Isn't this a better investment than a canned DJ reading corny one-liners?

Although there are vast quantities of audio already available on the Web, few stations curate sound. Have you noticed that iOS8 supports sound recordings via text? Maybe you can get your listeners to use that feature and text you sound. Try it and let me know how it goes.

The audio you collect requires smart daily scheduling. When you're broadcasting live, these audio pieces can be utilized to generate phone calls on the subject.

This new creative production approach will take time, effort, money and intelligence.

Who wants to step up and be a trailblazer?

The author is president of Lapidus Media and a longtime contributor. Find more of his Promo Power column at radioworld.com/promopower.

WWW.STUDIOITEMS.COM STUDIO ITEMS INC. (815) 669-2070

LOW PROFILE MIC BOOMS





- PRE-WIRED WITH GOLD PLATED NEUTRIK XLR CONNECTORS
- MECHANICAL BOOM STOP (SO ARM CAN NOT ROTATE 360 DEGREES)
- HOLLOW RISER SO MIC CABLE CAN RUN DIRECTLY TO MIC ARM XLR CREATING A CLEAN AND UNCLUTTERED LOOK
- 22" REACH
- LED COLORS: RED, BLUE, GREEN, WHITE, ORANGE, AND YELLOW

Monte Sieberns Paints Auditory Pictures

Blind broadcaster fulfills his DJ dreams with some advanced technology

DAIR TALENT

BY KEN DEUTSCH

According to an account by www.reelclassics.com, the classic quote originated in the syndicated newspaper cartoon Frank and Ernest in 1982. It depicted a movie marquee for a Fred Astaire film festival. Two guys stood in line ready to enter the theatre; a woman says to them, "Sure, he was great, but don't forget that Ginger Rogers did everything Astaire did, but backwards and in high heels."

tiating public transportation, traversing an unfamiliar room and other tasks sighted folks take for granted.

In his teens, Sieberns found some work in radio; but finding a full-time slot was not easy.

GETTING A GIG

"My audition tapes would pass muster, but in the interviews they'd see I was blind and that would put a damper on things. The managers were trying to imagine themselves in my situation, and it scared them, which is understandable," he said. "But successfully dealing with my blindness is all I know. It's not



Monte Sieberns uses the Braille Sense U2 in the studio.

I wanted to be that voice coming out of the speakers.

— Monte Sieberns

So it is with WJOT(FM)'s Monte Sieberns. He does everything other radio personalities do, but without the power of sight.

"I am blind from birth, and I naturally gravitated toward sounds," he said. "My father is a farmer who listened to WOWO(AM) Ft. Wayne for the farm reports. I wanted to be that voice coming out of the speakers."

Sieberns, 44, has been the voice of "Monte's Music Shop," heard live from noon to 5 p.m. weekdays, since April, 2007 on the Wabash, Ind., station. For a short time, when WJOT was searching for a new morning man, Sieberns also held down the 6-9 a.m. air shift.

From kindergarten through 12th grade, Sieberns attended Indiana School for the Blind, which not only taught him his ABCs but also skills such as nego-

as if I had sight and lost it. Over the course of my whole life I have adapted."

Sieberns endured a short stint in a broadcast school and found it to be less than helpful.

"They would ask stupid questions like 'How many feet of tape are there on a 10-inch reel?' Radio, it's not about theory; it's about creating a sound," he said.

Sieberns found part-time jobs at various stations in Indianapolis and Vincennes, Ind., but by 1988 he still couldn't find full-time employment on the air. Thus he began working behind the scenes building music libraries for stations and serving as a DJ at weddings, endeavors he continues to this day.

"I was tuning around the dial, feeling kind of maudlin about not being on the air," he said. "I discovered WJOT and called the operations manager and

offered to work on the air. He didn't need an air personality at the time, but the general manager did need help building an MP3 music library his staff could access from computer."

This led to an unusual — but successful — live audition.

"I invited the sales manager and the general manager down to my home studio," said Sieberns. "I told them that before I handed over the first volume of music I wanted to test it. I can't tell you the reason, but when the introduction to the first song came out of the speaker, I began talking over it like I was on the air. I even included their dial position. They both sat there and said, 'Whoa, we could use that.' I said, 'Here I am. You want me to come in today?'"

TAKE A CHANCE ON ME

The next Thursday, Sieberns found his way to the station with the assistance of his twin brother, Marty, who is not

blind. Monte Sieberns had a chance to use his hands to get familiar with the board and then said, "OK, let's go on the air!" The following Saturday morning he was brought in to run the board for a remote broadcast.

"It's awesome that these guys were willing to take a chance on me," he said. "One thing that helped was that I brought in my own adaptive equipment."

And these self-taught techniques and specialized pieces of gear make the difference when it comes to establishing independence for the blind.

"At first, I had to have someone read the log to me, but that's changed now. Someone just emails it to me, and I can display it in Braille. We use a program called StationPlaylist (www.stationplaylist.com), and I have another program called Window Eyes (www.windoweyesforoffice.com) that reads

(continued on page 23)

An advertisement for Sandies Studio Warning Lights and Broadcast Consoles. It features several pieces of equipment: a vertical sign that says "ON AIR", a smaller sign that says "ON AIR", a sign that says "RECORDING ON AIR", and a sign that says "GRABANDO EN AIRE". Below these signs are two pieces of broadcast consoles, one of which is labeled "DYNAMAX MX SERIES". The Sandies logo is prominently displayed in the center, with the phone number 214-547-2570 and the website www.sandiesusa.com.

PEOPLE NEWS



Carlos Lamadrid

Entercom Communications

has been chosen as VP of national sales and strategic partnerships

Andy Lack

U.S. international media.

will serve as the organization's first CEO



Gayle Troberman

iHeartMedia Inc.

will serve in the role of executive vice president and chief marketing officer

Curtis LeGeyst

NAB

has been promoted to the newly created position of senior vice president for public policy



Charles Steinhauer

Westwood One

has extended his contract with Cumulus Media to continue as COO



Jody Evans

Public Radio Program Directors Association

was chosen as its new president and CEO

Andreas Mayo

Andres Mayo Mastering and Audio Post

succeeds Sean O'live as the new president of the Audio Engineering Society



Brian Burdick

WideOrbit

has been named EVP of digital and programmatic

Kim Keenan

Minority Media and Telecommunications Council

will succeed co-founder and President David Honig, who is stepping down



Marc Bawol

WinMedia Group

has been named area sales manager for North, Central and South Americas

Michael Jordan

iHeartMedia

will become WAMZ(FM)'s new program director

Tim Richards

CBS Radio

has promoted been promoted to operations manager for Phoenix's KMLE(FM) and KZON(FM)



Jack Foley

Westwood One

has been selected as its new vice president of business development

Send information to radioworld@nbmedia.com with *People News* in the subject field.

(continued from page 22)

the screen to me with a synthesized voice. So now I can get the record title, artist name, song length, etc."

While Braille is an old technology, it's been brought into the 21st century with Braille Sense U2 (hims-inc.com). This software uses "refreshable Braille" incorporating metal pins that pop up and down electronically replacing the traditional paper chad.

Sieberns also carries several portable devices including an Olympus LS-100 multi-track PCM recorder and a Plectalk (www.plectalk.com), a CD/Flash recorder. He uses the latter to record stock market reports via his iPhone, a device that comes adapted for the blind directly from the factory. His bag of tricks also includes a Perkins Braille (www.perkinsproducts.org) that stamps out traditional Braille text onto stiff paper for those pieces of copy that will be read repeatedly.

His gear includes a remote mixer for combining his voice and music for commercials, his own thumb drives and SD cards. Not completely necessary — but always handy — is the 14 terabytes of music he has collected. For remote broadcasts, Siebert takes advantage of his senses of hearing, taste, touch and smell. For example, at a restaurant he samples the wares and tells the audience about the delicious taste.

"I paint an audio picture for the listener," he said. "like

when I was at this used car dealership, and I sat inside a car and described what it was like. Or when I was broadcasting from a jewelry store, and I could feel the etchings in the jewelry."

Wade Weaver, owner of WJOT, was one of the men who initially recognized Sieberns's talent and gave him his break on the air.

"My biggest accomplishment as a radio operator is helping Monte achieve his dream to become an FM disk jockey," said Weaver. "He's an amazing announcer, and there is nothing he can't do on the radio."

Most WJOT listeners know that Sieberns is blind, though he doesn't emphasize the fact on the air.

"My hopes are that I can open up this world for people and make them more comfortable with it," he said. "Very rarely will it upset me to deal with my blindness, but when I have a rough day I kick myself in the butt and say, 'You're here, deal with it!' Usually, I run around the building without my cane, which I shouldn't do because you never know when someone has rearranged the furniture."

Ken Deutsch started his writing career with grocery lists, graffiti and anonymous MASH notes to his elementary school teachers. Look where he is now.

Comment on this or any story. Write to radioworld@nbmedia.com.

WE FIX MARTI GEAR

plus a whole lot of other stuff!



Our techs specialize in Marti Electronics gear, but we service almost all brands of broadcast equipment.

From mic processors and audio amps, to STLs and transmitters -

Bohn Broadcast Services is your repair and service solution!

Give us a call today!

1-844-549-2646

www.bohnbroadcast.com

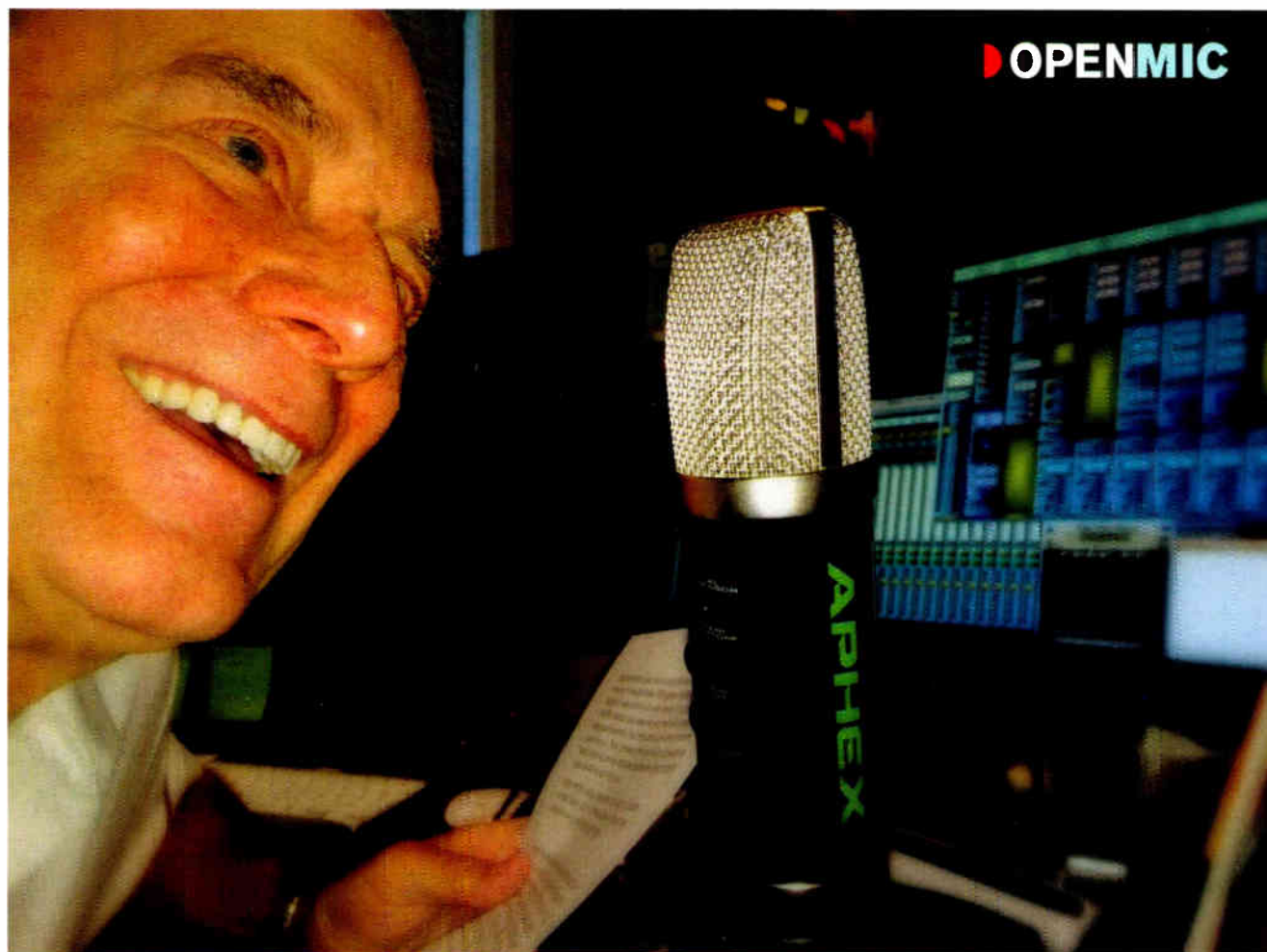

Does Microphone X Have It All?

Radio man, V/O artist Don Elliot takes a shine to the Aphex Microphone X, provides some V/O tips too

BY DON ELLIOT

Welcome to Open Mic, a new endeavor to give radio production personnel a forum to express themselves, impart information and stir the pot, in a less formal format. Here, L.A. radio vet and "V/O Guy" Don Elliot gives some voice-over pointers and finds a mic that he really likes. If you'd like to propose a piece for Open Mic, contact Brett Moss at bmoss@nbmedia.com.

In SAG and AFTRA, there's a famous old expression: "If you want work, leave town!" Yes, it seems as if whenever you are just getting away for some time off, you wind up with a flurry of requests for eleventh-hour projects, auditions or whatever.

It used to take a lot of outboard gear to achieve a particularly desirable competitive sound, especially something that catches the ear in an audition, compared to all the muck, schlock and pure

purple padoo an agent or casting director must read through to find "the one" for the job. In this business, you want to be the one who stands out.

So how do you win an audition or do the job from the road, and not have it sound like it was done outside a pro studio?

Until recently, the secret chain in my little corral that we pioneered at KIIS(FM) was a result of my piling on a rack version of the Aphex Aural Exciter and "Big Bottom" units, a Symetrix 528 and a Universal Audio LA-3A compressor/limiter, with the best V/O shotgun mic I know of, the Sennheiser 416. This creates a competitive sound that gets the listener's attention because it competes with the "big-as-a-barn-door" sound the audience is used to hearing in movie trailers and big production accounts.

I do this because the audience is used to that sound, and a lot of this game is all about "compared to what?" It's where the bar is. (The one raised

for standards and high class, not the one where we raise the glass!) Your product is going to get played adjacent to something else, so the ear already has a reference from hearing other product, and if yours doesn't measure up to or exceed that standard, you've lost the game before you ever open your mouth!

AUDITION CHALLENGES

The kids who get trophies for not winning at soccer are going to be pissed off at what follows.

The fact that "it's not fair" is exactly what you want.

You need an unfair advantage in auditions. You *want* an unfair advantage.

There's another old expression in AFTRA and SAG that I loosely paraphrase: "The audition *is* the job. You either get it, or you don't."

Let's say two talents are equal in all things, until we compare the tech end. If the quality isn't there, the listener doesn't have a tech checklist of why; they simply hear something ugly compared to something pretty. It's a logic

call, but fueled with vibes and emotional responses to audio stimuli. It's aural sex appeal.

But we're citing a lot of gear to use. Well, that could be a lot for a carry-on suitcase.

Not too long ago, I took my chain along and did some work while on a cruise. I had horrendous experiences trying to get MP3s transmitted from the ship to the client's studio.

I decided to compare notes with V/O legend Joe Cipriano on how he handles production on the road. Travels can take you anywhere in the world, whether it's work or play, but in the voice business, responsiveness and deadlines are a key to keeping clients happy and making them look good. And when that happens, you get bonus points for reliability when they know they can depend on you.

A FEW WITH JOE

Here are some excerpts of my quickie interview.

Me: "Tell me how you work with project 'home-away.'"

Joe: "It's been a few years since I worked from a cruise ship, and yes, at that time, the connection was like going back to dial-up speeds. I needed to read to a promo, which usually means the engineer cues up the promo and sets up three beeps before the start and you 'read to the promo' in real time.

"However, we couldn't connect live because of the low Internet speeds, so I had the networks email a very low-res audio version of the spot as an MP3. I would then import it into Pro Tools in my laptop and 'read to the audio of the promo' locally into my laptop. Then, I would export my audio only and turn it into a high-res MP3 at 320 kbps and email it back to the studios. They would then import the audio into their system and sync it up with their video."

Me: "So what are you using these days?"

Joe: "In recent years, I use a Verizon MiFi 4G LTE cellular mobile hotspot for all of my Source Connect sessions when I'm away from my home studio. I don't even use hotel Internet anymore. The MiFi is lightning fast, and I have it set up with a static IP, which makes my SC connection rock solid. I've done many sessions from the back of a rental car with my MacBook Air, Sennheiser 416 with a Focusrite iTrack Solo or a CEntrance MicPort Pro as the interface and Sony headphones. Wherever I am, I find a parking lot that is quiet and away from main roads and get in the back seat, which makes for the best acoustics. You've got a leather or fabric 'back' of the front seat in front of you, fabric

ceiling, and it's pretty darn quiet in a closed up and buttoned up automobile."

Me: "Thanks, Joe, for your hints, insights and secrets. It's always great to see how others overcome these obstacles. I feel like we have parted the curtain to see what the wizard was using to get 'that sound.'"

SOLUTION

I mentioned a ton of outboard gear earlier.

But what if you could take all that with you in one small unit when you are packing?

Even better, what if someone built all of that into the microphone itself?

The ear already has a reference from hearing other product, so if yours doesn't measure up to or exceed that standard, you've lost the game before you ever open your mouth!

I have had many discussions with Aphex's top gun Jace Nuzdack about his latest product, which is all that and more. It's called "Microphone X" (\$199.99 MSRP).

Microphone X is a USB mic with Aphex analog processing in the microphone. To be more specific, it has Aural Exciter analog high-frequency enhancement; Big Bottom analog low-frequency enhancement; and analog optical compression. Also included are a high-performance headphone amplifier, recording software and a desktop stand.

I should mention that the hot little boutique-grade preamp, the CEntrance MicPort Pro that Joe relies on (and I have also carried everywhere I go for years now),



is in the heart of this Aphex mic. Seems two savvy companies sweetened the deal nicely for us, and their synergy resulted in this fine piece of gear.

Incidentally, whenever I get to the part about the compression, most people shake their head with a hearty, "Oh no, man ... We like to do that stuff in post."

Right. After sifting through 13 takes of distorted performances because the talent changed levels unexpectedly and hit a peak in the read ... so no biggie, right? Just recut it lower? Why not have access to the "take that got away" by using some protection in the session at the mic itself, before it hits the DAW so that you get to keep that "best take" in the first place? Duuh. Double duh. My hat's off to Aphex for this accomplishment.

Another thing I like about Microphone X is that it is powered by USB, so it requires no extra battery power.

Using Microphone X with an iPad requires a bit of finagling. You must have the camera kit for 30-pin or Lightning jacks, and there is no way to charge the iPad and use the Microphone X at the same time. You'll get about five full hours of recording time with a full charge.

I should also point out that the only connection on the Microphone X is USB, so you must have it connected to a computer or iPad with a DAW application to hear it at all.

By the way, on the Mac you can setup multiple Microphone X units as an aggregate device.

However, it is up to the DAW or broadcast software to be able to send the output signal of the mic to monitor.

PARTING WORDS

I'll toss in some free advice on another common challenge in remote recording and making it sound like a studio: acoustics. Joe commented on his back seat of the car activities. But if you are carless when the need arises (stop

grinning), you might be able to deal with room acoustics with pillows and blankets or hotel closets. That's a tip from the pros.

While I'm on the subject, there's another issue dealing with recording on iPads or iPhones while on the road. Truthfully, these devices were made for content consumers, not content generators, despite the fact that Apple touts their products as being friendly to creatives. Try generating an MP3 output from one. There are several solutions to this. If you ask Apple, they will tell you to plug into iTunes on your laptop or desktop and convert to MP3 and then send it.

Now wait a minute ... When I'm on the road I don't always have either at my disposal. I need to turn this puppy around in under 15 minutes.

Currently, the most exciting solution out there that is compatible with all these requirements is a little free app audio editor called TwistedWave (from www.twistedwave.com). Record, edit and output to email or FTP as a converted MP3, all from the iPhone or iPad. There is also a paid version available that runs on Mac laptops if that's what you are packing.

There. Now you know how to take your show on the road, too!

For information on Microphone X, contact Aphex in Utah at (801) 699-2272 or visit www.aphex.com.

Don Elliot is a former program director at KHIS(FM) and well-known voice-over artist. His demo is available at <http://tinyurl.com/Don-Elliot-Promo-Demo>.

PRODUCTS & SERVICES SHOWCASE

Efficient
Effective
Effortless
Affordable

RADIO WORLD'S
Products and Services Showcase
provides a perfect medium for
marketing your products and services.

For more information, contact
Michele at 212-378-0400 ext. 523
or minderrieden@nbmedia.com
to request a media kit.

RADIOWORLD

GR
Gorman Redlich Mfg. Co.
is CAP-able

The CAP-DEC1, Gorman-Redlich is a stand-alone CAP-to-EAS converter for use with your existing emergency alerting equipment. This cost-effective device allows broadcasters to easily meet Common Alerting Protocol (CAP) compliance requirements mandated by the FCC without requiring the purchase of an additional encoder/decoder system or other costly

equipment. The CAP-DEC1 is CAP 1.2 compliant and requires only one unit of rack space. Trust the experts with over 35+ years experience in the emergency alerting industry to help you meet your broadcasting needs. Visit our website or contact us today for more information about the Gorman-Redlich CAP-DEC1. We continue to support equipment we made 35 years ago.



- Compatible with any existing EAS encoder/decoder made by any manufacturer. Will drive multiple EAS units.
- Powerful 1.6GHz dual core processor and 1GB of memory
- Built-in text-to-speech conversion functionality
- FAST Gigabit network capability with built in firewall for security
- Options to print, store or email logs via built-in email server
- Nearly limitless storage capacity for logs and audio messages
- Five (5) USB and RS232 ports for peripherals
- Automatic clock synchronization via NTP servers
- Software can be updated via LAN or USB
- Print alert reports to USB or network printer
- Polling 3 URL's currently with room for future expansion
- FEMA independent lab affirms CAP 1.2 compliance
- Printer no longer required for EAS log

Gorman-Redlich Mfg. Co.
www.gorman-redlich.com

257 W. Union Street, Athens, OH 45701
Phone: 740-593-3150

FREE SOFTWARE

Herb Goldberg Devices

Herbert Goldberg, blogging under the handle Varosound, presents a series of free VST plugins through his site Variety of Sound.

The website offers an impressive array of effects, from EQ to dynamics to reverb, all at no cost.

On the site he says: "As a computer scientist and musician, I'm enjoying designing DSP algorithms and plug-in concepts. It's a pleasure for me to share my efforts with other people without having to worry about commercial interests."

Each download is contained in a ZIP file, which contains the VST plug-in, a manual, and license. The one exception is EpicVerb 1.5, which downloads as a RAR file, requiring WinZip or a similar application to extract.

I took a look at six of the 15 plugins offered.

BaxterEQ is a mastering and mix bus shelving EQ. As with most of the plug-ins,



BaxterEQ



Density MKIII



Thrillseeker VBL

the interface is reminiscent of vintage rack-mount gear, in this case classic Pultecs. The effect is subtle, yet effective, but is best suited to entire mixes rather than surgical tone correction.

Density MKIII is another mastering/mix bus tool, offering compression and limiting. Its interface retains the "vintage" look of an old-fashioned tube unit. The controls are simple — a range control to adjust the compression threshold, a drive control and makeup gain. Attack and release are combined into a "Timing" control. The unit can handle stereo tracks, or two separate mono channels.

Thrillseeker VBL is an emulation of popular broadcast limiters from the 1950s. Fans of the old Gates or RCA limiters might get a kick out of this one. It's got the look and feel of the old gear, right down to virtual "set screws" to adjust bias, emphasis and other parameters. As with most such processors, a little goes a long way. It didn't take much to find out what an overprocessed station would sound like!

Continuing in the "vintage" tradition, Ferric TDS provides a simulation of tape

eBooks: Tools for Strategic Technology Decision-Making



Radio World's growing library of eBooks can assist you in maximizing your investment in an array of platforms and tools: licensed transmission, online streaming, mobile apps, multicasting, translators, podcasts, RDS, metadata and much more. The eBooks are a huge hit with readers. They help engineers, GMs, operations managers and other top radio executives — radio's new breed of digital, cross-platform decision-makers — understand this new world and thrive in it.

Visit radioworld.com/ebooks



Ferric TDS



Nasty VCS



EpicVerb

saturation dynamics. Its controls are straightforward, and it's certainly effective as an overall bus compressor; but I don't see it replacing my old MCI. Like the song says, "Ain't nothin' like the real thing."

Nasty VCS is a virtual console strip, cramming a lot of features into one space, with a tube simulator, fully parametric EQ, compressor/limiter and other features to surgically alter audio. This one's main flaw is the interface. While the virtual knobs are easy to use, the bypass and other controls for each stage appear as very tiny buttons along the bottom, making them difficult to spot. Aside from that, it's a handy, clean-sounding tool for doctoring vocal tracks.

Finally, EpicVerb is a full-featured reverb/ambience simulator, with pre-delay, dampening and EQ controls. Other adjustments include level and timing of early reflections, modulation and even mid/side levels. Dozens of presets are also included.

Info: varietyofsound.wordpress.com

— Curt Yengst, CSRE

BAY COUNTRY BROADCAST EQUIPMENT

BUY - SELL - TRADE

Your #1 Source

For Quality Used Radio Broadcast Equipment

View The Latest List Online at: <http://www.baycountry.com>
Or call and we will fax it to you.

7117 Olivia Rd., Baltimore MD 21220

Toll Free: 877-722-1031 • FAX 443-596-0212 • E-mail: sales@baycountry.com

ACOUSTICS

Acoustics First
SOUND AND NOISE CONTROL MATERIALS
Toll-Free Number: **888-765-2900**
www.AcousticsFirst.com

ANTENNAS

FCC COMPLIANCE
TOWER SIGNS
AM & FM Tower Signs
Tower Registration Signs
Standard & Custom Wording
Guy Wire Protectors - Antenna Tags
ANTENNA ID PRODUCTS
antennaid@msn.com
E-mail us for a free PDF catalog
610-458-8418 www.antennaid.com

AM LOOPS

FOR EAS RECEIVERS
FEMA RECOMMENDED
www.PixelSatRadio.com
(303) 526-1965

AUDIO PROCESSING (INCLUDES ON-AIR)

WANT TO BUY

Teletronix LA-2A's, UREI LA-3A's & LA-4's, Fairchild 660's & 670's, any Pultec EQ's & any other old tube compressor/limiters, call after 3PM CST - 214 738-7873 or sixtiesradio@yahoo.com.

RADIOWORLD Equipment Exchange

AUTOMATION EQUIPMENT

WANT TO SELL

It's free and it has been expanded. The only cost is to keep us informed as to how the system is performing and let us know how you are using it. DIY-DJ, is a Linux based radio automation system and now sports a record scheduler (DIY-DJ-RECORDER) which allows you to schedule the

WANT TO SELL

Radio broadcasts of Major League Baseball, NFL, and some college football games that are on cassette tapes, approx 100 to 125 games, time period of entire collection or from the 1950's - 1970's, BO. Must purchase entire collection. Contact Ron, 925-284-5428 or ronwtamm@yahoo.com

WANT TO BUY

Collector wants to buy: old vintage pro gears, compressor/limiter, microphone, mixing consoles, amplifiers, mic preamps, speakers, turntables, EQ working or not, working transformers (UTC Western Electric), Fairchild, Western Electric, Langevin, RCA, Gates, Urei, Altec, Pultec, Collins. Cash - pick up 773-339-9035 or ilg821@aol.com.

2" plastic "spot" reels 6.5 or 8" diameter, as used for quad video. Wayne, Audio Village, 760-320-0728 or audiovlg@gte.net.

Equipment Wanted: obsolete, or out of service broadcast and recording gear, amplifiers, processing, radio or mixing consoles, microphones, etc. Large lots preferred. Pickup or shipping can be discussed. 443-854-0725 or ajkivi@gmail.com.

I'm looking for San Francisco radio recordings from the 1920's through the 1980's. For example newscast, talk shows, music shows, live band remotes, etc. Stations like KGO, KFRC, KSFO, KTAB, KDIA, KWBR, KSF, KOB, KCBS, KQW, KRE, KTIM, KYA, etc. I will pay for copies... Feel free to call me at 925-284-5428 or you can email me at ronwtamm@yahoo.com.

Looking for a broadcast excerpt of a San Francisco Giant's taped off of KSFO

recording of a network or any other program for replay later as well as a basic logging system. Beside these additions the system schedules music, does voice tracking (ALWAYS hit the vocal), create a shell, live assist, exact time events, join satellite feeds, automated temperature announce, do unattended remote events and more. Call (406) 679-0527 or email krvvs@digitaldevelopment.net for a copy today.

MICROPHONES/ HEADPHONES/ SPEAKERS/AMPS

WANT TO SELL

1934 RCA 77A double ribbon microphone, originally used by Arthur Godfrey at WFBR Baltimore. 100% perfect condition. Contact Bill Cook, 719-684-6010.

WANT TO BUY

RCA 77-DX's & 44-BX's, any other RCA ribbon mics, on-air lights, call after 3PM CST, 214 738-7873 or sixtiesradio@yahoo.com.

MISCELLANEOUS

ROTRON BLOWERS AND PLATE BLOCKERS, new & rebuilt for Elcom, Harris, CCA, CSI, McMartin. Goodrich Ent. 11435 Manderson St. Omaha, NE 68164 402-493-1886 Email: CGoodrich@tcnfl.com

STOP AM RADIO INTERFERENCE

with a plug-in modem/telephone RF filter from:

K-Y Filter Company
3010 Grinnel Place
Davis, CA 95618
(530) 757-6873

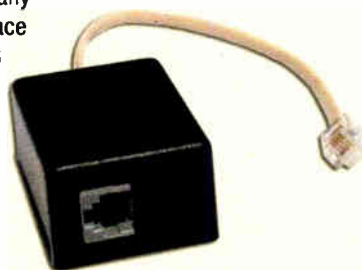

www.ky-filters.com

Model AM-1 is for AM Broadcast Band radio interference.
Model RF-1 is for Short Wave, Ham Radio, CB etc.

CONSULTANTS

OWL ENGINEERING, INC.
Consulting Communications Engineers
5844 Hamline Ave. N., Shoreview, MN 55126
651-784-7445
• AM/FM/NCE Applications • Tower Detuning
• Allocation and Upgrade Studies • Intermodulation Studies
• Pre-Purchase Inspections • ANSI and NRSC Measurements • Radiation Hazard Evaluation and Measurements
• AM Directional Array, Design, Tuning and Proof using Method of Moments
Fax (651) 784-7541 E-mail: info@owleng.com "Member AFCCE"

Doug Vernier
Telecommunication Consultants
Broadcast Engineering Consulting
AM/FM/TV/LPTV/OTV
Custom mapping service
Frequency searches
Propagation prediction
FCC application preparation
V-Soft
Software for your PC
(800) 743-3684
www.v-soft.com

**Broadcast
Equipment
Exchange**
For more information, ask
Michele at 212-378-0400 x523
or minderrieden@nbmedia.com
RADIOWORLD

GRAHAM BROCK, INC.
BROADCAST TECHNICAL CONSULTANTS
Full Service From Allocation to
Operation AM/FM
Field Work: Antenna and
Facilities Design
Over 45 years engineering
and consulting experience
912-638-8028
202-393-5133
www.grahambrock.com

• Radio and television facility coverage predictions, upgrade studies, and facility design
• FCC application preparation
• Contact Clarence M. Beverage or Laura M. Mizrahi
Communications Technologies, Inc.
Radio Frequency Broadcast Engineering Consultants
Tel: (856) 985-0077
www.comtechrf.com

Advertise your employment ad on our web site for only \$2 per word!

radioworld.com

Call Michele for all the details at 212-378-0400 ext. 523 or email minderrieden@nbmedia.com

radio from 1959, interviews with Willie Mays, Dusty Rhodes & some play by play excerpts, also features a homerun by Willie Mays and Felipe Alou stealing second base, running time is 18:02, also looking for SF Giants games and/or highlights from 1958-1978 also taped off KSFO Radio. Ron, 925-284-5428 or ronwtamm@yahoo.com.

Looking for KFRC signoff radio broadcast from 1930 Andy Potter, running time is 0:22 & also the KLX kitchen the program guest is Susanne Caygill, a discussion of woman's affairs with a long promotion for Caygill's appearance at a local store. Anne Truax, Susanne Caygill, running time is 13:44. Ron, 925-284-5428 or email ronwtamm@yahoo.com.

Looking for KTIM FM radio shows from 1981-1984 if possible unscoped. R Tamm, 925-284-5428 or ronwtamm@yahoo.com.

WANTED: Expired/cancelled FCC Third Class Radiotelephone license with Broadcast Endorsement. Kentverbeck1@yahoo.com.

RECEIVERS/ TRANSCIVERS

WANT TO SELL

Free sample SCA decoder. 417-881-1846.

RECORDING & PLAYBACK HARDWARE

WANT TO BUY

Large or small collections of 16" transcriptions or 12" transcriptions, not commercial LPs. Bill Cook, 719-684-6010.

Schnader telecriptions 16 mm musical films produced in the early 50 s. Bill Cook, 719-684-6010.

Standard Short-tune series. Bill Cook, 719-684-6010.

TAX DEDUCTIBLE EQUIPMENT

Donations Needed: All Volunteer, Non-profit Low Power community radios stations need Equipment. Will offer tax deduction letter, You determine donation value, We will pay shipping. Equipment shared between three Wisconsin stations. Looking for Mics, Mixers, field equipment, etc. You name it. Email: Dan@WIEradio.org.

DISTRIBUTOR DIRECTORY

The following distributors serving the broadcast industry would be glad to help you with any of your requirements.

CORNELL-DUBILIER
MICA CAPACITORS
FROM STOCK
JENNINGS VACUUM
CAPACITORS
FROM STOCK
HIGH ENERGY CERAMIC
CAPACITORS
SURCOM ASSOCIATES
5674 El Camino Real, Suite K
Carlsbad, California 92008
(760) 438-4420 Fax: (760) 438-4759
e-mail: lnk@surcom.com web: www.surcom.com



Se Habla Español

Rebuilt Power Tubes 1/2 the cost of New!

ECONCO

Se Habla Español

Tel: 800-532-6626 Web: www.econco.com
Intl +1-530-662-7553 Fax: +1-530-666-7760



TRANSMITTERS/EXCITERS/TRANSLATORS

TUBES

TRANSCOM CORPORATION

Serving the Broadcast Industry Since 1978
Transmitters and Broadcast Equipment for Radio & Television

Used FM Transmitters

100 W	2008	BE FM100C
500 W	2000	BE FM 500C
3.5 KW	2000	Harris Z3.5CD, solid-state
5 KW	1995	Harris HT5CD
5 KW	1999	Harris Z5CD, solid-state
5 KW	2006	Harris Z5, solid-state, unused
7.5 KW	2002	Harris Z7.5CD, solid-state, S PH
10 KW	2008	BE FM10S, solid-state
20 KW	1989	BE FM20B
25 KW	1996	Harris HT25CD
27.5 KW	1994	Continental 816R-4B, SS IPA
30 KW	1988	Harris FM30K
35 KW	1991	BE FM35B

Used AM Transmitters
Please see our website or contact us for current listing

Exciters & Miscellaneous Equipment
BE FC30, SCA Generator
Bird Model 8936, 10 kW air-cooled RF Load
Harris N + 1 Controller
Harris THE-1 FM exciter
Marti ME 40, FM exciter
MCI 4 Port 1-5/8" Coaxial Switch
Sola Constant Voltage Transformer #23-23-230-8

Please visit our website,
www.fmamtv.com, for additional listings.



HARRIS nautel

CROWN BROADCAST

TV Transmitters- Analog and Digital
Used FLO TV Transmitters * Axcera
* Rohde & Schwarz * Harris Maxiva

New TV Transmitters- Analog and Digital
OMB, Rohde & Schwarz and Technalogix
VHF and UHF TV Antennas
(10 W to 10 KW) TV STL

800-441-8454 • 215-938-7304 • FAX: +1-215-938-7361

www.fmamtv.com • E-mail: transcom@fmamtv.com

RETUNING & TESTING AVAILABLE • CALL US FOR A QUOTE!

AM Ground Systems Co

• Best price AM station full coverage
• Best AM ground system (over 30
years)
• Best ground system from
Chicago, IL, USA (since 1977)

amgroundsystems.com
866-22RADIO

RADIOWORLD
Equipment Exchange

RF PARTS™ CO.

Se Habla Español We Export

EIMAC • TAYLOR • SVETLANA
New & Rebuilt Tubes - Same Day Shipping
Motorola • Toshiba • SGS • Thomson & Mitsubishi Semiconductors
800-737-2787 760-744-0700
rfp@rfparts.com www.rfparts.com

Buying Or Selling
Used Equipment?
You're in
the right place!
RADIOWORLD



ISO 9001 Certified
The Choice of Successful
Broadcasters Since 1934

NEW POWER TUBES

Triodes
Tetrodes
Pentodes

NEW SOCKETS &
REPLACEMENT PARTS

Worldwide Availability

Made in U.S.A.

CALL 800-414-8823
Int'l (650) 846-2800
Fax (650) 846-3795

Visit our Web Site at
www.eimac.com



FOR THE BEST PRICE

& 24 Hr service on transmitting tubes & sockets/parts, new & rebuilt call Goodrich Ent. at 402-493-1886 day or night, www.goodrichenterprises.com

SPACE IS
AVAILABLE!

EMPLOYMENT

POSITIONS WANTED

Extremely knowledgeable and articulate racing writer/talk show host Adam Amick is available for snows, correspondent, features, etc. Check out www.bleacherreport.com for samples. Call 214-384-5812 or email: adam@rubbinsracingshow.com.

A highly enthusiastic challenge seeker! Skilled in Adobe Audition & digital editing! Highly qualified for copy/news writing & delivery and/or live broadcasting. Kayla, 231-613-2807 or abskayla8162@yahoo.com.

Friendly, relatable, professional female broadcaster. Strong producing, copy, voiceover and editing traits. Creative and versatile, diligent plus self-

motivated. Open and honest. Danielle, daniellefranklin266@gmail.com or 469-401-4667.

Hard work behind the scenes at a TV station! Perfect for me. Recent graduate with an associate in Broadcasting looking for work. Control room any. Mahogany Crowder, 405-601-2524 or mcrowder.mnc@gmail.com.

High energy, driven individual with on-air/Play-by-Play experience. Hard working and does what it takes to get the job done. Jonathan, 607-239-4580 or jkilment0220@gmail.com.

Mature, laid back gentleman with an outgoing personality. Looking for work. News - On-Air - VO will come ready to work. Ron Ackerman, theack1957@yahoo.com or 405-584-0668.

Musical, Professional, and Creative Vocal Images. Rick Hays has enthusiasm, passion, and vigor - ready to work for you. For details call, 724-413-4029 or rhays7@hotmail.com.

On-Air, Creative Copywriter with production skills. Call me. Let me light up your social media. In Oklahoma but willing to relocate. Young, energetic and ready to work. Brittany Dickson, 405-496-3012 or Brittanydickson1912@gmail.com.

Are you a small market station needing a good nuts & bolts engineer in the Los Angeles area? I will make your station shine! CET, fully FCC Licensed. Available for Full/Part-time/Contract work. Available immediately. Mitchell Rakoff, 909-446-6820, mitchellrakoff@yahoo.com.

Passionate Broadcaster/Writer. Curiosity that grows and love of knowledge seeking challenges to further my passions. On-air/VO/News/Production - well versed, creative and flexible. Melody, 817-701-6778. Melodywilson817@hotmail.com.

Sports Aficionado, with powerful production capacities too! Tenacious team-player, broadcasting/programming skills, plus stellar statistician ability. Tony, 302-750-2575 or parktony1014@gmail.com.

Experienced radio station manager seeks new management opportunity. More than 39 years experience in radio. Willing to relocate. Family-friendly format(s) preferred. Send details about your management opening to: radiogm@hotmail.com.

Go West, Young Broadcaster!

At CBI conference, terrestrial radio is still relevant to hopeful students

STUDENT MEDIA

BY JENNIFER WAITS

The week before Halloween, College Broadcasters Inc. held its annual National Student Electronic Media Convention in Seattle.

Student broadcasters from college and high school radio and television stations spent a few days connecting with peers and learning from media experts.

CBI's largest solo event to date, the conference drew approximately 400 attendees from around country and attracted some 70 vendors and guest speakers.

Sessions ranged from roundtable discussions to "how-to" panels delving into aspects of broadcasting. Topics included social media, live performances, fundraising, news reporting, sports, FCC regulations, and audio and video tips.

In many cases, students presented practical advice on how to do a particular aspect of TV or radio broadcasting. The conference was capped by the annual CBI National Student Production Awards, which was preceded by a keynote presentation given by Seattle broadcast personality John Curley.

Curley gave an inspirational speech about his own circuitous career trajectory. He encouraged aspiring broadcasters to find a mentor and to use "reverse goaling" in order to get to that perfect job — by that, he means that one should imagine one's dream job and then plot out different jobs that will be stepping stones to reach that goal eventually.

This was my third CBI conference; as a California resident, I was happy that CBI came to the West Coast for the first time. According to CBI Secretary Jamie Lynn Gilbert, West Coast attendance was up considerably compared with the 2013 conference in San Antonio.

In addition to reporting on the conference, I spoke on two panels. I shared tidbits from my college station visits — I've been to more than 80 stations — in a panel about the diversity of college radio, and talked about college radio history on another panel.

Before the conference kicked off, I spent my first day in Seattle touring stations, including public radio station KEXP(FM), streaming college station Rainy Dawg at the University of Washington, streaming college station UWave



Radio promotional items collected at CBI and during radio station tours.

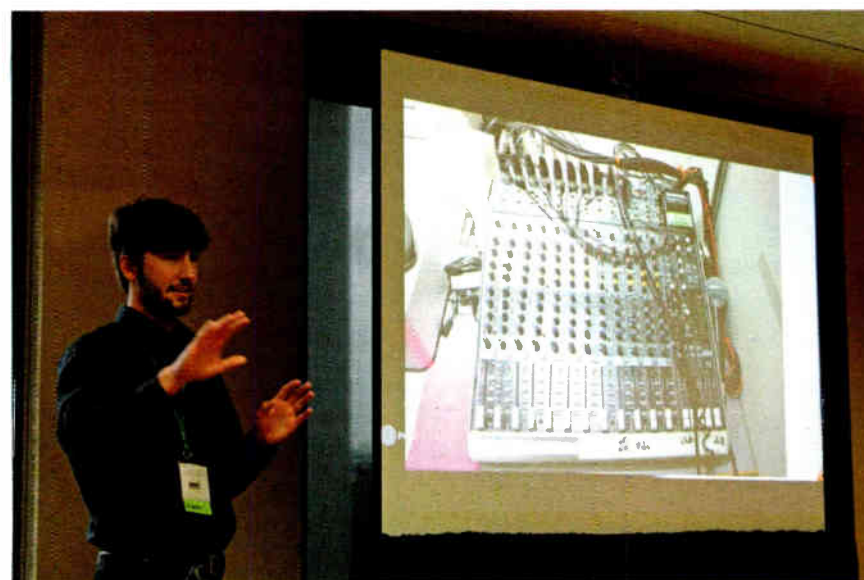

Taylor Jones, KWVA(FM) music director, describes the logistics of live sessions.

Radio at University of Washington-Bothell and streaming community station Hollow Earth Radio (which will soon be on low-power FM). The following day, I squeezed in a trip to KXSU(FM), formerly KSUB, at Seattle University.

One of the resounding themes of the conference was that terrestrial radio is still relevant to student broadcasters. A session led by Mark Maben of WSOU(FM) and Ross Reynolds of KU'OW(FM) focused on the staying power of over-the-air radio and also on the current renaissance in audio, with increased attention on podcasts. While Internet radio is important, they pointed out that much of that listening is moving to mobile devices.

LPFMS HIGHLIGHTED

I was amazed to visit three stations in Seattle that had recently received low-power FM construction permits, two of which are at colleges (UWave and KXSU).

The recent LPFM application window was definitely embraced by Seattle nonprofits; it was exciting to see some of these forthcoming stations in person.

CBI acknowledged the LPFM opportunity and held two sessions with these stations in mind. In an interesting bit of serendipity, at an LPFM roundtable discussion, participants represented stations in various stages in the process. Students from Humboldt State University in California are already on the air



A view into the exhibitor space at the CBI event

with KRFH(LP), while KXSU (Seattle University) and Aggie Radio (Utah State University) and Rice University and Loyola University-Maryland were still awaiting word from the FCC (both in mutually exclusive groups, competing with other applicants for their frequencies).

Saturday morning, another session, "Low-Power FM for College Broadcasters," went into the nitty gritty details of how KXSU navigated the application process. It was exciting to hear about these stations, and it's a reminder that terrestrial radio is still relevant to young people.

While touring KXSU, I asked General Manager Shannon Phelps why they wanted an LPFM.

She told me that it was the "next step to legitimize our station" and said that she expected that the station would become even more popular. She acknowledged that young people don't listen to radio as much but said that terrestrial radio draws people in, telling me that "the idea of being on the radio is still really appealing ... [and] empowering."

SWAG SWAP, SHOW AND TELL

Another highlight was the number of sessions devoted to live music.

I saw panels during which students from WKNC(FM) of North Carolina State University in Raleigh and KWVA(FM) of the University of Oregon in Eugene talked about how they produce live music series for their stations. They walked the audience

(continued on page 30)

CBI

(continued from page 29)

through the trials and tribulations of filming musicians and offered tips on how to create and promote videos of in-studio performances.

You can view past sessions on WKNC's "the Lounge" YouTube channel (<https://www.youtube.com/user/wknc881fm>) and on KWVA's YouTube channel.

An annual tradition at CBI is the Swag Swap, in which stations bring promotional items to give away or trade. This year's swap was in a large, dimly lit room during cocktail hour. While sipping on a variety of beverages, attendees buzzed about the room collecting prized items. T-shirts, tote bags, temporary tattoos, stickers, coasters, drink cozies and buttons were most common. I also spotted some LPs, mouse pads, pens and match boxes.

Another session, the "Radio Show and Tell," was a less frenetic setting for stations to share their work.

While some students modeled T-shirts (and a hand-knit sweater, made by a listener and adorned with the station call letters), others played snippets of airchecks and production. We heard a variety of material, including sports play-by-play and color commentary, witty station IDs and news stories. It was a nice opportunity to hear the sounds of so many different stations.

TEACHING RADIO TO KIDS

One of the most feel-good moments of the convention for me was a panel about radio camps and classes for kids and teens.

Both WLOY (Loyola University-Maryland) and WGMU (George Mason University) outlined programs



College Radio Day President Anthony Saia is station manager of KUOI(FM) at the University of Idaho.

that they run for aspiring broadcasters. While neither has an FCC license, both are heard online and via other distribution channels; and WLOY airs a low-power AM signal.

WGMU hosts summer camps for teenagers during which they teach many aspects of radio and production.

WLOY has several shows that air kid-produced content, does a summer radio boot camp for kids, and has also built small radio studios in local elementary schools.

I'd be remiss if I didn't mention that the CBI conference had a

number of sessions geared toward high school radio stations.

One roundtable discussion also talked about the best ways to recruit high school students to one's station. Having met a number of college radio volunteers who started in college radio while in high school, it's clear that the radio bug is still attracting some of the youngest listeners.

As the conference wrapped up and I returned to drought-plagued California, I left with warm feelings for both the Seattle noncommercial radio scene and for my college radio colleagues from all over the country. The next CBI event will be held in Minneapolis in October 2015, followed by Philadelphia in 2016. I'm plotting my station visits already.

Jennifer Waits is co-founder of Radio Survivor and a research associate on the Library of Congress' Radio Preservation Task Force. She says she obsessively tours radio stations, which she chronicles on her blog Spinning Indie. A college radio DJ since the 1980s, she's volunteered at four stations and has hosted a music show at KFJC(FM) since 1999.



Shannon Phelps, general manager of KXSU(FM), shows off a banner that reflects Seattle University's new LPFM call letters.

CORRECTION

Matt Sammon's commentary about HD Radio in the Nov. 19 issue included the sentence "Don't pretend the window is closing." It should have read "Don't pretend the window isn't closing."

RADIOWORLD
The News Source for Radio Managers and Engineers

Our readers have something to say:

"I have been a reader of Radio World for many, many years and have always appreciated its boots-on-the-ground approach."

Gary L. Ellingson, MBA, CPBE
Director of Engineering
Northwestern Media
St. Paul, Minn.

HEIL SOUND
www.heilsound.com

ADVERTISER INDEX

This listing is provided for the convenience of our readers. Radio World assumes no liability for inaccuracy.

PAGE	ADVERTISER	WEB SITE/URL
23	Bohn Broadcast Services	www.ohnbroadcast.com
7	Comrex Corporation	www.comrex.com
1	ENCO	www.enco.com
25	Gorman Redlich Mfg	www.gorman-redlich.com
30	Heil Sound, Ltd.	www.heilsound.com
18	Henry Engineering	www.henryeng.com
11	Inovonics Inc	www.inovonicsbroadcast.com
13	Moseley Associates	www.moseleysb.com
6, 10	Nautel Ltd.	www.nautel.com
4	Radio Systems Inc	www.radiosystems.com
21	Ram Broadcast Systems	www.ramsyscom.com
22	Sandies	www.sandiesusa.com
9	Tieline Technology	www.tieline.com
2, 16-17, 32	Wheatstone Corporation	www.wheatstone.com

**CREDIBLE
AUTHORITATIVE
INFORMATIVE
INSPIRING**

WE'VE GOT YOU COVERED.



creativePLANET
network.com

next|VIDEO
Conference + Expo

**Government
VIDEO EXPO**

The Industry's Most Trusted Brands

For more information, contact:

Subscriptions: Visit www.nbmedia.com | Advertising: Eric Trabb, 212-378-0400 x 532; etrabb@nbmedia.com

**NewBay
Media**

WHAT WILL YOU DO WITH EIGHT STEREO AUDIO PROCESSORS IN A SINGLE, NETWORKABLE RACK SPACE? HERE ARE A FEW SUGGESTIONS...

<p>Low Latency Talent Headphone Processing</p> 	<p>Remote Feed Conditioning</p> 	<p>Talkshow Call-Ins Processing</p> 
<p>Microphone Processing</p> 	<p>Satellite Uplink Peak and Spectral Control</p> 	<p>IFB Conditioning</p> 
<p>STL Pre-Processing and Protection-Processing</p> 	<p>Process Multiple HD Feeds</p> 	<p>Codec Pre-Processing</p> 
<p>Sweetening Incoming Commercials and Newsroom Feeds</p> 	<p>Automation Stream Processing</p> 	<p>Web Stream Processing</p> 

Highest performance 24-bit A/D and D/A converters • AES67 compatible • Two 8-channel utility mixers • Silence sensors • Gigabit Ethernet
Eight complete Wheatstone multiband processors, EACH with: 4-band parametric equalizer, 3-way crossover, 3 compressors, 3 limiters, final lookahead limiter



AURABIP
8-CHANNEL NETWORKABLE AUDIO PROCESSOR
Convenient, cost-effective, and incomparably capable