



# RADIO WORLD

JANUARY 1, 2010 | The News Source for Radio Managers and Engineers | \$2.50 | RADIOWORLD.COM

## INSIDE

### ON THE EDGE

• New products in studio routing infrastructure. — Page 28

### NEWS & ENGINEERING

• Readers respond to our problem of ospreys on the STL dipole. — Page 10

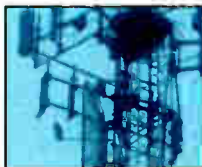

• Bob Struble says AM/FM can no longer take its position in the auto infotainment space for granted. — Page 18

### STUDIO SESSIONS



• Radio Road Warrior talks to field reporters about their favorite mics. — Page 24

### OPINION

• Scott Taylor thinks some AMs are losing their grip on reality. — Page 32

## TV Fights Repurposing Ch. 5 & 6

### MMTC's 'Rescue Petition' Draws Reactions

BY LESLIE STIMSON

**WASHINGTON** — The Federal Communications Commission is reviewing public comments filed regarding the "Radio Rescue Petition" proposed this summer by the Minority Media Telecommunications Council.

Twenty-two comments and 10 replies were filed on the 17 mostly technical proposals.

The MMTC wants the FCC to set up an "AM transition federal advisory committee" in regards to re-purposing TV analog Channels 5 and 6 for radio, echoing proposals made by other groups.

MMTC also proposes to modify AM nighttime coverage rules, replace the minimum efficiency standard for AMs with a minimum radiation standard, tweak certain FM classes in Zones I and

*(continued on page 8)*

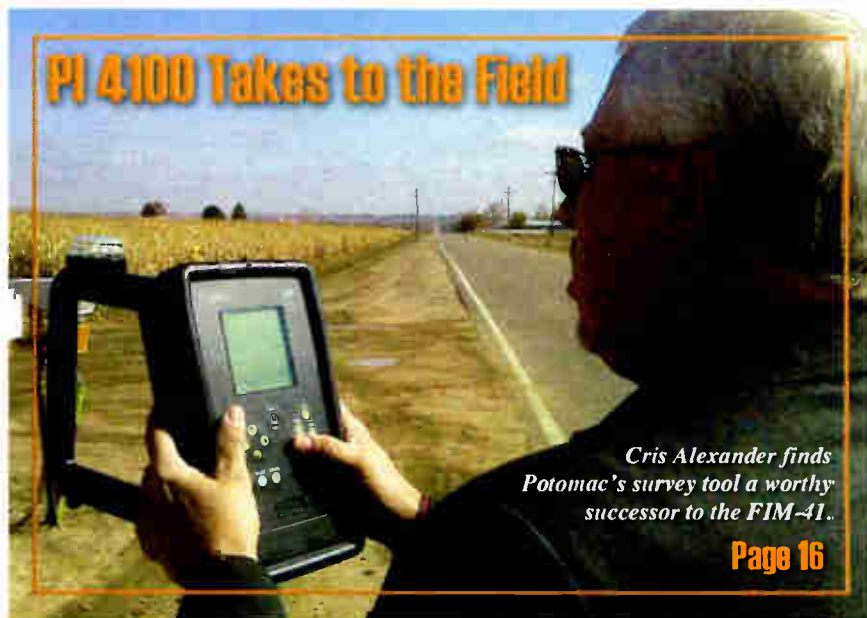

**PI 4100 Takes to the Field**

*Cris Alexander finds Potomac's survey tool a worthy successor to the FIM-41.*

**Page 16**

## Voice From Home: Broadcasting in Vietnam

### It Was a War, Yet Service Personnel Tried Keep Their Sense of Humor

BY RICK BEDNAR

At first you think you've been dropped off "at the end of the earth." Then the blast of hot air hits you as you exit the plane.

### FIRSTPERSON

This is 1968 — and this is war in Vietnam.

The first shock I remember was the rockets coming in at 3 a.m. to our

holding station at Long Binh. We were told to roll out of our bunks and pull our bedding on top of us for protection.

After a couple days at Long Binh, I was assigned to the Armed Forces Vietnam Network headquarters in Saigon. AFVN was a complex of radio and TV stations in the heart of the city. The U.S. government had built and equipped an identical broadcast center for the Vietnamese right next door to

*(continued on page 12)*



## Bridge-IT low-cost IP STL audio codec

# Tieline

tieline.com/bridge-it

World Radio History

**Now Shipping**

**800-750-7950**



IT IS THE MOST MUSICAL OF ALL PROCESSORS...



## VORSIS GOES TO 11!

It's been said that D-Minor is the saddest of all keys. But to truly understand that, you need to be able to HEAR D-Minor. That's where Vorsis comes in. Because, you see, it's also been said that Vorsis is the most musical of all processors - this coming from engineers around the world. No matter which Vorsis processor you choose, you can be assured your legions of fans out there will be getting the cleanest, most detailed sound you can deliver. And, as a bonus, you'll save money doing it!

Using Vorsis is as easy as owning it. Just pick a preset from the many that cover just about every format there is, and you're off! Want to tweak things to get your own signature sound dialed in? Vorsis' toolset is unparalleled, offering you deep control over every nuance of your sound.

There are a ton of technical particulars that we're sure you'll want to read about, so we've made it easy to find them on our website. Grab 'em. Read 'em. And give us a call. We'll be happy to get you set up before you find yourself residing in the "where are they now?" file.

WHEATSTONE  
**VORSIS**

It's Time YOU Won The Ratings War.™

phone 1.252.638-7000 | [www.vorsis.com](http://www.vorsis.com) | [sales@wheatstone.com](mailto:sales@wheatstone.com)



# DataFM Hopes for Role in New EAS

Patented System Uses RBDS to Embed Warning Data Via FM

BY RANDY J. STINE

*This is one in a series of profiles of companies involved in emergency alerting.*

**RINGGOLD, GA.** — Broadcast technology company DataFM believes the Federal Emergency Management Agency should give serious consideration to using the Radio Broadcast Data System, and specifically the company's patented software, when the government agency releases specs for a new digital emergency alert system.

DataFM says RBDS, a communications protocol standard for embedding small amounts of digital information in the subcarrier of terrestrial FM radio broadcasts, is an underused technology that is well-suited for public warning uses.

The DataFM system is a multi-use, point-to-multi-point communication system that is both geographic and demographic specific, according to the company's Web site. The system is being used for emergency messaging in every hospital in the state of Georgia, according to the site.

Other firms have pushed FEMA to use RBDS technology as part of a new EAS, most notably Global Security Systems and its Alert FM product. DataFM officials contend their product is

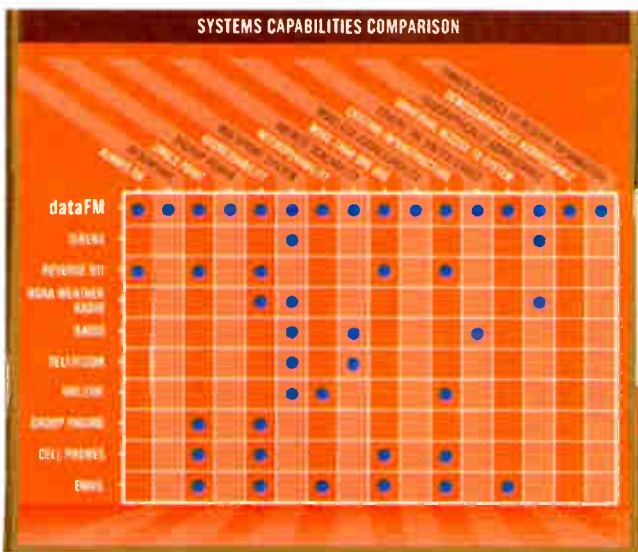

DataFM offers visitors to its Web site a chart comparing the benefits of its alerting approach to other systems such as reverse 911, cell phones and e-mail.

broadcast gear from people you trust



Lowest Prices and Largest Inventory on EVERYTHING For Broadcast

**BSWUSA.COM**

**800-426-8434**

better than others available because it can specifically target geographic areas and demographic groups.

"Our patented technology is individually addressable. That is what makes us unique. We can message a very specific group of people. Essentially, it is a point-to-point system," said Marshall Bandy, president of DataFM.

Global Security Systems disputes DataFM's claims that it alone can send targeted and addressable information. "We do a similar type of geo-targeting," said Matthew Straeb, executive vice president for GSS.

The DataFM patent, which was issued by the United States Patent and Trademark Office and titled the "Codeable Programmable Receiver," speaks for itself, Bandy said.

However, using any kind of patented technology worries some EAS observers, who would prefer that FEMA choose an "open, non-proprietary" set of systems for EAS.

A proprietary system like DataFM's "is 180 degrees out of phase with the parameters of what the Partnership for Public Warning set down as a premise for warning systems," said one EAS observer.

The Partnership for Public Warning was a non-profit consortium of government and private industry groups that looked for ways to improve public warning from 2001 until it was disbanded in 2005.

## SCHOOLS & HOSPITALS

Bandy said his company's primary role in Georgia is notification in the event of a pandemic on behalf of the Georgia Division of Public Health. The company also is part of the Atlanta Metropolitan Medical Response System, which includes 22 counties around metropolitan Atlanta.

"We also have the system installed in all of the Atlanta public schools," Bandy said.

The company uses the subcarriers of approximately 34 FM radio stations in the state, Bandy said, to send text and other data via RBDS. That includes 13 Georgia Public Broadcasting stations.

Radio stations — some of which are paid what the company describes as a modest fee — are equipped with a satellite receiver and RBDS equipment, which allows the stations to scroll song title and artist information to car radios capable of receiving RBDS data, Bandy said. However, only a DataFM receiver, which the company sells for \$200, is capable of receiving warnings.

More than 550 individually addressable RBDS receivers are deployed in Georgia, Bandy said, most of them in schools, hospitals and emergency centers.

DataFM, founded by Bandy in 1997, has met with the FCC's engineering staff and pitched the RBDS platform and its digital EAS capabilities, Bandy said. The company has been active in

*(continued on page 5)*

29,641 products in stock at press time!

## The 2010 BSW Catalog Is In Your Mailbox!

It's Our Best Ever, Filled With All The Latest Broadcast Gear at the BEST Prices!



**Brand New at bswusa.com!**  
**Get Quotes, Quick & Easy!**

At [www.bswusa.com](http://www.bswusa.com), every product has a convenient "Add it to a quote" button. When done building your quote, simply submit it and we'll be back to you with the best prices and delivery in the industry. It's THAT easy!



**Broadcast Supply Worldwide**  
**Knowledgeable Sales Staff**

BSW's sales professionals have decades of real-world broadcast and recording experience to offer expert help with your purchase.



# KRVN: A Rural Voice for Nebraska

Someone like me — who was born in Manhattan, grew up within sight of its skyline and has always lived in urban/suburban areas in the Mid-Atlantic — can't truly appreciate the connection that an agricultural community has to its farm radio station. But we can enjoy reading about it, and learn more about the role radio has played in our country.

Normally I might tell you about new publications; today my thoughts are about a 2002 book that just crossed my desk, sent by the director of engineering at the Nebraska Rural Radio Association, Rod Zeigler.

"KRVN: The First 50 Years of Service to Agriculture" is the story of "the Rural Voice of Nebraska." Published by the station, the paperback by station veterans Max Brown and Eric Brown relates how some 5,000 farmers and ranchers cooperated to create a broadcast outlet, an "off-farm tool" that would serve the needs of



**FROM THE EDITOR**



Paul McLane

Nebraska farmers.

The launch was prompted by events in the late 1940s including the discontinuation of local grain market broadcasts; the creation of a new farm station in Ohio, WRFD; and the impact of a nasty blizzard that was not well covered by Nebraska radio.

Thus a 25 kW daytime station at 1010 kHz was born. The authors give us a station history, super photos, detailed program schedules, copies of correspondence and a comprehensive staff list. There's a good description of KRVN's fight to move to 50 kW on 880 kHz, which finally occurred in the early 1970s, and the facility challenges involved in that project.

The broadcast family eventually grew to include KRVN(FM), KNEB(AM/FM) and KTIC(AM)/KWPB(FM), which is now KTIC(FM). Visit KRVN's Web site and you'll see immediately that it

remains a rural voice for Nebraska.

The photos here give a flavor. Fans of radio history, farm radio or KRVN itself will enjoy it. You can obtain a copy for \$12.95; contact KRVN via its Web site at [www.krvn.com](http://www.krvn.com).

The book also prints the charming words and music to "The Ballad of KRVN."

*They're hard-working people feedin' the nation  
No matter what the pay  
Livin' their lives with their kids and their wives  
Cause they love the country way  
And they built themselves a radio station.*

The station will turn 60 in 2011.



**Yes - I'm A Member  
Are You?**

**YES! I'M HELPING TO THROW NEW LIGHT ON NEBRASKA'S AGRICULTURAL PROBLEMS BY BEING A MEMBER AND SUPPORTER OF:**

**NEBRASKA RURAL RADIO ASSOCIATION**

**HERE'S HOW—**

The NRRA Will Foster:

1. More Public Discussion on Taxation, Schools, and Roads.
2. Improved Market Reports on Livestock, Grain and Produce.
3. Up-to-the-Minute Weather Information
4. More Information on the Results of Agricultural Research.
5. Wholesome Radio Entertainment for the Whole Family

**OUR GOAL—**

A State-wide Radio Station Owned and Controlled by Farm and Ranch People of Nebraska!

**YOU CAN HELP . . . JOIN ME TODAY!**

**Dial up a Winner!**

The new Doane survey of farmers' radio listening habits is in. And the Doane computer shows farmers and ranchers prefer KRVN by more than 4 to 1 over any other station. \*

For news, weather, markets and the best music in the country, Nebraska farmers and ranchers dial 880 for KRVN.

\*1983 Doane CAMS Class 1 Farmers, 51 Nebraska Counties 5 a.m.-12 midnight Monday through Friday. Average Share

THE RURAL VOICE OF NEBRASKA  
**KRVN**  
**880 Farm Radio**  
50,000 watts - Lexington, Nebraska

A 1984 promo flyer.



**Around the World,  
Across the Spectrum,  
Your Single Source  
For Broadcast Solutions**

Electronics Research, Inc. delivers innovative, high-quality, integrated solutions for broadcasters around the world and across the spectrum. When planning your next broadcast system call us toll-free at 877 ERI-LINE or visit us online at [www.eriinc.com](http://www.eriinc.com).

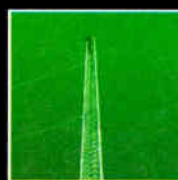

**ELECTRONICS RESEARCH, INC. ERI**

Antennas | Transmission Line | Filters/Combiners | Towers | Broadcast Services

## THIS ISSUE

JANUARY 1, 2010

## NEWS

TV Fights Repurposing Ch. 5 & 6 .....	1
Voice From Home: Broadcasting in Vietnam .....	1
DataFM Hopes for Role in New EAS .....	3
KRVN: A Rural Voice for Nebraska .....	4
Newswatch .....	5
The Leslie Report .....	6



## FEATURES

Workbench: Give Those Birds the Brush-Off .....	10
PI 4100 Takes to the Field .....	16
The Race for the Dashboard Is On ...	18



## GM JOURNAL

Discover the Power in Just :05 .....	20
Create Effective, Charming Ads .....	22
Who's Buying What .....	23

## STUDIO SESSIONS

Microphones Make News Stand Out .....	24
Do-It-Yourself DJ Comes to DRS Virus .....	26
On the Edge: Studio Routing Infrastructure .....	28-29



## OPINION

AM, Losing Its Grip on Reality .....	32
'Progress Toward a Common Ground' .....	33
Reader's Forum .....	33-34

## DATAFM

(continued from page 3)

filing reply comments to several FCC Notice of Proposed Rulemakings concerning public warning.

"We believe it is important to utilize the FM band. The existing ubiquitous infrastructure is there. It's already built. This is the highest and best use of the technology.

"It's important for radio broadcasters to embrace the opportunity. This is a chance to be in the communications business but outside of the realm of entertainment only. It's communication with the ability to deliver information by addressing it to geographic and demographic specific groups. This is the largest area of the wireless arena yet to be tapped," Bandy said.

In addition to future in-car delivery of alerts via RBDS, DataFM theorizes that someday an FM radio data chip could be implanted in all newly marketed cell phones and similar electronic devices, which would be capable of receiving text alerts.

## 'TOO MANY LINKS'

One supporter of DataFM's efforts believes the company is on the cutting edge of a technology that could really improve public warning in this country.

"This is very forward-thinking technology, opposite of what EAS has been to this point. Both EAS and the old EBS suffer from the same cancer; too many

links in the daisy chain," said Stephen Rutherford, market director of engineering for the Beasley Broadcasting cluster in Las Vegas.

"The (DataFM) system allows you to send a message to a specific receiver or receivers. Others can flood the area with pages, but DataFM is a targeted system."

Rutherford had experience with DataFM when he worked for Archway Broadcasting Group in Columbus, Ga., and installed a DataFM RBDS system in one of the group's FM radio stations. He later did some equipment installation work for DataFM, though he said he is not lobbying FEMA on behalf of the company.

"The DataFM system is heads and shoulders above anything the current or enhanced EAS is capable of achieving," Rutherford said.

Bandy, a former radio station owner who has been involved in RBDS since the mid-1990s, said, "RBDS gives FM radio stations an opportunity for additional revenue at a time when they need it most. In addition, there is the community service aspect of airing public warnings."

Some veteran EAS watchers have expressed concern over companies using FM subcarriers to disseminate public warnings.

"How much are they willing to pay for the use of a station's RBDS capabilities?" asked one such observer.

Bandy declined to release any information in regards to what the company pays an FM radio station for the use of a subcarrier.

FEMA has been criticized by some in the EAS community for not acting quickly enough on EAS. FEMA has been working on its Integrated Public Alert and Warning System since 2004 and an executive order in 2006 ordered them to finish it.

A Government Accountability Office report in September faulted the Department of Homeland Security for FEMA's lack of progress on EAS. Among other things, it found that FEMA kept poor records of how much money it had spent on implementing an improved EAS. The GAO report on EAS also said FEMA has failed to integrate alternative media, such as cell phones, BlackBerrys and the Internet, into EAS.

FEMA has said it hopes to adopt the Common Alert Protocol (CAP) Version 1.2 in early 2010. DataFM officials say their system is CAP compliant.

FEMA announced in early December 2009 that it had adopted specifications for the gateway interface for the Commercial Mobile Alert System, which will allow emergency managers to send geographically targeted text messages via cell phones beginning in 2012. Alerting companies, including DataFM and GSS, are pushing for the inclusion of an FM radio data chip in cell phones, capable of receiving RBDS text messages.

A FEMA official told Radio World earlier that the agency would study RBDS for alert and warning integration into IPAWS (Radio World, July 1, 2009).

FEMA officials declined to comment for this story.

## NEWSROUNDUP

**RADIO SHOW:** The National Association of Broadcasters and the Radio Advertising Bureau said they would expand their relationship and jointly produce the fall radio convention, to be held in Washington in 2010.

**LPFM:** By a voice vote, the U.S. House passed a bill to drop third-adjacent channel protections for most full-power FMs in order to fit more low-power FMs on the band. The measure moves to the Senate.

**SNOWE BILL:** Sen. Olympia Snowe, R-Maine, introduced a bill that would potentially add one electrical engineer or computer scientist to the staffs of each commissioner of the FCC. Society of Broadcast Engineers President Vinny Lopez said the bill will go a long way toward returning technical expertise to the commissioners' offices.

**HD RADIO:** About 734,000 HD Radio receivers were sold in 2009 as of early December, twice as many in 2008. That's according to iBiquity President/CEO Bob Struble at the Virtual Event's "Monetizing Audio Technology" conference. About 28,000 HD Radio receivers sold in 2006, he said; that increased to 140,000 in 2007 and 366,000 in 2008. About 1.3 million HD radios total have been sold to date, he said.

**CLARKSON:** Gary D. Clarkson died. He co-founded processor manufacturer CRL Systems along with the late Ron Jones. The company went public in 1983, and purchased Orban in 2000. Orban President Jay Brentlinger described Clarkson as "an inspiration for my involvement in CRL and later Orban." The two were both former chief engineers for Phoenix radio stations in the 1970s and 1980s.

**LLOYD:** FCC Chief Diversity Officer Mark Lloyd says he's no "czar" appointed by President Barack Obama to restore the Fairness Doctrine. He also said he's received death threats and hate mail after being criticized by conservatives over the defunct doctrine, which mandated that stations air opposing views.

**U.S./MEXICO:** Mexican and U.S. officials, in discussions over communications issues, laid out a plan for what they'll talk about in the next couple of years. It includes work on an agreement toward protection of television stations on Channel 6 from operation of some FMs along the border; technical criteria involving digital radio along the border as well as to eliminate "claimed harmful interference to Mexican radio stations allegedly caused by the temporary operation of U.S. stations using the IBOC system"; a possible new framework agreement for TV services; and working to finalize verification of a database of AM stations in 535-1605 kHz.





Selected content from Radio World's "The Leslie Report" by News Editor/Washington Bureau Chief Leslie Stimson. To receive the free, bi-monthly e-mail newsletter, subscribe at [www.radioworld.com/subscribe](http://www.radioworld.com/subscribe).

## TOWNS GIVES PARTIES 30 DAYS FOR NEXT STEP IN PPM DISPUTE

The multi-hour Capitol Hill hearing on the Arbitron Portable People meter in December crystallized some issues in the debate over whether the PPM methodology undercounts minority listeners.

The upshot is that Rep. Edolphus Towns, D-N.Y., chairman of the House Oversight and Government Reform Committee, gave all parties 30 days to come up with some sort of plan and "a realistic timetable" to reach an agreement. Otherwise, he said he's prepared to move on a legislative solution, though he didn't say what that would be.

For the first time, I heard exactly why the Media Rating Council has accredited the PPM in only two out of 30+ markets.

MRC Executive Director/ CEO George Ivie said there's little doubt PPM is an improvement over diary ratings and Arbitron has made some improvements in how it persuades people to wear the meter; however he said the voluntary watchdog group that looks at all ratings providers has ongoing concerns. (MRC accreditation of PPM matters to Arbitron because acceptance by an independent body is like the Good Housekeeping Seal, according

to Ivie. It gives broadcasters, advertisers and their agencies confidence in the ratings system.)

Response rates are lower than what MRC expected, he said, and the lower the response rate, the less likely that sample is representative of the population in a market. Non-compliance rates concern

**I heard exactly why the Media Rating Council has accredited the PPM in only two out of 30+ markets.**

MRC; Ivie said in general, across the population, some 25 percent of PPM panelists don't wear their meter every day, and the percentage is higher for young people and minorities. The numbers are worse among African-Americans; 40 percent of this demo doesn't carry their meter every day.

"That puts more stress on your sample," said Ivie, who said these are the issues on which MRC wants Arbitron to improve. MRC won't grant accreditation in more PPM markets until that happens. "It's about in-person contact, more intense training for pan-

elists" and making sure a panel is more representative of a market, he said.

Ivie stressed that the MRC wants to see "sustained improvement" in these areas for PPM markets. It has only accredited PPM in Houston and Riverside, Calif. Some of these performance metrics have now dropped in Riverside, Ivie said, and the MRC is trying to figure out how to handle that.

Only in Houston does Arbitron use both in-person PPM coaching and recruitment; that's because its system was set up when it still thought Nielsen was going to be a partner in PPM, according to Arbitron CEO Michael Skarzynski in his testimony. (The idea was that Arbitron and Nielsen would share the rollout costs, which was left unsaid. The two now are competitors for radio ratings service in some markets, though their methodologies for electronic ratings differ.)

Ceril Shagrin, head of corporate research at Univision, said PPM panels of meter-wearers are too small and that in-person recruiting is not a luxury, but rather a necessity. "What's good enough for Houston should be good enough for the rest of America." She said Arbitron should stop the rollout of PPM in additional markets until it receives MRC accreditation. Arbitron should recruit more people to wear the meter using cell-phone-only households with less reliance on address- and land-line-based lists, she said, to get more African-American and Hispanic listeners to wear the meter.

Arbitron is working on the CPO-only issue and Skarzynski said the company does use some in-person recruiting, noting that last weekend he helped a meter-wearer in a household in Prince George's

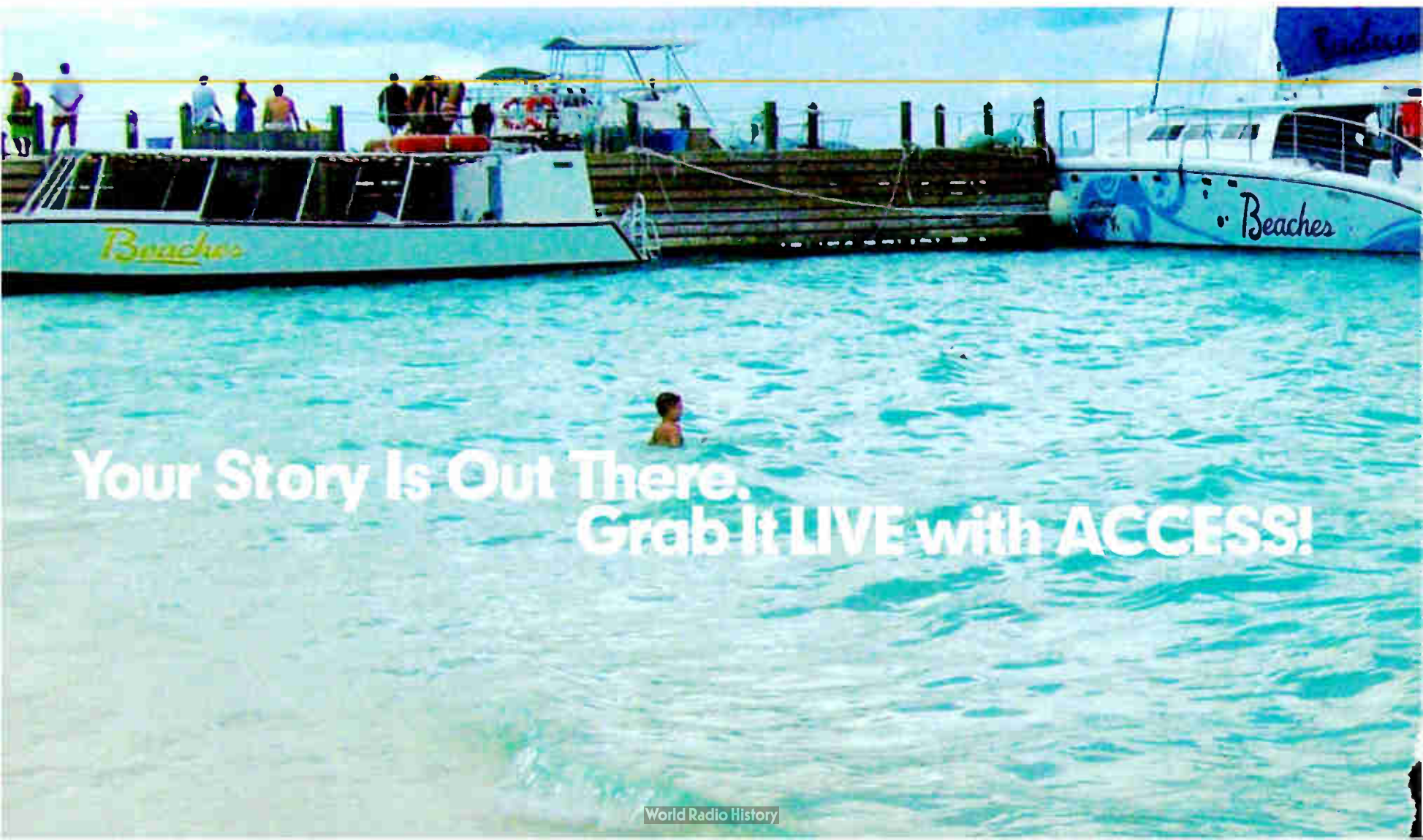

Your Story Is Out There.  
Grab It LIVE with ACCESS!



County, Md.

I've reported that the committee has been looking into PPM after a coalition of African-American and Hispanic broadcasters appealed to Congress saying their ratings have dropped dramatically in markets where PPM has been introduced, costing them ad revenue. These groups say the PPM methodology is flawed and that Arbitron refuses to acknowledge the problems.

Skarzynski said the methodology is solid and that the technology is not to blame for the "challenges minority broadcasters face."

"While PPM represents an important advance, it cannot do everything," like pay down the high debt service faced by stations, he said.

Arbitron has been making changes as it seeks MRC accreditation. For example, he noted the company has expanded its use of CPO sampling and this year began asking questions about country of origin in its recruitment process. The latter was a real mindset change for the company, noted Frank Flores of Spanish Broadcasting System, in the next panel.

### LIGGINS: ECONOMY, NOT PPM, IS HURTING MINORITY STATIONS

In the Hill hearing about PPM, Rep. Edolphus Towns characterized Arbitron as an "unregulated monopoly" several times, setting a strident tone for the day. But it's unclear what legislators can or might do about the dispute.

I don't think Congress can tell Arbitron to bring

back the diary in PPM markets and continue to run both services in those areas; that also would be prohibitively expensive. And the rub is that while stations say they're paying up to 60 percent more for PPM ratings than they do for the diary, if Arbitron actually did more in-person recruitment, that would add to the costs as well.

**There is always a learning curve with new technology. I'd rather get that out of the way now.**

— Al Liggins

Charles Warfield of ICBC Broadcast Holdings said his company's African-American-targeted stations have experienced a "disproportionate reduction" in PPM ratings compared to the diary. He suggested one way to solve the issue may be to release minority stations from their "burdensome" contracts with Arbitron.

Radio One CEO Al Liggins disagreed with his fellow broadcasters, saying "PPM is neither affecting diversity of our airwaves nor contributing to a [ratings] decline." Rather, since PPM measures actual radio exposure, PPM is "exposing poor choices made in good times," referring to companies, like his, that became over-leveraged and took on too much debt.

"There is always a learning curve with new tech-

nology. I'd rather get that out of the way now."

The diary, Liggins said, was biased in favor of legacy stations with a strong brand; PPM plays no favorites, he said. In fact, from PPM, which offers a minute-by-minute look at listener tune-in and out, Radio One has learned that a strategy of long 40-minute music sweeps while clustering spots into one-20-minute break doesn't work.

Tom Joyner has almost totally revamped the elements of his morning show based on what he learned from PPM, Liggins said.

"We need to move forward with PPM, adapt to it and work with Arbitron to make it better," said Liggins. He noted that MRC accreditation takes a long time and the current system cannot offer a ratings company with concrete benchmarks to meet.

While Liggins suggested that new census data would help Arbitron update its panel samples, Jessica Pantanini, incoming chair of the Association of Hispanic Advertising Agencies, said that data won't be available for another two years. "If you can't draw an advertiser today, they won't be back. Without the numbers, we can't justify being in on a buy."

Rep. Darrell Issa of California, the ranking minority member of the committee and the only Republican lawmaker at the hearing, said he planned to draft a letter to Arbitron asking what the company can do to provide more analysis without increasing the burden on stations. Issa commented to Arbitron's CEO Michael Skarzynski that perhaps, if the PPM could be embedded in a cell phone, this problem would go away. Skarzynski said that's the next-gen product the company is looking at.



**LIVE & LOCAL**

IP • 3G • Wi Fi • 4G • BGAN / VSAT • PSTN • DSL

**ACCESS**  
STEREO BRIC IP CODEC

**THE ULTIMATE TOOL FOR  
REMOTE BROADCAST**



Put Comrex On The Line.

**COMREX**

[www.comrex.com](http://www.comrex.com)

19 Pine Road, Devens, MA 01434 USA Tel: 978-784-1776 • Fax: 978-784-1717 • Toll Free: 800-237-1776 • e-mail: [info@comrex.com](mailto:info@comrex.com)

World Radio History



## RADIO RESCUE

(continued from page 1)

IA, create a new "L" class of LPFMs and relax main studio rules. (It also wants the FCC to extend the three-year period for new CPs, look into a new radio agreement with Cuba, hold tutorials on radio engineering rules, create a "broadcast public engineer" position to help small businesses and nonprofits and make other changes.)

Much of the reaction concerned the possible re-purposing of Channels 5 and 6. What follows are excerpts of some of the initial comments; we'll have additional excerpts in a future issue.

### BENEFITS FOR FM AND AM

"Minority Media Telecommunications Council has endorsed the proposal submitted by Broadcast Maximization Committee for the use of the vacated spectrum in television Channels 5 and 6 (76-88 MHz) and has suggested the creation of an advisory committee in order to speed up the process of considering the merits of the proposal.

"BMC has proposed to (1) relocate the LPFM service to a portion of this spectrum space; (2) expand the NCE service into the adjacent portion of this band;

**The greatest benefit will be conferred to the AM service.**

– Broadcast Maximization Committee

and (3) provide for the conversion and migration of all AM stations into the remaining portion of the band over an extended period of time and with digital transmissions only.

"BMC believes that the benefits from this proposal to all of the broadcast services are enormous. Thousands more LPFM stations can operate — free from interference caused to their limited signals, without having to fight with FM translators over spectrum, without having to share the FM band and without subjecting LPFM stations to possible displacement while greatly expanding the service to new and diverse entrants.

"NCE stations will benefit from the expansion of its service and the location of this available space adjacent to the current reserved portion of the FM band, presenting a perfect opportunity for this expansion. Based on the large number of applications filed in the last filing window, there is a tremendous amount of interest in providing additional local and specialized NCE programming to diverse and underserved groups.

"The greatest benefit will be conferred to the AM service. ... BMC has developed a plan to convert and provide for the migration over an extended period of time for all AM stations to operate in the Ch. 5/6 band in the digital mode.

"Since the filing of the BMC proposal ... [r]epresentatives from Canada have contacted BMC and expressed its keen interest in the concept of using the Channel 5/6 spectrum for this purpose in Canada.

BMC recognizes there are also industry groups opposed to the plan and issues to overcome. As a result, BMC believes that an advisory committee may be a reasonable solution to the current impasse."

Broadcast Maximization Committee  
Birmingham, Ala.

### USE THE SPACE FOR LPFM

"The commission should not create a Local "L" class of LPFM stations and protect it from broadcasters maximizing their full-power station's facilities.

"While perhaps supported by an admirable ideal, such an approach could impede rather than advance radio's recovery from current economic doldrums and

**[An L class] could impede rather than advance radio's recovery ... and result in inefficient use of spectrum.**

– Educational Media Foundation

result in inefficient use of spectrum, and there are in any event alternatives that avoid these pitfalls.

"Similarly, MMTC's proposal that the FCC maintain a rule of 10 translator applications per applicant is especially troubling for long-standing FM translator licensees/applicants like EMF. Like the L-Class proposal, the goal underlying this restriction — providing opportunities for new LPFMs — can be equally well met by proposals to re-use vacated analog TV Channels 5 and 6, which avoid restricting or otherwise harming FM translator licensees, applicants and listeners.

"Instead of the limit MMTC proposes, the FCC should, per EMF's related proposal last year, reallocate vacated analog TV Channels 5 and 6 to FM broadcasting and reserve the top two or three channels of that spectrum for LPFMs, rather than moving forward with mass dismissals of FM translator applications and/or proposals that would harm translator services on which the public has come to rely.

"Making this spectrum available to LPFM is preferable to simply shuffling the decks by trading existing or potential translators in favor of LPFM service, and in that regard the reallocation-and-reservation would do much more to add new services and opportunities."

Educational Media Foundation  
Rocklin, Calif.

### DISRUPTIVE IDEA

"MMTC suggests tasking the Channel 5/6 Committee with evaluation of a proposal by the Broadcast Maximization Committee to relocate certain incumbent digital television stations operating on television Channels 5 and 6 to new television channels in order to accommodate the migration of radio stations to television Channels 5 and 6.

"[T]he committee is unnecessary because the commission already has determined that continued use of Channels 5 and 6 for television service is in the public

interest. Moreover, adoption of any recommendation by the Channel 5/6 Committee to reallocate Channels 5 and 6 to radio services would be disruptive to both the DTV transition process and viewers and, therefore, would be contrary to the public interest."

Disney-ABC  
Washington

### NO SPECTRUM GRAB

"Signal Above is the licensee of low-power television station WDCN(LP), Fairfax, Va., serving the D.C. metro area on Channel 6. It is currently operating as an analog facility and has expended considerable resources to construct and operate its facility. ...

"Any alleged need to expand the FM band to provide relief for AM broadcasters and LPFM has been significantly addressed already by the commission's new rules allowing the use of FM translators by AM stations as well as legislation well on its way to passage that would allow for greatly enhanced opportunities for expanded LPFM service.

"Lastly, the transition to digital has effectively allowed for the tripling of the number of radio signals as more and more stations go digital and broadcast on channel HD1-HD3. The need to expand the band does not exist and certainly not at the expense of eliminating existing Channels 5 and 6 LPTV broadcasters who are already providing valuable service.

"[E]limination of Channels 5 and 6 affects far more than the approximately 20 full-power television stations that already have post-transitional licenses on Channels 5 and 6. It affects hundreds of low-power stations like Signal Above and their viewers.

**Contrary to the suggestion of MMTC, there has never been less of a need to expand the FM band.**

– Signal Above

"Contrary to the suggestion of MMTC, there has never been less of a need to expand the FM band. AM stations will be on an equal footing with FM stations as the transition to digital progresses. Furthermore, the commission has provided immediate relief to AM broadcasters by allowing the use of translators which doubles the signals for many AM stations by providing both an AM and FM signal of the same programming in a market. ...

"Further, the answer to the argument that not all AM stations have access to available translators is to open a translator window for AM stations, not to grab spectrum already being used by LPTV operators. ...

"Signal Above proposes that the commission reject the MMTC proposal or consider alternatives which will both protect LPTV broadcasters and their viewers and provide for expanded radio service.

"One suggested option is that all full-power and low-power stations licensed on Channel 5 or 6 be grandfathered and that otherwise any available frequency in the 7688 MHz band could be used for expanded radio service."

Signal Above  
Fairfax, Va.



# BUY AN OMNIA 5FM. GET AN UPGRADE TO AN OMNIA 6EX. ON US.



**Limited Time.**

**Offer will be withdrawn with no notice when we come to our senses.**



**Omnia**  
A Telos Company

Radio Never Sleeps. Neither do we. We're here for you, anytime, with free round-the-clock, 24/7 technical support. Call +1-216-622-0247.

© 2010 TLS Corp. OmniaAudio.com



# Give Those Birds the Brush-Off

Readers Respond to Our Problem of the Ospreys on the STL Dipole

In conversations with several contract engineers, I've been amazed at the number of transmitter sites they find with no transmitter ground strap connected.

## WORKBENCH by John Bisset

Read more Workbench articles online at [radioworld.com](http://radioworld.com)

Depending on the power line ground is risky. Fig. 1 shows a good example of proper grounding, as found at the Entercom Scranton cluster stations.

One contract engineer recalls a site where he found ground strap stuffed in a hole in the floor — connected to nothing!

Every couple of columns, we have focused on things that engineers "will get around to doing" but somehow never do. Remember the transfer switch interlocks that weren't connected? Fig. 2 shows both control and interlock wiring connected, as it should be.

With respect to grounding issues, don't assume a thing. Tug on that ground strap next visit to the transmitter site and make sure it's properly connected.

Thanks to Dan Pregnar and his crew at Entercom Scranton/Wilkes-Barre for the pictures of how to do things right.

You'll recall Bruce Blanchard's osprey invasion in our column of Nov. 18.

Well, readers, you've come through again. Here are some great suggestions for keeping birds away from the STL dipole.

Tony Wortmann of Radio.comm does contract work for seven stations and manages a business band sales and service operation. He offers a cheap fix that has worked for him: Place a bright spot light below where the birds perch and shine it upwards. If you don't have power on the tower, just run a power cord connected to a 500-watt halogen light mounted below their nest.

They'll find a better place to nest and leave the STL alone.



Fig. 1: Proper transmitter grounding. Make sure the ground strap is connected to ground.

Tony can be reached at [agwortmann@juno.com](mailto:agwortmann@juno.com).

Cox Radio Tampa's Roz Clark offers a tactic used by some Florida seaside restaurants to keep birds out of outdoor dining areas.

This solution too is inexpensive; it involves heavy gauge nylon fishing line. Roz's suggestion is to run several lengths of the line from the feed (perch) out to the rim of the dish, in several radial directions.

The monofilament will have negligible wind load effects and won't cause an issue with winter icing or the RF feed itself. The birds will not light on the feed horn protected this way.

Roz writes that he has not tried this approach, but may because he encounters seasonal groups of snowbird vultures that load up his STL tower every spring and fall. Although

birds have not caused any degradation of the STL feed, their droppings have degraded the roof of the STL shack. You don't want to look up when the birds are roosting.

Roz Clark can be reached at [roz.clark@coxradio.com](mailto:roz.clark@coxradio.com).

William MacDonald is CE for KMIK(AM) in Phoenix. His solution to the birds on the STL feed horn is to provide them with a better place to perch. Installation of an ice shield above the STL dish will protect the feed horn from falling ice and offer the birds a flat surface for eating their fish.

Bill MacDonald can be reached at [billmac25@gmail.com](mailto:billmac25@gmail.com).

(continued on page 12)



Fig. 2: Buy a pre-wired RF switch connection cable to ensure that control and interlocks are connected properly.

# Inovonics — your RDS/RBDS experts!

BRAND YOUR STATION on RDS Radios, and on Cell Phones & MP3 Players with FM!

**NEW!**  
**INO 703**



**Model 703**

- Scrolls static promo or ad messages
- AF list identifies translators
- Easy USB setup



**Model 720**

- Scrolls song titles, promos, ads
- Direct RS-232 connection to automation
- Easy USB or serial setup with PC



**Model 730**

All the features of the 720, plus...

- Supports UECP and RT+ song 'tagging'
- USB / Serial / LAN-Internet connectivity
- Easy jog-wheel or PC setup

**OUR BEST!**

**i Inovonics**  
800-733-0552

For full specifications, visit... [www.inovon.com](http://www.inovon.com)



Is setting up IP Audio networking tables a bit frustrating?

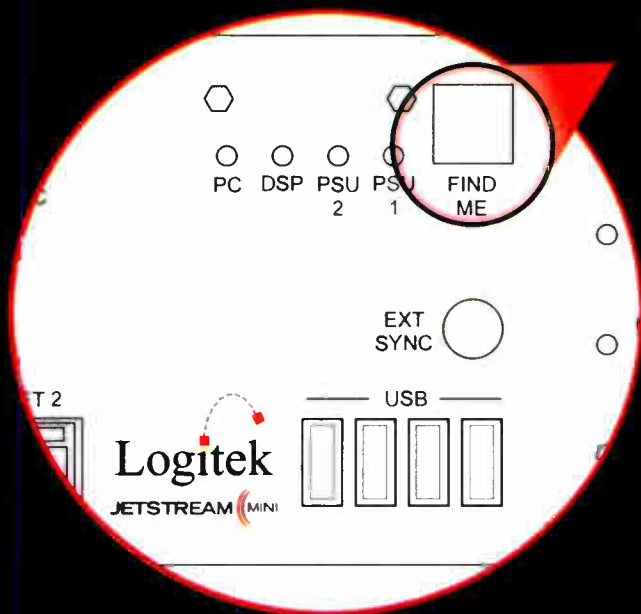
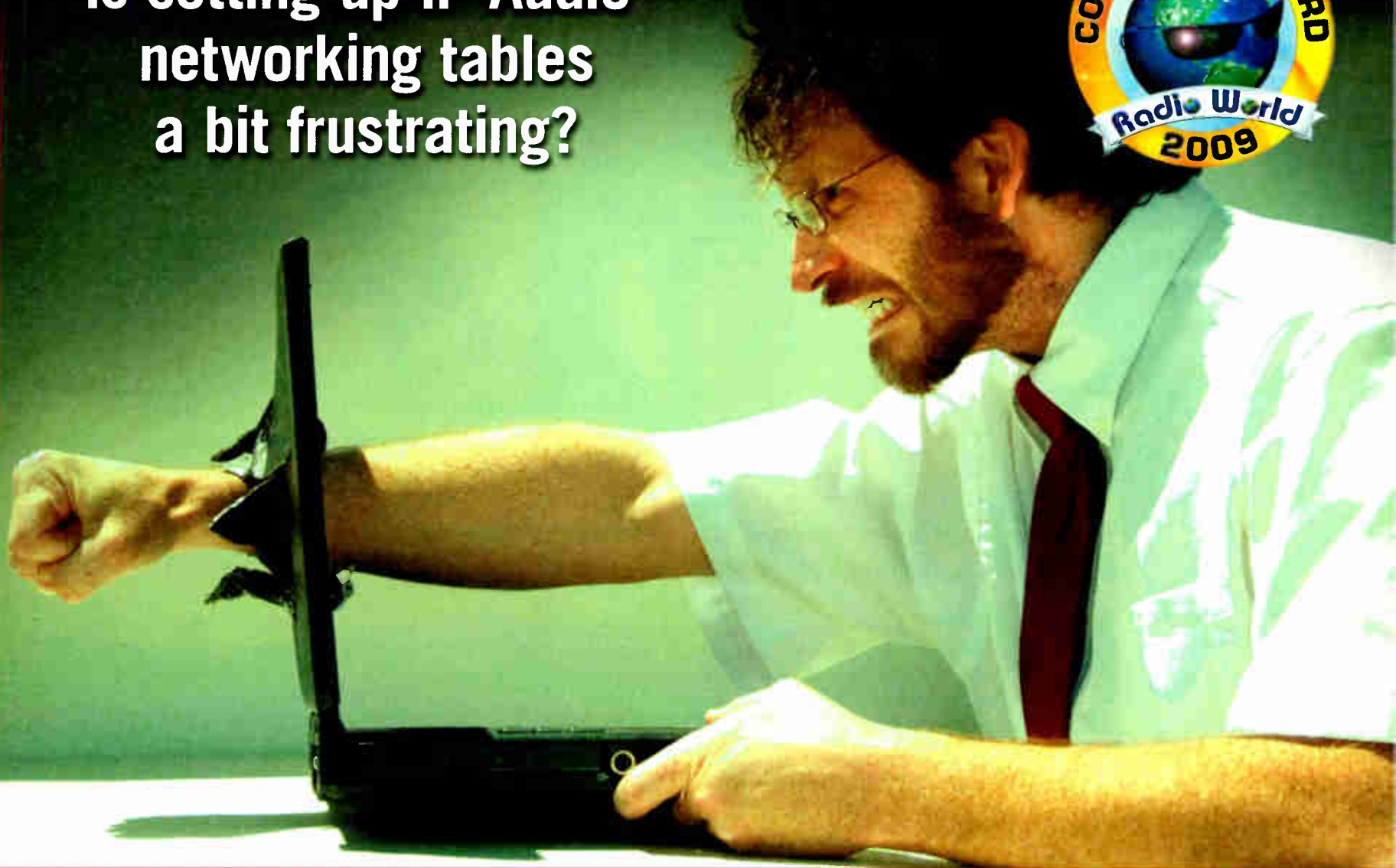

Try the One-Second JetStream approach.

Press one button to find other JetStream units on your network and automatically configure your system.

You'll save time, money and rack space, while enjoying the convenience of Logitek's next generation IP audio routing solution.

Call today **800.231.5870** for more information or to schedule a demonstration.

**JETSTREAM** (MINI)  
©2009 Logitek Electronic Systems, Inc.

Next Generation IP Audio  
**logitekaudio.com**

**Logitek**  
Console Router Systems



## VIETNAM

(continued from page 1)

our building.

I arrived at the station a couple days after the infamous Tet offensive. Every soldier was on high alert. The Vietcong had set off a car bomb in front of the building, blowing out the station's windows. Luckily, the bomb went off in the middle of the night and no one was injured.

I remember walking into the lobby and seeing large pieces of glass embedded in the wall opposite of where the windows used to be. Clearly, this was going to be a broadcast "experience" unlike any I'd had previously.

### 'TOWN AND COUNTRY'

I had started in radio in junior high school working at WAIK(AM) in my hometown of Galesburg, Ill. Eventually I moved to WGIL(AM) in Galesburg, working there during high school, and, later, during breaks from college at the University of Illinois in Champaign. There, during my senior year, I started as a weatherman, game show host and booth announcer at WCIA(TV), Channel 3, a CBS affiliate.

With the Vietnam War in progress, I enlisted in the Army after college graduation, in hopes of having some say in what I was going to do in the service. Most everyone in the Army knew they would eventually serve in Vietnam.

AFVN had personnel from many branches of the service. Radio-wise, it consisted of a Saigon FM station and a master AM control that fed programming to various Armed Forces stations located up and down South Vietnam. Each of these stations had its own staff and programming, but was required to take certain programs from the network headquarters in Saigon.

## WORKBENCH

(continued from page 10)

If all else fails, resort to modified spike strips!

Wayne Eckert is the assignment manager for Channel 1 Images. Wayne suggests having a local plastic shop cut a strip of 1/4-inch Plexiglas or Lexan in a sawtooth pattern. The length of the strip should be shorter than the length of the feed, with the narrow sawtooth spikes cut higher than the length of the offending bird's legs.

This "spike strip" can be mounted to the feed with black nylon wire ties, with the spikes facing up of course.

In theory this should make it diffi-

I was assigned an afternoon air shift on the FM station, and an evening two-hour country music program on the network feed to all the stations in Vietnam.

My evening program was called "Town and Country." I started out including 15 minutes of listener requests, but eventually devoted a full hour to requests, as I quickly began to get so many. I got mail from personnel throughout Vietnam, as well as from Navy men at sea. Guys requested songs dedicated to their wives or girl friends or family members. I also received many requests from Vietnamese listeners who liked American country music.

One of the thrills for me was hearing from a college friend, Mark Krueger. Neither of us knew the other was in Vietnam.

Mark remarked later, "I was serving in an artillery unit in the field when one evening I turned on my portable radio. As

**I remember walking into the lobby and seeing large pieces of glass embedded in the wall opposite of where the windows used to be.**

I recall, it was a country music show. And darned if I didn't recognize the voice on the air as that of Rick Bednar. I'd gone to college with him back in Champaign. I was never really fond of country music but I was so happy to hear a familiar 'voice from home' that I listened to that show each evening from then on."

### BELATED WISHES

At AFVN, we had an excellent staff and top-notch equipment. Nothing was "too good for the troops." If we needed a new cart deck, for example, the Pentagon sent two. Our staff included many talented news reporters who went

cult for the birds to land and uncomfortable for them to sit if they do. Additionally, a bright colored plastic as a visual warning can deter landing.

So we've loaded Bruce up with a good number of solutions. We'll let you know what he tries, and how successful the remedies are, this spring.

*John Bisset marked his 40th year in broadcasting in October. He is international sales manager for Europe and Southern Africa for Nautel and a past recipient of SBE's Educator of the Year Award. Reach him at johnbisset@myfairpoint.net. Faxed submissions can be sent to (603) 472-4944.*

*Submissions for this column are encouraged and qualify for SBE recertification credit.*

on to stateside network news operations after their military service.

I worked with the late Gary Gears, who had previously been a DJ on



That's me at AFVN radio headquarters in Saigon in 1968 ...



...and today, in my home recording studio.

WLS(AM) and WCFL (AM) in Chicago, and, later, went on to a prominent commercial voice-over career. Our "most famous" AFVN on-air personality was a great guy and our "Good Morning Vietnam!" morning show host. He was Pat Sajak, who would go on to host "Wheel of Fortune."

People sometimes ask me if the Robin Williams movie "Good Morning Vietnam" is true to life. I enjoyed the movie but feel it was primarily a stage for Williams' considerable ad-lib comedy skills. At the "real-life" AFVN, we never had the freedom to "tweak the military brass" or the U.S. government like Williams did in the movie.

Like hundreds of other Armed Forces broadcasting personnel serving around the world, our job was to entertain and inform the troops and help boost morale.

We were proud to bring a "voice from home" to those in the field whom we all admired very much. They were the heroes of the war, in our eyes.

### SORRY MR. PRESIDENT

Today, I've retired from WCIA(TV) and enjoy running my recording studio specializing in radio commercial production and television voice-overs.

But I often reflect on my Vietnam experiences. We were in the middle of a war, yet I think most service personnel there were able to keep their sense of

humor.

Pat Sajak recently told me about a humorous experience he had while hosting his AFVN morning show.

"President Nixon was scheduled to deliver a Christmas television address to the nation in 1969, and, due to the time difference (and the fact that satellite technology was in its infancy), we were carrying it only on radio during my morning show," Sajak recalled.

"I was playing music as usual, but monitoring the CBS network in one ear. When I heard the president being introduced, I broke in to my music and said, 'And now the president of the United States.' I flipped a switch, and the speech could be heard throughout Vietnam.

"Nixon came to a moving conclusion, and there was silence as he began shuffling his papers. I flipped the switch again and resumed my show," Sajak continued.

"A few seconds later, I was horrified to hear through that same ear that he had resumed speaking. Not only that, he was sending Christmas greetings directly to the troops in Vietnam, who were listening instead to the 1910 Fruitgum Company's rendition of '1, 2, 3 Red Light.'

"I could have admitted my mistake and gone back to the speech, but I figured there was no point in doing that because I was the only one in the world who knew that Richard Nixon was directing his comments to only one soldier: me!

"So if you were in Vietnam at Christmastime in 1969, allow me to wish you a belated Merry Christmas from Richard M. Nixon!"

*The author owns and operates a recording studio in Champaign, Ill., specializing in radio and television voice overs and spot production. He is retired from WCIA(TV) in Champaign where he had a 42 year career as a writer/producer, television weatherman and announcer. Contact him at bednar-rick@yahoo.com*





# “Go ahead caller... you’re on the air.”

Telos was first to use Mp3 technology, first to see the possibilities of ISDN, first to bring a DSP-based product to broadcasting, a hybrid by the way. Breakthroughs and innovations adopted years later by everyone else.

So, let’s take our next call, shall we?

It’s the Nx12, our most powerful performer, giving you the one-two punch of the latest Telos hybrid technology and audio processing by Omnia for the cleanest, most consistent call quality ever.

Nx12 has four advanced digital hybrids, each with its own AGC, noise gate, and caller override dynamics using carefully tuned DSP algorithms. Each also includes DDEQ, a sophisticated multi-band equalizer, which analyzes and adjusts received audio spectral characteristics so that calls sound smooth and consistent despite today’s wide variety of phone sets and connection paths.

Let’s face it, most people today are calling in on a cell phone. We get it. So, the Nx12’s hybrids incorporate special echo cancellation for tricky cellular and VoIP calls. Unique to Telos, the Nx12 has an adaptive function that reduces the possibility of feedback in open speaker applications. So go ahead... put that talkshow on remote with an audience.

Available in analog or ISDN Versions. Nx12 can connect to as many as 12 analog POTS lines or up to 6 ISDN BRI lines (which would provide 12 caller channels). A digital switch matrix inside the Nx12 connects the lines to hybrids. The Nx12 works with all Telos control surfaces including the Desktop Director, Call Controller, and Console Director. Talent and producers benefit from the unique Telos features, such as our exclusive Status Symbol visual call management icons which clearly show line and caller status.

And, it’s backed by the best support team in the business. The highly caffeinated 24/7 support techs.

## Telos Nx12: 12 lines. No waiting.



*Telos*  
AUDIO | NETWORKS

© 2010. Telos and Omnia are trademarks of TLS Corp.



Radio Never Sleeps. Neither do we. We're here for you, anytime, with free round-the-clock, 24/7 technical support. Call +1-216-622-0247.



# PowerStation: the new console system from Axia.



## Because there's no such thing as too much uptime.

**All stops removed** • Twenty years from now, you'll have forgotten this ad. But you'll still have your PowerStation, the full-featured one-box IP-Audio console/router system hardened with **industrial-grade components** and redundant power capabilities. Tough enough to take a football to the groin and keep on going. PowerStation **minimizes setup** and **maximizes "bang for the buck."** Engineered without compromise for broadcasting without interruption.

**Easy as  $\pi$**  • PowerStation combines a console DSP engine with audio and logic and a network switch, **all in one box**. As its name implies, there's a whole lot of muscle inside that burly frame, but that doesn't mean it's complicated. In fact, setting up PowerStation **couldn't be easier**: connect your studio gear with standard CAT-5 cables, connect your console with just one cable, name your sources and set preferences with a browser, and you're ready to rock. PowerStation makes building studios about 3.14 times easier than ever.

**GPI Oh!** • **GPIO ports are built in** to PowerStation — no breakout boxes or add-on converters needed. One day, you might not even *need* logic ports: more and more products from companies like 25-Seven Systems, Audio Science, ENCO, Google Radio Automation, International Datacasting, Omnia Audio, Radio Systems and Telos (to name just a few) use the Livewire™ standard to send their audio and logic control directly to Axia networks over a **single CAT-5 connection**.

**Everything's included** • Yeah, we said *everything*: PowerStation combines half-a-dozen essential tools into one compact unit. No hidden extras to buy, no "gotchas" after purchase. Inside that muscular chassis you'll find a **bulletproof mixing engine** capable of handling consoles up to 40 faders, a beefy power supply (with optional **redundant power**), machine control ports, and **audio I/O**, all in one box. And of course, since it's from Axia, the IP-Audio experts, a studio built with PowerStation can stand alone — or it can become a part of a large network quite easily. Thanks to **PowerStation Simple Networking**, you can daisy-chain up to 4 PowerStations directly for easy multi-studio installation without the need for a separate core switch. Just another way Axia makes IP-Audio easy.

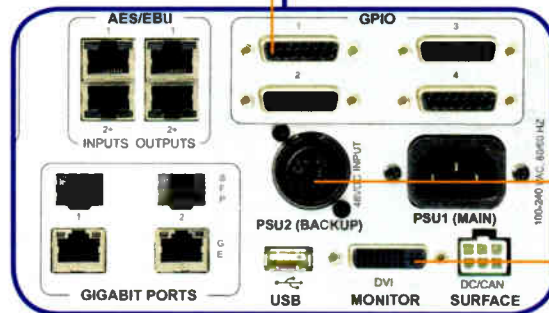
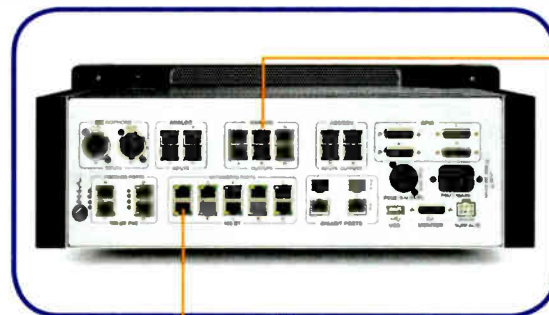

**E-I-E I/O** • Finding space in the equipment racks is like living in a barnyard: too many chickens, never enough coops. So our team of obsessive designers fit **an entire studio's worth of inputs, outputs, logic and network connections** — plus an advanced DSP mixing engine and a massive console power supply — into just 4 RU. There's inputs for 2 mics, 4 analog inputs and 2 AES/EBU inputs, with 6 analog and 2 AES outputs. 4 GPIO/O logic ports round things out. Want even more? Just connect the PowerStation Aux to instantly *double* the I/O — or plug some Axia Audio Nodes into its **built-in Ethernet switch**.

**Fan free** • PowerStation is **silent and fanless**. Because studios today are already full of PCs, laptops and playout servers clicking, whirring and generating heat — who needs more of that? Not only is there no in-studio noise with PowerStation, those **big extruded heat sinks** are just plain cool. No pun intended (or maybe it was. We're like that, you know).

**Built like a tank** • Remember when consoles were built to last? We do. At Axia, we're all about the long haul. **There are no compromises**: PowerStation uses only best-of-the-best components. Like studio-grade Mic preamps and A/D converters. A rigid, steel-framed, EM-tight chassis that shrugs off RF like Walter Payton brushing off tackles. An industrial CPU designed for high reliability in harsh environments. Beefy extruded heat sinks. Big, brawny handles to make rack-mounting easy. (And it looks cool, too.)

**Redundant power redundancy** • The power supply is the heart of any broadcast equipment, right? That's why PowerStation is **hardened against failure** with a **super-duty power supply** that sports enough amps to power an arc welder. And for those of you who like to wear a belt *and* suspenders, there's even a connection for **redundant auxiliary backup power** — with automatic switchover, naturally — that kicks in if it's ever needed.

**Screen play** • Yep, that's a DVI connector. **Your favorite monitor** — standard or widescreen — plugs in to present the console operator with Axia's "so easy an overnight jock could do it" **info-center display**. Meters, timers, fader assignments, mix-minus settings and more, all on-screen, on-demand.

### You're covered

Axia has the most comprehensive warranty in the industry — **5 years parts and service**. And (not that you'll need it), **free 24/7 technical support**, 365-days-a-year. We've got your back, my friend.







**Element 2.0** • With more than 1,000 consoles already on the air, Element is a huge hit. And now, thanks to suggestions from our clients, it's better than ever. Element 2.0 has cool features like Omnia™ **headphone processing** presets to give talent that "air sound"; **super-accurate metering** with both peak and average displays, **one-touch phone recording** with automatic split-channel feed, **automatic mix-minus** for every fader, an eight-channel **Virtual Mixer** that lets you combine multiple audio streams and control them with a single fader, and metallic bronze or silver module overlays. And we haven't even begun to tell you about Element's **Show Profiles** that instantly recall talent's favorite settings, its **built-in Telco controls**, fully-integrated **talkback/IFB** and **Mic processing** by Omnia. And durable? Element is nearly indestructible, ready to take whatever pounding ham-fisted jocks dish out and keep going. You want examples? Element's **avionics-grade switches** are rated for more than two million operations. What look like ordinary rotary controls are, in reality, **bullet-proof optical encoders** — no wipers to wear out or get noisy. The silky-smooth **conductive-plastic faders** actuate from the side, not the top, so dirt and grunge stay out. The **high-impact Lexan** module overlays have their color and printing applied on the back, where it **can't wear or chip off**. The frame is made from **thick aluminum extrusions** that are stronger than truck-stop coffee. To find out even more about Element, visit [AxiaAudio.com/Element/](http://AxiaAudio.com/Element/). Grab some coffee and prep for a good, long read — remember, our marketers get paid by the word.

**Come together, right now** • Now that you know what you can do with PowerStation, let's build a studio. The diagram below shows how a typical Talk Studio might look. Mics and headphone feeds plug into the built-in Mic inputs and Analog outputs... your playout PC, using the **Axia IP-Audio Driver** for Windows®, connects to a built-in Ethernet port... and so does the Telos Nx12 Talkshow System (which sends 12 lines of caller audio, mix-minus and take/drop/next commands over **one skinny CAT-5 cable**). Send a **backup audio feed** to your TOC for extra peace of mind. And after all that, there's still plenty of I/O left to plug in the turntables for the Saturday night Oldies show.

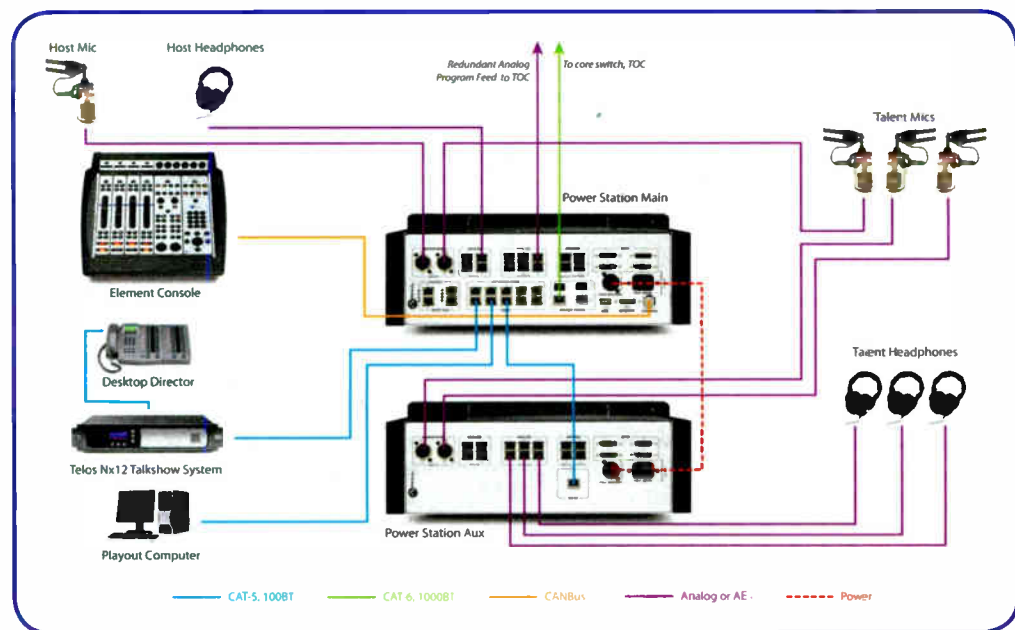

**The standalone network** • You want your console to be more than just reliable — you want it **built like a battleship**. You want the absolute peace of mind that comes from knowing your gear will **never let you down**. And if you take one studio down for maintenance, you want the rest to be completely unaffected. So we designed our **standalone network broadcast console that does it all**. It plays nice with others, but unplugs itself when you need it. At any pace you choose.

*Note to people planning studios:*  
Have you read the new book **Audio Over IP: Building Pro Audio Studios with Livewire** by Steve Church and Skip Pizzi? If not... Axia can save you 30% when you purchase a copy. Just visit [AxiaAudio.com/book/](http://AxiaAudio.com/book/)



[AxiaAudio.com](http://AxiaAudio.com)

© 2009 TIS Corp. Axia, Element, PowerStation, Telos, Omnia, TMTS Corp.



# PI 4100 Takes to the Field

Potomac's Third Generation of Survey Tool Is a Worthy Successor to the FIM-41

BY CRIS ALEXANDER

Field intensity meters, long a primary tool in AM field work, haven't changed much. I have in my inventory Potomac FIM-21s, FIM-41s and even a 1950s-vin-

## PRODUCT EVALUATION

tage RCA WX-2D (yes, it still works and "B" batteries are still available if you look hard).

Compare the old WX-2D to the FIM-21 or -41 and you won't observe a lot of differences in either form or function. Sure, the more modern FIMs are solid-state, but the construction and operation essentially are the same.

That has changed with the introduction of the Potomac FI-4100 field intensity meter.

The 4100 doesn't look anything like the legacy FIMs; it looks like something Dr. McCoy might have waved over a body before proclaiming, "He's dead, Jim."

Rather than a heavy metallic case and in-the-lid loop antenna, the case is molded plastic and the antenna is molded right in but perpendicular to the instrument body. It weighs only 5-1/2 pounds. Retail price is \$14,975.

### NO SCALES

There are no "scales" to select — there is just one continuous scale, from below 25  $\mu\text{V}/\text{m}$  to above 50  $\text{V}/\text{m}$  (or 28  $\text{dBuV}/\text{m}$  to 154  $\text{dBuV}/\text{m}$  if you prefer those units; both are displayed). There is no "meter" — the field intensity is indicated digitally and with an "analog" linear scale on the LCD screen. Accuracy is specified as 3 percent.

All of that is great — lighter weight, no need to calibrate, scale-less digital readout — but the new PI 4100 has something that no FIM before it has had: a built-in GPS receiver.

Together with the built-in flash memory for the storing of measurement data, this allows one-button onboard storage of field strength, distance, exact location, date and time. In my view, this is the defining feature of this piece of equipment.

When setting out to run a radial, per-

form walk-in or arc measurements, you won't need to take a clipboard and paper with you. Simply find the point, orient the meter and push the save button. Data can be retrieved later via a USB interface with the supplied software and stored to a .CSV (Excel text) file. From there you can do anything you want with it by way of for-

mally assigns a data point number (or you can change it), and each subsequent save automatically increments this number by one. So when running a radial, simply pressing save twice at each point increments the point number and stores the FI, distance, bearing, location, date and time, station and pattern ID, and other items.

### SPECTRUM DISPLAY

But there's more. The unit also



The PI 4100's ergonomic design makes operation simple.



The 4100 does not look anything like a traditional FIM.

matting, sorting, etc.

When I received the unit, it just took me a few minutes to create and store a station preset. Using the buttons on the front panel, I entered the call sign, frequency, station latitude/longitude and local magnetic variation.

Out in the field, I simply drove out the radial and then used the GPS bearing indicator to tell me when I was actually on the radial (it provides 0.1 degree resolution). As with any other FIM, the unit is oriented toward the station for the measurement. But what if the peak is broad and you can't simply "DF" the station for the peak? No problem. The display provides the magnetic bearing to the station. There is a wet compass built right in on top of the loop antenna, so it's a simple matter of orienting the unit in exactly the correct direction. Press save twice and you're done.

When you press save, you can enter information about the pattern and/or measurement point. For example, you could note DA-D, DA-N or ND. You can also enter the radial azimuth and the initials of the operator. The unit automati-

cally includes a spectrum display that can be handy in sniffing out the RF environment that you're working in. During my test radial, I looked at the spectrum and could clearly see the digital sidebands of the station I was measuring as well as those of the station just up the band.

The unit will measure up to 5.2 MHz, which is more than adequate to measure

### STRENGTH IN THE FIELD

Potomac describes the PI 4100 as its third generation of survey instrumentation for the direct measurement of electromagnetic field strength in the 520 kHz to 5.1 MHz frequency spectrum.

Intended as a successor to the FIM-41, it incorporates a "laboratory quality" radio frequency voltmeter, a calibrated, shielded loop antenna, an internal GPS receiver, an internal calibration source and data acquisition hardware and software.

"This device is equipped with an embedded microcontroller engine that obtains measurement data from the various transducers within the instrument and formats that data for display and, at the option of the user, stores it to memory."

Aspects highlighted by the company include a 116 dB dynamic range tuned RF voltmeter; digitally synthesized tuning in 1.0 kHz increments; spectrum display to facilitate compliance measurements (field strength, harmonic level and spectrum occupancy) in a single instrument; provisions for third-party calibration, using their laboratory standard, when it is impractical to return the instrument to the manufacturer; and data acquisition software and PC interface to enable collection, analysis and e-distribution of current field measurements. This last feature anticipates future acceptance of data e-filing by federal regulatory agencies.

Potomac says more than 80 units are in service now.

### PRODUCT CAPSULE

#### POTOMAC PI 4100 Medium-Wave Field Strength Meter

##### Thumbs Up

- + Ergonomic design
- + Measurement data storage
- + Integral GPS
- + Scale-less auto-calibration operation
- + Built-in wet compass

##### Thumbs Down

- Short battery life
- No mapping

Price: \$14,975

any third-order products or harmonics of interest, even for expanded band stations.

The 4100 comes with an internal rechargeable battery pack that Potomac says is good for five hours of operation. Battery voltage is continuously displayed on the screen, so there's not a lot of excuse for running out of gas. It also comes with an AA battery holder that you can fill with alkaline or lithium cells to carry with you for those times when you do run out of juice in the internal battery. In addition to the supplied AC power pack for recharging, a 12 V lighter-plug automotive power cord is supplied.

As one who has spent a lot of the last 30 years behind a field intensity meter, I really appreciate all the thought that went into the PI 4100. It brings together a magnetic field meter, GPS, onboard memory and computer interface in a way that will make the job of the person out making measurements much easier.

Walk-in radials can actually be walk-out measurements with just one person (instead of the traditional two-person



team). Drive-in measurements are much faster and safer without the need to check tuning, calibrate, note the field intensity and then try and remember it when you get back in the car.

**TWEAKS**

There are a few things that Potomac could have done better.

The five-hour battery life is too short to support a full-day's measurements, and if you try to lengthen it by turning the unit off between measurements, you'll find yourself waiting on a GPS



All the info is in one place on the LCD screen.

lock each time you turn it back on. That can add five minutes to each measurement point, which really defeats the purpose. Keeping that AA alkaline pack loaded with fresh batteries and in your pocket is not optional for that type of work. If you are driving between measuring points, the supplied cord allows you to recharge while traveling with the unit left on.

I found that I still had to take another GPS unit with me to navigate. While the internal GPS gives you coordinates, distance, azimuth from and bearing to the station, there is no map function, so you still need something to help you get there. I wonder how much more it would add to the cost to include a map feature to make this a truly all-in-one self-contained unit.

Finally, while the 4100 is comfortable to use, it is not particularly comfortable to carry. Its odd shape makes it somewhat difficult to transport. With a legacy FIM, after making a measurement, most folks either set the unit in the other seat on its back or put it in the floorboard behind their legs. Either option is not too attractive with the 4100. It is light enough that it is prone to slide off the seat during turns and stops, and it's just about impossible to safely put on the floor.

Those small issues aside, the Potomac PI 4100 is a home run.

*Cris Alexander, a longtime RW contributor, is director of engineering for Crawford Broadcasting and a recipient of SBE's Broadcast Engineer of the Year*

**MARKETPLACE**

**APTX CITES PERFORMANCE OF APT-X LOSSLESS**

APTX, which makes audio compression technology, said its new coding scheme apt-X Lossless "significantly outperforms" other lossless schemes in various situations involving transmission



of audio over wireless channels and networks.

"The improvements in performance demonstrated by apt-X Lossless relative to FLAC, for example, include a significant gain in compression ratio — up to 10 percent more data reduction — at time delays under 2 milliseconds,"

the company said, citing its own tests.

"This extremely low degree of latency is of critical importance in applications involving video, interac-

tive games and two-way communications."

It said the results should be of particular interest to manufacturers of consumer wireless audio devices.

"Such factors are critical in the design viability of next-generation consumer devices, such as 4G/LTE smart-phones and wearable, portable media players, and go-anywhere, touch-screen tablet computers."

For information e-mail the company in Belfast at [licensing@aptx.com](mailto:licensing@aptx.com) or visit [www.aptx.com](http://www.aptx.com).

**Where Great Radio Begins  
Harris® HPX®**

"This is where uncompromised operating efficiency and reliability meet outstanding value. The low power consumption, compact footprint and internal low-pass filter of the HPX high-power FM transmitter add up to real savings from the day it goes on air. Using field-proven Platinum Z/ZX® IPA modules and ZX-series switching power supplies, the HPX optimizes efficiency at every stage so your cost of ownership is lower for years to come.

HPX is designed for analog FM, HD Radio™ and FM + HD, with a selection of standard and enhanced control/diagnostic packages and exciters such as the unmatched Harris FlexStar®. When you need high operating power ready to meet any HD Radio power increase, HPX is the natural choice."

*Geoff Mendenhall, Vice President of Transmission Research and Technology at Harris, has been a key part of countless, groundbreaking, FM and AM transmitter designs for more than 30 years.*

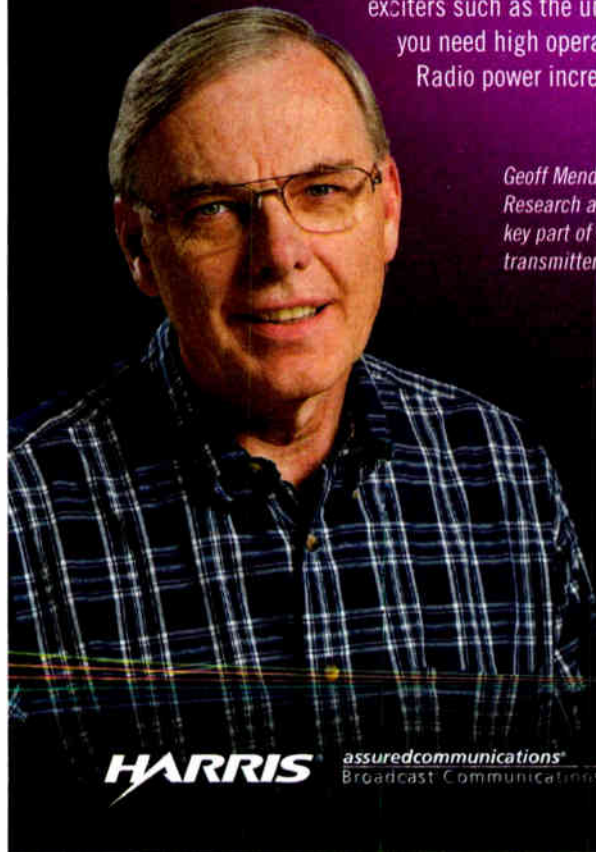

Learn more at [www.broadcast.harris.com/hpx](http://www.broadcast.harris.com/hpx) or (800) 622-0022.



assuredcommunications®  
Broadcast Communications • RF Communications • Core Network Communications Systems  
[www.harris.com](http://www.harris.com)



# The Race for the Dashboard Is On

## AM/FM Can No Longer Take Its Position in the Automotive Infotainment Space for Granted

BY BOB STRUBLE

*The author is president/CEO of iBiquity Digital Corp.*

For as long as any of us can remember, there has been a love affair between cars and radio. AM/FM was the sole

### COMMENTARY

source of information and entertainment for drivers, and car radios, quite simply, were never turned off.

Think of it: You shut off the ignition, but not the radio, and it came back on as soon as you fired the engine again. The only race was between broadcasters, fighting for presets.

Everyone won — automakers and their suppliers by providing more value to their customers, broadcasters who made an outsized portion of their revenues from in-car listening and consumers who voted with their ears and loved what they heard.

Bill Burton, the legendary Detroit radio ad man, had a great expression for this mutually beneficial relationship. He said, "An automobile is a radio with four wheels." Fabulous line, Bill.

A few years ago on a family car trip, it struck me that this decade's old truism no longer applied. My wife, five kids and I were driving to a vacation spot in western Maryland. Two of the kids were watching Sponge Bob on the DVD, which I was forced to listen to. Two were playing their Nintendo DS game devices. One was listening to his iPod. My wife didn't want to hear Sponge Bob, so she was listening to a book on tape.

At one point I thought, my goodness, there are seven consumers stuck in this car for three hours, and *the radio has not been turned on*. Ten years earlier, it would have been all there was to do. And this was prior to widespread mobile e-mail, texting and Web surfing, offering even more choices in the auto.

There is a reason Ford's CEO Alan Mulally will keynote again at this year's Consumer Electronics Show. And why

most automakers and their Tier One suppliers will be there, with booths or walking the CES floor. It's because the modern car has become a virtual consumer electronics playground, and CES has grown almost as important to car makers as the Detroit Auto Show.

Think of the CE devices that are routinely built into today's cars — I'm talking factory installed for the masses, not "pimp your ride" aftermarket stuff. Killer audio systems with multiple sources — AM/FM, Sirius XM, CD as well as USB and iPod connectivity. DVD video and gaming jacks for the rear seats. Navigation systems with real-time traffic updates. Bluetooth for safer mobile phone connectivity. Concierge and safety services like OnStar. And now mobile Internet connectivity. Voice activated everything. Coming soon: mobile television and true mobile broadband. And of course there are the standalone CE devices now routinely used in cars — mobile phones, gaming devices, MP3 players.

So what would Bill Burton's expression be now? An automobile is a *what* with four wheels? A computer? An office? A game room? Being a geek, I'd call it a mobile infotainment center.

#### AM/FM REMAINS FUNDAMENTAL

Don't get me wrong, AM/FM is still a fundamental part of the driving experience. Every car sold in this country comes with a radio, positioned square in the middle of some of the world's most valuable real estate: the car dashboard. But the days of AM/FM's monopoly hold on auto infotainment are long gone.

AM/FM can no longer take for granted that it will be automatically built into cars, or that it will be used by drivers. No, radio has to fight for its position in the dash.

The green flag has been waved in this race, and after starting in the pole position, radio is no longer leading the pack.

To mix my metaphors, this race will be run on two fronts.

First, to keep listeners interested in the car, radio broadcasters have to keep doing what they always have done, but do it better than they have ever done: create compelling programming, address the local tastes and needs of their audience, and promote their product like crazy.

**Car buyers will see factory installed iTunes Tagging in cars in 2010.**

But second, to meet the heightened demands of today's digital consumers, AM/FM has to offer more of what listeners have come to expect in a digital world: higher audio quality to take advantage of those great audio systems, more diverse content to compete with all those other choices listeners have, and more applications and interactivity to provide consumers additional value.

HD Radio technology is a new engine that can supercharge broadcaster efforts in this critical race — a digital broadcast pipe to consumers in their cars.

By improving audio quality — digital FM sounds like a CD and digital AM sounds like full stereo analog FM — HD Radio broadcasts allow listeners to experience AM/FM in the same high quality as their other digital audio sources.

With HD2 and HD3 channels, broadcasters are providing a diverse new set of programming choices to compete with all those other digital options. The progress on HD2 and HD3 channels has

#### CONTINUED PROGRESS IN CARS

"HD Radio Technology's rollout in cars continues impressively, as shown on the accompanying chart. A short while ago, HD Radio technology was available on BMW and Mini vehicles, and only as a standalone option. Now 15 different automakers are offering or have announced plans to offer HD Radio receivers factory installed in their cars.

"Luxury automakers like BMW and Mercedes, lower priced lines like Kia and Scion, as well as European, Asian and now the strongest American automaker, Ford, are on board. These manufacturers will offer HD Radio receivers in 80 different vehicle lines.

"And not only are more automakers offering the product, more consumers are taking it, as we move from a standalone option to having HD Radio technology included in option packages or, in the best case, being offered as standard equipment: HD Radio technology will be standard on 36 different vehicle lines. HD Radio factory auto sales have soared, and we expect significant additional launch announcements soon."

— Bob Struble

## PASSIONATE ABOUT RADIO?

...so are we



Sign up for a **FREE** Digital Subscription to **RADIO**WORLD

Visit: [www.myrwnews.com](http://www.myrwnews.com)

Experience the benefits and extra features that digital has to offer!

- No more waiting for your issues to arrive in the mail!
- Interactive content and reader experience
- Keyword search of current and archived issues
- No software to download
- Access issues from any computer via internet
- A **green** alternative to the printed version

OEM Automobile	
 <small>Standard/Optional Available Now</small>	 <small>Standard/Optional Available Now</small>
 <small>Standard/Optional Available Now</small>	 <small>Optional Available Now</small>



been accelerating, with nearly 1,100 new channels on the air.

Sports franchises like the Cowboys, Yankees, Penguins and Mets have multicast offerings. Religious (Mormon Channel), ethnic (WorldBand's HumDesi Southern Asian language programming) and lifestyle (Pride Channel) broadcasters bring new local and national offerings. And there are targeted local niche offerings: Boston's Irish Channel, DC's Bluegrass Country, Miami's Dance to name just a few.

And advanced HD Radio applications are finding their way into cars, providing consumers with more value from AM/FM broadcasts. Those walking the CES floor in Vegas will get a sneak preview.

**IMAGE SUPPORT NEXT HOT APP**

CES attendees will see real-time traffic data, as well as other valuable info like gas prices, movie times and local points of interest, broadcast over HD Radio bandwidth to navigation systems in cars. The higher bandwidth rates, local customization and favorable economics make traffic services over HD Radio bandwidth compelling compared to other services like satellite radio.

Two nationwide networks are already built out — one by Clear Channel, the other by Navteq working with a group of broadcasters in the Broadcast Traffic Consortium — so the infrastructure is in place. Consumer devices in the aftermarket and factory installed in vehicles, as will be shown at CES, will complete the service.

Also prominent on the show floor will be iTunes Tagging. This service, enabling a listener to press a button and capture song information for later purchase at the iTunes store, is an ideal app for cars. Better to push a button to remember to buy a song than to fumble for a pen and drive into a tree. Car buy-

ers will see factory installed iTunes Tagging in cars in 2010.

And showgoers will see what I predict will be the next hot HD Radio application in cars: Image Support.

This is the ability to broadcast pictures from an HD Radio station and display them on a radio screen. The initial application will be album art, which our research shows consumers will love and increasingly expect, and car manufacturers are enthusiastic about. Station branding and advertiser-generated images will also be in the mix. This app will increase the value of HD Radio

broadcasts to listeners, and like all other HD Radio apps, lead to new revenue opportunities for broadcasters.

In January, shortly after the CES concludes, Ford will begin offering HD Radio technology factory installed in their cars. When Alan Mulally addresses CES, he will lay out his compelling vision and plan to take Ford to the forefront of automotive consumer electronics, building on its highly successful Sync platform. That HD Radio technology is an important part of this vision is great news for broadcasters and consumers alike, and demonstrates convinc-

ingly the importance of digital technology for radio broadcasters.

So the digital race for the dashboard is in full swing. Radio broadcasters have always had the pole position, but have slipped back by driving with old technology. We at iBiquity are committed to be in the garage developing better radio engines and in the pit crew, helping fuel radio's run. Together, we can work to get that checkered flag.

Contact the author at thoughts@ibiquity.com. Radio World welcomes other points of view at radioworld@nbmedia.com.

# Where Great Radio Begins PR&E<sup>®</sup> VistaMax<sup>™</sup>



"VistaMax is at the forefront of the evolution from standalone consoles to networked control surfaces, centralized audio management and shared resources. Power, scalability and value assure that all PR&E products meet the needs of everyone at your station — on-air talent, producers, programmers and engineers.

There is no greater evidence of our flexibility and reliability than the number of stations — large and small — that benefit from PR&E innovations every day."

Paul Barzizza, Manager of Business Development for Radio Studio Solutions at Harris, has been helping PR&E customers design, configure and equip great studio facilities for more than 10 years.

Learn more at [www.pre.com](http://www.pre.com) or (800) 622-0022.

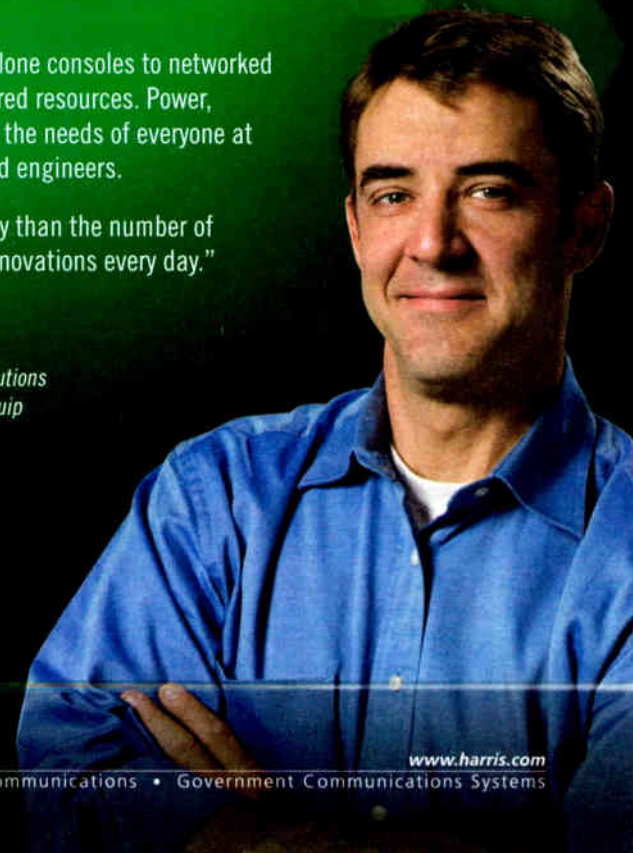

**atus**

Optional Available Now    Standard/Optional Available Now    Standard/Optional 2010    Standard/Optional 2010    Standard Available Now

Standard/Optional 2010    Optional 2010    Standard/Optional Available Now    Optional 2010    Standard 2010

■ Brands    ■ Vehicle Lines    ■ Standard Equipment

Year	Brands	Vehicle Lines	Standard Equipment
2006	1	3	0
2007	2	7	0
2008	5	30	1
2009	10	53	24
2010	15	80	36

www.harris.com  
 HARRIS assuredcommunications<sup>®</sup>  
 Broadcast Communications • RF Communications • Government Communications Systems



# Discover the Power in Just :05

Very Short Spots Offer Your Client  
The Possibility of Incredible Reach

BY ROD SCHWARTZ

I sold my first five-second radio commercials back in 1975.

(For the record, that's 30 years before Clear Channel would proclaim "Less Is More" and with great fanfare begin

## RADIOSALES

offering five-second "adlets" or two-second "blinks." Twitter founder Jack Dorsey had not yet been born. Heck, Al Gore hadn't even invented the Internet, though he may have been toying with the idea. But I digress.)

I started selling five-second ads because a legendary radio sales trainer taught me how effective they could be. He wasn't alone. Believe it or not, the Radio Advertising Bureau also reported on the success that some stations were having with what they called "eight-word ads."

There are at least three advantages to shorter ads:

- 1) They force the ad writer to craft a clear, concise message. There's no room for "fat" in a five-second ad.
- 2) It's much easier for a listener to comprehend, retain and recall a short message in its entirety. It's in-and-done before the listener can even react to it! (Stick around and I'll share with you a powerful technique for demonstrating this effectively to a prospect.)
- 3) Because five-second ads cost less than :30s or :60s, the advertiser's budget buys him greater frequency (more repetition of his message).

Short ads can be deployed to trip the recall switch, reminding the listener of something he's heard about in greater detail in a longer commercial.

Think of this technique as "clutter busting" — referring not so much to the other ads on your station as to all of the messages that bombard us daily everywhere we turn, from computer monitors and cell phones to the chatter of our co-workers, from in-store POP to ads on public benches, buses, billboards and buildings, television, newspaper, magazines.

While there may be disagreement as to how many advertising messages we see or hear in each day, we can agree that there's plenty of competition for a

listener's attention. We live in an age when distractions are plentiful.

### MARGINAL COST

So let's say you've sold your client a schedule of :30s or :60s to get the word out about his big store-wide sale.

His commercials include a number of price-and-item illustrations, maybe a special financing offer, prize drawings and so forth. Let's imagine that he's running 10 commercials a day for 10 days, and these ads are scheduled to run between 6 a.m. and 7 p.m. Assuming



even distribution, he's running one ad every 78 minutes.

By adding just 10 five-second ads per day to his schedule, you've doubled his frequency, cutting the time between exposures in half.

Add another 10 and now your listeners are being reminded about his sale every 26 minutes. The marginal cost of the additional five-second ads has tripled his frequency!

All other factors being equal, this advertiser is going to enjoy better results from his buy on your station, which ought to bring him back for more.

Sometimes longer ads aren't even necessary. It's quite possible to build an entire campaign around five-second ads exclusively.

I have a client who for many years has sponsored the weather update following network news at the top of the hour. His five-second message — usually a positioning statement, but occasionally a call-to-action — runs once an hour, 24 hours a day, 7 days a week. For all intents and purposes, his advertising message reaches the station's entire audience.

Every listener, every day.

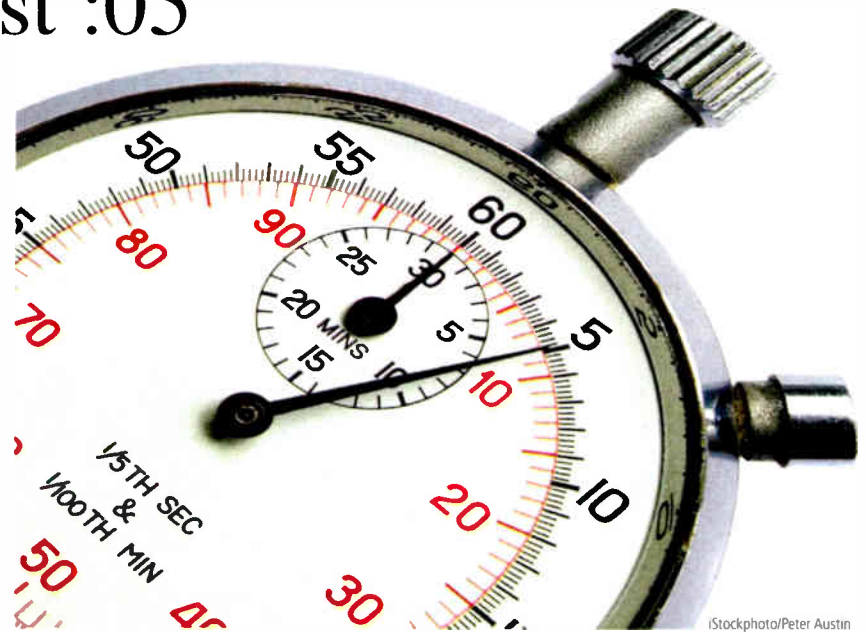

(Stockphoto/Peter Austin)

Think about that. How many of your advertisers can claim with reasonable certainty to reach every single listener on your station during the course of a day or a week, let alone all year long?

It's terrific exposure, and much easier for an advertiser to achieve and afford with a five-second ad.

The proliferation of satellite-delivered syndicated programming has all but eliminated the flexibility most stations once enjoyed when it came to scheduling commercials.

If your station does all its own programming, consider yourself fortunate, indeed. You still have the freedom, or at

demonstrate to your prospective client the power of a five-second ad.

First, write the copy. Create the actual message that you're going to propose the client run for this campaign. Take the time to make it a good one. (I recall this Jim Williams classic: "Don't Make a \$500 Mistake. Bob's Used Cars.")

When you're sitting across from the prospect, tell him, "I'd like you to help me with a little experiment." Pause. Make sure you have his undivided attention. Then, read the five-second copy aloud, with appropriate feeling.

Read it a second time.

Read it a third time.

**Short ads** can be deployed to trip the recall switch, reminding the listener of something he's heard about in greater detail in a longer commercial.

least the potential, to schedule ads of any length, in any combination, at any time. The world is your oyster. Go for it.

Stations whose programming comes via a bird in the sky have little choice but to fill fixed-length breaks with fixed-length ads at fixed times, with few opportunities for deviation from the :30/:60 standard.

It might be worth sitting down with your program director and asking him to identify any possibilities for running short ads (such as the :05 weather sponsorship mentioned earlier).

### TRY THIS

If you are able to identify and secure the appropriate inventory, and you're ready to put it to work for an advertiser, here's a technique you can use to

Then ask him to repeat what you just read.

In most cases, he'll repeat it verbatim without hesitation.

"You've just demonstrated the power of a five-second ad. I read it to you only three times and already you have it memorized, the whole thing."

Rehearse the advantages of the five-second ad with him:

- 1) Forces lean, concise copy;
- 2) More easily understood, retained and recalled by the listener (as he just demonstrated)
- 3) Allows more frequency within a given budget

(continued on page 23)





*"OP-X is very functional and easy to use. One of the best features is the log merge. On our old system it took minutes and with OP-X it takes seconds."*

*-John O'Dea, Ops Mgr  
WNNK-FM, Harrisburg, PA*

- Modular Operation in Op-X allows for a tiered system at a fraction of the cost of its competitors.
- Each studio client is capable of accessing all Audio Server modules on the network.
- Remote voice-tracking allows for creation of content for remote studios also running Cp-X.
- The revolutionary design of Cp-X's clock builder turns the previous task of scheduling satellite programming into a few simple clicks.
- Share serial devices from any machine using the Op-X Serial Server.
- Importing logs now gets its own module that takes confusion out of the process.
- Engineers will enjoy Op-X because it's easy to install, maintain, and has automatic backup features.

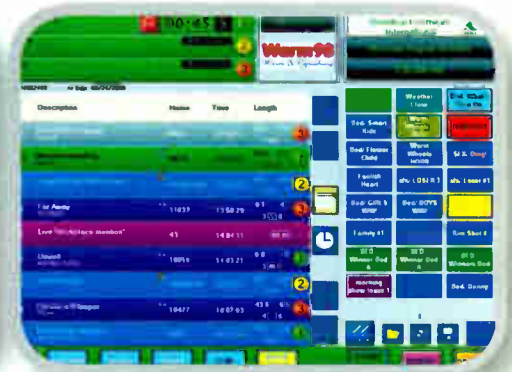

# AUTOMATION

**SIMPLE • POWERFUL • REDUNDANT**

***Not since Axia audio-over-IP** was introduced to the broadcast industry have we at BGS been so excited! It is with great enthusiasm we'd like to invite you to take a look at the new Op-X Radio Automation delivery system for any single or multi-station cluster. Op-X's versatility allows it to operate seamlessly with either Axia IP-Audio networks or legacy audio consoles.*



**Broadcasters  
General Store**  
**352-622-7700**  
**www.bgs.cc**



# Create Effective, Charming Ads

Perhaps It's Time to Reevaluate Your Use of Endorsements and Live Reads



One would think that after so many years in the business, we'd all be immune to the power of the medium. And yet there I was, just last week, considering the purchase of a product that I had heard described on the radio.

It was a live read that reached out and plucked me like a fresh fruit from a tree. Actually, I'm not even certain it was truly live. It may have just sounded like it was "live," but it could have been pre-recorded and endorsed by a talent whom I happen to like very much.

If broadcast cynics like me can be convinced by a radio personality to purchase a product, there's a lot of untapped potential in many stations.

Because commercials endorsements and live reads are not as common as they once were in our industry, perhaps it's time for your sales department to reevaluate their potential in terms of driving revenue for your station and results for your clients.

A program director and general sales manager should meet to discuss the big

issues surrounding a new concentration on endorsements and live reads. Begin with a clear understanding that not all endorsements need to be live reads, nor do all live reads need to be endorsements. They can be both, but depending on the product and the amount the client wants to spend, they do not have to be.

Plainly put, an endorsement occurs when a talent encourages listeners to purchase or use a product because it worked for them. During an endorsement, a talent typically will use their name and often will sound extemporaneous as they list the excellent qualities of the product.

A live read is just a commercial that is read, seemingly live, by an on-air talent.

## PROCEED WITH CARE

Now that the PD and GSM are using the same language, they should delve into the math.

Discuss how many times an hour live reads can be aired without sounding overwhelming. Depending on format, it may not make sense to run more than one live read during one commercial stop-set. Endorsements are even trickier, because the more you air, the more it sounds as if everyone at the station is pitching something.

This can be a problem, especially if the products being endorsed are all in one category. Not long ago someone asked me if all DJs were overweight. When I asked him why he wanted to know this, he surprised me by saying that he hears so many DJs talking about the benefits of weight loss programs or diets that he assumed anyone who played songs on the radio had pounds to spare.

Talent agreements should be written in such a way that every talent is

## PROMO POWER



**Mark Lapidus**

Read more Promo Power articles online at [radioworld.com](http://radioworld.com)

required to do so many endorsements for free per year. Do not attempt to make talent do all of them as part of their job. If they do three or four a year as part of their contract and then you (or the client) pays them for two or three others, you will find that they'll work a lot harder at sounding great when they do the spots.

Decide who will be the point person on staff to talk to talent about endorsements. Typically, the initial approach should come from the PD with a hand-off to the salesperson who is connected to the client. The sales manager should be involved in the price structure of the process, but may not be needed for any of the other logistics.

Naysayers about the subject are likely to point out that with all the voice-tracking done today, there just isn't much room for endorsements or live reads.

While it's true you may have fewer on-air talent to turn to, it's also true that you can hire outside talent to endorse products when necessary. You'll find that local celebrities from TV stations, newspapers and even Web sites will be capable of generating action for you.

Endorsements and live reads have been with us since the beginning of the medium and will likely be here long after we're all history. It's merely a question of radio people remembering just how effective and charming advertising can be when executed with the proper style.

*The author is president of Lapidus Media. E-mail him at [marklapidus@verizon.net](mailto:marklapidus@verizon.net).*

## STATION SERVICES

**Sound Ideas for Building Business<sup>SM</sup>**

:30/:60-sec. Radio Features  
*Something New Every Month!*



[GraceBroadcast.com](http://GraceBroadcast.com)

*"Hands down, the best radio sales resource I have encountered."*

- Jay Mitchell, Small Market Radio Newsletter



[RadioSalesCafe.com](http://RadioSalesCafe.com)

**ATTENTION PROVIDERS:** Promote your services to Radio World's readers. For information on affordable advertising call David at 615-776-1359 or email [dcarson@nbmedia.com](mailto:dcarson@nbmedia.com).

## WHO'S BUYING WHAT



Standard Media Group uses a Barix Exstreamer 1000 for distribution of 'Martini in the Morning.' Brad Chambers, chief creative officer and show host, sits while Chief Engineer Al Taddeo looks on.

For more Who's Buying What, see facing page.



## WHO'S BUYING WHAT

**Audioarts** said **RCN Radio** planned to install 13 R-55Es during a renovation of studio and transmitter equipment. Radio Cadena Nacional Radio is the largest AM and FM radio network in Colombia. It also uses R-60 and R-90 radio consoles. RCN is in the process of standardizing stations with the R55E-12 audio console.

**Wheatstone** also said **Acadia Broadcasting Ltd.** (CHSJ/CHWV) in St. John, Newfoundland, purchased four E6 control surfaces, five IP-88a Analog Blades, an IP-88ad analog/digital Blade, 17 AOiP Drivers for sound card replacement on iMediaTouch, Adobe Audition & Vox Pro, Glass E remote surface control software, Navigator system configuration software and 10 GP Series desk top turret systems through dealer Ron Paley Broadcast.

**RAM Systems** won a contract from **WGN(AM)** in Chicago to build and supply equipment and furniture. The job involves five news work stations: RAM will supply **SAS** Rubi-T Turrets, RIO Routers and custom tabletops. Station Director of Engineering Jim Carollo chose RAM for the job, which is scheduled for completion by the end of

January. The project is an expansion of the station's news bureau area. ...

**Broadcast Electronics** said **Gulf Coast Radio** in Dade County, Fla., is using its transmission gear at a new facility, opened in March. **WKGC** (AM/FM) use an AM 5E 5 kW transmitter with HD Radio signal generator and FMi 21T transmitter high-level combined with analog FM and HD Radio signals, with service via a new tower. The facility was put up on land owned by Gulf Coast Community College, the licensee of the stations, and aided with CPB HD Radio grants. The project includes a 10-bay **ERI** FM antenna providing 100 kW ERP. The AM's **LBA** antenna radiates 5 kW daytime ERP 150 feet down from the FM antenna. ...

**Leo Laporte** of **Premiere Radio Networks'** syndicated talk show "The Tech Guy" installed an **Axia** IP-Audio network and **Element 2.0** broadcast console at his Petaluma, Calif., studio. Separately, the first radio station in the Middle East using **Axia** debuted with the sign-on of the Qatar Foundation's **QF Radio** in Doha, Qatar. ...

**Quantum Communications** chose **Marketron Broadcast Solutions** to

provide the primary business operating system for its radio stations. **Quantum** has 32 stations in small and mid-sized markets. The group deal for **Quantum** includes **Marketron** business system software as well as the new **Marketron Exchange** e-commerce platform. ...

**Harris Corp.** sold nine **DMB 670** multimedia transmitters to French network operator and **DAB/DMB** equipment manufacturer **VDL** to support the imminent rollout of digital radio in the

cities of Nice, Marseille and Paris.

**Barix AG** said **Standard Media Group** was the first U.S. user of its **Exstreamer 1000**. The California-based company is sending its "Martini in the Morning" program to affiliate **KPHX(AM)** in Phoenix for air as an alternative to satellite distribution.

Send news of notable equipment sales or purchases to [radioworld@nbmedia.com](mailto:radioworld@nbmedia.com) with "Who's Buying What" in the subject line.

## 5 SECONDS

(continued from page 20)

Then present your proposal. Make the sale. And enjoy the results.

More than three decades ago, I used to drive the 55 miles between Winona and Rochester, Minn., two or three times a week. One Sunday I tuned in to Chicago's **WGN** at 720 AM and kept it there to hear what was happening in my old hometown. I don't remember the name of the host (though as I recall he had the most wonderfully soothing rich bass voice), but to this day I do remember two ads that he read live, several times each, during the course of my commute:

"7-Up, the Uncola. Chicagoland's number one refresher."

"Chapped lips need Blistex. Buy Blistex."

I swear, I never intended to memorize them. It just happened.

Like magic.

*Rod Schwartz is a 36-year radio sales veteran and owner/creative director of Grace Broadcast Sales, a provider of radio features and creative services; it recently launched Radio Sales Café, an online social network for radio advertising sales professionals. Reach the author at [rod@gracebroadcast.com](mailto:rod@gracebroadcast.com).*

# CONTENT IS EVERYTHING

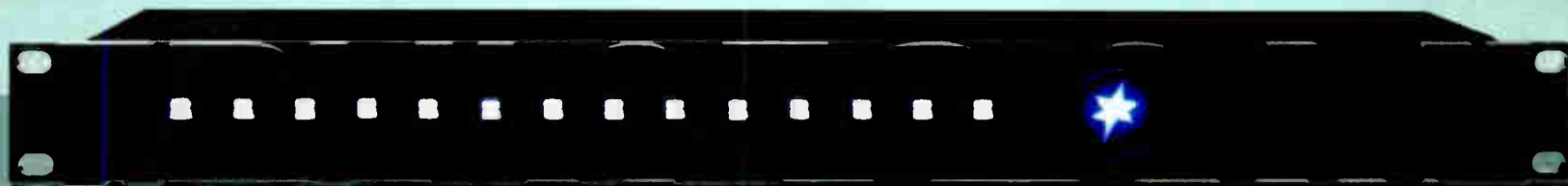

## PCAU-SUITE

ARMORED MONOBLOCK STL

HD • FM • AM • ETHERNET • RS232 • TELEMETRY • T1 • AES/EBU • DIGITAL • ANALOG • TSL • ENHANCED APT-X™ • 24-BIT • 22.5 KHZ • AC • DC

WWW.PULSE.COM • 800 381 1997

PULSE.COM IS A REGISTERED TRADEMARK OF HUBBELL INCORPORATED (NYSE: HUBA, HUBB)  
APT-X™ IS A TRADEMARK OF AUDIO PROCESSING TECHNOLOGY LICENSING LTD.



# Microphones Make News Stand Out

Here Are Three Sturdy Ol' Reliables That Might Merit a Place in Your Kit Bag

BY PAUL KAMINSKI

One of our guiding principles in this column is to let readers know about new tools that can make life in the field easier for radio news reporters. But when it comes to microphones as a tool for road

## RADIO ROAD WARRIOR

Columns are archived at [radioworld.com](http://radioworld.com)

warriors, some of the best are old reliables. Here are three. (Mentions of particular products in this column aren't necessarily endorsements by the user or the user's employer.)

In an earlier article I wrote about items that our colleague Pete Combs — of WSB Radio News in Atlanta as well as CBS News, Radio — carries in his backpack.

He wouldn't roll out from WSB's Peachtree Street newsroom without his Audio-Technica 815a shotgun. Pete uses the 815a on a 10-foot boom pole in a mass interview situation to isolate the newsmaker. When he's after natural sound, the 815a works well for him because of its directivity.

"I like the 815a for voice tracks, too," said Combs, "because I'm able to elimi-

nate most, if not all, of the ambient sound. With the 815a, I am not sacrificing presence for a directional signal."

Pete says the 815a is his favorite microphone.

The 815a is 18.11 inches long, weighs 7.1 ounces and provides response 30 Hz–20 kHz; pattern is line + gradient. The model has been discontinued by Audio-Technica. A good alternative is A-T's 8015 shotgun.

### GAME DAY

Sports reporters are a special group of road warriors. They like to keep equipment loads light because they are on the run gathering sound from locker room interviews, news conferences, back of a NASCAR transporter chat, and, when they can find a semi-quiet place, knocking out a voice track to give context to that sound.

Welcome to the world of Sirius XM's Claire B. Lang and Scott Johnston of Emmis stations WIBC(FM)/WFNI(AM) in Indianapolis. Both rely on variants of the legendary Electro-Voice RE50 to help them cover their beats.



Shure SM57

Claire B. Lang was the first satellite radio NASCAR reporter on XM in 2002 and is a mainstay of Sirius XM NASCAR on-track coverage. At a race, one will likely find Claire B. in the garage area getting the story for her "Dialed In" program straight from the newsmakers, whether they be drivers, crew chiefs, crew members or officials.

Her introduction to the RE50 came when she lost a mic she was carrying. "I

needed one pronto. I went to a local music store, told them what I needed and they offered this classic (RE50) microphone that was old but durable, and they said the sound would be spectacular. I've had that microphone for 10 years now."

Lang says that microphone would have to accompany her if she were doing radio on the proverbial desert island. Her advice for fellow road warriors: "Don't overlook the old classics for the brand-new models. Sometimes what worked before still works, and is maybe a better, more durable choice."



Sirius XM NASCAR correspondent Claire B. Lang uses an Electro-Voice RE50 to interview Alan Gustafson, crew chief for driver Mark Martin.

## Pinching shouldn't be painful.

Our competition may have led you to believe that you know them, or that you can trust them. But the plain truth is that they just want your cash, and lots of it!

In a time when cash is scarce, a better concept in sales, perhaps a more progressive one, is to work for a smaller profit and pass the savings along to the customer.

Realize the savings you can put in your pocket.

Call, click, or stop by Progressive Concepts today!

THE BEST IN BROADCAST ELECTRONICS SINCE 1990



**progressive concepts**  
305 South Bartlett Road • Streamwood, IL 60107

[www.progressive-concepts.com](http://www.progressive-concepts.com)  
(630) 736-9822

Johnston covers the Indianapolis Colts and Indianapolis Motor Speedway events as a sports reporter for ESPN's WFNI(AM) 1070 The Fan, and newstalker 93.1 WIBC(FM). His introduction to the RE50 came when the station issued a microphone that resembled the RE50.

The clone "transmitted every hand shift and movement into audible clicks and noise that ended up on the recordings." Scott then purchased his own RE50 about 15 years ago.

Johnston advises fellow road warriors to figure out how a microphone will be used before actually committing to purchase. He says he knew his RE50 mic would spend much of its time in the bottom of a gear bag, so he needed durability and something that did not require extra battery power. "Half the battle is figuring out what the mic will be used for, and the other half is matching what is out there to your needs."

The RE50 is a descendant of the 635A dynamic omnidirectional micro-

(continued on page 26)



More than 1,500 IP-Audio consoles so far.  
We're at a loss for words. Thankfully, we've got pictures.

Note to people planning studios:  
Have you read the  
new book *Audio Over  
IP: Building Pro AOP  
Studios with  
Livewire* by Steve  
Church and Skip  
Pizzi? If not... Axia  
can save you 30%  
when you purchase a  
copy. Just visit  
[AxiaAudio.com/book/](http://AxiaAudio.com/book/)

**AXIA**  
AUDIO OVER IP



# Do-It-Yourself DJ Comes to DRS Virus

## Swiss Broadcaster Takes Social Media to Another Level for Listeners

BY BRETT MOSS

Swiss broadcaster DRS Virus, a youth-oriented channel of the national broadcaster DRS, has initiated a daring move: a do-it-yourself DJ controlled by listeners.

It's more than listeners simply e-mailing or calling in requests or submitting suggestion lists. DRS Virus has turned the playlist over to its listeners for live operation.

To achieve this bit of wizardry, DRS Virus is employing Mx3Linear, a software program from Swiss software developer mxlab AG.

Mx3Linear allows visitors to the DRS Virus Web site to activate a small DJ avatar. Using a top-view GUI, that avatar walks around and chooses records from the station's record library and stores them in his "bag."

He then gets into line behind other DJs and waits his turn to take over the control of two turntables. While in line the DJ avatars can talk to each other. Once his turn comes he removes records from his "bag" and places them onto the platters where they will play in the order dictated.

Unlike a personal Web site where the output of such playlists streams directly to the listener — and only that

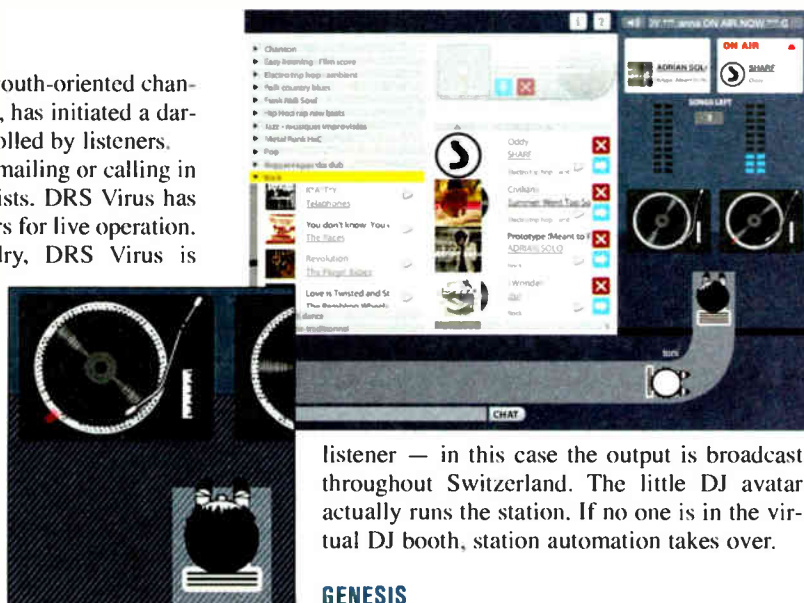

listener — in this case the output is broadcast throughout Switzerland. The little DJ avatar actually runs the station. If no one is in the virtual DJ booth, station automation takes over.

### GENESIS

Dominik Born, CEO of mxlab, explained the genesis of the concept: "I was a radio DJ and loved choosing music for airplay. After I moved on I missed it and so I asked myself how it would be possible to recreate that feeling and share it with others who will never have the chance to sit in the broadcast booth."

## WARRIOR

(continued from page 24)

phone. The 635A is lovingly called the "Buchanan Hammer" because the microphone originally was made in Buchanan, Mich., and its sales people demonstrated its durability by pounding nails with it and then connecting the 635A to an audio system for its usual function. The RE50 effectively is a 635A in a larger body to provide shock absorption.

The RE50 is 7.75 inches long, weighs 9.5 ounces, has frequency response of 80 Hz–13 kHz and is omnidirectional.

### SHURE THING

Since 1987, I've carried a Shure SM77 cardioid microphone, which is a short-barreled version of the well-known SM57. The SM57 and SM58 mics were introduced in 1966 and share the same Unidyne III dynamic cardioid cartridge developed by the late Ernie Seeler.

Those microphones originally were made for broadcast interview use. Since then giggering musicians have picked up on the tonal qualities and ruggedness of the 57 and 58, making them required members of any respectable rock or jazz band mic kit. The SM57 is now listed by Shure as an instrument mic while the SM58 gets the vocal association.

The SM57 also has been used in a dual redundant



Scott Johnston of WIBC(FM) and his trusty Electro-Voice RE50

microphone setup by the White House Communications Agency to mic every president of the United States since Richard Nixon. You'll see those two microphones every time the president steps behind a presidential podium.

I've used my SM77 for interviews and voice tracks, and as a studio announce microphone with a foam windscreen. It's my backup mic. The only service the SM77 has needed in those 22 years (even with a trip to Saudi Arabia and trips to lots of race tracks and news sites) has been a couple of paint jobs. A good thing, since the SM77 was discontinued a few years back by Shure. Pete Combs also carries an SM58 in his backpack.

Specifications: The SM57 (closest to my SM77) is 6-3/16 inches long, weighs 10 ounces, has response of 40 Hz–15 kHz and is cardioid in pattern. The SM58 (with a metal windscreen) is 6-3/8 inches long, weighs 10.5 ounces, has response of 50 Hz–5 kHz and

is cardioid.

Buying new or used, there are three mic tools that might deserve a place in your kit bag.

Paul Kaminski is the news director for the Motor Sports Radio Network, a contributor to CBS News, Radio and an editorial contributor to Radio World since 1997. His e-mail address is motorsportsradio@msrpk.com.

DRS knew Born from the mx3.ch Swiss music hub and portal that mxlab developed. He pitched DRS on creating a Swiss-only music night. The concept evolved from there.

In comparison to personalized streaming Web sites such as Jango and Last.fm, commercials are aired on DRS Virus. The avatars running the show have to wait for any scheduled commercials to run before their songs start.

Surprisingly, or not, listener interest in this method of operating a radio station has yet to wane. And traffic problems have been anticipated. If more than two avatars are in line, they are limited to two songs before having to move on. If no one is in line, the controlling listener can play to their heart's leisure.

Mx3Linear guards against mischief-making virtual DJs by limiting how often one song can be played before it has to wait a preselected amount of time before being available in the library again. That prevents bombarding the station with a single song or using a group of songs to dominate airplay.

Robert Ruckstuhl, director of programming for DRS3 and DRS Virus, said, "With this tool our listeners are for the first time able to control our programming. It is not only that they can say which song they like, but they can play the song in real time. We hope that this increases the relationship between our station and their listeners."

For interested stations, Born says that Mx3Linear is available for anyone willing to pay. He estimates approximately \$30,000 for a turnkey package along with a stable Internet connection puts the virtual DJ on the air.

## PRODUCT GUIDE

### HHB LAUNCHES CD BURNER

In something of a retro move, HHB has released a new, old-fashioned rackmounted CD burner.



The CDR-882 is a dual-well burner utilizing above-average consumer CD drives, according to HHB. The steel case is also heavy-duty for vibration dampening.

Conversion is 24-bit and a sample rate converter will handle 32 – 96 kHz. As a tip of the hat towards its professional market, XLR connectors, digital AES/EBU and analog, are included, along with optical S/PDIF and the obligatory RCA.

HHB New Product Development Manager Simon Burges said, "CD remains a widely-used format in broadcast, music recording and archiving so recording accuracy and data integrity continue to be important issues."

For information, contact HHB/Sennheiser at (860) 434-9190 or visit [www.hhbusa.com](http://www.hhbusa.com).



# extend your reach through media

"We who broadcast the Good News of Jesus Christ on a regular basis need the fellowship, encouragement and accountability we receive through NRB. Never in our history has the mission of NRB been more crucial than it is today."

—Luis Palau, World Evangelist

## More than 40 Educational Sessions like...

- The Digital Kingdom: Keeping Your Ministry Relevant in a High-Tech World
- Birthing a Broadcast Teaching Ministry
- Expanding Your Ministry with Remote-site Technology
- Internet Evangelism: The Story behind "I Am Second.com"
- Making Sunday Stick
- Does Media Really Have Anything To Do with Worship?
- Social Media: Prepare to Get Connected

**NRB 2010**  
CONVENTION & EXPOSITION

February 27 – March 2

[www.nrbconvention.org](http://www.nrbconvention.org)

Gaylord Opryland Resort

& Convention Center

Nashville, TN



< CHUCK COLSON



KAY ARTHUR >



< GAITHER VOCAL BAND



PAUL SHEPPARD >



< MEREDITH ANDREWS



TONY PERKINS >



< BARRY LYNN



KEITH & KRISTYN GETTY >





"On the Edge" is a look at recent product introductions in a specific area of radio broadcast engineering. Here: **Studio Routing Infrastructure.**

## HARRIS VISTAMAX COVERS THE ANGLES

The Harris PR&E VistaMax audio management system is the core of the Harris PR&E networking and infrastructure equipment range.

VistaMax and VistaMax Envoy systems provide routing and connectivity across the radio broadcast studio facility to share resources more efficiently while reducing costs associated with traditional audio routing systems, the company says.

VistaMax connects sources and destinations to the system via the shortest physical path, eliminating or greatly reducing the need for standalone routers, distribution systems and long multipair bundles of inter-room wiring. VistaMax also serves as the core for PR&E digital networked studios using Harris PR&E RMXdigital and NetWave digital radio consoles.

The VistaMax family extends to hardware and software components that expand the reach of the system. The latest is VMQuadra, an interface that ties VistaMax digital studio networks to automation computers.

Designed in collaboration with software automation developers, VMQuadra tackles the issues of having a large number of audio channels at each automation computer, the distribution of the computers throughout the facility and the need for bidirectional logic control. The system resides near the server and interconnects with up to four computers.

The growing product line also includes VMConnect, a compact host device that extends the number of VistaLink facets of an audio network based on VistaMax and VistaMax Envoy audio management frames. Audio connections remain at the VistaMax or Envoy frames, or locally to RMXdigital and NetWave consoles.

For information, contact Harris Broadcast Communications in Ohio at (513) 459-3400 or visit [www.harris.com](http://www.harris.com).



## JETSTREAM MINI IS A NEXT-GENERATION AOIP ROUTER

Logitek's JetStream Mini audio over IP router provides audio I/O, mixing, processing and networking in conjunction with its line of control surfaces: Mosaic, Artisan, and Remora, in addition to its new low-cost Pilot console.

The company says JetStream represents the next generation of IP-based audio routing systems, providing very fast audio streaming for on-air and production operations. Unlike older generations of IP audio systems, JetStream products are designed to take advantage of new standard network protocols that make the system easy to set up, administer and use. Only the names of the channels need to be entered; the JetStream acquires the necessary addresses, advertises its shared channels to other units and gathers a list of sources available from other JetStream products on the network.

The first product in the line, the JetStream Mini, is a 2RU fanless audio router designed to be installed in a studio.

It supports up to four radio consoles and features eight I/O slots that can be outfitted with any combination of five I/O cards: four stereo analog in, four stereo analog out, four AES or S/PDIF in, four AES or S/PDIF out, or four mic preamps with phantom power.

This flexibility allows a station to customize each JetStream Mini to fit their needs, an approach that is more economical than other AoIP nodes, Logitek says. StudioHub+ type RJ-45 connectors are used for audio I/O for easy installation. EQ, dynamics and delay are standard.

Dual server-class Gigabit Ethernet ports allow for small systems of up to three JetStream Minis to be built without a network switch as well as providing support for redundant network switches in larger installations.

For information, contact Logitek in Texas at (610) 642-2487 or visit [www.logitekaudio.com](http://www.logitekaudio.com).



## AXIA POWERSTATION INTEGRATES CONSOLE, INPUTS, NETWORK

PowerStation, Axia Audio's new all-in-one IP Audio console system, combines analog, digital and microphone I/O, a console power supply, DSP mixing engine, and network switch into a package that the company says is easy to deploy.

To set up PowerStation, connect studio gear with standard Cat-5 cables, connect an Element console with one cable, name the sources with a browser and it's ready for air. PowerStation can serve as the heart of a standalone studio (with support for consoles as large as 40 faders) or part of a larger Axia network. Simple Networking lets you daisy-chain up to four PowerStations for multi-studio installation without a separate core switch. Axia says the system is built for 24/7 reliability, with industrial-grade components and redundant power capabilities.

PowerStation works with Axia's Element 2.0 family of broadcast consoles. Some 1,500 Element consoles are on the air. Element 2.0 has features like voice and head-phone processing by Omnia; peak and average metering; one-touch phone recording; automatic mix-minus for every fader; an eight-channel Virtual Mixer that lets users combine multiple audio streams and control them with a single fader; motorized faders that can assume preset levels automatically; controls for Telos broadcast telephone systems and Show Profiles that recall talent's favorite settings.

Element uses avionics-grade switches rated for millions of operations, "bulletproof" optical encoders, conductive-plastic faders and a frame made from thick aluminum extrusions. Element is custom-sized to specifications in sizes from two to 40 faders, with single-frame or split-frame configuration available.

For information, contact Axia Audio in Ohio at (216) 241-7225 or visit [www.axiaaudio.com/powerstation](http://www.axiaaudio.com/powerstation).



## WHEATNET-IP DELIVERS AUDIO-OVER-IP

Creating a typical broadcast facility audio network is a challenge: linking myriad audio and control signals to and from studios, production suites, newsrooms, TOC areas, automation systems and Internet streaming servers.

Wheatstone says its WheatNet-IP system makes it possible to do so, on a tight budget, even without an IT degree.

The building blocks of the Wheatnet-IP system are single-rack-space "blades": four specialized I/O interfaces to handle audio and control requirements plus a fifth powerful DSP-based mix engine. These interface with Wheatstone's E-Series control surfaces, the Wheatstone Glass-E virtual console, Wheatstone audio control panels and most popular automation systems.

System setup is aided by a front-panel Setup Wizard built into each blade; all are equipped with front-panel metering and status indicators to provide confirmation of overall system health.

Each blade carries a copy of the entire system configuration in nonvolatile memory. Should replacement ever be necessary, assign the removed unit's ID number into its replacement and it will retrieve previous settings from the other blades and configure itself. No external PC is required.

While basic configuration of WheatNet-IP can be done from a blade's front panel, WheatNet-IP Navigator administration and control software offers an easier way to perform system tasks such as entering source and destination names and manually programming audio paths (crosspoints), letting you further customize and control your system, either locally or remotely. Each blade also has a built-in Web server, letting any browser perform many of the functions of the more advanced Navigator software.

For information, contact Wheatstone in North Carolina at (252) 638-7000 or visit [www.wheatstone.com](http://www.wheatstone.com).





## STUDIO ROUTING WITH DIGIGRAM'S ETHERSOUND

EtherSound is a network audio standard in live sound installations where versatile network topologies, low latency (125  $\mu$ s) and high sound quality (24-bit 48 kHz PCM) make it attractive. However, the company says EtherSound offers several benefits to broadcast installations as well as live sound.

The most obvious, perhaps, is that it greatly reduces cabling difficulties by using standard Cat-5 cables. A simple network cable will transport up to 64 channels in both directions. When networking (daisy-chain or star topology) different EtherSound audio bridges, analog or digital inputs/outputs, users can create a low-latency distributed routing matrix with no wiring except Cat-5 links.

Routing control is done through EScontrol (the dedicated EtherSound software interface from Digigram), allowing direct change of the routing or recall of settings.

Digigram says the typical "redundant ring" network topology brings peace of mind for 100 percent "on-air time"-obsessed engineers. This redundancy will reroute the signal in the case of accidental system failure without noticeable audio effect. EScontrol will trigger an automatic alert or GPIO command should an error be detected, so multiple failover options are handled easily.

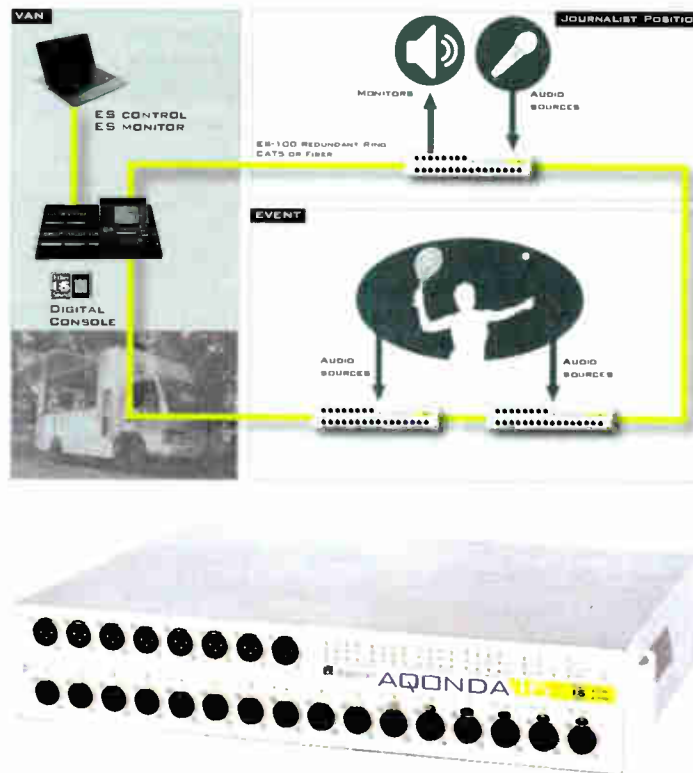

At the heart of the ring network system usually lies a station's preferred radio automation software running on a PC workstation. By plugging in an LX6464ES sound card interface, users bridge the automation software to the EtherSound network and connect to the mixing console (there are EtherSound interfaces for popular broadcast consoles such as Studer, Yamaha, etc.) and more generally, to the EtherSound ecosystem.

The Studer interface, for instance, fits into the Studer D21m I/O system rack. Initially for use with the Studer OnAir 3000 console, the card also is compatible with Studer's flagship Vista Series and routing systems. Network inputs and outputs can be patched directly from the console.

Users also can interface from the network with multiple analog or digital I/O sources using Digigram ES8in, ES8out, ES881 or 16161 devices.

EtherSound networking offers solutions for outside broadcasting needs. A stagebox interface such as the AQONDA, recently released by Digigram, will bridge up to 16 microphone/line preamps to an EtherSound-enabled OBvan mixing console or recording system.

For information, contact Digigram in Virginia at (703) 875-9100 or visit [www.digigram.com](http://www.digigram.com).

# FREE WEBINAR Watch It On-Demand

## Radio World TechCast — 360° Roundtable "What to Watch for in 2010"

Please be our guest from the convenience of your desktop or laptop for a stimulating 75-minute discussion about the most important technical trends that will affect radio broadcast engineers, managers and owners in 2010. Digital radio. RadioDNS. Tagging. Data. EPG. Mobile trends. Multiplatform strategies. Watch, learn and gain key insight from a panel of radio's thought leaders along with our industry-leading editorial staff.

Don't miss this rare opportunity to learn more about some of radio's most pressing technologies for the second decade of the 21st century – now available on your own time schedule and without having to travel.

Go Here To Register  
<http://www.radioworld.com/webinars7>

View this webinar **FREE** of charge –  
click the link above to play the  
on-demand archive, recorded  
December 8, 2009.

### Guest Speakers:



James Cridland  
Radio Futurologist



David H. Layer  
Senior Director, Advanced  
Engineering, NAB Science  
& Technology Department

### Sponsored by:



**RADIOWORLD**  
The News Source for Radio Managers and Engineers



# BROADCAST EQUIPMENT EXCHANGE

## BAY COUNTRY BROADCAST EQUIPMENT

### BUY - SELL - TRADE

Your #1 Source

For Quality Used Radio Broadcast Equipment

View The Latest List Online at: <http://www.baycountry.com>  
Or call and we will fax it to you.

7117 Olivia Rd., Baltimore MD 21220

Toll Free: 877-722-1031 • FAX 443-596-0212 • E-mail: [sales@baycountry.com](mailto:sales@baycountry.com)

## ACOUSTICS



Full product line for sound control & noise elimination.

[www.acousticsfirst.com](http://www.acousticsfirst.com)

## ANTENNAS/ TOWERS/CABLES

### WANT TO SELL

FCC COMPLIANCE

### TOWER SIGNS

AM & FM Tower Signs  
ASR-Tower Registration  
Standard & Custom signs

Guy Wire Protectors - Ant. Tags

### ANTENNA ID PRODUCTS

[antennalD@msn.com](mailto:antennalD@msn.com)  
Free Catalog  
610-458-8418  
[www.antennalD.com](http://www.antennalD.com)

### WANT TO BUY

Deicer Transformer for Dielectric DCR FM antenna wanted, part #A-17696. Contact Jim Stitt, 513-621-9292 or [towerjimsk@gmail.com](mailto:towerjimsk@gmail.com).

Wanted: Deicer Transformer for Dielectric DCR FM antenna. Transformer part #A-17696. Contact Jim Stitt, 513-621-9292 or [towerjimsk@gmail.com](mailto:towerjimsk@gmail.com).

## AUDIO PROCESSING (INCLUDES ON-AIR)

### WANT TO BUY

Teletronix LA-2A's, UREI LA-3A's & LA-4's, Fairchild 660's & 670's, any Pultec EQ's & any other old tube compressor/limiters, call after 3PM CST - 214 738-7873 or [sixtiesradio@yahoo.com](mailto:sixtiesradio@yahoo.com).

## AUTOMATION EQUIPMENT

### WANT TO SELL

It's free and it has been expanded. The only cost is to keep us informed as to how the system is performing and let us know how you are using it. DIY-DJ, is a Linux based radio automation system and now sports a record scheduler (DIY-DJ-RECORDER)

**ROTRON BLOWERS AND PLATE BLOCKERS**, new & rebuilt for Elcom, Harris, CCA, CSI, McMartin. Goodrich Ent. 11435 Manderson St. Omaha, NE 68164 402-493-1886 Email: [CGoodrich@tconl.com](mailto:CGoodrich@tconl.com)

SCA Demodulator Cards, \$12.00/ea, 417-881-8401.

### WANT TO BUY

Collector wants to buy: old vintage pro gears, compressor/limiter, microphone, mixing consoles, amplifiers, mic preamps, speakers, turntables, EQ working or not, working transformers (UTC Western Electric), Fairchild, Western Electric, Langevin, RCA, Gates, Urei, Altec, Pultec, Collins. Cash - pick up 773-339-9035

2" plastic "spot" reels 6.5 or 8" diameter, as used for quad video. Wayne, Audio Village, 760-320-0728 or [audiovlg@gte.net](mailto:audiovlg@gte.net).

Equipment Wanted: obsolete, or out of service broadcast recording gear, amplifiers, preamps, outboard, radio or mixing consoles, microphones, etc. Large lots acceptable. Pickup or shipping can be discussed. 443-854-0725 or [ajkivi@gmail.com](mailto:ajkivi@gmail.com).

I'm looking for San Francisco radio recordings from the 1920's through the 1980's. For example newscast, talk shows, music shows, live band remotes, etc. Stations like KGO, KFRC, KSFO, KTAB, KDIA, KWBR, KSF, KOB, KCBS, KQW, KRE, KTIM, KYA, etc. I will pay for copies... Feel free to call me at 925-284-5428 or you can email me at [ronwtamm@yahoo.com](mailto:ronwtamm@yahoo.com).

**SPACE IS AVAILABLE!**

To advertise, call  
615-776-1359

which allows you to schedule the recording of a network or any other program for replay later as well as a basic logging system. Beside these additions the system schedules music, does voice tracking (ALWAYS hit the vocal), create a shell, live assist, exact time events, join satellite feeds, automated temperature announce, do unattended remote events and more. Call (406) 679-0527 or email [krws@digitaldevelopment.net](mailto:krws@digitaldevelopment.net) for a copy today.

## COMPLETE FACILITIES

NEW OR USED COMPLETE PACKAGES

STUDIO/STL/TRANSMITTER /ANTENNA OR ANY COMBINATION OF ABOVE.

-LEASE OPTIONS-  
-EMERGENCY RENTALS-  
-REMOTE BROADCAST RENTALS-

SCMS, Inc. (800) 438-6040  
"You Know We Know Radio"

## MICROPHONES/ HEADPHONES/ SPEAKERS/AMPS

### WANT TO BUY

RCA 77-DX's & 44-BX's, any other RCA ribbon mics, on-air lights, call after 3PM CST, 214 738-7873 or [sixtiesradio@yahoo.com](mailto:sixtiesradio@yahoo.com).

## MISCELLANEOUS

### WANT TO SELL

## STOP AM RADIO INTERFERENCE

with a plug-in modem/telephone RF filter from:

K-Y Filter Company  
3010 Grinnel Place  
Davis, CA 95618  
(530) 757-6873

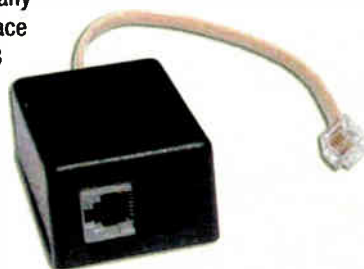

[www.ky-filters.com](http://www.ky-filters.com)

Model AM-1 is for AM Broadcast Band radio interference.  
Model RF-1 is for Short Wave, Ham Radio, CB etc.

## RECORDING & PLAYBACK HARDWARE

### WANT TO BUY

Large or small collections of 16" transcriptions or 12" transcriptions, not commercial LPs. Bill Cook, 719-687-6357.

Schnader telescriptions 16 mm musical films produced in the early 50 s. Bill Cook, 719-687-6357.

Standard Short-tune series. Bill Cook, 719-687-6357.

## REMOTE & MICROWAVE

### WANT TO SELL

**WE RENT FOR LESS**

Blueboxes	FM Exciters
Zephyrs	FM Power Amps
POTS Codexes	STL's
RF/Audio Gear	Test Equipment

If we don't have it, we will get it!  
SCMS, INC. (800) 438-6040  
"You Know We Know Radio"

TFT 9100/9107 composite STL system w/manuals, like new, \$4000; Marti STL 15C composite STL system w/manuals, vgc, \$1700. G Harrison, 540-672-1000.

## STATIONS

### WANT TO SELL

AM Station in Rome, NY REDUCED PRICE plus FM translators in Enid OK, Jacksonville, NC & Temple, TX, Taylorsville, IL, Hopkins-

ville, KY, Lawrenceburg, TN. Email [mralej@bbnradio.org](mailto:mralej@bbnradio.org).

KBUX-FM Radio Station f/sale in Quartzsite, AZ, 205 watts, FCC approval f/6000 watts. License only or w/studio/house on 1/2 acre+/- . King of Arizona Realty, Jayne F. Cushman, Broker, 928-927-5464.

## TAX DEDUCTIBLE EQUIPMENT

(2) Continental AM xmters that can be donated for FREE, 1 is a 10kW at 1560 KHz, model 316 in Aberdeen, SD, the other is a 5 kW at 920 KHz, model 315, in Coin, IA, you arrange transportation, both worked with turned off. D Horton, 888-712-5937 or 712-246-5234 or [fr112nelm@iamtelephone.com](mailto:fr112nelm@iamtelephone.com).

Donations Needed: All Volunteer, Non-profit Low Power community radios stations need Equipment. Will offer tax deduction letter, You determine donation value, We



World Leader  
in  
AM-FM  
Transmitters

Complete inventory at:

[www.Besco-Int.com](http://www.Besco-Int.com)

Pre-Owned AM-FM units in stock!

R.E. Witkowski - President  
Rob Malany - Vice President

Info: (972)-931-6055

Sales: (321)-960-4001

Email: [Sales@Besco-Int.com](mailto:Sales@Besco-Int.com)

## TRANSCOM CORPORATION

Serving the Broadcast Industry Since 1978  
Transmitters and Broadcast Equipment for Radio & Television

Please visit our website,  
[www.fmamtv.com](http://www.fmamtv.com), for additional listings.

Used FM Transmitters			
1	KW	2009	Crown FM1000E (demo), solid state
2	KW	2001	BE FM2-C, solid state
5	KW	1988	Harris FM5K1
5	KW	1991	Harris HT5
10	KW	1995	Harris HT10
14+5	KW HD	2005	BE Fm1405 (IBOC), solid state
20	KW	2005	BE FM20S, solid state
27.5	KW	1984	Continental 816R-4B, solid state IPA
27.5	KW	1999	Continental 816R-4C, solid state IPA
35	KW	1986	BE FM35A

Used AM Transmitters			
5	KW	1982	Harris MW5A
5	KW	1987	Harris MW5B
50	KW	1986	Nautel Amplet 50

### Exciters

\*New\* 30W Synthesized exciters  
Used BE Fxi250 FM & HD exciter  
Used Harris Digit 2nd Generation exciter  
Used Nautel NE-50 exciter



CROWN BROADCAST



New TV Transmitters- Analog and Digital  
OMB, Pineapple and Technalogix  
VHF and UHF TV Antennas  
(10 W to 10 KW) TV STL

800-441-8454 • 215-938-7304 • FAX: +1-215-938-7361

[www.fmamtv.com](http://www.fmamtv.com) • E-mail: [transcom@fmamtv.com](mailto:transcom@fmamtv.com)  
RETUNING & TESTING AVAILABLE • CALL US FOR A QUOTE!





**NEW**

# ECONCO NEW TUBES

New tubes are now manufactured by **ECONCO** at our award winning facility in Woodland California! Of course, we continue our 34 year tradition of high quality power tube rebuilding.

TEL: 800-532-6626  
 INTL: +1-530-662-7553  
 FAX: +1-530-666-7760  
 www.econco.com  
 SE HABLA ESPAÑOL



## CONSULTANTS

**OWL ENGINEERING, INC.**  
 Consulting Communications Engineers  
 5844 Hamline Ave. N., Shoreview, MN 55126  
**651-784-7445**

- AM/FM/NCE Applications
- Allocation and Upgrade Studies
- Pre-Purchase Inspections
- ANS and NRSC Measurements
- AM Directional Array, Design, Tuning and Proof using Method of Moments
- Tower Detuning
- Intermodulation Studies
- Radiation Hazard Evaluation and Measurements

Fax (651) 784-7541 E-mail: info@owleng.com "Member AFCC"

**We Expertly Refurbish Analog Optimods**  
 Factory Authorized Rechipping, Recapping, Realignment, and Restoration.

Bill Sacks, CPBE  
 (301) 880-7109  
**www.optimod.fm**

Optimod is a trademark of Circuit Research Labs, Inc.

### DISTRIBUTOR DIRECTORY

The following distributors serving the broadcast industry would be glad to help you with any of your requirements.

**CORNELL-DUBILIER MICA CAPACITORS**  
 FROM STOCK

**JENNINGS VACUUM CAPACITORS**  
 FROM STOCK

**HIGH ENERGY CERAMIC CAPACITORS**  
**SURCOM ASSOCIATES**  
 5674 El Camino Real, Suite K  
 Carlsbad, California 92008  
 (761) 438-4420 Fax: (761) 438-4759  
 e-mail: link@surcom.com web: www.surcom.com

**AMB Atlantic Media Broadcast**  
 SERVICE AFTER THE SALE SINCE 1997  
 1-800-AMB-0004  
 800AMB0004.com

COMPLETE STUDIOS  
 PRE-BUILT OR TO YOUR SPECIFICATIONS

ANTENNAS AND TRANSMITTERS  
 UPDATE YOUR OLD TRANSMITTER & IMPROVE AUDIO CHAIN

**FASTER... MORE ACCURATE RADIO COVERAGE**

- Real Time 3-D Displays
- Interference calculations
- Cost effective mapping
- Fully integrated databases
- Used by the FCC
- Latest standards built-in

**RADIO SOFT**  
 8910 Davis Hill Pkwy, Torrance, CA 90507  
 PH: 800-773-6800 Fax: 706-294-2248 Email: sales@radiosoft.com  
 Visit us on the web at www.radiosoft.com

**GRAHAM BROCK, INC.**  
 BROADCAST TECHNICAL CONSULTANTS  
 Full Service From Allocation to Operation AM/FM/TV/AUX Services:  
 Field Work, Antenna and Facilities Design

Over 45 years engineering and consulting experience

912-638-8028  
 202-393-5133  
 www.grahambrock.com

**cmbe**  
 (processing)

- AM, FM and TV coverage predictions and upgrade studies
- Broadcast transmission facility design
- FCC applications preparation
- Contact Clarence M. Beverage or Laura M. Mizrahi for additional information

**Communications Technologies, Inc.**  
 Radio Frequency/Broadcast Engineering Consultants  
 P.O. Box 1130, Marlton, NJ 08053  
 Tel: (856) 985-0077 Fax: (856) 985-8124  
 www.comtechrf.com

**Mullaney Engineering, Inc.**  
 Member AFCC  
 Serving Broadcasters Since 1948

9049 Shady Grove Court  
 Gaithersburg, MD 20877  
 (301) 921-0115  
 Fax (301) 590-9757  
 mullaney@mulleng.com

**Doug Vernier**  
 Telecommunication Consultants  
 Broadcast Engineering Consulting  
 AM/FM/TV/LPTV/DTV  
 Custom mapping service  
 Frequency searches  
 Propagation prediction  
 FCC application preparation

**Vsoft**  
 Software for your PC  
**(800) 743-3684**  
 www.v-soft.com

**M. Celenza**  
 Communications Consultant  
 AM-FM-LP-FM-TV  
 \$250.00 FM Frequency Studies  
 Applications, Amendments, Allocations  
 PHONE: (631)965-0816  
 FAX: (631)403-4617  
 EMAIL:  
 mcelenzacomunicationsconsultant@yahoo.com

**SPACE IS AVAILABLE**  
**Call David 615-776-1359**

**TUBES**

**FOR THE BEST PRICE**  
 & 24 Hr service on transmitting tubes & sockets/parts, new & rebuilt call Goodrich Ent. at **402-493-1886** day or night,  
**www.goodrichenterprises.com**

**POWER Eimac YOU CAN TRUST**

**ISO 9001 Certified**  
 The Choice of Successful Broadcasters Since 1934

**NEW POWER TUBES**  
 Triodes  
 Tetrodes  
 Pentodes

**NEW SOCKETS & REPLACEMENT PARTS**

**Worldwide Availability**

Made in U.S.A.

CALL 800-414-8823  
 Int'l (650) 592-1221  
 Fax (650) 592-9988

Visit our Web Site at **www.eimac.com**

**Pro-Tek**  
 Communications & Power Industries

**EEV**  
 BROADCASTING USA DISTRIBUTOR

352-592-7800  
 Fax 352-596-4884

**TRANSMITTERS/ EXCITERS/ TRANSLATORS, CONT.**

**OFF THE AIR? Emergency Back-up Rentals**

FM Exciters - STLs -  
 FM Pwr Amps - Antennas -  
 Studio & Test Equipment

**SCMS Inc (800) 438-6040**  
 "You Know We Know Radio"

**Best Assured! FCC Certified**  
**FM Stereo Transmitter**

- ✓ 50W RF output, continuous duty!
- ✓ Auto protect with auto soft fail & auto restore!
- ✓ Automatic battery backup!
- ✓ Digital display of all parameters
- ✓ Perfect for LPFM, Translators, as well as stand-alone exciters

**www.ramsyelectronics.com**

**ramsey** 800-446-2295  
 In Our 36th Year!

## EMPLOYMENT

Artistic team player consistently demonstrates quality programming/production skills, and a relentless pursuit to build an audience one listener at a time. Dwayne 620-331-9163; dwaynesmith@cablone.net.

Have a passion/knowledge for sports and music, with can-do-attitude! Ability to work under pressure, and fast paced environment. Bilingual/Will relocate. Noemi Ochoa, 817-626-8917; nochoa1021@rocketmail.com.

Talented, quick witted and community minded on air personality with great voice talents, creative copywriter. Proficient in Cool Edit/Adobe Audition. Anica Mayes, 682-227-5151 or amayes2004@gmail.com.

**RF PARTS™ CO.**  
 Se Habla Español We Export

EIMAC • TAYLOR • SVETLANA  
 New & Rebuilt Tubes - Same Day Shipping

Motorola • Toshiba • SGS • Thomson & Mitsubishi Semiconductors

800-737-2787 760-744-0700  
 rfp@rfparts.com www.rfparts.com

**D And C Electronics**  
 An International Distributor of RF Components  
**Tubes**  
 NEW & REBUILT

TRANSMITTERS, STUDIO EQUIPMENT, STLs, ANTENNAS,  
 RADIO DATA SYSTEM (FOR CAR RADIO DISPLAY)  
 EXCITERS-TRANSMITTERS, TRANSLATORS, MIXERS-CONSOLES, RADIO LINK  
 RPU, MOSFETS, VACUUM CAPACITORS, SOCKETS

**Eimac** **Pro-Tek**  
 SVETLANA **EEV**

BEST PRICES To Order: 1-800-881-2374  
 Outside U.S. (352) 592-7800  
 Se Habla Español

FROM OUR STOCK

P.O. Box 6409 Spring Hill, FL 34611  
 BEST SERVICE 352-592-7800  
 Fax 352-596-4884  
 Website: www.dandcelectronics.com



# AM, Losing Its Grip on Reality

## Here in the Field, the Outlook For Small Stations Is Troubling

BY SCOTT TAYLOR

The handwriting appears to be on the wall regarding the slow but steady decline of terrestrial radio as it now exists, and this appears to be especially true for small-market AM radio.

### COMMENTARY

With all the new technologies, especially those from the Internet, mom-and-pop operators are bombarded with challenges and competition that in many cases are becoming insurmountable. Many of these stations have been limping along for years; and because the owners have so much of their life and assets invested and limited transferable skills to another occupation, they plod along keeping their stations together with baling wire, spare parts, outdated equipment, limited funds and a whole lot of wishing and hoping that things will improve.

I work for a contract engineer and have had a close-up look at many small-market AM facilities. The outlook is bleak.

On a recent visit to a small station, I found the owner/operator walking around the transmitter site with a scrap metal dealer, evaluating how much money he could get for the tower, ground radials and feed lines. To me, this

was unnerving.

Over a recent three-month period I had conversations with three owner/operators who were seriously considering letting their licenses expire or just handing them in because the properties were worth more as real estate.

Outdated and worn-out equipment is a serious issue at many of these facilities. I am no longer surprised at how many small AMs continue to use old Gates Yard boards, Realistic/Radio Shack audio mixers and DJ equipment, cassette recorder/players, very old turntables and, yes, reel-to-reel equipment ... and of course old cart machines. New digital technologies, automation and even the thought of HD Radio appear to be only "pipe dreams" to some owners.

#### SHACK RADIO

Awhile back, I went to a small community AM station to evaluate a problem. What I saw would not have been believed had I not seen it myself.

The owner stated that he had lost ownership of the tower and studio building a few years back to the FM operator on the same stick, to get money to pay off his house before foreclosure. The day I arrived at the FM studio I was directed around back to a plywood outbuilding — a shack — measuring about 12 by 16 feet. This was the AM station.

Inside I met the owner, sitting at a makeshift plywood table supported by 2-by-4 legs. On the table was a three-channel Radio Shack audio mixer. The owner was using a Radio Shack microphone and a portable Sony handheld CD player ("top-of-the-line \$50 unit," I recall him

**On one visit I found the owner/operator with a scrap metal dealer evaluating how much he could get for the tower, ground radials and feed lines.**

saying) as the audio feed of his "oldies show." From the mixer, a line ran to a dbx compressor/limiter that sat on a piece of plywood placed across the open top of a galvanized trash can. The output fed an old BE transmitter.

The owner said other engineers had told him the situation was bordering on hopeless or required serious updating and lots of money. He wanted another opinion.

As tactfully as I could, I said I had to agree and that although his station was in fact functioning and on the air, the situation was dire. Except for a few small immediate improvements and suggestions, I could not offer much.

While there I asked the owner how

much he thought he could get for his station if he were ever to sell. With a straight face he said, "Four hundred to five hundred thousand, for sure."

As I walked toward my car, I could not help but feel that the station's days were numbered.

Terrestrial AM radio clearly is losing its grip on reality. The downward spiral is picking up as the "big boys" continue to liquidate and sell off unprofitable operations, as mom and pops give way to apartment and townhome complexes and

a way of life passes on. Lean and mean is now the order of the day. Long-term continuous employment in today's radio is questionable at best as more and more pink slips are being handed out. Unless immediate changes are made and action taken quickly to counter the onslaught of new and fierce competition, it's going to be "game over" for a good number of small-market AMs.

As I sat in my car and prepared to drive away from that station, I thought about the owner's estimate of the value of his station. I could think of only one word for him and similar small-market AM operators: Delusional.

*Comment on this or any article. Write to radioworld@nbmedia.com.*

**RADIOWORLD**  
The Newspaper for Radio Managers and Engineers

Our readers have something to say

*"We are impressed by the numerous articles by James O'Neal. They are extremely well written while providing detailed, accurate information about the history of radio and its development."*

**Ted Kuligowski**  
IEEE BTS Newsletter Staff  
McLean, Va.

Shown: Heil Deco Series Fin

**ADVERTISER INDEX**

This listing is provided for the convenience of our readers. Radio World assumes no liability for inaccuracy.

PAGE	ADVERTISER	WEB SITE/URL
14, 15, 25	Axia - A Telos Company	www.axiaaudio.com
21	BSI	www.bsiusa.com
3	BSW	www.bswusa.com
6, 7, 35	Comrex Corporation	www.comrex.com
4	ERI	www.eriinc.com
22	Grace Broadcast Sales	www.gracebroadcast.com
17, 19	Harris Corporation	www.broadcast.harris.com
32	Heil Sound, Ltd.	www.heilsound.com
10	Inovonics Inc	www.inovon.com
11	Logitek	www.logitekaudio.com
9	Omnia - A Telos Company	www.omniaaudio.com
24	Progressive Concepts	www.progressive-concepts.com
23	Pulsecom	www.pulse.com
13	Telos Systems - TLS Corp.	www.telos-systems.com
1	Tieline Technology	www.tieline.com
2, 36	Wheatstone Corporation	www.wheatstone.com



# 'Progress Towards a Common Ground'

Remarks by Arbitron's CEO on Capitol Hill About the PPM

*Here are remarks by Michael Skarzynski, CEO of Arbitron, to the U.S. House of Representatives Committee on Oversight and Government Reform on Dec. 2.*

For more than 60 years, Arbitron has been dedicated to advancing the interests of the radio industry. We provide the

## NEWSMAKER

quality data that allows radio broadcasters to make programming decisions — and advertisers to make their media buying decisions.

Today's hearing is focused on Arbitron's Portable People Meter — or PPM — and its impact on minority radio stations.

We share the concern regarding the health of this important voice of the broadcasting community. We are however confident that PPM is not the cause of the challenges faced by minority broadcasters.

It is encouraging to note that urban adult contemporary is the most listened to format in the top 16 PPM markets. This was reported just two days ago by an important trade publication, Inside Radio. We believe that the Inside Radio report is another strong indication that PPM continues to reflect reliably the lis-

tenership of all formats including urban and Hispanic.

Arbitron has worked to implement the PPM service responsibly and fairly — and we have always been sensitive and responsive to customer concerns raised about PPM.

Arbitron launched its innovative ratings service to help support the entire radio industry's objective to have relevant, reliable data that enables it to compete against television, Internet and other media for advertising revenue.

While PPM represents a significant advance, it cannot do everything. It cannot solve the severe economic challenges that the radio industry has confronted for the last two years.

**PPM continues to reflect reliably the listenership of all formats including urban and Hispanic.**

We have all felt the impact of a recession that has caused a drastic — and in some cases devastating — decline in radio advertising, with resulting significant declines in radio revenue. Further, PPM cannot address the high debt burdens faced by many radio broadcasters,

including minority broadcasters.

Our radio broadcast customers asked Arbitron to develop an electronic measurement service that helps them showcase the value of radio.

Our advertising agency customers asked us to provide them a service that more accurately reflects exposure to radio.

We responded.

## SOLID METHODOLOGY

The development of PPM is a reflection of our commitment to improving radio. Arbitron spent more than \$100 million over 10 years developing this solution. We incorporated input from industry players and the technology has been thoroughly tested over time.

The PPM technology and methodology are solid. PPM was honored by Time magazine as one of the best inventions of 2007. PPM methodology was built on the MRC-accredited diary methodology and produces valid and reliable audience estimates.

I cite AM stereo, HD Radio, new and improved EAS — and the list goes on. We do just fine in analog and I would be happy with Conelrad back.

I have always been amazed as to the faith the commission puts into the input it gets from corporate radio. These are the guys who are filing for bankruptcy, selling properties, firing people, fail in emergencies and don't "serve in the public interest."

I would love to have a translator but that doesn't seem possible at the moment. A 10 or 15 watt translator would do wonders for us. We would cover our little city and that would be fine.

A fellow broadcaster asked why I wouldn't want more power so as to cover Baton Rouge. The answer is simple; we don't live in Baton Rouge. Baton Rouge, like most cities, already has about 10 too many radio stations.

We will continue to work hard to be a part of our community and pray that someday the commission will understand that there is more to radio than the corporate giants. We little guys are very valuable to the survival of radio. We do it right and get virtually no help from Washington.

Thank you for the thought-provoking story.

*Harry Hoyler  
General Manager  
KKAY(AM)  
White Castle, La.*

In fact, PPM has been the audience measurement tool of choice for several years in a number of European countries, as well as Canada and Singapore.

Overall, we have received a great deal of positive customer feedback about PPM. Broadcasters are telling Arbitron that PPM provides reliable, timely and granular data.

Providing our broadcast customers the more timely PPM data has helped guide mid-course corrections and programming adjustments to advance their business.

For example, California radio station KJLH — owned by Stevie Wonder — added "The Steve Harvey Show" on Aug. 10, 2009. Current PPM data shows that KJLH, between September and October 2009 — experienced a 60 percent increase in morning drive share for persons 18–34.

When I joined Arbitron in January of this year, I made it my priority to visit customers personally.

I learned from customers that there are powerful and constructive ideas about how we can improve our PPM service.

In fact, listening to our customers has helped us craft our continuous improvement program as we strive to improve our PPM service and make it a valuable asset for the industry. Every technology requires improvements and we believe we have been both proactive and responsive to making improvements.

This year we have:

- Expanded cell-phone-only sampling to a national average of 15 percent and we expect to increase to 20 percent by year-end 2010;
- Instituted country-of-origin reporting; and
- Expanded extensive training, in-person coaching and enhanced incentives to encourage greater survey participation.

Additionally, we are working with our customers and other industry leaders to develop an Engagement Index. As envisioned, the Engagement Index would be a metric that complements existing data and reflects an audience's involvement and loyalty to a particular station.

This cooperative work could help all broadcasters, advertising agencies and advertisers have a balanced impact on radio ad planning and buying.

We have been working tirelessly with members of the minority broadcasting community and we believe that with your leadership and a continued dialogue we can make progress towards a common ground.

Mr. Chairman, Arbitron welcomes the opportunity to work with you and members of this committee to address the challenges of the minority radio broadcasters.

## OUR AM DOES QUITE WELL, THANK YOU

I read with interest your story concerning the relevancy of AM radio ("Is AM Radio Still Relevant?" Sept. 1).

Let me be the first to say that AM is far more relevant than FM. I say this as an AM broadcaster and a person who loves radio.

## READER'S FORUM

I have a small 1 kW AM in the Baton Rouge market and I must say we do quite well. We are not in debt, pay our bills and do what we do best, "Serve in the Public Interest."

During Hurricanes Katrina and Gustav our little station ran circles around the corporate giants. We did this with old equipment, static in our signal and most of all with people, yes people.

I, like many AM operators, appreciate the new translator ruling but it is flawed terribly for many of us. There are no translators in the Baton Rouge market. They have been scarfed up by corporate radio and worst of all are not being used as best we can see.

In my almost 30 years in the business I have found that most of the new giz-whizzes for radio borderline on junk.



Next Issue of RADIO WORLD January 13, 2010  
Next Issue of ENGINEERING EXTRA February 17, 2010E-mail: radioworld@nbmedia.com  
Web site: www.radioworld.com  
Telephone: (703) 852-4600  
Business Fax: (703) 852-4582  
Editorial Fax: (703) 852-4585

For address changes and subscription renewal, please visit radioworld.com and click on the "Subscription" button. To submit letters or story proposals, to request writer's guidelines, or for other editorial matters, e-mail the editor at radioworld@nbmedia.com.

**EDITORIAL STAFF**  
EDITORIAL CHIEF, U.S. Paul J. McLane  
NEWS EDITOR/WASH. BUREAU CHIEF Leslie Stimson  
GEAR & TECHNOLOGY EDITOR Brett Moss  
TECHNICAL ADVISER Thomas R. McGinley  
TECHNICAL EDITOR, RWEE Michael LeClair  
PRODUCTION EDITOR, RWEE Karen Lee  
CONTRIBUTING EDITOR John Bisset  
INTERNATIONAL EDITOR IN CHIEF T. Carter Ross  
LATIN AMERICA EDITOR IN CHIEF Rogelio Ocampo  
LATIN AMERICA EDITOR Karina Gerardi  
MANAGING EDITOR, WEB Brian Smith  
EDITORIAL ASSISTANT, MILAN Peter Finch**EDITORIAL CONTRIBUTORS**  
W.C. Alexander, Steve Callahan, James Careless, Harry Cole, Mark Durenberger, Charles Fitch, Ty Ford, Harold Hallikainen, Craig Johnston, Paul Kaminski, Peter King, Mark Lapidus, Daniel Mansergh, Sharon Rae Pettigrew, Carl Lindemann, Ted Nahil, James O'Neal, Tom Osenkowsky, Ken Deutsch, Rich Rarey, Tom Ray, Randy Sine, Richard Strickland, James G. Withers, Tom Vernon.**ADMINISTRATION & PRODUCTION**  
PUBLISHER John Casey  
EDITORIAL DIRECTOR T. Carter Ross  
PRODUCTION DIRECTOR Davis White  
PRODUCTION PUBLICATION COORDINATOR Karen Lee  
ADVERTISING COORDINATOR Caroline Freeland**CIRCULATION**  
ASSOCIATE CIRCULATION DIRECTOR,  
AUDIENCE DEVELOPMENT Anne Drobish  
CIRCULATION MANAGER Kwentin Keenan  
CIRCULATION COORDINATOR Michele Fonville**SUBSCRIPTIONS**  
Radio World, P.O. Box 282, Lowell, MA 01853  
TELEPHONE: 888-266-5828 (USA only 8:30 a.m. - 5 p.m. EST)  
978-667-0352 (Outside the US) FAX: 978-671-0460  
WEB SITE: www.myRWNews.com  
E-MAIL: newbay@computerfulfillment.com**CORPORATE**  
NewBay Media LLC  
PRESIDENT AND CEO Steve Palm  
CHIEF FINANCIAL OFFICER Paul Mastronardi  
CONTROLLER Jack Liedke  
GROUP CIRCULATION DIRECTOR Denise Robbins  
VICE PRESIDENT OF WEB DEVELOPMENT Joe Ferrick**VIDEO/BROADCAST GROUP**  
EXECUTIVE VICE PRESIDENT Carmel King  
VICE PRESIDENT / SALES DIRECTOR Eric Trabb**ADVERTISING SALES REPRESENTATIVES**  
US EAST & LATIN AMERICA: John Casey, jcasey@nbmedia.com  
T: 330-342-8361 | F: 330-247-1288  
US WEST & CANADA: David Carson, dcarson@nbmedia.com  
T: 615-776-1359 | F: 866-572-6156  
SOUTHERN EUROPE, AFRICA, MIDDLE EAST:  
Raffaella Calabrese, rcalabrese@broadcast.it  
T: +39-02-7030-0310 | F: +39-02-7030-0211  
UK & IRELAND, CENTRAL & NORTHERN EUROPE:  
Graham Kirk, g.kirk@audiomedia.com  
T: +44-1480-461555 | F: +44-1480-461550  
JAPAN: Eiji Yoshikawa, callems@world.odn.ne.jp  
T: +81-3-3327-5759 | F: +81-3-3322-7933  
ASIA-PACIFIC: Wengong Wang, wwg@imaschina.com  
T: +86-755-83862930/40750 | F: +86-755-83862920  
CLASSIFIEDS: David Carson, dcarson@nbmedia.com  
T: 615-776-1359 | F: 866-572-6156

Radio World Founded by Stevan B. Dana

Radio World (ISSN: 0274-8541) is published bi-weekly with additional issues in February, April, June, August, October and December by NewBay Media, LLC, 810 Seventh Avenue, 27th Floor, New York, NY 10019. Phone: (703) 852-4600, Fax: (703) 852-4582. Periodicals postage rates are paid at New York, NY 10079 and additional mailing offices. POSTMASTER: Send address changes to Radio World, P.O. Box 282, Lowell, MA 01853.

REPRINTS: Call or write Caroline Freeland, 5285 Shawnee Rd., Ste. 100, Alexandria, VA 22312-2334; (703) 852-4600; Fax: (703) 852-4583

Globe graphic ©iStockphoto.com / Edward Grajeda

Copyright 2010 by NewBay Media, LLC.  
All rights reserved.  
Printed in the USA**REVENUE SPLIT**

In her Sept. 1 commentary about performance royalties, Ms. Bendall is absolutely right, "Everyone deserves to be paid for their work."

**READER'S FORUM**

Small stations like ours work hard to promote music, both new and old; but to date, we've never received a dime from the labels or performers who profit from our efforts. And even now, when some are asking for it via musicFirst, I've never once had an artist, performer or even a label representative personally ask for payment when they sent or brought a CD by for me to play.

So let me get this right: I take it and play it, they sell CDs, I sell spots and I'm not being fair?

OK, Ms. Bendall, let's wipe the slate clean. Here's a suggestion: I'll stop selling advertising and help promote your performer's music, T-shirts, concerts, events, posters, watches, movies, etc. We can split the revenues 50-50.

That sounds fair to me.

*David Chenault  
Operations Manager  
KMOO(FM), Hightower Radio Inc.  
Mineola, Texas***WHAT'S FAIR ABOUT THAT?**

Ms. Bendall, I never saw in your article where the word "label" was referred to. Could this have been an oversight or a deletion for cause?

You refer to fairness. I may have missed it but I do not see where more costs being brought to the radio station owners for labels' profits is fair.

You also stated, "Nor does it come down too heavily on radio." Could you explain "heavily"? I know this fee would put numerous stations out of business and a lot more going to "talk radio" because they cannot afford all the little fees placed upon them.

My breakdown is a little different than yours. Should this fee pass, a radio station owner who makes, let's say, \$101,000 a year pays 26 percent for writers' royalties, 5 percent for performance royalties for a total of 31 percent of gross revenue to start but that ends up going up a percentage every year or every renewal of contract(s) — for example government regulatory fees, BMI, ASCAP and SESAC.

What is fair about labels getting 50 percent, artists 45 percent and musicians 5 percent? Radio stations have to pay for equipment, maintenance and repairs, building and tower rent or payments, insurance, not to mention employee related fees, federal, state and local taxes, etc. etc. etc.

Show me where the fairness is. I, along with a lot of other radio station owners, can't see it.

The artists need to go after the labels they signed with. They are the ones making the big bucks, not the radio stations.

I also feel the record labels have ripped off artists for years; when you first start out in that business you would do just about anything to get your music out there, but in the long run end up on the short end — not from the radio stations who promote them for free, but the labels and some managers they chose to sign with.

Also, in case you haven't noticed, our country is in a financial crisis and monies are tight all the way around. I feel the artists should go after the labels, not the people who are out there using their own resources to play their music, for free.

Serving the public interest is our first priority; we give up much commercial air time in times of crisis and offer local news, events, weather etc. If this royalty fee passes we would be forced to cut back on many public service projects due to lack



of personnel as we will be forced to cut jobs.

Fairness is to remember that we pay the electric bill that runs the transmitters that provide artists the means and airways of playing their music. That includes information about artists and help packing concert halls they perform in. This results in lots of money for them, their agents and again their labels. Fairness?

*Linda D. Jones  
Owner  
110 Broadcast Group  
Seminole, Okla.***A NEW REVENUE MODEL**

Since she is the consummate paid lobbyist for the record labels/RIAA/musicFirst, we can understand why Jennifer Bendall stated plainly transparent "opinions" in her commentary.

If you don't know by now, it's all about the money to line the pockets of the record labels, and nothing else.

The time has come for radio stations to end the free ride and to start charging record labels to promote and popularize their product — as every other business is charged when radio advertises their product.

The change I urge the radio profession and government regulators to support is: "You Pay, We Play. You Don't Pay, We Don't Play."

Establish a radio industry broadcast play royalty board. Establish a fee schedule for promotion and radio plays. Charge artists a fee, per play, per station, on every radio station it is played on.

The fee schedule: Artists with no record label: 1 cent per play. Indie record labels: 2 cents per play. Labels with revenues between \$100 million and \$500 million, 10 cents per play; labels with revenues over \$500 million, negotiate fees of 11 to 50 cents per play.

Distribute play revenue evenly to all 13,000 U.S. radio stations

*Tony Coloff  
President/General Manager  
KIOW(FM)  
Forest City, Iowa***CHANGE THE RULES**

I am amazed that broadcasters have not started to charge record companies and artists to air their recordings. Why aren't we charging them?

If they want to change the rules, so should we.

*Peggy L. Renschler  
Assistant Secretary  
Family Stations Inc.  
Sacramento, Calif.*





## Comrex BRIC-Link

provides reliable, high quality, cost-effective IP audio transmission over dedicated links.

**plus**



## ISM Band 5.x GHz IP Radios

from Trango Systems, Tranzeo, Motorola, Tsunami and others available at BGS provide a low-cost, unlicensed, line of sight data link.

**equals**

## Perfect, low cost STL solution

Use with BRIC-Link's linear and FLAC modes for full bandwidth audio with minimal delay. Easy to set up. Low operating cost.



Available from:

**Broadcasters  
General Store**

www.bgs.cc • 352-622-7700

**BRIC Link**

World Radio History

Put Comrex on the Line  
**COMREX**

www.comrex.com



# FINALLY... FAILSAFE NETWORKED A/DIP.

## WHEATSTONE E-SERIES & WHEATNET-IP ARE YOUR BEST CHOICE BY A LONG SHOT.



When it comes to networking your facilities, there's only one best choice. Wheatstone. For years, we've been the network/control surface choice of top broadcasters. And with good reason – we care.

Wheatstone's Audio-Over-IP product is the best in the business. Here's why:

**1. WheatNet-IP is easiest for a station to implement and configure.** It is, hands down, the easiest in the industry. No need for Wheatstone to provide factory on-site assistance unless you really WANT us there. The manual and app notes will have you up, running and stable in less time than any other system.

**2. WheatNet-IP is a natural for large facility multi-station networking (and for smaller facilities too!).** It uses the IGMP features of Ethernet Layer 3 switches to identify a multicast packet – see which ports are requesting that packet, and send it only to those ports. Traffic control is maintained and system bandwidth is optimized.

**3. Redundancy is critical.** A typical WheatNet-IP installation has multiple levels of redundancy. Each BLADE holds the complete map of the entire system within its onboard memory – we call it distributed

intelligence – a system with 50 BLADEs has 49 backups with failover in the event of a failure. Cisco Stackwise technology provides redundancy in the central core TOC switch. A WheatNet-IP/E-Series console studio complex can stand alone, even if the TOC goes down, with backup analog or digital program audio feeding a back end router independent of the core Gigabit infrastructure.

**4. Modular is better.** Why would you want to combine your switch, mix engine and I/O into one box? Beats us. With WheatNet-IP, you install only what you need, where you need it. We believe in not overselling.

**5. Manufacturing quality is very important.** Wheatstone is proud to have the best track record in the business for build-quality, reliability and intelligent functionality. With far more up-and-running installations than anyone else, this is where we really shine. An investment in WheatNet-IP and E-Series control surfaces today will reward you with a future-proof, failsafe networking/control environment that's infinitely updatable and in for the long run.

### 6. WheatNet-IP has an advantage.

Take a look at your entire environment. Wheatstone is a perfect partner because we are always there, always innovating. Built into every WheatNet-IP BLADE are features others just didn't think of – handy utility mixers, silence detection, crosspoint routing control, headphone monitoring of any source, lots of logic GPIO, and comprehensive metering of audio I/O, not just signal-presence indicators. And, in the hugely unlikely event that a BLADE needs to be replaced, you just plug in a new one and enter the BLADE number. That's it.

**7. Wheatstone is local.** WheatNet-IP and the E-Series, just like ALL Wheatstone products, are designed, engineered and built from start to finish in our New Bern NC USA facility. Everyone who works on our products is 100% knowledgeable and immediately available. You can relax – as with the famous insurance company, you ARE in good hands.

With WheatNet-IP, we think we've done our homework. In fact, we know we have. And we're happy to say that we've got the best product on the market. To learn more, and there's a LOT more, get us on the phone or visit us on the web. We'll be happy to meet with you and get you everything you need.



Audio Networking – Simply Evolved

phone 1.252.638-7000 | [www.wheatstone.com](http://www.wheatstone.com) | [sales@wheatstone.com](mailto:sales@wheatstone.com)