

*****AUTO**3-DIGIT 857
 S117298 D08 0508
 TOM MILLER 541
 ASST CHIEF ENGINEER
 KTZR
 2033 S AUGUSTA PL
 TUCSON AZ 85710 7905

News Flash
 Choices proliferate in
 CF audio recording.

Down by the Riverside
 In Shreveport, Cumulus heads
 for the water.

Page 36

Page 34



Radio World

\$2.50

The Newspaper for Radio Managers and Engineers

October 26, 2005

Should Radio Be 'First Responders'?

by Randy J. Stine

WASHINGTON Some broadcasters and emergency management officials are asking whether government should have an increased role in keeping radio stations on the air "at all costs" during catastrophic events.

The recent hurricanes along the Gulf Coast sparked the debate.

Who ultimately is responsible for broadcaster preparedness is not a matter of debate, according to sources familiar with public warning. Broadcasters must spend the resources to build redundant operational systems and develop emergency plans, they say.

However, some emergency communications experts have wondered if broadcasters should be given "first responder" status, similar to that granted public safety departments. The designation would give stations special privileges such as guaranteed access to diesel fuel and emergency generators.

Such a move would be unprecedented, they believe.

Emergency management sources interviewed for this article agree that broadcasters played a critical role disseminating lifesaving information to thousands of civilians stranded in New Orleans and other Gulf Coast cities and listening to radios, often portable radios.

Who's special?

Also at issue is which federal entity should be responsible for granting broadcasters such special privileges.

Is this a matter for the Federal Emergency Management Agency, or the FCC? Others believe the National Communications System, which operates under the auspices of the U.S. Department of Homeland Security and is responsible for maintaining telecommunication infrastructure during emergencies, should take responsibility.

See RESPONDER, page 12 ▶

ENGINEER OF THE YEAR

Mike Starling is the recipient of Radio World's 2005 "Excellence in Engineering" Award

Page 4

Starling stands outside NPR headquarters in Washington with the dented chassis of the first NPR Tomorrow Radio Kenwood test receiver used in multicast testing.

Continental Electronics

HD Radio the way it should be done

HD Radio and Analog FM in a single box. Continental Electronics stands alone with the proven and most efficient HD solution. Upgrade your existing Continental Electronics 816R-C FM transmitter now or buy a new Analog FM Transmitter upgradeable when you need HD. And, don't forget its "Built Continental Tough".

800.733.5011 • www.contelec.com

HD Radio
Licensed Manufacturer

COOL STUFF AHEAD



Sign Up For
NewsBytes
 Weekly Digest at
www.rwonline.com

Rita Broadcast Damage Less Than Feared

by Randy J. Stine

HOUSTON Sporadic power outages and minor facility damage were themes among broadcasters here in the wake of Hurricane Rita. The outages forced a handful of stations off the air for various lengths of time.

More damage was reported up the Gulf Coastline in cities such as Beaumont and Port Arthur, Texas. Many stations in small markets lost power after local co-ops suffered infrastructure damage.

In some cases, broadcasters joined forces to air emergency information after Rita came ashore. Special exceptions were made for broadcasting per-

sonnel to avoid the ordered evacuations in Houston; and the FCC again remained open over the weekend, as it did during Katrina, to expedite emergency service authorizations.

Increased preparedness was evident thanks in part to Katrina, broadcasters said. "No one took this lightly. Our broadcasters were very proactive in their preparations," said Ann Arnold, executive director of the Texas Association of Broadcasters. "We coordinated in advance with power and utility companies asking that priority would be given to our members to have electrical power restored."

The 200-station Texas State Network, headquartered in Austin, fed

continuous Rita coverage to any station wanting the programming, Arnold said. "This allowed some stations to evacuate additional people in advance of the storm. It was especially important to get out evacuee information."

Jed Wilkinson, director of engineering for Cox/Houston, said he and other engineers went through as many scenarios as possible to prepare for Rita.

"We asked, 'What if the studios go down ... can we have the transmitters automatically switch through audio from another source or carry a TV simulcast?' Those kinds of things."

Cox has consolidated studios for FM stations KTHT, KKBQ, KLDE and

See RITA, page 7 ▶

Have You Seen My Tower?

A radio station in Texas lost a lot more than its broadcast signal when Hurricane Rita zoomed inland along the Texas Gulf Coast. The station's broadcast tower collapsed, and parts of it were missing afterwards.

KWUD(AM) is licensed to Woodville, an east Texas community of 2,500 people about 50 miles north of Beaumont. The 1,000-watt station broadcast from a 190-foot tower.

"The cinder block transmitter building survived, but the tower was ripped away from the base and fell over," said Jim Carroll, president of Carroll Texas Broadcasting. "We took quite a hit."



Carroll speculated that one of the many tornados spawned by Rita snapped the tower off and carried pieces of it away. "It's in the woods somewhere," he said.

A tower company was on site to examine the situation within a few days of the storm and the station had ordered steel for a new tower, Carroll said. The station remained off the air a week after the storm.

Carroll Texas Broadcasting also owns stations in Wyoming and Montana.

— by Randy J. Stine

THIS IS THE NEXT BIG THING:



WHEATNET™ — FUTURE PROOF!

WHEATNET LETS YOU ROUTE THOUSANDS of bi-directional signals at ONCE in just 60 microseconds—all secure, virus-proof and in just 2 rackspaces! WHEATNET leaps way ahead of conventional stacked router or IP-based designs, interconnecting up to 48 studios (each with its own independent mix engines and I/O resources) using just one CAT-5 wire per studio, plus providing systemwide X-Y control from one central location. You can even meter and monitor (in stereo) any signal systemwide.

REDUNDANCY? We've got that covered too: just add a second WHEATNET and CAT-5 link from each studio and have an AUTOMATIC standby interconnect for the ENTIRE system!

WHEATSTONE has a proven track record for digital networking; benefit from our experience!



48 CAT-5 PORTS with 128 audio channels (plus embedded control data) per port. THAT'S 6144 TRAFFIC CHANNELS IN JUST TWO RACK SPACES!



Wheatstone

GET THE POWER!

tel 252-638-7000 / sales@wheatstone.com

copyright © 2005 by Wheatstone Corporation

Index

NEWS	
Should Radio Be 'First Responders? Rita Broadcast Damage Less Than Feared	1
Radios' Future Seen in New Distribution	2
From the Editor	3
Hurricanes, Ownership Top FCC's Time	4
Hurricane Katrina Up Close	6
Newswatch	8
	10
HD RADIO	
HD Radio Multicast a Go-Go	14
HD Radio Scoreboard	15
Overheard at the Radio Show	16
FEATURES	
Workbench: Document Your Site Economically	20
Who's Buying What	21
Crawford Makes Room for Multicasting	22
When Streams Become Files	24
Surround Content for HD Radio	26
Studios to Feel Some Digital Growing Pains?	28
At WGUC, Eager for Radio Surround	30
STUDIO SESSIONS	
Cumulus Shreveport Hangs at the Mall	34
A Compact Guide to Flash Recorders	36
BUYER'S GUIDE	
NextMedia Likes NexGen Voice-Tracking	40
WNYC Produces With Digasystem '04 Hurricanes Yield Automation Upgrade	41
Nassau Likes SS32's Comm Module	42
SkimmerPlus Eases Podcasts for WRAL	45
KAXE Sticks With DAD for Upgrade	46
WRAY Makes Transition to Vault?	46
Paradis Has Automation 'Smarts'	48
Digital Juke Box Services Appalachia	48
OPINION	
Reader's Forum	52-54
Preparation Means Asking Questions	54

Radio's Future Seen in New Distribution

Some Say Medium Needs to Reinvest in Itself by Promoting HD Radio

by Leslie Stimson

While more public and commercial stations have begun multicasting, Ibiquity is urging stations to promote their digital conversions and not wait for a plethora of receivers to reach the market.

Meanwhile, the industry watches the FCC, wondering how commissioners will handle multicasting, AM nighttime authorization and other final IBOC rules.

With Katrina a recent memory and Rita in the headlines during the recent NAB Radio Show, broadcasters' response to hurricanes and other disasters was praised by commissioners who attended the event. The convention also was the last such show as association president and CEO for Eddie Fritts.

This story and material that follows here and in the HD Radio section of this issue highlight news from the convention.

CHOOSE NEW DISTRIBUTION PLAN, PUSH BACK ON WALL STREET

Radio needs to figure out how it will be distributed in the next 3 to 5 years. So said Jon Coleman of Coleman Research in a session on radio's future, as he held up a cell phone that plays streaming radio. The key is not to wait for a return on investment in any new distribution model, he said. "If we wait, everyone else will have a distribution plan but radio."



Big check: NAB donated \$1 million to hurricane relief and Eddie Fritts said broadcasters overall would well exceed their \$100 million target.

have to market a product that's compelling. "We're going to have to push this band in a way that's consistent," he said regarding multicasting. "I don't think people are going to beat a path to buy a radio to find 'LiteFM HD-2.' Brand extension generally doesn't work." He urged radio to program what 18-34-year-olds want to hear.

What about the radio business in general in the future? John Parikhal of Joint Communications said radio will "fall over" if it sees more consolidation.

"Wall Street is either a pimp or someone who beats you. They want everything out of you and then they dump you." It's

with IBOC signals, 100 to 150 are outside the top markets, she said.

Panelist Paul Tinkle, who started as a janitor at a station he now owns in

verting.

For stations, IBOC has preserved the commercial broadcast model, he said. "If it weren't for IBOC, I believe you could be looking at a new service, like Eureka-147 or DRM, in a new terrestrial band, and these services would not necessarily be owned by broadcasters."

The benefits of IBOC, Morgan said, for AM are "remarkable" audio quality and improved audio quality for FM that would especially be apparent to mobile listeners in high multipath areas. The flexibility in how the bit stream can be portioned for multicasting or other data uses is a benefit, he said.

"Anything that could be done on an SCA can be handled by the ancillary data stream of IBOC. One of the problems I always encountered with SCAs was that if you sold it to a stock quote service, you could not use it for paging. With IBOC, they both flow in the same bit stream," said Morgan.

But he cautioned of potential pitfalls for some IBOC users, such as potential first-adjacent interference on FM. "But this interference would generally be outside your existing protected service area."

Only time will reveal how the commission will handle exceptions such as short-spaced or facilities adjacent to grandfathered high-powered FMs, he said.

AM is different, he said, noting that both atmospheric and man-made noise as well as interference from co-channel and adjacent-channel stations contribute to AM interference. IBOC can dramatically reduce

See FUTURE, page 5 ▶

Tennessee, said :30 spots in his town sell for \$8 a piece. Given that reality, he's not willing to spend money to convert his facilities to IBOC "when there's not that many people listening to it."

MORGAN NOTES AM IBOC Qs, BUT SAYS GO AHEAD

In the session on small markets and technology, Charlie Morgan, semi-retired as senior vice president of Susquehanna Radio and current chairman of the NRSC, laid out the pros and cons of con-



Dick Lewis, regional vice president of Clear Channel in Baton Rouge, La., discusses emergency preparedness and response.

Bill Figenshu, president of Figmedial and former executive with Infinity and Citadel, said national media coverage gives the misimpression that satellite radio has more listeners than does terrestrial, an image traditional radio needs to correct.

"I'm afraid the competitors are playing with real bullets. They have huge budgets." He expressed concern that when he walks into a Circuit City or a Best Buy and asks to see HD Radios, he's been taken to a satellite radio display.

Radio needs to "get cracking and execute a plan," said Jon Coleman. "The good news is we have a free medium and we have a product that people are interested in on a free medium. We can't just kick that away by being stupid."

As far as promoting HD Radio, Figenshu said receiver manufacturers "will give us two years to get it together. This means we

time for radio to push back on Wall Streets demands, lower expectations and reinvest more profits into stations, he said.

"I see businesses that made their number and then dropped dead. It's time to push back." Stations should also make better use of their Web sites, which he called underutilized.

HD RADIO TO LESSEN TSL DECLINE?

Robin Flynn of Kagan Research said Kagan believes HD Radio's multicast channels will be an incubator for new formats, and that digital radio in general will lessen the decline in time spent listening to radio. Flynn made the comments during a session on technology's future in small markets.

Of the 500 or so stations on the air

Attention... Station Owners... CEs... GMs... SMs... PDs... NDs...

There's A New Kid In Town!

In case you hadn't heard yet... Broadcast Depot wants your business! You no longer need to settle for so-so service from your present supplier, or "so-called" guaranteed lowest prices that really aren't the lowest available!

www.7bd.com

We have all the Popular Brands! Great Service! and the BEST PRICES!

And, now we've added an ol' pro to assist you with your daily needs!



Contact Chuck Malnes at Broadcast Depot to get your next quote, and see what you've been missing!

Email: cmalnes@7bd.com | www.7bd.com

Toll-Free: 877-90-BDNow (23669) | Fax: 765-983-3817

FROM THE EDITOR

Starling: Excellence in Engineering

by Paul McLane

Michael Starling is the recipient of the 2005 Radio World "Excellence in Engineering" Award.

Recipients represent the highest ideals of the U.S. radio broadcast engineering profession and reflect those ideals through contributions to the industry. The award was presented during the NAB Radio Show in Philadelphia, where Starling also



NPR President/CEO Kevin Klose and Starling celebrated another honor, NPR's recent 'Cool Stuff' Award for innovation in multicasting, at the network's headquarters.

"The Outer Limits" in 1963, the story of a chief engineer and station manager siphoning power from the transmitter to communicate with a being from the Andromeda Galaxy. "It was probably 20 years before I realized it, but that had really ignited my imagination and led me into shortwave listening in junior high school. I quickly became a ham operator and was instantly mesmerized by the magic of sending voices and music through the air. I went in that direction straight away."

He became president of the high school amateur radio club, working 113 countries in the middle of the night. Meanwhile, a ham friend was studying for his First Class Radiotelephone, hoping to get a job at a nearby station, and urged Starling to get his Third Class so he could work as a DJ. Starling, apparently not shy even then, called all the stations in town and landed the job at WBMD.

New duties

Thirty-six years later, Starling, age 53, is among the elite engineers in radio.

As chief technology officer and vice president of engineering and operations for National Public Radio, he has been responsible in recent years for strategic technology, operations, audio engineering and engineering technology, overseeing a staff of more than 100, a \$12 million annual operating budget and \$2 million in annual capital projects. He has been principal architect of numerous NPR regulatory positions before the FCC.

He has a new title now; days after he received this award, NPR announced Starling's promotion to chief technical officer and executive director for NPR Labs. That means he is "the primary visionary on technical policies at NPR on behalf of the member stations — helping chart a course for the future of public radio."

But his influence goes beyond that. You'd be pressed to name a radio engineer who has had greater impact in the past year.

He played a key role in the exploration of multicasting, one of the most important technology developments in U.S. radio right now. The Tomorrow Radio Project, of

which he was architect, led directly to the exploration — by commercial and public stations alike — of airing multiple program channels in existing spectrum using digital radio technology.

Starling recently established NPR Labs, an advanced technology research and development center, at a time when the industry desperately needs more technical R&D. Readers will recall his Guest Commentary here (March 30) on the need for such a center.

He also launched an NPR certification mark for digital radio receivers; and he's a leader in creating national "best operating practices" recommendations.

"I called him up and said, 'I've always thought of having my own station, is there any chance of doing it?' He was great and helped me," Starling recalled. "That's how I found Amherst, Va. Within a couple of years I found a frequency, got local funders and signed it on in 1976."

Starling counts Perry among his most important influences; another is John Folsom, former DOE of KPBS(FM/TV) in San Diego, who "taught me a lot about standards, the real meaning of 'good engineering practice' — making sure our exhibits into the commission were absolutely pristine and error-free."

Starling also learned the value of a range of experience. He holds a law degree and is admitted to the California, District of Columbia and Federal bars, which helps him in his public policy work. For two years he was engineering operations super-



Radio World editors, publishers and suppliers and NPR colleagues congratulated Starling at the RW booth during the NAB Radio Show.

received a PR-40 large-diameter studio cardioid microphone courtesy of Heil Sound Ltd. as part of the award.

Starling got his first job in radio because he was persistent — and because he happened to walk into a station that had fired its entire air staff the day before. The PD was pleased that this ambitious 17-year-old held a Third Class FCC permit with broadcast endorsement — this was 1969 — and hired Starling for a Sunday shift at WBMD(AM) in Baltimore.

But ask him how he got into radio and he'll look back to the inaugural episode of

This is an engineer who tends to look farther ahead than most. He also consistently has acted in the best interests not only of his employers but of the industry.

His past accomplishments aren't shabby either. At age 24 he launched a station in Virginia, WKYY(AM). He got the idea while working as a copyboy for Broadcasting magazine. Opening the mail, he saw a flyer from an engineering consulting firm, Educational FM Associates, run by Ed Perry.

He was chief for nine years at KPBS; he has been a DOE and was president of a consulting firm, AM/FM Associates. He studied journalism/radio-TV at the University of Maryland.

I asked him if his studies in law and journalism are unusual for an engineer.

"Maybe it's unusual to have those particular threads," he said, "but most of the engineers I know have had experience in other realms; and it's that practical experi-

See STARLING, page 7 ▶

...SCROLL WITH IT...

RDS Master™

RDS ENCODER

Learn more at www.burk.com/rds/

✓ SAME DAY SHIPPING

✓ SAME DAY SUPPORT

✓ SAME DAY SERVICE

BURK TECHNOLOGY

800-255-8090 (Main Office)
800-736-9165 (Radio Sales)
www.burk.com

Future

► Continued from page 3

such interference, he said, but he noted the potential for interference to first-adjacent analog services, with views on this issue ranging from "insignificant to horror stories."

Morgan said NRSC felt that this interference would only be noticeable in areas outside protected contours during daytime hours.

For AM nighttime, skywave for clear channel stations "will be severely damaged and may go away," said Morgan. Interference to first-adjacent analog services may be a problem at night, but the magnitude of this interference has yet to be determined, he said.

Questions to be answered, he said, include: Will this interference replace existing interference? Will it add to interference in areas where a signal is already unusable? Will much of this new interference be masked by existing interference?

The commission must wrestle with these questions, Morgan said. He feels personally that the only to get answers is for the commission to authorize nighttime AM IBOC operation, "with certain restrictions to ensure that adjacent channel stations are not adversely affected, on a station-by-station basis."

STRUBLE: TRAFFIC NO. 2 HD-R KILLER APP; PROMOTE NOW, TABLETOP AVAILABILITY

Stations need to promote the fact that they've converted facilities to HD Radio and take advantage of the data possibilities with the technology, Ibiqity Digital President/CEO Robert Struble told program directors.

The data applications associated with HD Radio are like "RDS on steroids," he said. Broadcasters should monetize billboards on the radio faceplate with messages such as "1-900 Allstate."

"You get money for that," he said.

Some stations that convert don't send text with their signals to the receivers. He asked that such stations at least make sure radios receiving their signal display the station call letter; otherwise, sometimes a receiver serial number is displayed.

If multicasting is a so-called "killer app" for HD Radio, real-time traffic is another, Ibiqity believes.

"Traffic is big. Think of this as a data pipe. It's cheap, and there are several hundred devices that will receive your data. Car guys get into traffic, the real-time plotting for traffic into the bit stream. You see where you're going and where the issues are," Struble said.

Three to five years into the future, on-demand services will be big for stations using the Ibiqity technology, the company says. "TiVo for radio. Ultimately, this is the 'buy' button," said Struble, who estimated this capability will be available in two or three years.

But stations must promote their digital conversion. "The whole challenge of building awareness of HD Radio is really going to fall on you." Noting that XM and Sirius have spent a great deal in promotion, Struble said, "The reality is, we're \$750 million in the hole. We're behind. There's a ton of confusion about HD Radio.

"The question we would ask the industry is: 'Why would you spend all this money and then not tell anybody about it?'"

Ibiqity would like to get network radio

talent involved in promoting the technology.

He acknowledged that limited promotion to date is due to the small number of HD Radio receivers available to the public. Struble noted that Kenwood, JVC and Panasonic have car units available, but acknowledged that tabletops, which stations would like to use as giveaways, are late.



Dataworld is now part of BIA Financial Network. Jack Neff, left, marks the sale with Tom Buono of BIAfn.

Boston Acoustics expected a November release, he said. Radiosophy told Radio World at the show that those who have already ordered a unit would receive it in December. Polk Audio said recently it plans to ship HD Radio-capable units early next year.

ATTENDANCE UP FROM SAN DIEGO, DOWN FROM PHILLY

NAB said about 3,789 attendees and 115 exhibitors registered for the Radio Show in Philadelphia.

That attendance figure translates to a 15 percent increase over the San Diego show last year, when 3,293 attendees and 89 exhibiting companies took part, according to the trade group.

But attendance this year was off a bit from two years ago in Philly, when NAB had estimated 3,900 attendees.

FRITTS SAYS 'GOODBYE'

Eddie Fritts said goodbye to TV in the spring, and he got that chance with radio in September.

He noted in his opening address this would be his last such event as the association's president and CEO. Calling the moment bittersweet, Fritts said despite competition from iPods, satellite radio, Blackberries and cell phones, "there is no substitute for the immediacy of local radio."

Nowhere has the power of radio been more apparent than in the station response to Hurricane Katrina, Fritts said, as he thanked broadcasters in the Gulf Coast area that stayed on the air. "Some of you lost your homes, and yet continued to broadcast."

Donations raised during the BroadcastUnity Day organized by NAB in September surpassed the initial \$100 million goal and were heading towards \$200 million, he said.

NAB RADIO SHOW IN DALLAS NEXT YEAR

The NAB has tried over the years to figure out the best format for its fall radio show, including scheduling it as part of a combined show with other organizations, as in the World Media Expo concept.

Next year, the radio show will be co-

located with the R&R Convention in Dallas. "We plan on combining the energies of two great radio events to give programmers and management even more opportunity to interact," said John David, executive vice president, NAB Radio.

The Dallas events will be held at the Wyndham Anatole Hotel on Sept. 20-22, 2006. Attendees registering for either The

Galveston markets discussed Hurricane Rita preparation plans.

They shipped satellite phones, fuel and other supplies to accessible locations, coordinated backups for server facilities and discussed how they could evacuate staffs and broadcast programming from alternate sites depending on which direction the hurricane took. See related story, page 2.

IBIQUITY NAMES HD RADIO PROMO CONTEST WINNERS

Ibiqity Digital Corp. announced winners of its nationwide HD Radio Promo contest, with \$10,000 going to Mark Tammany of WKQX(FM) in Chicago for the promo "Stay Tuned."

Other winners, of \$1,000 each, are:

- Best AM HD Radio On-Air Promo: Mike Amatori, KGO/KSFO/ABC, San Francisco
- Best FM HD Radio On-Air Promo: Randy Gross, WARM(FM), York, Pa.
- Best Independent Producer-Created On-Air Promo: Ron Harper, Ron Harper Voiceovers, Mason, Ohio
- Best HD Radio promo copy: Doug Zanger, Entercom, Portland, Ore.
- Best HD Radio page on a station Web site: Eli Christopher, KBKS(FM), Seattle

Judges included Bob Shannon of hobshannonworks, Bobby Ocean of Bobby Ocean Inc. and David Martin of Media Arts & Sciences. The promo contest was launched in conjunction with Ibiqity's HD Radio Playbook, an online promotion guide.

NAB Radio Show or the R&R Convention in Dallas will be given access to sessions at both events.

HURRICANE RITA TOP OF MIND FOR ENGINEERS

In the hallways of the NAB Radio Show engineers of radio groups and networks with operations in the Houston and

MILLENNIUM DIGITAL CONSOLES NOW SHIPPING!

RADIO SYSTEMS' CONSOLES DAS HYBRIDS CLOCKS

Year after year, broadcasters depend on Radio Systems' studio products. For performance, price and dependability THERE IS NO BETTER VALUE.

Millennium 6, 12, 18 & 24 Channel Analog and Digital Consoles • 4x4a & DA-16 Distribution Amplifiers DI-2000 & TI-101 Telephone Hybrids • CT-2002 Clock and Timing Systems w/GPS and Infrared Remote

Radio Systems, Inc.
601 Heron Drive, Logan Township, NJ 08085
phone: 856 467-8000 Fax: 856 467-3044 www.radiosystems.com

Hurricanes, Ownership Top FCC's Time

*Multicasting Could Be a Sticking Point
With Varying Views of Public Interest*

by Leslie Stimson

PHILADELPHIA Questions about public service may have the potential to stall radio's nascent move to multicasting, with Republican and Democratic commissioners taking different views of the implications of supplemental channels.

That was one of the topics that arose in discussion at the NAB Radio Show. Meanwhile, hurricane preparedness and response, media ownership and satellite radio are top-of-mind radio topics at the

FCC, based on comments by two commissioners.

Moderator Bruce Reese, the NAB's Joint Board chairman and the president/CEO of Bonneville, asked Commissioners Kathleen Abernathy and Jonathan Adelstein how they see discussions shaping up on the radio market definition, which he said broadcasters believe "has been resolved wrongly."

Abernathy said that with two court losses, it's appropriate to re-think the rules. As far as lessons learned, "We're supposed to think based on the (media)

world based as it is today. We're trying to come up with a formula that accurately measures all the pieces in play and come up with a hard number."

Her biggest challenge, she said, is not in large markets, which have several layers of media, but in the smaller to medium-size markets where, in some cases, the commission would only know what to do if it tackled the issue case-by-case. "We have to work in more flexibility in the analysis of these deals."

Adelstein described the original media ownership decision-making process as "one of the biggest storms to hit the FCC." The commission must let industry and the public know ahead of time what



Kathleen Abernathy

it's thinking before decisions are made, he said.

"If we had done that last time — we had begged the chairman (Michael Powell) to do it — we could have corrected the deficiencies and it wouldn't have been overturned by the Third Circuit."

The commission has received unclear, and sometimes conflicting, direction from the different courts, Abernathy said. The agency needs to build a rule around facts, and not anecdotal information, she said.

Pointing to broadcasters' frustration with satellite radio's move to offer local traffic and weather, Reese asked the commissioners how they define localism and the public interest.

Adelstein referenced the open Notice of Inquiry on that topic. Both commissioners said broadcasters' connection to their communities is their lifeline.

"The competition we see from a nationwide satellite radio kind of service is not local at all. That's not your market. Most broadcasters, I believe, get that. The inquiry is meant to make sure everyone gets the message without the agency needing to 'micromanage,'" Abernathy said.

She acknowledged that "if the two begin to look similar we'll have to step back and re-evaluate" the rules.

Final IBOC rules?

What about the final rules authorizing IBOC? On the technical issues, the agency seems to have found common ground, but there is a sticking point. Adelstein believes that while HD Radio is a great new technology that revitalizes service to localities, the multicasting channels raise questions of what public service obligations to impose on those new channels.

Abernathy, on the other hand, sees this as a new technology, and other than imposing basic service obligations on the service, is "inclined to see where this goes."

Both said they are working to find common ground on the issue and hope to resolve differences soon. Privately, several attendees told Radio World said they doubt that would happen until the Bush administration nominates a third Republican to the agency, breaking up what is now a 2-2 tie.

Hurricane matters

Both commissioners toured areas affected by Hurricane Katrina in September. During the convention, they noted that Hurricane Rita was heading for the Texas coast.

"Unfortunately, we're faced with this horrible situation in Texas," said

See FCC, page 7 ▶

You asked for a bulletproof console.

OK, maybe we're taking things a bit literally. But if a Mosaic console panel can stop a bullet, we figure it should be able to stand up to your board operators' daily abuse. The Mosaic's extra-rugged construction, combined with some of the most advanced control and operation features on the market, give your station the versatility you want with the durability you need. In short, bulletproof operation.



Mosaic
Where art meets technology

The Mosaic is a scalable, flexible control surface for the Logitek Audio Engine, a digital router that streamlines your installations and simplifies complex audio tasks.

We really did shoot a bullet at a Mosaic panel. The bullet dented the panel, but it didn't puncture it. For details on how the Logitek Mosaic bullet test was conducted, visit www.logitekaudio.com/bullet.



Logitek Electronic Systems, Inc.

5622 Edgemoor • Houston, TX 77081 USA

713.664.4470

1.800.231.5870

info@logitekaudio.com

www.logitekaudio.com

© 2005 Logitek Electronic Systems, Inc.

Logitek
Console Router Systems

Starling

► Continued from page 4

ence — in other than the mysteries of the ether and electrons — that makes for good, integrated engineers well-grounded in business, programming and marketing as well. Most of your practical, hands-on chief engineers have done lots of other things.”

Starling has managed big projects. He implemented what was at the time the largest U.S. digital audio networking system using high-availability server architecture, serving users in Washington, Los Angeles and New York via a WAN. Among his greatest challenges was the 1994 move of NPR into its current building — “in four months and four days, on time and on budget, with no loss of airtime;

quite a whirlwind of 20-hour days.”

His papers, articles and convention appearances are too numerous to list. Near to my heart, he has been active in supporting the International Association of Audio Information Services, for which I am a past board member; the radio reading services honored him last year with its C. Stanley Potter Lifetime Achievement Award.

He and his wife Linda, a special education resource specialist, live in Maryland. He has two grown sons, Eric and Jeff.

Fun stuff

“As corny as it sounds, I truly find it to be gratifying and something of an honor to work in this part of the industry,” he said. “I love public radio and I love engineering.” I asked Mike how he would describe what he does at NPR. His brief answer: “All the really fun engineering stuff.”

Starling is upbeat about radio’s future, noting that billions of people use our medium around the world. Even though podcasting and satellite have made a dent in listening in the United States, he said, the total number of users remains a little more than one-tenth that of traditional radio.

“It’s from a position of strength that we get to embrace the new technologies.”

Still, he says, radio must focus on protecting the integrity of its broadcast signals and remaining competitive with emerging technologies. “Only by having healthy signals and spectrum can we continue to reach the listeners we’ve built to serve.”

In the short term, he’s eager for the commission to approve multicasting for real, and for electronics companies to get receivers into the marketplace, “hopefully in the next few months.”

He’s also pleased to see an increasing

number of younger folks at public radio engineering events. “Even though it’s largely a room of gray hairs, there’s increasingly lots of youngsters showing up who are intrigued by the tuning intricacies of final amplifiers as well as IT-based projects. These are signs of hope.”

He points to NPR’s Kyle Evans as an example of an eager, younger engineer. Evans was an intern in 2003 for NPR’s summer engineering projects and is now a technical research associate for NPR Labs.

Starling’s words of wisdom to someone interested in an engineering career: Motivation and enthusiasm will carry you.

“If you’re really interested in it and you love it, don’t take no for an answer. Just keep knocking on doors until someone gives you a break.”

Radio is fortunate that Mike Starling has knocked on a lot of its doors. 🌐

Rita

► Continued from page 2

KHPT in the Galleria section of Houston, but maintains four transmitter sites. Cox simulcast news and information on its four stations.

“We sandbagged and boarded up the doors at our transmitter sites, all of which made it through just fine. We also boarded the windows at the studios and unplugged and centrally located all of our computer gear. I think I got the last 87 sheets of plywood from Magnolia Hardware,” Wilkinson said.

Finding diesel fuel was a major concern, he said. “Suppliers ran out when the warnings were issued. We didn’t have enough fuel on hand at our sites and scrambled to get fuel from different vendors.”

Susquehanna’s KRBE(FM) adapted its top 40 format to become a news station in advance of the hurricane, said General Manager Mark Shecterle. “It was, ‘Who has gas and what’s the latest evacuation route?’ Our operations were not impacted severely.”

A “skeleton crew” of station personnel remained to maintain operations, he said. “We had a plan with three different levels of response depending on the severity of the storm. Thankfully, we all made it through OK.”

Some STL and building damage was reported in Beaumont, 90 miles north-east of Houston, Arnold said. 🌐

FCC

► Continued from page 6

Adelstein. “Supplies are being put into position. It’s going to be another tough one.”

Abernathy and Adelstein praised the response of broadcasters and said it was good to see cooperation among groups and stations.

Abernathy spoke of Chairman Kevin Martin’s proposals, released just before the show, to shore up a coordinated response for broadcasters and telephone companies in the face of future disasters. Part of the plan calls for elevating the FCC’s Office of Homeland Security into a bureau.

“The goal of the restructuring is to make sure we have a clear, efficient way of coordinating after a disaster,” Abernathy said. 🌐



STAC
STUDIO TELEPHONE ACCESS CENTER

GOT CALLERS? STAC 'EM!

No matter what they're talking about, STAC is the best way to manage your calls.

STAC (Studio Telephone Access Center) puts you in control of your talk shows, request/contest lines, call-ins and phoners with great sound, ease of operation and scalable configuration. Incorporating a pair of Comrex high-performance digital hybrids, STAC provides the most natural sounding telephone audio — even when conferencing up to four callers.

The STAC system is available in six (STAC 6) and twelve (STAC 12) line versions. Connect up to four control surfaces using standard CAT5 cable — no custom cabling required. Best of all, STAC is incredibly easy to use — anyone can master it in seconds.

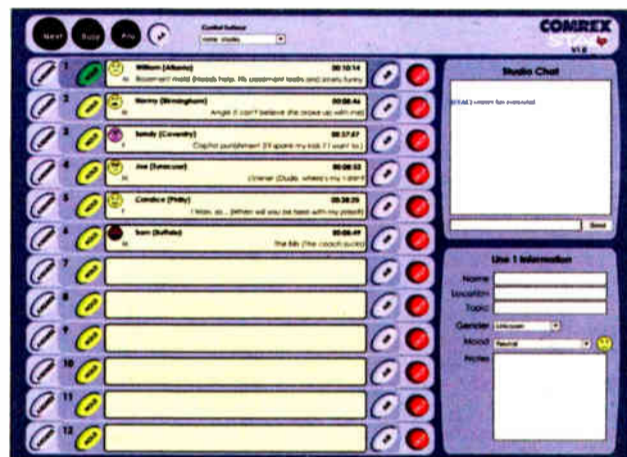

Use STAC any place there's a web browser!

If you have a computer, you've already got all the hardware and software you need. Just log onto the internet using a standard web browser — NO SPECIAL SOFTWARE TO INSTALL — go to your STAC IP address, and you are there! STAC 'EM from home, the studio or that great beach in Cancun!

Cool features include:

- **STAC IP** allows call control from multiple networked computers.
- **Busy-All** makes starting contests a breeze.
- **Auto-Attendant** answers, plays your message and STACs callers on hold. Great stress relief for screeners and producers!



Got Calls? Put Comrex On The Line.

Toll Free: 800-237-1776 • www.comrex.com • e-mail: info@comrex.com
19 Pine Road, Devens, MA 01434 USA • Tel: 978-784-1776 • Fax: 978-784-1717

COMREX

FIRST PERSON

Hurricane Katrina Up Close

by Jim Ryan

The author is senior reporter for WBAP(AM), Fort Worth/Dallas and Southwest correspondent for ABC News Radio.

I arrived in Florida on Thursday, Aug. 25, a few hours before Hurricane Katrina, a Category 1 storm with top sustained winds of 80 miles per hour, made landfall between Ft. Lauderdale and Miami.

As "mild" as a hurricane can be, Katrina still killed 11 people in several Florida counties and left more than a million without electricity.

It seemed at the time that Katrina would be just one more name on a long list chronicling the extremely active Atlantic hurricane season of 2005. I was told to cover the cleanup of South Florida and then head back to Dallas on Saturday, Aug. 27.

But on Saturday morning, after hearing predictions that Katrina might veer north through the Gulf of Mexico, ABC rebased me to Louisiana.

I got to New Orleans by late afternoon and walked over to the French Quarter to interview tourists and locals about their preparations (or lack of preparations) for the coming storm. Most said they were

not too concerned; New Orleans, after all, hadn't suffered a direct hit from a hurricane since Betsy, nearly 40 years earlier.

Initially, I was checked into a hotel on Tchoupitoulas Street, but decided that, if Katrina lived up to predictions, I would be stuck there with no way to communicate.

My usual travel kit includes a Marantz PMD660 "flash" recorder, a Shure VP64 microphone, a Comrex Vector POTS codec and a Dell Latitude PP01S notebook loaded with the old, reliable Cool Edit Pro editing package. But this gear would be of little worth without power, a POTS line or Wi-Fi connection.

I moved into the Windsor Court Hotel, where ABC(TV) had posted nearly a dozen of its staff members. There, I would have access to a satellite uplink that, in theory, would let me file even without electricity or telephone service.

Katrina lands

Hurricane Katrina made her second landfall east of Grand Isle, La., at about 6:30 a.m. on Monday, Aug. 29. Through the glass doors of my hotel balcony, I watched as the windows of skyscrapers in downtown New Orleans were blown out by 145-mile-an-hour winds.

Trees were snapped and roofs were ripped off.

Soon, in New Orleans' outlying areas, streets were flowing with water. Then homes. Then neighborhoods.

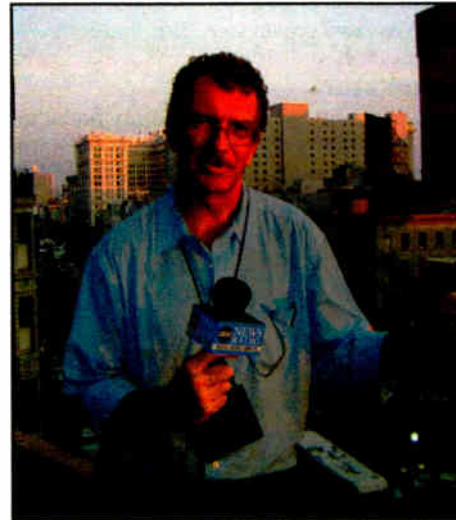

Jim Ryan reporting for ABC News Radio in New Orleans after Hurricane Katrina.

The Louisiana Superdome was designated a storm shelter of last resort for the homeless and sick who couldn't leave on their own. The arena lost electricity at the height of the storm and the roof sprung several leaks. But evacuees continued to flow in from flooded neighborhoods. Eventually the New Orleans Convention Center also was opened as a temporary shelter.

One by one, the local hotels that weren't evacuated before the storm started asking their guests to leave. Mayor Ray Nagin predicted that downtown buildings would soon flow with up to nine feet of water if the levee system continued to fail. His demand for a mandatory evacuation of the central business district became more emphatic.

Media companies from around the world began taking up positions along Canal Street, parking satellite trucks in the median and running cable beside the streetcar tracks sunken into the pavement. I spent three difficult nights sleeping in my rented SUV and eating my dwindling supply of beef jerky and granola bars. Parked next to the freelance uplink truck that ABC had sent into the city, I could go live via satellite to New York.

By Thursday, my television colleagues had established a supply chain and we were fed sandwiches from one of the few restaurants within 50 miles that were still open. On Saturday, a large "sleeper bus" pulled onto the ABC section of Canal Street. The cramped, triple-stacked bunks were a welcome change from the driver's seat of my vehicle.

Fanning out

Before Katrina's second landfall, ABC News Radio had placed personnel in several key locations — Los Angeles bureau reporter Alex Stone and New York engineer Kevin Rider were in Baton Rouge, while New York-based correspondent Aaron Katersky reported from Biloxi.

On Thursday, Alex and Kevin were sent into New Orleans. Kevin carried a portable Inmarsat uplink with him, so we were assured a reliable path out, regard-

less of television's broadcast schedule.

Meanwhile, my favorite city began to tear itself to bloody bits.

I watched shops along Canal Street and in the French Quarter being stripped clean by looters. Every afternoon smoke filled the sky and sirens wailed as downtown buildings were torched. Police officers, guardsmen and mysterious, unnamed personnel walked the streets with shotguns and AK-47s slung over their shoulders.

Finally, on the Saturday after Katrina's Monday arrival, the last of the storm victims were taken out of the Superdome and the convention center, leaving mountains of garbage, human waste and decaying corpses in the dark corners or on the street. For tens of thousands of people, living through the hurricane was only the first challenge. Surviving in the days afterward became the real test.

On Sunday I was re-based to Dallas, which meant driving to Baton Rouge, whose airport had re-opened. Rising up out of New Orleans on the tall highway ramps, I had a wide view of the city and its suburbs.

New Orleans — abandoned, burned, and soaked with floodwater — looked as though it had been hit with a bomb. The shoulders of the freeway were littered with abandoned cars, some stripped down to the frame.

At the Baton Rouge airport, more evidence of the misery: People who could afford to leave the storm zone on their own waited in long ticket lines and boarded crowded flights bound for anywhere but Louisiana. Drawn, unshaven faces and red, wet eyes stared out the windows at the planes taxiing on the tarmac and the helicopters taking off and heading southeast toward New Orleans. Clearly many of these people, like the ones who'd left in crowded charter buses, had no intention of returning.

Eleven days after I left Dallas/Ft. Worth for hurricane coverage that was to last only 72 hours, I was finally headed home. I can't remember ever wishing so badly to be back with my family.

Then came Rita

It was only a brief rest. I returned to New Orleans on Sept. 18 to begin an eight-day duty rotation at the ABC News Radio bureau established alongside the television operation in the Sheraton Hotel on Canal Street.

By Tuesday the 20th, the network realized that Hurricane Rita could pose as great a risk to the Texas coast as Katrina had to Louisiana. On Wednesday, I pulled into Galveston equipped with my usual PMD660/Comrex Vector/Dell notebook combination and with a Nera INMARSAT M4 unit, a Comrex Matrix and power inverters.

On the roof of a parking garage behind a Galveston hospital, I rode out Rita, which made landfall early on Sept. 24, along the Texas-Louisiana border. The INMARSAT allows the Matrix to be used as an ISDN connection, with near-perfect quality in both directions.

Under normal conditions I set up the flat-panel antenna outside and aim it at the southeast sky. But given Rita's hurricane-strength winds, I placed the antenna on the dashboard, pointed it out the windshield and aimed the car southeast.

The whole kit can run on batteries but, using the inverters, I powered it off the vehicle power ports. Establishing live shots was nearly flawless, even at the height of the storm. 🌍

Plug and play. Really.

It's not hype—you really can stream audio over 100 Mbps Ethernet with AudioScience's ASI 6416 professional PCI sound card with CobraNet™. Connecting is as easy as plugging in an Ethernet cable. Since CobraNet is non-proprietary, you'll be able to plug and play with any CobraNet-equipped device. And our ASIRoute software allows you to make routing connections on the network without ever touching a wire. For information, call us at +1-302-324-5333 or go to www.audioscience.com.

- 16 channels of CobraNet I/O
- 8 stereo streams of record and play
- PCM, MPEG layer 2, MP3 and Dolby AC2 formats
- MRX multi rate digital mixing
- Up to 4 cards in one system
- Windows 2000, XP and Linux drivers

CobraNet
CobraNet is a trademark of Cirrus Logic

AUDIOSCIENCE
Sound Engineering
Since Excellence

Multicasting.

It's like trying to fit —
well, you know.



Management has decided to multicast. Which seems like a terrific idea — until you consider just how little bandwidth each channel will get. How will the sound of your station(s) survive these shrinking bitrates? Omnia can help.

New Omnia Multicast with SENSUS™ restores the fullness and depth that bit-reduction steals. Our DSP gurus teamed up with the codec experts at Telos (the folks who introduced broadcasters to MP3 and MPEG AAC). Together, they developed a unique suite of tools to pre-condition audio for HD Radio™ multicasting.



Omnia Multicast with SENSUS codec conditioning, Omnia Bass Management system and distributed look-ahead limiter significantly improves the sound of HD multicast and other bit-reduced streams.

SENSUS technology enhances punch, preserves presence, and reduces artifacts. Even heavily bit-reduced channels (like multicast) can be significantly improved by Omnia running SENSUS. And like all Omnia processors, Omnia Multicast delivers the smooth, clean, pure signature sound that grabs your listeners and holds them hour after hour. No wonder the top stations around the world choose Omnia over all other processor brands.

Multicast like you mean it... with Omnia Multicast.



OmniaAudio.com

◆ NEWS WATCH ◆

Radio PTFP Grants Awarded

WASHINGTON Public Telecommunications Facilities Program grants for fiscal year 2005 are public, totaling some \$21.4 million for 123 projects. There are 73 radio awards totaling about \$7.4 million.

Of those, there are nine digital radio conversion grants awarding \$1 million and 64 radio service expansion or equipment replacement grants awarding \$6.3 million. Markets receiving digital radio projects include Boston; Columbus, Ohio; Concord, N.H.; Hutchinson, Kan.; Knoxville, Tenn.; Muncie, Ind.; Pittsburgh; and Norfolk and Roanoke, Va.

Eighteen radio projects will extend new public broadcasting service to approximately 400,000 people and provide additional service to about 700,000 people.

Two of the equipment replacement projects were awarded on an emergency basis in May. Grants were awarded to WUKY(FM), Lexington, Ky., and to KANZ(FM), Garden City, Kan., so the stations could place transmission equipment at new tower sites and maintain public broadcasting service. Both stations had rented tower space from commercial TV stations and were forced to relocate because of the digital conversion plans of the TV stations.

Included in the radio and television awards are grants so 22 public radio stations and five public television stations can purchase standby generators to enable the stations to continue public service programming during times of emergency.

BIA: Transactions To Remain Flat

CHANTILLY, VA. BIA Financial Network Inc. believes the number of stations sold in 2005 in the first half of the year was slightly higher than the same period in 2004.

However, it projects the value of 2005 radio transactions will not likely to rise above the \$2.4 billion in transaction value in both 2004 and 2003. That's accord-

ing to the financial group in its latest radio transaction report, released at the NAB Radio Show.

"While no one expected the level of sales to return to the numbers in the late 1990s and the early 2000s, some had hoped that the total value of sales would have rebounded," said Mark Fratrik, vice president of BIA. "Instead, the marketplace has been distracted by overwhelming competition for listeners and advertisers from both non-terrestrial radio and all forms of new media."

At the end of the mid-point of 2005, 500 stations were sold, compared to 900 sold in the full year of 2003 and 2004. The value of 2005 transactions for the first six months was around \$950 million. BIA projects the total value of 2005 transactions to be \$2 billion to \$2.4 billion.

Numbers could change if rumored sales of properties owned by Susquehanna Radio and ABC Radio occur. These two deals would be unique and not suggestive of a trend, said the financial group.

Many groups will continue to acquire single stations to fill-in gaps in existing markets. BIA said that many radio station buyers are acquiring stations with weak signals to improve facilities through a technical upgrade to increase the population served by the station, and consequently, the station's overall value.

NHPR Ups Signal

CONCORD, N.H. New Hampshire Public Radio said it completed two signal improvement projects designed to strengthen coverage for some 200,000 residents of the Nashua and Portsmouth areas. The project represents an investment of more than \$300,000, according to the pubcaster, which says much of the funding came in grants from business and foundations as well as contributions from listeners. Both stations are now on the air.

NHPR says its signal now covers more than 90 percent of the Granite State. The signal in Portsmouth is broadcast on 103.9 MHz from an antenna atop City Hall via a 170-watt translator and has the potential to reach more than 35,000 residents. In Nashua, WEVS(FM) will broadcast on 88.3 MHz with a 5,000-watt signal covering 166,000 residents of

Southern Hillsborough County, including the towns of Milford, Hollis, Amherst and Merrimack. WEVS Nashua will replace the translator at 90.3 MHz that has served Nashua since 1983.

WFUV Moves

NEW YORK Fordham University's WFUV(FM) has moved into new studios on campus. The facility includes control rooms, a performance studio, interview studios, voiceover booths and workstations. At more than 6,000 square feet, it offers twice the workspace of the former WFUV facility, according to station executives.

"Producers will finally have all the tools they need — literally, with ProTools editing stations — to no longer have to jump through hoops to get their work done," said Director of Technical Operations George Evans, who orchestrated WFUV's transition to the new facility.

WFUV is also in the process of erecting a tower on top of Montefiore Medical Center in the Bronx, which WFUV believes would double its signal reach from 7 million to potentially 14 million people. The new antenna is expected to be operational by January.

Europe New Hot Market?

NEW YORK Former CBS radio executive Dan Mason and programming consultant Walter Sabo believe Central and Eastern Europe is a hot new media market. The partners in Sabo-Mason International have a new management agreement with Tiger Global Management of New York to identify and acquire radio stations in Europe.

Sabo likened the market to that of the U.S. in the 1970s.

"For the first time there are entire countries free of government run radio and TV stations," he said.

Mason predicts radio station values will increase significantly soon. Many countries, he noted, have recently recently licensed independent stations.

The two planned to present a workshop at the NAB European Convention in Athens, Greece this month.

Senators Introduce Disaster Alert Bills

WASHINGTON Members of Congress introduced two bills that highlight the need to improve emergency communications during and after a disaster.

Senators Jim DeMint, R-S.C., and Ben Nelson, D-Neb., the chairman and ranking member of the Commerce Committee's Subcommittee on Disaster Prevention and Prediction, introduced S. 1753, the "Warning, Alerts, and Response Network Act."

The legislation would provide for the establishment a network to transmit alerts across a variety of media, including cell phones, Blackberry, digital, analog, cable and satellite radio and TV, as well as non-traditional media such as sirens and "radios-on-a-stick."

It would also provide at least \$250 million for the research, development and deployment of technologies and equipment to operate the alert systems.

Sen. John Kerry, D-Mass. introduced a bill requiring the Department of Homeland Security and FCC to explore the feasibility of using a back-up systems to improve communications capabilities during a natural disaster or terrorist attack.

The measure assumes analog spectrum to be given up by TV broadcasters when they convert to digital would be freed for emergency communications use.

Infinity Names a Digital PD

NEW YORK Infinity Broadcasting has named Dave Robbins as its director of digital programming. His added responsibilities include overseeing the broadcast group's HD Radio efforts and strategy, primarily development and expansion of the company's multicast stations.

Robbins will continue in his position as vice president and general manager of WUSN(FM) and WJMK(FM) in Chicago. He has been with Infinity since 1998.

Infinity credited Robbins with playing an integral role in the development and launch of Infinity's two multicast stations, Chicago's WUSN(FM) HD-2 and WJMK(FM) HD-2.



AM Radio DA Phasing System: The Way It Ought To Be.

Built for the digital revolution for Radio Disney by Kintronic Labs.

Nobody Does It Better!

WFDF Radio in Motown, USA
Eight Towers, 50KW, DA-2

423.878.3141 fax 423.878.4224 Email: ktl@kintronic.com www.kintronic.com



Kintronic Labs, Inc.



GET IN THE GAME

For football remotes that deliver every heart pounding, bone crunching moment, choose a codec that outperforms the competition. Only Tieline codec options connect over your choice of POTS, ISDN, GSM and soon IP* with just one simple box. Get instant, rock solid connections, incredible wireless or wired audio quality and get your listeners into the game.

They're even compatible with Comrex¹ POTS codecs.

Order your free demo today.

800-750-7950



Tieline 
www.tieline.com

*Audio over IP and wi-fi software module for all Tieline G3 codecs available late 2005.
Compatible with ¹Comrex Matrix, Blue and Vector Codecs. ¹Comrex and associated trademarks are the property of Comrex Corporation

Responder

► Continued from page 1

Jackie Lett, president of the Mississippi Broadcasters Association, said broadcasters in that state will approach the Department of Homeland Security and the Mississippi state legislature in early 2006 to discuss "first responder" status for stations.

"I believe our broadcasters should have been allowed access to diesel fuel, which was in short supply after Katrina hit," Lett said. "We heard horror stories ... even police commandeering a fuel delivery truck headed to a transmitter site because they needed it elsewhere urgently. Making sure we will be allowed into restricted areas to repair facilities is also a major concern. The goal is to seek assistance to remain on the air."

How to determine which broadcasters would receive diesel fuel and other government support during emergencies could be a complicated matter, said Don Jacks, FEMA public affairs officer.

"My initial thought would be, 'Who gets fuel and who doesn't?'" Jacks said. "Who would decide if it's the top news station in town or a country music station?"

Regardless, Jacks doubts FEMA would attempt to determine such a policy since it is not a regulatory agency. "We can't do that and don't expect to. I would imagine the FCC would be interested," Jacks said.

An FCC spokesman declined to comment specifically on the possibility of future rulemaking to make such changes.

changes are based in part on the recommendations of the Media Security and Reliability Council, an FCC advisory committee and the Partnership for Public Warning, which ceased operations earlier this year. Sources said they expected the FCC's work on the EAS Notice of Proposed Rulemaking to be completed in 2005, but that was prior to the hurricanes.

Schallenberg said it's unclear whether the federal government would want to part with a percentage of its response resources for a major event in order to support broadcasters.

"How do they balance fuel for critical government needs against those of the broadcasters who are important because of the numbers of people they can reach?" Schallenberg said.

Bill Croghan, co-vice chair of the Nevada EAS Committee, said, "I doubt all radio stations should be included" if broadcasters do receive government assistance, although "I would think the LPI and LP2 and any local powerhouse signals would be included."

"Having first responder status assumes that these broadcasters would be useful and not just some boondoggle to get their commercials back on the air. I think you could run the risk of some broadcasters claiming special treatment," he said.

EAS vs. PDAs

Some broadcasters may decline the government's help during an emergency to avoid political and regulatory complications, said Art Botterell, former trustee for PPW.

"There is a natural tendency for broadcasters to keep a distance from government and the matter of journalistic independence. Broadcasters do things to minimize the impact on the bottom line," Botterell said in an e-mail response to a Radio World inquiry.

Peter Ward, former chair of the board of trustees for PPW, said he agrees radio played a crucial communications role in the aftermath of Katrina, but made another point: Some emergency management managers view EAS and radio in general as less important thanks to newer emergency information delivery technologies, such as PDAs and cell phones.

"There are some differences that have to be talked through yet by a lot of parties. Radio certainly is in there when it come to emergency warning. The lack of local communication capability in New Orleans was shocking, really," Ward said.

If radio were to be considered part of the first response team someday, Karole White, Michigan Association of Broadcasters President/CEO, thinks broadcasters would be taken more seriously.

"Maybe then we wouldn't have to push emergency responders so hard to include us. Until lately, broadcasters have been kept on the outside too often," White said. ●

Broadcasters will approach the Department of Homeland Security and the Mississippi legislature in early 2006 to discuss 'first responder' status for stations.

At the NAB Radio Show, FCC Commissioner Jonathon Adelstein said in general about disaster response and communications, "We have to be on the job and allow broadcasters any flexibility they need to respond." (See story, page 6.)

Coincidentally, the FCC's review of proposed changes to EAS rules, released August 2004, continues. Potential

The federal government has provided generators and large fuel tanks to the 34 radio stations that are part of the country's EAS Primary Entry Point network, said Mark Manuelian, president of the Primary Entry Point Advisory Committee.

Hardening stations

The PEP system allows the president to issue an Emergency Alert Notification and address the American public during an emergency. Entercom's WWL(AM) in New Orleans is a PEP station and managed to remain on the air after Katrina.

"There is added focus on emergency information in light of Katrina; and FEMA has asked PEPAC to advise them on the feasibility of hardening key stations in areas at risk for major natural disasters, the intent being to keep those stations operating through the event and for the recovery period," Manuelian said.

The 34 current PEP stations in the country reach approximately 90 percent of the continental United States, plus Hawaii, Alaska and Puerto Rico, said Manuelian, who said that 26 stations are being added to the PEP network over the next year to ensure a larger broadcast coverage area.

"I don't consider broadcasters as first responders in the sense that they respond to the scene of a disaster. Certainly they are part of the critical communications infrastructure," said Van Schallenberg, who served on the now-defunct EAS National Advisory Committee and works in homeland security support for the Oklahoma County Sheriff's Department.

products. Fluke expects the transaction to close during the fourth quarter.

CPB: The CPB board elected Cheryl Halpern and Gay Hart Gaines to one-year terms as chair and vice chair, respectively, of the nine-member board. Halpern's succession to the chair brings an end to the contentious term of her fellow Republican Kenneth Tomlinson.

XM: XM Satellite Radio and Public Radio International are launching the interview program, "Bob Edwards Weekend," for syndication to public radio stations in January.

Produced by XM and distributed by PRI, the two-hour program will feature interviews from "The Bob Edwards Show," which airs weekdays on XM channel XMPR. The program will be available to PRI's 734 affiliate stations. "The Bob Edwards Show" debuted on XM in 2004.

NEWSWATCH

News Roundup

AUCTION DELAYED: The FCC auction of 171 FM construction permits was pushed back to January. The Gulf Coast hurricanes affected the timing. It has been rescheduled to begin Jan. 12, 2006. Upfront payments are due Dec. 2.

ASCAP: The American Society of Composers, Authors and Publishers is waiving music fees owed by customers affected by the Gulf Coast hurricanes. Radio and TV stations did not have to pay music licensing fees for September and October, while bars, stores and restaurants are waived from the fees for September through December. For a list of eligible areas, see www.ascap.com.

FLUKE: Fluke Electronics Corp. agreed to acquire Infrared Solutions, a provider of portable thermography

ALTRONIC RESEARCH INC.
Performance By Design



OUTDOOR DUMMY LOADS
6600 Series

Convection-Cooled Resistor Loads
Designed for Outdoor Applications

Available in 6kW, 12kW & 20kW Power Ratings
Ideal for HD Applications
No AC Power Required

ALTRONIC RESEARCH INC.
P.O. Box 249 Yellville, Arkansas 72687 870-449-4093 Fax: 870-449-6000
E-mail: altronic@mtnhome.com Web Site: <http://www.altronic.com>

"IP-Audio in New York City? Not on my station."

"Buckley Radio decided to move WOR to a new location, leaving behind studios we'd called home for over 50 years.



"My staff and I had spent months carefully planning new facilities, and we were more than halfway through preparations — then, the rug got pulled from under us.

"Quotes to build new studios were astronomical! I had to cut our



equipment budget *in half*. And the huge amount of syndicated, network and local programming WOR produces *demand*ed digital audio routing and consoles.

"I'd heard that the Axia IP-Audio system could give us the high-end features we needed. And they

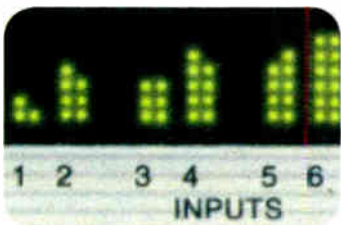

said our budget wasn't a problem; Axia costs less because they use standard Ethernet for audio routing instead of expensive proprietary mainframes.

"Using Ethernet for Audio was certainly new and different, and I

had some concerns. But moving from cart to PC was a big change, too — and for the better. In our industry, change is natural.

"The more I learned about Axia, the more impressed I became with their routing switcher and consoles, and how well their network topology was designed. I began thinking that this Ethernet stuff might just work!



"So I decided to break new ground and order the Axia consoles and routing setup, nine studios worth. It's been on the air half



a year now, and we love it. Our operators keep raving about how easy things are to operate. Even our listeners tell us how good WOR sounds.

"And from the day the Axia surfaces, engines and IP-Audio nodes were hooked up, we've had zero downtime. Zilch. Zip. Nada. Axia works — end of story."



— Thomas R. Ray III, CPBE, Vice President /
Corporate Director of Engineering, Buckley Radio



www.AxiaAudio.com

HD Radio Multicast a Go-Go

Movement Gains Steam; But 'Where Are the Receivers?' Is Top HD-R Question

by Leslie Stimson

PHILADELPHIA Ibiquity is looking internationally for inspiration for upgrades to its HD Radio technology. Meanwhile it's working to put the capability in mobile devices and studying record and replay receiver functions.

More commercial groups are multicasting. NPR, meanwhile, has projects to pave the way for ever-lower bit rate exploration.

Here are digital radio news highlights from the recent NAB Radio Show.

NRSC PASSES IBOC DATA STANDARD

The National Radio Systems Committee approved an amended standard for advanced application services for HD Radio. Placeholder language for this portion of the larger IBOC standard was inserted when the group passed NRSC-5 this spring.

The data standard, NRSC-5-A, includes an advanced data services transport protocol for HD Radio. Services need not be program-related, said DAB Subcommittee Chairman Milford Smith.

"This defines the data pipe," said Smith, noting that a digital transmission scheme is more complicated than an analog one.

If no one appeals the data standard, it becomes part of the NRSC's group of voluntary standards. Then NRSC can consider standards and recommendations regarding advanced data service applications.

The data standard existed in Ibiquity Digital's specifications for its HD Radio system.

NRSC TASK GROUP DISBANDS

The NRSC task group working on how multicast stations should be identified on the display has disbanded. It could not reach

consensus on a numbering scheme other than saying the industry should avoid a scheme involving something other than traditional frequencies, sources said.

station. For example, the first supplemental channel would be labeled with a "2" after either the frequency or calls.

The group's recommendations include:

- Multicast content should be identified by a unique and simple label;
- New content identification should be easy to market;



NPR is using this monitor to map HD-R coverage.

After months of study, the group decided the topic is not a technical issue. It made general recommendations to the NRSC sponsoring organizations, NAB and CEA. The group felt a "suffix" numbering scheme, as is used now, should remain the same. Such a labeling approach links a supplemental channels to the main "heritage"

- Identification of new content locations should not be confusing;
- HD Radio receivers should have a consistent numbering scheme for identifying main and supplemental service;
- Future technology developments should be pursued to enhance the user experience.

Receiver manufacturers, in the meantime, would continue to link supplemental channels visually with main channels, such as WXYZ-HD2, 3 and so on.

COX TO ASK LISTENERS ABOUT IDS

Cox Radio plans to ask listeners how multicast channels should be identified.

The company also has invited radio and CE industry representatives to participate in a consumer research project that Cox will coordinate and fund this fall to help answer the supplemental ID question. Results will be made public, according to a spokesman.

In the NRSC task group on the multicast ID issue, Cox had floated a proposal for a new numbering system to help brand the digital channels as unique, as previously reported by Radio World.

NPR MAPS HD-R COVERAGE ...

Data opportunities were the buzzwords for HD Radio. In a two-hour session devoted to the subject, NPR VP of Engineering and Operations Mike Starling and Ibiquity Digital VP of Advanced Services Joe D'Angelo updated attendees.

For Starling, multicasting is key to gaining listeners. "In 2015, there may be nothing 'main' about your main channel — quite possibly one of your multicasts will become your main source of listenership and revenue."

Starling said a couple of Tomorrow Radio projects include development of digital-only boosters for stations licensed by land grant universities outside population centers. "Many of them didn't have a great analog signal so they need help with a digital signal," he said.

NPR also continues to evaluate low-bit-rate coding progress, refine coverage predictions, evaluate transcoding issues and demonstrate and evaluate emergency radio services.

John Kean, NPR senior technologist, created an HD Radio coverage monitor using a Kenwood radio, Starling said. So far, NPR has mapped coverage for 21 stations.

See DIGITAL, page 17 ▶

Tomorrow Radio Today.

The DaySequerra M4 HD RadioTuner is the first broadcast quality, multicast capable tuner available.

M4 HD RadioTuner



- SYNTHESIZED, PUSHBUTTON TUNING FOR AM AND FM BANDS
- BALANCED AUDIO OUTPUTS AT +4dBV ON 3.5MM EUROSTYLE MODULAR CONNECTORS
- TRANSFORMER ISOLATED AES3 DIGITAL AUDIO OUTPUT - 5.1 SURROUND CAPABLE
- 10 PRESET STATIONS PER AM AND FM BAND
- DEMODULATED AUDIO PROGRAM PEAK AND SIGNAL PRESENT INDICATORS
- HIGH QUALITY HEADPHONE OUTPUT ON FRONT PANEL
- HD RADIO® TO ANALOG PROGRAM TIME-ALIGNMENT MONITOR

Shipping June 2005

DaySequerra
An **ATI** Group Company

154 Cooper Rd. S902 ■ W. Berlin, NJ 08091
856-719-9900
www.daysequerra.com



HD Radio Multicasting

Perfect for program directors with multiple personalities. And for building listenership.



Broadcast Electronics, Inc. • Tel: (217) 224-9600 • Fax: (217) 224-9607 • Web: www.bdcast.com • E-Mail: bdcast@bdcast.com

Sponsored by Broadcast Electronics

Radio World's HD Radio™ Scoreboard

The HD Radio Scoreboard is compiled monthly by Radio World using information supplied by iBiquity Digital Corp. and other sources. The data shown reflect best information as of Sept. 28. This page is sponsored by Broadcast Electronics. HD Radio is a trademark of iBiquity Digital Corp.

HD RADIO AT BEASLEY BROADCAST GROUP

Station	Freq.	Format	Market	On Air	Multicasting
WXTL(FM)	92.5	Country	Philadelphia, PA	Yes	Yes
WRXK(FM)	96.1	Clsc Rock	Ft. Myers-Naples, FL	No	No
KKLZ(FM)	96.3	Clsc Rock	Las Vegas, NV	No	No
WPOW(FM)	96.5	Rhymc/CHR	Miami-Ft. Laud., FL	Yes	Yes
WRDW(FM)	96.5	CHR/Rhymc	Philadelphia, PA	Yes	Yes
WZFX(FM)	99.1	Urban	Fayetteville, NC	No	No
WKXC(FM)	99.5	Country	Augusta, GA	No	No
WKIS(FM)	99.9	Country	Miami-Ft. Laud., FL	Yes	No
KSTJ(FM)	102.7	80s Hits	Las Vegas, NV	Yes	No
WXKB(FM)	103.9	Adult CHR	Ft. Myers-Naples, FL	No	No
KJUL(FM)	104.3	Nostalgia	Las Vegas, NV	No	No
WSFL(FM)	106.5	Clsc Rock	Greenville-New Bern, NC	No	No
WQAM(AM)	560	Sprts/Talk	Miami-Ft. Laud., FL	Yes	No
WGAC(AM)	580	News/Talk	Augusta, GA	No	No
WSBR(AM)	740	Bus News	W. Palm Beach-Boca Raton, FL	Yes	No
WVCN(AM)	770	Sprts/Talk	Ft. Myers-Naples, FL	No	No
WTMR(AM)	800	Christian	Philadelphia, PA	No	No
WAEC(AM)	860	Religion	Atlanta, GA	No	No
WVDB(AM)	860	Bus News	Philadelphia, PA	No	No
WHSR(AM)	980	Internat 1	Miami-Ft. Laud., FL	Yes	No
WNCT(AM)	1070	Sprts/Talk	Greenville-New Bern, NC	No	No
WWWE(AM)	1100	Span/Chrst	Atlanta, GA	No	No
WWNIN(AM)	1470	Motivation1	Miami-Ft. Lauderdale, FL	Yes	No
WRDW(AM)	1630	Sports	Augusta, GA	No	No

The HD Radio Bottom Line
Total Licensed On the Air

934

525

Last Month

Total Licensed

926

On the Air

505

Market Penetration
United States

13,557 AM & FM Stations
(excludes LPFMs)

Number of
FM Stations
Multicasting:



31

■ Licensed by iBiquity and on the air ■ Licensed by iBiquity and not on the air

Overheard at the Radio Show

Selected comments by participants in the NAB Radio Show:

"I came in interested in multicasting," said Steve Callahan, assistant chief engineer of WBUR(FM) Boston.

o'clock" — when the floor closed on the second day — "they had all kinds of people coming down the escalators and heading for the floor."

He called the traffic "significantly better than San Diego," site of the 2004 show. "Overall, on a 1 to 10 scale, I'd give it a 5," he said.



Ernie Belanger, center, explains Armstrong's FM2BVP broadband FM portable antennas, suitable for emergency use, to Fred Morton.

Callahan says the show gave him the opportunity to transform curiosity into practical knowledge that will help his public station begin programming multiple audio streams on its HD Radio signal. "I'm leaving with the attitude that (multicasting) is something all stations will have to consider."

Multicasting was also a hot topic for commercial operator Delmarva Broadcasting, which has stations in Delaware and Maryland. "Six months ago we barely knew what multicasting was," said Charlie Slezak. "Now we're going to multicast as soon as we go HD" at WSTW(FM) in Wilmington, he said.

Show hours caused some confusion for attendees, said Ernie Belanger of Armstrong Transmitters. "Five or ten minutes before 3

Belanger said storms down south prompted interest in Armstrong's emergency transmitter setup, which includes a 1 kW FM transmitter in a flyaway case and an emergency antenna that fits in what looks like a long gun case.

While weather in Philadelphia was warm and sunny, the impending arrival of Hurricane Rita on the Gulf Coast had some vendors and attendees worried. Fred Morton of Houston said he'd changed his return plans four times to steer clear. He planned to fly to Oklahoma City on Friday to meet his wife, who was evacuating from Houston. Morton finally made it home Sunday; Rita caused no damage to his home, or to any of the sites he maintains.

Cam Eicher in the Logitek booth said the company's office in Houston would be closed on

Control Solutions

Model RFC-1/B Remote Facilities Controller

- control transmitter from any telephone
- 8-64 channels of telemetry and control
- programmable control by date and time
- optional printer and modem adapters
- programmable telemetry alarms
- integrated rack panel



Model RAK-1 Intelligent Rack Adapter

- parallel printer interface
- internal modem for data transfer
- front panel status indicators
- battery backed power supply
- rack mountable chassis
- accessory package for RFC-1/B



Sine Systems, inc.

615.228.3500
more information: www.sinesystems.com

Thursday. Smitty was commuting from his home office in central New Jersey. In addition to spending all day at the show, he was staying in the area late into the night to do some tweaking

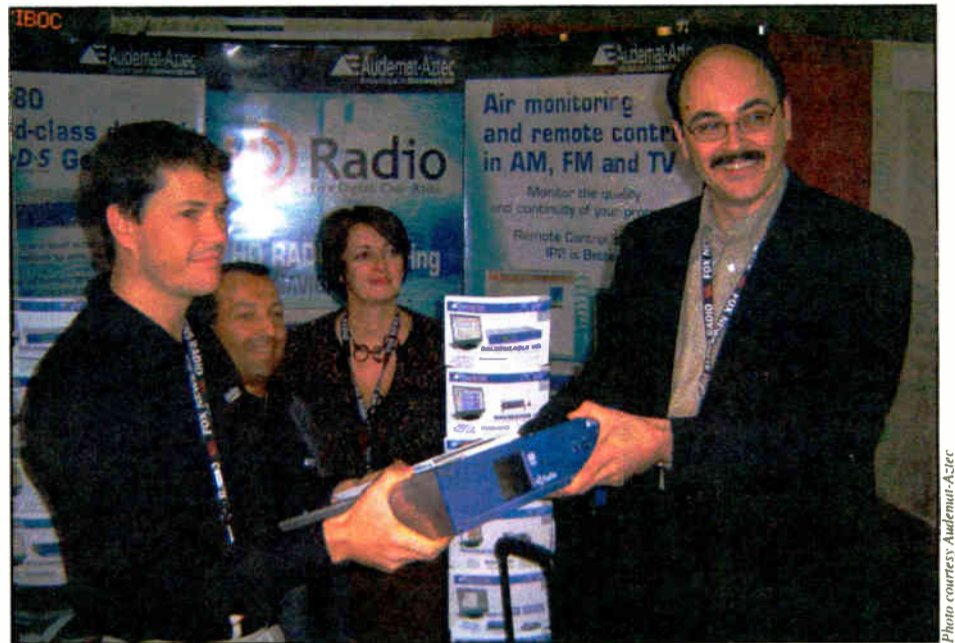

Audemat-Aztec said Ibiquty certified its Goldeneagle HD monitoring unit. Jeff Littlejohn of Clear Channel, right, accepts the ceremonial first unit from Christophe Poulain. Earlier this year the broadcaster ordered 49 FM and 14 AM units and provided engineering design input.



Dave Scott and team were at the show promoting his new company, Radio Traffic.com. From left: Jay Clayton, Candace Clayton, Doug Raines and Dave Scott

the Friday that the storm passed through. For Dave Hultsman of Continental Electronics, the storm's path was of less concern; instead of heading home to Birmingham, Ala., he was leaving for the SBE Chapter 22 show in Syracuse.

Engineers who attended the audio processing workshop were greeted by loud pop music playing over the speakers. An audio guy playing some CDs to test the sound system? Nope; the Maroon 5 and other tunes were actually a recording of AM HD radio as heard over the air from one of Journal Broadcasting's stations, an unbilled surprise by Journal Vice President of Engineering Andy Laird, who conducted the workshop with Omnia's Frank Foti.

The Pennsylvania Convention Center was a popular spot for the show, several engineers said. The \$5.50 train ride from the airport to the Market East train station drew raves. So did the food; in addition to lunch on the floor Thursday and Friday, Reading Terminal Market's warren of stalls was full of people with show badges enjoying cheesesteaks and other delicacies.

The show's location in Philadelphia may have been a little *too* convenient for some.

"I'm not getting much sleep," said Greater Media VP of Engineering Milford Smith on

to the new nighttime transmitter site of Greater Media's WPEN(AM), Philadelphia.

Is there a home-field advantage for the Marconi Radio Awards? Watching the ceremony, managers from Regent Communications' WLHT(FM), Grand Rapids, Mich., weren't holding out much hope of winning AC Station of the Year. They were up against Jerry Lee's WBEB(FM), Philadelphia, which has become legendary as one of the last independently-owned stations in a major market.

Sure enough, the winner was WBEB. But there was no such home-field advantage for several other Philadelphia stations nominated, including rock station WMMR(FM), which lost to Indianapolis' WIBC(AM) as Legendary Station of the Year.

"It's great to see so many old friends gathered again for our annual celebration of radio," said Eddie Fritts in opening remarks. "This is a bitter-sweet moment for me, for this will be my last Radio Show as President & CEO of NAB. I had planned to give an hour-long speech outlining some of radio's accomplishments during my 23 years at NAB, but my buddy John David has only allotted me seven minutes.

"I guess that's what happens when you're a lame duck. We all know that 'Less is More!'"

— by Scott Fybus and Paul McLane

Digital

► Continued from page 14

NPR has made some general observations about HD Radio signal coverage, including:

- Rolling terrain is bad, Non-linear relationship to power; Class Cs will usually cover slightly beyond the 60 dBu contour,
- Many Class As will be lucky to fully cover the 70 dBu contour; and
- In flat terrain, signal reaches beyond the 60 dBu contour.

Starling said these are interim conclusions.

... AND DELAYS RECEIVER PROGRAM

NPR has had to delay its group purchase of multicast receivers for noncom stations because of production delays affecting tabletops — the type of receiver stations would like to use as giveaways.

Starling said an important finding of the organization's multicast receiver group was that "Station managers said uniformly: 'We really don't want any inventory holding risk,' meaning spending several hundred thousand dollars investing in products, and then someone else perhaps could come out with less expensive products and stations might be stuck with inventory."

NPR has been talking to receiver manufacturers Kenwood, Boston Acoustics, Polk and Radiosophy. Of those, only Kenwood had placed multicasting units in the market as of mid-September. Boston Acoustics projected availability in November, with Polk projecting shipments in the first quarter. Radiosophy President/CEO Richard Skeie told Radio World, "We have a large order backlog and expect the whole backlog to be filled in December."

NPR had hoped to ship to stations in time for fall fundraisers; now it hopes to finalize its purchase program by next fall so stations can use tabletops as giveaways.

The network hopes to launch a pilot project in the first quarter, with perhaps a half-dozen to a dozen stations to report back to the system about the chosen receivers next spring, said Starling. The network wants feedback from stations and can't endorse receivers until it can test production units in-house, he said.

Stations in the receiver program must be broadcasting in HD Radio and multicasting and commit to a certain amount of promotion in order to drive customers to the Web sites of the receiver manufacturers. Stations that agree would get what Starling termed an "affiliate bounty," or a return payment. The dollar amounts have not yet been agreed to.

IBIQUITY TWEAKS ENCODING, EYES TIVO-LIKE CAPABILITIES

On the topic of multicasting, D'Angelo said Ibiqity is working on a low-bit-rate encoding scheme that would be compatible with existing encoders.

He addressed receiver activity in coming months, saying BMW will expand the use of HD Radio use beyond the Series 7 to Series 5 and 6 autos next year.

Ibiqity also has added image support to the program-associated data that appears on the faceplate of receivers.

And the company is working to develop a 45-second audio buffer for audio replay and record capabilities "using the capabilities inherent in the chip," he said, likening this to dipping a toe in the water for TiVo capabilities.

Ibiqity is working to place its technology in mobile devices. The key is working to fit within size constraints and miniaturize the radio, D'Angelo said.

Digital Radio Mondiale has developed a USB digital radio receiver that can be used with personal computers, he said; Ibiqity is looking at this idea to see if and how it could be applied in this country.

CPB LOCKS IN GROUP DEAL FOR HD RADIO

Roughly 800 noncommercial stations will accelerate their digital conversion after

an HD Radio licensing agreement reached between CPB and Ibiqity Digital.

Under the agreement, CPB will buy a group license that will allow approximately 400 CPB-funded public stations to acquire Ibiqity's digital HD Radio technology. This license also will cover costs associated with advanced data services such as multicasting and datacasting. Earlier CPB had provided funding to another 400 stations.

The licensing fee for noncoms in this group deal would be \$5,000 per station, the same as commercial group owners that agreed to accelerate their rollout.

CPB must see that at least 100 stations convert per year under the deal; 105 are on the air with digital signals, according to CPB.

Noncoms remain exempt from the data portion of the Ibiqity license fee "as long

as they use it in a noncommercial way," Luis Guardia, senior director of Media Technology for CPB, told Radio World.

CPB AWARDS GRANTS FOR DIGITAL CONVERSIONS

CPB also has awarded \$8.8 million in grants to help 119 more public stations, including 78 serving rural and minority audiences, purchase equipment needed to transition to digital.

This is the fourth round of matching grants to eligible stations.

CPB has distributed grants to 405 public radio and 285 public television stations to begin their digital transitions. These funds are part of \$190 million in funding that Congress has provided to CPB over five years to assist public broadcasters go digital.

See DIGITAL, page 18 ►



"AudioVAULT Version 9.0 is Ready To Go!"

With twenty years of engineering experience between them, Kim and Lori know when software is ready for delivery. Heading up our AudioVAULT test department, they put every aspect of Version 9.0 through the most rigorous evaluation, so you're assured this version of AudioVAULT is as reliable and robust as its predecessors. Among the more than three dozen enhancements are dual network support for redundancy, server failover without program interruption and more flexible station-wide play while recording. And as is always the case with AudioVAULT, your pager is less likely to go off at night—thanks to Kim and Lori.



Broadcast Electronics, Inc. • 4100 North 24th Street, P.O. Box 3606, Quincy, Illinois 62305-3606 U.S.A.

Telephone: (217) 224-9600 • Fax: (217) 224-9607 • E-Mail: bdcast@bdcast.com

Broadcast Electronics and the BE logo are registered trademarks of Broadcast Electronics, Inc.
HD Radio is a registered trademark of Ibiqity Digital Corporation.

Digital

► Continued from page 17

GROUPS TALKING OF DIGITAL 'COALITION'

Big radio groups are referring again to discussions they've had about digital data services and promotion.

Infinity Chairman/CEO Joel Hollander said talks are taking place among executives of his company, Clear Channel, Emmis and Entercom. He said broadcasters likely would reveal a plan in the fall.

Clear Channel Radio President/CEO John Hogan termed the group an alliance, a word echoed by Ibiquity President/CEO Robert Struble in talking to PDs. "There's a

coalition that's coming together, the largest in history."

OEM RECEIVER INTEGRATION, MULTICASTING DISPLAYED

Several HD Radio products and services were display at the Ibiquity booth. Receivers included units from Boston Acoustics, Eclipse, JVC, Kenwood, Panasonic, Polk, Radiosphy, Sanyo and Yamaha.

Live multicast programming courtesy of Beasley's WXTU(FM) aired. WXTU is multicasting XTU-Channel 2, featuring the "next generation" of country artists.

A kiosk featuring a RealTraffic demonstration with SmartRoute systems from Westwood One showed how HD Radio technology can be used to provide

local traffic updates.

More than 500 stations are airing HD Radio, according to the company.

DICE UNVEILS OEM HD RADIO DEVICE

Dice Electronics unveiled what it and Ibiquity say is the first HD Radio integration solution for OEM head units.

Dice says its "HD Dice" makes nearly any head unit HD Radio-compatible by connecting to a black box. Ibiquity displayed the device in its booth. A message on the Dice Web site says "Coming Soon!"

RADIO ONE STATIONS TAKE PART IN 5.1 DEMO

Harris supported its NeuStar product line display with a live 5.1 surround sound

broadcast of two local FM stations.

Radio One produced live 5.1 transmissions of WPPZ and WRNB using a Harris Z Series FM transmitter and NeuStar 5225. The broadcast was received using an antenna attached to roof of the Pennsylvania Convention Center.

HARRIS ADDS KENWOOD PRODUCTS

Harris will offer some Kenwood HD and HD-ready radios for purchase to station engineers for demos and testing both in and outside vehicles.

The supplier is stocking the Kenwood EZ500 and KTC-HR100TR HD Radio and/or HD Radio-ready receivers. Kenwood has made the range of HD Radio/HD Radio-ready receivers, plus amps and speakers suitable for promo vans, available to Harris.

EXECUTIVE TO PROMOTE INTERNATIONAL IBOC

Ibiquity says it has seen increased interest in HD Radio technology from international markets. Asked when another country might adopt HD Radio, President/CEO Robert Struble said "very soon," saying the system's spectrum efficiency is "compelling" for governments.

The company hired Perry Priestley as director of international broadcast business development. He was director of sales for Thales Broadcast and Multimedia, overseeing the Canadian, Caribbean and Latin American markets. He has held positions with Comark Communications, Philips North America and Pye TVT.

BE, IBIQUITY TO TEST HD-R IN SWITZERLAND

Broadcast Electronics and Ibiquity will take part in HD Radio tests in Switzerland. The first broadcasts there should be heard next spring on "88 Radio Sunshine" near Lucerne. Mountainous terrains and 100 kHz frequency spacing of FM stations pose challenges to digital broadcasts there. BE will supply IBOC transmission equipment and technical expertise to begin testing, starting with field-strength measurements of broadcasts on Radio Sunshine's main channel. Subsequent testing could include multicasting supplemental audio channels and synchronous digital broadcasts on some of the station's 12 other boosters and translators, the supplier said.

BUCKLEY ACCELERATES ROLLOUT

Buckley Radio has joined groups indicating corporate support of HD Radio, with a plan to convert most of its stations over three years.

Four Buckley stations are licensed to broadcast with IBOC: KWAV(FM), Monterey, Calif.; WDRG(FM), Hartford, Conn.; WOR(AM), New York; and WSEN(FM), Syracuse, N.Y. WOR was an early Ibiquity test station; the others plan to convert shortly.

The group has 19 radio properties.

BEASLEY DEBUTS 96.5-HD2

Beasley's WRDW(FM) in Philadelphia debuted 96.5-HD2 during the convention. The commercial-free channel showcases new dance music and remixes of top 40 records. Those who have HD Radios with the ability to decode multicast signals can tune to "96.5-HD2"; the station is also streaming the programming. 

Looking for a new Digital Audio System? Why not try the

INNOVATOR

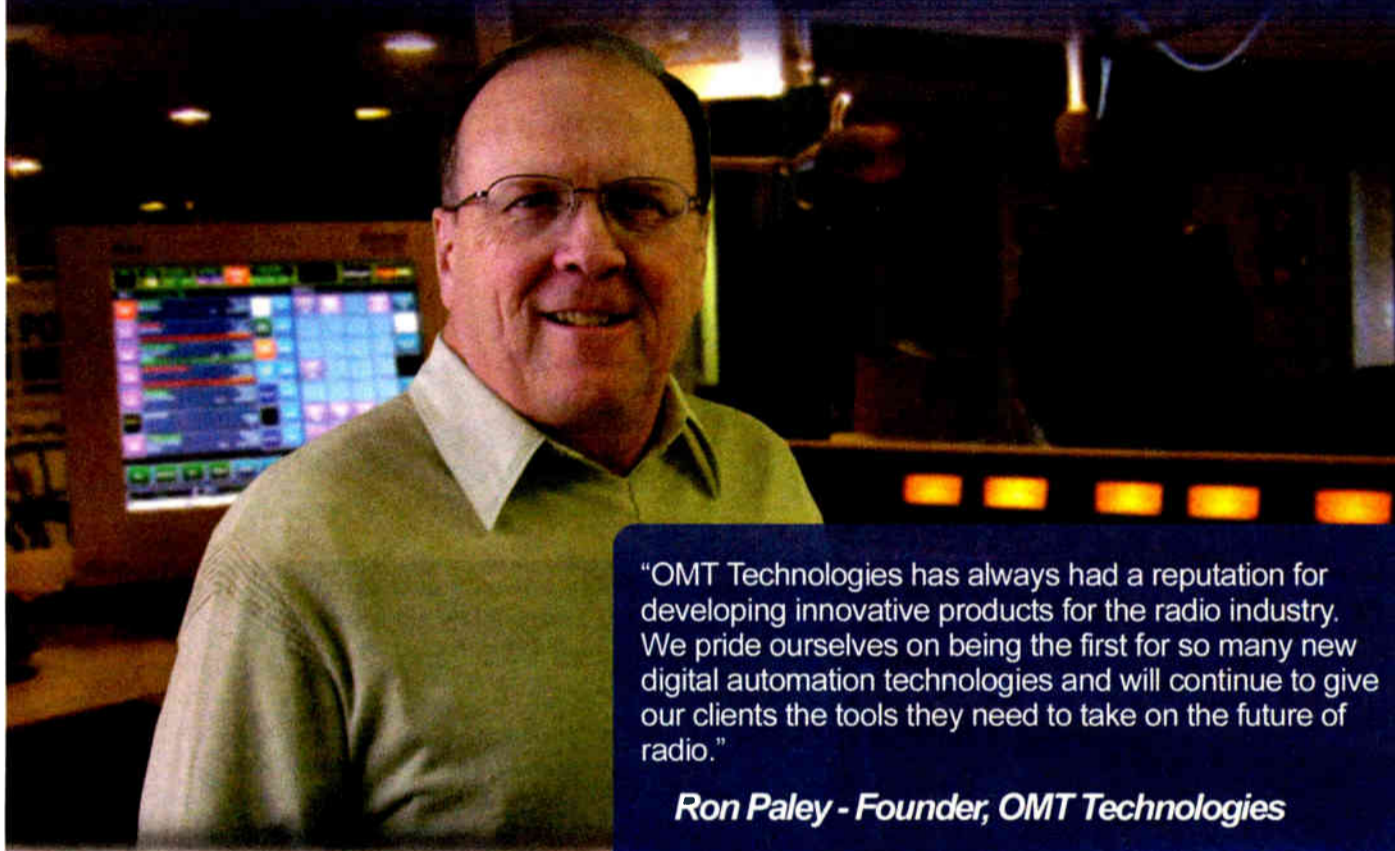

"OMT Technologies has always had a reputation for developing innovative products for the radio industry. We pride ourselves on being the first for so many new digital automation technologies and will continue to give our clients the tools they need to take on the future of radio."

Ron Paley - Founder, OMT Technologies

iMediaTouch features:

- Non-proprietary hardware, use any audio card, any PC
- Supports MP2, MP3, PCM, WMA and Dolby AC3!
- Live Assist, Satellite or Full Automation
- Complete website integration with XML or HTML output
- On-Air Promo builder for on the fly promos
- CD Ripper and complete production tools for automation
- On-Air studio or Production studio Voicetracking
- On-Air Phone bit editor with full production capabilities
- RDS and HD Radio ready!



Broadcast Automation Software

Innovation has been the trademark for OMT since 1984, with an impressive list of industry firsts that have set the stage for the future of broadcast solutions.

From being the only true non-proprietary broadcast automation system, to our #1 selling digital logger and our award winning internet streaming software, our iMedia product lines provide innovative choices for your radio group or station.

Find out why over 1200 radio stations and the top consumer music providers all chose OMT products.



The Original. The Standard. The Innovator.

To find out more, call us Toll Free 888 665 0501 or visit www.imediatouch.com

Together We Have The Power To Move Radio Forward.



At Harris, we're taking our leadership in the radio industry to an even higher level. Shaped by the feedback of customers and audiences across the market spectrum, the newly-formed Harris Radio Team is rich with the industry's most comprehensive products, services and expert resources. All with a focused team solely dedicated to moving our industry, and your business, forward. It's a spirit of innovation built on decades of pioneering solutions for radio. So get your business heading in the right direction, turn to the new leadership of Team Harris Radio.

To learn more about the new Harris Radio Team, call us at **800-622-0022** or visit us at **www.broadcast.harris.com**.

T H E N E W H A R R I S R A D I O T E A M I S O N T H E A I R



AM/FM



AUDIO CONSOLES



DIGITAL RADIO



BROADCAST STUDIO



HIGH POWER AM



SYSTEMS & SERVICE

www.broadcast.harris.com

HARRIS

Workbench

Radio World, October 26, 2005

Past columns are archived at www.rwonline.com/reference-room

Document Your Site Economically

by John Bisset

Last time, we provided a starting point for inspecting the *outside* of the transmitter site. For best results, perform that procedure quarterly, if not monthly.

Now let's move inside. What follows is a basic list that an entry-level technician can use. Whether you're at the site for a routine inspection or to troubleshoot an emergency, this advice will serve you well.

Once inside, before touching or adjusting any equipment, check the readings and log all test meters for your

critical equipment, including the transmitter, STL receivers, ISDN program delivery equipment and audio processing. The object is to create a baseline of indications, taken when equipment is operating normally. In the event of a failure, this baseline will guide you as to what to check first.

If you are at the site because of an equipment failure, log all readings before touching anything. But also use your eyes, ears, sense of touch and smell to inspect.

Do you detect a burning smell? Do you hear relays chattering or a blower motor bearing whining? As you touch the

rigid transmission line, is it hot? Warm is OK, but if the line is hot to the touch, this can indicate an internal failure.

In a transmitter with pilot lights or LEDs to indicate operation, keep a note as to which are illuminated during nor-

mal operation. Mark Voris works with Vern Killion, the engineering manager at KRVN in Lincoln, Neb. Mark writes that for many years, all the wiring and equip-

ment diagrams were put on paper and kept in binders for KRVN. Mark has taken a different approach. With the use of a computer and Windows Paintbrush, he has created documentation for the station.

Mark concedes that other engineers who have gone the way of the computer used CAD programs, but Mark finds Windows Paintbrush more economical.

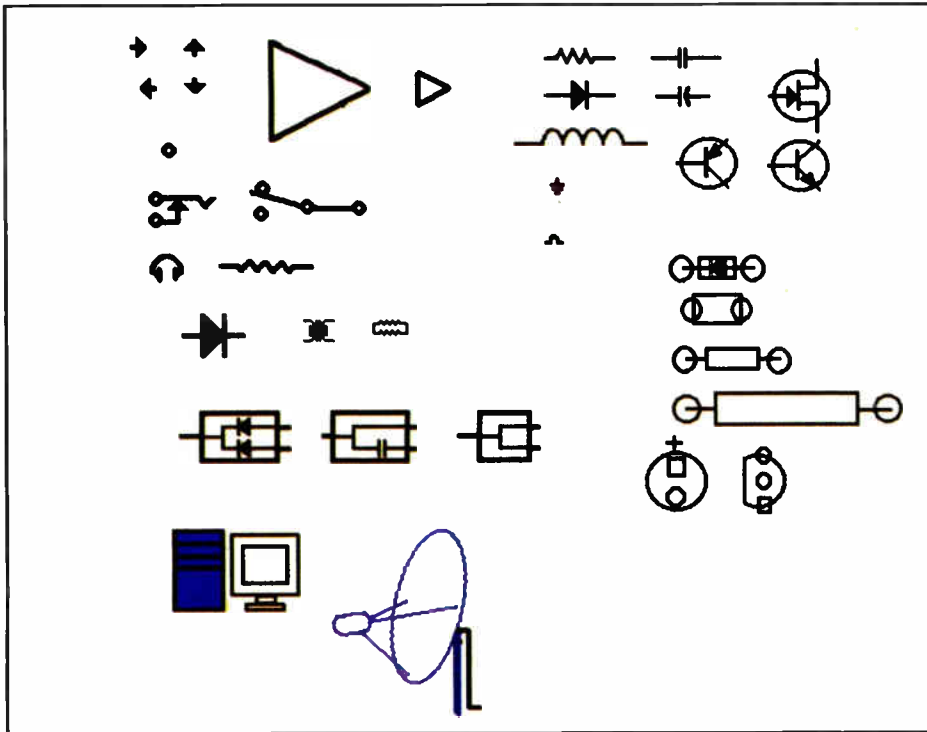

Fig. 1: You can create common symbols to speed documentation.

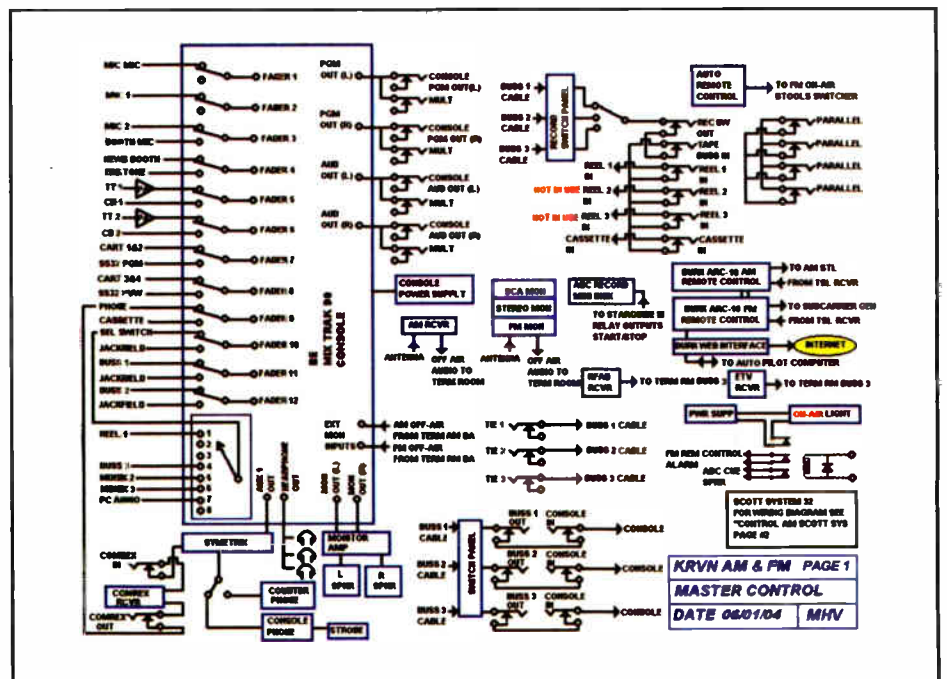

Fig. 2: An easy-to-follow master control drawing.

mal operation. This will help you determine, at a glance, if something is wrong. Also check your circuit breakers.

With a senior engineer's help, develop a flowchart block diagram for each transmitter site. This will help diagnose failures, as you determine where the signal is flowing and where it is not.

Mark Voris works with Vern Killion, the engineering manager at KRVN in Lincoln, Neb. Mark writes that for many years, all the wiring and equip-

He starts his documentation package by creating a SYMBOLES file that has most of the electronic and other symbols that will be used in the drawings. An example is shown in Fig. 1.

Once this file is created, Mark creates a TEMPLATE file with the title and date of the drawing listed in the corner. This is also where you will want to play with attributes and page settings for printing your finished drawing later.

See WORKBENCH, page 22 ▶

Simple or Interactive RDS - your choice!

Inovonics offers three ways to hop aboard the RDS bandwagon

Our 702 "Mini Encoder" gives you a big RDS presence with minimum investment. Display your call or 'street name,' or even scroll your ID/promo message across the radio faceplate. Send all the important RDS housekeeping info, plus independent RadioText messaging for phone numbers or ads. The 702 features a Windows® interface and easy USB connectivity.

Model 702 - \$420



The 712 and 713 are full-featured encoders that connect with station automation to scroll song and artist info, weather, promos and ads on RDS radio faceplates. Both units feature our unique safe-scrolling mode, and the 713 has full TCP/IP network connectivity. In addition to dynamic, 'scrolling PS,' an independent RadioText register simultaneously sends fixed messages, such as station slogans, ads and contest numbers.

Model 712 - \$1250

Model 713 - \$1690



Download full spec sheets at www.inovon.com

Inovonics
1305 Fair Ave. • Santa Cruz, CA 95060
TEL: (831) 458-0552 • FAX: (831) 458-0554
www.inovon.com • e-mail: info@inovon.com

MULTICHANNEL AUDIO PRODUCTION FOR HD RADIO



***What You Need
To Know About Radio's
Surround Future***

A Special Technology Report

Surround Them with HD Radio—Right Now

Broadcast with Dolby® Pro Logic® II on HD Radio™ and take advantage of the more than 30 million Pro Logic II decoders already in use. Using Dolby Pro Logic II is easy, requiring no major changes to your station's infrastructure.

Your listeners already know the Dolby name means quality sound. They associate it with the compelling surround sound they enjoy at the movies and in their home theaters. Now, with Dolby Pro Logic II, you can deliver that same surround sound experience to your radio audience.

Dolby delivers surround for HD Radio.



Dolby Laboratories, Inc.
100 Potrero Avenue, San Francisco, CA 94103-4813 USA
Telephone 415-558-0200 Fax 415-863-1373
Aston Bassett, Wiltshire SN4-8QJ England
Telephone (44) 1793-842100 Fax (44) 1793-842101

www.dolby.com

Dolby, ProLogic, and the double-D symbol are registered trademarks of Dolby Laboratories. HD Radio is a trademark of iBiquity Digital Corporation. © 2005 Dolby Laboratories, Inc. All rights reserved. 505/16703



Multichannel Comes to Radio — Almost

HD Radio Seems Surround-Ready, But a Few More Things Will Have to Happen First

by Skip Pizzi

First there was AM, then FM, then FM stereo, then AM stereo ... oops.

Well, things were going OK there for a while, but the state-of-the-art for radio's audio has been more or less stuck in stereo since the 1960s. In the meantime, TV audio has moved steadily from mono to stereo to matrix surround to digital 5.1 audio at a relatively rapid pace.

Now as HD Radio takes to the air, an opportunity arises for radio broadcasting to achieve escape velocity from the technological orbit where its audio format has stalled for nearly half a century. But it's not quite there. A num-

ber of issues remain to be worked out, not the least of which is whether the market demand really exists for multichannel sound on the radio. The real answer will only be determined by trial, while the resolution to other open issues will affect eventual optimum implementation. But just how the latter points are resolved may be pivotal to the ultimate market success of radio surround sound.

Importantly, while this consideration of improving audio quality on digital radio occurs, parallel developments are underway on increasing the quantity of services there with HD Radio multicasting. The future of radio broadcasting will likely involve both types of advances, but the details of their interaction also represent a current issue for broadcasters' serious consideration.

The technology

These are critical and complex questions that require careful, individual examination, and then a holistic analysis. Toward that end, the specific topic at hand in this publication is surround sound broadcasting, so let's define that problem space, and consider some of the proposed solutions.

Multichannel sound is nothing really new. It attempts to add another dimension to the soundfield of a reproduced audio signal. In audio's earliest times, monaural sound defined a single point source. Stereo added a second point source, thereby defining a line (from left to right, a single dimension). Most multichannel systems ("surround formats") add a second dimension (Front to Back), thereby creating a sound plane. Some advanced multichannel systems also involve a height dimension, for a "3D" soundfield.

At least that's the way you would describe the systems in purely geometric terms. But audio recordists have long known that even a mono signal can offer some perception of dimensionality based on the "depth" of the recording. Some things seem closer than others. Stereo enhanced the spaciousness of the audio signal, either by literal localization of different sound elements along various points of the Left-Right line, or by adding a lateral enhancement to the "depth" or "space" of the mix. This allows stereo to define a virtual soundfield that can seem to extend beyond the line defined by the placement of the two speakers.

Multichannel sound — which really is a

catchall term for any system with more than two channels — does the same with a second dimension, adding even more literal and perceptual spaciousness to the aural presentation. This can create a sense of real immersion in the soundfield to the centrally placed listener, and/or cause sounds to be convincingly localized at any point around the listening position.

As in contemporary stereo mixing, most audio elements in surround mixing are not discretely assigned to individual channel outputs, but are typically panned across several channels. This multiplicity (or redundancy) of output allows multichannel digital audio coding systems to add efficiency, and therefore not require a linear scaling-up of data rate proportional to the number of channels added.

Thus, for example, a 5.1-channel digital audio coding system can achieve approximately the same audio quality at 384 kilobits per second or less as can a stereo signal at 256 kbps or less. This process is sometimes referred to as joint coding, and can apply to any audio format where multiple channels share some elements of content.

The ultimate extension of this approach separates the imaging (or "steering") information entirely from the audio data in a multichannel digital coding system. Just such a parametric coding methodology is progressing through

continued

About This Supplement

Is U.S. radio ready for surround? In this 16-page supplement to Radio World newspaper and Pro Audio Review, authors Skip Pizzi and Mike Pappas discuss how this question affects studio planning for radio stations and production facilities. Skip Pizzi is contributing editor of Radio World. He co-chairs the NRSC Surround Sound Audio Task Group with Steve Fluker of Cox Broadcasting.

Mike Pappas is chief engineer of KUVU(FM) in Denver, the first FM HD Radio station on the air in Colorado and the first station to broadcast 5.1 surround on HD Radio. He serves on the National Radio Systems Committee.

Cover: Surround Mixing Studio at Thirteen/WNET in New York. Photo by Robert Wolsch Designs

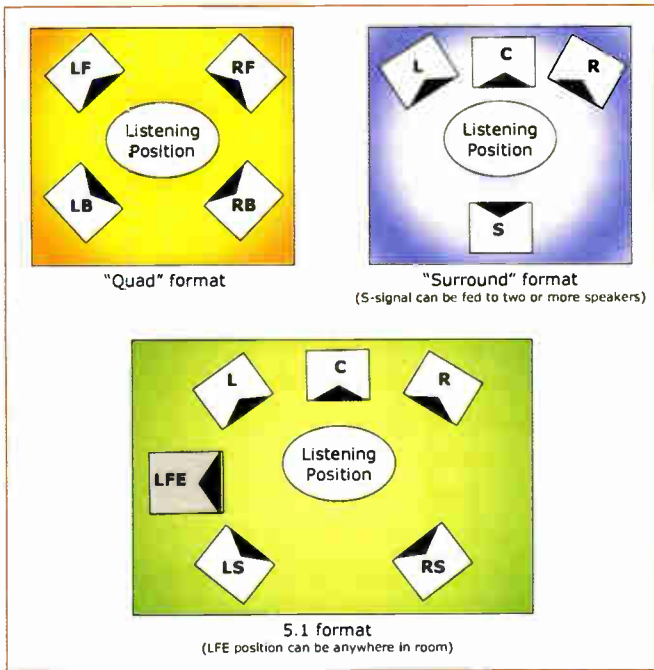

Fig. 1: Comparison of speaker placement for 'quad,' original matrix surround, and 5.1 formats.

Dolby Pro Logic II

HD Radio offers an opportunity for enhanced audio quality with surround sound to add excitement to the listening experience. However, for surround sound to be practical, it must be easy for everyone.

Broadcasters need a system that works within their existing environment, and consumers need a system that doesn't add much cost. Dolby Pro Logic II is such a system. Already proven with over 30 million decoders in place, the signal is stored, edited and transmitted just as stereo is today, so major changes in the station infrastructure are not necessary.

It's a surround sound system that makes sense.

Contact the company at www.dolby.com or (415) 558-0200 in California.



AudioScience Surround Sound eXtensions

The surround sound extensions (SSX) added to the ASI5000 series of audio adapters give them the ability to play and record multichannel streams with up to eight channels of audio.

Playback functionality allows two multichannel streams to be mixed with the multichannel audio input to one audio output. Both analog and AES/EBU I/O are supported.

Developers can use the same mixer model and Microsoft-compatible APIs as other AudioScience products operating in stereo mode. SSX is available in driver v2.90 and later under both Windows and Linux.

Contact the company at www.audioscience.com or call (949) 650-6263 in Delaware.



Product information is provided by suppliers.

Surround

continued

the MPEG standardization process, where it is now referred to as MPEG Surround. (Previously the terms "Spatial Coding" or "Parametric Surround" had been used.) Theoretically, this format can be appended to any audio codec, allowing a mono or stereo coding algorithm to be enhanced with backward-compatible 5.1-channel capability through the addition of a relatively low bit-rate data channel. (Although it was initially thought that spatial coding data would require around 16 kbps for adequate performance, recent MPEG tests have shown that this can be reduced to as low as ~5 kbps without objectionable artifacts.) Currently at "Reference Model 0" status, the format will likely emerge as a new part of the MPEG-4 suite of standards sometime next year.

A recent update includes what MPEG calls a "blind upmix" option in the decoder, which would allow a receiver to utilize the image construction capabilities of the decoder to create its own pseudo-surround image in the absence (or temporary loss) of a steering data signal.

Quad, Surround and 5.1

"Surround" is often used as a synonym for the general term of multichannel sound, but it can also specifically refer to some early multichannel systems that used four reproduction channels. In their first commercial implementations, these four channels were intended to simply "double up" the stereo approach, with speaker placement therefore in two pairs, placed in the four corners of the listening space (LF, RF, LB, RB — note the term "Back" is generally used instead of "Rear" to avoid confusion of acronyms; see Fig. 1). The format was then called "quadraphonic" sound.

The simplest of these approaches used a passive polarity reversal matrix between a stereo amplifier and four speakers. Originally developed by Dynaco as the Dynaquad system, this approach is now referred to generically as an ambience recovery system.

Soon thereafter an encode/decode approach was developed, based on fundamental technology of Peter Scheiber. These systems are generally called "matrix (or matrixed) surround" systems, referencing the Scheiber Matrix of which they are all variants. That encoding process takes the four channels of the original mix and via a quadrature phase matrix, mixes the back channels with the front channels in a way that a complementary matrix decoder can

subsequently extract the four-channel mix again with reasonable fidelity. Hence the label "+2-2" is also applied to such systems in some cases.

Of course, the quad approach, introduced in the 1970s, was not a market success, but the +2-2 matrix was repurposed by the film industry, and later by television, into a format that applied well to sound-for-picture. Instead of a four-corner arrangement, three speakers were placed in a line across the front of the listening space (left, center and right), with the fourth channel used for ambient or "surround" effects, often reproduced through several distributed speakers around the sides and back of the room. This initially was developed for cinematic presentation by Dolby Labs (with its already market-leading noise reduction added) under the name Dolby Stereo.

Because the center channel was always placed close (or in projection systems, behind) the film or video screen, it allowed the audio sent to that speaker to be localized to the screen regardless of the listener's position. This is useful for dialog sound, which almost always needs to be associated with the person speaking on camera. (Dialog sound from an on-screen talker that seems to originate from any other location away from the screen can be disorienting to the audience.) Thus matrix surround became an L-C-R-S format.

The state of the art for radio's audio has been more or less stuck in stereo since the 1960s.

By the late 1970s it had become standard practice to encode the standard stereo soundtrack of films with matrix surround. This implied that as consumer videotape formats also migrated to Hi-Fi stereo audio, rented and purchased movies on Beta and VHS carried surround soundtracks, fueling the home theater movement. Again, the Dolby brand dominated, and a consumer version of their system was developed, called Dolby Surround. (Dolby Stereo used Dolby-A noise reduction on all channels, while Dolby Surround added Dolby-B and an HF rolloff to the S channel only.) In the 1980s Dolby enhanced the consumer system's performance significantly with its ProLogic system — not a surround format, per se, but just a better implementation of the Surround decoder, so existing content remained fully compatible.

continued



WorldNet Oslo makes your STL the strongest link in your digital audio air chain.

MAKE YOUR THE STRONGEST LINK

Introducing WorldNet Oslo from APT. Now you can have up to eight full bandwidth audio channels with low delay, cascade-resilient, Enhanced apt-X™ coding.

Each WorldNet Oslo gives you a choice of Encoder, Decoder and Duplex Audio Modules, AC and DC redundant power supplies, a flexible auxiliary data system and automatic backup. WorldNet Oslo supports 16, 20 or 24-bit Enhanced apt-X™ audio, delivering lossless audio quality with under 2ms delay.

WorldNet Oslo comes complete with an easy to use IP-based Management System so you can set up, configure and monitor your installation across town or across the globe. To see just how useful this user interface can be, download a demonstration version from www.aptx.com.

Contact us to find out what WorldNet Oslo can do for your air chain or request a demo.



Highly intuitive user-friendly interface with VU meters and programmable fault monitoring all via IP

Features & Benefits

- Multiple Channel Audio Codec
- Designed for your STL and Studio-to-Studio Links
- Redundant Power Supplies
- Modular Architecture
- Audio over E1, T1 or Ethernet
- Up to 4 audio channels per audio card
- Up to 6 audio cards per chassis
- Analog and AES/EBU audio interfaces
- Enhanced apt-X™ coding

APT
AUDIO PROCESSING
TECHNOLOGY

Audio Processing Technology Ltd
Tel: +44 28 9037 1110
Fax: +44 28 9037 1137

Audio Processing Technology North America
Toll-free: 800-955-APT-X
Fax: 732-796-0304

Audio Processing Technology Japan
Tel: +81 (0) 3 5771 1191
Fax: +81 (0) 3 5771 1192

Email: info@aptx.com
Web: www.aptx.com

APT WorldNet Oslo

The WorldNet Oslo from APT is the perfect solution for 5.1 contribution and distribution applications, transporting high-quality content over an E1, T1 or IP link.

A modular, multi-channel codec system, the WorldNet Oslo boasts a unique feature set incorporating Enhanced apt-XTM coding to deliver real-time, near lossless quality audio. On a typical configuration, 6x15k stereo duplex programs can be delivered over 1 x E1 or T1 circuit.

With a variety of available interfaces, built-in redundancy and modular architecture, the WorldNet Oslo will fit into a wide range of broadcast applications today and provides scalability and reliability for those seeking a future-proof solution.

Contact the company at www.aptx.com or (800) 955-APTX in New Jersey.

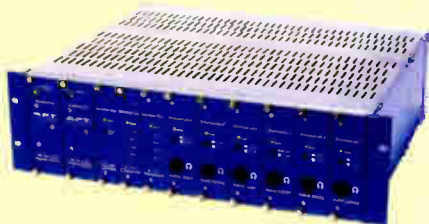

Harris UltraLink Digital Radio Audio Conditioner

The Harris UltraLink Digital Radio Audio Conditioner pre-conditions audio content prior to lossy compression to minimize artifacts and increase bit-rate efficiency.

UltraLink uses Neural Audio's advanced algorithms to prevent unwanted artifacts that compromise audio quality and bandwidth efficiency, and works across multiple digital radio standards including HD Radio. Neural's image packing and irrelevancy reduction technologies enable the codec to operate at maximum efficiency and provide improved audio quality at the receiver.

The bit-rate savings in the digital audio stream frees bandwidth for such vital new services as data transmission, supplemental audio and other programming opportunities enabled by digital technology. As a result, UltraLink is a key enabling technology for multichannel delivery. It is capable of achieving superior quality secondary and third channel audio beyond the main HD Radio channel.

Contact the company at www.broadcast.harris.com or (513) 459-3400 in Ohio.



Product information is provided by suppliers.

Surround *continued*

Meanwhile, theatrical sound also had a high-end format called six-track magnetic, which added a second surround channel (creating lateral imaging in the surround field via separate left and right rear signals) plus a "boom" channel, used for a separate low-frequency effects (LFE) feed to the subwoofers installed in some theaters. Because this sixth channel did not extend over the full audio bandwidth (20 Hz to 20 kHz), but only occupied about one-tenth of it (20-200 Hz), the six-channel approach was renamed "5.1," using a L, C, RF, LB, RB, LFE arrangement. This imaging approach was then used as the basis for the subsequent development of digital multichan-

examining the proposed technologies and considering the issues that surround broadcasting brings to bear for radio stations and receiver manufacturers. This group is in discussion with all the iBiquity-approved systems and various representatives of the MPEG Surround format.

Regarding the other decision-makers, the FCC has made no indication to date of its intention to rule on surround broadcasting for digital radio; and if left to the marketplace, the consumer would literally be surrounded by other options, including DTS, MLP, DSD, DTS-ES, Logic7, Centerpoint, THX-EX, WMA Pro, RA 10 and Ambisonics, along with numerous other proprietary single-ended ("pseudo-sur-

Format Type	Description	Proponents/System
Composite	LCRS or 5.1-channel surround content encoded into 2.0 audio	<ul style="list-style-type: none"> Dolby Labs/ProLogic II SRS Labs/Circle Surround Neural Audio /Neural Surround
Component	5.1-channel (or other channel scheme) steering data transmitted on separate data stream from 2.0 or 1.0 audio signal	<ul style="list-style-type: none"> ISO-MPEG/MPEG Surround (Primary technology contributed by Philips, Coding Technologies, Fraunhofer IIS and Agere Systems)
Single-ended	No broadcast surround encoding; receiver derives LCRS or 5.1 signal from 2.0 audio ("pseudo-surround" or "blind upmix")	Numerous, including all of the above

Table 1: Proposed Surround Format Categories For Digital Radio

nel audio systems, and remains the preferred format today, as implemented in the Dolby Digital, DTS, SDDS and other systems. (Some digital surround systems support 6.1 or 7.1 channel audio, which add more surround channels, intended for use along the rear or side walls of the listening area to further improve imaging.)

Surround in HD Radio

There is a considerable amount of discussion on if and how surround will be implemented in HD Radio. The first question is who, if anyone, will even decide these questions: HD Radio developer iBiquity Digital Corp.; the National Radio Systems Committee; the FCC; or the dreaded "marketplace"?

So far, iBiquity is taking a neutral stance, accepting proposed formats for testing and approval for acceptability of use within the HD Radio system. As of August, iBiquity had approved Dolby ProLogicII, Neural Audio Surround and SRS Circle Surround. It has also proposed a surround system identifier field for inclusion in the HD Radio system's metadata, to allow a receiver to detect which surround encoding format is in use on an HD Radio broadcast service, if any.

Meanwhile, the NRSC has established a Surround Sound Audio Task Group, which is

round") systems.

The options under consideration by the industry for HD Radio can be summarized into three different technical approaches, as shown in Table 1. The biggest difference for HD Radio transmission is whether a "composite" or a "component" approach is used. Composite systems — traditionally referred to as "matrix" systems — incorporate their surround encoding into the audio signal prior to broadcast, so all that is required for compatibility with HD Radio is that the audio and surround encoding pass through the system without difficulty. (This is what iBiquity has verified for the three formats noted earlier.)

On the other hand, the only component approach proposed to date (MPEG Surround) requires separate audio and steering data channels. In the HD Radio system MPEG Surround would use the HDC audio codec for the stereo audio signal, while surround steering data would be transmitted as a synchronized data-cast signal. It is assumed that when MPEG Surround prototype hardware is available later in 2005 that it will be submitted to iBiquity for approval of its use in HD Radio. In this case, rather than simple pass-through compatibility testing, a standardized method of routing and identifying the spatial coding data in the

continued

SURROUND SOUND IS THE FUTURE



Surround Sound is the future of HD broadcasting. Stay ahead of the curve with AudioScience, the first to offer surround sound capability for broadcast-quality audio adapters. Our new **SSX™** extensions for our 5000 series cards let you play, record and mix streams with up to 8 channels of audio, using our existing mixer model and Microsoft-compatible APIs. And like all AudioScience cards, the 5000 series is Built for Broadcast.™ Now you can deliver the ultimate in digital audio to an eager market. Call us at +1-302-324-5333 or go to www.audioscience.com.



Surround
Sound
Extensions

AUDIOSCIENCE
Sound Engineering
Sonic Excellence

Day Sequerra M2 HD Radio Modulation Monitor & M4 HD Radio Tuner

Day Sequerra, a premier manufacturer of broadcast receivers, has delivered its first HD Radio Modulation Monitor to Clear Channel Radio in the metropolitan New York market. Clear Channel received the first M4 Modulation Monitors for stations WALK, WAXQ, WHTZ, WKTU, WLTW and WWPR.

The M4 HD Radio Tuner, shown, is the first "Tomorrow Radio Ready" broadcast-quality modulation monitor available with built-in multicast capability. The M4 has been designed as the benchmark in sensitivity and reliability, and at the same time, delivers the highest quality, accurate monitoring of existing analog and HD Radio AM and FM broadcast signals.



Features include synthesized, pushbutton tuning for AM and FM bands; decoding of "Tomorrow Radio" multicast SPS broadcasts; balanced analog and AES3 digital audio outputs; 5.1 surround capability; HD Radio to analog program time-alignment monitor; and display of MPS and SPS program-specific data.

Contact the company at www.daysequerra.com or (856) 719-9900 in New Jersey.

Linear Acoustic AEROMAX-HDFM Multichannel Radio Processor

Innovative AEROMAX-HDFM incorporates programmable audio processing for a station's main FM and HD/Digital Radio signal paths, in addition to providing separate multiband processing for up to two supplementary audio channels. The unit also provides 5.1-channel surround-sound encoding via built-in SRS Labs Circle Surround technology.

Working closely with SRS Labs, Linear Acoustic has integrated into AEROMAX-HDFM the advanced



Circle Surround 5.1 Channel encoder that converts surround sound audio — produced, for example, by DVD-A or SACD discs, or live sources — into a compatible two-channel signal that can be broadcast over HD Radio and even FM.

Stations can now deliver 5.1-channel surround content that can be decoded by a large number of currently available surround decoders, including Circle Surround, Dolby Pro Logic, Dolby PLII, DTS Neo 6 and Harman Logic 7.

Contact the company at www.linearacoustic.com or (212) 315-9551 in New York.

Product information is provided by suppliers.

Surround

continued

HD Radio system will need to be developed.

The industry debate on the best approach has at times reached a fever pitch, with composite system proponents — Dolby, SRS and Neural — touting their systems' ease of implementation for broadcasters and 'good enough' performance, while the still-developing component camp, supported to date in the United States mainly by Telos/Omnia/Axia, cites MPEG Surround's technical superiority and proposes practical methods for broadcasters' migration to the infrastructure it requires.

Another key issue to be considered is if and how surround and multicasting might coexist in HD Radio. The main point here is how low can you go with surround — that is, what is the practical minimum audio coding bit rate of the HDC codec that can be used for adequate surround performance? If such performance cannot be achieved at 64 kbps or less, it is unlikely that surround and multicast can simultaneously coexist on HD Radio services. This may be a major stumbling block to HD surround's deployment, since many broadcasters today would pick multicasting over surround if forced to choose.

This consideration may also vary across different surround formats, and because it is such a key parameter in the decision matrix, it could have strong weight on any future surround format decisions.

Other elements affecting such decisions include, of course, the relative subjective performance of the different approaches, and the likely market success of the format used. Regarding audio quality, several rounds of comparative and validly structured subjective audio tests are expected in upcoming months by various organizations, including NPR and AES. In terms of market success, a wide range of possibilities exists. Consider that some of the formats being considered are quite broadly deployed (although not in radio products per se), while others have not yet seen even their first commercial receiver implementations. Thus time-to-market and achievement of critical mass could vary significantly among systems.

Studio considerations

There are several other key questions that remain unsettled but which will have strong impact on radio broadcasters' migration to the land of surround. The first applies to the question of digital vs. analog broadcasting for FM stations, to wit:

Because matrix surround encoding can be applied and retained on stereo audio signals, it is possible that a station's main program service audio could incorporate surround encoding that is then broadcast over both its analog and digital services. This implies that surround encoding could be applied to program audio in a real-time process at the studio, or even pre-encoded onto stored content.

This approach would certainly simplify things for stations, allowing them offer surround content to properly equipped receivers, while still producing and transporting a single program stream fed to both analog and digital exciters at the transmitter site — as the basic HD Radio approach has traditionally envisioned. Stereo-only receivers would receive the compatible LT/RT stereo signal in both analog and digital modes, and analog FM receivers equipped with surround decoding (such as in the home theater environment)

Several questions remain unsettled but will have strong impact on radio's migration to the land of surround.

would enjoy surround-encoded content.

There are a few potential problems with this approach, however. First, FCC rules state that the IBOC MPS content shall be the same as the analog FM content. While it is assumed that this does not necessarily apply to audio processing of the content, it is unclear whether surround encoding would be considered "audio processing."

More substantively, however, concerns have been raised that matrix surround encoding will necessarily increase the FM analog L-R subcarrier's average modulation level, thereby increasing the audible impact of multipath to all listeners. Further, just as multipath can wreak havoc with the analog stereo image and audio quality, it could cause some even nastier effects on analog surround reception. Finally, how would the analog FM receiver's blend circuitry (used to ameliorate such multipath problems for stereo) subjectively affect surround listening?

A related question is what impact the analog FM audio processing might have here. (The question of how broadcast audio processing would be optimally implemented for radio surround broadcasting in general is an important subsidiary discussion in itself.)

Anecdotal reports have led some to believe

continued



(Egg-salad)



(Egg-cellent...!)



Surround. Simple.

H OLOPHONE®
Surround Sound Microphone Systems
www.holophone.com 416.362.7790

Visit us at
AES
New York 2005
Booth #654

Pulsecom PCAU

Supported by the world's largest telecommunication providers, over 3,000 Pulsecom PCAUs have been deployed in the past 24 months.

Why? Because the PCAU offers extraordinary audio quality, nondestructive apt-X™ technology, the security of 24-hour telco network support, long-reach "link everywhere" capability — and it's often the least expensive solution. Use Pulsecom's "PCAU Concierge Service" to locate the Broadcast service group at your telco by calling (800) 381-1997.

Pulsecom (a subsidiary of Hubbell Inc., NYSE: HUBA, HUBB) supplies a full range of communications solutions. Founded in 1963, Pulsecom is an ISO 9001:2000 firm with an installed base of over 9,000,000 voice and data circuits.

Contact the company at www.pulse.com or call (800) 381-1997.



Holophone H2-PRO Surround Microphone

The Holophone H2-PRO is a new, patented audio capture device capable of recording up to 7.1 channels of high-quality and discrete surround sound.

The H2-PRO features eight DPA Model 4060 mics, which terminate in eight XLR cables. It is compatible with all recording consoles, multichannel preamps and portable hard-disk location recorders that provide phantom power.

The H2-PRO is the only tool specifically designed to capture ultrarealistic, discrete surround sound in real time with no processing. It's ideal for all surround sound recording and broadcast applications — concert halls, music, sports, field recording, standard TV, DTV, HDTV, radio, web-casting, etc.



The H2-PRO is compatible with all consumer multi-channel audio formats.

Contact the company at www.holophone.com or (416) 362-7790 in Toronto.

Product information is provided by suppliers.

Surround

continued

that multipath effects are the reason matrix surround has never been implemented on analog FM stereo, even though this could have happened years ago. (Interestingly, some car audio systems that include pseudo-surround effects disable the feature in the FM mode, using it only for local audio playback.)

NPR is testing the surround multipath issue, and the results of these tests will help the industry determine whether matrix surround encoding could be included in analog FM. If these tests indicate significant problems with that approach, the addition of surround encoding will have to be limited to the digital signal, regardless of the surround format used.

Should that be the case, it implies that one of several more complex audio routing and encoding options will be required for any implementation of surround encoding in radio broadcasting.

5.1 + 2.0 = 8

The ideal approach in this case would involve an environment that stored and routed separate stereo and surround forms of all content throughout the studios, and fed separate 5.1 and 2.0 program signals to the transmitter site. The 2.0 feed would be sent to the analog exciter's audio input, while the 5.1 signal is sent to the MTS input of the digital exciter.

A simplified approach would send a single signal to the transmitter site, but an upmix/downmix device there would route 2.0 audio to the analog transmission path and 5.1 to the digital. The audio signal fed to the transmitter site could come from the studio as either 2.0 or 5.1, or an alternating combination of both, with the up/downmixer either automatically downmixing a stereo signal from the 5.1 audio, or creating a pseudo-surround signal from the 2.0 content.

Again, there are challenges to either of these processes. For the upmix case, some argue that the result is not sufficiently different from the receiver simulating surround using a single-ended approach, so why should broadcasters bother with encoding pseudo-surround? (Others contend that this would be an interim solution used only while 5.1 content was not universally available, and would eventually go away, just as stereo simulation did in the stereo TV transition.) Meanwhile, an automatic downmix of some 5.1 content may not produce an acceptable aesthetic

result for stereo listeners. (This is why surround music releases typically contain separate 2.0 and 5.1 mixes of all content.)

Note that the latter argument also applies to any device taking a 5.1-channel input from a broadcast — analog or digital — and rendering it as 2.0 audio. For this reason the MPEG Surround system allows the insertion of an "artistic stereo" 2.0 signal, which is what the stereo listener hears, but what is also used as the basis for the reconstruction of a 5.1 mix via the addition of the spatial coding data signal in surround-capable receivers.

So if the up/downmix at the transmitter is not an acceptable solution, the only remaining approach is a completely parallel 5.1/2.0 architecture throughout the broadcast facility, as described above. This means that all content storage will require eight discrete channels (six to include the 5.1 mix and two for the stereo), and all signal routing will require separate 5.1 and 2.0 feeds, all the way to the transmitter site — including STLs, of course.

There are those who feel this is the only way broadcasters should tackle surround, and that it is a necessary complexity of the effort. They believe that going with the simplified single stream approach — whether via composite

NPR is testing the surround multipath issue.

encoding or automatic up/downmixing — will not produce sufficiently compelling results for listeners to adapt in adequate volumes to make broadcasters' conversion worthwhile — or worse, it could actually detract from the stereo listening experience. This camp also points to the fact that surround music content is currently released with two separate mixes as supportive of their approach. (This also implies that broadcasters' locally produced surround content should be produced similarly, with separate stereo and surround versions.)

Going this route may not be as daunting as it initially seems, however. Several eight-channel file formats exist for such use with hard-disk audio storage, making this adaptation relatively simple for PC-based systems — although requiring some expansion in maximum storage capacity. Numerous multichannel audio I/O cards also exist for such systems, at quite reasonable costs. More challenging is

continued

Multicast Ready

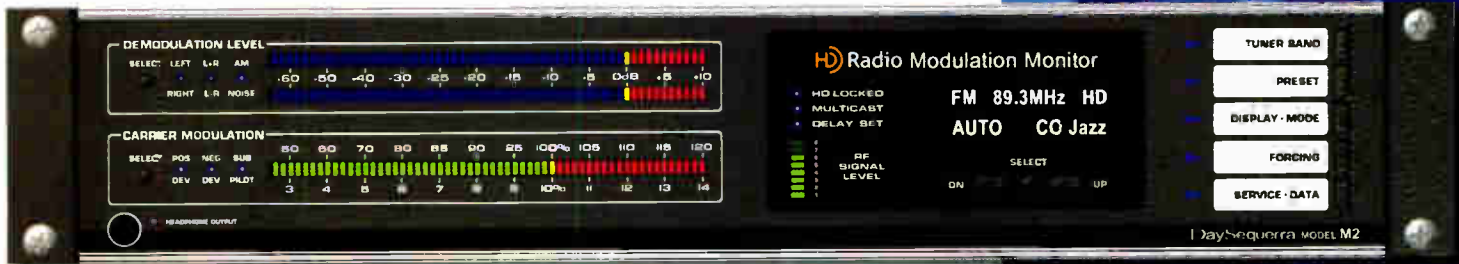

M2 HD Radio Modulation Monitor.



M4 HD Radio Tuner
NOW SHIPPING

- SYNTHESIZED, PUSHBUTTON TUNING FOR AM AND FM BANDS
- DECODE "TOMORROW RADIO" MULTICAST SPS BROADCASTS
- BALANCED ANALOG AND AES3 DIGITAL AUDIO OUTPUTS - 5.1 SURROUND CAPABLE
- HD RADIO TO ANALOG PROGRAM TIME-ALIGNMENT MONITOR
- DISPLAY MPS AND SPS PROGRAM SPECIFIC DATA
- M2.2 NETWORK OPTION FOR HD RADIO MEASUREMENTS INCLUDING BER



DaySequerra
154 Cooper Rd. S902
W. Berlin, NJ 08091
856-719-9900
www.caysequerra.com

Surround*continued*

the routing of signals around the facility in this form, but there are a couple of viable options available here, as well. One is the Dolby-E format, which uses lossless compression to encode eight audio channels into a single AES3 path. (This format was originally developed to solve a similar problem in the DTV environment.) Another is the use of an IP-based audio router, such as that used in the Axia system, which is typically configurable in a range of audio formats.

While broadcasters await possible actions from the NRSC, iBiquity and perhaps even the FCC regarding surround broadcasting, there are a number of other near-term issues that can be considered by the industry. These involve content, compatibility and conversion.

Next steps

Regarding content, there will be a need for substantial amounts of material produced in surround. This includes both published music and station-produced or other interstitial content (including spots). The latter could be where surround is most valuable as a business enhancement tool for broadcasters. To enable

capabilities if they are placed in an air chain, such that content already encoded in surround is left alone, but stereo content is upmixed. The performance and accuracy of such detection may also vary among devices and surround formats.

Regardless of format used, there will be a need to monitor off the air in surround, stereo and mono. If surround content is being broadcast (on either analog or digital), how the content sounds to stereo and mono listeners will also be important to check. This will require a downmix in the station's monitoring system, but not all downmixes are created equal, so there will need to be some consensus or standardization on what downmix algorithm to use for station monitoring. Just as a mono summing matrix takes a "standard" approach on how the left and right signals of a 2.0 stereo mix are combined to a 1.0 mix — i.e., each channel's power reduced by 3 dB, then combined at equal amounts — a standard surround downmix algorithm defines how the channels of a 5.1 signal are mapped into 2.0 form. Probably the best-known example is the downmix standard in ITU-R BS.775-1 (see Table 2).

Downmix to	Output channel	Inputs				
		L	R	C	LS	RS
Monaural (1.0)	Mono (C)	0.7071	0.7071	1.0000	0.5000	0.5000
	Left (L)	1.0000	0.0000	0.7071	0.7071	0.0000
Stereo (2.0)	Right (R)	0.0000	1.0000	0.7071	0.0000	0.7071

Table 2: Downmix Algorithm Proposed in ITU-R BS.775-1

this, however, record labels will have to produce more of their regular releases (and catalog re-releases) in surround, and broadcasters will have to equip their production studios for surround capability.

A related question is whether record companies will move to a single downward-compatible release format (as they eventually did with stereo LPs), or whether they will permanently stick with the separate surround and stereo versions they use today.

Independent of this, broadcasters may want to upmix at least some legacy stereo content to surround during any transition period, which could be lengthy. This could be done manually per song or spot by the broadcaster, or automatically by a device in the audio processing chain. If the latter approach is taken, there may be significant variation between the surround upmixes produced by different devices, so some examination of the options may be worthwhile. It is also likely that such devices might include auto-detect-

Another set of open questions involves the HD Radio system's "blend" to analog FM, and how this might be affected if surround is engaged only on the digital signal (with analog FM constrained to its current stereo, or at best, a single-ended pseudo-surround upmix in the receiver).

This issue is another two-edged sword. Consider that under such a scenario, during the tuning process a surround-capable HD Radio receiver would first acquire the analog signal (in stereo), then switch to the digital (in surround). This switchover would likely be accompanied by a pleasant increase in the richness of the aural image, thereby enhancing the qualitative value of the HD Radio format to FM listeners — which some feel is only marginally apparent in most listening conditions with stereo only today. This in turn could accelerate the conversion to HD Radio by consumers.

On the other hand, when the digital signal failed in this scenario, the HD Radio receiver

would default to analog FM and the surround image would collapse to stereo. How objectionable would this switch be to listeners, and how smoothly would it occur? Would it devalue the analog experience in relative terms more so than without surround on the digital signal? Could its impact be lessened via single-ended surround upmixing by the receiver so long as the stereo FM signal remained? In that case, how objectionable would the ultimate blend to mono be for listeners?

Substantial and worthwhile change is rarely achieved without significant effort.

What about a transition to surround with multiple phases? For example, could broadcasters begin with matrix surround today, then move to MPEG Surround tomorrow? Or could matrix surround be used on analog with MPEG Surround on digital? There is concern that such an approach could lead to consumer confusion, or slow the transition by encouraging consumers to wait for the more advanced technology instead of buying new HD Radio equipment sooner.

Finally, there is still some uncertainty on whether transmitting surround content is even worthwhile, or if single-ended systems automatically generating a surround image from stereo content in the receiver are good enough for most applications. Most enthusiasts clearly prefer the transmission of real surround content via some broadcast method, but there is no real data on whether the majority of consumers would share this view, or even notice the difference. Now that all the proposed formats (including MPEG Surround) include this capability, it is a viable option that could incorporate surround audio on broadcast content, but without broadcasters having any real role in the process. So a certain level of timely proactivity on the part of broadcasters is warranted if they don't want the decisions in this space to be made for them by others.

Substantial and worthwhile change is rarely achieved without significant effort. Such challenges are what lie ahead for the industry as it works toward the first major format upgrade in the last half-century for the audio that FM radio delivers to American listeners. The first steps of what could be a long path to this transition have just begun. ■

Breathtaking Clarity

Telco Digital Program Audio

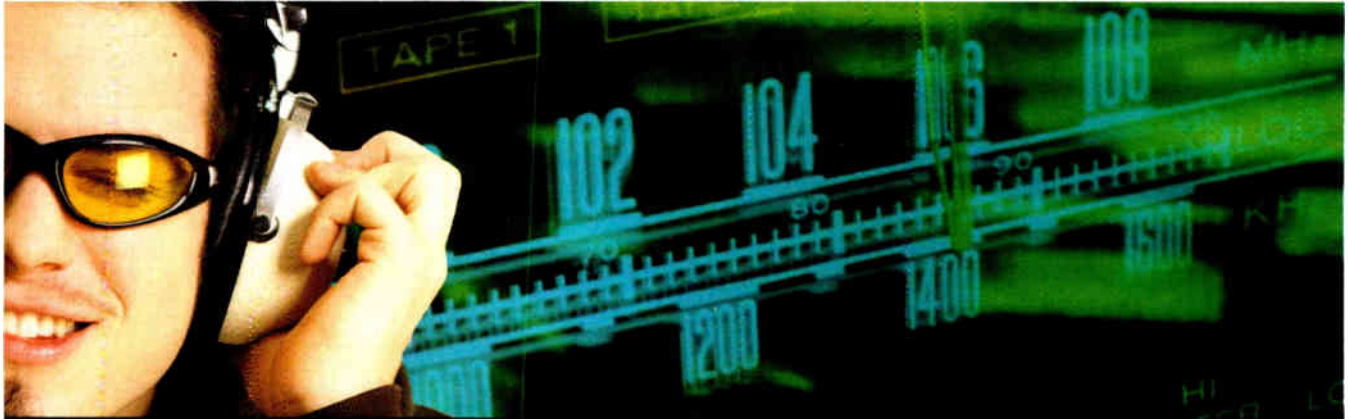

Next Generation Audio for Your Listeners

PCAU

Program Channel Access Unit

*A New Standard for Telco STL, Remote-to-Studio
and Studio-to-Studio Links*

40 Years of Pulsecom innovations.
Here's another — The PCAU: Telco Digital Program Audio

Acclaimed apt-X™ Audio Quality:

- ✓ Transparent Digital Coding delivers outstanding fidelity
- ✓ Low Latency — ideal for monitoring applications
- ✓ Free of “Cascading CODEC” and “Listener Fatigue” issues
- ✓ Multiple tandem connection support
- ✓ Automatic alignment, zero loss Broadband Audio

Universal Telco Connectivity:

- ✓ Compatible with Telco Digital Loop Carrier and NGDLC systems
- ✓ Best-in-class reach to serve remote locations
- ✓ Campus mode delivers service over 3 miles of twisted pair
- ✓ High performance alternative to Western Electric™ KS20159L3, Tellabs™ 4008 and D4 PCUs
- ✓ E-mail: dave.corp@pulse.com to learn more about the PCAU Trial Program



PULSECOM®

Pulsecom is an ISO9001:2000 Company

www.pulse.com

800-381-1997

Pulsecom is a registered trademark of Hubbell, Incorporated. apt-X is a trademark of Audio Processing Technologies, Ltd.
Western Electric is a trademark of Lucent Technologies, Inc., Tellabs is a trademark of Tellabs, Inc., and HD Radio is a trademark of Ibtiquity Digital Corporation.
©2005 Pulse Communications, Inc. All rights reserved.

Surround Production: It's in the Mix

by Mike Pappas

You don't need to lay out a significant amount of money or engage in a lot of head-banging to create surround sound content. Think outside of the box. Be creative and you can get started on the road to surround production.

At KUVU(FM) in Denver we have been producing, recording and broadcasting live concerts in surround for several years. We have developed techniques that will allow you to use much of your existing infrastructure.

It's in the mix

If your existing stereo console has two aux sends that are post-EQ and post-fader and two available groups, you can make 5.1 surround with it.

At KUVU we use a Midas Venice 320 console. It has 32 inputs, four groups, two effects sends, two monitor sends and two aux sends, selectable to be pre- or post-fade.

How do we use a conventional stereo mixer to mix in 5.1? We use the stereo outputs for Left and Right. We use Aux 1 as the Center

We take all of the Midas outputs and we use Y cables to split them between the A to D converters and our 5.1 monitoring system. Since we are not using the Midas control room outputs, which would have the cue bus, we take the control room output into a small cue speaker or use headphones.

The downside to this method is that any stereo mixer you use will not support 5.1 control room monitoring output. To get around that we use a 5.1 monitor controller made by EMM Labs. It gives us the ability to have four sets of 5.1 inputs so we can listen to the discrete 5.1 from the console and the off-air 5.1. It has a master level control and trim adjusts for each output and six presets. Some surround monitoring systems provide a monitor controller as part of the package.

Monitoring

You may be able to recycle your existing stereo monitors as either rear-channel speakers with the addition of three matched speakers for the Left Center Right, or add an additional identical center speaker to your exist-

not going to fix anything; more likely it will make things worse. Fix your control room acoustical problems. You will go a long way toward mixes that translate well to the rest of the world, either in stereo or surround.

The sub's placement in the room will dictate its performance. Make sure it is not creating low-frequency nodes at the mix position that are tricking your ears into thinking that there is more LF than really exists. This is critical for successful use of the sub channel. If you can't be certain that the sub is set up correctly, you might want to forgo the use of the sub channel and rely on the surround speakers to handle the low end.

Metering

We have a DK-Technologies MSD600M++ master stereo and surround sound meter to help us keep track of the six channels of levels; a "jelly fish" surround display makes sure we don't have phase issues between channels that would affect the mix.

We assign the MSD600M FFT function to the sub channel to look for infrasonic noise problems such as air conditioning rumble that are below the capability of our subwoofer to resolve; the phase meter is set to look at the stereo program to make sure that we haven't got something out of phase for our conventional analog listeners.

The MSD600M++ also has a full-blown digital router, eight A-to-D and D-to-A converters along with four AES/EBU inputs and outputs. We use some of those functions to route the L/R Center/Sub left surround/right surround signal in the plant and to convert the digital mix minus from our Logitek plant into analog for talent cueing.

A mix in surround

Making a surround mix isn't all that much more difficult than making a mix in stereo.

If I am broadcasting a jazz trio with a vocalist, I will start by putting the piano in the Left/Center, the bass in the Center/Sub and the drums in the Center/Sub/Right. I will then put the vocalist in the Center channel only. Think of how you would mix it in stereo, then divide it up among the three front channels. I assign the audience mics along with the reverb returns to the rear channels via Groups 3 and 4 and off I go. With bigger groups I just look at what is going to be the lead (vocalist or instruments)

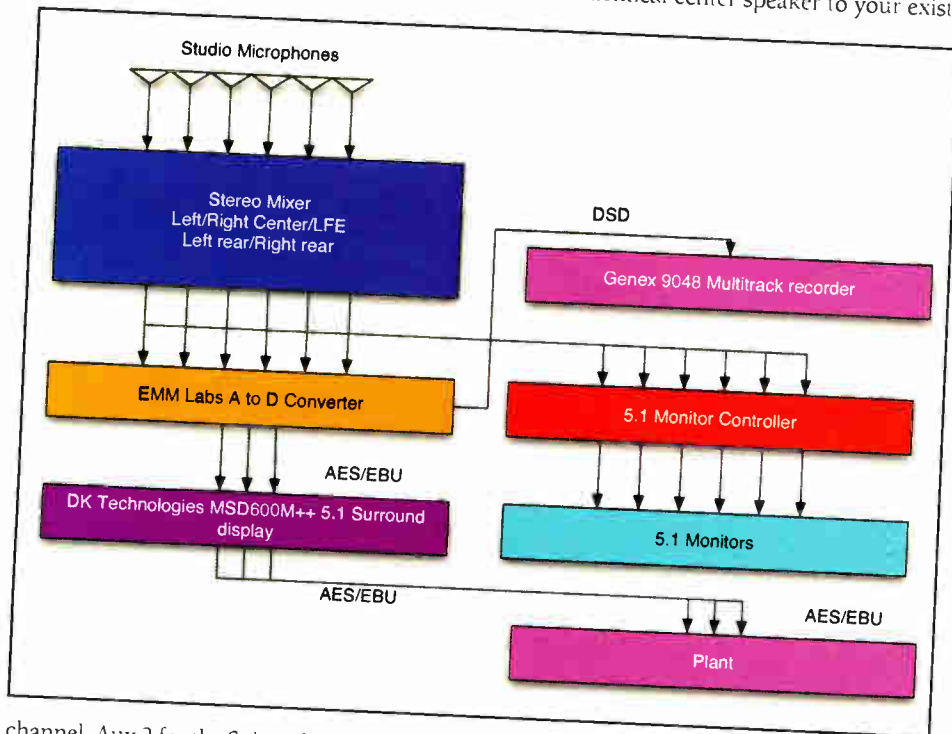

channel, Aux 2 for the Sub with these both set for post fade. Groups 3 and 4 are used for the Left and Right Rear channels respectively.

Obviously, Left Center Right panning takes a little practice; but this technique is serviceable and we have done more than 100 broadcasts using the Midas this way.

ing stereo pair and a pair of rear-channel speakers. Choose speakers that sound similar or you'll go crazy when you try to make a mix.

You need to make sure that your 5.1 monitoring system is set up correctly in spacing and levels. If your existing control room acoustics sound bad in stereo, surround is

and put them in the center channel and build the rest of the mix around it.

Rear channels

My theory on mixing surround is that subtle is better than "in your face."

On our surround broadcasts my goal is to put you in the hall/studio. The performers will be in front of you and the audience will be behind you. I typically crossfeed the reverb returns into the rear channels (left front goes to right rear and right front goes to left rear) with 24 to 26 ms of "pre-delay" to open up the

surround sound experience.

I use a Neumann KU-100 stereo dummy head to mic the audience. You don't need to use KU-100 for rear channels; a pair of spaced cardioids, facing away from the band, works. I avoid using omni mics to generate the rear channels because I would end up with too much of the sound from the band in the rear channels.

Other thoughts

It generally is not a good idea to put a source into all six channels at the same time.

A tuba in the left rear channel is amusing at first but distracting in the long run.

Additionally the novelty of things spinning things around the room dissipates quickly in

Doing surround with existing equipment is not a big deal, with a little creativity. We have been doing it for years and the results have been most satisfying.

anything longer than a 30-second ad spot.

You can record your 5.1 mixes to just about any six-channel DAW or digital multitrack machine. At KUVU we record everything to our 40-track Genex Direct Stream Digital recorder and always assign the last six channels of the machine to hold the 5.1 mix. This lets us have access to the 5.1 mix by simply restoring the backup tape without having to recreate the mix from scratch should we need access to the original.

Doing surround with existing equipment is not a big deal if you apply a little creativity. We have been doing it for years and the results have been most satisfying. ■



Control Room at KUVU



Audio processing for FM, multiple HD Radio programs *and* 5.1 Surround?

Yes, it can process your main FM, main HD and up to two supplemental HD channels.

Yes, it has all the multiband processing functionality you expect.

Yes, it encodes 5.1-Channel Surround, compatible with FM, HD and millions of consumer decoders TODAY.



Yes, there is a headphone connector behind this door.

Yes, that is a composite spectrum analyzer. Really. (and there's a scope too)

Yes, the user interface is simple to learn and use. (and of course there is a blue light)

Yes, yes and yes!

The Linear Acoustic AEROMAX-HDFM

354 North Prince Street, Lancaster, PA 17603, USA 888-292-3117 www.linearacoustic.com
© 2005 Linear Acoustic Inc. All rights reserved. AEROMAX-HDFM and designated company logo are trademarks of Linear Acoustic Inc. SRS and the Circle Surround logo are registered trademarks of SRS Labs, Inc.

L LINEAR ACOUSTIC
Surround Sound Solvers

Together We Have The Power To Move Radio Forward.



At Harris, we're taking our leadership in the radio industry to an even higher level. Shaped by the feedback of customers and audiences across the market spectrum, the newly-formed Harris Radio Team is rich with the industry's most comprehensive products, services and expert resources. All with a focused team solely dedicated to moving our industry, and your business, forward. It's a spirit of innovation built on decades of pioneering solutions for radio. So get your business heading in the right direction, turn to the new leadership of Team Harris Radio.

To learn more about the new Harris Radio Team, call us at **800-622-0022** or visit us at www.broadcast.harris.com.

T H E N E W H A R R I S R A D I O T E A M I S O N T H E A I R



AM/FM

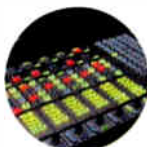

AUDIO CONSOLES



DIGITAL RADIO



BROADCAST STUDIO



HIGH POWER AM



SYSTEMS & SERVICE

www.broadcast.harris.com

HARRIS



"Who's Buying What" is printed as a service for readers who are interested in how they choose equipment and services. Information is provided by suppliers and users.

Companies whose news of unusual or prominent purchases should e-mail information and photos to radioworld@imaspub.com.

OMT said Backyard Broadcasting purchased iMediaTouch Digital Delivery Software for five of its stations in Elmira/Corning,



A BE FM-73 transmitter is on the air at KISS(FM) 102.1 in Sao Paulo, Brazil. Engineer Alfredo Marcouizos put the station on the air, the first HD FM signal in Brazil.

Backyard earlier this year acquired the assets of Midcontinent Broadcasting, a five-station cluster in Sioux Falls, S.D., that has used the iMediaTouch platform since 1996. Ben VanPatten is chief for Backyard Broadcasting in Elmira/Corning.

Dielectric Communications said Radio One in Philly has installed a new antenna system to transmit broadcasts from WRNB(FM).

Dielectric provided a directional, top-mount single-bay antenna plus transmission lines and a custom beacon assembly. The station has incorporated the antenna onto the spire of One Liberty Place, the tallest building in the city.

Dielectric said the antenna radiates signals at lower angles to provide the most signal power at street level and not overshoot nearby office buildings. The antenna went on the air in June. Mike DePolo is chief engineer for the

Philadelphia market. Installation assistance was from Don Train of TRAIN's Towers and Radio One VP of Engineering John Mathews.

The spire at the top of the building obliged the designers to create a cus-

tom assembly and top-mount antenna. Consultant Mark Humphrey said the objective was to expand the range and audience without increasing overall height of the spire. The directional antenna protects a neighboring station to the southwest.

Wheatstone said WRVO on the Oswego campus of the State University of New York is moving into a new facility with two control rooms, two talk studios and two news edit rooms equipped with custom Wheatstone Techline Studio Furniture. Broadcast gear includes a Bridge Router system with two G5 control surfaces and two G3 control surfaces. The chief engineer is Jeff Windsor. Funding for the Bridge Router and G5 control surfaces was provided by a PTFP grant.

Broadcast Electronics said KISS FM in São Paulo went on the air with HD Radio in September, becoming the first station to transmit FM HD Radio in Brazil. The station was using an FMi 73 transmitter package into a separate antenna installed prior to a broadcast convention there. BE said the Brazilian communications regulation agency was expected to announce that broadcasters would be free to install digital radio broadcasting systems, without specifying a system.

The station's 240-watt digital signal was transmitted through a Shively four-bay broadband FM antenna, along with the station's existing installation of a BE FM-35T analog transmitter. The tower is on the roof of one of the tallest buildings on Avenida Paulista.

Coming This Spring!

Experience Total Immersion in Surround Sound At the **NAB2006** 5.1 Audio Pavilion

THE WORLD'S LARGEST ELECTRONIC MEDIA SHOW

See the Latest Surround Technology, Hardware and Software

April 24-27, 2006



Calling all Companies in Surround

Take advantage of this special opportunity to display your surround sound hardware and software to more than 100,000 potential buyers by exhibiting in the NAB2006 5.1 Pavilion. If you are already exhibiting at NAB2006, your cost is only \$5500; non-exhibitors pay \$7000. Cost includes a turnkey pod and extensive pre-show and on-site advertising package. Also available: The Car Package for \$7500, which includes a 10x20 demo area and spotting fee for vehicle (round-trip). For more details, contact NAB at 202-595-2051; email: exhibit@nab.org or visit www.nabshow.com.

5.1 Audio Pavilion

In the Central Hall of the
Las Vegas Convention Center
(adjacent to the Panasonic booth)

5.1 Surround Sound Audio is a significant technological development for broadcasters in both television and radio. It holds the promise of making DTV pictures "look better" as well as enhancing the programming that radio stations deliver to today's tech-savvy consumers.

Learn how to gain the competitive edge with Surround Sound — make plans now to attend NAB2006 and visit the 5.1 Audio Pavilion.

Exhibit space is limited, so reserve yours today!

The NAB 5.1 Audio Pavilion is produced in partnership with IMAS Publishing Group, publishers of

AUDIO MEDIA

TV TECHNOLOGY

Radio World

PRO AUDIO REVIEW



Workbench

► Continued from page 20

Mark starts with a template, then saves the file with the name of what he is

lose anything.

It takes time to begin, but once you get into the knack of it, you will be able to create a diagram in little time. The drawing can be as all-encompassing as in Fig. 2, or a simpler block diagram, like the one in Fig. 3.

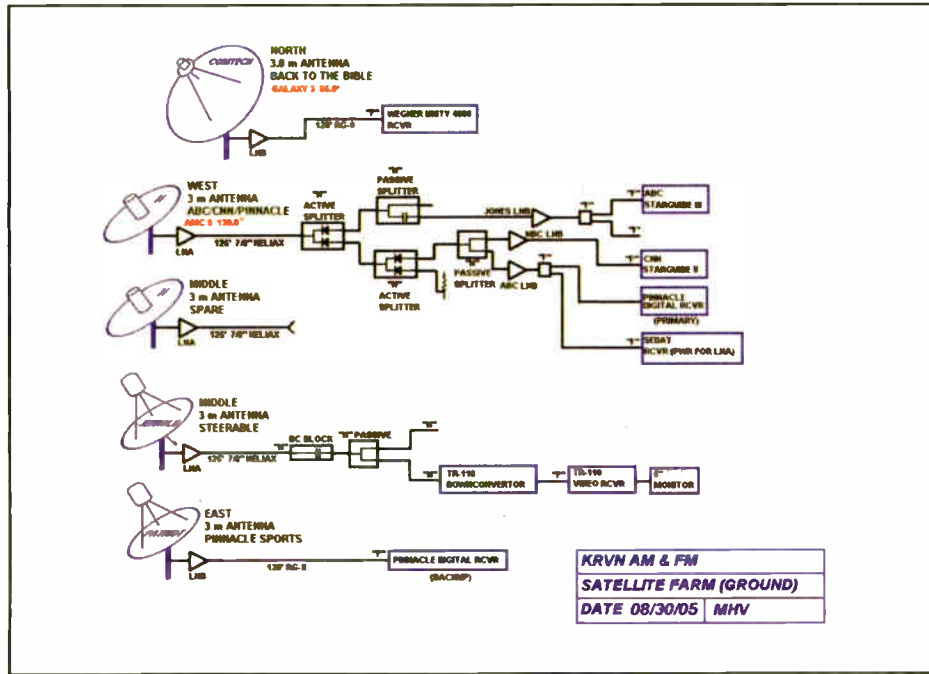

Fig. 3: Drawings can be simple yet still show signal paths.

creating. For example, "KRVN master-control," as seen in Fig. 2.

Once the template is saved, start drawing. Save periodically so as not to

lose anything. Once the diagram is complete he then uses image viewer program Irfanview to view the page and save as a JPG file.

Mark keeps the original drawings in

BMP format, to open again in Paint to modify when needed. The engineering staff of three people keeps notebook binders with the drawings printed out (and in color too), as well as saved on each engineer's laptop. The multiple copies come in real handy when they need to find out where a certain wire goes or what is connected to what.

Thanks, Mark, for sharing such an economical and worthy technique. Mark Voris can be reached at mvoris@krvn.com.

Now that you have your system documentation in check, how about mounting a rechargeable flashlight by the front door of the transmitter building?

Standard flashlights will do, but make sure you have plenty of fresh batteries. To avoid leakage and corrosion, an engineer showed me how to place a small

piece of cardboard between the positive terminal and the flashlight lamp cap. Yes, you have to unscrew the cap, remove the paper and reconnect; but I never had another corroded flashlight, and the batteries were always fresh.

You may have seen the new flashlight offered on the late night TV infomercials: no batteries, you just shake it to charge it up. I haven't tried one, but if it works, it may be the answer to keeping the traditional flashlight stocked with fresh batteries at your transmitter site.

John Bisset has worked as a chief engineer and contract engineer for more than 30 years. He is northeast regional sales manager for Broadcast Electronics. Reach him at (571) 217-9386 or jbisset@bdcast.com. Faxed submissions can be sent to (603) 472-4944. Submissions for this column are encouraged, and qualify for SBE recertification credit.

DIGITAL NEWS

Crawford Makes Room For Multicasting

Crawford Broadcasting Co. operates 29 AM and FM stations including clusters in Chicago, Detroit, Portland, Denver, Colorado Springs, St. Louis and Birmingham. All its FM stations and two of its AMs are transmitting HD Radio; the company plans to have 80 percent of its stations converted to digital by the end of 2008.

Solidifying its position as early adopters on the digital broadcast front, Crawford recently was given authorization by the FCC to begin multicast tests on all of its FM HD Radio stations. Director of Engineering Cris Alexander, who is also a contributor to Radio World, is now tackling facility and infrastructure issues related to multicasting.

"We are just getting into this, but already we have seven of our FM stations multicasting," says Alexander. "We are awaiting arrival of the importer, the device that allow us to carve up the available 96 kbps FM bandwidth into multiple streams, for our remaining FM station."

At the outset, to ease the transition, Alexander sent a pair of engineers to the Broadcast Electronics factory for training on the new equipment; following the training, a how-to document was prepared and distributed to each of Crawford's FM station chiefs.

Based on the company's ambitious multicast upgrade schedule, engineers will be kept busy. "Because we anticipate broadcasting a second unique format on each of our FM stations within the next few months, we are currently addressing a number of facility/infrastructure issues," says Alexander.

One issue demanding attention of any station adding multicasting is the studio-to-transmitter link.

"To multicast, you need a good bit of TCP/IP bandwidth between studio and transmitter, or you need an additional digital audio path with some data capacity as well," Alexander says. "We have been scrambling to address this STL bandwidth issue, adding (spread-spectrum) DSSS links where we can, and in some cases leasing T1 lines. STL bandwidth is where we have spent a good part of our HD/multicast budget."

Also of immediate concern to Alexander is server space to accommodate the demands of multicasting.

"As we have begun adding formats for multicast, we have run up against file server space limitations. To address that problem, we have been installing terabyte servers in our big FM markets. In addition, we have been adding audio servers specifically for the new multicast formats," Alexander said.

Despite a relatively smooth upgrade process to date, being a pioneer of the technology leads Alexander to some interesting issues.

"We are still learning, and I still have a lot of questions. For example, is unlicensed DSSS in the 900 MHz band" — the station uses a Moseley Lanlink 900D — "reliable enough and does it have sufficient bandwidth to accommodate multicasting and PAD transmission? This is something we'll be watching carefully. Also, we will be installing our importers on both ends of the STL."

"There are pros and cons of both types of installation. As we find what does and doesn't work, we'll make adjustments."

Multicasting additional formats will require the Crawford stations to address some long-range considerations.

"To date we have not added studio space for the multicast formats, but we will do this on a five-year plan — or as HD/multicast receivers proliferate to a certain level. We will also have to add office space for the additional programming and other personnel," he said.

"HD Radio is the future of terrestrial radio. And multicasting presents a unique opportunity for stations to increase inventory and revenue, and more importantly provide listeners with additional and more diverse content. To compete with satellite and personal audio devices, terrestrial radio must be different and better. It's up to us to make it succeed."

— Steve Murphy

Over 1,000,000,000 seconds of precision timing



WHEN you require the best, most accurate in precision timing look only to ESE. Designed for "Precision Timing", ESE Master Clocks & Accessories have been the industry standard for over three decades.

Whether using GPS, WWV, Modem, Crystal or line frequency accuracy — all ESE Master Clocks can drive digital or analog slave clocks, as well as interface with video and/or computer based systems. Call or visit our web site for more details.

• 3-Year Warranty •



142 Sierra Street • El Segundo, CA 90245 USA
Phone: (310) 322-2136 • Fax: 310.322.8127

www.es-web.com

HIGHER DEFINITION



Orban's new flagship and the next step beyond the 8400, the new, all-digital 8500 offers major improvements: twice the sample rate, twice the DSP horsepower, and built-in HD Radio /digital radio/netcast processing with 20 kHz bandwidth.

The 8500's competitive sound takes 8400 version 3.0 sonics to the next level. The 8500 will import and run any 8400 preset, so anyone with carefully customized 8400 user presets can upgrade to the 8500 without missing a beat. For HD Radio broadcasters, a built-in, defeatable 8-second analog-channel delay lets you use the 8500's built-in stereo generator and patented "Half-Cosine Interpolation" composite limiter to maintain full loudness on your analog channel.

All processing structures have about 4 milliseconds less delay, making headphone monitoring even easier for talent. For the most critical off-air monitoring requirements, you can even use one of the new "ultra-low latency" presets with only 3 milliseconds of delay.

Ethernet is now built-in. Of course, you can also control the 8500 via modem, serial connection, GPI, external RS-232-interfaced automation, or internal clock-based automation with Internet time sync—the 8500 is always easy to integrate into your facility, regardless of complexity. And we've retained the 8400's famous ease-of-use that makes it easy for you to brand your sound by creating your own custom presets—even if you're not an audio processing expert.

Ready for higher definition?

No matter what your audio processing challenges may be, Optimod-FM 8500 is ready when you are.

Introducing Optimod-FM 8500



Orban/CRL Founder and VP of Engineering Bob Orban (left), and Orban/CRL President, Chairman, and CEO Jay Brentlinger (right), receive Radio World's "Cool Stuff" Award for the new Orban Optimod-FM 8500 audio processor at the National Association of Broadcasters 2005 in Las Vegas.



www.orban.com

When Streams Become Files

A New Battle Is Brewing Over Usage Of Digital Music Delivered Via Digital Radio

Last time we considered how to make radio content less perishable and thereby more appropriate for short- or long-term storage. This discussion was aimed primarily at podcasting of selected radio broadcasts, but there's another closely related issue that has been making waves lately, and which may have strong impact on future radio business.

To best understand this issue, a review of context is helpful.

First, recall that the music recording industry has taken great pains to prevent

the storage of webcasts by consumers. There are several provisions in the Digital Millennium Copyright Act, or DMCA, that address this point specifically. Through its primary trade association, the Recording Industry Association of America, the industry also is currently lobbying hard to have similar restrictions applied to IBOC digital radio.

Next, you may have noticed the strong response over the past year or so to XM Satellite Radio's XM2Go products, as well as Sirius Satellite Radio's handheld

devices that could receive, and in some cases, store satellite radio content.

Importantly, the satellite radio was careful to steer clear of most of the recording industry's concerns by offering the storage-capable devices with no digital audio I/O, no removable storage and no ability for much user interactivity with the recorded content.

In fact, although described by some as "TiVo for satellite radio," these units were really more akin to digital VCRs, in that recording content was only possible by hitting a record button in real time while listening to a particular channel, or by presetting a channel, start and stop time for a future recording. Once record-

The Big Picture



Photo: Gary Hayes, BBC

by Skip Pizzi

ed, content could only be played or deleted — no editing was possible — and storage was initially limited to about three hours. (Some manufacturers' XM2Go units now hold as much as five hours of content.)

Recently, however, both satellite radio firms have announced plans to introduce next-gen handheld receivers with decidedly different functionality.

Some feel that this crosses a line from transitory to permanent storage of copyrighted material.

In July, XM announced that at least one consumer electronics manufacturer will produce devices in time for the holiday buying season this year, which combine MP3 player capability with satellite radio reception. Shortly thereafter, Sirius released information on its upcoming \$50 receiver, a portable device about the size of the original iPod, which was planned to be on store shelves this month.

New rules?

These units will greatly increase the storage capacity for recording satellite radio — perhaps up to 50 hours. But a more controversial attribute of the new devices is their potential ability to allow users to edit a recorded satellite radio stream and store individual songs (or other content elements) as separate files on the device, while deleting others from the recorded stream.

In at least some cases, this capability would reportedly come at no additional charge to subscribers, which in the record industry's view amounts to a free download.

Some in the music industry apparently feel that this crosses a line from transitory to permanent storage of copyrighted material, which violates current legisla-

See PROTECTION, page 25 ▶

Xtreme-digilink

**Live On Air
Hard Disk Music
Satellite Automation**

over 100 shipped
since April !!!

NEW



NEW Features

- Music Scheduling
- Long Form Recording
... with Logic
- Live Remotes by phone
- and much more...

New... use third party music schedulers or the powerful internal scheduler. Record multi-hour programs with logic and play them back like a virtual satellite feed. Call in by cell phone and interrupt programming with a Live update.... and much more.....

- No down payment
- Return at any time
- Free Factory training
- Free Hardware support
- Free Telephone support
- Free Software upgrades
- Free Hardware upgrades
- Free PC and Network setup

ONLY \$100 PER MONTH

Xtreme is a complete solution for live & automated On Air Radio systems. Pay one very low monthly fee, and we do the rest. We supply the audio hardware, software, and support, while all that you supply is the PC. Without a large initial equipment investment there is no financial risk or capital expense; the old automation system can be upgraded out of current operating costs. With free system configuration and training you receive the help you need to make a smooth transition to the new system. With free hardware replacement, ongoing repairs are worry free. Free telephone support helps train new staff, and free software upgrades means you have the latest product features at no cost. The only hardware that is not included is the PC computer and we can help you with that too... also for free.



come to our FREE school !

...the risk free automation system
XTREME~digilink



970-461-0730 www.arrakis-systems.com

over 100 shipped !!!

Arrakis

Protection

► Continued from page 24
 tion and/or licensing agreements. They predict that quick litigation will follow if the products are released as apparently planned. Meanwhile, the satellite radio companies reportedly feel that they are on defensible legal and licensing grounds with this move.

More practically, the recording industry and others are concerned that this capability will thwart the growth of nascent but increasingly popular paid music download services. (However, some pre-release product literature indicates that recorded songs from satellite radio can only be "tagged" for later purchase from an online music store. It is likely that this variant would be acceptable to the music industry, so it could indicate a potential way out of the impasse.)

At press time, the controversy had not yet produced much in the way of public pronouncements, as the engaged players refrain from comment and sensibly try to work things out. But there's apparently been no shortage of heated debate in those discussions; and if the wide gulf in positions persists, it is likely that this will spill into the public record soon, if it hasn't already by the time you read this.

Other potentially controversial, but as yet undetermined, issues will be whether these or future devices include digital audio I/O or other digital interfaces — USB, IEEE 1394, WiFi, Bluetooth, USB, etc. — and whether any removable storage, such as SD cards, can be fitted. Also critical will be the level of predetermination of upcoming content (i.e., playlists in advance) or any other search or automated recording features, which would allow a user to set the device to capture particular songs wherever and whenever they appear.

Finally, the parameters of any rights

management applied to stored content will be of concern, particularly if transfer of copyrighted material to PCs or other digital devices is possible.

Yet another consideration is whether the audio quality of satellite radio is up to the task for a music download modality. But of course, if such capability is available at no additional cost, this issue may be of little concern to subscribers who are already satisfied with the audio quality of real-time satellite radio service.

Deep impact

This predicament could appear to be just another of what seems a nearly limitless sequence of thrusts and parries between content owners, conduit operators and consumer electronics manufacturers.

What is salient about this particular

case is that its outcome could resonate beyond the specific parties involved. If a precedent is set that allows such functionality to be applied to broadcast music streams, it could open the door for webcasts and even IBOC digital terrestrial radio to do the same.

A contributing factor here is the strong climatic shift in the federal legislative and regulatory environment away from applying different rules to different delivery systems. (This is the primary motivation behind the current move in Congress to revise the Telecom Act of 1996, the fundamental law behind all U.S. communication regulations.) Given this, what's found to be acceptable on one medium is more likely to be applied broadly to all or many others.

Thinking ahead, though, even if such functionality were to become possible for

terrestrial radio broadcasters, it is almost certain that a business — or perhaps even a regulatory — prerequisite would be the inclusion of some form of content protection limiting the usage and redistribution of such content, as is already inherently provided by satellite radio's conditional access systems. (Note that the current systems used by satellite radio may not be adequate for the type and/or level of protection required for some of the envisioned functionality of these devices, however — at least in the music industry's opinion.)

More on the options for adding such content protection technology to terrestrial digital radio broadcasting, and the RIAA's already stated preferences in this area, in the next issue.

Skip Pizzi is contributing editor of Radio World.

Why Write For Radio World?

- ✓ Get paid for your career expertise.
- ✓ Increase your professional standing by becoming associated with radio's most respected technology and management publication.
- ✓ Be seen by thousands of U.S. radio station engineers, owners and managers.
- ✓ Take part in the industry's marketplace of ideas.
- ✓ Help mentor and train others.
- ✓ Build a valuable network.
- ✓ Enhance your own education through story research and industry contacts while being paid for your time.

Sent story ideas or queries to the editor at radioworld@imaspub.com.

wherever. whenever.

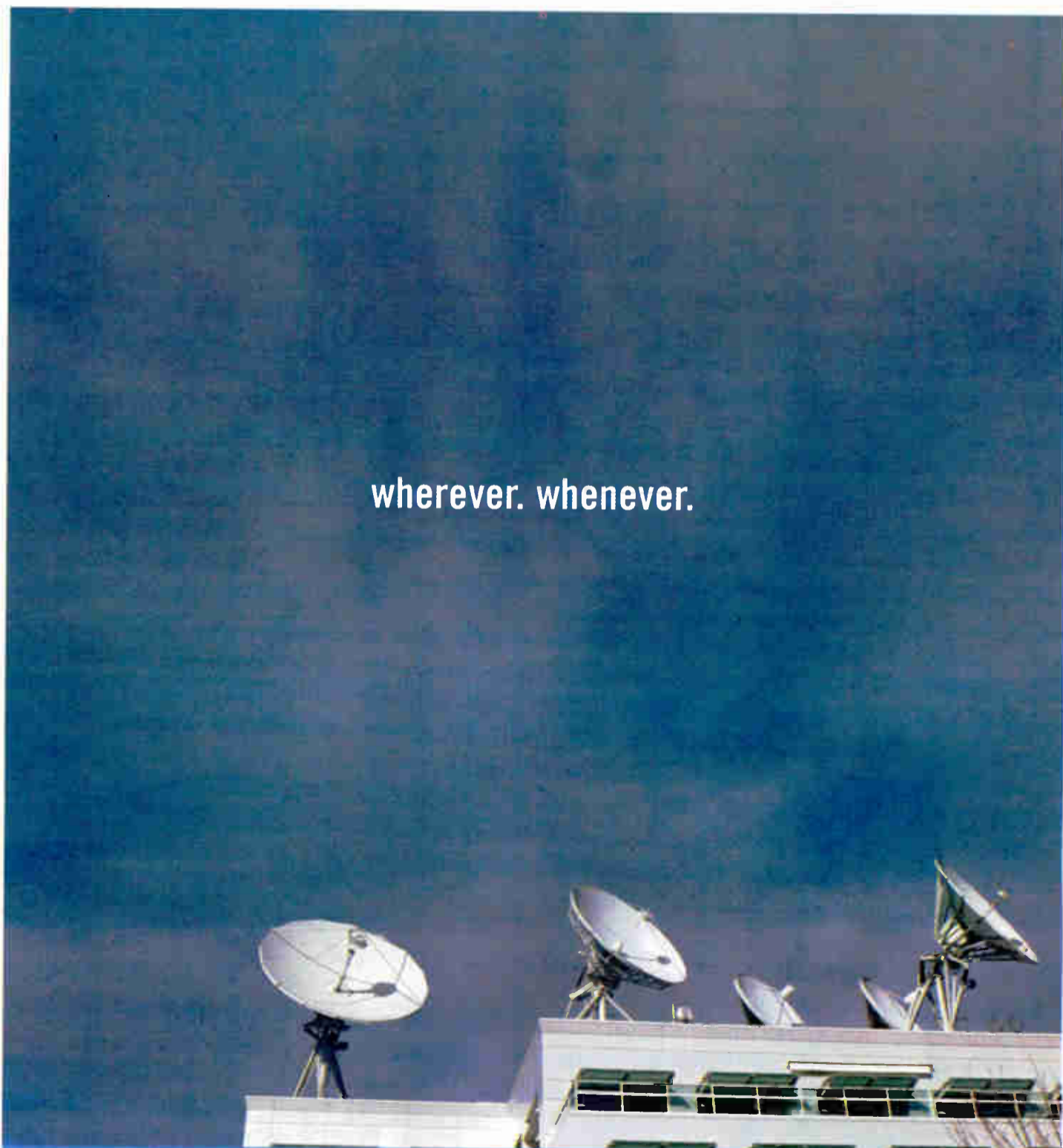

Prime C-band satellite capacity, digital system design, and expert field engineers to assist you. To cover the U.S., Mexico, and the Caribbean. Faraway affiliates, distant stations, hard-to-reach areas are all within easy reach. With reliable, low-cost solutions, maximum flexibility, and engineering support 24/7. Wherever you want us, whenever you need us. Call NPR Satellite Services at 202.513.2626 or visit www.nprtsa.org/world.

npr
satellite
services

space segment | equipment | uplink services | system design | engineering support | 24x7 customer service

Surround Content for HD Radio

by Tom Vernon

As debate about whether and how to develop technical standards to encode surround sound for HD Radio continues, the issue of content has received less attention.

Sufficient material in 5.1 surround needs to be available for the medium to survive on radio. A lack of four-channel content was one of the reasons for the demise of quad in the late 1970s. If surround is poised to enter HD Radio, some fear history might repeat itself.

hearing surround in their cars, in HDTV on HBO programs, and even with their computers so they'll be expecting it in HD Radio as well."

Part of Graupner's strategy with 5.1 is to be ahead of the industry.

"It may take a while for surround to be fully deployed in HD, but when the demand comes, it will be very rapid. We plan to have all of our materials available in 5.1 before that need arrives." He said TM Century's first priority is getting its content into 5.1; media for distribution can be



'The potential of surround is phenomenal,' says Bruno Caruso. 'It can help put Emerson College at a different level than other institutions.'

We asked several industry professionals about the availability of surround sound broadcast programs and musical recordings, as well as the gear necessary to produce local surround sound content.

It's coming

David Graupner, president and CEO of content provider TM Century, thinks it's not a matter of if surround sound is coming to HD Radio, but when.

"5.1 is the new stereo. Consumers are

worked out later. DVD-A is a definite possibility according to Graupner, but other technologies are under consideration.

Broadcasters wanting to produce their own surround content may need to upgrade production facilities. Jim Bailey, product development manager for Tascam, listed some of the necessary gear.

"A digital audio workstation with audio editing software is essential. A useful accessory is a surround monitor controller, such as the Tascam DS-M7.1."

This device can control the volume of six speakers with one knob and allows a quick check of stereo/mono compatibility. Bailey said a digital console that can do a surround mix is useful for serious production, although it's possible to record directly onto the DAW.

Dan Craik, product manager for commercial audio systems at Yamaha, said some mixers, such as the Yamaha DM-1000, have surround monitoring, ProTools control and effects built into the console.

If a digital mixer is used, the next step is usually a PC workstation that has editing software such as ProTools or SonicForge, as well as a DVD authoring program like Minnetonka's Disc Welder or Apple's DVD Studio Pro. Craik said DVD workstations are one area where Apple Computer commands a significant share of the market.

The final stop in the production chain is the DVD burner. Prices continue to fall, and range from \$150 to \$300, with external units costing more than devices which mount inside the PC workstation. Popular choices include the Plextor PX-504A and Panasonic LF-D 512.

Currently there are no broadcast-quality DVD-A decks. Stations wanting to play DVDs live or dub them into a hard drive must resort to consumer-grade gear.

'Equivalent product'

Some in the recording industry are embracing 5.1 surround.

Brian Ackley, chief operating officer and chief engineer of American Gramophone, said virtually all of that company's current releases are available in surround.

"We provide an equivalent product for both the surround and traditional markets. To do this, we use a dual disc, with 5.1 DVD sound on one side, and CD-compatible audio on the other." He said interest in the competing Super Audio CD, or SACD, system is "just about over." Releasing material in surround has become a common practice.

Some artists are responding to the surround sound medium. Ackley mentions Chip Davis, founder of Mannheim Steamroller, who composed music specifically for surround since 1998.

"There is a thriving market not only for new releases, but also re-releases of older albums which were originally mastered on 8, 16 or 24 track tapes," Ackley said.

While the re-release market has potential, he feels, there may also be pitfalls.

"Producers need to be sure the original content can survive a surround sound remix. Without this care, the remix may lose some of the magic of the original recording, and leave consumers dissatisfied. It's important to get a sense of the original groove of a recording, and make sure the stereo down-mix is at least as good as the original."

At WERS(FM) in Boston, there's a great deal of enthusiasm for broadcasting live surround content on HD Radio. Audio Broadcast Engineer Bruno Caruso said, "WERS has a block format, with a lot of live music, including live music weeks. There's a tremendous opportunity to broadcast 5.1 mixes from our live performance studio."

Caruso has been in contact with many manufacturers regarding 5.1 encoding for STL links and transmission, and is waiting for the final pieces to fall into place. The intent is to have a surround signal on the air as soon as possible.

WERS is a student-run station at

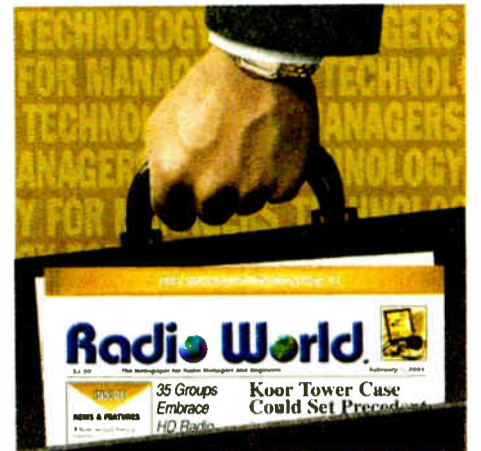

TECHNOLOGY FOR MANAGERS

Emerson College, so the hands-on opportunities for students to become proficient in 5.1 production are important to Caruso.

"We're providing students with skills that can lead to careers in the radio, gaming, film, recording and television industries. The potential of surround is phenomenal. It can help put Emerson College at a different

See SURROUND, page 28 ▶

DVD-A

DVD-Audio is the medium of choice for distributing surround sound audio. It is a Digital Versatile Disc format developed by Panasonic specifically to contain high-quality music and audio data. The format was adopted in 1999 by the DVD Forum.

The DVD format represents a vast improvement over CD audio quality, which is limited to 44.1 kHz/16-bit. DVD audio can be 16-, 20- or 24-bit, with sampling rates of 44.1, 48, 88.2, 96, 176.4 or 192 kHz. DVD-A discs can handle anything from mono to 5.1 surround in various sampling rates and frequencies. Audio is stored in the LPCM format (uncompressed or "losslessly" compressed with Meridian Lossless Packaging).

DVD authoring software has been developed to enable users to bundle stereo or multi-channel audio content with extras such as lyrics, liner notes, photos and menu navigation.

Audio professionals in the recording, gaming, film and independent television markets have quickly adopted DVDs for the production and distribution of multi-channel audio. At present, it is the only affordable format that can record 24-bit/192 kHz stereo or uncompressed multi-channel surround sound accurately.

While most of the industry supports DVD-A as the successor to compact discs, Sony and Phillips have introduced their own product, the Super Audio CD. SACD has audio quality and capabilities that are comparable to DVD Audio. One pitfall of both DVD and SACD discs is that they are not always compatible with legacy players, making the purchase of new gear necessary.

The number of DVD-A releases is growing rapidly. In addition to new material, there is a virtually unlimited supply of recordings that were made in the 1960s and '70s that can be remixed for 5.1. The Beach Boys "Pet Sounds," Mannheim Steamroller's "Christmas Celebration" and Queen's "A Night at the Opera" are among classic albums that have received a surround sound facelift.

—Tom Vernon

The Wizard™ has gone STEREO!

The new **DIGITAL FMSA-1** gives The Wizard System unmatched stereo monitoring capabilities...



Superlative stereo performance. Linear-phase filters that reveal the true performance of your audio processing. The stability of digital stereo demodulation. The sophisticated graphical presentation of The Wizard. And — with the RS-232 port — operation on site or off.

Contact Belar today for more details on what should be *your* next modulation monitor

BELAR ELECTRONICS LABORATORY, INC.
119 LANCASTER AVENUE • P.O. BOX 76 • DEVON, PA 19333-0076 USA
(610) 687-5550 • FAX (610) 687-2986 • WWW.BELAR.COM
Call, write or FAX for more information on Belar AM, FM, Stereo, SCA and TV monitors

Exclusive BSW Offer!!



R55E-18 shown with optional module

Hurry!! BSW Special Offer Expires Dec 31st.

AUDIOARTS ENGINEERING

FREE Phone or 6-Line Selector Module with Audioarts R55 Console!

FEATURES:

- Two VU meter pairs (program and switched)
- Built-in cue speaker, timer and Talkback
- Two stereo program busses, two mono busses
- Low-profile countertop installation
- Rackmount power supply
- Built-in cue speaker with amplifier and external cue line output
- Flip-up meterbridge and A/B inputs

R55E	8-channel console	List \$4,890.00
R55E-12	12-channel console	List \$6,420.00
R55E-1812	18/12 console	List \$7,135.00
R55E-18	18/18 console	List \$10,190.00

MODULES:

SPN55E	Phone input module	List \$657.00
SS55E	2nd studio monitor	List \$547.00
LS55E	6-position stereo line	List \$342.00
LS55E	Spare stereo line in	List \$578.00
TR55EFF	Tape remote	List \$276.00

LowestPrice@bswusa.com
OR CALL 1-800-426-8434

BSW sells more Audioarts consoles than anyone in the world. Why? Because we have lower prices and fast delivery from the factory. And when we include a FREE phone or 6-line selector module, these R-55s practically sell themselves!

The Audioarts R-55 modular consoles come in 8-, 12-, and 18-channel mainframes with illuminated LED switches and flip-up meterbridges that provide direct access to I/O connectors and dipswitches. They feature a sleek, low-profile countertop design, with opto-isolated preamp control and built-in modules, control room/studio monitor module, output module, a cue speaker and an installation kit with crimp tool/manual. The R55E-12 has 12 stereo line modules and a digital timer. The R55E-1812 and R55E-18 models add a digital clock/timer, and have 12 or 18 stereo line modules standard.

Hurry! Order by December 31st, and get a FREE SPN55E phone module or a LS55E 6 position stereo line selector module (your choice) from BSW! Call your sales rep today for the lowest price.



Lowest Quote!!

Omnia - Top FM Processor for HD Radio

For large-market stations, the Omnia-6EXi HD provides FM broadcasters with parallel processing paths individually optimized for conventional FM audio and digital transmission chains - especially bit-streams. The Omnia-6EXi adds fine-tuning controls, with a unique parallel processing structure that routes audio from the mixer section to output stages for both conventional FM and DAB. The FM section receives distortion-controlled final limiting with pre-emphasis, and an upper-frequency response of 15 kHz. The DAB section has a multi-band Look-Ahead final limiter with frequency response all the way up to the full audio bandwidth of 20 kHz. Call us today with your quote for the industry's lowest price.

OMNIA6EXIHDFM List \$12,580.00

LowestPrice@bswusa.com
OR CALL 1-800-426-8434



Haven't Gotten Yours?!! ...Marantz Handheld Flash Recorder

The PMD660 digital recorder lets you record hours of MP3 audio on a single Compact Flash card (or as uncompressed 16-bit .wav files) and easily transfer to your computer via USB. You can even edit in the unit itself - use simple cut-and-paste editing or take advantage of non-linear, non-destructive playlist editing. Virtual tracks let you compare edits, set up multiple sound bites or provide interview segments of varying durations. On-board mics for stereo recording, or XLR inputs and mini-jack line I/O.



PMD660 List \$649.99 **LowestPrice only \$499!**



ApheX 230 Broadcast Voice Processor with Big Bottom

Let's face it - everyone wants a better voice - you, your boss, your boss' boss. Vocal presence is HUGE, and there's no better way to get it than with a great voice processor. ApheX has created an analog, single-channel preamp and voice processor specifically for broadcasters. Its comprehensive features include tube preamplification, Easyrider auto-compression, Logic-Assisted gating, de-essing, parametric EQ, and ApheX' Aural Exciter and Big Bottom psychoacoustic effects - all through.

230 List \$799.00 **LowestPrice only \$699!** **APHEX**



Tascam Single Rack Space CD Player with XLRs

The new Tascam CD-01U Pro is a professional slot-loading CD player designed to fit in 1RU, with balanced XLR analog, RCA analog and digital outputs. This compact professional model will save room in your broadcast equipment rack. Also available is an affordable unbalanced version - the CD-01U. Both players have an RS-232 control port available for programming with AMX and Crestron systems. They also feature MP3 playback, 20-second shock protection and pitch controls for flexible performance.

CD01UPRO w/XLR out List \$699.00 **LowestPrice only \$599!** **TASCAM**
CD01U wo/XLR out List \$599.00 **LowestPrice only \$499!**



Broadcast Tools Over-the-Internet Remote Site Control

The Broadcast Tools, TinyTools WRC-4 transmitter site control delivers a powerful built-in web browser, Ethernet port, and four channels of 10-bit analog inputs with a large monitoring range. Features: TTL compatible digital (contact closures), inputs SPST relays, open collector outputs, temperature sensor, and 4-email notification.

WRC4 List \$439.00 **LowestPrice only \$389!**



Broadcast Tools Passive Audio Switcher

The SS4:1TERMII offers passive switching/routing with four stereo inputs to one stereo output or vice versa. Pluggable screw terminal connectors; 1/3-rack size. Optional rackmount shelf available. Only \$199 at BSW!

SS4:1III List \$239.00 **LowestPrice only \$199!**



Broadcast Tools Silence Monitor

A must-have for every monitor! The Broadcast Tools Silence Monitor III monitors your audio signal, generates alarms and transparently switches to back-up source equipment when silence is detected. Order today.

SMIII List \$259.00 **LowestPrice only \$229!**



New Product Alert #4
There are times when you just need to be on the scene, broadcasting events as they happen. And you are fresh out of codecs. Try the new PortaKnitter - a 500W transmitter that's compact enough to go where you go.

Money Machine!!



Audio Time Manager from 25-Seven

ATM from 25-Seven gives you the power to shift live programming in real time without compromising sound quality. Squeeze more time (up to 6 minutes per hour) without audio artifacts and glide undetectably between scheduled programming and added content. Use it to clean up network feeds, run PSAs or add local spots for extra revenue!! By allowing you to delay the start of syndicated programming and shorten its duration in real-time, ATM puts you in control of your broadcast schedule without removing content, changing pitch or creating annoying artifacts. Plus, it's easy to use. Call BSW today.

ATM List \$7,950.00 **LowestPrice@bswusa.com**
OR CALL 1-800-426-8434

Lowest Prices on everything at: www.bswusa.com

Same Day Shipping
BSW stocks a large number of products. If we have it in stock, we'll ship it the same day. Just order by 1:00 PM Eastern Time.

Free Shipping on Most Web orders over \$189
We will ship over \$189 and FREE ground service delivery to the contiguous US states. (Excludes heavy oversized items.)



1-800-426-8434
World Radio History

Knowledgeable Staff

Our sales professionals have over 20 years of broadcast and audio experience. We offer expert help with all your equipment needs. We're BSW!

LowestPrice@bswusa.com

For the best prices on all of your gear, visit us at www.bswusa.com. We'll make it just for a quote at www.bswusa.com.

Studios to Feel Digital Growing Pains?

Facility Managers Have to Think Ahead

by Stephen Murphy

Apart from the surround encoding debate detailed in the pages of Radio World, stations planning to take advantage of HD Radio's delivery capabilities must also address acoustic issues specific to surround monitoring. Unfortunately, with the myriad issues inherent to upgrading to HD Radio, creating proper surround production and monitoring environments may not always get the attention or expenditure it deserves.

The reason stations need accurate monitoring environments is straightforward. In order to make critical audio

decisions, it is imperative to have an accurate baseline from which to operate.

will ensure the translation of your audio output to the greatest range of listening environments. This is critical particularly for production rooms providing content

The same challenges and solutions apply, whether the room is intended for broadcasting, post-production or multitracking.

— John Stork

A properly designed room combined with a high-quality monitoring system

and/or making creative audio decisions regarding content.

Sure there are the notable high-profile, surround-capable broadcast production studios such as those found at XM Satellite Radio's facilities at Jazz at Lincoln Center, Thirteen/WNET (PBS), Interlochen Public Radio (NPR/PRI) and WGUC/Cincinnati Classical Public Radio. But what of the hundreds of stations that will be adding surround to their digital broadcasts and can't squeeze a new multi-million dollar 5.1 production facility into the budget? Most likely they will be upgrading existing rooms.

Same principles

John Stork, whose architectural acoustics firm Walters-Stork Design Group designed the facilities named above, provides insight for those wishing to upgrade production and monitoring spaces. Stork says the same set of basic surround design principles holds true regardless of the intended use of the space.

"From our perspective, and that of acoustics in general, surround is surround," he says. "The same challenges and solutions apply, whether the room is intended for broadcasting, post-production or multitracking."

"Additionally, the radio world has certainly not come up with its own set of

See PLANS, page 29 ▶

Surround

▶ Continued from page 26
level than other institutions."

Some stations with an HD signal are looking at different options. Tobias Poole, operating director for WRTI in Philadelphia, said, "Multicasting is far more important to us than surround sound. Once we have two streams running 24/7, then we can discuss any other enhancements to the service." Currently, WRTI broadcasts a "classical by day, jazz by night" format.



Brian Ackley, COO and chief engineer of American Gramophone, said virtually all of his company's current releases are available in surround.

Ironically, 5.1 surround may face stiff competition from the low-tech audio marketplace. Craik notes the popularity of MP3 players such as Apple's iPod, and adds that a significant part of the younger audience seems willing to sacrifice audio quality for the convenience of a smaller device.

He also observes an industry trend for hot and punchy recordings with limited dynamic range.

"We have the potential to create gourmet-quality sound, but much of the younger audience has McDonald's-quality tastes."

Your thoughts on the outlook for surround in radio? E-mail them to radioworld@imaspub.com. ●



Small processors, Big sound

From the company that brought you the DSPX, we bring to you the Xtra and the mini.

DSPXmini

\$1,700.00

- Cost effective FM only version of the DSPX
- 4 band DSP processing
- Lan & serial remote control
- Unbeatable value for money
- Supercharged DSP engine 'outruns any turbo'



DSPX

\$3,300.00

- UK's most popular DAB processor
- 4 band DSP processing
- Lan & serial remote control
- Analog, Digital and MPX IO's
- FM, DAB, HD and Net processing setups
- Presets and real time clock



DSPXtra

\$6,500.00

- 6 band DSP processor
- Integrated 'award winning' Ariane Leveler
- LAN, USB & Serial remote control
- Analog, Digital and MPX IO's
- FM, DAB, HD and Net processing setups
- Unbelievable sound



www.bwbroadcast.com

Plans

► Continued from page 28

surround standards. They're happy to adopt the ITU standards for speaker placement, which is just fine for most purposes."

Storyk cautions that transforming a well-designed — or sufficiently designed — stereo room to 5.1 is far from an automatic process. With speakers firing in all directions, careful consideration of room shape and overall symmetry, surface treatment and speaker placement must be scrutinized.

As an example, Storyk describes an upgrade project on which he is working for the Food Network and says the same issues apply to radio.

"Their primary audio production room was conceived and built as a stereo room only a few years ago, and now has to be upgraded to 5.1. They can't change the room — it's the only one they have — so we have to go in and make some architectural and acoustic changes to get the room to work in 5.1.

"Specifically, we have to make the back of the room more symmetrical — if anything, this is the single biggest issue for rooms designed for optimal stereo listening that now have to accommodate surround."

In a stereo environment, Storyk said, only the front half of the room must be symmetrical. When you start putting in rear speakers, the whole room must be symmetrical around the acoustic centerline of the room.

Specifically, in this case, the rear right-hand side of the room was not the same as the left-hand side. "It just didn't work out that way when they first built the space, and it wasn't that critical for stereo monitoring; but now the issue has become critical for accurate surround monitoring. We're going to have to do some minor architectural yet acoustically significant changes in order to get the back speakers to behave symmetrically."

Another issue that can become a problem when converting from stereo to 5.1 is that a lot of designers traditionally made the front of control rooms on the bright,

reflective side. Now, with rear speakers firing into these surfaces, that too can become a problem.

On a positive note, Storyk says, "Smaller on-air rooms are usually on the dead side, and with small, high-quality monitors, it's not too difficult to get a room in line for basic surround monitoring purposes. It obviously becomes much more critical if it's a large room set up for audio content production."

A good sign for the future, Storyk says, is that most of his firm's work for broadcast facilities in the past several years has been geared towards surround production and delivery.

Pro Audio Review Studio Editor Stephen Murphy has over 20 years broadcast and audio production experience, including Grammy-winning and Gold/Platinum credits.



Vagabond Audio is a Chicago-based studio that does extensive work in 5.1.

Photo by Jan Oberg

MASTER CONTROL™

The On-Air Digital Studio

The best use the best.™



"We've been using RCS Master Control, Selector and LINKER at WXPN for over seven years. We upgraded to the latest version just before we moved into our new building last year, and now our programming staff couldn't live without it."

Jay Goldman, Technical Director
WXPN/ Philadelphia

RCS
Sound Software™
www.rcsworks.com

© Copyright 2005, RCS, Inc. All Rights Reserved. RCS is a registered trademark and RCS Sound Software, Master Control and "The best use the best" are trademarks of RCS, Inc.

You Read It Here...



20 Years Ago

"An improved medium-wave antenna design, the new FMX extended-range FM stereo system and latest developments in AM technology improvements were highlighted at the 35th annual IEEE Broadcast Symposium ...

"Leading the radio engineering session was Emil Torick of the CBS Technology Center, who introduced and demonstrated the new FMX system designed to improve stereo fidelity and increase coverage area of FM stereo broadcasts."

"IEEE Profiles New Designs"
by Edward Wytkind
Oct. 15, 1985

At WGUC, Eager for Radio

by Rich Rarey

Don Danko is a man impatient — impatient with the slow progress of surround sound for broadcast.

"We started seeing surround coming down the pike about five or six years ago," he said. "Got in some equipment; but as is the case with first-generation gear, it wasn't suitable."

Danko is vice president of engineering and operations for Cincinnati Public Radio's WGUC(FM) and a strong proponent of broadcast surround.

His station has been recording content in a surround format for four years, a decision Danko said was made by GM Richard Eiswerth and himself. The Corbett Studio, an audio recording and production service of Cincinnati Public Radio, records the Cincinnati Symphony Orchestra concerts from their opulent Music Hall home. They later broadcast the concerts; post produced, utilizing one of the three "composite" surround encode/decode systems compatible with conventional stereo. In addition, a five-channel discrete mix, suitable for other subsequent surround applications, is recorded at the live event.

The Corbett Studio also records several other Cincinnati ensembles such as the May Festival and has created commercial releases in surround as well.

The WGUC engineering staff is building a library of discrete surround music recordings even as it airs content knowing few listeners can currently hear the complete surround effect.

Even with modern consoles and proper

monitoring, other, non-technical obstacles remain.

"We don't have an outlet for the recording," Danko said. Due to contractual obligations, WGUC can broadcast each CSO concert only once without paying additional performance rights fees to the

can do with record labels and/or other entities," he said, referring to the CSO's recording label Telarc. "We knew we'd have to come up with greater justification for the technology to show what surround could do for the CSO."

Cincinnati Public Radio and Corbett



Don Danko, standing, and Alex Kosiorek

musicians' union. Also by contract, the broadcast must be local to Cincinnati. Danko said that without underwriting, the prospect of additional broadcasts is too expensive.

"Although we're still testing the broadcast version of surround 5.1, we're looking to figure out if there's something we

Studio Recording and Mastering Engineer Alex Kosiorek has recorded the most recent season of the CSO and May Festival in stereo and simultaneously made a five-track surround-ready mix. He says he prefers to generate the stereo and surround 5.0 mixes simultaneously.

"Monitoring is not as difficult as it would seem, as we're using a Yamaha DM1000, with supplemental equipment, and we can flip between stereo monitoring and 5.0 monitoring," Kosiorek said.

He records the 5.0 mix to five separate tracks, at 24-bit resolution and an 88.2 kHz sampling rate, using Magix's Sequoia recording software. The concert recordings are brought back to Cincinnati Public Radio's Corbett Studio, where the concert itself is post-produced and program host tracks are added. Kosiorek encodes the concert into one of the composite surround systems from the five channels. He says he pays significant attention to the surround's stereo downmix during the process, so it maintains stereo integrity.

Danko says a stereo downmix is in the ear of the beholder. "One of the arguments that has been used against composite surround encoding is that the downmix doesn't perfectly represent the stereo recording. When you're the one recording the show, who's to say what the true stereo downmix should sound like? I don't think people could argue when we record the CSO what the stereo downmix should sound like, because we're the ones making the mix in the first place."

Revenue goal

Is a post-produced concert preferable to a live broadcast? In Cincinnati, at least, listeners prefer the former. Danko said the station hasn't aired live CSO concerts for some years.

"Our listeners are sophisticated and expect highly produced concerts — with no two-minute applause and hosts talking on and on to fill time, for example."

Danko says a post-produced concert allows the host to concentrate on enhanc-

ing the listener's experience through focused writing and concert details. As a consequence of the production process, the WGUC broadcast season lags behind the live CSO season.

"We air shows just prior to or during the live concert season to build enthusiasm and excitement," Danko said. Apparently the listeners respond; according to Danko, the station often uses CSO concert and Cincinnati Opera performance tickets as giveaways and listeners snap them up. Danko says the station's target demographic wants to hear the concerts — not only the CSO, but the festivals and groups that perform in the city's other venues.

The Corbett Studio itself is a revenue resource for Cincinnati Public Radio; the station offers the studio's services for clients who need production, on-location surround recording, forensic audio and restoration services.

"Cincinnati Public Radio has invested station resources in surround to gain expertise and knowledge for its clients as well," Kosiorek said. "We're trying to make the studio self-supporting. Our recording work at Music Hall when added to our in-studio clients helps accomplish that."

Useful guide

Danko says that when pondering surround production, a station must have a clear understanding of the proper equipment and proper monitoring.

Kosiorek said one of the best references he's read is available on The Recording Academy's Web site. See www.grammy.com/pe_wing/5_1_Rec.pdf. The publication is "Recommendations for Surround Sound Production," provided by the academy's Producers & Engineers Wing.

"It's a technical document about surround and offers recommended standards that have become more universal at studio facilities," Kosiorek said. "It's a large PDF document, and it is meant to be absorbed."

Danko says full-blown surround sources may not be appropriate for every type of music. "We were originally thinking 5.1, as it was the 'big' standard. But it wasn't until Alex came on board that we settled on 5.0."

Kosiorek said wryly that surround 5.0 is more appropriate for the majority of classical music, because the theatrical Low Frequency Effect (LFE) channel is superfluous — unless of course there's a car chase in one of the movements.

With three brands of surround encoders commercially available — Dolby Pro Logic II, SRS Circle Surround and Neural 5225 — Kosiorek decided to try to test all three thoroughly during the CSO broadcast season. A problem, he said, was that broadcast rights to the appropriate material allowed only one on-air play. So the station would use similar but not identical content (comparing classical to classical, folk to folk, and so on) at different times.

The informal trials are run like this: The WGUC on-air announcer takes a composite surround-encoded concert CD, created by Kosiorek, and plays it in a Sony CDP500 CD player. The digital output of the CD passes to the digital input of the on-air studio's Harris Legacy console, the digital output of which is sent to a fiber optic Intraplex transmission codec and travels to the transmitter site on an E-1 circuit.

An E-1 circuit contains 30 data channels of 64 kbps, as opposed to a T-1's 24 channels. The WGUC E-1 bandwidth is allocated to two linear audio channels, a perceptually coded radio reading service channel and a variable-rate LAN connection. Remaining

See WGUC, page 32 ►

STATION/STUDIO SERVICES

From "Hello" to "Sign Me Up" in Two Minutes Flat.

Your business is radio advertising sales. *Words* are your stock-in-trade. Your success hinges on what you say and how often you say it. Are you using the telephone to your best advantage? With a little preparation and discipline, a salesperson will cover more ground in less time using the phone. (In fact, from the moment the decision-maker picks up the phone, the entire conversation should take less than two minutes!) Time is irreplaceable and gas is expensive. The telephone is your friend. Don't neglect it! Make telemarketing a part of your overall sales practice. We can help make it easy and productive with our inexpensive, professionally produced :30- and :60-second Sales Boosters. Listeners enjoy them - and advertisers readily sponsor them. Visit our website for ideas, inspiration, and free demos.



GRACE BROADCAST SALES
Sound Ideas for Building BusinessSM

Questions? Call us toll-free (888) 472-2388.
www.gracebroadcast.com

STOP!

IF YOUR AD WAS
HERE

MANAGERS WOULD
KNOW ABOUT

YOUR SERVICES

GREAT PRICES!
CHECK WITH:

CLAUDIA 703-998-7600 ext. 154

SPACE AVAILABLE

Call Claudia For Details

1-703-998-7600 ext. 154

ATTENTION PROVIDERS!

Promote your services to **Radio World's** readers. Reach Radio Station and Recording Studio owners/managers and engineers with your message.

For information on affordable advertising
call **Claudia** at **1-703-998-7600, ext. 154.**



WorldNet Oslo makes your STL the strongest link in your digital audio air chain

MAKE YOUR **ST** LINK THE STRONGEST LINK

Introducing WorldNet Oslo from APT. Now you can have up to eight full bandwidth audio channels with low delay, cascade-resilient, Enhanced apt-X™ coding.

Each WorldNet Oslo gives you a choice of Encoder, Decoder and Duplex Audio Modules, AC and DC redundant power supplies, a flexible auxiliary data system and automatic backup. WorldNet Oslo supports 16, 20 or 24-bit Enhanced apt-X™ audio, delivering lossless audio quality with under 2ms delay.

WorldNet Oslo comes complete with an easy to use IP-based Management System so you can set up, configure and monitor your installation across town or across the globe. To see just how useful this user interface can be, download a demonstration version from www.aptx.com.

Contact us to find out what WorldNet Oslo can do for your air chain or request a demo.



Highly intuitive user-friendly interface with VU meters and programmable fault monitoring, all via IP

Features & Benefits

- Multiple Channel Audio Codec
- Designed for your STL and Studio-to-Studio Links
- Redundant Power Supplies
- Modular Architecture
- Audio over E1, T1 or Ethernet
- Up to 4 audio channels per audio card
- Up to 6 audio cards per chassis
- Analog and AES/EBU audio interfaces
- Enhanced apt-X™ coding

APT
AUDIO PROCESSING
TECHNOLOGY

Audio Processing Technology Ltd
Tel: +44 28 9037 1110
Fax: +44 28 9037 1137

Audio Processing Technology North America
Toll-free: 800-955-APT-X
Fax: 732-796-0304

Audio Processing Technology Japan
Tel: +81 (0) 3 5771 1191
Fax: +81 (0) 3 5771 1192

Email: info@aptx.com
Web: www.aptx.com

World Radio History

WGUC

► Continued from page 30
bandwidth is available for a future stereo perceptually coded audio channel.

The digital output of the Intraplex feeds an Orban Optimod 8500 processor to process the FM and HD signals and delay the FM feed to match the HD feed. The signal is then sent to a Harris Dexstar HD exciter and a Harris Digit FM exciter.

The surround signals are broadcast on the WGUC main FM channel and its 64 kbps HD Radio channel. Because broadcast radio reception has so few consumer devices that include surround decoding,

Cincinnati Public Radio happens to own a radio receiver that includes the SRS Circle Surround matrix decoder. Danko or Kosiorek uses this receiver to listen to the broadcast in surround as it airs. But Danko notes that the receiver has no indicator showing that it's actually receiving a surround-encoded signal.

No 'winner' yet

Which system sounds best? Kosiorek demurred.

Each "had significant tradeoffs and benefits. There are so many variables to each one," he said. "One system will be more robust through the broadcast chain but it 'challenges' the analog FM signal and has higher amounts of L-minus-R information.

He said the Corbett Studio, the local Audio Engineering Society Chapter and NPR recently teamed up to perform cross-compatibility tests. Results were pending in October.

Danko wonders what the listener's experience will be with compatibility. Will a single receiver simply contain chips to decode the popular surround schemes or will one system be adopted over the others?

In any event, Kosiorek said his goal is having the Corbett Studio support all recording technologies. He'd also like to be able to announce surround sound broadcasts to the public sooner rather than later. While the station has mentioned surround tests in ancillary publications, he said, surround content is not pre- or back-announced as such on the air. And, Kosiorek said, he's had no telephone calls complaining, "My stereo sounds weird."

'Do something fast'

If a station is to undertake surround recordings, Danko is emphatic that management, specifically the general manager and chief engineer, must be in total agreement and "extremely close in wavelengths" in their thinking. Otherwise, he said, the expense of acquiring equipment and the time to learn and perfect its use will be discouraging.

Danko cites a "trust loop" at WGUC in which the board of directors, the GM and the chief engineer trust each other's judgments toward achieving the station's goals.

After surround tests last year featuring recorded programs from the Cincinnati May Festival's 2004 season, station executives put out an announcement stating, "The successful trial is a noteworthy development which sets WGUC apart as the

first station in Ohio to broadcast locally produced surround sound programming."

The station also had said that when it had committed in 2001 to a major investment in surround equipment for the Corbett facility, "its focus was geared toward recording major performance ensembles and using those recordings to produce superior surround sound encoded broadcasts, CDs and DVDs."

Of the future, Danko again becomes an impatient man.

"I think we really have to come to an understanding on how we're going to implement surround. One system or all systems? AM stereo lingered and withered. We have to get on this 'craze,' get on this technology. TV and satellite providers are already using this technology. We seem to be the last ones catching on to the 5.0 or surround. We can't wait for HD Radio surround. Analog FM can broadcast surround now," he said, his voice rising with conviction.

Although WGUC has been an HD Radio station licensee since 2003, he doesn't think digital penetration will be significant soon and says it will take time to get receivers into consumers' hands.

"In five, or six, or eight years, and we look again (at surround) when HD Radio has reached a critical mass, the technology and the sound of the encoders and decoders may have changed. We need to do something fast before the listeners go somewhere else.

"We should have this completely figured out and get receivers on the market in a year."

Rich Rarey, CEA, CBNT, is the Master Control Supervisor at National Public Radio. His first surround sound recording aired on NPR's "Weekend Edition/Sunday" on Dec. 27, 1992.

Danko is emphatic: If a station is to undertake surround sound recordings, management and the chief engineer must be 'extremely close in wavelengths' in their thinking.

Kosiorek said his evaluation technique has to be more elaborate.

"The funny thing," he said, "is that we had to record it off-air and take it back to the station and listen to it over the proper decoder."

Another system has less L-minus-R problems, but less channel separation.

"The best system," Kosiorek said, "will be the least challenging to the listener and least impeding ... There's no clear-cut winner at this moment."

Today's top engineers need a reliable source of deep tech info.



**Now they have it.
Radio World
Engineering Extra**

Published six times a year, this "deep tech" version of Radio World is pure technology, with articles written by engineers for engineers—edited by an engineer active in the industry. White papers, in-depth engineering session coverage, technical op-ed and analysis articles—if it's important to radio engineers, you'll find it in Radio World Engineering Extra.

**Sign up now for your FREE subscription at:
<http://www.rwonline.com/eng-extra>**

Even if you are a Radio World subscriber, you must sign up to receive RW-EE.

MARKET PLACE

Day Sequerra Delivers First M4 Mod Monitors

Day Sequerra delivered its first HD Radio Modulation Monitor to Clear Channel Radio in New York in September. The group received the first M4 Modulation Monitors for WALK, WAXQ, WHTZ, WKTU, WLTW and WWPR.

Josh Hadden, director of engineering and IT for Clear Channel Radio, is shown with David Day, president of the manufacturer, which said Hadden noted the unit for its expandability, HD acquisition time and access to one-button analog/digital channel split feed for time alignment.

Day described development of the M4 as "a grueling process" but one worth the effort.

The company said the M4 HD Radio Tuner is the first "Tomorrow Radio Ready" broadcast-quality modulation monitor with multicast capability built in. It provides monitoring of existing analog and HD Radio AM and FM broadcast signals.

Contact the company in New Jersey at (856) 719-9900 or www.daysequerra.com.



2005 Radio World Excellence in Engineering Award



PRESENTED TO
MIKE STARLING
NATIONAL PUBLIC RADIO

APT
AUDIO PROCESSING
TECHNOLOGY

*APT salutes Mike Starling for his
endless pursuit of audio clarity.
We couldn't agree more ...*

HARRIS

*Mike, your tireless work to
advance technology, council to help craft
regulations and keen sense of humor
well qualify you. Congratulations from
your friends at Harris.*

HD Radio
Digital AM & FM

*iBiquity Digital congratulates
Mike Starling and appreciates his
leadership role in making HD Radio and
its multicasting capabilities a reality.*

COMREX

*Congratulations to one of radio's master
engineers and a champion of new
technologies, from your friends at Comrex.*

Moseley

*Moseley Associates sends congratulations
to Mike Starling on his selection for the
2005 Excellence in Engineering Award.*



*Mike, you're one
of the leading
visionaries of digital
radio implementation.
This recognition
is well deserved.*

ENCO

*Congratulations to one of the best
in public radio engineering.*



*A hearty "well done" to Mike and his NPR
colleagues from all at Heil Sound.*

ESE

*We are proud to have you in the industry.
Congratulations, Mike.*

**W. Richard Green
& Associates**

*It's a sincere pleasure to
congratulate a winner.*

ERI

*ERI congratulates Mike Starling,
winner of the Radio World Excellence
in Engineering Award.*

Radio World

*Kudos from the RW editorial staff
to a true leader among radio's
chief technologists.*

Studio Sessions

Product Guide

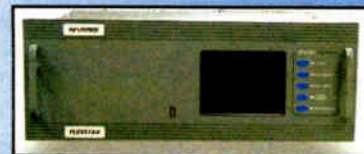

Inside

Radio World

Resource for Radio On-Air, Production and Recording

October 26, 2005

FACILITY PROFILE

Cumulus Shreveport Hangs at the Mall

Group Partners With Developer to Build Broadcast Center on Louisiana Boardwalk

by Tom Vernon

When O&S Holdings asked the Shreveport Cumulus stations if they would be interested in relocating to a new site on the redeveloped waterfront, it didn't take

way.

"It was a unique opportunity for us," said Gary Kline, corporate director of engineering of Cumulus Media. "This is the first time we've partnered with a retail developer to build a site to our specifications." The

project had in common was AutoCAD on their laptops," Kline said. "That allowed us to work quickly with the architect to revise floor plans, and then forward them to city planners for approval."

The recently completed Louisiana Boardwalk is in Bossier City, across the Red River from downtown Shreveport. Promoters say the \$190 million Boardwalk

digital audio consoles, Telos phone systems, Electro-Voice RE-20 mics and AirCorp 500 PH mic processors. Monitoring is provided by Mackie M-800 amps driving JBL4410A speakers. Backup power for the complex is provided by an emergency generator and UPS.

Each studio also has Wheatstone Preference Series studio furniture with customized wood trim and countertops cut to Cumulus design, and Denon DN-C680 CD players. Production rooms have Tascam MD-350 MiniDisc players and HHB BurnIT Plus CD recorders.

Existing Prophet Systems automation was brought over from the earlier facilities. Audio is routed by a Wheatstone Bridge router. The satellite and STL gear are located in a remote equipment room, which has a Wheatstone satellite router cage and is connected via fiber to the main rackroom. All audio sources, including the Prophet, are wired digitally into the console.

The remote equipment room also houses the processors and STL gear. Three Optimod 8200s and one Omnia-6 EX drive Harris CD Link digital STL transmitters. The entire audio path, studio to transmitter, is digital on all the FM stations. KRMD(AM) is digital up to the CRL AGC input at the remote room. The remote equipment room also houses fiber equipment to return the satellite RF to the receivers in the rack room, as well as networking and RS-232 data connections to the main rack.

The cluster uses three transmitter sites. The furthest is KRMD(FM), approximately



A view of the Louisiana Boardwalk.

long for them to make a decision.

"We had one AM and four FM facilities crammed into a renovated office building that really wasn't suitable for broadcasting," said James Kester, chief engineer for the cluster. Plans for the move were soon under-

collaboration included O&S Holdings paying for some of the construction expenses. Cumulus officials declined to reveal the budget for the project.

Software helped to expedite the planning. "One thing that everyone working on this

The Gear

Cumulus Shreveport has four FM studios, one AM studio and three production rooms. Equipment includes:

- A Wheatstone D-75 digital audio console in each production room
- Electro-Voice RE20 mics with Air Corp 500 PH mic processors
- Two Denon C680 CD Players in each studio; one each in the production rooms
- HHB CD Text BurnIT Plus in each production room
- Tascam MD-350 recorder in each production room
- Each studio and production room has a Mackie M-800 amp driving JBL 4410A monitors
- Each FM studio has a Telos One-x-Six phone system
- The AM studio has a Telos Two-x-12 phone system
- Each studio uses Audion Laboratories' VoxPro their phone call/audio editor
- Each production room has a Telos One phone system
- Wheatstone Bridge Router
- Wheatstone Preference Series studio furniture

Because of the location of its satellite and STL dishes, Cumulus Shreveport has a remote equipment room. It houses a Wheatstone Satellite Router Cage and a fiber optic link to the main rack room. This routes audio, data and Internet.

Cumulus Shreveport has three Optimod 8200s, and one Omnia 6 EX driving CD Link STLs.



George Walters of Skyline Communications aligns the STL grid antennas.

is the state's first "lifestyle center," a complex that includes outlet shopping, an entertainment "district" and riverfront dining. The center opened its doors on May 12

Located on the second floor of the entertainment district, the 10,000-square-foot Cumulus Broadcast Center includes studios of KRMD(FM), Country 101; KMJJ(FM), Urban Contemporary; KVMA(FM), Classic Soul and KRMD(AM), Super Talk 1340. A fifth station is not on the air.

The broadcast complex includes five on-air studios and three production rooms. Studios are equipped with Wheatstone D75

12 miles north of town on a tall TV tower. KMJJ operates off its own tower, 10 miles north of town. KVMA and KRMD(AM) operate from a self-supporting tower just south of downtown Shreveport, about 3 miles from the new studios. Due to the unique design of this structure, it's known as the "Eiffel Tower."

Except for repointing of STL antennas at one tower site, the work was centered on relocating studios to the Louisiana Boardwalk and did not involve the transmitter sites.

See CUMULUS, page 38 ▶

PRODUCT GUIDE

HHB Has NPL7 Battery, 80 GB Drive for Portadrive

HHB says it has upgraded its Portadrive location sound recorder by offering a higher-powered rechargeable battery and an 80 GB removable drive.

Supplied as a standard accessory with Portadrives, the 71-watt/hour NPL7 Lithium Ion rechargeable battery replaces the original 52-watt/hour NPL50, increasing continuous operation from two hours to approximately three.

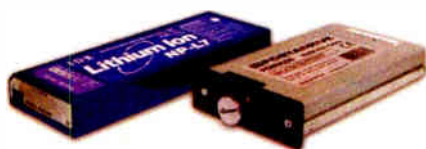

The Portadrive's power safety features provides changeover between external and internal battery power, with the supplied AC adaptor doubling as a charger for the battery when the Portadrive is not in use.

Available as an optional accessory, a new PDRDC80 80 GB removable HDD caddy can record 9.5 hours of eight-channel, uncompressed, 24-bit/96 kHz audio.

File transfer to Mac and PC-based workstations is facilitated by the PDRD-SUF FireWire/USB docking station, which is being bundled for free with the Portadrive, along with the multi-format PDRDVDBU back-up drive. A 40GB HDD caddy is supplied with the Portadrive as standard.

For more information, contact Sennheiser Electronic Corp. in Connecticut at (860) 434-9190 or visit www.sennheiserusa.com

Axia's 2.5 Software for SmartSurface Adds Processing

Axia Audio released Version 2.5 software for SmartSurface, its 16-fader studio control surface. The company says the v2.5 adds dynamic voice processing, through compression, de-essing and noise gating by Omnia, to supplement the SmartSurface three-band parametric equalization features.

The fader channels can be assigned control of any studio source in the networked studio complex for control of mixing, routing, playback, recording and editing. SmartSurface works with the Axia IP-Audio system, which enables broadcasters to build audio networks using switched Ethernet to connect multiple rooms.

Additional highlights of the v2.5 software include control of automated playout systems, improved set/save/recall functions and the ability to stop and start multiple pre-defined audio sources via a button press, which Axia says is suitable for morning or talk shows.

For more information, contact Axia at (216) 241-7225 or visit www.axiaaudio.com

VoicePro Processor Offers Human Voice Features

TC-Helicon says its professional voice recorder, VoicePro, offers an unconventional approach to producing and processing aspects of the human voice, such as character, pitch and time shift effects, harmony and doubling. Integrating VoicePro in a studio setting is possible with 24/96 analog and multi-channel AES/EBU digital I/O.

In conjunction with VoicePro shipping, TC-Helicon offers a free downloadable software editor by PSI Craft for the vocal processor. The Mac/PC editor can be loaded as a VST plug-in or standalone application. The editor requires a MIDI device to communicate with VoicePro and offers control over preset and utility parameters in VoicePro, as well as preset management.



VoicePro users can download the PSI Craft editor from at www.tc-helicon.com/editors. VoicePro retails for \$3,495. For more information, contact the company at (805) 373-1828 or visit www.tcelectronic.com.

Prophet Systems can get you to the top.

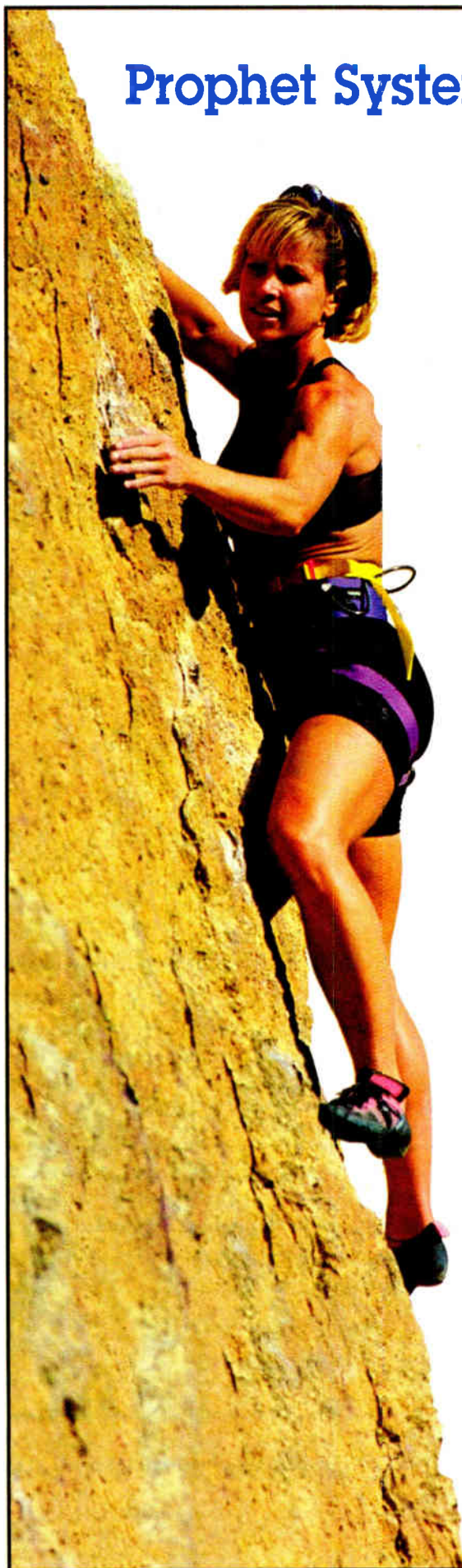

Tools that make the impossible, possible.

NexGen NexGen Digital. Stable easy to use content management for Radio and TV broadcast, providing several hardware and software configurations to scale to any size station.

XLR8R Podcast XLR8R is simple to use and is easily integrated into the workflow at a radio station. Content creation professionals now have a tool available to them to easily craft compelling, original and even experimental programming. NexGen's XLR8R enables radio stations to convert content to an MP3 podcast file six to 10 times faster than real time.

MUSIC GEN PRO MusicGen Pro, the smart, sophisticated music scheduling system for the way radio is programmed today. Top PDs have collaborated to create a powerful program which will rotate music better than any system available. It's the only music scheduling system designed to run seamlessly with NexGen. It's time to replace your old, outdated and more expensive scheduling solution.

NEWSGEN This comprehensive, standalone newsroom software enables reporters to write newscasts, receive and manipulate wire copy and digitally record, edit and playback audio. Completely scalable—from an enterprise wide deployment to a server-based system and has NexGen integration, and WANcast capabilities you come to expect from Prophet Systems.

PSI Prophet Importer - Enables advanced HD radio capabilities, like multicasting and datacasting. Stand-alone module can work with any automation system.

DigiLogger Effectively monitor multiple stations, and make those recordings available via a convenient, easy to use web-browser. And with NexGen's XML export ability, users can pinpoint audio elements and hear them exactly as they aired. Flex-skim technology means that programmers can easily maintain and monitor airchecks, without having to leave their desks.

Proven Performance from Prophet Systems.

Developed with a purpose.



1-877-774-1010
ProphetSales@prophetsys.com
www.prophetsys.com

A Compact Guide to Flash Recorders

by Paul Kaminski

The future of radio newsgathering may be contained in a stamp-sized device not much bigger than a thumbnail.

Although most serious street reporters use a combination of MiniDisc and cassette recorders to gather sound, that could well change in the next few years — perhaps sooner.

To help you manage that change before it manages you, here's an overview of how audio flash card recorders work, featuring some operational considerations that should be addressed before writing a check or taking out the plastic, and a listing of models.

Reporters need speed, reliability and functionality in the field; the Flash card recorder solves those issues.

How they work

Audio flash card recorders write (record) audio files (or tracks) to removable media called CompactFlash cards, which were made popular in digital photography and are readily available. The cards have a capacity that ranges from 32 MB to 4 and 8 GB, which is bigger than some laptop hard drives.

Depending on menu selection, the amount of audio is a function of format and sample size. The ones seen at NAB2005 will record in MP3 format, which yields hours on even the smallest CF cards (64 MB and above), and in uncompressed .WAV format, which yields better audio quality at the expense of space on the CF card.

The recorders have combinations of microphone, line and digital inputs, with provisions for automatic recording level control, manual recording level control and manual recording level control with a limiter, depending on the model. They will record CD-and-better quality audio. The recorders have no moving parts except for controls and switches. Some will fit in your pocket; most will hang comfortably off your shoulder.

Some have XLR inputs for microphones and phantom power for condenser models, some have 1/8-inch TRS jacks for microphone inputs and others have microphone input pads (-20 dB). All have some sort of built-in microphone. The units also include RCA analog or 1/8-inch TRS jacks for line inputs, and S/PDIF digital coaxial inputs and outputs.

Units are powered by AC adapters and standard AA batteries. Some have rechargeable nickel-cadmium (NiCd) and nickel metal hydride (NiMH) battery packs. I came across one powered by a cell phone battery.

Easing life in the field

These recorders can be used as stand-alone audio recorder/players, or connected to telephones, codecs and loops to send analog sound. The reporter can access the cuts using fast forward and rewind buttons — like a CD player, no shuttling of tape — and then play the cuts as needed.

Some machines will allow the reporter to set up a series of cuts in an "edit decision list," which will take advantage of random access, even across separate and contiguous tracks, and play the cuts in a defined order, which reporters do when selecting cuts of actuality for news and sports feeds. What usually takes two machines can be accomplished with one. The process is significantly faster than shuttling through analog tape.

Some units will give the capability of recording two mono tracks, one at normal volume and one at -20 dB lower. So if you



AEO's DR-100



Marantz 671



HHB FlashMic

are recording where the ambient sound level is high, you have a backup in case the main track is over modulated.

Flash card recorders have another advantage. With other formats, audio has to be recorded (rendered) in real time into the audio editing program on a laptop, then edited and prepared for transmission by file transfer protocol or e-mail. With the flash card audio recorders and their USB interfaces, the time spent rendering audio into the laptop decreases dramatically.

In the case of clean files that don't need editing, those files can be transferred or attached to e-mails just like completed audio files on a hard drive. In the case of an interview of 5 to 10 minutes, a reporter with one of these machines can be editing files within two minutes, while the competitor is rendering audio into a laptop for editing, or shuttling through analog tape to find cuts of actuality.

One other thing: the CF cards also can be inserted into card readers in other machines for access to the files. You can also transfer files by copying them to a USB jump drive, for instance.

Generally speaking, flash card recorders will cost more than cassette recorders and "prosumer/consumer" MD



Edirol's R-1



Nagra Ares BB+

recorders with microphone inputs, and less than higher-end MD recorders and DAT machines. One wouldn't classify this as a throwaway, non-depreciable recorder.

The return on investment can be measured by the time saved by a field reporter, which may translate into competitive advantage of being first to broadcast a report while the competition is still processing sound, and the time and money saved on maintenance and upgrades, some of which are available as a download from the respective company's Web site.

The recorders with XLR inputs will accept easily available XLR M-F connector cords. Those recorders with 1/8-inch TRS microphone jacks can still take advantage of external microphones as long as a connecting cord with high strength and low hang weight is used. CF cards are available almost anywhere, but like most items research yields the best price.

Most of the recorders come with a standard 64 MB CF card. The minimum

we use is 256 MB, and we keep the 64 for backup. Like anything else, more is better (at the right price).

The learning curve would likely be kind of steep for someone who's replacing a cassette machine or MD used to play sound over a phone, and less so for those of us who use a laptop in the field. Quality time with the instruction manual is necessary to take full advantage of all the available options — and it's better to do this at leisure than on deadline.

Setting record levels is important because unlike the MD, the flash card recorders don't have a lossy compression-recording scheme. But the AGC on these units will help you in a "run and gun" situation.

When you replace four and eight alkaline batteries at a time, that cost might prompt you to look closely at rechargeable batteries, whether individual or battery packs. It's been our experience that NiMH batteries last much longer. Motor Sports Radio Network has two sets of NiMH batteries that have lasted almost three years in our MD units.

Moving product

So how are they selling? John Lynch of BSW in Tacoma, Wash., sees this from two viewpoints: as a senior sales representative for the company and as a power user who produces audio projects for the Unlimited Light Hydroplane Racing Association.

"When the Marantz PMD 660 came out," said Lynch, "BSW ordered 200 of them. (The shipment) took four months to arrive. Once it did, all the units were sold within two weeks. That was one of our biggest product introductions, and we've sold units to podcasters and major chains, once they get the purchase requests through corporate channels."

They continue to be a very popular item," he said. Lynch's audio projects are recorded on flash card recorders and can be heard at www.ultra.org.

Lynch adds, "The portable cassette business has shrunk," from his standpoint. "You will still likely see reporters using cassette recorders in the field, simply because they are more familiar with them. But once those reporters leave the business, the cassette recorders they used, like on-air cart machines, aren't being replaced."

Paul Kaminski is the news director for the Motor Sports Radio Network and a contributor for CBS News Radio. His e-mail is motorsportsradio@msrp.com.

Flash Card Recorders

Several manufacturers are shipping, or plan to ship, flash-card capable audio recorders.

D & M Professional: Marantz PMD 660; Marantz PMD 670; and Marantz PMD 671; Web: www.d-mpro.com

AEO USA: DR-100; Web: www.aeqbroadcast.com

Edirol Corp.: R-1; Web: www.edirol.com

PocketRec; Web: www.pocketrec.com

Nagra USA: ARES-M; ARES BB+; and ARES PII+; Web: www.nagraaudio.com

Maycom HandHeld Recorder; Web: www.bradleybroadcast.com

HHB USA: FlashMic; Web: www.sennheiserusa.com

If your company offers a flash card recorder omitted from this list, write to us at radioworld@imaspub.com with product information.

PRODUCT GUIDE

Prophet Has Podcast Module For NexGen

Prophet Systems debuted Podcast XLR8R, a module within the company's NexGen Digital content management system, which allows stations to convert content to an MP3 podcast file and post it to a Web site for download.

Podcast XLR8R converts playlists, music and radio programming into podcast feeds, instead of manually playing back each programming element in real time to convert into podcast form. The module enables the creation of podcasts using the standard tools and equipment that are deployed for terrestrial radio broadcasts.

The company said listeners benefit from the module, too, as podcast content is available immediately and they can hear the same elements from the original radio broadcast when the podcast feed is downloaded.

For more information, contact Prophet Systems in Nebraska at (877) 774-1010 or visit www.prophetsys.com.

Soundelux Releases E47C

TransAudio Group, U.S. distributor for Soundelux Microphones, debuted the manufacturer's E47C tube condenser microphone, which recreates the "cardioid only" characteristics of the original 1950s-era German tube 47, which the company says typically was used almost exclusively in that mode.



Like the original, the E47C displays a proximity effect suitable for close-worked male and female vocals. It features a NOS Telefunken Large Plate EF814k tube for vintage amplification and dynamics response, a P99E power supply, custom 20-foot Soundelux cable between the power supply and mic, and a 47 suspension clamp-type shockmount with wood box.

Replacement parts are available. For more information, visit www.transaudiogroup.com.

How to ...

Submit a letter to the editor:

E-mail us at radioworld@imaspub.com with "Letter to the Editor" in the title field.



Change your mailing address: Visit www.rwonline.com, click on Subscribe to RW and follow instructions to change a subscription address.

DaletPlus Integrates With Newsroom Systems

DaletPlus Radio Suite is a broadcast and asset management system for digital radio operations. Dalet Digital Media Systems says the product facilitates audio and newswire acquisition, search and retrieval and production and script editing with embedded audio, in addition to scheduling, broadcast and archiving.

The system features automatic capture via scheduled ingest or manual recording tools, and plays and edits audio material while recording. There is support for multiple audio formats and bit rates. The system is compatible with Soundblaster and Digigram audio cards.

Highlights include simultaneous broadcast over media outlets such as DAB and the Internet; and integration with newsroom computer systems other than DaletPlus, like Dalet OpenMedia or ENPS.

The AudioRecorder feature records up to eight simultaneous channels per workstation, and has tape deck-style controls to record, pause and fast-forward. Auto-Trim erases beginning and end silences. Cue points and markers are user-determined, as are default mix parameters for auto-segues.

ActiveLog is for scheduled recordings and logging for large-scale ingest. Features include immediate access to captured material while recording, a scheduling calendar that automates multiple recording sessions and support for multiple bit rates and mono and multitrack audio.

DaletPlus OnAir offers a user interface and layout that can be configured to the needs of a broadcast studio or studio operator.

The DaletPlus NewsDepot plug-in is suitable for collecting field contributions by phone or ISDN, and MediaWall is suitable for live desktop monitoring of incoming audio and video feeds.

For more information, contact Dalet Digital Media Systems USA at (212) 825-3322 or visit www.dalet.com.

We're changing the face of RADIO ENGINEERING...

Imagine an incredibly intelligent diagnostics solution that monitors your station 24 hours a day, so if an unexpected problem arises, you already know about it. Even if you're not at work. Our one-of-a-kind Diagnostics Solution alerts you in advance (using activity thresholds defined by you) should your on-air system exhibit a potential problem. It's the ideal add-on to your new or existing Scott Studios or Maestro digital automation system.

dMarc's Diagnostics knows which activities are normal and which are not, and it knows when and how to send alerts to just the right people. Prevent serious malfunctions, partial shutdowns or even dead air. All this from a single, easy-to-use Management Console so flexible it can monitor a single station or an entire network.

The price is right, too. (Free!) Call or email us for details on how this critical diagnostics solution can be yours without investing a single dime. Our Quick Response Email Hotline is diagnostics@dmarc.net or call Toll Free 888-438-7268.

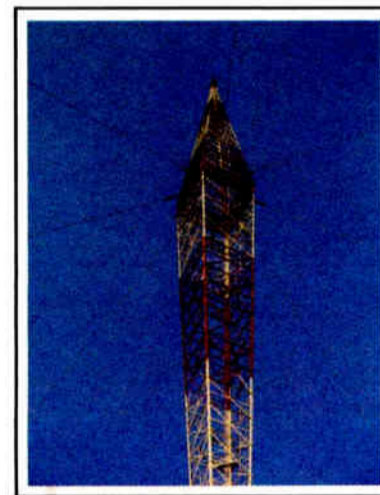

...ONE STICK at a time.

Ph. Toll Free **888-438-7268**

E-mail: diagnostics@dmarc.net

Scott Studios **Maestro**
Scott Studios and Maestro are Product Lines of dMarc

dMarc
 INNOVATION
 THROUGH AUTOMATION

www.dmarc.net

DIAGNOSTICS | DATASERVICES | SARBANES-OXLEY | REVENUESUITE

Cumulus

▶ Continued from page 34



KVMA(FM) and KRMD(AM) operate from a self-supporting tower (left) three miles south of the new studios in Shreveport. Its design earned it the nickname, 'Eiffel Tower.'

Planning for the project began in January and the move was completed in early June.

Skyline Communications Inc. of Indianapolis installed studio trunk cables,

of Claysburg, Pa., installed the punch-blocks and rack trunk cables in the rack room, assembled the furniture and mounted the consoles and Wheatstone-supplied console prewire.

Project Manager Dave Supplee, Cumulus Northeast regional engineer, did the rack room cross-connects and rack audio wiring. Gary Zocolo, Cumulus engineer from Youngstown, Ohio, with Market

All studio consoles are new with the exception of a Radio Systems Millenium console in the newsroom. The existing Prophet CFS automation was retained, as well as some microphones, mic processors, telephone hybrids and satellite receivers.

Wiring the remote room presented some challenges. One of the goals was to isolate the room from the rest of the plant, and even though it was a short 200-foot run, fiber was used for all interconnects between the two. This required a run of multi-mode and a run of single-mode fiber. The multi-mode handles the Bridge router, RS-232 and IP network. The single mode is used to transport RF from the two satellite dishes LNBs to the various receivers in the main rack room.

No project is without its glitches. Supplee notes that construction delays created numerous logistical problems. Equipment arrived when there was no secure location. Building construction was still taking place when the Cumulus crew was scheduled to do its work.

At the last minute, it was discovered that the crew could not use a crane to lift the satellite dishes and ballast to the rooftop. This necessitated hauling them by hand, a great deal of additional labor by the Cumulus crew and Skyline Communications.

The plant was designed for easy, sim-

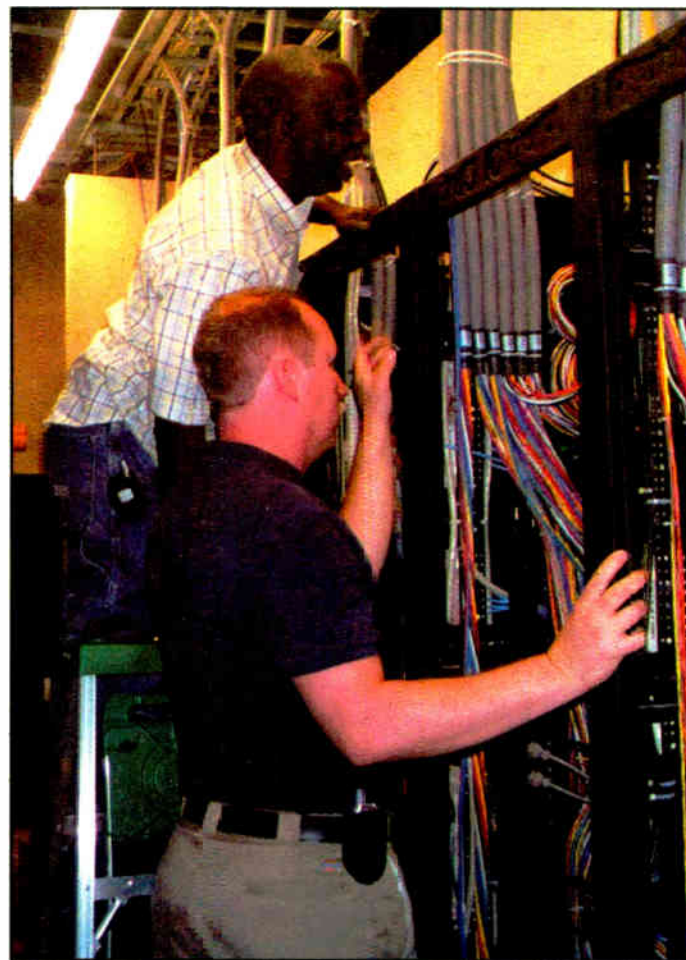

Hal Stinnett, assistant chief engineer, and James Kester, chief engineer of the Shreveport-Bossier City cluster, work on installing equipment in the racks.

ple changes to accommodate future programming needs. Studios are wired in a consistent manner, i.e., digital program out appears on all studios in the same location on that studio's trunk block. Documentation also is straightforward. Excel spreadsheets make it easy to keep documentation current.

Supplee said that the build made extensive use of the Wheatstone Bridge Router's capability.

"The 40 analog and 24 digital inputs, 24 analog and 40 digital outputs gave us the ability to minimize wiring for satellite equipment and flexibility for almost anything foreseeable," he said. "Wheatstone's software also allows us to limit visibility of sources/outputs to the end user — they only see what they need."

"We also made extensive use of prewire items from Wheatstone," he said. "All consoles, except the Radio Systems Millenium, were prewire, and most of the furniture came with the blocks pre-mounted in the wiring cage in the furniture. We also used the Wheatstone remote announcer and Headphone panels, also prewired on the panel end."

Other timesavers included premade cables from Prophet, and Broadcast Tools COP and COA interfaces

Despite glitches and construction delays, the technical project on-site time was approximately 12 weeks. The Cumulus staff was able to build nine studios in seven weeks. Fortunately, the subsequent hurricanes that swept the Gulf Coast region this year left the facility undamaged, according to Supplee.

While Kline is not sure if stations relocating to malls will become a trend, he is enthusiastic about the idea of partnering with developers for studio builds in the future.

"If the deal is right, we'd definitely look at doing this again."

Tom Vernon is a frequent contributor to Radio World.

This is the first time we've partnered with a retail developer to build a site to our specifications.

— Gary Kline

racks, IT wiring and fiber remote equipment room, as well as the STL antennas and satellite dishes. Lightner Electronics

Chief James Kester and Kester's assistant Hal Stinnett completed wiring and installation of studio gear.

United States Postal Service
Statement of Ownership, Management, and Circulation

1. Publication Title: **Radio World**

2. Publication Number: **0274-8041**

3. Filing Date: **30-Sep-05**

4. Issue Frequency: **Bi-Weekly**

5. Number of Issues Published Annually: **32**

6. Annual Subscription Price: **FREE**

7. Complete Mailing Address of Known Office of Publication (Not printer) (Street, city, county, state, and ZIP+4):
IMAS Publishing (USA) Inc
5827 Columbia Pike, Third Floor
Falls Church, VA 22041

Contact Person: **Robert Green**
Telephone: **703-908-7800**

8. Complete Mailing Address of Headquarters or General Business Office of Publisher (Not printer):
IMAS Publishing (USA) Inc
5827 Columbia Pike, Third Floor
Falls Church, VA 22041

9. Full Names and Complete Mailing Addresses of Publisher, Editor, and Managing Editor (Do not leave blank):
Publisher (Name and complete mailing address):
John Casey
72 Jefferson Drive
Hudson, OH 44238
Editor (Name and complete mailing address):
Paul J. McLane
P O Box 1214
Falls Church, VA 22041
Managing Editor (Name and complete mailing address):
None

10. (Do not leave blank. If the publication is owned by a corporation, give the name and address of the corporation immediately followed by the names and addresses of all stockholders owning or holding 1 percent or more of the total amount of stock. If not owned by a corporation, give the names and addresses of the individual owners. If owned by a partnership or other unincorporated firm, give its name and address as well as those of each individual owner. If the publication is published by a nonprofit organization, give its name and address.)
Full Name: **IMAS Publishing (USA) Inc**
Complete Mailing Address: **P O Box 1214, Falls Church, VA 22041**

11. Known Bondholders, Mortgagees, and Other Security Holders Owning or Holding 1 Percent or More of Total Amount of Bonds, Mortgages, or Other Securities. If none, check box None

12. Tax Status (For completion by nonprofit organizations authorized to mail at nonprofit rates) (Check one)
The purpose, function, and nonprofit status of this organization and the exempt status for federal income tax purposes:
 Has Not Changed During Preceding 12 Months
 Has Changed During Preceding 12 Months (Publisher must submit explanation of change with this statement)

13. Publication Title: **Radio World**

14. Issue Date for Circulation Data Below: **26-Sep-05**

15. Extent and Nature of Circulation

a. Total Number of Copies (Net press run)		Average No. Copies Each Issue During Preceding 12 Months	No. Copies of Single Issue Published Nearest to Filing Date
(1) Paid/Requested Outside-County Mail Subscriptions Stated on Form 3541 (Include advertiser's proof and exchange copies)			17902
(2) Paid In-County Subscriptions Stated on Form 354 (Include advertiser's proof and exchange copies)		8512	10088
(3) Sales Through Dealers and Carriers, Street Vendors, Counter Sales, and Other Non-USPS Paid Distribution		0	0
(4) Other Classes Mailed Through the USPS		0	0
C Total Paid and/or Requested (Sum of 15b (1), (2), (3), and (4))		8512	10088
d. Free Distribution by Mail (Sum of 15c (1), (2), and (3))			
(1) Outside-County as Stated on Form 3541		34	12
(2) In-County as Stated on Form 354		147	12-1
(3) Other Classes Mailed Through the USPS		0	0
e. Free Distribution Outside the Mail (Carriers or other means)		301	294
f. Total Free Distribution (Sum of 15d and 15e)		807	1547
g. Total Distribution (Sum of 15c and 15f)		9319	11635
h. Copies not Distributed		25	25
i. Total (Sum of 15g and h)		9344	11760
j. Percent Paid and/or Requested Circulation (15c divided by 15g, times 100)		89.6%	89.4%

16. Publication of Statement of Ownership: Publication required. Publication not required.

17. Signature and Title of Editor, Publisher, Business Manager, or Owner: *[Signature]* **4-Oct-05**

I certify that all information furnished on this form is true and complete. I understand that anyone who furnishes false or misleading information on this form or who omits material or information requested on the form may be subject to criminal sanctions (including fines and imprisonment) and/or civil sanctions (including civil penalties).

Instructions to Publishers

- Complete and file one copy of this form with your postmaster annually on or before October 1. Keep a copy of the completed form for your records.
- In cases where the stockholder or security holder is a trustee, include in items 10 and 11 the name of the person or corporation in whom the trustee is acting. Also include the names and addresses of individuals who are stockholders who own or hold 1 percent or more of the total amount of bonds, mortgages, or other securities of the publishing corporation. In item 11, if none, check the box. Use blank sheets if more space is required.
- Be sure to furnish all circulation information called for in item 15. Free circulation must be shown in items 15d, e, and f. Item 15h, Copies not Distributed, must include (1) newspaper copies originally stated on Form 3541, and returned to the publisher (2) estimated returns from news agents, and (3) copies for office use, leftovers, spoiled, and all other copies not distributed.

If the publisher has Periodicals authorization as a general or requester publication, this Statement of Ownership, Management, and Circulation must be published; it must be printed in any issue in October or, if the publication is not published during October, the first issue printed after October.

In item 16 indicate the date of the issue in which this Statement of Ownership will be published.

Item 17 must be signed.

Failure to file or publish a statement of ownership may lead to suspension of Periodicals authorization.

PS Form 3825, October 1999 (Reverse)

Products & Services SHOWCASE

AM Antenna Solutions



LBA Tunipole™
Folded Unipole Systems



RF Components



Vacuum Capacitors



Diplexer, Triplexer and
Phasor Systems

Sold Here!

**Reach further –
sound better!**

LBA Technology, Inc. is your proven supplier of innovative, digital-ready AM antenna systems. Our products include tuning units, phasing systems, multiplexers, AM/wire-less isolation systems and components for every power level. We help hundreds of broadcasters in the USA and worldwide to --

LBA Technology, Inc.

3400 Tupper Drive, Greenville, NC 27834

800-522-4464 / 252-757-0279 / Fax 252-752-9155 / Email Lbotech@Lbagroup.com / www.Lbagroup.com



LBA
Since 1963

Mini Mix 8A

Proven...Affordable...

Reliable.



AUTOGRAM

800.327.6901

www.autogramcorp.com

Efficient

Effective

Affordable

RADIO WORLD'S
Products and Services Showcase
provides a perfect medium for
marketing your products and services.

For more information, contact
John at 330-342-8361 (Eastern US)
or Dale at 916-721-3410 (Western US)
to request a media kit.

Radio World



Simply Simple.

Call or visit us online

SEMICONDUCTORS | PASSIVES | INTERCONNECTS | POWER | ELECTROMECHANICAL | TEST, TOOLS & SUPPLIES



New Products
New Technologies
New Suppliers
New Catalog Every 90 Days!

MOUSER
ELECTRONIC

a TI company

(800) 346-6873
www.mouser.com

Mouser® and Mouser Electronic® trademarks of Mouser Electronics, Inc.

New! StudioDrive-USB!

Use StudioDrive's new **USB MicroSound** option for a quick and easy connection to your PC or laptop. You'll get superb digital audio...and no soundcard is needed. Just load your editing or automation software, plug in the USB cable, and go!

StudioDrive with USB is perfect for

- Newsroom
- Production suite
- Emergency studio
- Desktop automation
- Self-contained remotes

Now in stock at all
Henry Engineering dealers.



We Build Solutions

626-355-3656
henryeng.com



USB easy!

StudioDrive shown with optional Desk-Mount Kit.

Buyer's Guide

More User Reports



Inside

Radio World

Automation & Digital Storage

October 26, 2005

USER REPORT

NextMedia Likes NexGen Voice-Tracking

by Michael Dinger
Chief Engineer
NextMedia Chicago

JOLIET, Ill. When I arrived at this job a year and a half ago, the stations were limping along on an aging DOS-based DCS system. The hardware was mostly original and I was constantly battling failures.

In the first nine months, I probably replaced half of the hard drives. Some of them were even still the old boat-anchor-size, 5-1/4-inch models. It was time for the system to be not only updated, but replaced. It was actually costing us revenue with all of the failures.

I was familiar with Prophet Systems' NexGen, having used it at my former locations, so I suggested we get it for our sites here.

Prophet sent a sales team by for a demo when they were out on a tour of the Midwest. When the air staff saw the voice-tracking screens and how you could slide each element around for the "flow" you wanted, that sealed the deal. Prophet it was going to be.

Because the operation is run out of two distinct sites, it was decided we would do WERV in Aurora, Ill., first as it is an FM standalone with no special requirements.

The system can be configured in several ways. Even our two sites are different. WERV, a single-station site, is just using peer-to-peer. The control room machine also acts as the server for the system, which includes two production rooms.

For the Joliet cluster of four stations and two production studios, we went with a full-blown Windows 2003 server.

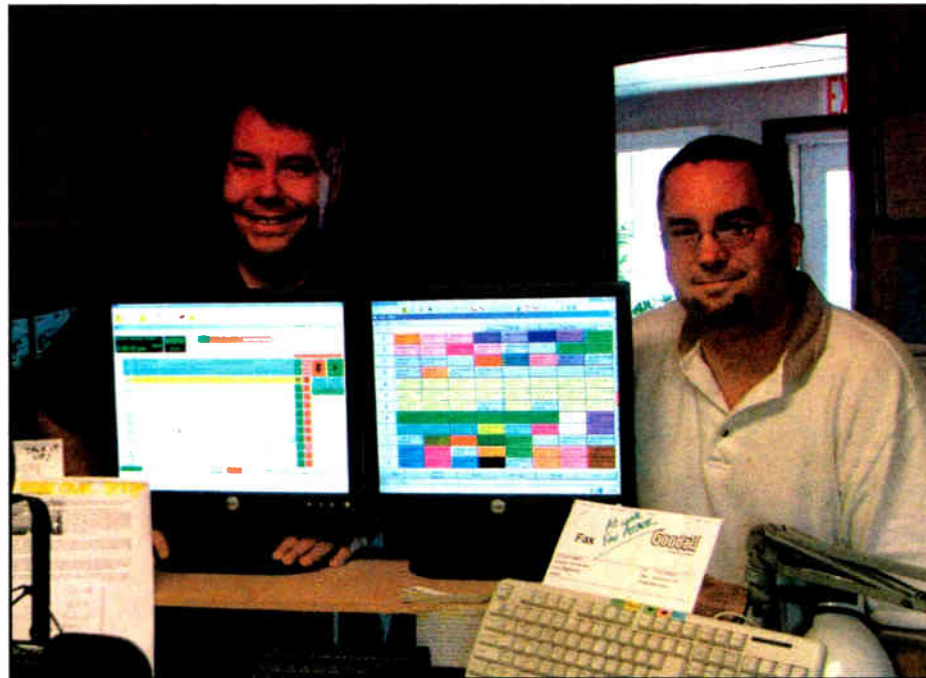

NextMedia Chicago Interim PD Scott Childers, left, and Michael Dinger with the Prophet NexGen system

The system also can work with just about any audio card. As long as there is a Windows XP driver for it, it will work.

We had some budgetary restrictions so we decided not to use the AudioScience cards that Prophet normally packages with its hardware, choosing the Echo Layla instead. This probably saved us about \$1,000 per computer. The major difference is the AudioScience cards perform the MPEG compression in hardware, while using the Laylas requires the compression to be done in software.

The control room interface is intuitive. One window displays the active log

are accessible through hot keys on the keyboard; and the "wall of carts," with 96 buttons and the source and relay controls.

In order to make the best use of the desktop real estate, though, two monitor screens are recommended. That way the active control room log is always visible and the other screen can display the button bars and other functions.

Wancasting

One feature the production guys love is Wancasting.

NextMedia has 12 stations in suburban Chicago and a sales person dedicated to selling all 12 as a regional buy. The production director in Aurora usually handles the duties for these spots and really loves the fact that he can load a spot in Aurora, hit Send when finished and minutes later it is available at the other site.

By the end of this year, only one of the suburban Chicago locations will not be on NexGen, and it will likely be converted in the next year or two.

Wancasting does require either a dedicated data link between sites or a VPN connection. We are using VPN over some inexpensive routers and it works well.

The only negative we've noticed is not

The production guys love the Wancasting feature. ... The production director in Aurora loves that he can load a spot, hit Send when finished and minutes later it is available at the other site.

where, depending on the permissions assigned, the user can add, delete or change any item. Other optional windows include the button bar, with buttons that

Prophet's fault but Microsoft's. Our file standard is MP2, 4.5:1 compression, 44.1 kHz sampling. There is a confirmed computational bug in the Microsoft media player when playing back files in MP2 format.

NexGen uses an API to media player when using software compression. The bug manifests itself as a high-pitched whine in low spots in the music or a background noise behind voice. Our experiments have shown this does not occur when uncompressed PCM or MP3 is used.

Our solution is to reload the elements in uncompressed PCM that are the most egregious offenders with the goal of moving to all uncompressed as time goes on. This will have other benefits. WERV and WSSR are in HD now, and the fewer times the audio goes through the MPEG grinder the better. Had we gone with the AudioScience cards, it would not be an issue as the compression is handled by hardware on the audio card rather than software. (The source for this information is www.orban.com/orban/products/stream/1020_codecs.html.)

For more information, including pricing, contact Prophet Systems in Nebraska at (877) 774-1010 or visit www.prophet-sys.com.

TECH UPDATE

RCS Master Control Adds Auto-Scheduling

RCS says its Master Control is a "Selector-smart" automation system with added automatic and integration features that help stations streamline daily air studio operations such as auto-scheduling and auto-traffic integration.

Before a program log is about to run out, the auto-scheduling feature goes into the Selector music scheduling and Linker promo scheduling software and generates the program log of spots and promos using the proper clocks for each daypart, including the most current traffic log.

The auto-traffic integration feature enables Master Control to grab the latest traffic log and add it to the on-air schedule at a specified time.

RCS says on-air operators will benefit from studio tools in Master Control such as instant audio Hot Keys, Living Log, Segue Editor, "Real Feel" Voice Tracking and the Log-Linked Web Browser. Additionally, the Internet Voice Tracking feature lets air talent insert content from a Windows computer with a sound card and microphone.

For more information, including pricing, contact RCS Inc. in New York at (914) 428-4600 or visit www.rcsworks.com.



Master Control's Internet Voice Tracking feature lets air talent insert content from a Windows computer with a sound card and mic.

WNYC Produces With D.A.V.I.D.

by Angelo Bello
Digital Audio Network Engineer
New York Public Radio
WNYC and WNYC(FM)

NEW YORK Imagine a digital audio system that can integrate into the specific requirements of your network architecture; incorporate audio files of various formats and bit rates with drag-and-drop; sort through audio files on the fly with point-and-click; and streamline interdepartmental communication. **D.A.V.I.D. Systems'** Digasystem has provided us with a solution that meets these criteria and benefits us here at New York Public Radio.

WNYC and WNYC(FM), broadcasting from the heart of New York's financial district, are America's most-listened-to public radio stations. In addition to feeds from National Public Radio and Public Radio International, WNYC uses D.A.V.I.D. Systems to create podcasts from our local programming, including "NPR's On the Media."

Quick and nimble

The flexibility of D.A.V.I.D. Systems has made WNYC more agile in the way we manage our on-air content. D.A.V.I.D. Systems maximizes our resources, helping us with operations such as time-shifting network shows, maintaining program choices during pledge drives and organizing news content.

For example, "Car Talk," an hour-long show fed by NPR at 10 a.m. on Saturday, is scheduled on WNYC at 11 a.m. The quick turnaround from recording to playback would be too tight for many operations or would cause stress and a probability of on-air mistakes. With D.A.V.I.D. Systems, audio files can be played back and edited at any time even if the file is still being recorded.

The automatic ingest features of D.A.V.I.D. Systems are precise so we're able to divide NPR's feeds of "Morning Edition" into three distinct segments every hour. This allows us to cover a "Morning Edition" segment with a local feature produced by one of our reporters and still broadcast the network content later. This feature is useful during pledge drives because it gives the board ops the discretion to pick the most compelling segments of "All Things Considered," for example, and start them when it suits the station, not the network. During routine network programming, D.A.V.I.D. Systems automation features allow the board operators to concentrate on production work, not babysitting the board.

The newsroom is a tremendous benefit of the system as well. Using flags and metadata, producers can clear actualities and packaged reports for broadcast during specific programs. A row of quick selection buttons located on a toolbar in the on-air application allows the board ops to call up news material that producers have designated for specific programs on certain air dates. This prevents them from having to hunt and peck through sound that is not relevant to their needs.

Integration and efficiency

The integration of D.A.V.I.D. Systems in the organization extends beyond the realm of news and programming. For security and performance reasons, we have set-up VLANs for our different workgroups that allow us to organize networks based on function and not physical location.

D.A.V.I.D. Systems' open architecture incorporates information from our Marketron traffic system, shares content back and forth with ProTools and audio files are pushed to the Web team for the creation of podcasts.

An audio file of any kind on the office VLAN can be moved over to D.A.V.I.D. Systems, eliminating any kind of sneakernet file sharing.

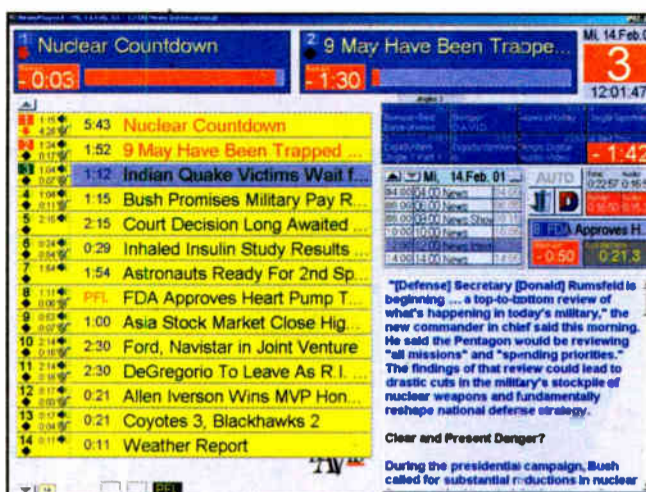

One of our Podcasts is a weekly production called "New York Edition." It's a compilation of features produced by WNYC and inserted into "Morning Edition" and "All Things Considered." During the week these features are put in a folder in the Database Manager with drag-and-drop. A host records introductions to each part of the program and an engineer assembles it into a finished production. D.A.V.I.D. Systems even converts the file into the MP3 format with the appropriate bit rate automatically.

D.A.V.I.D. Systems also is being employed for our archiving endeavors. It allows us to automatically record audio and assign it a "pleas archive" icon. Our archivists locate the audio to be saved and use D.A.V.I.D. Systems to burn CDs.

For more information, contact D.A.V.I.D. Systems in Arlington, Va. at (888) 374-3040 or visit www.digasystem.com.

This is your program material and data.



This is your current STL.



Looks like you've got a problem. Big Pipe is your solution.

Big Pipe is not just another studio-transmitter link. With scalable bidirectional capabilities up to a whopping 45 Mb/s, you can interchange analog and digital audio, HD Radio data, Ethernet, serial data, video, and telephony via a wireless or wireline path. Scalable, flexible, and reliable, Big Pipe works just as well for studio facility interconnects and many other media transport needs. Because it comes from BE, you know that Big Pipe is designed for the realities of radio, including tight budgets and rock solid performance.



Broadcast Electronics, Inc. • 4100 North 24th Street, P.O. Box 3606, Quincy, Illinois 62305-3606
 Telephone: (217) 224-9600 • Fax: (217) 224-9607 • E-Mail: bdcast@bdcast.com
Broadcast Electronics and the BE logo is a registered trademark and Big Pipe is a trademark of Broadcast Electronics, Inc. HD Radio is a trademark of iBiquity Digital Corporation.

USER REPORT

'04 Hurricanes Yield Automation Upgrade

Fla. Broadcaster Replaces OMT's 16-bit iMediaTouch 2000 With 32-Bit Version

by **Ballard F. Fore, Jr.**
Director of Engineering/MIS
Treasure and Space Coast Radio
WGNX(FM)/WGYL(FM)
WOSN(FM)/WTTB(AM)

VERO BEACH, Fla. When we began our search for a new automation system, we decided it would be state-of-the-art, user-friendly and backed by a reliable service department. After evaluating the available systems, we went with OMT's iMediaTouch — a wise decision on our part.

We've now entered our seventh year of operations with the iMediaTouch automation; the software and service have exceeded our expectations.

We implemented an iMediaTouch system designed to service two stations, WPAW(FM) and WOSN(FM). At the time, two Compaq/HP Central File servers networked two Air Studios running the iMediaTouch 2000 On-Air software with Broadcast Tools SS8x2 switchers, and on-air audio was delivered through Antex LX-44 audio cards. The two production rooms featured Compaq workstations using Cool Edit Pro and the

Transcoder, for high-speed file importing, exporting and CD ripping. The audio library was pristine. The codec-based



Ballard Fore with Treasure and Space Coast Radio's iMediaTouch system.

iMediaTouch MediaDisk32 Pro software.

Our Vero Beach stations were some of the first radio facilities in America to use the iMediaTouch embedded software,

iMediaTouch software, which includes MP2, MP3, WMA and WAV codecs, allowed our production personnel to import linear WAV audio from Cool Edit

Pro and convert it to MPEG2 into our system in seconds.

Programmers and traffic staff could perform Transcoder functions at their desktops using conventional computers with no special audio cards.

We also used two OMT's iMediaBGR Background Recorders for time-shift recording and long file audio playback of satellite-received programming. In fact, our engineering and programming personnel helped OMT write the specifications for the ability to stretch and shrink stop sets for tight satellite breaks using the iMediaTouch codec playback engine.

OMT delivered the Stretch-Shrink audio feature in less than six weeks from the date of our specification submission. We required no changes to our audio cards or computer hardware for the feature to work.

Another feature we liked was the networked and user-shared audio, which was touted as not possible by industry standards at the time. With today's popular audio-over-IP consoles and router trends, the transition of our iMediaTouch system to a LAN network-based audio and router AOIP system will be a breeze, as iMediaTouch has been a proven network streaming performer since its installation.

Weather resistant

We enjoyed the software aspect of iMediaTouch, but the service we needed most has been crucial to our operations

See OMT, page 44 ►

USER REPORT

Nassau Likes SS32's Comm Module

dMarc's Add-On for System Has Sarbanes-Oxley, Data Services, RevenueSuite, Diagnostics

by **Jeffrey Smith, CEA, CBNT**
Director of Broadcast Systems
Nassau Broadcasting Partners

PRINCETON, N.J. Nassau Broadcasting has been using Scott Studios automation systems since the mid-1990s with much success. We began our transition to the SS32 system from the SS/PB DOS system in early 2000, and have now installed or plan to install SS32 systems in the 54 radio stations Nassau Broadcasting owns or operates.

Our on-air talent and production personnel have been big fans of the user-friendly nature of the system. The GUI the operators use is intuitive. Our engineers appreciate how easy the configuration menus are to navigate and how much power the system has. We have yet to find an application it cannot handle, doing live assist, voice tracking and full satellite automation without any issues.

Diagnostics

Nassau Broadcasting has had a long relationship with Scott Studios; so when it was announced in October of 2004 that the company was being acquired by dMarc Broadcasting we naturally had some concerns. The acquisition turned out to be a smooth one; the sales and support staff at Scott Studios would not be changing, and dMarc had some great ideas for how to enhance the existing product.

One of the most exciting "add-ons" from dMarc was a Comm Module for the SS32 system. The module contains four parts: Sarbanes-Oxley, DataServices,

RevenueSuite and Diagnostics. The latter three we use extensively.

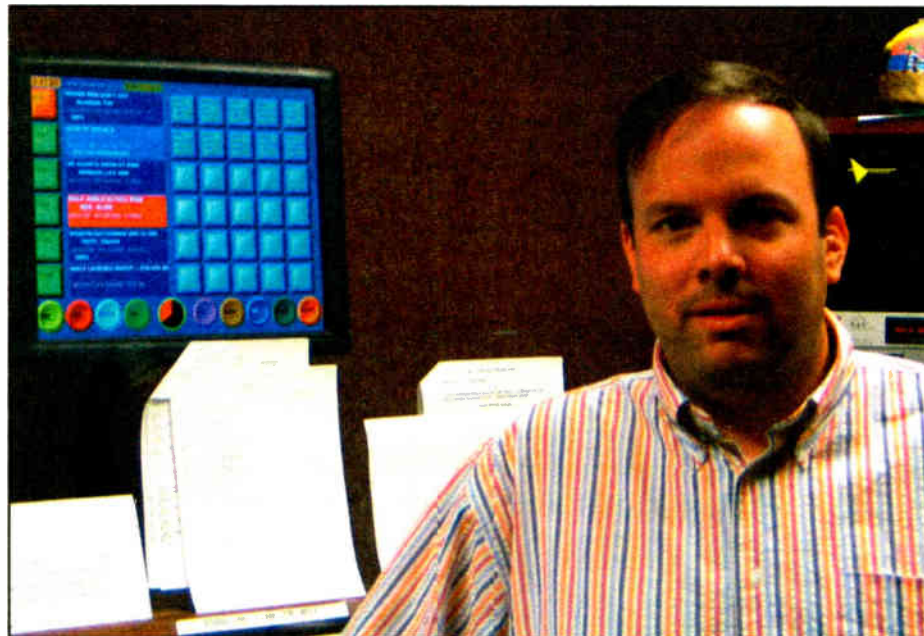

Jeff Smith with Nassau Broadcasting's SS32.

The Diagnostics section allows us to monitor critical aspects of the SS32 computer performance, such as drive space, memory usage and CPU usage. It has the ability to page an engineer when drive space gets critical or the system goes down. It also has a graphic display of drive usage and shows you the hardware used in each system. All this is a big help with preventive maintenance and troubleshooting.

The Diagnostics section also allows us to view these features from a secure Web site.

The DataServices section enables us in configuring our RDS encoder units. It supports the Burk RDS Master, Audemat-Aztec FMB80 and the Inovonics 711 and 712. The secure Web site allows you to point and click your

way through the setup. Connect to the encoder via IP to the Internet and it is ready to go.

The site also allows you to configure different campaigns to run via RDS, so users can set up special displays for advertisers or promote events when a certain song plays. It was easy to set up and was a great addition for us, now that it supports the four major RDS encoders on the market.

The RevenueSuite section was by far the biggest hit with Nassau Broadcasting's

GMs and sales managers. This feature allows you to fill unsold inventory with national advertising provided by dMarc. In return for agreeing to air these spots, dMarc will pay the station a percentage of the revenue from each spot.

RevenueSuite allows you control. We can decide when we want to make spots available, if at all, each day. Spots can air during any daypart, as often or as little as we desire. We have really started to see profits from what otherwise would have been unsold inventory.

The spots are inserted automatically by dMarc so it does not tie up our production department and each spot can have the same ID number, so it is easy for the traffic department. We can monitor what spots are going to play, as well as what spots have played from the dMarc Web site. We also can view and print daily, weekly, monthly and quarterly revenue reports for each station or the entire company from the secure site.

The spots that dMarc sends have gotten better with time; the company now has a strong team in place and enough affiliates signed on with RevenueSuite that the spots will get even better. We have spoken to dMarc about varying spots by format. This would be a great improvement for dMarc, as some of the current spots do not work well on "hotter" formats.

Even with that issue, we are glad we signed on from the beginning.

S.O.

The Sarbanes-Oxley section allows us to secure the aired logs generated by the SS32. It locks the file in such a way that it cannot be tampered with.

The secure web site provides an executive view of station encryption status for stations associated with a group in real time. A centralized log also is kept for each station, which shows the time and

See SS32, page 44 ►

The world's best-sounding POTS codec.



At Telos, we're obsessed with quality audio. We were the first to marry DSP with broadcast phone hybrids to achieve clean, clear caller audio. We invented Zephyr, Earth's most popular way to send CD-quality audio over ISDN. And now our DSP experts have built the **best-sounding POTS codec ever** — **Zephyr Xport**.

Instead of proprietary algorithms, we chose **MPEG-standard *aacPlus***[®], the same coding used by XM Satellite Radio, Digital Radio Mondiale, Minnesota Public Radio, Apple Computer and many others to deliver **superior audio at low bit rates**. (An optional ISDN interface lets Xport connect to Zephyr Xstream with Low-Delay MPEG AAC, or with nearly all third-party ISDN codecs using G.722.)

There's no need for a studio-side POTS line. Your studio's Zephyr Xstream receives Xport's POTS calls via its existing ISDN line, **eliminating the cost of a second POTS codec** and delivering smooth, clear digital audio to your listeners.

And Xport **makes unexpected modem re-training extinct** thanks to custom DSP algorithms that extract stable performance from even marginal phone lines. Xport gives you **surprisingly clean 15 kHz remote audio at bit rates as low as 19 kbps**.

No wonder clients tell us Zephyr Xport is the world's best-sounding POTS codec. But don't take their word for it — hear it for yourself.

Zephyr Xport: **It's all about the audio.**



Two-input mixer with sweetening by Omnia, switchable Phantom power, and send / receive headphone mix make life on the road easy.



Ethernet port isn't just for remote control: feed PCM audio right into the codec from any Windows™ laptop. Great for newsies on the go.



Xport's *aacPlus* and Low-Delay MPEG AAC deliver superb fidelity. G.722 coding enables connections with 3rd-party codecs, too.



Xport lets you easily send and receive audio using a cell phone headset jack. Gives a whole new meaning to the phrase "phoning it in."

Telos
AUDIO | NETWORKS

telos-systems.com

OMT

► Continued from page 42 over the last two years.

In September of 2004, Hurricanes Frances and Jeanne decided to pay the Treasure Coast a visit. Power was out for a total of 28 days, and our studios were on generator for the entire time with no air conditioning within the buildings. The iMediaTouch continued to work smoothly on our No. 1 adult standards station 97.1 OCEAN FM under the most adverse operating conditions, 100+ degree heat.

Unfortunately, our stations continue working out of temporary studios as negotiations continue one year later with our insurance company to repair

the extensive damage to the roof and interior contents of our building. And most recently, a SCSI drive failed in revealed the system would have to be upgraded from the iMediaTouch 2000 16-bit Windows-based version.

Power was out for 28 days, and our studios were on generator with no air conditioning ... The iMediaTouch continued to work smoothly under 100+ degree heat.

our main server that operates the iMediaTouch system.

While we were able to save audio files by replacing the failed drive with a spare one in an unused server, a call to the technical support department at OMT

OMT dispatched Field Engineer Ron Taylor to our location. He arrived within 20 hours of our distress call while we downloaded OMT's iMediaPix cart software program to enable us to play our commercials.

The entire day's log was saved with no income lost.

Within six hours of his arrival, Taylor had the original iMediaTouch 16-bit Windows software upgraded to 32-bit and the iMediaTouch software and system running smoothly. Situations like this make our company appreciate OMT and the iMediaTouch System. Not only do we find the new iMediaTouch Version 1 software and system user friendly, we enjoy our relationship with the technical support department.

For more information, including pricing, contact OMT in Canada at (204) 786-3994 or visit www.imediatouch.com.

SS32

► Continued from page 42 date for each change in encryption status that occurs on a station.

The encrypted air log can only be decrypted, viewed and exported using Scott Studios products, which preserves the integrity of the file. The encrypted air log must be decrypted immediately before export to the traffic/accounting systems, which ensures accurate record keeping. While this feature alone does not make a station compliant with Sarbanes-Oxley legislation, it does help significantly.

Sarbanes-Oxley legislation requires public companies to maintain their data file in such a way that they cannot be tampered with or manipulated.

The addition of the Comm Module by dMarc to the SS32 software is a fine improvement to the system developed by Scott Studios. There have been a few bumps but all have been immediately addressed and corrected by the support team at dMarc. The features that are available are outstanding and sure to get even better by the end of the year.

For more information, contact dMarc Broadcasting in California at (949) 791-1200 or visit www.dmarc.net.

TECH UPDATE

Arrakis Updates Digilink-Free With Xtreme

Billed by the company as a radio station in a box, Digilink-Free from Arrakis Systems is a free radio automation software system that includes live on-air and hard disk on-air automation, scheduling and production capabilities.

Digilink-Free was updated this year with a free version of Digilink-Xtreme, the company's Windows-based software featuring on air, production, scheduling and logging.

Digilink-Xtreme is suitable for hard disk audio-based live or automated stations. Highlights include overscheduling, autofill, drop events and timed events.

Digilink-Xtreme comes with a black box Arrakis has dubbed the "Bridge," which is operated by Digilink-Xtreme and turns a user-purchased PC into an audio workstation. The Bridge provides the interface between the PC and a radio station's audio system. The functionality of two audio soundcards is built in, which connects to the PC via USB cable. Also included are routing switchers and satellite control logic.

For information contact the company in Colorado at (970) 461-0730 or visit www.arrakis-systems.com.

WBS

RLM24
High density Digital Audio Metering*

*The RLM24 provides 24 stereo VU/PPM loudness meters in two rack units of space.

Features include
Silence sensing with audible and visual alarms, individual channel threshold and time delay, GPOs to trigger external devices.

WBS
ward-beck systems

455 Milner Ave., Unit 10
Toronto, ON, Canada
M1B 2K4

416.335.5999
800.771.2556
ward-beck.com

USER REPORT

SkimmerPlus Eases Podcasts for WRAL

by Will Patnaud, CBRE
Asst. Chief Engineer, WRAL(FM)
Consulting Engineer, WKNC(FM)

RALEIGH, N.C. Back in March, when MIX 101.5 WRAL(FM) decided to start assembling podcasts of the morning show, the webmaster would begin his day with the arduous task of dubbing all the morning show breaks into his computer from a MiniDisc in real time.

The process of extracting the breaks consumed way too much time. Additionally, the already-stretched-thin morning show producer now had to remember to start and stop the MiniDisc recording, which had unreliable results.

There had to be a better way. I knew a number of the major radio automation suppliers had software available to skim directly to a computer, but the nature of this project, which wasn't (yet) generating revenue for the station, required a low-cost solution with easy setup.

Following a brief search, I came across SkimmerPlus from Broadcast Software International.

Affordable option

I decided to give it a try on a spare P4 1.6 GHz machine in the shop, using a CardDeluxe soundcard from Digital Audio Labs. I had SkimmerPlus up and running the same day. In more than six months it hasn't yet missed a break.

Also, the webmaster can now publish the morning show podcast before most of the morning show crew has even made it home.

SkimmerPlus offers a number of features that make it an attractive choice. Foremost is the price. Starting at \$399 for a single record deck, it fit well within the budget for our podcasting project. For an additional cost, SkimmerPlus can be expanded to accommodate logging of additional sources, up to 24 total, depending on the power of the computer on which it is installed.

In fact, I plan to take advantage of this scalability by slowly migrating logging duties from our hardware-based DAT logger, for which replacement drives are becoming hard to find.

I also like the numerous choices for compression, including support for virtually any other format using third-party codecs available for Windows 2000 or XP. For example, when the Windows-available Fraunhofer IIS MP3 codec didn't offer exactly the bit rate I was looking for, I just installed another codec for Windows and it was instantly available as a compression choice in SkimmerPlus.

BSI also offers low-cost MP3 and MPEG Layer 2 codecs as well, in addition to the unique ability to save a linear, uncompressed copy of the captured audio along with the compressed file.

The flexibility of SkimmerPlus to work with third-party codecs, and just about any soundcard, can be a double-edge sword. Research your codecs carefully before choosing one and don't skimp on a soundcard. I certainly wouldn't recommend trying to use an on-board soundcard. Stick with a proven name.

Also impressive is the amount of flexibility available when it comes to controlling the record decks. Decks within SkimmerPlus are controlled by events, which are displayed and defined apart from the record decks. Therefore, any deck can be controlled by a multitude of events.

Events can be triggered by time of day, day of week, external contact closure or any combination thereof. BSI offers a USB triggering device at a reasonable price of \$99, adding 24 triggering inputs that can be simultaneously assigned to any combination of events.

Options for controlling the record decks are extensive. The only triggering feature I would like to see added would be VOX capability, which I understand is in the works.

Features worth mentioning are the HTTP and FTP servers, allowing precise control over who sees what content and how they get it. For our podcasting project, I just mapped the Webmaster to the directory on



Will Patnaud

the machine where SkimmerPlus is running. Our account execs, looking to see if their spot or remote break aired, can log in with

their own unique ID to a Web site served by SkimmerPlus.

A neat application of this feature is used at WKNC(FM), the student-run station at N.C. State University, where I recently started using SkimmerPlus as a replacement for the cassette skimmer, which never seemed to work half the time. I'm still not sure if it was really broken or if that was just an excuse for forgetting to load a tape.

Now the program director can simply log in via the built-in Web site to review a student's airshift, then e-mail a copy to the student with notes for improvement.

Due to its attractive price, stability and numerous features, SkimmerPlus has been a good fit for a number of my projects; I won't hesitate considering it again.

For more information, contact Broadcast Software International in Oregon at (541) 338-8588 or visit www.bsiusa.com.

ENERGYA
FULLY DIGITAL ON AIR CONSOLE

AUDIO DIGITAL NETWORK

NEW

OPEN YOUR EYES AND LET THE FUTURE COME IN

SYNAPSE
CONSOLE UP TO 16 DIGITAL/ANALOG INPUTS AND OUTPUTS

XTREME
FULLY DIGITAL 5 BAND AUDIO PROCESSOR

CROSS
AUDIO MATRIX WITH DIGITAL/ANALOG INPUTS AND OUTPUTS

DIGITAL AUTOMATION SYSTEM

Telereport Plus
PORTABLE TELEPHONE DIGITAL HYBRID

**Digital Studio System
Broadcast Consoles
Stereo & RDS Coders
Telephone Hybrids
Audio Processors**

AEV S.p.A. Headquarters - Bologna ITALY
Phone +39.051.6634711 - Fax +39.051.6634700 - Email: info@aev.net
Full details on www.aev.net or mirror site www.aev-usa.com

USER REPORT

KAXE Sticks With DAD for Upgrade

by Dan Houg
Engineer
KAXE(FM)

GRAND RAPIDS, Minn. KAXE(FM) had one of those cleansing opportunities this year, when we relocated from old studios we'd been in since our beginning in 1976.

This gave us a chance to evaluate our ENCO DADpro automation system installed in 1999 and either upgrade the aging hardware, replace it or switch to another brand of automation system.

After consideration of costs, time and the automation alternatives, we chose to replace our old ENCO system with the newer ENCO DAD system.

'Indispensable' features

We have the DADpro32 automation and control software integrated with our two Logitek consoles and Audio Engine. This is simultaneously wonderful and terrifying. If either system goes down, our station operations are affected drastically. Fortunately, aside from some minor glitches, we've been stable and productive.

The DADpro software has many capabilities, many of which we aren't using; but the features we do use, we feel are indispensable. We are a station that produces our own unattended overnight programming and we use DADpro for the production and delivery of our material.

Daytime live operations see extensive use of the Array buttons that put pre-recorded cuts at hand for volunteers and staff; the recording machines, for recording feeds off

the SOSS satellite network as well as recording daytime volunteer programming for rebroadcast during overnights; and of course the playback machines that hold playlists of automation control commands and audio cuts.

We've programmed several ever-present "Priority" buttons to issue commands



Dan Houg and KAXE's DAD

to the Logitek Audio Engine to accomplish switching between our two studios as well as enter one of several overnight modes.

The DAD software uses a hardware key on the printer port to enable specific features. I would encourage stations to avoid one mistake we made in budgeting and ordering our ENCO system. Unwittingly, we did not specify a "full DAD key" for our production machine, and to our ENCO sales

rep's credit, he tried to configure a low-cost system for us.

Unfortunately, we frequently encountered features we needed that were disabled until we paid for them and each one seems to cost \$495. Avoid many headaches and just budget the cost of a full key to start with.

The functionality of the DADpro software is excellent, with the ability to do waveform editing of MP2 files without time-consuming conversion to PCM. While the built-in waveform editor is fast, it has a clunky feel and is not the best for detailed editing. ENCO has thoughtfully provided an excellent solution to this by integrating operations with my favorite waveform editor, Adobe Audition, formerly Cool Edit Pro.

Realize however that if your cuts library is in a compressed format, cuts have to undergo conversion before use in Audition.

Small installation

ENCO promotes itself as a software company, not a hardware maker. But it has conquered the necessity of a stable PC platform for running its software by providing the hardware itself.

This is a smart move from a support standpoint, as well as providing the station with a prebuilt and configured system.

We have a small installation consisting of three DADpro workstations configured as a peer-to-peer W2000 network. Two of the workstations have two 200 GB SATA drives configured as a RAID 1 array with the single volume holding our cuts mirrored between the two workstations.

Central is an ASUS P4C800-E motherboard with an Intel P4 3GHz processor. Coupled to this are Seagate 200 GB SATA drives, a 128 MB video card, CD and 3.5-inch floppy drives, and we choose the Digigram miXart 8 audio cards that run eight channels in/out. I liked this configuration so much and assumed ENCO put a diligent amount of testing into this platform, so I built two identical PCs using this configuration for use as fast computers for Web streaming encoding and other chores.

While my cost was several hundred less than what ENCO charged for the hardware, given the configuration setup and integration they do before they shipping I'd have to say buying their hardware is a reasonable thing to do and I would do so again if we expand our ENCO system.

For more information, contact ENCO Systems in Michigan at (800) ENCOSYS (362-6797) or visit www.enco.com.

USER REPORT

WRAY Makes Transition to Vault2

by Floyd Turner
Director of Engineering
Thy Word Network
WBGW(FM), WBHW(FM),
WBJW(FM)
Owner, FET Engineering,
Broadcast Technical Consultants

EVANSVILLE, Ind. Broadcast Electronics' AudioVault has been a part of my daily life as a broadcast engineer for more than 13 years, going back to the days of Windows for Workgroups, 10base2 Ethernet and 1 GB hard drives that cost \$1,200.

We've gone from standalone server workstations to multiple redundant servers with workstations for every studio, and improved throughput that makes the original AV100 systems seem like dinosaurs compared to the current Vault2.

While improvements in PC operating systems and hardware have driven the overall pace, it has been amazing to see how well the AV100 with an ISA-based system has kept up for all these years. Its proprietary SCSI-based file system has been pretty bulletproof and remarkably trouble-free. In fact I have one system with more than 100,000 hours of on-air use and few hiccups.

But with the Vault2 now available, we knew it was time to begin phasing out the old workhorse and saddling up the young thoroughbred, as it were.

Even in the budget-challenged environment of small-market radio, this was one

purchase we couldn't afford not to make. So this year at NAB, we negotiated a multiple-station changeover with Broadcast

WRAY(FM) is a 24-hour music intense country format and WRAY(AM) is a 24-hour news-talk station.

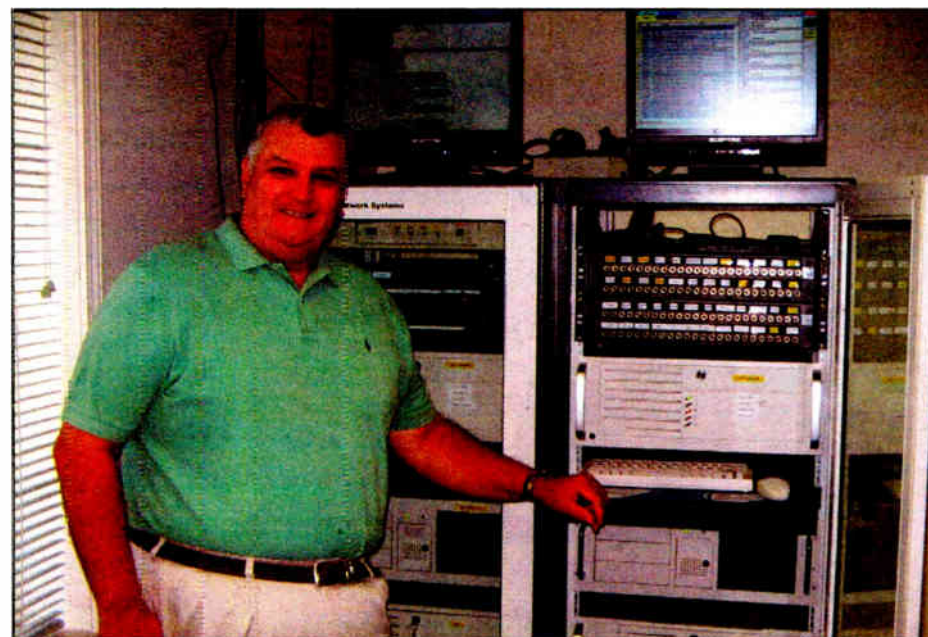

WRAY(AM-FM) General Manager Stephen Lankford

Electronics, and I spent most of the summer doing the AV100-to-Vault2 transitions.

The first station we did was WRAY(AM-FM) in Princeton, Ind.

Switching files

WRAY-AM 1250 and WRAY-FM 98.1 are family owned and operated radio stations, serving the Princeton area since 1950.

During the mid-1990s, as the cart machines and reel-to-reel machines began to wear out, WRAY began looking at digital automation systems and decided on the AudioVault system. The AV100 system was installed in October of 1998. The stations' demand to expand and do more things became apparent, and the system was updated to Vault2

during the summer of 2005.

Vault2 hardware architecture for the AudioVault digital audio system is the hardware replacement for AV100. It takes advantage of off-the-shelf audio cards and standard Windows components.

Vault2 uses Windows-compatible audio cards from Digigram but is also capable of being used with sound cards like SoundBlaster or Audigy cards. These cards share processing load with the PC's CPU, which is finally powerful enough to keep up.

The changeover required some definitive steps to make a smooth transition without interrupting the busy schedule of the daily operation. The first challenge was to retrieve all the files stored under the AV100 system, so we set up a new server and began copying out the 36 GB of files. The AV100 software automatically converts them to .WAV files on the fly, but the process took about 40 hours to complete. Then the new files were cross-copied to the other new server, a process that only took about two hours with the Vault2 file system, utilizing the SCSI-3, Ultra160-based file system.

Once the files were secure, we began to cut in the new servers and transition each studio workstation over to Vault2. Because all the studio workstations had recently been upgraded to Pentium 4 class with 512 MB of memory, they were ready to fly with the new software — and fly they did, with virtually no delay present as files are created, cross-copied and made available to all studios almost instantaneously.

We chose to retain Windows 2000 Pro as the operating system, as we have total confidence in its reliability and consistent oper-

See VAULT2, page 48 ►

Products & Services SHOWCASE

Affordable Custom Broadcast Furniture

Constructed,
Delivered and
Installed by

STUDIO
TECHNOLOGY



Now also serving you
from the West Coast!

Studio Technology West
310B Coney Island Dr.
Sparks, NV 89431
TEL: 775-351-2042
FAX: 775-351-2082

TEL: 610-925-2785
FAX: 610-925-2787
529 Rosedale Rd, Ste. 103
Kennett, PA 19348

e-mail: sales@studiotechology.com
web: www.studiotechology.com

Do Unattended Live Remotes

DR-10 Dial Up Controller & Remote Broadcast Interface

- The DR-10 is a Dial-Up remote control with telephone audio input and output for remote broadcasting.
- If your automation works with satellite networks, you can use the DR-10's relay outputs to fire commercials, liners, etc. Save \$5 with no staff needed at the studio!
- Use the DPDT relays to insert the phone audio directly into the program path when necessary, especially for emergencies or to bypass your automation system.
- When used with our Silencer Option, the DR-10 is the **ONLY** product available that completely removes DTMF control tones from the audio path for clean remotes.

Get the DR-10 & start
saving money now!
www.circuitwerkes.com



CircuitWerkes, Inc. - 352-335-6558

SIX MILLION
THUNDERSTORMS HIT
PLANET EARTH EVERY YEAR!
IT TAKES ONLY ONE TO
PUT YOU OFF THE AIR!



The STATI-CAT LIGHTNING PREVENTION SYSTEM provides a continuous, low-resistance discharge path for the static electric charge on tall structures. Dissipation points are 1/8" stainless steel rods.

This affordable and rugged system has proven itself in the field for over 20 years.

Cortana
Corporation Inc.

Write or call for a free brochure and design
P.O. Box 2548, Farmington, N.M. 87499-2548

Toll Free: 888-325-5336 • Fax: 505-326-2337 • www.cortanacorporation.com

BEXT

FM & TV
Transmitters
Solid State or Tube
Antennas & Combiners

20 Years of Service
Asistencia en Español
24 Hour Support
2 Years Warranty

www.bext.com
Tel 619 239 8462
Fax 619 239 8474
bext@bext.com

FROM THE TALL
TO THE SMALL

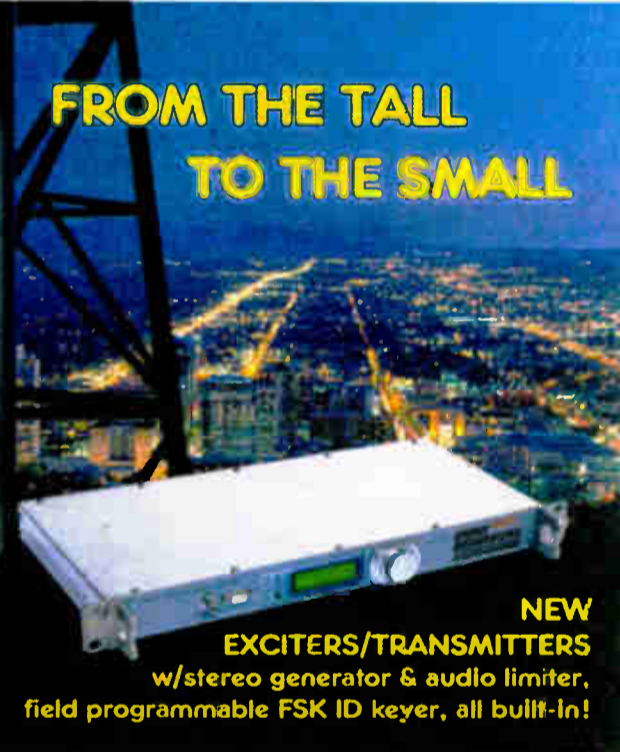

NEW
EXCITERS/TRANSMITTERS
w/stereo generator & audio limiter,
field programmable FSK ID keyer, all built-in!

DIGITAL ANTENNA MONITORS

In-Stock-Available for
Immediate Delivery



Price US\$2700.00 2 Towers
Will operate with any remote control equipment.



Price US\$2100.00 2 Towers
For AM directionals with studio located at transmitter site.

These monitors are state-of-the-art instruments of unequalled accuracy (.5% or better on ratio and .5° or better on phase) and stability. With typical modulation the true ratio readout of these monitors is a factor of 10 more stable than instruments that measure normalized amplitude, and their phase readouts are rock solid. Phase sign is automatic, no extra operation. In addition to the analog DC outputs for remote control the Model CMR has a multiplexed BCD digital output which can be used to drive the Remote Indicator Model CMR-1. RF inputs have dual protection. Gas discharge tubes across the sample line terminations plus relay protection.

GORMAN REDLICH MFG. CO.
257 W. Union St. Athens, Ohio 45701
Phone 740-593-3150 • FAX 740-592-3898
www.gorman-redlich.com/jimg@gorman-redlich.com

Reach Broadcast Professionals!

For more information, including rates & deadlines, fax Claudia Van Veen at 703-671-7409.

Advertise
today!

Radio World
Newspaper for Radio Managers and Engineers
Time — and Long Hours — at the Top

USER REPORT

Paradis Has Automation 'Smarts'

Linux-Based Smartcaster Offers Stations Auto Record, Playback; Redundancy Provides 'Backup'

by **Brett Paradis**
Owner/Operator
Paradis Broadcasting

ALEXANDRIA, Minn. Paradis Broadcasting owns and operates three radio stations, and each has its own distinct format. KXRA(AM) is all news/talk and has been on the air since 1949; KXRA(FM) is a 25 kW classic rock, on the air since 1967; and KXRZ(FM) is a 6 kW programming '80s, '90s and current music, on since 1984.

Because each station has a format unique and separate from the others, we needed an automation and digital storage system that would handle them simultaneously, without any dropouts in the audio network distribution system.

Our first computerized automation system was installed in 1994. After much research, we went with **Smarts Broadcast Systems**. At the time, Smarts was one of only a few companies that offered the abil-

ity to program a music-intensive format without the use of CD players; using strictly hard drives. It was a system that simply connected one computer to another and allowed the recording, storage and playback of audio without the need for any transfer by floppies.

This first Smarts Broadcasting system served us well for several years. In 1999, as we prepared for Y2K, we replaced it with a then-new Smartcaster Generation 2000 system.

The Generation 2000 system was a nice step up. The new distribution network using electric switches vastly increased the speed of digital delivery, while virtually eliminating any interruptions in digital communication between computers.

Recently, we moved up to Smarts Broadcast's latest Smartcaster, a Linux-based server system. We have found the Linux servers to be robust and reliable for two years now.



Brett Paradis stands with Paradis Broadcasting's Smartcaster.

With our news/talk station, we need a system that enables us to automatically record and playback both short- and long-form network programming. This allows our on-air staff to be more productive, as they spend their time on the creative process rather than simply pushing buttons to carry

out commands.

Our two FM stations are both music-intensive. However, one is mostly a satellite-based format, while the other's music is supplied entirely by the Smartcaster. We are able to localize the sound in such a way that few people are even aware that not all the announcers are local — even for the station with satellite-driven music.

Additionally, the voice tracking abilities have allowed us flexibility on all three stations.

Unlike Windows NT or any other Windows format, there is no need to defrag the Linux servers; you are not required to take systems off-line for any reason, providing almost seamless audio availability. Also, the redundancy of the Linux system provides safety in terms of "backup" audio and information.

The Live Show screen used in the various control rooms is helpful, as it allows the announcers to see the entire day at once, rather than just one hour at a time. They can scroll through the day and make any changes they desire, put in pauses or insert voice-tracks. It enables flexibility and ease of operation.

For more information, contact Smarts Broadcast Systems in Emmetsburg, Iowa, at (712) 852-4047 or visit www.smartsbroadcast.com.

USER REPORT

Digital Juke Box Services Appalachia

Arts Organization's LPFM Relies on System for Remote Administration, Library Storage Expansion

by **Jerry Venable**
Executive Director/General
Manager
WOOP(LP)

CLEVELAND, Tenn. WOOP(LP) is a non-commercial low-power FM radio station operated by a nonprofit arts organization, the Traditional Music Resource Center. The mission of the organization is the preservation, broadcast and performance of music that is traditional to the Appalachian area of the southeast United States. The format is traditional country music, bluegrass, old-fashioned gospel music, acoustic, cowboy and samplings of other related music forms liberally included in the broadcast day.

There are no compensated employees, and our air "talent" consists of any individual with an interest in having a show on our little community radio station.

WOOP is a true niche broadcaster, and faces the typical low-power broadcaster's challenges of servicing an audience with a narrow-interest music format and really low power and reach. These include surviving in a noncommercial revenue environment, maximizing the value of capital expenditures and integrating technology so broadcasts are automated by a system that allows a once-a-week show host to operate the system without supervisory or engineering support.

WOOP would not and could not exist without a reasonably priced, fully functional automation system like **Digital Juke Box**.

Our first experience with the Digital Juke Box dates back to early 1998



A screen shot from WOOP & Digital Juke Box systems.

when a predecessor entity to the arts organization became one of the first to broadcast live, 24/7 radio-style programming over the Internet.

While computer automation was not in its infancy, it was struggling through puberty compared to today's state-of-the-art systems. Present-day challenges of routing, networking and Cat-5 integration replaced the simple, but very real 1998 challenge of having a system that would stay on the air with the Windows 95 operating system.

The Digital Juke Box was the answer; it was affordable and it used the DOS operating system.

In recent years, when the instability of Windows 95 was replaced by the stability of Windows XP, the Digital Juke Box was programmed to use the new operating system. Networking, Web interfaces, remote administration and large-size storage devices created amazing opportunities for small, niche broadcasters such as WOOP.

Although we have been long-term users of Digital Juke Box, our organi-

zational capital and operating budgets cause us to constantly review what is available in automation systems for the initial and recurring dollar outlays. For us, the answer remains the Digital Juke Box because it provides value. There are systems available for smaller outlays but none that we have found provide the same features, reliability and support. It would be impossible for us to broadcast without a dependable automation system that keeps on playing the music.

The interface is intuitive. We have no experienced radio people; each new program host is a "tabula rasa" experience, including the 70-year-old grandmother who does a gospel show on Sundays. She learned the system quickly, though clicking the mouse without double-clicking remains an insurmountable challenge.

The large-capacity storage devices have given us an opportunity to expand

our music library, which includes seasonal music, special interest or event music and live performance recordings.

With a legacy of Internet broadcasting, WOOP streams its audio signal online at its Web site, www.woopfm.com. The Digital Juke Box interface to place the Song Title and Artist information on our site to accompany the audio stream was easy. We are in the process of installing an SC100 RDS encoder and will soon be sending this same Song Title and Artist information to RDS-enabled car radios, just like the "big boys."

Digital Juke Box allows us to be the "high-tech rednecks."

Additionally, having an automation system that integrates to the Internet allows me as the executive director and general manager to access the computers by remote control, no matter where I may be located. This is a luxury for any bare-bones organization.

For more information, contact Digital Juke Box in Ohio at (740) 282-SOFT (7638) or visit www.digitaljukebox.com.

Vault²

► Continued from page 42
ation. XP has yet to convince me that I can trust it in this type of continuous-duty environment, although it too is fully supported by Broadcast Electronics.

Vault² is able to use far more hard drive options because it's under the Windows umbrella, such as SCSI, IDE, SATA or any combination or configuration including RAID. If Windows can see it, and it's NTFS, Vault² can use it, which also enables interconnectivity with other formats and products.

Where files created with multi-track editors or other non-AudioVault sources had to be imported and converted to the AV100 format through the AV100 hardware (which was the only access to the file system),

Vault² can use linear or compressed WAV or MPEG files which can be more easily brought in to the AudioVault world.

We had a few software hiccups to deal with, caused mostly from leaving the NetBios setup that AV100 required and implementing TCP/IP as the network communication protocol. The Digigram cards are demanding in that correct drivers and install procedures must be followed for them to work properly after installation. But after a few days of catching loose ends, touching up configurations and generally settling in, everything has been fine.

It's hard to believe how far digital automation systems have come in a few years, and equally hard to imagine where we'll be in the near future. But based on our experience with AudioVault over these past 13 years, I expect it to be part of the picture.

For more information, contact Broadcast Electronics in Illinois at (217) 224-9600 or visit www.bdcast.com.

BROADCAST

Equipment Exchange

"Broadcast Equipment Exchange" accepts no responsibility for the condition of the equipment listed or for the specifics of transactions made between buyers and sellers.

ACOUSTICS

WANT TO SELL



Full product line for sound control & noise elimination.

www.acousticsfirst.com

AMPLIFIERS

WANT TO SELL

Tascam PA-20MK II Dual Power Amplifier - Powers up but will sell "as is" for \$75.00. For a picture please e-mail Mike Raley at mrale@bbradio.org

ANTENNAS/TOWERS/CABLES

WANT TO SELL

Jampro JSCP-8 Antenna, tuned to 105.7. Recently rebuilt. \$2500 or offer. Contact Keith Shipman, Horizon Broadcasting Group. 541-383-3825 or kbs@horizonbroadcasting.com

AM Ground Systems

Reliable, On-time Installation
Quality Workmanship
Ground System Evaluation
and Repair
www.amgroundsystems.com
1-877-766-2999



Shively Labs 6810 -6R- DA antenna. This antenna is tuned to 92.5fm with a gain of 6.09 and db of 7.85. This was originally installed in 1986 and removed from service back in November. System also included raydoms for ice protection and is 20 dbk max. Pictures are available so e-mail Mrale@bbradio.org for the full scoop. Asking \$2000. Buyer responsible for pick-up and delivery. This system is located in Alert, NC. Please e-mail Mike Raley at mrale@bbradio.org.



Station increasing wattage. Must sell excellent 6 Bay Shively antennae with heaters; #6813 Non Directional, Z3.5 (solid State) Harris F.M. transmitter with Digit Exciter included; 5 years old, 3 Phase; 8200 Orban Optimod; Manuals with all equipment. Also 300' Andrews co-ax with fittings. Call Gene at 606-877-1326 or e-mail wygeradio@yahoo.com

WANT TO BUY

1'8" And 1 5/8" Coaxial Relays, Continental Communications 314-664-4497, contcomm@sbcglobal.net

AUDIO PROCESSING (INCLUDES ON-AIR)

WANT TO SELL

CRL Millennium Digital Audio Processor. Used but in great shape and ready to install. Includes manual and latest software update. \$3,900 or best offer. Call 740-334-3437

Orban 9200/U Serial 80511802481. Price \$2600 + shipping. (As is conditions) Call Gary at WKYY-FM at 440-466-9559.

AUTOMATION EQUIPMENT

WANT TO SELL

Now available, radio automation for the Linux operating system. Schedule music, voice track, create shells, auto or announcer assist mode, set intro and ending cues, hit the vocal every time with your voice tracks, execute exact time events, join networks, and more. Visit digitaldevelopment.net and click on RADIO AUTOMATION for screen shots. The software is free; there is a small duplication fee. For more info call 406.665.1832.

Complete Smarts system bought in 2003, just taken off for cluster consolidation. Call for details. Chris - 270-786-1005

CD PLAYERS

WANT TO SELL

Denon DN M105R minidisc player. This is a commercial model we used for remote ID and PSA activations. Have gone to cd players so we are going to let these go for \$200.00 each "as is" plus s/h. Contact Mike Raley at (704) 523-5555 or e-mail at mrale@bbradio.org for pictures.

COMPLETE FACILITIES

WANT TO SELL

NEW OR USED COMPLETE PACKAGES

STUDIO/STL/TRANSMITTER /ANTENNA OR ANY COMBINATION OF ABOVE.

-LEASE OPTIONS-
-EMERGENCY RENTALS-
-REMOTE BROADCAST RENTALS-

SCMS, Inc. (800) 438-6040
"You Know We Know Radio"

CONSOLES/MIXERS

WANT TO SELL

Audio Arts A-50 console. Used in light recording such as weather and PSA's. Has eight faders on it but the picture can speak for itself. Will let go for "as is" \$750.00 plus shipping and handling. Call Mike Raley at (704) 523-5555 or email Mrale@bbradio.org for a picture.

AEO BC312, 10 channel audio console. As is condition. Contact Gary Hays, 440-466-9559 \$1500 + shipping.

WANT TO BUY

GATES Executive, Dualux II, or Dualux 80 Stereo Console in decent working condition. Steve Kelly (601) 982-1062.

Amplex AM-10 mixer in operating condition. Bill Cook, 719-687-6357.

LIMITERS/AUDIO PROCESSING

WANT TO BUY

Teletonix LA-2A's, UREI LA-3A's & LA-4's, Fairchild 660's & 670's, any Pultec EQ's & any other old tube compressor/limiters, call after 3PM CST, 972-271-7625.

MICROPHONES

WANT TO BUY

RCA 77-DX's & 44-BX's, any other RCA ribbon mics, on-air lights, call after 3PM CST, 972-271-7625.

MISCELLANEOUS

IRON BLOWERS AND FLARE BLOWERS, new & rebuilt for Elcom, Harris, CCA, CSI, McMartin, Goodrich Ent. 11435 Manderson St. Omaha, NE 68164 402 493 1886 FAX 402 493 6821

REMOTE & MICROWAVE

WANT TO SELL

davicom

MAC+ & MiniMAC+

THE MOST FLEXIBLE SECURE-IP
REMOTE MONITORING SYSTEMS
ON THE MARKET

COMLAB INC.
2300, Leon-Harmel, Suite 220
Quebec, QC, G1N 4L2
Tel: 418.682.3380 Fax: 418.682.8996
Web: www.davicom.com

Marti Digital Cellcast. Perfect for remotes. 4 channel mixes. Operates on cell or phone line. Wall plug power or 12Y DC-Gar lighter adapter, 1 year old. \$3300 when new. Price \$2500. Call Matt Fulmer 864-21-6230.

WE RENT FOR LESS

Blueboxes FM Exciters
Zephyrs FM Power Amps
POTS Codexes STL's
RF/Audio Gear Test Equipment

If we don't have it, we will get it!
SCMS, INC. (800) 438-6040
"You Know We Know Radio"

WANT TO BUY

Marti RPU equipment, Continental Communications, 314-664-4407. contcomm@sbcglobal.net

RF SUPPORT

WANT TO SELL

3 TTC XLFM Series Translators (10 watt) tuned to 95.5, 104.9 and 104.9. Contact Keith Shipman, Horizon Broadcasting Group. 541-383-3825 or kbs@horizonbroadcasting.com

SATELLITE EQUIPMENT

WANT TO SELL

Gardiner Low Noise Amplifiers - Will sell "as is" for \$25.00 each plus shipping. E-mail mrale@bbradio.org for picture

SOFTWARE/DATABASES

WANT TO SELL

Stream your remotes over the internet! Cheap, reliable, automatic with our software. Visit www.blockweb.com/freemanlabs/autostream or telephone 512-461-8233

STATIONS

WANT TO SELL

HADDEN & ASSOC.

- Central FL AM Fulltime...\$295
- MS Class A FM Upgraded...\$1.5M
- TX FM Class A Religious...\$800K
- TX 2 Class C FM Group...\$4.0M

407.699.6069
E-mail: Haddenws@aol.com
Web: Haddenonline.com

1,000 watt AM station in North Central, NY state. Harris transmitter along with 12.2 acres of property included. Has CP to raise tower height and Main Studio Waiver. Please visit www.bbradio.org/sale for more information as well as information on five sattelators for sale in the Midwest. Contact Mike Raley at mrale@bbradio.org or call (704) 523-5555.

TX Panhandle 100K, FM, \$500,000, call 806-259-3511

WANT TO BUY

Minority Principal seeks Silent/Distressed AM or FM station South USA 713-498-3381 JPecina@collins21e.com

STEREO GENERATORS

WANT TO SELL

CRL Stereo Modulator/Processor (SMP-850), CRL FM Stereo Generator (SG-800A), CRL Spectral Energy Processor (SEP-800), CR: Stereo Gain Controller (SGC-800). Contact Keith Shipman, Horizon Broadcasting Group. 541-383-3825 or kbs@horizonbroadcasting.com

STUDIO ACCESSORIES/SUPPORT

WANT TO SELL

Audio Cord Cart machines. We have about Several "E" series playbacks at \$20.00 each, 10 "DL" series playbacks and two "A" series playbacks at \$20.00 each. Most of them have been refurbished. We also have one "A" series P/R mono, two "E" series p/r mono and two "DL" series p/r mono. Call Michael Raley @ (704) 523-5555 or e-mail Mrale@bbradio.org for more information. No connectors are available. Will sell "as is". Shipping and handling charges apply. Call Michael Raley @ (704) 523-5555 or e-mail Mrale@bbradio.org for some pictures.

STUDIO-TRANSMITTER LINKS (STL) AND RPU

WANT TO SELL

3 sets of Marti STL's (R-10/STL-10) tuned to 950.875, 950.500 and 946.12. Contact Keith Shipman, Horizon Broadcasting Group. 541-383-3825 or kbs@horizonbroadcasting.com

V-Soft COMMUNICATIONS The Leader in Broadcast Engineering Software

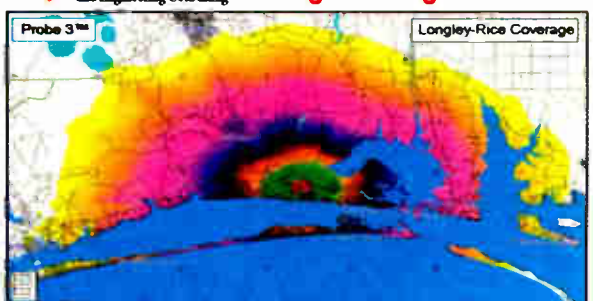

Professional Software packages for FCC applications and predicting coverage.

- Create stunning "real-world" coverage maps and interference studies using Longley-Rice, PTP, Okamura/Hata and FCC with Probe 3™.
- Search for FM channels under spacings and contour to contour protection using FMCont™.
- Prepare AM skywave and groundwave allocations studies and map FCC contours with AM-Pro™.
- Plot STL paths over 3D terrain with Terrain-3D™.

Quality custom mapping and FCC engineering consulting available.

www.v-soft.com

(800)743-3684

TAPES/CARTS/REELS/CDs

Are you a fan of great "old time" announcing and need to get rid of some CDs or "airable" quality LPs or 45s? Low-budget, non-commercial, public radio show in Philly area needs a larger library of music. Musical styles: instrumental, vocalists, vocal groups, soft rock and more. For more info, call Frank the DJ at 215-338-0546. Or send your CDs, LP & 45s to: 7202 Leonard St., Philadelphia, PA 19149.

WANT TO BUY

Large or small collections of 16" transcriptions or 12" transcriptions, not commercial LPs. Bill Cook, 719-687-6357.

I'm looking for San Francisco Bay area radio station recordings from the 1920's-1980's. For example: Top 40 radio show newscasts, live band remotes, sports recordings, talk shows, R7B, religious, etc. From stations like: KSFO, KTAB, KFRC, KNBC, KNKB, KQW, etc. I'll pay for copies. 415-383-6216.

TEST-METERING-MONITORING

WANT TO SELL

Score FC71 Frequency meter. Been in padded case since new. Works great! \$250. Call Jack 417-437-1226

Score LC101 Capacitor & Inductor Meter, Ranges 1PF 200,000 UF 1UH-10 Henry. Padded case. Excl condition \$300. Call Jack 417-437-1226

TRANSMITTERS/EXCITERS/TRANSLATORS

WANT TO SELL

Harris FM-5H 5kW FM transmitter. Good condition, clean with exciter \$7500 obo. Mark or Dan (530) 894-4813"



NEED TO MAKE ROOM FOR THE NEW EQUIPMENT YOU ORDERED?

Sell your used equipment here in the pages of Radio World Broadcast Equipment Exchange.

It's easy... just fill out the Action-gram in the back of the issue and mail or fax it in. We'll run your listing (s) for two consecutive issues!

DON'T LET YOUR OLD EQUIPMENT COLLECT DUST... COLLECT \$ INSTEAD!

If you have any questions regarding the procedure, you can call Claudia at 703-998-7600 ext. 154 or email her at cvanveen@maspub.com, for more information.

Consultants

**Consulting Communications Engineers
EMC Test Lab**

- FCC Applications and Field Engineering
- Frequency Searches and Coordination
- AM-FM-CATV-ITFS-LPTV
- EMC Test Lab-FCC and European (IEC)

OWL ENGINEERING, INC.
E-mail: info@owleng.com **651-784-7445** Fax (651) 784-7541
5644 Hamline Ave. N., Shoreview, MN 55126 Member AFCEE

EVANS ASSOCIATES Consulting Communications Engineers

FCC Applications • Design • Field Engineering • Tower Detuning Upgrade & Relocation Studies • AM Directional Array Tuning & Proof

EXPERTS IN:
TV • DTV Transition • FM • Directional Antennas • RF Exposure

210 S. Main St., Thiensville, WI 53092. (262) 242-6000, FAX (262) 242-6045
<http://www.evansassoc.com> Member AFCEE

COMMUNICATIONS TECHNOLOGIES, INC.
BROADCAST TECHNICAL CONSULTANTS

- AM, FM, TV coverage & Upgrades
- Broadcast transmission facility design
- FCC applications preparation - construction permit and license engineering

Clarence M. Beverage • Laura M. Mizrahi
P.O. Box 1130 Tel: (856)985-0077
Marlton, NJ 08053 Fax: (856)985-8124
www.commtechrf.com

GRAHAM BROCK, INC.
BROADCAST TECHNICAL CONSULTANTS

Full Service From Allocation to Operation AM/FM/TV/AUX Services, Field Work, Antenna and Facilities Design

Over 45 years engineering and consulting experience

912-638-8028
202-393-5133
www.grahambrock.com

FASTER... MORE ACCURATE RADIO COVERAGE

- Real Time 3-D Displays
- Interference calculations
- Cost effective mapping
- Fully integrated databases
- Used by the FCC
- Latest standards built-in

RADIO SOFT
Visit us on the web at www.radiosoft.com
101 Democrat St. #E, Democrat GA 706 770 0811

Serving Broadcasters Since 1948

Mullaney Engineering, Inc.
Member AFCEE

9049 Shady Grove Court
Gaithersburg, MD 20877
(301) 921-0115
Fax (301) 590-9757
mullaney@mullengr.com

The Coverage Map Store

REALcoverage.com

High Performance Engineering for Maximum Coverage

Structural Analysis

ERI
Electronics Research, Inc.
7777 Gardner Road
Chandler, IN 47610
(812) 925-6000
www.ERInc.com

REGISTERED PROFESSIONAL ENGINEERS
STRUCTURAL ANALYSIS
ERI Incorporated 1943
TOWER REINFORCING

DISTRIBUTOR DIRECTORY

The following distributors serving the broadcast industry would be glad to help you with any of your requirements.

CORNELL-DUBILIER MICA CAPACITORS
FROM STOCK

JENNINGS VACUUM CAPACITORS
FROM STOCK

JENNINGS VACUUM RELAYS

SURCOM ASSOCIATES
2215 Faraday Ave., Suite A
Carlsbad, California 92008
(760) 438-4420 Fax: (760) 438-4759
e-mail: link@surcom.com web: www.surcom.com

SPACE IS AVAILABLE!

Are You a Distributor?

ADVERTISE HERE!
Space is available
Call 703-998-7600

ACTION-GRAM

EQUIPMENT LISTINGS

Radio World's Broadcast Equipment Exchange provides a FREE listing service for radio stations only. All other end users will be charged. This FREE service does not apply to Employment Help Wanted ads or Stations For Sale ads. These are published on a paid basis only. Send your listings to us by filling out the form below. Please be aware that it takes one month for listings to appear. The listings run for two consecutive issues and must be resubmitted in order to run again. Thank you.

Are you currently a subscriber to Radio World?
 Yes No

Please print and include all information: Signature _____ Date _____

Contact Name _____
Title _____
Company/Station _____
Address _____
City/State _____
Zip Code _____
Telephone _____

Brokers, dealers, manufacturers and other organizations who are not legitimate end users can participate in the Broadcast Equipment Exchange on a paid basis. Line ad listings & display advertising are available on a per word or per inch basis.

WTS WTB Category: _____
Make: _____ Model: _____
Brief Description: _____
Price: _____

WTS WTB Category: _____
Make: _____ Model: _____
Brief Description: _____
Price: _____

WTS WTB Category: _____
Make: _____ Model: _____
Brief Description: _____
Price: _____

*Closing for listings is every other Friday for the next month's issue. All listings are run for 2 issues unless pressed for space or otherwise notified by listee.
Broadcast Equipment Exchange
PO BOX 1214, Falls Church, VA 22041 • Tel: 703-998-7600 • Fax: 703-671-7409

Doug Vernier
Telecommunication Consultants

Broadcast Engineering Consulting
AM/FM/TV/LPTV/DTV
Custom mapping service
Frequency searches
Propagation prediction
FCC application preparation

VSoft
Software for your PC
(800) 743-3684
www.v-soft.com

Radio World

5827 Columbia Pike, 3rd Floor Falls Church, VA 22041
PHONE: 703-998-7600 • FAX: 703-671-7409

Classified Advertising Rates Effective January 1, 2005

	1x	6x	13x	26x
1-9 col inch (per inch)	\$110	105	100	95
10-19 col inch (per inch)	\$95	85	75	65
Distributor Directory	\$135	130	125	120
Professional Card	\$105	100	95	90
Station/Studio Services	\$200	170	145	124
Classified Line Ad	\$2/word			
Blind Box Ad	\$15 additional			

Call Claudia Van Veen, at 703-998-7600 ext. 154, to reserve space in the next issue. Use your credit card to pay, we now accept VISA, MASTERCARD and American Express.

www.rwonline.com



NEW

ECONCO NEW TUBES

New tubes are now manufactured by **ECONCO** at our award winning facility in Woodland California! Of course, we continue our 34 year tradition of high quality power tube rebuilding.

TEL: 800-532-6626
 INTL: +1-530-662-7553
 FAX: +1-530-666-7760
 www.econco.com
 SE HABLE ESPAÑOL



TRANSMITTERS/EXCITERS/TRANSLATORS WTS (Cont.)

TRANSCOM CORPORATION

Serving the Broadcast Industry Since 1978
 Transmitters and Broadcast Equipment for Radio & Television

<p>Used FM Transmitters</p> <table border="0"> <tr><td>1.5 KW</td><td>1983</td><td>BE FM 1.5A</td></tr> <tr><td>2.5 KW</td><td>1984</td><td>Continental 814R-1</td></tr> <tr><td>3.5 KW</td><td>1992</td><td>Harris HT 3.5</td></tr> <tr><td>5 KW</td><td>1982</td><td>Harris FM 5K</td></tr> <tr><td>6 KW</td><td>1995</td><td>Henry 6000D</td></tr> <tr><td>10 KW</td><td>1988</td><td>BE FM10A</td></tr> <tr><td>10 KW</td><td>2001</td><td>Henry 10,000D-95</td></tr> <tr><td>20 KW</td><td>1978</td><td>Collins 831G2</td></tr> <tr><td>20 KW</td><td>1991</td><td>Harris HT 20</td></tr> <tr><td>25 KW</td><td>1980</td><td>CSI-T-25-FA (Amp Only)</td></tr> <tr><td>25 KW</td><td>1982</td><td>Harris FM25K</td></tr> <tr><td>30 KW</td><td>1986</td><td>BE FM30A</td></tr> <tr><td>35 KW</td><td>1990</td><td>Continental 816R-5B</td></tr> <tr><td>50 KW</td><td>1982</td><td>Harris Combiner w/auto exciter-transmitter switcher</td></tr> </table> <p>Used AM Transmitters</p> <table border="0"> <tr><td>1 KW</td><td>1999</td><td>Omnitrix 1000A solid state</td></tr> <tr><td>1 KW</td><td>1983</td><td>Harris MW1A Solid State</td></tr> <tr><td>1 KW</td><td>1986</td><td>Harris SX1A Solid State</td></tr> <tr><td>5 KW</td><td>1985</td><td>Continental 315R1</td></tr> <tr><td>5 KW</td><td>1996</td><td>Harris Gates 5 Solid State</td></tr> <tr><td>5 KW</td><td>1982</td><td>Harris MW5A</td></tr> <tr><td>10 KW</td><td>1986</td><td>Harris MW10B</td></tr> <tr><td>12 KW</td><td>2000</td><td>Nautel XL12 Solid State</td></tr> <tr><td>50 KW</td><td>1985</td><td>Continental 317 C2</td></tr> </table>	1.5 KW	1983	BE FM 1.5A	2.5 KW	1984	Continental 814R-1	3.5 KW	1992	Harris HT 3.5	5 KW	1982	Harris FM 5K	6 KW	1995	Henry 6000D	10 KW	1988	BE FM10A	10 KW	2001	Henry 10,000D-95	20 KW	1978	Collins 831G2	20 KW	1991	Harris HT 20	25 KW	1980	CSI-T-25-FA (Amp Only)	25 KW	1982	Harris FM25K	30 KW	1986	BE FM30A	35 KW	1990	Continental 816R-5B	50 KW	1982	Harris Combiner w/auto exciter-transmitter switcher	1 KW	1999	Omnitrix 1000A solid state	1 KW	1983	Harris MW1A Solid State	1 KW	1986	Harris SX1A Solid State	5 KW	1985	Continental 315R1	5 KW	1996	Harris Gates 5 Solid State	5 KW	1982	Harris MW5A	10 KW	1986	Harris MW10B	12 KW	2000	Nautel XL12 Solid State	50 KW	1985	Continental 317 C2	<p>Exciters</p> <p>*New* 20 w & 30W Synthesized exciters New TV Transmitters- Analog and Digital</p> <p>Special Discount Pricing On: VHF and UHF TV Antennas (10 W to 10 KW) TV STL</p> <p>Used TV Transmitters</p> <table border="0"> <tr><td>10 KW</td><td>VHF</td><td>NEC PCN 1213</td></tr> <tr><td>30 KW</td><td>UHF</td><td>RCA TTU-30-A, CH 50</td></tr> </table> <p>Used Misc. Equipment</p> <table border="0"> <tr><td>Bird RF Thruline</td><td>Wattmeter, 50S</td></tr> <tr><td>Genon</td><td>720R Cassette Player</td></tr> <tr><td>Potomac Phase Monitr</td><td>AM19 w/sampler</td></tr> <tr><td>Potomac Phase Monitr</td><td>1901 Digital 2 Trw</td></tr> <tr><td>Sola Voltage Reg.</td><td>60hz 1 KVA s-phase</td></tr> </table>	10 KW	VHF	NEC PCN 1213	30 KW	UHF	RCA TTU-30-A, CH 50	Bird RF Thruline	Wattmeter, 50S	Genon	720R Cassette Player	Potomac Phase Monitr	AM19 w/sampler	Potomac Phase Monitr	1901 Digital 2 Trw	Sola Voltage Reg.	60hz 1 KVA s-phase	<p>Used AM Transmitters</p> <table border="0"> <tr><td>1 KW</td><td>1999</td><td>Omnitrix 1000A solid state</td></tr> <tr><td>1 KW</td><td>1983</td><td>Harris MW1A Solid State</td></tr> <tr><td>1 KW</td><td>1986</td><td>Harris SX1A Solid State</td></tr> <tr><td>5 KW</td><td>1985</td><td>Continental 315R1</td></tr> <tr><td>5 KW</td><td>1996</td><td>Harris Gates 5 Solid State</td></tr> <tr><td>5 KW</td><td>1982</td><td>Harris MW5A</td></tr> <tr><td>10 KW</td><td>1986</td><td>Harris MW10B</td></tr> <tr><td>12 KW</td><td>2000</td><td>Nautel XL12 Solid State</td></tr> <tr><td>50 KW</td><td>1985</td><td>Continental 317 C2</td></tr> </table>	1 KW	1999	Omnitrix 1000A solid state	1 KW	1983	Harris MW1A Solid State	1 KW	1986	Harris SX1A Solid State	5 KW	1985	Continental 315R1	5 KW	1996	Harris Gates 5 Solid State	5 KW	1982	Harris MW5A	10 KW	1986	Harris MW10B	12 KW	2000	Nautel XL12 Solid State	50 KW	1985	Continental 317 C2
1.5 KW	1983	BE FM 1.5A																																																																																																																
2.5 KW	1984	Continental 814R-1																																																																																																																
3.5 KW	1992	Harris HT 3.5																																																																																																																
5 KW	1982	Harris FM 5K																																																																																																																
6 KW	1995	Henry 6000D																																																																																																																
10 KW	1988	BE FM10A																																																																																																																
10 KW	2001	Henry 10,000D-95																																																																																																																
20 KW	1978	Collins 831G2																																																																																																																
20 KW	1991	Harris HT 20																																																																																																																
25 KW	1980	CSI-T-25-FA (Amp Only)																																																																																																																
25 KW	1982	Harris FM25K																																																																																																																
30 KW	1986	BE FM30A																																																																																																																
35 KW	1990	Continental 816R-5B																																																																																																																
50 KW	1982	Harris Combiner w/auto exciter-transmitter switcher																																																																																																																
1 KW	1999	Omnitrix 1000A solid state																																																																																																																
1 KW	1983	Harris MW1A Solid State																																																																																																																
1 KW	1986	Harris SX1A Solid State																																																																																																																
5 KW	1985	Continental 315R1																																																																																																																
5 KW	1996	Harris Gates 5 Solid State																																																																																																																
5 KW	1982	Harris MW5A																																																																																																																
10 KW	1986	Harris MW10B																																																																																																																
12 KW	2000	Nautel XL12 Solid State																																																																																																																
50 KW	1985	Continental 317 C2																																																																																																																
10 KW	VHF	NEC PCN 1213																																																																																																																
30 KW	UHF	RCA TTU-30-A, CH 50																																																																																																																
Bird RF Thruline	Wattmeter, 50S																																																																																																																	
Genon	720R Cassette Player																																																																																																																	
Potomac Phase Monitr	AM19 w/sampler																																																																																																																	
Potomac Phase Monitr	1901 Digital 2 Trw																																																																																																																	
Sola Voltage Reg.	60hz 1 KVA s-phase																																																																																																																	
1 KW	1999	Omnitrix 1000A solid state																																																																																																																
1 KW	1983	Harris MW1A Solid State																																																																																																																
1 KW	1986	Harris SX1A Solid State																																																																																																																
5 KW	1985	Continental 315R1																																																																																																																
5 KW	1996	Harris Gates 5 Solid State																																																																																																																
5 KW	1982	Harris MW5A																																																																																																																
10 KW	1986	Harris MW10B																																																																																																																
12 KW	2000	Nautel XL12 Solid State																																																																																																																
50 KW	1985	Continental 317 C2																																																																																																																

Please visit our website for current listings.

800-441-8454 • 215-938-7304 • FAX: +1-215-938-7361
 www.fmamtv.com • E-mail: transcom@fmamtv.com
RETUNING & TESTING AVAILABLE • CALL US FOR A QUOTE!

Superior Broadcast Products

Television & FM Transmitters and Antennas Built in the USA

contact **Benny Springer** or **Jimmie Joynt**
 Call us 800/279-3326

OFF THE AIR? Emergency Back-up Rentals
 FM Exciters - STLs -
 FM Pwr Amps - Antennas -
 Studio & Test Equipment
SCMS Inc (800) 438-6040
 "You Know We Know Radio"

Real Answer! FCC Certified FM Stereo Transmitter

 ✓ 50W RF output, continuous duty!
 ✓ Auto protect with auto soft fail & auto restore!
 ✓ Automatic battery backup!
 ✓ Digital display of all parameters
 ✓ Perfect for LPFM, Translators, as well as stand-alone exciters
 www.ramseyelectronics.com
ramsey 800-446-2295 *Is Our 33rd Year!*

WANT TO BUY
 Looking for a 1KW Western Electric Transmitter, complete. Call 804-276-3983.

AM Phasors, Phasor Parts, Phase Monitors, Rf Switches.
 Continental Communications, 314-664-4497, contcomm@sbcglobal.net

To advertise, call Claudia
703-998-7600, ext. 154
 or e-mail:
cvanveen@imaspub.com

New 100 AMP RS Contactor For Sale From **GELECO**
 Price \$850
 Phone: 416-421-5631
 Fax: 416-421-3880

TUBES & COMPONENTS

FOR THE BEST PRICE & 24 Hr service on transmitting tubes & sockets/parts, new & rebuilt call Goodrich Ent. at 402-493-1886 day or night, www.goodrichenterprises.com

Radio World Equipment Exchange

D And C Electronics

An International Distributor of RF Components
Tubes
 NEW & REBUILT

TRANSMITTERS, STUDIO EQUIPMENT, STLs, ANTENNAS, RADIO DATA SYSTEM (FOR CAR RADIO DISPLAY) EXCITERS-TRANSMITTERS, TRANSLATORS, MIXERS-CONSOLES, RADIO LINK RPU, MOSFETS, VACUUM CAPACITORS, SOCKETS





SVETLANA   **EEV**
 BROADCASTING USA DISTRIBUTOR

BEST PRICES To Order: 1-800-881-2374 FROM OUR STOCK
 Outside U.S. (352) 688-2374
 Se Habla Español

3089 Deltona Blvd. Spring Hill, FL 34609 352-688-2374 Fax 352-683-9595
 Website: www.dandcelectronics.com

RF PARTS CO.
 From Milliwatts to Kilowatts
EIMAC • TAYLOR • ECONCO • SVETLANA
 Motorola • Toshiba • SGS • Thomson & Mitsubishi Semiconductors
 Se Habla Español **800-737-2787** We Export
 760-744-0700 Email: rf@rfparts.com Web: www.rfparts.com

www.rwonline.com www.rwonline.com

EMPLOYMENT

HELP WANTED



Clear Channel Radio has openings for Market Engineering Managers in several markets. Successful candidates will oversee all technical aspects of the market and must be highly skilled not only in technical matters, but also exhibit strong management skills. This position will have substantial hands on requirements, so if you are looking for a desk job, this probably isn't for you.

Clear Channel Radio leads the industry in technological innovation and support for quality engineering. We offer Excellent Pay, Technical Training programs, 401K, Employee Stock Purchase Plans, Great Benefits and many Opportunities for growth and advancement.

If you have great technical skills and are ready to work with our highly qualified team...

Contact:
 Steve Davis - Sr. Vice President - Engineering
 Clear Channel Radio, 2625 S. Memorial Dr., Ste. A
 Tulsa, OK 74129, 918-664-4581 Fax 918-664-3066
 stevedavis@clearchannel.com

Clear Channel is an Equal Opportunity Employer.

Audio/Radio Production tenure track professor in SUNY Fredonia's Communication department for Fall 2006. See full description at www.fredonia.edu/department/communication.

Broadcast Equipment Exchange
 For more information, call Claudia at 703-998-7600 ext. 154.
Radio World

POSITIONS WANTED

Career Wanted: If you need someone to do any of the following: Board-Op, On-Air, Copywriting, production, voiceovers, promotions etc. Available now, contact Cynthia Johnson at dj_cindy_roy@yahoo.com

Very upbeat and outgoing female! Knowledgeable of all essential skills of the radio business. From Copywriting, programming and board-operations, to sales/ promotions. Contact Aubrey 817-975-3804 jojogr1222@hotmail.com

Good Board work, production and copywriting abilities! If this sounds like someone you need, I'm your woman. ABS grad eager to start my career. Tina 405-590-6953

Rock DJ, funny, intelligent, energetic, full of personality, and dependability! Highly motivated, plus does character voices. Music Director Experience. Will relocate. Dave 817-966-4563, dnick125@yahoo.com

Eager young man looking for a chance to work in the world of radio. Confident in my ability to fulfill any task, and will work hard! Joe 405-410-3261

Need a Radio Goddess full of energy, highly determined, dependable and familiar with broadcasting? Look No Further! Contact Michelle Manson at 214-697-2577 or email mrsnichellenicoleonmanson@yahoo.com



Recent ABS graduate looking for my dream job in radio or just any job in radio. Hard worker who is willing to relocate. Justin 405-694-9395 or cubsbaserballpete@yahoo.com

Friendly, Eager to work, IS CET Certified, Commercial FCC License with radar, NABER Certified two-way radio technician, amateur radio extra, seeks CE, asst. CE F/T, P/T Contract, AM/FM, Cable, TV. Contact: Mitchell Rakoff, mitchellrakoff@yahoo.com 718-969-5224

SPACE IS AVAILABLE!
 To advertise, call Claudia 703-998-7600, ext. 154.

ADVERTISER INDEX

This listing is provided for the convenience of our readers.
Radio World assumes no liability for inaccuracy.

PAGE	ADVERTISER	WEB SITE URL
45	AEV SpA	www.aev.net
12	Altronic Research	www.altronic.com
31	APT	www.aptx.com
24	Arrakis Systems Inc.	www.arrakis-systems.com
14	ATI	www.ataudio.com
8	AudioScience, Inc.	www.audioscience.com
47	Autogram Corporation	www.autogramcorp.com
13	Axia - A Telos Company	www.axiaaudio.com
26	Belar Electronics Laboratory Inc.	www.belar.com
39	Bext, Inc	www.bext.com
3	Broadcast Depot	www.7bd.com
15	Broadcast Electronics	www.bdcast.com
41	Broadcast Electronics	www.bdcast.com
17	Broadcast Electronics	www.bdcast.com
28	Broadcast Warehouse	www.bwbroadcast.com
27	BSW	www.bswusa.com
4	Burk Technology	www.burk.com
39	Circuit Werkes	www.circuitwerkes.com
7	Comrex Corporation	www.comrex.com
1	Continental Electronics Corp.	www.contelec.com
39	Cortana	www.cortanacorporation.com
22	ESE	www.es-web.com
39	Gorman Redlich Mfg	www.gorman-redlich.com
19	Harris Corporation	www.broadcast.harris.com
47	Henry Engineering	www.henryeng.com
20	Inovonics Inc	www.inovon.com
10	Kintronic Labs Inc	www.kintronic.com
47	LBA Technology, Inc.	www.lbagroup.com
6	Logitek	www.logitekaudio.com
47	Mouser Electronics	www.mouser.com
25	NPR Satellite Services	www.nprss.org/rworld
9	Omnia - A Telos Company	www.omniaaudio.com
18	OMT Technologies/Media Touch	www.omt.net
23	Orban (CRL)	www.orban.com
35	Prophet Systems Innovations	www.prophetsys.com
5	Radio Systems Inc	www.radiosystems.com
29	RCS	www.rcsworks.com
37	Scott Studios Corp./dMarc	www.dmarc.net
16	Sine Systems	www.sinesystems.com
39	Studio Technology	www.studiotechnology.com
43	Telos Systems - TLS Corp.	www.telos-systems.com
11	Tieline Technology	www.tieline.com
56	Vorsis	www.vorsis.com
44	Ward-Beck Systems	www.ward-beck.com
2	Wheatstone Corporation	www.wheatstone.com
55	Wheatstone Corporation	www.wheatstone.com

◆ READER'S FORUM ◆

Serve the Public Before Corporations

"Public Radio: Making Every Dollar Count" (June 22) was interesting and to the point. The financing of public radio stations is a continuing problem. It is strange because the solution is so obvious.

A percentage of the gross income of commercial radio and television broadcasters should be diverted to public broadcasting on an annual basis. The use of so much spectrum by broadcasters is a gift to corporations beyond belief. It is only due to the strong lobby in the Congress by the broadcasters that this situation has been allowed to continue for many years. The license granted by the FCC should in some way serve the public rather than the owners of broadcast stations and companies.

It is time for the public and the government to put an end to this gift, and require the commercial broadcasters to give back to the public something they have been getting for free for many years. The programming on these commercial stations is profitable beyond reason, and it is time this windfall be shared with the public.

I'd be interested in seeing an article on this subject in your paper. You do a great job, and I enjoy your publication very much.

John P. Franklin
Santa Barbara, Calif.

Moving Forward

What a great letter from Carl Van Orden (*Reader's Forum*, Aug. 3). I live in Voorhees, N.J. and there isn't one radio station, AM or FM, in the entire market area that I would like to listen to for music. The one exception is the two hours per day of the Andy Kortman show on WNJC(AM).

I like the big bands and the standards. Since WPEN(AM) decided to change formats I feel like an orphan. I spent 42 years in the radio broadcast business doing every thing from announcing, engineering, sales and management, and then worked for equipment manufacturers such as McMartin, Moseley, Ramko, Harris and Fidelipac. I even spent five years working for Radio World as west coast advertising sales manager. I am now retired.

Radio has been my whole life and has supported my family and me pretty well. I am saddened to see the way the industry is going. Perhaps some forward-thinking station managers will take your suggestions to heart and once again start programming to those not being served.

Jack Ducart
Voorhees, N.J.

Are Consultants Ruining Radio?

Radio isn't giving its listeners "JACK." Carl Van Orden is right on target (*Reader's Forum*, Aug. 3).

Unfortunately, the industry as a whole, in most major markets, doesn't care what the listeners want. Its only concern is what its "consultants" say is the trend in their markets as a result of the "consultants'" research.

A consultant is an out-of-work programmer incapable of landing a big-market job — idiots who are single-handedly ruining the broadcast industry.

I grew up in Trenton, N.J. A perfect radio city. I could listen to both New York and Philly radio markets, and what a selection I had: WABC, WMCA, WFIL, WIBG. The list is too big to go on, but you could bet that every one of these stations was listenable by almost every age group.

A consultant is an out-of-work programmer incapable of landing a big-market job — idiots who are single-handedly ruining the broadcast industry.

— Robert Heiney

The ones I mentioned played top 40 but presented it in a dayparted mature approach. Radio today is too micro-managed — too many splinters of the radio format pie. In fact, the pie slices are so thin, you can't get a piece from the pan without making a mess on the other pieces.

Radio was fun to listen to back in the 1960s and '70s. The only fun in radio these days is the high-priced morning gabfest every station seems to have. After that, it's basically a jukebox with commercials. No personality interaction with the listeners. Contests are dull, not to mention the fact that most are nationwide, so just try to win that!

Radio isn't hard to program. Why do we need people in out-of-town offices, telling us what our listeners want to hear?

Oldies formats are dying a slow death. Why? Well, when you play the same 250 songs over and over, it gets boring. Throw in a blah format and you've got a station no one wants to listen to for very long.

Oldies formats should be the radio we older AMers remember. There are over 3,000 song titles I could rattle off that I would love to hear again, and in a format I remember loving. I tried to sell this idea to a couple of oldies stations. Their "consultants" said it wouldn't work.

"Consultants." I found an island to which we can ship them all. Thanks for ruining radio.

Robert Heiney
The Woodlands, Texas

Radio World
The Newspaper for Radio Managers and Engineers

Our readers have something to say

"I read Radio World to stay current and to see things from the perspective of my station engineer. I also enjoy the radio history; it's good to know where the bleeding edge once was."

Brent Gardner-Smith
Executive Director/Station Manager
Aspen Public Radio
Aspen, CO

HEIL SOUND
www.heilsound.com

Shown: Heil PR40 Large-Diameter Dynamic Studio Microphone.

◆ READER'S FORUM ◆

Radio World, October 26, 2005

Radio's 'Bloated Infrastructure'

I have, for some time, been getting a sense of 'déjà vu' about the radio industry. It got worse recently. When I realized why I had this feeling, it came as a shock.

About 20 years ago, I was at the peak of my career as a high-power international installation engineer. There never were many engineers experienced at the megawatts level, so the pay and perks were pretty good. There would be the Harris squad and the Marconi boys and the Siemens/Telefunken division and not many more, so it was quite a cozy business club.

One day I attended a big international communications show put on in Earls Court, London, by GEC, the big U.K. multinational. Marconi was a GEC subsidiary at the time. I wandered around, fascinated by new things like optical fiber and ISDN. I was staring at a videophone demo when some guy on the screen spoke to me from Germany, making me jump. The sales manager happened to be right there, and when he discovered I worked for a GEC company, he asked me what I actually did.

I explained. "Oh," he said, with a sound of "oh dear" just under his breath. He rolled his eyes, "You're in a dying business."

I said, incredulously, "What? I've never been better off!" and he replied, simply, "Satellites."

I walked away shaking my head and laughing. If only I had known that my career path was set to implode.

At first, the satellites made little difference to broadcasting. Cloud-scraping towers were still de rigeur for TV; AM was very popular still; FM was a welcome addition to

the industry. But when DBS — Direct Broadcasting via Satellite — really took hold, demand for terrestrial installations dried up, and the sheiks were looking for the next status symbol to build.

In denial of the underlying market facts, I took refuge in sales and marketing of FM band 2, and for a while, with the French market exploding in a kilowatt race, times were good.

Remember, as you plan more digital channels, 'variety is not originality,' and consider if it is quality or quantity that wins the day.

— Clive Warner

When that market dried up, times became hard indeed. For a while I installed for whoever wanted stuff on air. An installation department that once employed 150 engineers of many different specialties, imploded to a caretaker staff of two or three people. The terrestrial market collapsed and only a select few remained.

Now things are changing fast. Could it be a more radical change than, for instance, the vinyl 33 and cassette to CD and MP3? Is radio itself on the first steps to becoming "a dying industry"?

Basically it all adds up to an explosion of cheap distribution, ever-faster and cheaper bandwidth, the coming public-WiFi of entire cities, rooftop wireless WANs, podcasting, music and video over cellphones, satellite radio and so forth.

I have serious doubts that terrestrial radio will be able to hold on to sufficient market share to support its current bloated infrastructure. And certainly not with the tired

playlist, straitjacketed syndicated rubbish they pass off as "entertainment" nowadays.

Find the right talent. Give it a free hand. Give local access to your customers. Tear up the play lists. And remember, as you plan more digital channels, "variety is not originality," and consider if it is quality or quantity that wins the day.

On another note, I'm in Monterrey, Mexico, working with the rector of

with exciter and any amount of feeder that's available. Also, we need any kind of program processor such as Optimod or Aphex, mixer(s), microphones and headphones.

Contact me at clive@citiria.com for more information.

Clive Warner
Monterrey, Mexico

A 'Special Breed' Indeed

I wanted to commend you for the article about SBE Fellows ("'Fellows' Are a Special Breed at SBE," July 6). I'm sure many of your readers recognized a good number of the names of those who have been an important part of SBE's development over the years.

I do feel obligated to point out two errors. The article incorrectly refers to Charlie Hallinan as the first president, and later to Sandy Sandberg as the founder. Both men were charter members of SBE and Hallinan was SBE's second president. Sandberg served on the Board and as an officer (secretary).

John Battison was the founder and first president of SBE, and holds membership number "1" in the Society.

John L. Poray, CAE
Executive Director
Society of Broadcast Engineers Inc.
Indianapolis

Improved Offering Yields Growth

I am amused by the proposals put forth through various radio trade associations from group owners about how to save radio now that cost cutting has resulted in failure to develop product to meet listeners' needs. These are the same proponents who, in the late 1990s, eliminated program development, local news and engineering costs, while combining many stations under a single roof.

It only worked up to a point. Now that there is nothing new or improved in the pipeline, rate of return on invested capital has dropped to the level to make Wall Street nervous. Implied in this pomposity was that the business types (MBAs) knew a better way to run radio. However, as a long-term broadcaster and a University of Chicago MBA, I do not recall learning that profit comes by cost cutting at the expense of the customers, in this case the listener and advertiser.

Predictions were common that we remaining independent station operators were doomed. However as group operators have continued to cut back, our business has improved.

— Tom Burns

I was taught that long-term growth comes through improvement in the offering.

A few years ago predictions were common that we remaining independent station operators were doomed. However as group operators have continued to cut back, our business has improved. The only way large group operators have been able to sell their service is through continuing rate cutting and in the long-term advertisers perceive they are not receiving value for money expended.

There should be interesting opportunities to acquire such stations in the years to come.

Tom Burns
President
WEFM(FM), WLLT(FM)
Mt. Zion, Ill.

WPEN Memories

I thoroughly enjoyed Doug Fearn's article on WPEN ("Major-Market Radio in the 1960s," April 27), and eagerly look forward to his subsequent articles on WPEN. It brought back some enjoyable memories for me of my first big-city radio experience.

I started in radio broadcasting at WGBA(AM) in Columbus, Ga., right out of the Army at Fort Benning in 1949. I was eager but very green about the broadcasting business, so when an opportunity came about for a weekend stint as news/announcer at WPEN in my home neighborhood in Philadelphia, I grabbed it.

Jules Rind was the program director in 1952 who hired me and put me under his wing for the next eight years while mentoring me about the business. His constructive criticism was probably the most helpful learning experience for me at that time.

Fearn brought back some great memories of Joe Grady and Ed Hurst, co-hosts of the 950 Club; Ed Felbin, host of the daily Frankford Unity Hour mid-mornings and the late night talk show; and amiable studio engineers like Charlie Fritz, Johnny Campisi, Stan Moderski, Mort Borrow and Charlie Burtis, the chief engineer.

And who can ever forget Bud Breeze, the singing disc jockey and former "Boy Singer" for the Blue Baron Orchestra. One summer when Breeze took a vacation I was asked to sub for him. And no I didn't sing along with the music as he did.

There were others that Fearn reminded me of, like the music librarian Gertie Katzman, newsmen Bill Smith and Frank Kent, and fellow announcers Larry Brown and Frank Carter. I will always remember WPEN as my jumping off place for a radio broadcasting career, although it was mostly weekend and occasional vacation relief from 1952 to 1960.

Thanks for the memory.

Dick Harris
Seattle



Dick Harris at WPEN, c.1955.

◆ READER'S FORUM ◆

Conglomerates' Playground

Your front-page story about retiring NAB President and CEO Eddie Fritts (March 30) reaffirms why I, or any other small broadcaster, shouldn't be members of NAB unless we can muster the numbers to wrest control from those who would make broadcasting the exclusive playground of the consolidation barons.

I didn't have to read very far before I needed an airsickness bag. That line about how before the 1996 Telecom Act, 60 percent of stations were losing money and consolidation "helped them grow," was just too much.

So one company absorbs and homogenizes some 1,200 stations, and he sees that as a good thing? That same company was said in the Wall Street Journal to have lost over \$3.5 billion last year. Well, that's some loss. Or is it Enron/Arthur Anderson-style accounting? Methinks it was more like vultures swooped down on some carcasses.

But wait, there's more. The article touts the buzz of multicasting. That, in the real world, means you take the "space" that could make one good signal, and make a bunch of signals no better than today. Then there is the question of the programming on those signals.

Consolidation has brought a great reduction in choice. Choose from computer-generated plastic format No. 1 or No. 2. So you'll add plastic format No. 3 and No. 4. I can't hardly wait.

Look at the Arbitron numbers in any big city. The top performer rarely gets over 7 percent. I'd be ashamed to tell that to a client. How is fragmentation going to be good?

And then there's that wonderful text messaging on the radio screen. Drivers are bad enough already. In a Cessna airplane, you can look at the "dash" for easily a minute and not hit anything. In a car, get real. Besides if the conglomerates ran real radio and not that canned plastic stuff they would actually talk to you about the music and something of consequence so you wouldn't have to read it on the screen.

In radio, we talk to you. If you want music on shuffle, get an iPod.

It's really all about content. Current radio is truly empty calories — junk food. No discovery of music, either new or old. Just talk to the independent record labels like I do. Conglomerate bean counters and "consultants."

Very few stations do it like we do — real people playing from a wide selection of CDs, LPs, 45s and yes 78s, in real time. Emotion, not a computer, guides what gets played next.

Consolidation has done to broadcasting what agribusiness has done to tomatoes. And the NAB is complicit in that.

James D. Jenkins
Owner/GM
WAGS(AM)/WJDJ(AM)
Bishopville, S.C.

A Broadcaster's Reinvention

Perhaps it was my staring into the street-level fishbowl studio of WDAD(AM) in Indiana, Pa., on the way home from Horace Mann Elementary School in first or second grade. Or maybe it was my Dad's friend, Shel Davis, W3FVU, who let me talk to someone in Alaska on his ham radio.

Maybe it was the crystal set radio my dad and I built as one of the many projects we did together. Or the Regency TR-1 I received as a ninth birthday present from my parents.

All I know is that well before I received my ham radio license at age 11 (KN3OLG, later K3OLG) I had been hooked.

And that hook must have had a barb or two, because I later got a job at WDAD; built my own bootleg station; was on the air at several Pittsburgh stations while going through college at the University of Pittsburgh, where I also was chief engineer of WPGH; was an engineer for AFRTS at Clark Air Base in the Philippines while in the USAF; and was chief engineer for most all the Monterey-Salinas, Calif., stations for over 20 years.

I had a construction permit and was going to build my own station but instead took the money and ran; and then served as chief engineer for several Los Angeles area stations, including what was once the original "Boss Radio," KHJ.

And then I fell.

In retrospect I should have filed a malpractice insurance claim, because as it was later explained to me, had the treating doctor "pinned" the fracture in my right femur rather than simply casting it, I would have been fine. But after three knee surgeries and looking toward a sooner-rather-than-later knee replacement, I've become good at turning discomfort into ignorable background noise for as long as I can, rather than face the inevitable eventual surgery.

Preparation Means Asking Questions

OK, Mother Nature, we hear you.

"Be prepared to deal with the unexpected." That's her lesson for radio in this past season of hurricanes.

Failures and disasters can strike at any time. The first steps in assessing your station's readiness are to define weak spots and institute contingency plans and improvements. To do that, you have to think broadly: "What's the worst that can happen?"

Examine every piece of equipment, asking, "What if this were to fail?" What would you do if your transmitter failed? Your audio processor? Automation system? Satellite dish or receiver? Business computer? STL? Consoles? Do you have a backup plan?

What if you suddenly could not access the studio building? Your transmitter site? Think big here.

What about key employees? How many people know how to assemble traffic logs or perform bookkeeping tasks? Is there a standby engineer familiar with your station? Are studio and transmitter wiring and construction plans available to standby engineers?

Does more than one person know how to perform a task? Do you store daily backups of business computer files off-site? Is there a master document with the names of contractors the station employs (tower rigger, electrician, plumber, heating/air conditioning, snow plowing, satellite technician, fuel supplier, generator service, etc.)? Does the list include contact info for your key hardware vendors? This list should also contain passwords for computer and site log-ins, employee contact information and other such data. The GM should keep this list, and a trusted lieutenant should have a copy too.

A set of tools, DVM, scope, cables and test jigs should be on hand at every station. Common emergency items such as first aid kit, fire extinguisher and flashlights should be at every facility.

An engineer should maintain a supply of spare parts to deal with failures immediately. Fuses, chips, capacitors and other components should be stocked. There should be a Go-To manual that outlines backup plans: How to place another studio on the air if the control room fails. How to change transmitters. What to do in the event of an automation failure.

Have keys and alarm codes to the transmitter site, along with directions for an FCC inspector or standby engineer.

Could you broadcast from the transmitter site should a catastrophe strike the studio?

Could you broadcast from an alternate transmitter site if your main site goes down?

Could you stream an Internet program if you lost your air signal entirely?

Have you thought about conducting an emergency drill for your employees?

Planning is a vital part of surviving disaster and getting back to something like normal business. Get the dialogue started at your station. Identify possible sources of catastrophe to help prepare for the challenges of staying on the air — and very possibly saving lives.

Common sense and preparedness are key tools in maintaining operational continuity. Mom says to use your head. And Mom always knows best.

— RW

With returning to broadcasting an unlikely option, I realized that finding a new career, especially at my age, would require more than simply doing something new. A buffer between my life in broadcasting and something new meant that first I had to stop thinking of myself in the way I had for most all my adult life.

Redefining, actually reinventing, myself was not the dramatic "journey of self-discovery" one hears about, but I have to admit it took several years, beginning with the realization that I had to make a new career choice.

I went back to school and learned more about computers than I ever thought there was to know, and started my own business solving home and small business computer and networking problems.

I now have virtually no commute, no boss, no meetings, no reports and no 3 a.m. panic off-the-air phone calls. I have a 100 percent success rate at solving people's computer problems and enjoy the resulting gratitude from my customers. And the money, while variable, is close to what I used to make in broadcasting.

Do I miss radio? Sadly, not really. I still punch away from my Sirius satellite radio in the car for news or a computer show or two and read a few online sources, but that's about it.

People say the radio industry is changing at an ever-increasing pace. But I've made my change. Now, about those virus and spyware problems.

Jerry Lewine, K6QU
Agoura Hills, Calif.

—EDITORIAL STAFF—

Paul J. McLane	ext. 117	Editor in Chief, U.S.
Leslie Stimson	ext. 129	News Editor/Wash. Bureau Chief
Kelly Brooks	ext. 136	Associate Editor
Thomas R. McGinley	—	Technical Adviser
Michael LeClair	—	Technical Editor, RWEE
John Bisset	—	Contributing Editor
Skip Pizzi	—	Contributing Editor
Marguerite Clark	—	Editor (International), Milan
Rogelio Ocampo	ext. 121	Latin America Editor in Chief
Karina Gerardi	ext. 137	Latin America Editor
Anne-Marie Smith	ext. 126	Assistant Editor (International)
Terry Hanley	ext. 130	Production Editor, RWEE & Listings Coordinator
Keith Tate	ext. 144	Editorial Assistant
Peter Finch	—	Editorial Assistant, Milan

—EDITORIAL CONTRIBUTORS—

W.C. Alexander, Bruce Bartlett, James Careless, Naina N. Chernoff, Harry Cole, Mark Durenberger, Charles Fitch, Ty Ford, Scott Fybush, Frank Grundstein, Harold Hallikainen, Craig Johnston, Paul Kaminski, Peter King, Mark Lapidus, Sharon Rae Pettigrew, Carl Lindemann, Ted Nahil, Tom Osenkowsky, Ken R. Rich Rarey, Tom Ray, Randy Stine, James G. Withers, Travis the V/O Guy, Barry Umansky, Tom Vernon.

Radio World

Vol. 29, No. 26 October 26, 2005

Telephone: (703) 998-7600 • Business Fax: (703) 998-2966 • Editorial Fax: (703) 820-3245
E-mail: radioworld@imaspub.com • Web site: www.rwonline.com

—ADVERTISING SALES REPRESENTATIVES—

US East: John Casey	330-342-8361	Fax: 330-342-8362	e-mail: jcasey@imaspub.com
US West: Dale Tucker	916-721-3410	Fax: 916-729-0810	e-mail: dtucker@imaspub.com
Classified Ads: Claudia Van Veen	703-998-7600 x154	Fax: 703-671-7409	e-mail: cvanveen@imaspub.com
European Sales Mgr., Africa, Middle East: Raffaella Calabrese	+39-02-7030-0310	Fax: +39-02-7030-0211	e-mail: rcalabrese@imaspub.com
Japan: Eiji Yoshikawa	+81-3-3327-2688	Fax: +81-3-3327-3010	e-mail: callem@world.odn.ne.jp
Asia/Pacific: Wengong Wang	+86-755-5785161	Fax: +86-755-5785160	e-mail: wwg@imaschina.com
Latin America: Alan Carter	703-998-7600 x111	Fax: 703-671-7409	e-mail: acarter@imaspub.com

NEXT ISSUE OF RADIO WORLD NOVEMBER 9, 2005
NEXT ISSUE OF ENGINEERING EXTRA DECEMBER 14, 2005

For address changes and subscription renewal, please visit www.rwonline.com and click on "Subscribe to RW." To submit letters

—ADMINISTRATION & PRODUCTION—

Stevan B. Dana	President
Carmel King	Chief Executive Officer
John Casey	Publisher
Mariene Lane	Chief Operating Officer
Chuck Inderrieden	Chief Financial Officer
Eric Trabb	Vice President, Sales
T. Carter Ross	Editorial Director
Davis White	Production Director
Melissa SE Robertson	Production Publication Coordinator
Lori Behr	Ad Traffic Manager
Linda Sultan	Classified/Product Showcase Layout
Robert Green	Circulation Manager



Radio World (ISSN: 0274-8541) is published bi-weekly with additional issues in February, April, June, August, October and December by IMAS Publishing (USA), Inc., P.O. Box 1214, Falls Church, VA 22041. Phone: (703) 998-7600, Fax: (703) 998-2966. Periodicals postage rates are paid at Falls Church, VA 22046 and additional mailing offices. POSTMASTER: Send address changes to Radio World, P.O. Box 1214, Falls Church, VA 22041. REPRINTS: For reprints call or write Emmily Wilson, P.O. Box 1214, Falls Church, VA 22041; (703) 998-7600; Fax: (703) 998-2966. Copyright 2005 by IMAS Publishing (USA), Inc. All rights reserved.

—Printed in the USA—

CHECK OUT OUR LATEST!



The NEW AUDIOARTS D-75 DIGITAL RADIO CONSOLE

A CLEAN, CLEAR on-air design: straightforward layout, easy tabletop installation, and best of all—*completely modular*.

A TRUE plug-and-play radio board from the Wheatstone digital design team!



AUDIOARTS ENGINEERING

sales@wheatstone.com / tel 252-638-7000 / www.audioarts.net

This Little Unit



Can Do BIG Things!

Our new AP-3 is the perfect HD Processor:



SETTING UP FOR HD RADIO?

The VORSIS AP-3 digital processor is the ideal tool to shape your sound exactly the way you want it —cleanly and efficiently.

Built around a multi-band compressor with complementary AGC, the AP-3 replaces a whole rack of dedicated units. VORSIS pre-conditions your signal (HPF, LPF, notch filter, de-esser, expander), then let's you apply 3-band AGC/compression and 4-band parametric EQ (signal chain reversible) before going through a final stage zero-overshoot peak limiter.

With real-time spectrum density readouts and full metering, our included PC graphic interface software makes operation of the AP-3 direct and easy, offering complete control of all audio parameters, presets, monitor functions, system settings and security—all through a single RJ-45 ethernet connection that lets you control one or many AP-3 units.

TAILOR THAT SOUND

VORSIS™

tel 252-638-7000 / sales@vorsis.com / www.vorsis.com

Copyright © 2005 by Wheatstone Corporation

World Radio History