

\*\*\*\*\*3-DIGIT 857  
 S101903 D08 9802  
 BARRY MISHKIND 386  
 2033 S AUGUSTA PL  
 TUCSON AZ 85710 7905

**Buyer's Guide**

The latest products in test, monitoring and remote control.  
**See Page 47**

**Way Up North**

Charles Lakaytis engineers for "the most northern broadcast station in North America."  
**See Page 10**

# Radio World

The Newspaper for Radio Managers and Engineers



February 17, 1999

**INSIDE**

**NEWS**

▼ Radio leaders tell the FCC what they think of the USADR DAB petition.  
**See Page 3**



▼ USADR and FM: Excerpts of the filing.  
**See Page 8**

**ENGINEERING**

▼ Is the new CCRadio "the ultimate AM/FM radio," as advertised? Al Peterson checks it out.



**See Page 19**

▼ Before planning your next election-night extravaganza, learn from the experiences of KPBS-FM.  
**See Page 24**

**GM JOURNAL**

▼ Advocates of minority broadcast ownership look beyond the "access to capital" argument.  
**See Page 27**

▼ Alan Haber points out some of radio's worst Web site mistakes.  
**See Page 33**

**STUDIO SESSIONS**

▼ Flip Michaels on the new Otari MR-30 MiniDisc recorder.  
**See Page 37**

Visit RW Online at [www.rwonline.com](http://www.rwonline.com)

## Here Comes Low-Power FM Radio

*FCC Proposals Could Bring Historic Change; Questions Raised About Interference Standards*

by Leslie Stimson

WASHINGTON "MM 95-25"

The name and docket number are innocuous. But this particular FCC proposal could bring historic change to the FM band,

Bill Kennard has been pressing his colleagues to explore the creation of a new low-power radio service, to enable more "small-pocket" citizens an opportunity to own stations in the age of consolidation. Now, the FCC has taken a big step toward



The FCC took up the low-power issue shortly after moving into its new headquarters in Washington.

with a new class of licensed radio stations. And broadcasters lost no time in blasting the proposal.

As he said he would when he took office just over a year ago, FCC Chairman

the creation of such a service.

The commission has proposed three types of service for the FM band — ranging from 1,000 watts to 1 watt, with coverage areas ranging from about nine to

one miles — and it has asked the public for comment. The FCC ultimately could act on all, some or none of them. The item was expected to be published in the  
 See LOW, page 6 ▶

## QDI Wants You to Pay For EAS

by Lynn Meadows

WASHINGTON Radio station managers are angered and confused by a letter from Quad Dimension Inc. in which the company says stations must pay royalties for using the Emergency Alert System. The supplier says it owns the patent on the federally mandated system.

A first wave of 1,500 broadcast station owners received a package from QDI last month. It included a cover letter and a non-exclusive patent license agreement.

"Anticipating your station's desire to respect the intellectual property rights of others, QDI is writing to offer your station a license under the Patent. A license/royalty payment of  
 See EAS, page 6 ▶

Photo by Paul J. McLane

## TIRED OF BROADCAST PROBLEMS?

GET SOLUTIONS THAT JUST WORK.

worldwide excellence in  
 broadcast transmission products.



*Continental Electronics Corporation*

JUST CONTACT US AT 1-800-733-5011 or [www.contelec.com](http://www.contelec.com) ISO9001 CERTIFIED  
 © 1999 Continental Electronics Corporation

Circle (2) On Reader Service Card

World Radio History

# NEWSWATCH

## 'No Buy' Edicts Found

Advertisers, broadcasters, civil rights groups and federal regulators plan to meet later this month to consider, among other things, whether there should be a voluntary code of conduct for broadcasters, advertisers and ad agencies to oppose unfair ad placement dictates.

According to a study released last month by the FCC, 91 percent of minority stations surveyed said they experienced dictates from ad agencies — instructions from advertisers either not to

buy ads or to pay less money for those ads on urban or Spanish formats.

Respondents said 61 percent of the ads purchased on minority-owned stations were discounted. The study was conducted by the Civil Rights Forum and its authors said its findings were preliminary and suggested further study.

## Chancellor Floats Options

**DALLAS** Will Chancellor sell?

Chancellor Media Corp., the top radio group in terms of both annual revenue

and station count, is exploring its options to maximize shareholder value. Options include a sale, merger or consolidation of one or more of its operating divisions or the entire company. Chancellor has hired investment banker BT Alex Brown to conduct "a strategic review."

## No Tolerance On Structures

**WASHINGTON** All unregistered antenna structures that require registration must be registered immediately, or their owners face possible fines or other

enforcement action.

Generally, antenna structures 200 feet or higher or those near an airport must be registered. A survey by the commission's Compliance and Information Bureau found that 28 percent of antenna structures were not registered. The FCC has begun to identify the owners and licensees of unregistered structures for possible further action.

For more information, see the commission's antenna Internet home page at [www.fcc.gov/formpage.html](http://www.fcc.gov/formpage.html)

## Index

### FEATURES

<b>Workbench: Boom Springs and Nitro Tanks</b> by John Bisset	16
<b>Emmis HQ Is an Indy Showcase</b> by Paul J. McLane	17
<b>Eureka Offers Challenges, Potential</b> by Michael Blackburn	18
<b>Crane Radio Is an AM Champ</b> by Alan R. Peterson	19
<b>KPBS-FM Election Case Study</b> by Bruce Rogow	24

### GM JOURNAL

<b>Minorities Eye Radio Mountain</b> by Lynn Meadows	27
<b>KPTY Party Radio Plays to Young Ears</b> by Dee McVicker	27
<b>Station Financing</b> by Dain Schult	31
<b>Barter Works for Judy Jarvis Show</b> by April Bartel	32
<b>Music Gives Way to Talk At L.A. Legend</b> by Bob Rusk	32
<b>Get Hip to Radio Web Site Rules</b> by Alan Haber	33

### STUDIO SESSIONS

<b>MP3 Delivers Audio for Stations</b> by Jeff Laurence	37
<b>Otari Joins MD Arena With MR-30 Recorder</b> by Flip Michaels	37
<b>The Session From You-Know-Where</b> by Travis	38
<b>Zap Noise With Ray Gun Software</b> by Read G. Burgan	40
<b>Bring Back Wacky DJ Stunts!</b> By Alan R. Peterson	42
<b>Pop Quiz: 1941 Broadcast Terms</b> by Rich Rarey	43

### BUYER'S GUIDE

<b>Many Options for Quality Test Equipment</b> by Bob Shotwell	47
<b>Reducing Costs With the Davicom MAC</b> by John McCloy	47
<b>DSP-Based SCA Monitor From Belar</b> by Dennis J. Martin	48
<b>TCI Enjoys a Slice of the PIE</b> by David Swan	48
<b>Sophisticated Control in St. Louis Complex</b> by Jeff Detweiler	49

## Take a LOOK at THIS:



## Then look at our competition.

OF COURSE many stations are cost-conscious these days—just remember why you wanted a new console in the first place: to UPGRADE.

The R-60 has what's needed, with all the right features: our SIMPLE PHONE® module for easy error-free talk segments; twin six bank preselectors, so you won't run out of input capacity; onboard machine control panel, clock, timer, a well-designed cue system, and a truly effective control room and studio monitor interface. And because it's totally modular, service is easy—even while you're on-the-air! Documentation: this can determine whether you have an installation day or an installation week. We've done it right to guide you through. And PERFORMANCE? Of course we've handled that; simply compare our specs.

**DON'T MISS your opportunity to upgrade.** Choose the R-60 radio console from AUDIOARTS.

<b>FREQUENCY RESPONSE</b>	
Line (10Hz-20KHz)	±1/10dB
Mic (20Hz-20KHz)	±1/10dB
<b>THD+N (20Hz-20KHz)</b>	
Line, +4dBu	.005%
Mic & Line, +16dBu	.005%
<b>IMD (SMPTE)</b>	
Mic & Line, +4dBu	.004%
<b>DIM</b>	
Mic & Line, +16dBu	.005%
<b>DYNAMIC RANGE</b>	
Line	114dB
Mic	98dB
<b>HEADROOM</b>	
ref +4dBu	24dB
<b>OFF &amp; ASSIGN ISOLATION</b>	
1 KHz	-110dB
20 KHz	-105dB
<b>BUS CROSSTALK</b>	
1 KHz	-100dB
20 KHz	-75dB

600 Industrial Drive, New Bern, NC. 28562  
tel 919/252-638-7000 / fax 919/252-637-1285  
E-mail: [email@wheatstone.com](mailto:email@wheatstone.com)

**AUDIOARTS ENGINEERING**

# No Consensus on USADR and IBOC DAB

## Broadcasters and Industry Groups File Comments With FCC on DAB Petition

by Leslie Stimson

**WASHINGTON** How should the FCC implement a terrestrial digital audio broadcasting service?

Judging from comments to the commission, there is little consensus on this question.

For instance, those who own radio stations are at odds with those who do not, but would like to — such as advocates of low-power radio.

Some broadcasters are worried about interference to their existing signals from a hybrid IBOC signal. Others are not convinced that a U.S. terrestrial DAB system should even operate within the existing AM and FM bands and on the existing channels, as IBOC would.

Some advocate the Eureka-147 system, which is in various stages of implementation in Canada, Europe, Australia, and parts of Asia and Africa.

These opinions and more are among the sentiments expressed by broadcasters and advocate groups in formal comments to the FCC. The commission invited comments following a request by USA Digital Radio that the FCC establish rules to make the transition to in-band, on-channel DAB.

### Whose is better?

Two other companies developing IBOC technology, Lucent Digital Radio and Digital Radio Express, used their

decade of industry debate about DAB. The commission began a rule making to look at both satellite- and terrestrially-delivered DAB more than eight years ago; satellite DAB licenses have since been issued. But the current proceeding is strictly for IBOC.

## IBOC may not be the best means of implementing digital radio, and there is no basis for concluding at this time that IBOC ... is in the public interest.

Several sentiments have emerged from the comments.

In its petition, USADR urges the commission to determine that IBOC is the most appropriate means to transition from analog to digital broadcasting; establish interference criteria to ensure the compatibility of analog and digital radio; establish a transition plan; conclude that a commission-adopted transmission standard is necessary; establish testing criteria and timetable to evaluate IBOC systems; and select a single system and transmission standard.

But several commenting organizations opposed the petition, arguing that not enough is known about how each of the

raises serious concerns of interference to, among other types of facilities, Class A stations, short-spaced stations and stations employing existing on-channel technologies, such as FM boosters. In light of these issues, the petition's DAB proposal — to broadcast a radio station's digital signal in the same band and on the same channel as the station's analog signal — may well violate the cardinal principle of any transition to digital: to pro-

"We strongly object to the introduction of digital technology into the existing broadcast services in such a manner as to preclude a new micro-radio service," wrote the National Lawyers Guild Committee, which has represented Free Radio Berkeley and other low-power broadcasters in legal battles. This group supports the Eureka-147 system over IBOC, as does the Citizen Media Corps, led by low-power supporter Steven Provizer.

Implementation of IBOC in its current form, wrote a group of more than 160 low-power supporters called "The Amherst Alliance," would result in the FCC "giving with one hand and taking with the other." Newly licensed low-power stations would not be the only ones in peril, wrote the group. "If IBOC or any other digitization technology is overly sensitive to second adjacent channel interference, then 'rim shot' conventional radio stations — located on the peripheries of metropolitan areas — could be fatally undercut economically."

### Competitors

Lucent Digital Radio and Digital Radio Express opposed items specifically related to the USADR system.

For example, USADR recommends tightening the emission masks slightly for AM and FM stations operating in the hybrid and all-digital modes.

DRE wrote, "USADR has not presented

See IBOC, page 14 ▶

— National Public Radio

protect existing analog transmissions until the transition is virtually complete."

Others who opposed the petition did so to protect the interests of any new services that might be authorized by the FCC, such as low-power radio. (See story, page 1.) IBOC DAB technology is based on existing frequency allocations. Its supporters fear there could be interference to IBOC stations if any new services are added. Because of that unknown, some who support the licensing of low-power stations fear the FCC may license them as analog-only, to prevent interference in the future.

## We strongly object to the introduction (of IBOC) ... in such a manner as to preclude a new micro-radio service.

— National Lawyers Guild Committee

comments as an opportunity to contrast their technology to USADR's and to argue that their systems are better.

The commission now will decide how to treat the USADR petition — whether to proceed with a formal procedure to establish a terrestrial DAB service, or whether to continue to gather information as an interim step before moving forward on a rule making. Either option it chooses is likely to be a lengthy process.

The FCC also could decide not to act on the petition, but that is considered less likely.

This was the radio industry's first chance to react formally to IBOC, after a

IBOC systems would work to lock the country into that form of DAB.

National Public Radio said it was premature to establish implementation rules for DAB, including a transition plan.

"IBOC may not be the best means of implementing digital radio, and there is no basis for concluding at this time that IBOC, as opposed to some other system of digital audio broadcasting, is in the public interest," NPR stated.

Group owner Big City Radio said the commission should not proceed to the rule making phase, and instead, should continue to gather more information. Further, the group said, "The petition

## Frequency Agile STL Systems



- ▲ If you are looking to deliver clean, crisp audio to your transmitter via microwave, Armstrong FML-10 STL system offers unsurpassed audio purity in a rock-solid, feature-packed package.
- ▲ Built to tough manufacturing standards throughout, FML-10 system features microprocessor controllers, advanced PLL circuitry, ultra linear VCO and front panel frequency programmability with digital frequency readout.
- ▲ Currently in service at over 300 stations in 21 countries, this field proven design is a "rock-solid" STL choice for any station.

Complete System Under \$5500.00  
Same Day Shipping  
30 Day Money Back Guarantee



**ARMSTRONG**

TRANSMITTER CORPORATION

4835 N. Street • Marcellus, NY 13108 • PH: 315/673-1269 • Fax: 315/673-9972  
E-mail: info@armstrongtx.com • www.armstrongtx.com

## Simple Connection

Console Harnesses & Prewired Program Racks  
Simply Connect to the Turnkey Distributor ...

**BROADCAST**  
**RICHMOND**

Tel 765-966-6468 Fax 765-966-5505 E broadcast@infocom.com  
Connect to [www.broadcast-richmond.com](http://www.broadcast-richmond.com)

# Wake Up to Radio's Alternatives

*Listen Up: National Media Are Spreading The Word About Your New Competitors*

American consumers are starting to figure out that they can get the "radio" programming they want from places other than the radio dial. Articles in the national press suggest that awareness of these alternatives is on the rise.

For instance, a story in *The Washington Post* last month caught the attention of radio managers around the country. The headline was "The Radio Waves of the Future."

"No longer do radio listeners have to passively accept the couple of dozen stations they can tune in at home or at work, slaves to the corporate formula that dictates repetitive, hit-oriented playlists," wrote *Post* Staff Writer Frank Ahrens. "Right now, almost any standard computer can cheaply become the ultimate radio, tuning in stations from Miami and San Francisco, from Moscow and Singapore. For free. ...

"Don't want to click around? Then build your own radio station, one that plays only country or classical or punk. Even all-Hawaiian, all the time. This, too, is free.

"Sick of finding a tolerable station on your car radio, only to drive out of range in half an hour? Soon, there's a good chance you'll drive coast to coast and listen to the same station that plays your favorite songs, or if you get tired of that, choose from 99 other stations."

## Stagnation?

Ahrens wrote that the \$14-billion-a-year radio business in the United States is "shaking off three decades of technological stagnation. The next few years could revolutionize everything about radio, from how to make money at it to how it sounds."

He compared the trends in radio to the cable TV revolution, and pointed out that the three major TV networks laughed, at first, at the threat from cable.

Now, he wrote, it's radio's turn, thanks to online audio, the coming of satellite

audio services, and technological advances like wireless modems that will change the way audio and other data come into our lives.

The article depended on a recent Arbitron Internet listening study for much of its data. That study was reported in *RW* when it was released last fall.

In fact, a careful reader of *RW* found nothing surprising in the *Post* article. We have been writing about these trends for

years — and we have argued plainly in these opinion pages that radio managers have left themselves wide open to such competition by allowing much of our programming to become homogenized and predictable.

The importance of an article like the one in the *Post* is that it represents a dawning awareness in the mind of the consumer of the possible changes in radio. It should also be a warning gong to owners grown accustomed to double-digit ad sales increases year after year.

## Bombardment

To some extent, radio managers can't do anything about these trends. The Internet is here; bandwidth and data technology will continue to improve; audio and video and content yet unimagined will bombard us via new channels; and new, better methods of bringing audio into the workplace and car will roll out.

But we must not be complacent. The risk for any radio person is that, one of these days, we'll wake up to find that our livelihood has been undercut because we took for granted the listener in the car or at the office.

## Content providers

Many radio stations are aware of this trend and are using the Internet to promote themselves, to generate revenue, to build loyalty and to reach new listeners afar. But they need to do more. They need to consider themselves professional content providers.

**One of these days, we'll wake up to find that our livelihood has been undercut because we took for granted the listener in the car or at the office.**

and use all channels at their disposal, and find new ones.

And they must ask themselves every day, "Am I providing a product that gives the listener and the advertiser a reason to come back?"

The strongest product remains the same as before: good, localized, compelling programming.

I found the tone of the article in the *Post* annoying, but I am not surprised that a newspaper — which, after all, is part of a fiercely competing medium — would put the case so bluntly.

However, as a wise person once said, our critics are our friends, for they help us see our flaws.

Now, are we listening?

★★★

Suppliers, do you offer a news service to radio stations? Our April 28 issue will feature a special Focus on

## From the Editor

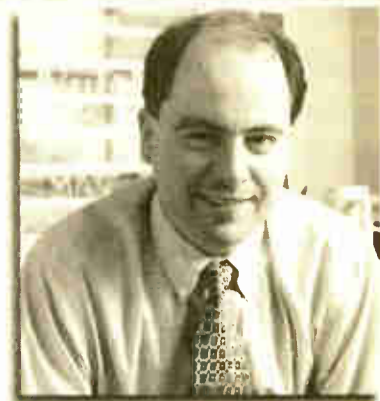

**Paul J. McLane**

News Services. If your organization provides news services, including programs, audio and text feeds, software packages and consulting, we're looking for information about you to share with our readers.

For more info, contact Laurie Cebula, *Radio World* Business Editor, via e-mail to [lcebula@imaspub.com](mailto:lcebula@imaspub.com)

★★★

And a word of greeting to the new national sales manager of *Radio World*, John Casey.

Many readers and advertisers know John from his work as vice president of marketing and sales for Telos Systems/Cutting Edge. His technical and product background is substantial, with past experience at Denon Electronics and RE America.

As a member of the National Radio Systems Committee, John was instrumental in the formation and adoption of a written standard for the Radio Broadcast Data System. He also has been active as an industry author, session panelist and technology educator for the NAB, National Public Radio, the Society of Broadcast Engineers and the Electronics Industries Association. John replaces Skip Tash, whose departure I told you about a few weeks back.

John knows the industry and knows how important *RW* is to you. We're delighted to have him working on behalf of our readers and our clients.

*Burk puts you in control.*



**ARC-16: The industry standard for multi-site transmitter remote control.**

**BURK**  
TECHNOLOGY

Toll Free 1-800-255-8090 ■ email: [sales@burk.com](mailto:sales@burk.com)

*With*  
**NEW**  
**AutoPilot®**  
FOR WINDOWS

*"It's almost like standing in front of the transmitter!"*

## ◆ READERS FORUM ◆

Letters received are the property of RW, and may be edited for space considerations.

## Y2K doom?

Dear RW,

Regarding Mr. Conrad's letter to FCC Chairman Kennard (*Readers Forum*, RW, Jan. 20), he is echoing the sentiments and heartbreak many of us in the trenches feel. I hope the new century does not spell doom for the local owner-operator. It appears we're going to have three companies that own the airwaves.

Tom McCarthy  
Announcer  
KRWM(FM)  
Seattle

## Tokyo Rose' trivia

Dear RW,

Maybe we can help Col. Norm Gertz with his "music trivia" question regarding the Tokyo Rose broadcasts (*Readers*

*Forum*, RW, Jan. 6).

We read his letter on "The Hotline," a daily talk show hosted by city mayor Jeff Graham on WATN(AM). The next day we received an e-mail from a listener with a Web site devoted to "Tokyo Rose." Apparently, no one ever broadcast using that name; rather, it was a nickname given by American G.I.s to the several female announcers on "The Zero Hour" program broadcast by the Japanese.

The site features the story of "Orphan Ann" and includes several audio clips of her broadcasts. If Col. Gertz can get to a computer he should check [http://earth-station1.simplenet.com/Tokyo\\_Rose.html](http://earth-station1.simplenet.com/Tokyo_Rose.html)

While I'm not 100 percent certain, the opening music he is asking about may be titled "My Resistance Is Low." Her program would close with "Goodbye Now."

Joseph L. Brosk  
Broadcaster  
WATN(AM)/WTOJ(FM)  
Watertown, N.Y.

## Radio weather tools

Dear RW,

Thank you for your Dec. 9, 1998, article on radio weather services. The article mentioned to pass along information about any other weather services, so I would like to submit some information about WeatherTrac, of which I am manager and chief meteorologist.

WeatherTrac is a private weather forecasting service serving radio stations throughout the country. We are based out of WISC-TV in Madison, Wis., and have been in business for seven years.

## Correction

In the Dec. 23, 1998 RW, the Web site address for Applied Magic was incorrect. The correct Web site address is [www.applied-magic.com](http://www.applied-magic.com)

## The benefits of compression

Dear RW,

I love e-mail! This wonderful technology lets me become offended by a *Radio World* article and immediately tell you why.

The article in question is in the Jan. 20 issue and was written by Mel Lambert. When I saw that you had titled the piece "Compression: Is It Necessary, Helpful?" I expected to learn something. Unfortunately, what I learned was largely false, misleading and damaging to my company.

As you know, MUSICAM USA is the world's largest manufacturer of digital audio codecs. And I believe you also know that MUSICAM is a registered trademark of Corporate Computer Systems Inc. (d/b/a MUSICAM USA) and should be acknowledged as such, rather than thrown around loosely as was done in the article. Since our products use bit-rate reduction (referred to as "compression" in the article) I'd like to think we know something about the subject.

One of the things we know is that the artifacts created by cascaded bit-rate reduction systems are largely dependent on the compression ratio used. In its simplest form, high compression ratios (i.e., low bit rates) tend to create audible artifacts, sometimes after only one pass through the compression system whereas low compression ratios may be cascaded many times with no audible effects. That's why MUSICAM USA makes codecs that can encode MPEG Layer II audio at bit rates up to 384 kilobits per second, rather than the 128 kbps limit offered by some other manufacturers. MUSICAM compression has been shown to produce no discernible arti-

## USADR Scores a Coup

What does it mean that USA Digital Radio has persuaded 10 more radio groups to invest in its vision of the future of radio?

USADR had been a limited partnership of CBS, Westinghouse Electric and Gannett. With new investment money, described as in the tens of millions of dollars, the company is a corporation comprised of CBS, Gannett, Chancellor Media, Citadel Communications, Clear Channel Communications, Cox Radio, Cumulus Media, Emmis Communications, Entercom Communications, Heftel Broadcasting, Jacor Communications, Radio One and media investment firm Chase Capital Partners. USADR says its investors own a combined total of more than 1,600 stations.

USADR made much of the announcement, touting it as "a strong industry commitment to a digital future."

Some questions about the news are unanswered.

For example, we don't know how much money each of the new groups put in, and USADR isn't saying. So we can't judge if the amount invested by each group is substantial, token or somewhere in between. As a result, it's harder to judge how significant this backing is.

Also, some of the investors said their decision by no means precludes them from either testing or investing in other IBOC systems. It's unclear whether they will.

And what effect will this news have on station engineers who test the USADR system? Will they be influenced by the knowledge that their employers own part of it?

These are important points. But make no mistake. The news is quite a coup for USADR, and for the people driving it — people like engineer Glynn Walden, who has put in countless hours over the past decade trying to explain to owners and regulators what IBOC is and why broadcasters should want it.

USADR was able to convince important radio players to associate themselves publicly with the venture. The company can point to solid broadcast support for its system. It also can proceed knowing that groups other than CBS will be willing to test USADR IBOC on their stations.

The investment demonstrates that USADR has been working to gain broadcaster trust longer than any other proponent. It helps USADR position itself as a broadcast company that is developing technology for broadcasters.

As IBOC approaches reality, this argument may prove to be very important indeed.

— RW

We have a comprehensive service that custom-tailors forecasts and broadcasts to any type of radio format. Currently we service clients ranging anywhere from farm and ag-related stations to Hot AC.

We provide excellent severe weather coverage 24 hours a day, 365 days per year. Our database is packed with all of the latest technology and can track any Doppler radar site in the country. We have six experienced, degreed meteorologists

who are on the clock year-round.

Our rates are extremely competitive. We provide our reports through regular phone lines as well as studio-quality ISDN.

For further information I can be contacted at (608) 877-0313 or on the Internet at [smithj@mailbag.com](mailto:smithj@mailbag.com)

Jeff Smith  
Chief Meteorologist  
WeatherTrac  
Madison, Wis.

facts when cascaded 15 times at 384 kbps.

It is ironic that, while we believe Mr. Lambert is well aware of the scalability of compression, he chose not to mention that bit rate be taken into account when planning an audio path. Rather, he said, "Applied once, twice, or possibly three times to audio material, (compression algorithms) produce no discernible effects. Perform the process several more times ... and you soon realize that something is decidedly odd."

What is also "decidedly odd" is Mr. Lambert's obvious allegiance to ADPCM systems (read: aptX). To make his case, he says, "While less-aggressive sub-band ADPCM systems, for example, could be used safely up (sic) for as many as eight to 10 encode/decode cycles, others with enhanced reduction ratios might need to be limited to one or two generations." Again, this is misleading without providing information about data rates.

I believe that readers are served when they receive accurate and complete information. Unfortunately, this article takes an information shortcut and says, "Compression is bad. Don't use it if you don't have to." But broadcasters, studios and voice-over talents need to use compression to save money on audio transmission and storage. At MUSICAM USA, we have developed equipment that allows them to do just that, without compromising the integrity of their audio. I'm disappointed that this important point wasn't made.

Art Constantine  
Vice President, Business Development  
Corporate Computer Systems Inc., d/b/a MUSICAM USA  
Holmdel, N.J.

## Radio World

Vol. 23, No. 4 February 17, 1999

telephone: (703) 998-7600  
editorial fax: (703) 820-3245  
e-mail: [radioworld@imaspub.com](mailto:radioworld@imaspub.com)  
Web site: [www.rwonline.com](http://www.rwonline.com)

Paul J. McLane ext. 117	Editor
Sharon Rae ext. 126	Managing Editor
Alan Peterson ext. 135	Technical Editor
Leslie Stimson ext. 129	News Editor/ Washington Bureau Chief
Laurie Ann Cebula ext. 198	Business/ GM Journal Editor
Brian Galante ext. 146	Assistant Editor
Thomas R. McGinley	Technical Advisor
Stevan B. Dana	President/CEO
Carmel King ext. 157	Group Publisher
Marlene Lane ext. 128	Editorial Director/Assistant COO
T. Carter Ross ext. 137	Editor (International)
Christine Joaquim ext. 138	Managing Editor (International)
Rogelio Ocampo ext. 121	Latin America Managing Editor
Marguerite Clark	European Editor
Brooke Abernethy ext. 130	Editorial Assistant
Linda Sultan ext. 141	Editorial Assistant
Robert Green ext. 161	Circulation Manager

**Contributors:** W.C. Alexander, James Careless, Harry Cole, Troy Conner, Ty Ford, Alan Haber, Harold Hallikainen, Mario Hieb, Peter King, Mel Lambert, Mark Lapidus, Carl Lindemann, Dee McVicker, Lynn Meadows, John Montone, Rich Rarey, Bob Rusk, Randy Stine, Tom Vernon.

Radio World (ISSN: 0274-8541) is published bi-weekly by IMAS Publishing (USA), Inc., P.O. Box 1214, Falls Church, VA 22041. Phone: (703) 998-7600, Fax: (703) 998-2966. Periodicals postage rates are paid at Falls Church VA 22046 and additional mailing offices.

POSTMASTER: Send address changes to Radio World, P.O. Box 1214, Falls Church VA 22041. REPRINTS: Reprints of all articles in this issue are available. Call or write Michael Crosssett, P.O. Box 1214, Falls Church, VA 22041; (703) 998-7600; Fax: (703) 998-2966. Copyright 1999 by IMAS Publishing (USA), Inc. All rights reserved.

—PRINTED IN THE USA—

Next Issue of Radio World  
March 3, 1999

# Low Power Ahead?

► **LOW**, continued from page 1

Federal Register in early February, at which point would begin a 60-day comment period and subsequent 30-day reply comment period.

In order to shoehorn in what it considers a reasonable number of new stations, the FCC would have to change interference protection standards. That is one reason broadcasters oppose the new service, and why developers of in-band, on-channel digital audio broadcasting are concerned about the potential effect on stations making the transition to DAB.

To allay those concerns, four of the five commissioners said they would not jeopardize the integrity of the FM band.

Commissioner Harold Furchtgott-Roth said he was not opposed to an LPFM service in theory, but he dissented from his colleagues on the proposal that was voted on Jan. 28 because he opposes lessening interference protection standards.

"This is a severe incursion on the rights of current licenseholders, as well as on the value of their licenses, which will be drastically undercut in the market if these proposals are adopted," he stated.

Chairman Kennard said he would not back down on exploring how such a service could be created even though it would be "inconvenient" to existing broadcasters. He said over-the-air TV broadcasters, for example, fought the creation of cable TV service when the commission was considering cable rules.

Nick Leggett, whose petition was among those that helped prompt the FCC to this point, said a new service could be good for radio because it would be "like a farm team," a place for people to develop their radio talents.

"I don't understand why NAB is fighting this as if it's an invasion of the Nazis or something," he said.

The commission could decide to go with one, several, all or even none of the proposed services. But FCC staffers have said Kennard is intent on implementing

some form of new low-power service.

Still unclear is how soon low-power stations could be on the air if such a service is adopted.

The three proposed FM services:

- A primary service with a maximum effective radiated power and antenna height of 1,000 watts and 60 meters, for a coverage area of about 8.8 miles;
- A secondary service with a maximum effective radiated power and antenna height of 100 watts and 30 meters, for a coverage area of about 3.5 miles and;
- A service with a maximum effective radiated power of 1 to 10 watts, for a coverage area of one to two miles. Details on whether these stations would be treated as primary or secondary were not available at press time.

A primary service is fully protected, and licenses are subject to all FCC regulations. A secondary service must shut down if it is causing interference to a primary service. The FCC has proposed that secondary service LPFMs be exempt from some rules and regulations.

The FCC has proposed the services only on FM. Most low-power proponents say they prefer FM for its audio fidelity.

FCC staffers who spoke to **RW** said the commission is trying to eliminate interference in the AM band, and that was a big factor in its decision.

Leggett said it would be a mistake to limit the service to FM.

"I don't agree AM would be simpler. There should be some outlet for home-built equipment, because it's a lot cheaper." He said AM would be appropriate for most of the talk programming that community groups would air on low-power stations.

The commission has proposed minimum distance separation standards between low-power stations. It would require co-channel and first adjacent channel protections, but felt that third channel and possibly second channel protection may not be necessary and asked

for comments on these proposals.

Where would the new stations be located? In researching this proposal, the FCC conducted a study of approximately 60 cities, with populations ranging from more than a half million people to 20,000.

"Some of the big cities couldn't accommodate any additional radio service ... some could perhaps accommodate one or more under different interference conditions," said Keith Larson, assistant bureau chief, engineering, in the Mass Media Bureau.

Proponents believe the radio band has room for more stations.

"The current interference protection standards were developed more than 40 years ago," said another low-power petitioner, Rodger Skinner. "Receivers today are more selective than they were in that period of time. There are several hundred full-power FM stations operating on second and third adjacent channels under grandfathered short-spaced FM rules. They've operated on these channels for years without interference complaints."

Of the current interference protection standards, he said, "We feel they're outdated, outmoded and unnecessary."

## Impact on DAB?

Watching this debate closely are the companies researching an IBOC DAB system. They are sensitive to any changes in station allocations or interference protection standards.

"We are sympathetic to the commission's desire to increase the diversity in radio through LPFM," said Derek Kumar, vice president of engineering for Digital Radio Express. "However, we are concerned that new allocations would make the already troublesome first adjacent channel interference worse. This is the primary 'analog-to-digital' interference mechanism. We hope the commission uses careful frequency planning to mitigate potential problems."

In comments to the FCC about its own petition to begin an IBOC DAB standard, USADR wrote, "The microradio petitions present the commission with a wide range of incompatible requests."

Former unlicensed operator Steven Provizer said he does not believe IBOC DAB is the only way radio in this country can transition to digital, and that alone should not prevent the establishment of a low-power service. "There are so many unanswered questions about IBOC."

## Many questions

How many new stations would result and how they would be licensed are undetermined. Low-power supporters hope for thousands, while FCC Mass Media Bureau Chief Roy Stewart said it is too soon to tell. He believes the figure may be in the hundreds.

Who would qualify for a license? A thorny question is how to treat those who have operated unlicensed stations in the past. The FCC might, for example, set up different policies to handle applications from pirates who shut down when told to, and those who didn't.

"We did not slam the door on those people," said Stewart, referring to unlicensed operators. He suggested that unlicensed operators could be "rehabilitated" and be obliged to wait for an opportunity to apply for a station.

Some low-power supporters told **RW** that, although they do not condone the actions of unlicensed operators, they felt the FCC would not have acted on the low-power issue without that impetus.

# Stations Dunned in EAS Dispute

► **EAS**, continued from page 1

\$240 for calendar year 1999 is due immediately. Beginning in calendar year 2000, an annual royalty payment of \$180 will be due and will continue for the life of the Patent."

## Shock, and wait

The letters shocked many broadcast owners. At the Tennessee Association of Broadcasters, a staffer said, the phones were "ringing off the hook." Michael Schneider of the Texas Association of Broadcasters said that office sent a fax to its members advising them to "take a wait-and-see attitude."

Lawyers, state broadcast associations and the NAB urged stations not to sign anything until the FCC, the National Weather Service and



the Department of Commerce developed a response. The Department of Commerce is the parent agency of both the NWS and the Patent and Trademark Office.

A request for reexamination of the patent is likely to be part of that response.

Three inventors invented a technology called Storm Alert for Emergency. They joined with a fourth partner in 1991 to become Quad Dimension Inc. and received a patent for SAFE in 1992. Michael Fessler, president of Quad Dimension, said the patent covers the entire emergency alerting system, from use of an encoder to the interjection, transmission and monitoring of codes.

In 1992, QDI met with a private national weather provider to explore fielding a private emergency alerting service. The owner informed the group that the NWS was revamping the Emergency Broadcasting System.

Officials at the FCC, aware of the patent thanks to letters and a video sent from Quad Dimension in 1992 and 1994, chose to enact the SAFE system when they issued their EAS rules in 1994.

Those same officials may have believed they were decreeing that stations use a non-proprietary system

See EAS, page 7 ►



**HENRY  
HE  
ENGINEERING**

## INTERFACE AMPLIFIERS ONLY \$159 ea.



**Matchbox II** Interface Amplifier  
Choose the familiar Matchbox II for interfacing consumer-level record/play devices to your pro system. The bi-directional unit offers four independent amplifiers for matching RCA to XLR I/Os. *Mfr. List \$195.00 Now Only \$159.00 at BSW!*



**TwinMatch** Interface Amplifier  
TwinMatch is similar to the Matchbox II, but provides two stereo channels in one direction for playback of consumer level units such as CD players. Features adjustable gain for +4 or +8 dBm systems. *Mfr. List \$195.00 Now Only \$159.00 at BSW!*



**PortaMatch** Interface Amplifier  
This battery-operated version of the MatchBox II is the ideal way to match consumer and pro gear in the field when AC power is not available. Runs on two nine-volt batteries (not included). *Mfr. List \$195.00 Now Only \$159.00 at BSW!*



**BSW**  
BROADCAST SUPPLY WORLDWIDE

**Order Today: 800-426-8434**

Circle (29) On Reader Service Card

World Radio History

► EAS, continued from page 6 from the National Weather Service called the NOAA Weather Radio Specific Area Message Encoder. SAME also uses frequency shift keying to transmit codes that contain both a hazard message to be broadcast and the geographical region affected by the hazard. SAME was never patented.

When the inventors of SAFE applied for their patent in 1991, they submitted a document describing SAME. The officials at the Patent and Trademark Office concluded that the two systems were different enough to warrant a patent be issued for SAFE.

The FCC released its EAS ruling in December of 1994. In June of 1995, several EAS equipment manufacturers received letters from Quad Dimension telling them they needed a licensing agreement to use technology covered by the patent.

According to Jim Gorman of EAS equipment maker Gorman-Redlich, manufacturers were told several times in EAS planning meetings that the FCC was not going to adopt a proprietary system. The company makes the EAS1 model.

#### Claims dismissal

By 1997, the PTO decided to re-examine the patent and dismissed all the claims made in the patent. As part of that process, the inventors have a chance to modify their claims. They did

**The royalty would have effectively doubled the price of an EAS encoder.**

— Jim Woods

so, adding wording to make their alert system more specifically targeted to television and AM and FM broadcast stations. In November of 1998, the PTO upheld the modified claims.

On the one hand of this debate are angry broadcasters, many of whom never wanted to buy EAS equipment in the first place. Now they face the prospect of paying nearly as much to use it.

#### Inventors' due?

On the other is a group of inventors who say they worked hard over many years to develop the SAFE system and deserve compensation for the SAFE patent and helping public safety.

The first 1,500 stations to receive the letter from QDI were informed they had until Jan. 24 to sign their license agreements and send in their checks. A remaining 9,700 letters were scheduled to be sent out soon.

Intellectual property counsels for both Sage Alerting, maker of the EAS Endec, and Harris Corp., which distributes the unit, were investigating the matter.

Jim Woods, vice president of radio and studio product lines for Harris Corp., said, based on the letter and royalty formula outlined in it, "The royalty would have

effectively doubled the price of an EAS encoder."

A spokesman for MTS, maker of the MTS System 3000D, said his company had received a registered package last August with a copy of the patent and a letter asking MTS to contact QDI. MTS did call QDI, but did not hear back.

TFT Inc., maker of the EAS 911 series of encoders and decoders, was receiving about 30 questions daily from broadcasters who had received the QDI letter.

"We're really trying to figure out what is going on here," a TFT spokesman said.

Broadcasters were not happy. The owner of a small Christian AM station said of the yearly fee, "There is no way in the world we can do this." The license agreement specifies that licensees of the

patent may pay a "lump sum discount rate of \$1,495" with written permission from QDI.

"We take a little issue with commercial broadcasters who say they can't afford it because the EAS encoders they purchased were not inexpensive," said Daric Laughlin, one of the SAFE inventors.

#### Total cost

"If you add up the total cost of the licensing fees amounting to about \$15 per month, it's probably less than the cost of the EAS box," Fessler said.

Like many others who received the letter, Bill Allman, owner of WOTR(FM) in West Virginia, said this should be a dispute between the manufacturers and the patent holders.

"I can't see any way that a broadcast

station could be liable," said Tom Taggart, half-owner of WVVW(AM) and WRRR(FM) in Ohio and a vocal critic of EAS in the past.

In a letter to RW, Fessler wrote, "Some broadcasters are asking why QDI is not asking manufacturers of EAS hardware for licensing agreements instead of them. The reexamined SAFE patent encompasses a system that contains emergency warning location and type codes that are interjected, transmitted and received using the AM/FM or TV broadcast channel. The hardware being sold by the EAS equipment manufacturers is a subset of the patented system."

"Broadcasters are the ones using claims 1-17 of the SAFE system," Fessler said. "The box can't perform the functions of the SAFE patent."

## ISDN Simplicity.



**Broadcasting on ISDN doesn't have to be complicated or expensive.**

The Nexus has everything you need for full-fidelity, low delay, mono audio on ISDN. And it is extremely easy to use. With a list price of only **\$2,300**, there's no need to wait any longer to sound great.

**(800) 237-1776**

Comrex Corporation, 65 Nonset Path, Acton, MA 01720

Fax: (978) 635-0401 Fax-on-demand: (978) 264-9973

Email: info@comrex.com

**COMREX**  
www.comrex.com

# USADR and FM DAB Performance

In October, USA Digital Radio asked the Federal Communications Commission to seek public comment on its petition to implement digital AM and FM broadcasting in the United States. The following are excerpts from its Petition for Rule Making. This is the third in a series. The previous part appeared in *RW Feb. 3*.

An Acrobat version of the full text of the petition is available online at [www.fcc.gov/mmb/](http://www.fcc.gov/mmb/) and the text is also available at [www.fcc.gov/Bureaus/Mass\\_Media/Filings/rm9395.pdf](http://www.fcc.gov/Bureaus/Mass_Media/Filings/rm9395.pdf)

Footnotes with source references and other details are omitted here but are available in the online version.

(This excerpt resumes during a description of the USADR FM IBOC DAB System.)

## 4. FM IBOC Signal Generation

A functional block diagram of a hybrid mode FM IBOC DAB transmitter is presented in Figure 7. The sampled stereo audio source

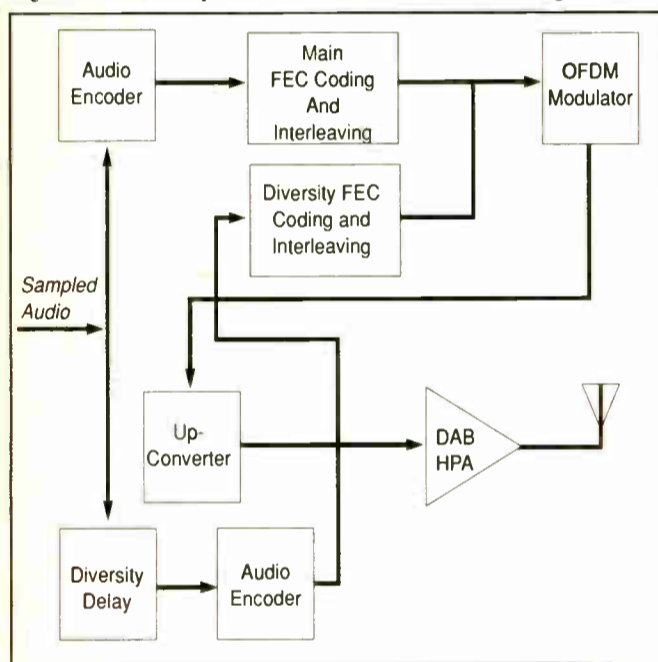

Figure 8: FM IBOC All-Digital Transmitter Functional Block Diagram

feeds both the analog and DAB signal generation paths. A diversity delay is introduced in the analog path for blend to backup audio purposes. In the power combiner method shown here, the audio is processed and delivered to the analog exciter for amplification by the high power amplifier ("HPA").

First, the DAB path source encodes the audio signal in the audio encoder. To ensure that the broadcast of information through the fading channel is robust, the compressed bit stream is then passed through the FEC coding and interleaving function. The resulting bit stream is packaged into a modem frame and QPSK- and OFDM-modulated to produce the DAB baseband signal. This baseband signal is upconverted and amplified before being power-combined with the analog signal.

As shown in Figure 8, the all-digital transmitter replaces the analog signal path with a shorter interleaver and FEC.

## 5. FM IBOC Signal Reception

USADR IBOC DAB receivers will be backward and forward compatible: they will receive both analog and digital broadcasts in the interim hybrid period, and will be fully compatible with the future all-digital period.

A functional block diagram of an FM IBOC receiver is presented in Figure 9. The signal is received by the antenna, passed through an RF front end, and mixed to Intermediate Frequency ("IF"), as in existing analog receivers. Unlike

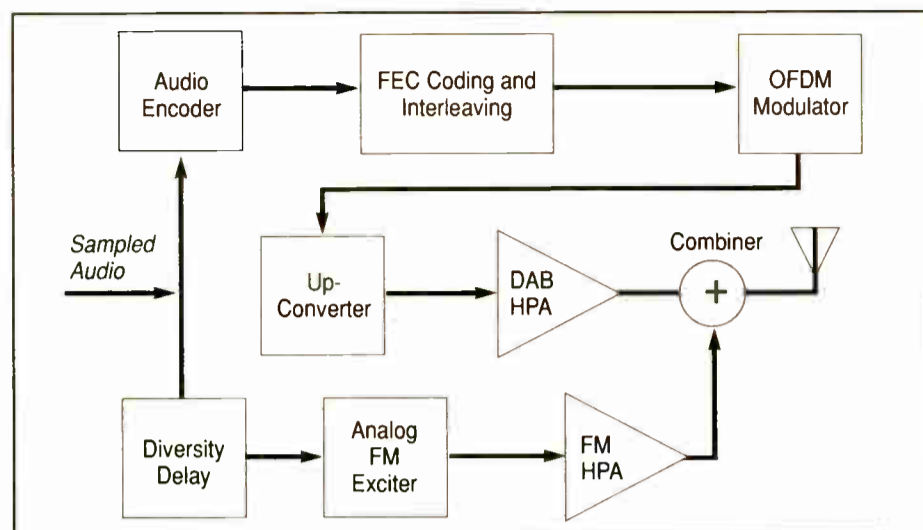

Figure 7: FM IBOC Hybrid Transmitter Functional Block Diagram Showing Power Combiner Method

typical analog receivers, however, the signal is then digitized at IF, and digitally down-converted to produce in-phase and quadrature baseband components. The hybrid signal is then separated into an analog FM component and a DAB component. The analog FM stereo signal is digitally demodulated and de-multiplexed by the FM receiver to produce a sampled, stereo audio signal.

The baseband DAB signal is first sent to the modem, where it is processed by the FAC to suppress interference from potential first-adjacent analog FM signals. The signal is then OFDM demodulated, deframed, and passed to the FEC decoding and de-interleaving function. The resulting bit stream is processed by the codecs to decompress the source-encoded main digital back-up audio signals. These signals are then passed to the blend function.

## B. FM System Performance and Compatibility

### 1. Introduction

IBOC DAB system performance is dependent on several factors, including power, bandwidth, and spectral placement of the digital sidebands. USADR has balanced these factors to mutually optimize digital system performance, analog compatibility and audio quality.

To verify that the resulting design is indeed capable of harmonious co-existence in both current and future environments, the system was modeled and simulated using state-of-the-art computing resources. The computer simulations focused on two areas of compatibility. First, performance of the digital signal in an environment comprised of both existing ana-

log and IBOC signals was examined. This first group of simulations investigated performance of hybrid and all-digital IBOC signals in the presence of various combinations of co- and adjacent-channel analog, hybrid, and all-digital signals. Second, the effects of digital signals on existing analog broadcasts were analyzed. These simulations measured the degradation introduced by appending DAB

sidebands to an analog FM signal.

The methodology, simulations, and results were independently verified by recognized electrical engineering experts, Dr. R.L. Pickholtz and Dr. B.R. Vojcic, and are presented (in the filing appendix).

### 2. FM IBOC hybrid and all-digital mode performance

A variety of simulations and analyses have characterized the performance of the FM IBOC DAB hybrid and all-digital modes while subject to various combinations of three types of impairments: Gaussian noise, multi-

coverage and existing analog coverage.

#### Gaussian Noise

These simulations set an upper bound on system performance, and allowed validation of the model. Results indicate that the hybrid signal has a margin of 22.5-dB at the protected contour of a Class B station.

#### Multipath Fading

Simulations were run using four different multipath models, covering a range of vehicle speeds and locations. Results indicate that the hybrid signal has a margin of 9 to 20 dB at the protected contour of a Class B station. These results indicate that the coverage of virtual CD-quality digital audio in a mobile environment will approximately match the coverage afforded by existing analog broadcasts in the same channel.

#### Independently Faded Interference

These simulations were performed in the presence of various combinations of co-channel, first-adjacent channel, and second-adjacent channel interference from analog, hybrid and all-digital signals. The simulations modeled a number of interference scenarios, ranging in severity from typical to "worst-case."

Simulations were run in the presence of a single first-adjacent interferer of varying amplitudes. Results indicate that the hybrid signal has a margin of 13 dB at the protected contour of a Class B station.

Conditions were further deteriorated by then placing a second first-adjacent signal on the opposite sideband of the desired signal. Results indicate that, with two high-level first-

## The coverage of virtual CD-quality digital audio in a mobile environment will approximately match the coverage afforded by existing analog broadcasts in the same channel.

adjacent interferers which would only be present in a short-spaced scenario (+6 dB D/U on each sideband) the hybrid signal has a margin of 3 dB at the protected contour of a Class B station. (D/U is defined as the desired to undesired signal ratio.) Hence, even in an arguably worst-case mobile environment with both digital sidebands impacted by large analog interferers, the system continues to deliver virtual CD-quality digital audio out to a Class B station's protected contour, with margin.

Since there is no direct overlap of energy between the desired digital signal and second-adjacent signals, and since the FCC provides

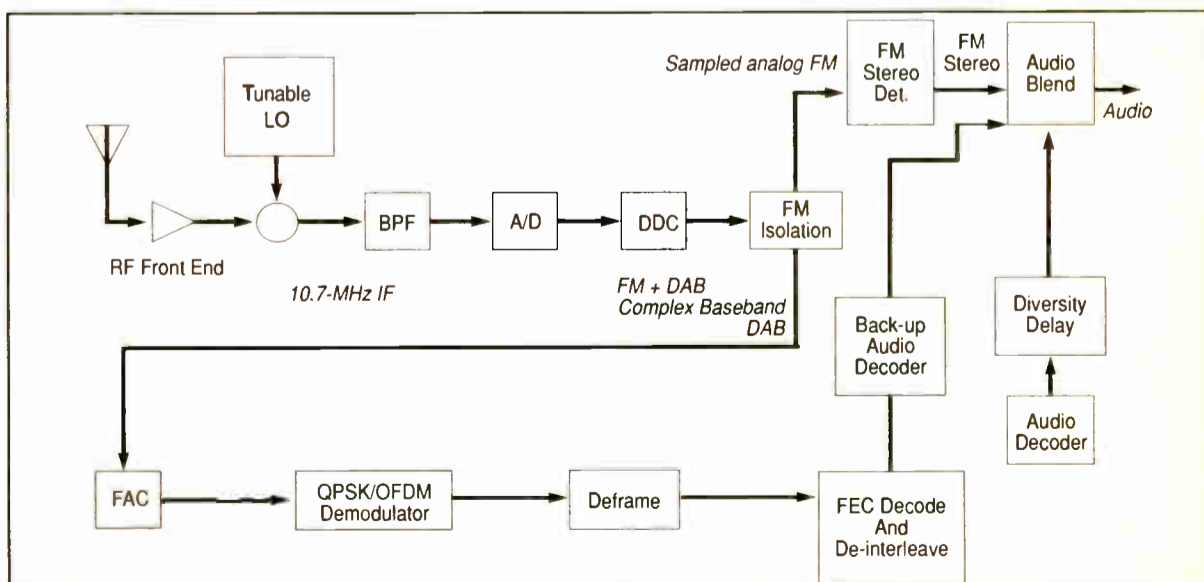

Figure 9: FM IBOC Receiver Functional Block Diagram

path fading, and interference. The simulations determined the margin of the received digital signal at the analog protected contour. This permits comparisons between potential digital

significant protection against co-channel interference, the effect of these types of interference is minimal.

See FILING, page 12 ▶



# ONE LOVES TO TRAVEL, THE OTHER PREFERS TO STAY HOME



## ZEPHYR IS EVERYWHERE.

*The irrepresible Telos Zephyr has earned a hard and fast place in the hearts of broadcasters, engineers, and recording professionals around the world. Why? With its integrated ISDN terminal adapter, MPEG Layer 3 and Layer 2 compression technology, optional AES/EBU digital I/O, and an intuitive user interface, the Zephyr was designed by Telos specifically for broadcast audio applications over ISDN. It's the ideal solution for remote mixing and broadcasts, ad hoc networks, recording sessions, voiceovers, distribution of commercials, backup to satellite and microwave links, and nearly any other application you can imagine. How could anyone function in today's world without one?*



## ZEPHYREXPRESS IS EVERYWHERE ELSE.



*With its ground-breaking design and capabilities, the amazing new ZephyrExpress takes Zephyr's industry-leading operation wherever you need to go, and combines a full-featured ISDN codec and three digitally-controlled stereo mixers in a single, road-worthy chassis. With an unprecedented, easy-to-use interface and specs that blow away most studio codecs, the ZephyrExpress is like nothing you've ever experienced. Now you can hit the road without having to leave your Zephyr behind.*



**The Best Way to Hear from There™**



Telos Systems • 2101 Superior Avenue • Cleveland, OH 44114 • Tel: +1.216.241.7225 • Fax: +1.216.241.4103  
E-mail: [info@telos-systems.com](mailto:info@telos-systems.com) • [www.telos-systems.com](http://www.telos-systems.com)

Telos Systems, the Telos logo, Zephyr, and The Best Way To Hear From There are trademarks of TLS Corp.  
Other trademarks are the property of their respective holders.

# North to Alaska — Way North

by Bob Rusk

**BARROW, Alaska** Broadcast engineers are pretty hearty souls. They work routinely under tremendous pressure, and often perform their jobs in surroundings that are far from ideal.

Charles Lakaytis could write the book on that. His workbench literally sits near the top of the world, where, for much of the winter, the sun does not rise and the temperature stays below zero.

Lakaytis recently came in from the cold to chat by phone with **RW**. He is chief engineer at public radio stations KBRW-AM-FM in Barrow, Alaska, an Eskimo village north of the Arctic Circle. The station is the most northern broadcaster in North America, at 72 degrees North and 155 degrees West.

"This time of year, the temperature is about -5 degrees Fahrenheit, the wind is blowing, and there is anywhere from six to 12 feet of snow on the ground," he said. "That

makes things interesting."

On this day, Lakaytis was in the midst of completing a major project, moving equipment into the new AM transmitter building, which is six miles from town.

"To get into the building, we first had to spend about three hours digging snow



'Another three feet, and we can get in.' Chuck Lakaytis digs out the temporary transmitter building.

away from the door," he said.

A fire of undetermined origin destroyed the former building, as well as the main and standby transmitters, and it

has taken more than two years to finish the new facility. Weather played a major role in that timetable, as it does with many aspects of life here.

"We got caught in a weather cycle and lost a year," Lakaytis said. "We had a temporary building skidded in on the snow, and 37 days after the fire we were



Travelling the last 1,000 feet of a long journey, a new Nautel transmitter moves through the tundra on a Rollagon.

back on the air with a Nautel transmitter. Lots of folks, including RF Specialties and Kintronic Labs, were instrumental in getting us back on the air."

## Long journey

Regular jet service provides the only year-round access to Barrow, population 4,300. It is the northernmost community in continental North America. That isolation means equipment takes a long journey before it is delivered.

The new transmitter, for example, was sent by truck from Canada to Seattle, Lakaytis said. It was then put on an ocean liner and shipped to Anchorage. From there, it was trucked to Fairbanks. Two weeks after its journey began, the transmitter finally arrived in Barrow aboard a DC-6 cargo plane.

"Anyplace else it would have arrived in a moving van at the front door of the transmitter site," said Lakaytis. Both FedEx and UPS serve Barrow, but even when Lakaytis needs something as basic as solder, it still may take a couple days to get it from a supplier in Anchorage or Fairbanks.

"It's not like I can call Radio Shack and then drive down there and get it," he said. "There isn't a parts store within 400 miles."

## Hard work

In addition to his responsibilities at KBRW-AM-FM, Lakaytis is in charge of maintaining five satellite-fed translators in the remote villages of Anaktuvuk Pass, Kaktovik on Barter Island, Point Hope, Point Lay, and Nuiqsut. He averages 50 hours a week on the job, and has even put in some 20-hour days. The work takes its toll.

"I'm not a young man anymore. I can feel it at the end of the day," said Lakaytis, 56. "You have to be prepared for the times when it's -20 degrees F and your truck gets stuck in a snowdrift. You might have to sit there for six or seven hours before you get extricated." Because of Alaska's proximity to the North Pole, extreme darkness and daylight add to the stress of working in the Last Frontier. The sun does not rise in Barrow between Nov. 18 and Jan. 24. The sun does not set in Barrow between May 10 and Aug. 2.

Lakaytis, who has been in broadcast engineering since 1980, had worked in the biomedical and nuclear engineering fields. He was chief engineer at public station KANZ(FM) in Garden City, Kan., in 1984 when he accepted a job at KRBD(FM) in Ketchikan, Alaska.

Lakaytis, who also operated a contract engineering business, moved to Barrow in 1996 to help put new station KBRW-FM on the air. There may soon be a third station in town. The non-profit corpora-

tion that owns KBRW has applied for another FM license.

The residents of the North Slope can rely on radio to bring them the latest news, information and entertainment from the rest of the world.

"We use Arrakis Systems' DL3 network automation. It would simply be impossible to operate without that," Lakaytis said. "We're also using several Arrakis Systems' DL4 digital audio recorders. Our objective is to have all of our sound on hard drive by the middle of 1999."

## Serving the North Slope

KBRW-AM-FM serves the culturally diverse population of Alaska's North Slope with a blend of local and network programming in the Inupiat Eskimo, Tagalog (Filipino) and English languages.

KBRW(AM) airs shows including NPR's "Morning Edition," and is the only full-service station serving the region. The daily lineup on KBRW-FM includes several hours of the WFMT Jazz Satellite Network.

The community-owned and -operated stations broadcast 24-hours a day and are licensed to Silakkuagvik Communications Inc., a non-profit membership organization with a board of directors controlled by Alaskan natives.

"Silakkuagvik" is an Inupiat word that means "voices that fly through the air" and, as stated on the stations' Web site, "serves as a constant reminder to each of us at KBRW that our mission is to communicate the important issues of the day to the 8,000 citizens of the North Slope through a radio program service that has something for everyone."

For more, visit the stations' home page, [www.kbrw.org](http://www.kbrw.org)

## TRY SOMETHING REALLY COOL!

**Cool Edit Pro**

The complete multitrack recording studio for Windows™

**The easiest way to:**

- Record and build spots, news, and clips
- Add music and sound f/x
- Stretch or condense

"Cool Edit Pro has been the dream come true that we have wanted for decades: a low cost production studio software package that has the power of any hardware studio we have worked in. Our morning shows across North America now have the capability of doing all their show preparation in their home studios with Cool Edit Pro. It is not just a new program, it's a revolution that has changed the way radio is done."

- Bob Hamilton, New Radio Star

"It's difficult to go anywhere in Cool Edit Pro and not hear yourself whispering to yourself 'this is cool.'"

- Dave Oliwa, Radio And Production, May 1997

Check out our downloadable demo at:  
<http://www.syntrillium.com>

PO Box 62255  
Phoenix, AZ 85082-2255 USA  
cepro@syntrillium.com  
+1-602-941-4327  
+1-602-941-8170 (fax)  
1-888-941-7100 (US & Canada toll-free calls)

Technology and Price Breakthrough

# NEW-Your Complete Digital Solution!!!

Perfect Cart machine replacement: play, stop, pause, loop, link . . .

Perfect for Live Assist: Jingle Box, Phoner Editor, & much more . . .

Perfect for Automation: Voice Over Recorder, Segue Editor, & more . . .

From the #1 manufacturer of Digital Workstations in Radio !!!

**Live On Air**  
**\$495**



**Live Assist \$1,995**



**Hard Disk Automation**  
**\$2,995**

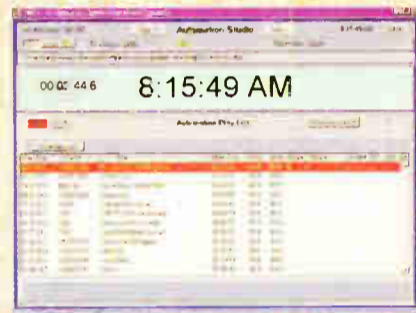

(includes Live Assist software)

**Cart Machine Control**  
**\$750**



Optional Front \$495



Triple Play &  
Record

**Jingle Box Control**  
**\$1,195**



## DL4 Digital Audio Engine

\$2,995 (24 hrs ~ 2,000 spots)    \$5,295 (105 hrs ~ 2,000 songs)

The DL4 is a technology & price breakthrough !!! More reliable and 1/4 the price of comparable products, the DL4 is NOT a PC computer with sound card in it. The DL4 is in fact a digital audio appliance that is controlled by Arrakis LCD control panels, jingle boxes, and Windows 95 PC computers. If the PC fails, your audio library is still available !!! Expandable from 3 Plays & 1 Record to up to 96 Plays & 32 Records, the DL4 fits any size station's needs. You can even use your favorite PC based digital editor for production with the DL4 On Air !!! Call TODAY to find out how little it will cost for you to SAVE money and move into the 21st century !!!

Arrakis Systems inc. (970) 224-2248 [www.arrakis-systems.com](http://www.arrakis-systems.com)



# Excerpts of the USADR Petition

► FILING, continued from page 8

The results described above apply to desired hybrid signals. However, they may easily be extended to all-digital signals. Since the all-digital sidebands enjoy a 10 dB increase in power over the hybrid sidebands, all of the above results are improved by roughly 10 dB for the all-digital system.

### 3. Analog FM performance in the presence of IBOC DAB signals

USADR modeled a typical automobile FM stereo receiver. Simulation results and conclusions presented herein are based on performance of this receiver.

#### a. Effects of IBOC digital sidebands on analog host FM performance

##### Main audio channel performance

Results indicate that the audio noise level increases with the deviation of the FM signal. Although these results are intriguing, they do not predict degradation in host FM audio quality due to IBOC DAB. Because the DAB-induced post-detection noise floor increases in proportion to the deviation of the FM signal, the effect is self-masking: audio noise will be lowest during quiet passages, and highest only when the audio is loudest. The FM IBOC DAB signal was shown to induce an SNR of better than 77 dB in the simulated receiver during quiet passages. Since implementation constraints often limit receiver SNRs below 60 dB, this should render DAB-induced audio noise imperceptible to the listener. Actual performance will depend on receiver implementation, signal strength, and ambient environment.

##### SCA performance

USADR ran simulations to determine the impact of subcarriers on IBOC DAB host FM performance, and to determine the impact of DAB on the performance of SCAs. Simulations indicate that a 92 kHz SCA reduces the host FM audio SNR from approximately 77 to 70 dB; however, this noise level is still too low to produce audible effects in the modeled receiver.

**The audio noise level increases with the deviation of the FM signal. Although these results are intriguing, they do not predict degradation in host FM audio quality.**

Simulated SCAs located at 67 kHz were found to have even less impact on audio performance. IBOC simulations indicate that the SNR of a 67 kHz SCA (in a 10 kHz bandwidth) is 25-30 dB near the transmitter, while for 92 kHz SCAs, the SNR is 20-25 dB. The increase in noise may not pose a problem for digital SCAs (e.g., Seiko and Radio Broadcast Data System), since they should be robust enough to operate at reasonably low SNRs.

##### Stereo subcarrier demodulation

To recover stereo information, the 30-kHz-wide, double-sideband amplitude-modulated left-minus-right ("L-R") signal centered at 38 kHz is demodulated using a 38 kHz local oscillator ("LO"), and subsequently filtered with a 15 kHz lowpass filter. In most receivers, the 38 kHz

LO is simply a square wave, with a 38 kHz fundamental and odd harmonics at 114 kHz, 190 kHz, etc. As a result, in the absence of adequate filtering, not only is the desired L-R signal recovered, but so is any noise in the multiplex signal that lies within +/- 15 kHz of 114 kHz (noise around 190 kHz should be filtered prior to FM detection). This noise causes a 3 dB stereo SNR degradation in inexpensive receivers which

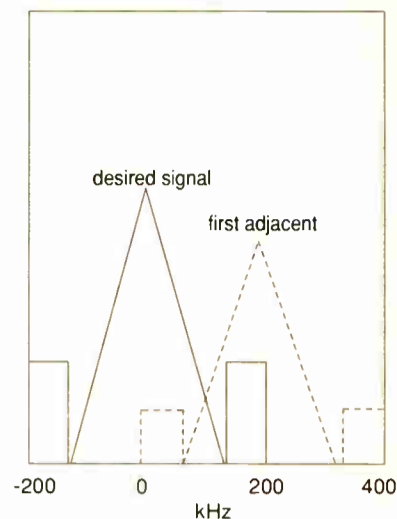

Figure 10: Interference Scenario Showing Hybrid First Adjacent at -6 dB

first-adjacent analog interference was characterized for five different radios in an EIA study. The results indicate that degradation from the analog portion of a first-adjacent hybrid signal in typical receivers (automotive, home, and boombox) should mask additional interference introduced by the digital portion.

##### Second adjacent channel interference

Interference from second adjacent hybrid IBOC channels located +/- 400 kHz from the host signal can be derived from the relationship of the adjacent signals shown in the plot of Figure 11.

The figure illustrates that the digital sidebands of the hybrid second adjacent signal fall well outside the bandwidth of the desired FM signal. Likewise, the all-digital sidebands also lie well outside the analog FM receiver pass-band. FM pre-detection filtering in the receiver front end should reject most of their energy. As a result, the effects of second-adjacent hybrid and all-digital IBOC signals should be negligible.

##### Co-channel Interference

Interference from a hybrid co-channel will be dominated by the analog portion of the hybrid signal. As a result, the performance of a desired analog signal in the presence of a hybrid IBOC co-channel should be similar to the performance currently exhibited by analog FM. The analog portion of a co-channel interferer is not present in the all-digital system. In addition, the digital energy is concentrated away from the center of the desired channel. As a result, the interference from a co-channel all-digital signal should be far less than that currently incurred from analog FM co-channel signals.

#### 4. Summary

The IBOC signal has been designed to be compatible with both existing and future radio frequency environments of IBOC signals. In

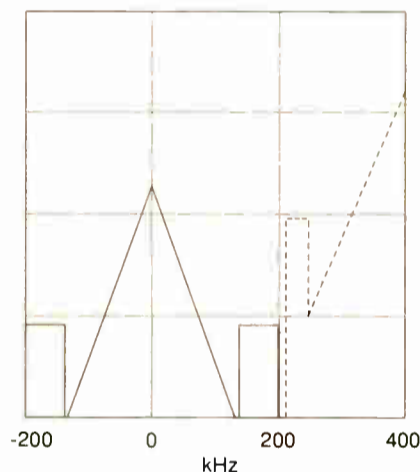

Figure 11: Interference Scenario Showing Hybrid Second Adjacent

by the addition of DAB in radios with inadequate filtering. In a typical ambient environment, with inexpensive receivers, it is possible that any degradation will be imperceptible to the listener.

#### b. Effects of interference on analog host FM performance

##### First-adjacent channel interference

Interference from first-adjacent hybrid IBOC channels located +/- 200 kHz from the host signal can be derived from the relation-

**Simulations indicate that a 92 kHz SCA reduces the host FM audio SNR from approximately 77 to 70 dB ... Simulated SCAs at 67 kHz were found to have even less impact on audio performance.**

ship of the adjacent signals shown in the plot of Figure 10.

Simulations have set the static power of the analog portion of the hybrid interferer to be 6 dB below the desired host FM power (maximum first adjacent level at protected contour). Simulation results show that introduction of a -6 dB hybrid IBOC first adjacent channel degrades the SNR in the modeled receiver at the 54 dBu contour to about 50 dB. Degradation in typical receivers caused by

addition, IBOC signals will provide robust digital coverage, even in the presence of multipath fading and strong interference. Indeed, simulations indicate that in many instances, the digital coverage will extend to the protected coverage areas of the existing analog station, with significant margin.

■ ■ ■

The next installment, describing the USADR AM system, will appear in the March 3 issue of RW.

**RADIO FREQUENCY SYSTEMS**

**RFS Broadcast**

**Total Systems Solutions for FM Radio**

- Complete RF Systems for FM Radio
- Broadband or Single channel
- Feeders, rigid line, switching units, pressurization equipment
- Range of combiners from Starpoint through to Balanced
- Horizontal, vertical and circularly polarized applications

**RFS Broadcast**  
**59 Dodge Ave**  
**North Haven CT, 06473**

**tel +1 203 239 3311**  
**fax +1 203 239 9260**  
**info@rfsbroadcast.com**

# COMPARE

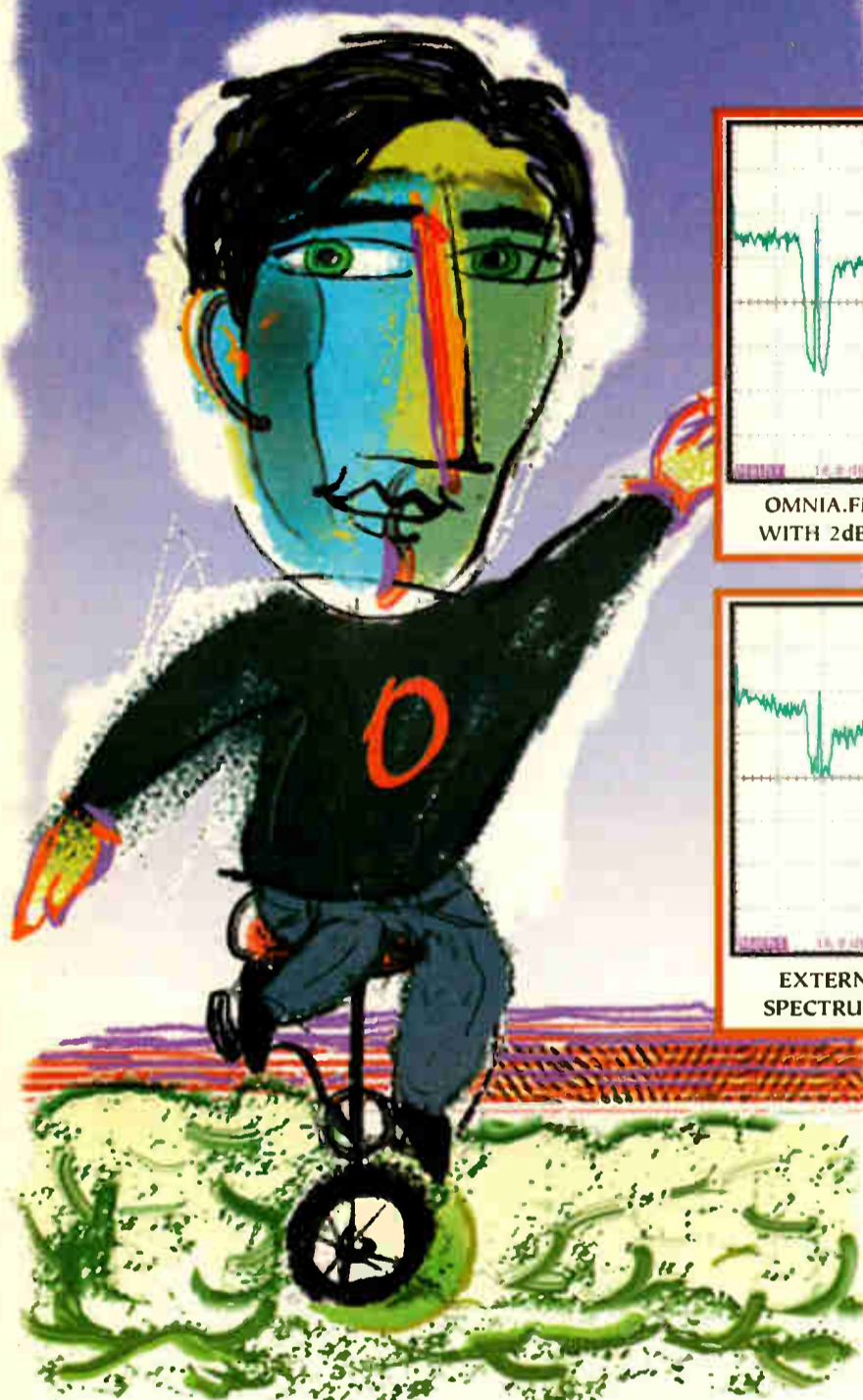

**W**hen you compare digital audio processors, it's not apples to apples. Why? Because only the Omnia.<sup>®</sup>fm gives you adjustable composite clipping, a powerful technique used by thousands of broadcasters for PD-pleasing loudness-loudness that can't be achieved in any other way, no matter which processor you're using.

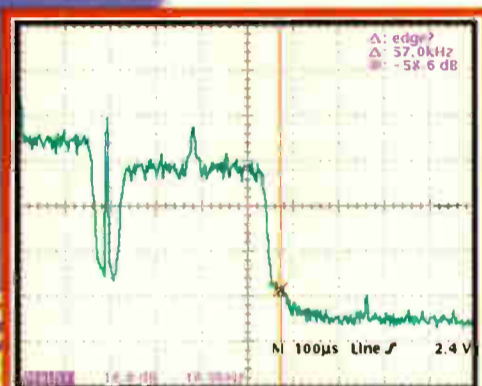

OMNIA.FM COMPOSITE SPECTRUM WITH 2dB OF COMPOSITE CLIPPING

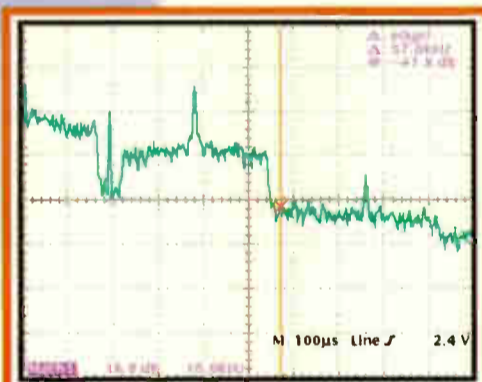

EXTERNAL COMPOSITE CLIPPER SPECTRUM WITH 2dB OF CLIPPING

You can have this power without worry: The Omnia.fm includes a precision digital composite low-pass filter which eliminates interference to subcarriers (including RDS) from clipping by-products. And since the pilot is added after the clipper, it remains unharmed.

Sure, you can tack on an external composite clipper to other digital processors. But with the Omnia.fm's integral composite clipper, operation can be controlled remotely and included in stored presets. And because of the Omnia.fm's unique, non-aliasing final limiter, you have rock-solid peak control, even without composite clipping. Put it all together and you have the Omnia.fm's clean spectrum, loud, punchy sound and *absolutely no digital grunge*.

Make your own comparison and you'll find that the Omnia.fm provides unmatched performance, with or without composite clipping. Only the Omnia.fm gives you a choice. And only the Omnia.fm gives you a free 60-day demo with a money-back guarantee\*.

*Here's how:* The test signals were generated by a Delta Electronics SNG-1 (Stereo Noise Generator); spectrum analysis was performed with a Tektronix TDS-744A Digital Scope in the FFT mode. The top graph shows the spectrum out to 100kHz of the Omnia.fm with its built-in, all-digital composite clipper and composite low-pass filter. The bottom graph shows a different processor combined with an external composite clipper. Both composite clippers were set for 2dB of clipping. Notice in the bottom graph the significant harmonic energy in the SCA region as a result of composite clipping.

For a complete technical report, call us for a copy of our paper entitled "Omnia.fm: An Engineering Study." Or visit our web site at: [www.nogrunge.com](http://www.nogrunge.com).



CUTTINGEDGE

2101 SUPERIOR AVENUE CLEVELAND, OH 44114 TEL: +1 (216) 241-3343 FAX: +1 (216) 241-4103 E-MAIL: [INFO@NOGRUNGE.COM](mailto:INFO@NOGRUNGE.COM) WWW:[NOGRUNGE.COM](http://NOGRUNGE.COM)

\*Contact your dealer for details on this demo program. Demo requests must be accompanied by a purchase order so our dealers know you're really serious about some serious sound.

- Audio Broadcast Group 3685 Roger B. Chaffee Blvd. Grand Rapids, MI 49548 Tel: +1 (800) 999-9281 Fax: +1 (616) 452-1652 e-mail: [support@abg.com](mailto:support@abg.com)
- Bradley Broadcast Sales 7313G Grove Road Frederick, MD 21704 Tel: +1 (800) 732-7665 Fax: +1 (301) 682-8377 e-mail: [Info@bradleybroadcast.com](mailto:Info@bradleybroadcast.com)
- Broadcasters General Store 2480 SE 52nd Street Ocala, FL 34480 Tel: +1 (352) 622-7700 Fax: +1 (352) 629-7000 e-mail: [bgs@mercury.net](mailto:bgs@mercury.net)
- Broadcast Supply Worldwide 7012 27th Street West Tacoma, WA 98466 Tel: +1 (800) 426-8434 Fax: +1 (800) 231-7055 e-mail: [info@bswusa.com](mailto:info@bswusa.com)
- Crouse-Kimzey Company P.O. Box 155999 Fort Worth, TX 76155 Tel: +1 (800) 433-2105 Fax: +1 (972) 623-2800 e-mail: [sales@proaudio.com](mailto:sales@proaudio.com)
- Radio Communications Unlimited 5509 Barrington Ooltewah, TN 37363 Tel/Fax: +1 (423) 396-3743
- Caveco 1121 Bellamy Road, North Unit #10 Scarborough, ONT M1H 3B9 Tel: +1 (416) 438-6230 Fax: +1 (416) 438-1065 e-mail: [bob@caveco.com](mailto:bob@caveco.com)
- Marketing Marc Vallée 1067 Chemin St. Lambert St. Sauveur de Monts, QE J0R 1R1 Tel: +1 (450) 227-1828 Fax: +1 (450) 227-8394 e-mail: [marc@vallee.com](mailto:marc@vallee.com)
- All Electric 487 Cariboo Crescent Coquitlam, BC V3C 4X7 Tel: +1 (604) 945-5651 Fax: +1 (604) 945-5652 e-mail: [allelec@dowco.com](mailto:allelec@dowco.com)

Circle (82) On Reader Service Card

# Wrestling With IBOC's Future

► IBOC, continued from page 3

sufficient evidence in its petition that actual system hardware performance will accomplish the coverage goals of IBOC in realistic signal reception circumstances at the proposed power levels." DRE went on to say that the emission mask changes were not needed with its system.

In a subsequent interview, USADR Director of Engineering Glynn Walden said, "We asked to tighten the mask for stations operating IBOC (because) it prevents interference between IBOC stations."

Lucent disputed USADR's claims of spectrum efficiency. Lucent said the USADR plan of blending to analog as a

backup to ensure reception in poor signal areas is "deficient" because it precludes the broadcaster from transmitting different programming on the analog and digital channels.

In an interview, Lucent Digital Radio Director of Technology Planning Alan Pate said, "We do not believe it's necessary to accept that compromise in the technology solution for IBOC." Lucent said in order to be commercially viable, IBOC has to be all digital, even in the transition phase.

## Split the signal

Lucent has developed what it calls a "multi-streaming" approach, in which

one IBOC signal is split into two separate streams. Lucent argues that this approach would better resist interference and leave the resulting signal more robust. Each stream is separately protected by Forward Error Correction codes and is modulated using Coded Orthogonal Frequency Division Multiplex, a modulation technique used to eliminate the effects of multipath. In addition, time diversity is applied to specific components of the streams. Therefore, Lucent argues, its system applies coding and modulation techniques designed to eliminate the impact of multipath.

Lucent also wrote, "USADR's proposed all-digital FM system design will force surrounding analog stations to either shut down, accept additional interference or convert to all-digital at whatever the cost and penetration of receivers in the local market." Lucent said its own system "will not adversely affect analog or digital stations operating on adjacent, second adjacent, or any other channel."

Of those who supported the petition, many are now investors in USADR, such as Clear Channel Communications and Cumulus Media (RW, Jan. 20). They agreed that IBOC DAB rules be established, including a single system standard to head off resistance among broadcasters and consumers.

Others who support the petition but are not investors in USADR commented as well. Bonneville International Corp. wrote, "The commission's prior experience with AM stereo reflects that a more open-ended approach will delay rather than expedite the introduction of digital

## Get Better Jocks for Less Money

Decrease costs, *increase profits* and run your station more efficiently. Outside of drive time, why pay your talent to sit around *waiting* to talk? A Scott digital System can put all your songs, spots and prerecorded Voice Trax together smoothly and easily...without anybody in the airstudio!

For years, Scott Studios' client stations have been successfully pre-recording incredibly live sounding fully localized 4 hour music shows in just 10-20 minutes. If you have a hub and spoke cluster of stations with similar formats and names (like Mix, Magic, Kiss or Kicker), you can sound great and save even more.

### Scott Breakthrough: Free Software!

Thanks to Scott Studios' new *free* Voice Trax Via Internet (VTVI) software, announcers can phone in shows with studio quality from anywhere. All they need is a good microphone, mic pre-amp and processor, Internet connection, any Windows<sup>®</sup> computer with sound card and Scott Studios' *free* VTVI!

Simply schedule your station's music. With the touch of a button, your log and latest local copy points are automatically e-mailed to your announcers. And Scott's VTVI works seamlessly with all music schedulers and traffic/billing programs.

Live tags, trivia and copy are displayed automatically on the screen. Announcers don't need a clumsy copy book or liner cards. They can talk as early as they want before songs fade and over intros or in the clear. VTVI is so simple to use: a touch of the space bar triggers the next song or the next spot. Voice Trax are recorded with the computer's regular sound card with exceptional digital quality.

Unlike live radio, any or all of the Trax can be reviewed and possibly improved by re-recording. With the VTVI's Segue Editor, announcers can fine-tune their timing of song intros, back sells and donutspots without re-recording.

### VTVI is Goof Proof!

VTVI includes Scott Studios' exclusive Voice/Music Synchronizer. Whenever the announcer mentions song title or artist, he or she turns on the link so the back sell or intro plays *only* with the correct song.

### You Can Even Do Time & Temp!

Scott's VTVI lets you record every possible time check, or do a range of alternate recordings mentioning the time in any Voice Trax. The Scott NT System picks the right one at air time. You can also record all the seasonal temperatures and let Scott's optional temperature announce equipment play the right one at air time.



Here's Scott Studios' Voice Trax Via Internet (VTVI) software, shown with the optional Segue Editor. VTVI allows a distant announcer to pre-record a 4 hour show in about 15-20 minutes with nothing more than a Windows computer with an ordinary sound card, an Internet connection and a good microphone.

### \$10,000 a Year Cheaper than WANs

When the announcer is done, a click on the VTVI Auto-Send button dials the Internet over a standard phone line and uploads the entire show to your Scott Studios digital audio system automatically. Transfer does take a long time, but your announcer can be answering e-mail, writing copy or creating promos on the VTVI computer while the show transfers.

VTVI isn't limited to music announcements. It gives high quality audio to recorded spots, remotes, weather, stock reports, news and election returns.

Your station will sound great with Scott VTVI! The only thing you need is an Internet connection on each end, a \$29 a month FTP transfer site and the Scott NT System with Remote Recording Router.

Voice Trax play seamlessly without anyone back at the station. And if the announcer forgets to record something, or if songs or spots get changed at the last minute, Scott's Voice/Music Synchronizer automatically substitutes a generic Voice Trax with the same voice for the day and hour of that break.

### 3 VTVI Models: Good, Better, Best

Scott Studios also offers a \$500 VTVI+ that sends your distant announcer telescoped song intros and endings via the Internet. With VTVI+, a telescoped aircheck can be previewed and fine-tuned in the context of starts and ends of songs and spots.

Or with VTVI Deluxe, your announcers record their Voice Trax *while listening to song and spot intros and endings* in context!

This was the first chance to react formally to IBOC, after a decade of industry debate.

radio technology in local markets. In addition, a unified terrestrial DAB standard is necessary to provide consumers and equipment manufacturers with the certainty required to encourage marketplace acceptance."

### Too early

The Radio Operators Caucus, which represents more than 20 station owners and hundreds of stations, supported the concept of establishing IBOC DAB rules, but said it is too early to pick one system. It disagreed with the USADR proposal that after a transition period, analog should no longer be protected.

"Termination of protection of analog signals is unnecessary and would result in loss of service to those who are unable to afford digital receivers," the caucus wrote.

The Consumer Electronics Manufacturers Association, which represents many receiver manufacturers, agrees with USADR that terrestrial DAB is in the public interest.

"Over two-thirds of American homes listen to CDs, and that CD use is not only growing in the home, it is growing in the car. This is important because most radio listening today takes place in the car. Although radio continues to be a strong medium, it is clear that there is consumer demand for improved service and enhanced audio quality. The issue that remains, however, is finding a workable system in a defined period of time."

However, CEMA urged the commission not to discount using other spectrum for terrestrial DAB. In previous DAB system tests, CEMA supported the Eureka-147 system as the best-sounding system.



VTVI is just one of several ways Scott Studios digital systems can improve your sound and your bottom line.

It's a fact: More U.S. stations use Scott Studios than any other major digital audio system. 2,000 radio stations use 4,400 Scott digital workstations, including major groups like CBS, Chancellor, Disney/ABC, Clear Channel, Emmis, Citadel and many more. Last year, 418 U.S. stations bought new Scott Systems. That's more than chose some other "major" digital systems in several years! Call 800 SCOTT-77 to find out why Scott Studios are chosen the most.

**Scott Studios** Corp.  
13375 Stemmons Freeway, Suite 400  
Dallas, Texas 75234 USA  
(972) 620-2211 FAX: (972) 620-8811  
Internet: [www.scottstudios.com](http://www.scottstudios.com)  
**(800) SCOTT-77**

► IBOC, continued from page 14

CEMA also argued for a single system standard.

"It would reduce consumer costs by eliminating the need to purchase duplicative equipment or special devices to convert from one standard to another," the association stated.

Supporters agreed with USADR that there should be one standard for an IBOC system, and that a purely private standard setting body would be hard-pressed to reach a consensus. According to auto company and receiver manufacturer Ford Motor Co., the FCC should create a public/private committee, with FCC participation, to tap into private sector expertise.

"The presence of the commission on the panel would ensure that some type of consensus would eventually be reached," Ford stated.

The latter group has developed test guidelines for the proponents to test and have third-party verification of their systems.

mon laboratory setup, such as was done previously by the NRSC," wrote NAB.

#### Interference protection

The association is worried about possible interference to IBOC stations, caused either by the licensing of new services or by the easing of protection standards in the current FM technical streamlining effort.

"We believe it is critical that the state of interference within the radio bands not be increased — through rampant 'interference negotiation,' reduced adjacent channel interference protections, pirate radio broadcasts or the introduction of new, interfering low-power FM services," NAB wrote.

The NAB Radio Board has formed a spectrum integrity task force to review interference and other concerns.

## Supporters agreed with USADR that a single IBOC standard is desirable.

The NAB made its concerns known as well.

NAB and CEMA co-sponsor the standards-setting National Radio Systems Committee and its DAB sub-

committee members nor the individual proponents envision a regime of simultaneous testing of multiple IBOC systems, run by a single, neutral entity in a com-

### DIGITAL NEWS

#### Germans Study DAB Reception

In Germany, Video-Audio Design has completed a study on the reception of DAB signals in buildings.

SLM, the private radio licensing authority for Saxony, commissioned the report from VAD of Dresden, because of concerns that L-band DAB signals were not penetrating buildings, causing problems for indoor listening. Most DAB broadcasting in Germany will air on the L-band.

VAD found that there was considerable loss of L-band signals inside, particularly in ground-floor rooms. The study suggested that boosting transmitter power by 10 dB would help make inside reception reach acceptable levels.

A 10 dB increase would solve the problems in most types of buildings, although buildings with metal windows were determined irredeemable. Indoor repeaters were recommended for particularly bad cases, but even here, improvement could only be achieved in two rooms at a time.

— Michael Lawton

#### New President for WorldSpace

**WASHINGTON** Harold B. "Buck" Adams was named president and chief operating officer to direct WorldSpace toward its full commercial launch later this year.

WorldSpace Chairman and Chief Executive Officer Noah Samara said, "Buck Adams provides the experience and know-how necessary to help WorldSpace evolve from a start-up venture to the world's first viable digital satellite radio service."

Adams will be responsible for streamlining and managing WorldSpace operations.

Prior to joining WorldSpace, Adams was chairman and CEO of the Artley Group Ltd., a Washington, D.C.,-based investment consultancy working with infrastructure-focused businesses in emerging markets. He also has worked with Global Telecommunications Group Inc. and GTE Spacenet.

— Chris Joaquim

# The #1 solution for digital audio editing.



## The Short/cut™ Editor is fast and easy. So is our free test drive offer.

Discover for yourself why the Short/cut Personal Audio™ Editor is the perfect choice for two track recording and editing in news, production and on-air applications.

Short/cut is powerful enough for production, yet simple enough that even non-technical staff can learn to operate it within minutes.

It delivers superior audio quality, true cut and paste waveform editing, massive hard disk storage and support for external removable media drives\* — all in one compact,

easy-to-use unit. It even has built-in speakers and ten Hot-Keys for immediate playback of edited material in the studio, or on the road.

Whether you're replacing out-dated reel-to-reel machines, or building a state of the art studio, Short/cut is your number one choice.

So here's our offer. Take it out for a test drive on our nickel. We're sure that after you test drive it, you'll want to park it at your place.



Attention call letter stations.\*\* You're only a phone call away from a free 10-day Test Drive.

So try it out. We'll understand if you don't give it back.

**(818) 991-0360**

*360 Systems*®

PROFESSIONAL DIGITAL AUDIO

For more information call (818) 991-0360 / Fax (818) 991-1360 / e-mail: info@360systems.com / Website: www.360systems.com

\*Optional Zip™ drives available from 360 Systems \*\*Offer good in U.S. and Canada only  
© 1998-360 Systems

# Workbench

Radio World, February 17, 1999

## Boom Springs and Nitro Tanks

John Bisset

Rodney Belizaire works with Herb Squire at WQXR-FM in New York City. Russ Mundschenk's idea of replacing the noisy springs on a microphone boom with rubber bungee straps caught his eye, and he writes asking where to find them.

Most hardware or auto supply stores have a supply of these straps. You don't want the really big ones — can you imagine the missile if one broke? I've seen the smaller cords for sale at hardware stores, auto supply stores and home centers.

\*\*\*

Many of us are enduring cold weather right now, and associated with that cold is ice. If you haven't given your FM antenna system a quick check, now is a good time to do it. In addition to verify-

ing that the de-icers are working, check your nitrogen level and pressurization system. It's never normal to lose a lot of nitrogen.

Keep a routine check of nitrogen pressure and tank volume. It's great preventive maintenance and could save your station thousands of dollars. Having an antenna flame out or a line catch fire is not the way to spend the winter months.

Also make sure your nitrogen tanks are secured to the wall (see Figure 1). Chains work fine. I've seen stations receive citations from the local fire marshal for unsecured tanks — don't let your station be one of them.

So what do you do if your line is leaking? Before calling in the tower crew to climb the tower, grab a spray bottle filled with soapsuds; the soap kids use to blow bubbles works best, but any kind of diluted soap should work. With the tank

turned on and the nitrogen being fed into the line at about 3 psi, begin spraying the soapsuds, starting at the air inlet connection on the transmission line (Figure 2). When the soapsuds start to bubble, you've found your leak.

look for the leak from the top down.

Of course, if the "spritzer method" fails to turn up any leaks at ground level, the next step is to call in the climbers.

Thanks to Mark Bohnett with WESM(FM), Princess Anne, Md., for the photos and maintenance advice.

\*\*\*

Speaking of keeping lines dry, when was the last time you looked at the color of the absorption crystals in your line dehydrator? If they've changed color, you can dry the moisture by baking them in an oven set at low temperature.

Thanks to Phil Carns for that reminder. Phil visited a station that had about 10 boxes of "wet" crystals on the shelf; the management just kept buying new crystals each time they needed to be changed. It's sad what some stations do while thinking they're saving money.

\*\*\*

Dave Callaway of Waycross, Ga., does play-by-play for the local high school football team, broadcast locally on cable. The cable TV setup is right next to the local radio station announcers, who



Figure 1: Inspect nitrogen tanks regularly and keep them chained to the wall for safety.

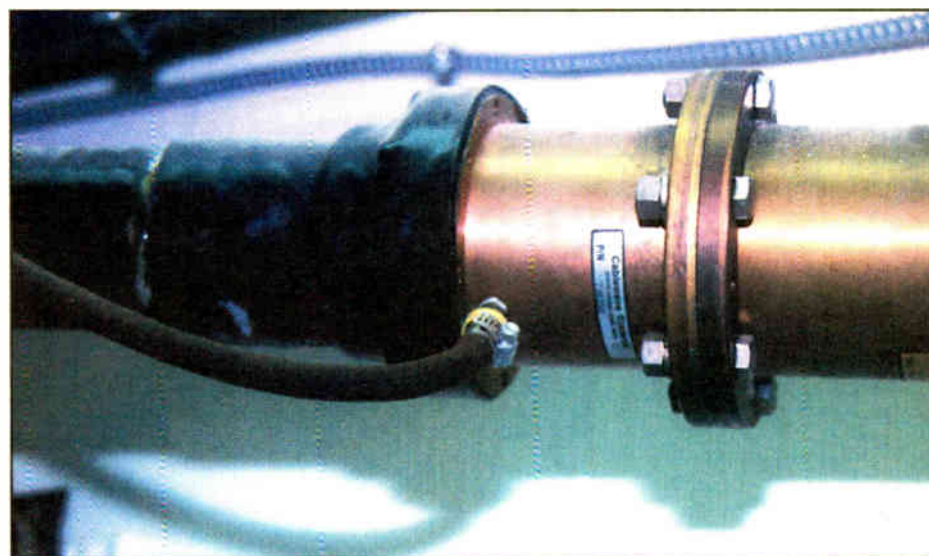

Figure 2: When searching for air leaks, check the fitting at the coaxial line first, then the connecting hose and regulator.

Don't be surprised if you find the connecting hose bad, or even a leaky regulator. Even if those items need to be replaced, you're probably dollars ahead when compared to hiring a tower crew to

lost their telephone coupler last week. Dave would like to help the station out, and inquired about a schematic for a simple, inexpensive telephone interface that

See WORKBENCH, page 21

### TOOLKIT TIME SAVERS



Whirlwind makes a complete line of specialty items that drop into your toolkit and save you time on the job. They offer rugged construction, thought-out details, and Whirlwind performance. Call toll free 888.733.4396 for product and dealer information.

**whirlwind**

Check out our full catalog! <http://www.whirlwindusa.com>



# Emmis HQ Is an Indy Showcase

*New 25-Studio Facility Features  
BE AudioVault, PR&E Integrity Consoles*

**Paul J. McLane**

Among the most notable radio installations in the United States is the new Emmis Communications headquarters in Indianapolis, a \$25 million, 142,000-square-foot facility that is home to WENS(FM), WNAP-FM, WTLC-FM,

headquarters building project, and specifically, the audio and RF that make it up?

**Taylor:** My role in the building was more of a project manager for Emmis.

I was in charge of making sure the infrastructure was in place for the information systems and the digital environment, so we could communicate not only

along and joke around. There is no animosity or egos.

## Talking to each other

**RW:** How did you manage the decision-making process itself? Was it a committee approach?

**Taylor:** I took over this role in June of 1998, when I came into Emmis. At that time, to be honest, it was sporadic at times, just because the communication wasn't there.

The engineers and the information systems group decided from a technical standpoint that we were going to have regular meetings to discuss the issues.

**Taylor:** They are kind of doing their own thing at this point. We had a (corporate) chief engineer at one point, and unfortunately he passed away in a car accident a little over a year ago. His name was Norm Beatty.

There has been discussions on whether there will be a corporate chief engineer for radio and how the group will be organized, but nothing has been decided as of yet.

**RW:** How does that leave the management and daily decisions at individual stations?

**Taylor:** The stations run as independent entities at this point. They make the decisions that are best for the station. They communicate those decisions back up through the general manager of the station and the president of the radio division, Doyle Rose, for any major expendi-

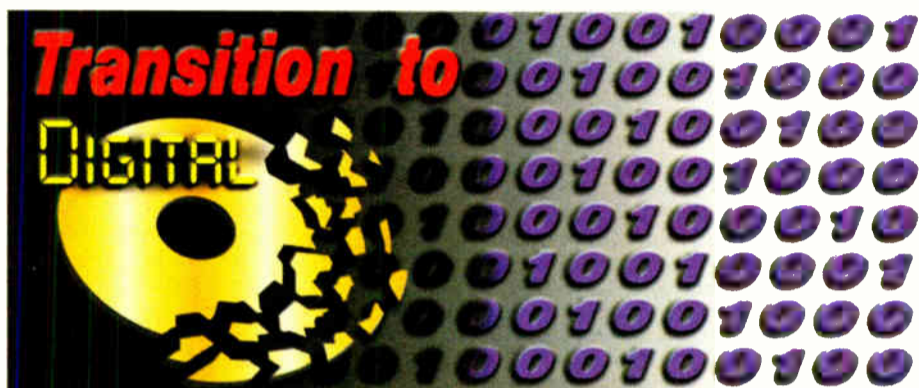

WTLC(AM), WIBC(AM), Network Indiana, Agri-America, Indianapolis Monthly Magazine, and Emmis corporate offices. It opened in December.

The headquarters has 25 studios on four floors, including two street-level showcase on-air rooms; six standard on-air studios; six primary and six secondary production studios; a large newsroom with eight workstations; a news announce studio; two screening rooms; and a talk studio.

The two showcase studios feature a video-quality electronic message board, giving news and information to passers-by on the street. Any of the five stations can use these studios, which also have double-paned, bullet-proof glass for sound isolation and safety, as well as a two-way video monitoring system.

Three technical centers, with a total of 32 racks, hold satellite, ISDN and T1 equipment as well as tech support. Digital audio was an important part of the job; the contract included 20 digital Integrity consoles from Pacific Research & Engineering.

**RW Editor Paul J. McLane** spoke with Curtis E. Taylor, chief information officer for Emmis Communications, and Dave Hood, chief engineer of WTLC-AM-FM, about the challenges of managing a project of this scope.

**RW:** What were your roles in the new

from our desktops, but to the consoles and to the servers that are now running our building. I also served as a resource coordinator for our engineering group.

**Hood:** Mainly, it was teamwork I did with Jeff Dinsmore, chief engineer at WIBC and Network Indiana. We helped pick the equipment, went through a lot of interviews with vendors, especially the digital delivery system. ... We invited the five system suppliers who we thought would deliver the best system for the corporation.

**Taylor:** Dave is being modest. He was instrumental in getting the Broadcast Electronics AudioVault system in. He evaluated five systems and helped select the vendor, helped select the studio hardware, worked with the configuration of that hardware and worked with the vendor who installed it, which was Pacific Research & Engineering.

He did some of the installation himself as well as going through a lot of the testing and the final cut-over and troubleshooting after we finally got in the building — which has not stopped, by the way.

**RW:** Your engineering team has a good working relationship.

**Hood:** We are all team players here. Jeff is great. The guys we work with, we get



Emmis Communications World Headquarters

That was the key as far as the team-building process, and we are all working together even better now because it was a committee effort.

**RW:** Let's talk about the engineering structure of Emmis, which has 19 radio stations.

**Taylor:** Roughly, there is at least one engineer per city.

We have multiple stations in certain cities, so here in Indianapolis for instance, we have four engineers for the five or six stations in this building. At our New York site we also have multiple engineers, so the total number of engineers in this organization is about 20, if you count full- and part-time.

**RW:** Who oversees them?

tures or issues that may come up.

If there is anything major as far as technical questions, the engineers are not afraid to pick up the phone and call any one of their counterparts anywhere in the country.

**RW:** How would you describe this project to an engineer you meet at a show who doesn't know anything about it?

**Hood:** Don't do it! (Laughs)  
It was a big mama.

We've got the coordination to get what we wanted to do. We wanted duplicate cloning of the studios. We wanted a lot of communications between our systems, such as the Broadcast Electronics AudioVault and the Pacific Integrity consoles, and the actual network that

See EMMIS, page 22 ▶

Lucent Technologies  
Bell Labs Innovations



"Now Hear This. Lucent Digital Radio Brings Wider Coverage to IBOC  
DAB (equal to FM analog) with CD-Quality Audio"

**Lucent Digital Radio**

[www.lucent.com/ldr](http://www.lucent.com/ldr)

## GUEST COMMENTARY

# Eureka Offers Challenges, Potential

**Michael Blackburn**

*The author is group engineering manager for AMP Radio Networks in Kuala Lumpur, Malaysia.*

Planning Eureka-147 DAB implementation in Malaysia over the past 16 months has been an exciting time.

Yet, on the eve of the digital radio era, it is frustrating that it still is not possible to put together a complete commercially viable end-to-end DAB broadcasting system.

It is unlikely that commercial radio broadcasters will proceed in implement-

ing DAB until the complete solution is available off-the-shelf and the revenue stream has been identified for recovering the high costs of implementing a DAB broadcast and transmission system.

### Premium-quality audio

Synchronized multimedia Eureka-147 DAB is an extremely solid and robust transmission that shines above other technologies in its ability to provide totally portable information, entertainment and multimedia to the radio listener on the move.

If implemented adequately, DAB is capable of delivering a premium-quality

audio service in any environment to the consumer. However improvements in audio quality alone will not be enough to convince the majority of consumers to pay the current DAB receiver high prices.

The success of DAB, therefore, must lie in the development of interesting, informative and commercially viable data services. However, the consumer will not be convinced if they cannot see, feel and lay their hands on a receiver with all the features DAB is capable of providing.

A commercially viable DAB system must be capable of delivering program-associated data (PAD) in a highly con-

trolled and tightly synchronized fashion, as well as delivering additional revenue-capable, non-PAD services.

The transport system is technically capable of providing this, with some limitations in the handling of dynamic and animated media file formats; however, it is expected that DAB must grow with the ever-changing world, where the Internet is a competitor. DAB must accommodate all common Internet-based multimedia file formats.

To the best of my knowledge, no broadcast automation system on the market today is capable of tightly controlling the scheduling, handling and synchronized transmission of graphical media.

I need to be able to schedule graphical media so that it arrives and is displayed on the receiver data terminal with split-second accuracy to ensure synchronization with the audio.

The media broadcast system must be capable of automatically calculating and prerolling graphical media to accommodate various file sizes, types and transmission delays from end to end.

### All and more

Furthermore, the media broadcast system must have all features and more of a typical computer-based audio broadcast-

**If anyone can  
provide me the  
complete solution  
today, I have the  
checkbook ready!**

ing system, including a media scheduling system with user-adjustable rules, clocks, parameters, etc., to allow for fully automated yet apparently non-repetitive playback with, among others, a reconciliation and billing system.

Currently a presenter can punch in a sound effect or short audio element, commonly called a "hot key element." We need the same parallel for DAB — to be able to punch in live, unscheduled graphics.

Broadcasters may wish to schedule 20 different media slides for the duration of an average 3.5-minute song, again tightly synchronized to the audio and mixing music-related and revenue-driven content.

The broadcast application software should assemble the media from a number of frames, possibly three or more, sized carefully to comply with an equal number of different display sizes, from the 2-by-16 character car receiver display to a 320-by-240 pixel LCD panel to a desktop CRT or even a television.

### Karaoke radio

I look forward to the day when it is possible to have, for example, "Karaoke Radio" where the consumer can sing along to their favorite song, following a bouncing ball tightly synchronized to the audio.

We need to integrate with GSM for in-car use and with fixed-line phones for home use to ensure consumer interactivity via the return channel.

The car receiver needs to be simple to drive with a "Tell Me More" button to provide additional information, such as a map and directions to the shop or the week's special offer. Imagine being able

See DAB, page 21 ►

## Control Multiple Transmitter Sites from Anywhere



### **Gentner GSC3000** Radio Transmitter Remote Control

#### Key Advantages

- Control multiple transmitter sites from one location
- Access system via phone or by computer/modem
- Program unit to take its own corrective action
- Receive notification by phone, pager or computer
- Affordable modular system to handle from 8 to 256 channels of metering, status and control

Call BSW Today for Complete Details and Excellent Pricing on the GSC3000!

**1-800-426-8434**

FAX 800-231-7155  
<http://www.bswusa.com>

#### Receive better value from BSW!

- Lower prices on all professional audio and broadcast equipment
- The most comprehensive inventory representing over 200 manufacturers
- Knowledgeable sales representatives with broadcast and studio engineering experience
- Fast, customized delivery to meet your needs
- Integrity, support and lasting commitment to you

**BSW**  
BROADCAST SUPPLY WORLDWIDE

7012 27th Street West, Tacoma, WA 98466 USA

## PRODUCT EVALUATION

# Crane Radio Is an AM Champ

Alan R. Peterson

C. Crane Company is positioning its new CCRadio with the same verve that GE demonstrated when it rolled out its Super Radio a few years back. The CCRadio is a collaborative effort between Crane and Sangean Electronics, the manufacturer and importer of AM, FM and shortwave receivers.

The company calls the CCRadio "The Ultimate AM/FM Radio," and for good reason: the AM section has been optimized to punch up response in the frequencies where the human voice resides. The receiver also latches on to TV channels 2 through 13, the entire FM band and NOAA Weather Radio broadcasts.

Similar radios can be found that do this for less than what the CCRadio costs — \$159.95, a price closer to a portable TV — but there is enough going on in the CCRadio to qualify it for a status greater than "workshop radio," a fate that befalls many tabletop units. DX hobbyists would go for this as a nice basic receiver. I liked it because it made AM sound good, and I still like AM.

The CCRadio has a recognizable Sangean appearance, seen often in Radio Shack products (Sangean OEMs radios for Radio Shack as well as sells radios under its own label). Tuning and volume dials are on the right side of the CCRadio. A large LCD readout shows frequency,

in the big guns from New York, Philadelphia and Baltimore as expected. It also caught WRVA(AM) Richmond, Va.; WHP(AM) Harrisburg, Pa., which had to creep around adjacent WTEM(AM), Washington; a fistful of Ohio stations, and a surprising number of locals and region-

to experience this feature first-hand. Still, I am glad it is there.

Take the printed specifications in stride and let your ears be your guide. The Audio Frequency Range is listed at 40 Hz to 31 kHz, which I am certain is the charted response of the audio amplifier stage. With



Photo by Alan R. Peterson

als that dipped to post-sunset power.

To do this, I had to listen away from home and off the AC line. I live within the sightlines of two powerful transmission towers and a cluster of high-tension power lines. AM reception around my place gets crippled by hum and corona noise.

As good as the CCRadio is, we are still a long way off from a receiver that

AM response limited to 4.5 kHz and FM pretty much rolling off at 15 kHz tops — to say nothing of human hearing response and the limits of the five-inch speaker — that extra octave is never heard.

Few folks are going to want to hook an external AM antenna to the CCRadio, even though there are connections for it. Time was, you could connect the antenna terminal to a bed boxspring or to the finger-hook of a dial telephone and use the outdoor phonelines as a longwire antenna.

I use a coil of computer ribbon cable as a passive directional loop to pull in distant stations and null out the locals. Most listeners will not exert this sort of effort, but for those that do, Crane also offers longwire and portable active antennas that will interface with the CCRadio.

Should you be inclined to add an external antenna, be ready to deal with 10 kHz whistle from domestic stations and

## Product Capsule:

The CCRadio by  
C. Crane Company



### Thumbs Up

- ✓ Makes AM sound good
- ✓ Weather alert feature
- ✓ External antenna terminals



### Thumbs Down

- ✓ Expensive
- ✓ Still subject to artificial interference

For more information, call (800) 522-8863, visit [www.ccrane.com](http://www.ccrane.com) or circle Reader Service 149.

the occasional 9 kHz tweet from overseas AMs. Being on the East Coast, my reception is subject to European skip. Your experiences may differ.

## Sign off

Crane has an interesting product in the CCRadio. If you are shopping for a plain old table radio (if there is such a thing anymore), you would likely grab a department store special, based solely on price. But remember, the CCRadio is optimized for talk radio, pulls in TV, FM and NOAA, with an alert feature that could warn you in time of disastrous weather. That is worth its asking price.

As an emergency and travel radio, it is, in my opinion, exceeded only by the Baygen 2 Freeplay generator-driven receiver, also sold by Crane. But the Baygen does not pick up NOAA, so score another point for the CCRadio.

The CCRadio's claim to fame will have to be its emphasis on AM reception, which it does very well. Contact the company for a catalog and information on the CCRadio and find out for yourself.

Alan Peterson is technical editor of RW.

Bought a new-model receiver lately? Tell us about it. Send e-mail to [radioworld@imaspub.com](mailto:radioworld@imaspub.com)

**The CCRadio reminds me of the time when all receivers had a solid AM front end and actually sounded good through console cabinets in the living room.**

clock and alarm settings, battery status and the band that is active. Seven large buttons atop the CCRadio control Power, Weather Alert and station presets. Two screw terminals on the rear are for an external AM antenna and ground.

## AM operation

AM is not dead. The way I see it, if it were, companies would not make receivers anymore.

With most AM stations today airing talk and sports programming, it makes sense to have a receiver that offers the best bandwidth and response possible for speech. Some exceptions include adult standard stations, but recordings made during the heyday of the big bands scope out roughly to the response of AM radio anyway, so little is lost.

The CCRadio was designed primarily for better AM reception and offers decent intelligibility in the AM band, even for smaller stations with less than perfect processing. After checking out the prominent AM stations around the Washington, D.C., area and being satisfied with the performance of the CCRadio, I went after some other fish at night.

Paradoxically, it is never the \$400 AM/FM receivers, but always the \$19 clock radios that pick up the rare, out-of-town AM stations. The CCRadio bridges this inequity. With its internal 7.8-inch ferrite antenna, the CCRadio did a reasonable job here in suburban Washington, pulling

ignores artificial interference. Conditions improved when the receiver was run off battery power and no spurious junk could hitch a ride on the AC line. And of course, when the ferrite antenna was aligned to the desired station, as is the case for any AM receiver.

The CCRadio reminded me of the time when all receivers in general had a solid AM front end and actually sounded good through console cabinets in the living room. Just to see how it would work, I took the headphone jack output and ran it through an old Fender tube guitar amp to recreate the sound of grampa's old 1940s vintage Philco. With a little bass and treble dialed in from the front of the CCRadio, the 12-inch speaker on my amp brought back the deep, well-remembered sound.

Not that this is the best way to listen to the CCRadio, but it certainly was an interesting experiment.

Lest you believe I live in the past, the CCRadio also has solid FM reception. This is in mono for better noise figures on weaker FM stations. The TV audio receiver lets you check out soaps, newscasts and Rosie O'Donnell while at the office or in the garage. The weather band receiver lets you lock onto the strongest NOAA channel in your area, then monitors it for alerts.

When one is received, the CCRadio trips a light and alert signal to let you know there is something you need to hear. Due to a lack of weather emergencies during my evaluation, I did not get

# SMART BOY

## -he bought a BEXT

### Look to the low power leader

for high performance in transmitters, exciters (such as the popular LEX 25) and a whole catalog of intelligently priced RF equipment.

E-mail your questions. We'll answer promptly.



LEX 25 25 Watt FM Exciter  
S/N: >80dB THD: <0.03% \$1,495  
Two-year limited warranty



1055 10th Ave.  
San Diego, CA 92101  
619-239-8462  
FAX: 619-239-8474  
e-mail: [support@bext.com](mailto:support@bext.com)  
web: [www.bext.com](http://www.bext.com)

**BEXT**

# Products & Services Showcase

For more information on the products shown below, circle the appropriate Reader Service No.(s) on the enclosed Subscription/Reader Service card or contact the advertiser directly.

## Composite Audio DA and Switcher!



The CDS-200 Composite DA/Switcher

### APPLICATIONS

- Switching Between Composite STL's
- Main/Alternate Processing Switching
- Feed Two Transmitters and an RDBS Encoder
- Feed one SCA Generator to Two Transmitters
- Distribute Composite with the Ease of Audio

### FEATURES

- 2 Input Switcher
- 3 Isolated Outputs
- Individual Level Control for Each Output
- Front Panel and Remote Control with Full Status
- Power Fail Memory with Bypass Mode
- Inputs Selectable for Balanced or Unbalanced Operation
- Front Panel Test Jack



**Broadcast Devices, Inc.**  
5 Crestview Avenue, Peekskill, NY 10566  
broadcastdevices@worldnet.att.net

Tel: (914) 737-5032 FAX: (914) 736-6916

READER SERVICE NO. 26



*If lightning strikes on your tower are causing equipment damage and lost air time - the cost of a Stati-Cat system may be recovered during your first lightning season.*

## AFFORDABLE - RUGGED LIGHTNING PROTECTION

The *Stati-Cat Lightning Prevention System* provides a continuous, low-resistance discharge path for the static electric charge on tall structures. DISSIPATION POINTS ARE 1/8" STAINLESS STEEL RODS (not wires) ground to needle sharpness.



Write or call toll free for a free brochure!  
P.O. Box 2548, Farmington, N.M. 87499-2548  
888-325-5336 FAX 505-326-2337

READER SERVICE NO. 52

## POWERFUL DIAL-UP CONTROLLER



The CircuitWerkes DR-10 Dial-up controller is perfect for studio & automation control.

- 10 dry relay contacts out (2 are DPDT for switching bal. audio, etc.).
- Auto-answers on settable ring # and auto-disconnects with telco CPC.
- Each relay can be assigned to any tone & can be set to function as momentary, latching closure with distinct on/off codes, or interlocked latching with other relays. Any relay can be assigned to any tone(s).
- Up to 8 digit user set password prevents pirating.
- Each relay is programmable to close at beginning or end\* of tone and can beep when activated. End of tone closures are after the beep!
- Two-tone & detection delay modes eliminate falsing for remotes, etc.
- 4 Status inputs beep when queried, dial 4 numbers & control relays.
- A simple, built-in audio hybrid, with active, balanced input & outputs, lets you control your equipment while monitoring local audio sources.
- All audio & control connections via easy to use screw terminals.
- Retains its settings & prior state after a power failure.
- Silencer option removes DTMF tones from output.
- List price only \$449.00. Compare our features & price to anyone else!

The DR-10 can do a lot more than space allows us to print. For complete info & downloadable manuals, check out our web site - <http://www.circuitwerkes.com> \*end of tone closures function in momentary mode only.

**CircuitWerkes** - (352) 335-6555 / Fax 380-0230  
3716 Southwest 3rd Place, Gainesville, FL 32607

READER SERVICE NO. 78

You found what you've been looking for...

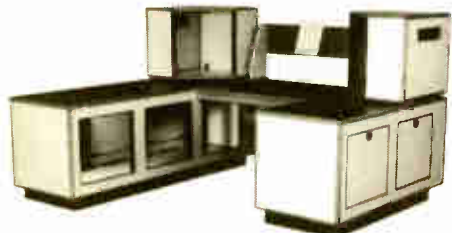

The finest in **Modular Studio Furniture**  
Endless combinations...  
precision quality...  
attractive design...  
and a GREAT PRICE!

### Advanced Furniture Systems

1545 N. Washington Ave., Loveland, CO 80538  
Phone: 970-663-4123 Fax: 970-663-6338  
Email: afs@mail.omn.com  
Website: [www.omn.com/afs](http://www.omn.com/afs)

READER SERVICE NO. 25

Buy simplicity, reliability and service

## EAS

Price \$1750.00

Equipment is in stock for immediate delivery!

Now available with optional DTMF control via a phone line.

**GORMAN-REDLICH MFG. CO.**  
257 W. Union St. Athens, Ohio 45701

Phone 740-593-3150  
FAX 740-592-3898



- 5 two-way RS-232 inputs outputs for computer, remote signboard & character generator
- 4 audio inputs on standard models (expandable to 6 audio inputs). All audio inputs & outputs are transformer isolated from encoder-decoder board.
- Automatic interruption of program audio for unattended operation.
- 4 line 40 character LCD display with LED backlighting
- 20 key keypad to program unit, set modulation level, set input levels
- Will handshake with automation equipment.
- 2 year warranty
- 2 minutes of digital audio storage (expandable to 4.5 minutes)
- 25 pin parallel printer port for external printer
- 52 terminals on the rear to interface with other equipment by removable plugs.

Web Site: [www.gorman-redlich.com](http://www.gorman-redlich.com)

◆ Also available: printers, weather radios, antennas for weather radios, crystal controlled synthesized FM digitally tuned radios, remote signboards, cables for interconnection, character generators.

READER SERVICE NO. 104

## PTEK

## LOW COST FM TRANSMITTERS & POWER AMPLIFIERS



Exciters/Transmitters  
10W  
25W

Power Amplifiers  
150W  
300W  
500W  
1000W

**CALL 888-411-5174 FOR DETAILS**

1814 SCHOOLDALE DRIVE, SAN JOSE, CA 95124. 408-448-3342 FAX 408-448-5951

READER SERVICE NO. 130

## Your New Interview Tool



### INLINE PATCH Telephone Audio Interface

Simply connect Inline Patch between your telephone and the wall jack. You will get separate control over your voice and the caller's voice. A great little hybrid!

List Price  
\$270.00



## JK Audio Remote Broadcast Gear

800-JK Audio (815) 786-2929 [www.jkaudio.com](http://www.jkaudio.com)  
800-552-8346 Fax: (815) 786-8502

READER SERVICE NO. 51

# Eureka's Unrealized Potential

► DAB, continued from page 18  
to print this information out, even in the car — an instant new revenue stream for the broadcaster. A "Buy Me" button would allow instant purchases; credit lines could even be established with service providers or a receiver plug-in Smart Card system.

On-board RAM in the receiver would allow consumers to scroll through possibly the last 10 media pages for more information. Conditional access will be a necessary revenue-driven feature for the consumer who may want exclusive information, such as live stock exchange updates.

## Challenges ahead

We need to integrate car navigation with current traffic conditions to a GPS-referenced location inside the vehicle. The station could then regularly upload to the customer the latest maps, eliminating the need to purchase a new CD-ROM every few months.

The ten-fold audio improvement suggested by others in the DAB debate should be our focus. When we demonstrate DAB to shareholders, consumers, car manufac-

turers, receiver resellers, advertisers, etc., we need to blow them away with what DAB can really do for them.

All systems in the DAB chain must cater for the highest common denominator and it appears at present we still have a few bridges to cross:

- Receiver manufacturers are cutting corners on facilities and features in the early models.
- Broadcast systems manufacturers have not produced the effective media-handling tools and automation systems.
- In many cases, broadcasters are sitting back until all these problems are sorted out before investing huge sums of money.
- The consumer will not buy on the

promise that wonderful graphical media content will be coming soon.

- Receiver resellers have no idea how to sell a "digital what is it" receiver.
- Car manufacturers are installing car navigation systems as standard features, and we could soon be driving on Windows CE platforms. We need to have a DAB receivers in there somewhere.
- There needs to be some standardization of display sizes so that the broadcast tools and applications can package the media for consumption.
- Receivers need to provide GSM interfaces; Smart Card capabilities; adequate RAM for media storage; serial, USB or infrared interfaces to download software

to a laptop or palmtop computers.

• The Eureka-147 transport protocols need to accommodate new and ever-changing multimedia file formats.

It is the classic "cat and mouse" story.

I look forward to the day when all these issues are resolved and sincerely hope that DAB is not overtaken by the many other multimedia technologies in various stages of use or development.

And, if anyone can provide me the complete solution today, I have the checkbook ready!

■ ■ ■

*Michael Blackburn is the group engineering manager for AMP Radio Networks. Contact him via e-mail at michael\_blackburn@astro.com.my*

*This commentary originally appeared on the Radio-L DAB listserv mailing list.*

*RW welcomes other points of view.*

## A Handy Console Switch Fix

► WORKBENCH, continued from page 16  
he could build. He would keep it as a spare in case it is needed in the future. If you have an idea for a circuit to help Dave out, fax it to my attention at (703) 323-8044.

★ ★ ★

Bob Clinton, chief engineer of WHFS(FM) in Washington, D.C., shared a neat trick for those of you with Dialite console switches.

Because the light bulbs in these switches move with the pushbutton assembly, repeated use flattens the lead solder blob on the base of the #387 bulb. As the blob flattens, the lights become intermittent. I always thought it was a bad connection inside the switch. Wrong!

Remove the bulb and touch the tip of a soldering iron to the bottom to re-form the solder blob, stick the bulb back in the switch, and you're ready to go.

I won't say I was skeptical, because Bob has always been on the mark with his suggestions. It's just that this seemed to be too easy, if you know what I mean. But try it, it works; the manager will love the money you saved!

■ ■ ■

*John Bisset has worked as a chief engineer and contract engineer for more than 20 years. He is a district sales manager for Harris Corp. Reach him at (703) 323-8011.*

*Submissions for this column are encouraged, and qualify for SBE recertification credit. Fax your submission to (703) 323-8044, or via e-mail at jbbisset@harris.com*

# Crown's New Exciter

...we've created a **Monster** broadcast solution!

Our Design Engineers have created a second generation, high-performance FM exciter with significantly improved specifications. Fear no one—this monster solution fends off the competition by ensuring clean, accurate audio quality and includes:

- Reduced total harmonic distortion
- Excellent signal-to-noise ratio
- Versatile modular design
- Power levels of 30, 100, 250, and 500-watts

Need a **Monster** of a solution for...

- Replacement of the IPA in your high-power tube transmitter
- New installation
- Backup

**Give us a call!**

**In-the-box Innovations.  
Out-of-the-box Solutions.**

 **crown**  
broadcast

800-294-8050 or 219-294-8050

Fax: 219-294-8222

Email: broadcast@crowntntl.com

Web: www.crownbroadcast.com

# Inside Emmis HQ

► EMMIS, continued from page 17  
we're using, the Novell Netware for the corporate business applications and Windows NT for the broadcasting network. This means we had to bridge the two networks together.

The drawings, "Here's what the studios are going to look like," that was done by Ratio Architects. They laid out the studios and what consoles went with each other.

PR&E did a large chunk of this. Emmis knew that this project was huge, and they made the correct decision to get Pacific to come in there and help us.

Not only are there four of us — three chief engineers and one assistant engi-

neer — but we had to keep our stations on the air while building this whole project. They knew we couldn't do it by ourselves. We brought in Pacific, who guided us and coordinated. (We) couldn't have done it without them. They did a marvelous job.

**RW:** You chose them as a turnkey installation provider?

**Hood:** They did the basic structure and skeleton, and we engineers were still coordinating everything and then doing all the small parts — making sure things were tied in, setting up STL sites, and planning the actual cutover there

was a lot of stuff that Pacific was not contracted to do.

We do a lot of T1 work; every transmitter site has a T1. But Pacific put the meat on the table.

## Digital or analog?

**RW:** Why did you choose the digital Pacific Integrity consoles?

**Hood:** Originally, we were going to have Pacific BMX IIIs. Then some of the executives said that if we are going to install new systems, then we should

needs analog because of their setup, a couple of their other radio consoles. We didn't put Integrity consoles in every studio. There are two studios that don't have it.

The AudioVault is mostly AES3, but if a studio had to have analog because of the console, all we did was tell the AudioVault, "Hey, you're not digital, you're now analog." And it did it.

**RW:** In an interview recently, I spoke to Russ Mundschenk, a chief engineer in

**One of the criteria ... in the equipment selection process was not only experience ... but support. That's become a huge issue.**

— Dave Hood

## Arrakis Studio Furniture systems are #1 with over 1,000 sold!

The Master Control Studio, shown right, is one of seven Arrakis studios in Sony's Manhattan network origination center for SW Networks.



### Arrakis furniture is #1 ...

- Off the shelf -or- Custom
- Easy to design & assemble
- Very fast delivery !!!

call today to find out why Arrakis studio furniture is the choice of broadcasters worldwide...

from Moscow, to Tokyo, to Manhattan...

**(303) 224-2248**

or (970) 224-2248

1995 Arrakis Systems inc. 2619 Midpoint Drive, Fort Collins, CO. 80525



go totally digital since this is the direction the industry is moving.

**Taylor:** The Integrity consoles were being used somewhere else in the Emmis family, and that's where I think part of the decision to use the Integrity consoles came from.

**RW:** How are equipment decisions made at Emmis?

The AM and FM Studios of WTLC, as drawn by Ratio Architects Inc.

**Taylor:** Decisions on equipment are made from the bottom up.

The engineer and the equipment users at a site will write a justification for purchasing a piece of equipment based on new functionality that new equipment on the market offers or to replace current equipment that is failing. This justification is then sent to the general manager of the station, who can approve or deny the request.

Depending on the amount of the request it may have to go to Doyle Rose, the president of the division, for his approval.

**RW:** You've talked about standardizing equipment around the group, whenever possible.

**Hood:** Yes. That's why we're looking at the AudioVault real close, to get other stations all to go AudioVault, mainly because the AudioVault has this wide-area network. That's a key issue for all the Emmis stations.

**RW:** A few more questions about the console. What are the inputs and outputs?

**Hood:** The console is a combination analog and digital, but mostly it uses AES3 in and out.

Network Indiana, for instance,

Philadelphia, who has done a lot of digital wiring. His lament was that more equipment isn't shipped with digital inputs and outputs. Do you agree?

**Hood:** Correct. I would like to see more equipment with both analog and digital I/O.

**RW:** You use an SAS router. If you could go back to SAS or to any switcher manufacturer and ask for any improvements,

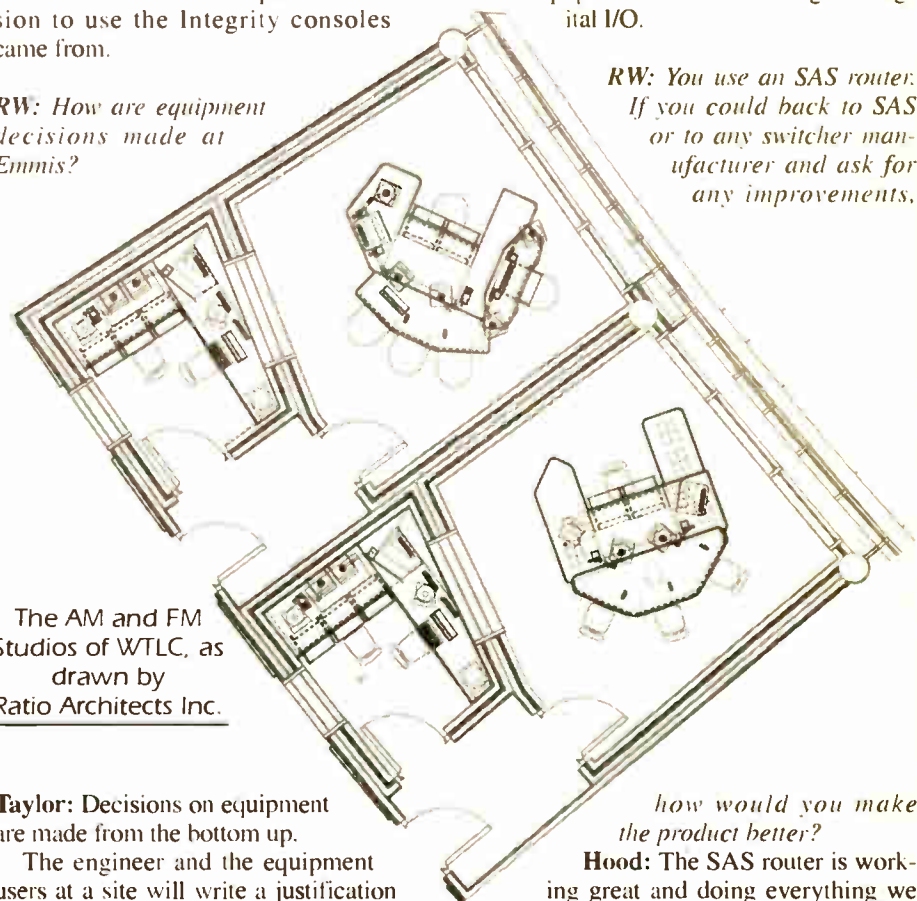

how would you make the product better?

**Hood:** The SAS router is working great and doing everything we want, it's just that we wish we had gotten the combination analog/digital router — and now I understand they have an AES3, but it was too late for us.

Their support has been magnificent. Their books (manuals) need to be improved.

One of the criteria we used in the equipment selection process was not only experience with the equipment, but support. That's become a huge issue.

## Importance of support

**RW:** Why?

**Hood:** Because more and more equipment is coming from the manufacturer as what I'm calling "black boxes."

They don't want us in there. I've been in broadcasting for 28 years, and I'm used to getting into an ITC machine — "Oh, that capacitor, I'll go to Radio Shack and get it."

Now we're getting equipment that is black-box — you don't get in there and fix it, you have to send it back to the manufacturer. Some of the stuff is plug-and-chug.

See EMMIS, page 23 ►



At Work in the New Emmis Facility

► EMMIS, continued from page 22  
you can replace a module, but it's gotten to the point where we have to rely on the company for support, or we're dead in the water.

**RW:** Is that support forthcoming from most manufacturers, given the post-consolidation demands of a group like Emmis, with all these studios?

**Taylor:** They have to, because if they don't support us, we have no use for their product.

We're having a problem with a particular company right now that we are paying \$5,000 a year for annual support, and we're getting lousy support from them.

## More Than An Architect

Ratio Architects Inc. of Indianapolis played an important role in the Emmis headquarters project. The company guided the technical and engineering design, as well as the building and interior design. Under its direction, a team of suppliers was set up to deliver an integrated technical system.

Pacific Research & Engineering was selected to implement the broadcast systems and furniture design and installation. Ratio Principal Steve Risting called PR&E the "leading supplier and installation service for major radio broadcast facilities throughout the world."

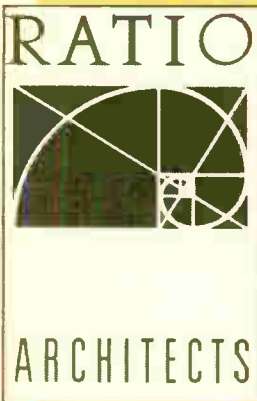

Northeastern Communications Concepts Inc. in New York provided acoustical and studio layout expertise. The construction manager was Shiel/Sexton of Indianapolis.

Among the design objectives in the project was to create a facility that "expressed a distinct and innovative identity for Emmis with a communications theme," according to Ratio. To accomplish that, the designers used mullions on the exterior, custom-glass curtain walls, spaced to represent FM waves by varying in spacing, and a custom metal trellis above the outside entry to represent AM waves, varying in height. Inside details on the furniture also use the wave theme.

WIBC(AM) General Manager Tom Severino praised Ratio for its "remarkable job" of integrating broadcast needs with architectural and construction issues.

**RW:** Do you find that there are a number of companies now that charge you for annual support services?

**Taylor:** Oh yes, and if it's reasonable. I don't have an argument with it, because if I pay so much a month for service and need to call at 3:12 a.m. on Christmas Eve, I expect someone to be there.



The concluding part of this interview appears March 17. The full text and additional photos also are available at [www.rwonline.com](http://www.rwonline.com)

This is one in a series of articles about how radio stations and groups are implementing digital technology.

## The Engineers of Emmis

Among the key technical staff during the construction of the new Emmis Communications headquarters:

Curtis E. Taylor, 31, is the chief information officer for Emmis. He joined the company in June of 1998. He has held system manager positions at Allied Signal Aerospace, and before that computer management positions with Bank One Financial Services.

He started his career in 1989 as a systems programmer and holds a BS degree in advanced technical studies, an AAS degree in computer information processing, an MBA from Butler University and a MA in telecommunication management.

Dave Hood, 51, is chief engineer of WTLC-AM-FM, which he joined in 1994. He graduated from Purdue University with a BS-EET in 1977, and worked for WLHN(FM) in Anderson, Ind., until 1996. He has performed contract work for 12 stations.

Other important engineers on the project include:

Bob Hawkins, chief engineer of WENS(FM) and WNAP-FM; Jeff Dinsmore, chief engineer for WIBC(AM), Network Indiana and Agri-America; and Kenny Elcock, staff engineer for WIBC(AM), Network Indiana and Agri-America.

# The Best Digital Audio Delivery System Just Got Better More Powerful, Less Cost!

Make the **EZ** Selection

Library & Playlist Modification Module <b>EZ-LIB</b> Great For PD's, MD's, Traffic... Multiple Cart Walls Module <b>EZ-ARRAY</b> Unlimited Instant Access-Customize Each User Automated or Live Assist Player Module <b>EZ-PLAY</b> Up to 4 Available Per Workstation MasterLog Live Assist Player Module <b>EZ-MLOG</b> Second Generation Interface for Advanced Users Quad Player Module <b>EZ-QPLAY</b> Multi-Deck Cart Player Enhanced Quad Player Module <b>EZ-4PLAY</b> Multi-Deck Player With Scheduling	Tracker 2000 Module <b>EZ-TRKR</b> The Easiest & Most Powerful Voice Tracker Available Recording & AutoRecording Machine Module <b>EZ-REC</b> Up to 4 Available Per Workstation Graphic Waveform Cut & Paste Assembly Editor Module <b>EZ-EDIT</b> Fast Non-Destructive Editor Script Display Module <b>EZ-SCRIPT</b> Prompting Display With Embedded Audio Wire Capture & Editing <b>NewsDAD32</b> Complete News System <b>STRATA</b> Embedded DAD Application
--	---

The DAD<sub>PRO</sub>32 Digital Audio Delivery System already has a widely established and enviable reputation as the most versatile and reliable system on the market. Now configuring a DAD System

is as easy as picking your favorite tunes. New EZ Modules permit selection of only the features and functionality required for optimization of any Workstation, typically at a significant cost savings.



LAN or WAN - LIVE ASSIST or AUTOMATED  
MAJOR or SMALL MARKET  
DAD<sub>PRO</sub>32 DELIVERS WHAT OTHERS ONLY PROMISE

Applicable Play and Record DSP boards will need to be added depending on module selected. The full DAD<sub>PRO</sub>32 system is recommended for operationally intensive facilities. For more information on EZ Modules and other DAD products, contact your nearest ENCO dealer, or call



24555 Hallwood Court, Farmington Hills, MI 48335 USA  
Tel: 800-362-6797 or 248-476-5711  
Fax: 248-476-5712 • [www.enco.com](http://www.enco.com)



## FIRST PERSON

# KPBS-FM Election Case Study

*Full-Scale Deployment Is Key When a Leading Public Radio Station Covers a Big Vote*

**Bruce Rogow**

To bring the most comprehensive and up-to-date information to our audience, the Engineering Department of San Diego's KPBS-FM recreated the station newsroom at City Hall this past Election Day.

The Registrar of Voters converts Golden Hall, a huge theater in downtown San Diego, into "Election Central," where the candidates and their supporters

gather to watch the returns. It's also the remote broadcast site for local television and radio stations. The general public sees and hears the same faces and voices to whom they turn every day, in a raucous new background. For the engineers, it's full-scale deployment of people and equipment that takes weeks to plan.

### Strategic motions

The KPBS-FM news department intended not only to broadcast live from

Golden Hall, but also to conduct live interviews with candidates and reporters calling in from other locations around the city. This meant recording interviews from the field and editing them on site, complemented by access to AP Newswire, the County of San Diego online election returns and the Internet. Additionally, two-way radio communications was required between the news director and the roving reporters in the hall. Even though this was radio, it took a van full of equipment to make it happen.

The city divided up the hall's perimeter and sold lots like a real estate developer. The local TV stations took the

biggest lots and built lighted stages for their news sets. KPBS-FM opted for three eight-foot banquet tables. Power is provided for each location, but other services have to be ordered in advance.

At one end of the room is a 100-foot-wide board where the race results are displayed. Throughout the night, volunteers write vote totals as ballots are counted. In addition to reporters, news crews and election volunteers, more than 500 candidate supporters — many carrying signs and shouting slogans when a camera appeared — attended the event. It was bedlam, hardly the quiet studio environment we're used to.

### Making it happen

To fulfill the needs of the news department, both analog and digital technology were required. One piece of equipment, a selectable talkback system, had to be custom built for the live election coverage. Setting up for the live interview was simple. We used a Mackie 1402 14-channel mixer. Four Sennheiser MKE 4032 microphones in shock mounts were placed on the center of the three tables, and we provided Sony MDR 7506 headphones for two hosts and two guests.

The headphone mixes were the most difficult aspects of the audio setup. Because of talkback requirements, a separate headphone mix was necessary for the hosts, guests and technical director. Two Aux busses on the Mackie mixer

**More than 500**

**supporters attended.**

**It was bedlam, hardly**

**the quiet studio**

**environment we're**

**used to.**

and two additional Shure mixers were needed to sort it all out. The individual headphone mixes were fed to a pair of Crown D-75 power amps. The outputs were connected to Furman HR-2 volume controllers for each mic position.

To accomplish audio editing, we used a 166 MHz Pentium PC with 32 MB of RAM running EdDitor Plus from Minnetonka software. This program was the precursor to Fast EdDit, and provides cut-and-paste single-track editing. We equipped the PC with the CardD Plus sound card from Digital Audio Labs.

At approximately \$600, the CardD Plus is expensive, but you can't beat the sound quality and signal-to-noise performance. It has unbalanced RCA inputs and outputs, so a Henry Engineering Matchbox was used to convert to balanced XLR connectors. During the broadcast, we played edited sound bites out of the computer to air. The computer eliminated two open-reel tape machines and a cart recorder.

To bring the Internet and AP Newswire to the remote site, a more elaborate arrangement was necessary. We used our file server computer (166 MHz Pentium, 128 MB RAM) running Windows NT Server 4.0 and RAS (remote access server) to act as our link to the resources back at the studio. We installed ISDN modems in the server and in the remote computer, a 100 MHz

See KPBS, page 25 ▶

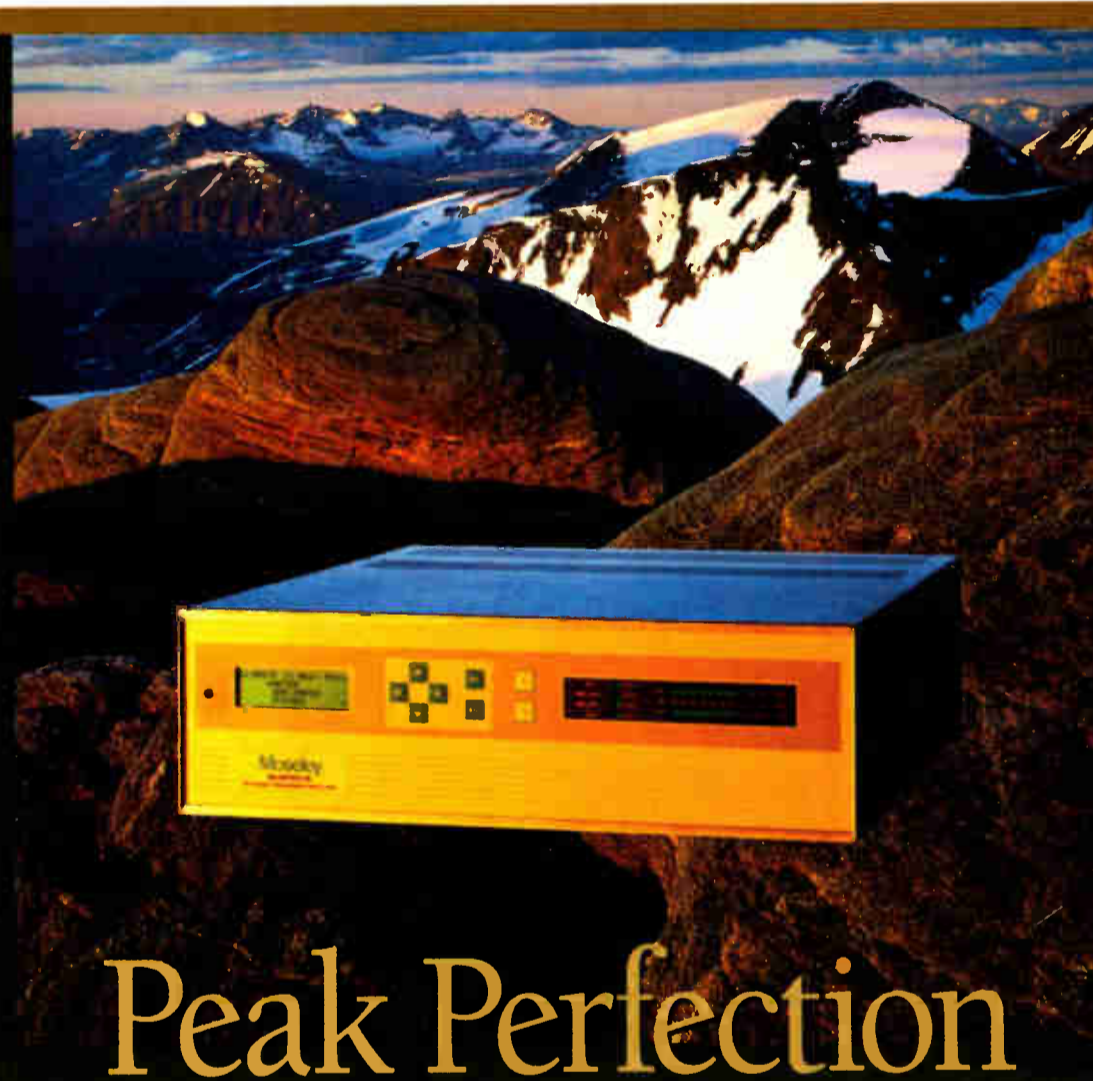

## Peak Perfection

INTRODUCING the Starlink SL9003Q — the world's first open-architecture, all-digital, 4-channel aural Studio Transmitter Link. Using spectrally efficient QAM (quadrature amplitude modulation) technology, it conveys up to four linear non-compressed audio channels over a single narrow bandwidth 950 MHz STL

channel. Yes, we did say non-compressed. AES/EBU I/Os, combined with a built-in sample rate converter, provide seamless connection without compression or delay. User selectable digital audio sampling rates of 32, 44.1 or 48 kHz together with a choice of 16, 32 or 64 QAM allows the optimization of occupied

bandwidth, robustness and connectivity to equipment in the all-digital air chain. But most importantly, the Starlink SL9003Q is from your friends at Moseley—continuing four decades of leadership and innovation in the broadcast industry. Attain the summit of peak audio performance with the Starlink SL9003Q. ▲

**Moseley**

111 Castilian Drive • Santa Barbara, CA 93117-3093 • USA  
Telephone (805) 968-9621 • Fax (805) 685-9638 • www.moseleysb.com



► KPBS, continued from page 24

Pentium, to achieve a faster connection.

Using RAS, we were able to run Netscape and AP News as if we were hooked up to a local hub. The main difference was the connection speed. Even with the 115k ISDN connection, the access time was slow. Next time we

tion results used ProComm Plus for Windows at a 9600 modem connection. We set up a local eight-port hub to network all the PCs so they could share a single laser printer.

We accomplished the link between KPBS-FM Master Control and Golden Hall with a Telos Zephyr ISDN codec at

The telephone caller audio was sent G.722 to minimize the time delay when the hosts were interviewing the callers.

**Lessons learned**

Advance planning is crucial to the success of any remote broadcast. With the added complexity of news production on site, procedures must be clarified in advance. Be prepared for people who want to change the setup for increased comfort and convenience. The requests can be time-consuming to implement and

director. There is a tendency to want to provide everything for everybody, and while it can be done, don't let the complexity create a situation where the final product is compromised.

Finally, a rehearsal is highly recommended to iron out the bugs. The bottom line is there is no substitute for detailed, advanced planning and a rehearsal to ensure the seamless broadcast the listeners expect.

■ ■ ■

*Bruce Rogow is a free-lance writer and assistant chief engineer for KPBS-*



KPBS-FM Operations Director John Decker mixes the live broadcast, including interviews, spot digital audio playback and headphone feeds.



Staff reporters Carrie Kahn and Scott Horsley interview candidates and report election results from Golden Hall in San Diego.

intend to have the local cable TV provider install a cable modem and use Point-to-Point Tunneling Protocol (PPTP) to connect to our server.

Since the roving reporters needed access to the computer as well as to the host anchors, we added an NTI Technologies video/keyboard/mouse splitter box to the fray. The splitter allows two workstations to control the same computer. The County online elec-

each end — four independent audio paths were used. The program audio from Golden Hall to master control was sent via Layer III stereo on channel "A" and a separate talkback from the remote technical director on channel "B." In the other direction, we sent audio from telephone callers received at the station to the remote site while the second channel provided talkback from master control to the technical director at Golden Hall.

have unpredictable results, neither of which one can afford on a live broadcast.

We learned to simplify the setup as much as possible. Also, mixing audio for air and three separate headphone mixes was a great challenge for the technical

*FM in San Diego. He has worked in radio and television engineering for more than seven years.*

*Got an engineering story to tell? Send e-mail to radioworld@imaspub.com or write to the address on page 5.*

# digital consoles — outstanding

**PARADIGM**  
DIGITAL RADIO ON-AIR CONSOLE

**Not a console idea ...  
but a real broadcast tool!**

- PARADIGM includes:
- Connection of up to 24 sources
  - Voice processor on every microphone
  - Phase, balance, mode on every line input
  - Recall the setup for each operator
  - Powerful external control logic
  - Clock shows day, date and time
  - Timer has digital readout and graphic display
  - Modern look with traditional operating features
  - Provides your master digital audio sync
  - Easy to install and maintain



There's more.....

test drive one at NAB 1999, Booth L-10994  
or contact KLOTZ DIGITAL worldwide at one of the locations below

**KLOTZ**  
DIGITAL

**KLOTZ DIGITAL** <http://www.klotzdigital.com> · e-mail: [sales@klotz-digital.de](mailto:sales@klotz-digital.de)

**KLOTZ DIGITAL Audio Communications GmbH, Germany**  
**KLOTZ DIGITAL AMERICA INC., USA**  
**KLOTZ DIGITAL, France**  
**KLOTZ DIGITAL (M) SDN BHD (454 317-X), Malaysia**

Hans-Stiessberger-Str.2a · D-85540 Haar · Phone: +49-89-46 23 38-81 · Fax: +49-89-46 23 38-61  
Nortech Park · 5875 Peachtree Ind Blvd. #340 · Norcross, GA 30092 · Phone: +1-678-966-9900 · Fax: +1-678-966-9903  
87 Rue St. Martin · F-75004 Paris · Phone: +33-1-4887 4681 · Fax: +33-1-4804 7146  
Wisma Samudra · Level 4, No.1, Jalan Kontraktor U1/14 · Seksyen U1, Hicom-Glenmarie Industrial Park  
40150 Shah Alam · Selangor Darul Ehsan · Phone: +60-3-5193233 · Fax: +60-3-5195133

# A challenge from the greatest critic of the OPTIMOD-FM 8200 - the guy who invented it.

**ON AIR**



**"Version 3.0 is more  
than an upgrade.**

**It can take your  
station's signature  
to the next level of  
competitive sound.**

**Listen to it side  
by side with any  
audio processor in  
existence; then, let  
me know what you  
think. Good or bad,  
every e-mail sent to  
me will be answered  
by me, personally.  
bob@orban.com."**

**orban®**

**H** A Harman International Company

**BOB ORBAN** is known for his critical ears. In the seven years since we introduced OPTIMOD-FM 8200, perhaps no one has logged more hours listening to the best and worst in digital audio processing. Even critics have called his knack for creating louder, punchier, artifact-free sound "a gift." But make no mistake. With 30 years of experience in audio, it's Bob Orban's expertise that is written into every layer of the new Version 3.0 software. It gives you a level of audio technology that no other processor in existence can match.

#### **NOTHING IS NEWER.**

Version 3.0 software adds five new features to OPTIMOD 8200's proven digital platform. With thousands of users and millions of on-air hours to draw on, Orban's team knew exactly how to take your station's audio to the next level. 21 new presets dramatically expand your options to create a superior competitive sound. Sonic "color" controls now allow you to fine-tune tonal balance to precisely target your desired audience. Tweak the band output mix controls to add sizzle, bring vocals up front, or mellow out instrumentals. Raise the bass clipper threshold to create a more solid bass punch for urban and dance formats. Toggle Phase Rotation on/off to minimize distortion or improve music transparency. Open up the highs to effectively remove any hint of what has erroneously been called "digital grunge."

#### **NOTHING SOUNDS BETTER.**

Cut to cut, spot to spot, announcer after announcer, nothing delivers a more consistent sound than the new Version 3.0 software. Which means that hour after hour your station's signature sound remains true to your audience's preference. The dynamic, musical presentation never fatigues listeners. Every minute you're on the air, you achieve a unique sound that brands your station with a distinct presence in the market. Loud. Clean. Clear and Punchy. Side by

side, no other processor delivers higher quality sound or requires fewer hassles to achieve it.

#### **DIGITAL PROCESSING DONE RIGHT.**

After seven years of listening, tweaking and non-stop critiquing, we've confirmed what you've known all along: the biggest news in FM digital processing is still OPTIMOD-FM 8200. OPTIMOD integrates perfectly into any industry-standard STL and transmitter environment—no exciter modifications or non-standard connections are



necessary. It achieves tight peak control without composite clipping that trashes subcarriers. In short, it delivers elegant, professional engineering—not junk science or marketing spin. In the words of one of the most critical ears in radio, "don't believe everything you hear." Listen for yourself.

#### **UPGRADE NOW.**

In a matter of minutes you can upgrade the 8200 to the newest, best-sounding, best-performing audio processor in radio. Call your Orban dealer for details. Visit our website for more information. And e-mail Bob to let him know what you think.



# GM Journal



Services for  
Your Station  
Page 34

Radio World

Resource for Business, Programming & Sales

February 17, 1999

## Minorities Eye Radio Mountain

Lynn Meadows

Blacks, Hispanics, Asians and Native Americans own less than 3 percent of all the radio and television stations in the United States, according to the 1998 Minority Commercial Broadcast Ownership report recently released by the National Telecommunications and Information Administration.

According to the report, 160 minority broadcasters own 337 of the 11,524 radio and television stations in the country. Limited access to capital frequently is cited as the main reason for the disparity in ownership. But David Honig, executive director of the Minority Media and

financial resources, Honig said. Later, and beyond the scope of the FCC, minorities found that when they did have the money to buy a station, they were not aware when stations went up for sale, Honig said.

### Minority rules

Today, a few black owners, including Bishop L.E. Willis of Willis Broadcasting and Cathy Hughes of Radio One Broadcasting Company, own broadcast stations in multiple markets. According to the report, Amador Bustos, president of Z Spanish Radio Network, is the only Hispanic broadcast owner who owns more than 10 stations.

tions, language is one factor that binds a minority-owned station to the community and vice versa.

According to the NTIA report, the Navajo Nation, which covers 25,000 square miles in the North American southwest, is the only Native American owner of broadcast stations. Twelve years ago, only the Nation's border towns were receiving broadcast signals, according to General Manager Tazbah McCullah.

The board of directors for the Nation applied for and received a 50 kW, clear-channel station, KTNN(AM) went on the air in 1986 with a Navajo-language format. Today, KTNN competes with other privately owned stations that also broadcast in Navajo but do not reach the whole Nation.

"We're very local," said McCullah of KTNN. The station airs funeral announcements and lost and found announcements every day. The staff does at least seven remotes every week. On Tuesdays, KTNN broadcasts "Navajo See MINORITY, page 28 ▶



Tony Ramsey, Keven Kofax and Karen Gross at the Virginia State Fair

Telecommunications Council, said the explanation is too simple.

In the early days of broadcasting, he said, it cost relatively little to start a radio station. But Honig said FCC rules discriminated against what he described as "would-be" minority broadcasters. Broadcast experience was a factor during the comparative hearing process, and Honig said this rule deterred minority involvement. Another deterrent, according to Honig, was an FCC requirement that a new owner have sufficient money to run a station for one year without revenue.

Minorities typically did not have either broadcast experience or the necessary

Bishop, Hughes and Bustos are exceptions. According to the report, 33 of the 56 Hispanic commercial radio station owners in the United States are single-station owners. Thirty own AM stations. Likewise, 63 of the 90 black commercial radio station owners own one station, and 44 of those own AMs.

The survey reveals only two Asian owners among the nation's radio owner groups. Kwang Wook Choi owns an AM and an FM in Los Angeles and Arthur Liu owns three AM stations in New York.

Honig said most, but not all, minority-owned stations service minorities. As in the case of many Hispanic-owned sta-

## KPTY Party Radio Plays to Young Ears

Dee McVicker

Shock programming is making airwaves in Gilbert, Ariz., a bedroom community in the Phoenix area.

There is some irony in the controversy, given that this is an area of FM old-timers with names like The Edge and The Zone — euphemisms for a generation once accused of being out of control.

One of some 45 stations in the Phoenix area, KPTY(FM), known as "Party Radio," skews its programming to the lower end of the 12-to-35 age group.

Its on-air antics include water pipe giveaways and songs like "South Park Bitch" and "ICP Clown Mix" by the rap duo Insane Clown Posse, which saw its

latest album shelved by its record company for obscenity and violence.

Station managers say they are pursuing a generation that has eluded



Public service for the 'Wake and Bake' morning crew included a food drive.

radio thus far.

Program Director Byron Kennedy said, "I don't think radio has moved with the generations. I think young people's

See PARTY RADIO, page 30 ▶

## Perfect the Art of Broadcasting



netia

DIGITAL AUDIO

<http://www.netia-broadcast.com>

Audio software  
and on-air  
automation for  
any size operation

In North America, call toll-free: (877) 730-2616 • e-mail: [L.Gross@netia.fr](mailto:L.Gross@netia.fr)

Tel. (410) 730-2616 • Fax (410) 730-6718

In Europe, call Netia International Sales & Marketing (in France): +33-4-67590807 • e-mail [marketing@netia.fr](mailto:marketing@netia.fr)

# Minority Radio Faces Challenges

► **MINORITY**, continued from page 27  
 Nights," which features stories from the Navajo tradition. When the Phoenix Suns play, KTNN airs the play-by-play in Navajo.

KTNN sales representatives sell to advertisers in Albuquerque, N.M., Salt Lake City and Phoenix. With consolidation, the competition for ad revenue has toughened, McCullah said. She competes against one local group selling spots for less than half of the KTNN spot rate.

"It's made us stronger," McCullah said of consolidation. "We could have sat back maybe for the next five years on our laurels."

In Chicago, Melody Spann-Cooper has a much different challenge as president



and general manager of WVON(AM) on 1450 kHz. "The Talk of Chicago" is owned by a group of five stockholders — all black Americans.

### Black talk radio

WVON shares its signal with WCEV, a Polish station. WVON broadcasts from 10 p.m. to 1 p.m., and WCEV broadcasts the remaining hours.

"I've had five offers in the last two years," said Spann-Cooper, laughing at the thought. "We're committed to keeping this station." She said it is fortunate to have a niche, which she described as "black talk."

"No one else is doing our particular format," Spann-Cooper said. The station does not subscribe to Arbitron. She said she sells on the basis of quality of listenership, explaining to advertisers that the average listener is 35+ with disposable income and high time spent listening.

"They get a good bang for their buck."

said Spann-Cooper.

In Richmond, Va., another black-owned station is getting noticed and getting ratings, too. In this case, the four black majority shareholders of the group, called FM 100, shared an interest in giving back to the community and invested in local radio. The group acquired its third and most powerful station, WKJS(FM) in January when minority shareholder and General Manager Larry Jones anticipated that a market consolidator would need to divest of one station.

Jones called a broker and the group acquired the 100 kW station for \$4.5 million without it ever actually being on the market. The group changed the station's oldies format into adult urban contemporary radio station, marketed as KISS 104.7. Its ranking improved from 12th to 5th place in adults 25-54 between the winter and summer books.

General Sales Manager Yvonne Vessels-Hagen joined FM 100 in January last year. She left a position as national sales manager for a large group because she liked the idea of coming back to local radio and the fact that FM-100 is minority-owned. "We have a passion for serving this community," Vessels-Hagen said.

"People are happy to come to work. We feel like we're on a mission. Everything we do is motivated by the interests of the community we live in," Jones said. "We frankly are very proud of what we are doing. This is not just a business to me. It's a way of life."

Vessels-Hagen stressed that good promotions have garnered recognition for

WKJS. That notice or recognition has led to better ratings.

"No, we don't have \$50,000 for promotions out of our own pocket, but with good partners we can make things happen," she said.

During the holidays, the station asked listeners to write letters about people who needed help in their communities. The station has been granting wishes, includ-

indication of what minority stations are up against. "That's just one that we've heard about," said Honig.

Asked if the local ownership aspect will translate into higher revenue, Jones said that, little by little, he expects the community will notice the difference between a locally owned station and one that is not. He said the listener would feel there is a reason to support this radio station beyond what the next song is. He said he did not think being black-owned gave the station an advantage, rather it is the quality of the station that will attract listeners.

The FCC must remedy the effects of its own discrimination, Honig said. One "race neutral" initiative that would have a little impact, he said, would be for sellers to send out notices when a station is for sale.

Bringing back tax certificates for owners who sell to minorities is another option, he said. "This isn't just a way to make millionaires," said Honig. "This is a way to hear different voices."

Spann-Cooper and Jones agreed that the FCC would need to play a role in increasing minority ownership.

"I think for it to turn around, it's going to take the commitment of the FCC," Spann-Cooper said. She said she heard FCC Chairman William Kennard at the National Association of Black Owned Broadcasters talk about ways to help minorities into ownership positions.

She thinks more minorities will sell their stations in the next two to three years simply because the purchase offers are "amazing." Jones of FM 100 said the gap in minority ownership is only correctable if the FCC gives extra credit for new station applicants who are minorities.

"I think that's the only hope for most people," he said, referring to the cost of buying a ready-made station.

Reach Lynn Meadows via e-mail at meadows@pinn.net

### A FIVE-YEAR COMPARATIVE ANALYSIS

Year	Industry	Minority	Black	Hispanic	Asian	Native American
1993	AM	4,950	185	120	63	0
	FM	4,920	108	80	23	2
1994	AM	4,929	191	111	76	1
	FM	5,044	121	80	35	3
1995	AM	4,906	185	109	72	2
	FM	5,285	129	86	34	3
1996-97	AM	4,814	184	101	80	1
	FM	5,468	100	64	31	2
1997-98	AM	4,724	189	100	84	4
	FM	5,591	116	68	46	1

Total Minority and Non-Minority Owned Commercial Broadcast Stations Licensed in the U.S. in 1993-1998

ing finding a seeing eye dog for a blind man with the help of the Lions Club and a car for someone who needs transportation, with the help of the advertising community.

Vessels-Hagen said the sales team has had to educate the advertising community on the importance of directing their ads toward the stations' listeners.

"We stress the importance of advertising to the black community and the necessity of issuing an invitation to our audience as opposed to giving them permission to frequent their businesses and purchase their products," Vessels-Hagen said.

### Amazing offers

Vessels-Hagen is being gracious, Honig said. He used the infamous Katz memo that circulated last spring as an

**JOHN SUTTON'S BIG BAND SWING**

THE PRE-PRODUCED VERSION OF THE LONG RUNNING LIVE BIG BAND SWING SHOW IS NOW AVAILABLE ON CD! THE CD VERSION OF THE SHOW IS A FOUR-HOUR FORMAT WITH STAND ALONE HOURS SO THAT YOU CAN PROGRAM EACH HOUR INDIVIDUALLY OR TOGETHER WHERE YOU NEED THEM OR RUN THEM AS OFTEN AS YOU LIKE! THE MAIN PROGRAMMING DIFFERENCE FROM THE LIVE SHOW IS THAT THE CD SHOW LEANS TOWARD THE NEWER AND MORE UPTEMPO SOUNDS OF THE CLASSIC BIG BAND SWING AND JUMP SONGS.

EXAMPLES OF ARTISTS FEATURED ALONG WITH THE TRACKS FROM MILLER, BASIE AND JAMES: BIG BAD VOODOO DADDY, SQUIRREL NUT ZIPPERS, BRIAN SETZER, MICHAEL CIVISCA, CHERRY POPPIN' DADDIES, GEORGE GEE AND HIS MAKE BELIEVE BALLROOM ORCHESTRA, ETC.

## BIG BAND SWING ON CD

WEBSTER AUDIO PRODUCTS, INC.  
 6635 S DAYTON ST. SUITE 290  
 GREENWOOD VILLAGE, CO 80111  
 PH: 1-800-757-9464  
 FAX: 1-303-790-8543  
 WWW.WEBSTERAUDIO.COM

Tons of fun... expand your audience... you would be surprised at all of the nostalgia listeners who want to hear the new big bands and vocalists too. We have over 4,000 CD's in our library and can bring your listening audience a variety of new releases and new artists.



IF YOU HAVE BEEN WAITING TO PROGRAM BIG BAND SWING, BUT WERE NOT ABLE TO TAKE IT LIVE, OR IF YOU ALREADY CARRY IT LIVE AND WANT THE DIVERSITY OF THE NEWER MUSIC - GET ON BOARD TODAY. THIS PROGRAM IS PROVIDED ON A MARKET EXCLUSIVE BASIS AND IS A BARTERED PROGRAM.

DON'T LET THE SWING AND JUMP CRAZE PASS YOU BY. THE LISTENING AUDIENCE FOR THIS PROGRAM IS CATERED TO THE 18 - 65 PLUS DEMO, OPENING THE DOORS TO A VARIETY OF ADVERTISERS.

## STATION/STUDIO SERVICES

**Sound Effects  
 Production Effects  
 Buy-Out Production Music!**

Over 50 products to choose from. Call 612-522-6256 or get full details and hear on-line demos at our web site:

<http://radio-mall.com>

Dave Dworkin's Ghostwriters  
 2412 Unity Ave N., Dept RW,  
 Minneapolis, MN 55422

READER SERVICE 128



**Satellite Delivered  
 Radio Programming**

Tel: 954-735-4070  
 Fax: 954-735-0370

READER SERVICE 127

### ATTENTION PROVIDERS!

Promote your services to **Radio World's** 18,000+ readers. Reach Radio Station and Recording Studio owners/managers and engineers with your message. For information on affordable advertising call **Simone** at **1-800-336-3045, extension 154.**

# Your digital console should meet your specifications.

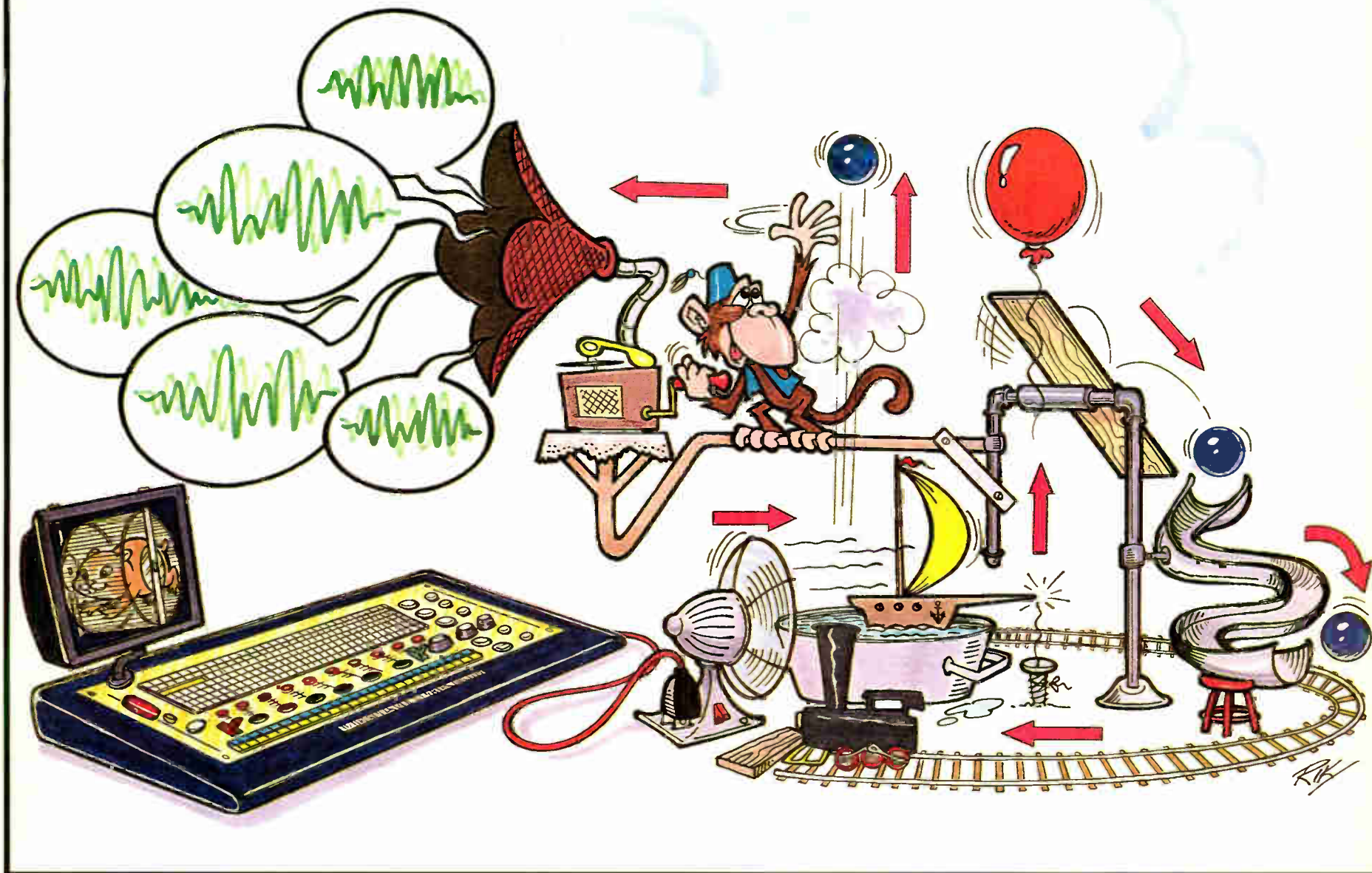

You expect more out of a digital console than simple operation, analog feel, or a hybrid analog/digital design. Hybrid consoles that depend on analog are brought to market by manufacturers who have no faith in the integrity of their digital abilities.

When the first Harris digital console went on the air over two years ago, it was a welcomed change, because Harris developed the DRC line by listening to the requirements of broadcasters like you.

You will easily recognize the sonic improvement of true digital when you hear the Harris DRC2000. No other on-air radio console can give you the capabilities you need today with the strength to fill your future needs. Each channel has audio effects processing that is the best in the business. The DRC2000. Nothing else comes closer to digital done right.



**next level solutions**

WIRELESS

BROADCAST

COMMUNICATIONS  
PRODUCTS

**HARRIS**  
Communications

1-800-622-0022 ■ [www.harris.com/communications](http://www.harris.com/communications)

# Broadcast Solutions

for broadcast professionals.

"My job is to make sure our listeners hear a seamless, interactive broadcast—and fortunately, that's Gentner's job too."

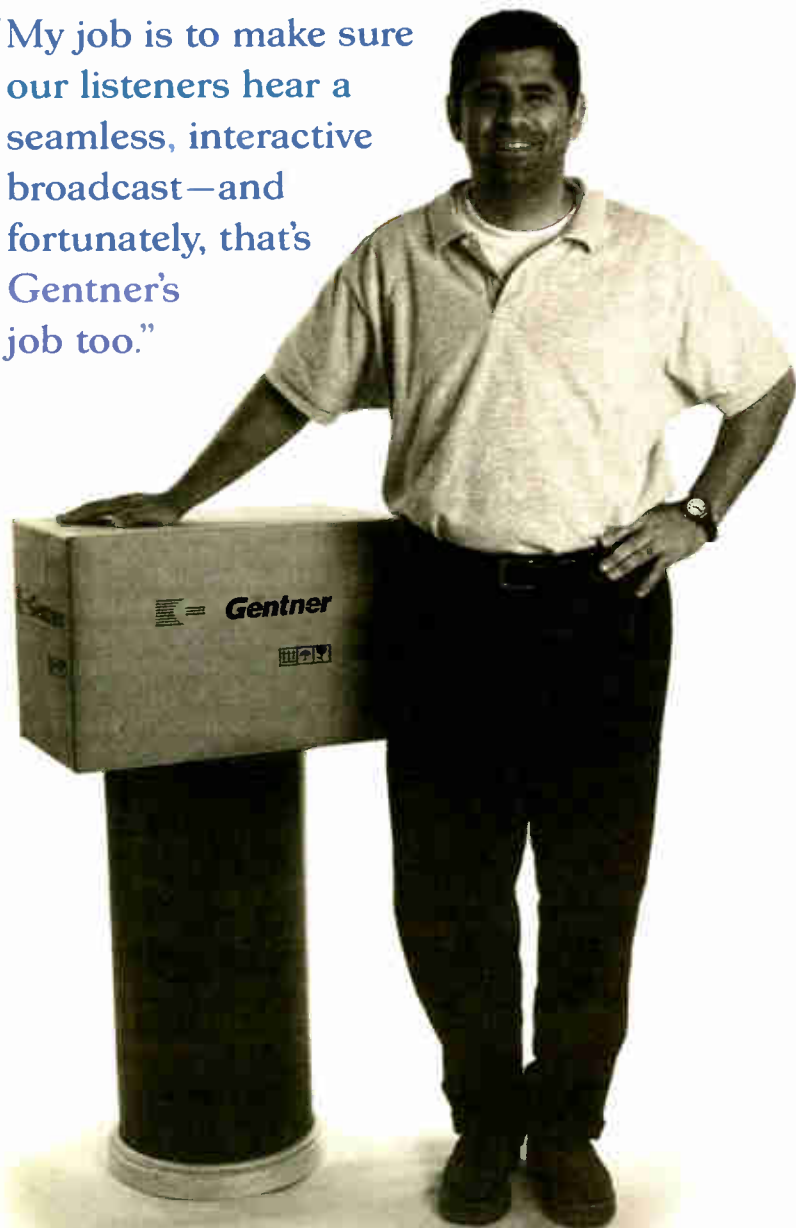

**NEW**



Introducing our **NEW** state-of-the-art 24 bit digital hybrid—**DH30**

Gentner offers telephone interface products for any broadcast setting—from live remote, to broadcasts, to listener call-ins. We have the right solution for you.

**Gentner**

Perfect Communication through Technology, Service, and Education.™

1.800.765.9320 • 1.801.975.7200 • [www.gentner.com](http://www.gentner.com)  
Fax-On-Demand: 1.800.695.8110 DH30 Doc. #3014

## KPTY: Raunchy Radio or Good, Plain Rock and Roll?

► PARTY RADIO, continued from page 27  
tastes are a lot different. Everything changes, why shouldn't radio?"

Owner New Planet Radio acquired KPTY from Rainbow Broadcasting in September of 1996 for \$7.35 million, according to BIA figures. Kennedy has pursued the 12+ demographic before for New Planet Radio, which also owns three stations in Hawaii, including one with a similar format.

Kennedy describes the format, which has been on the air since June of 1998, as "MTV on the radio."

"Honolulu was the first one ... and it exploded" in the ratings, he said.

The Gilbert station, at 103.9 MHz, is relatively new to a market that includes the often raw sexual advice of "Loveline" on KUPD-FM, and the national attention-grabber himself, Howard Stern, on KEDJ(FM).

### Wake and bake

Officials of the station's city of license are concerned.

"They're doing a lot of songs that deal with drugs and other issues that you might just call raunchy. And we're not happy about that," said David Cannella, a spokesman for the city of Gilbert.

The Party Radio debate is playing out in the local newspaper, centered mostly on the songs the station plays and the listeners it targets. One listener was quoted in the Arizona Republic as saying, "It's scary to hear 12-year-olds calling up asking for 'Detachable Penis.'"

Criticism extends to on-air jock banter and station promotions. "Big Mama," a KPTY morning jock, calls his show "Wake and Bake," an apparent reference to smoking marijuana.

In September of 1998, according to the Arizona Republic, personality Super Snake reportedly left the station because it started giving away "bongs." Kennedy said Super Snake left because his contract had expired and the station chose not to extend it.

Kennedy does not deny that water pipes were given away during a station promotion.

"They're legal to sell and they're water pipes," he said. He argues that the station plays to the realities of drugs, but does not promote them.

Cannella disagrees.

"We spend a lot of money with our drug-resistance programs in schools, and to have a radio station say, 'Well, that's already out there, so we're just going to play to it', that's ridiculous," Cannella said.

But KPTY is, by Cannella's assessment, a good corporate citizen.

"Their management has been involved in the Sister Cities program, and they seem to take an interest in things that go on in Gilbert," he said.

Mayor Cynthia Dunham has been a guest on KPTY's Sunday morning news program. Cannella feels the station simply needs to cut a few of its offensive songs, and it can still appeal to the younger generation.

Of course, the station programming is not within the city's jurisdiction. But what about the FCC?

"Our jurisdiction is very limited because of the First Amendment," said FCC spokeswoman Rosemary Kimball. "Basically, it's very easy to be in compliance." The FCC doesn't promote indecency on the air; however, it does allow it to be broadcast after 10 p.m.

But the question is whether what's broadcast is deemed obscene or indecent by the FCC. Obscene speech is not protected by the First Amendment and cannot be broadcast at any time. "There's a difference between indecent and obscene. Obscene is a criminal offense. It's persecuted by the Department of Justice and it's never allowed," said Kimball.

To rise to the level of obscenity, according to the FCC, broadcasts must meet a three-pronged test: "Number 1: An average person, applying contemporary community standards, must find that the material, as a whole, appeals to the prurient interest. Number 2: The material must depict or describe, in a patently offensive way, sexual conduct specifically defined by applicable law. Number 3: the material, taken as a whole, must lack serious literary, artistic, political or scientific value," according to FCC guidelines.

### Commission fines

"It was much easier when you had the seven dirty words to deal with.

Now, everything is on a case-by-case basis," said Kimball, who could not say whether KPTY was being investigated by the commission as a result of any complaints.

Although KPTY had not been fined by the FCC in the seven months since it started airing the format, it recently settled a \$7,500 fine dating from before the format change.

"That was issued probably a year and a half ago for playing Prince's 'Erotic City,' which is something you'd probably never hear on our radio station (now)," Kennedy said. "It was the old format and they apparently played, or were accused of playing, the unedited version. As far as I know they played the edited version. And we were fighting it, and it had never become official until two months ago, after we switched the format."

Kennedy said the KPTY song list now is music meant for the airwaves, and that the station is getting a bad rap for being different.

"There's no question in my mind that every station playing CHR or that type of format, that they're all playing the same songs, and if once an hour or twice an hour we can have a song that's an identifier, it helps us. They are songs that (other stations) won't take a chance to play because they're scared of bad publicity or bad press," Kennedy said.

The station lost revenue when several advertisers pulled spots following a rash of local newspaper articles, Kennedy said.

But Cannella said the city continues to receive complaints about the music on the station.

■ ■ ■

Dee McVicker is a regular contributor to RW.



## STATION FINANCING

# The Big Day Finally Arrives

Dain Schult

*This is one in a series of occasional articles on financing the purchase of a radio station. The most recent part appeared Sept. 30. You can read previous parts at [www.rwonline.com](http://www.rwonline.com)*

Welcome to the part of the program that really is the scariest part of it all, the day you finally close on your station.

Try to relax and realize that the excitement and the anticipation of something good happening overshadows the actual event when it occurs. For example, that vacation you've dreamed of taking to an exotic location may never quite live up to those dreams you've had. If you're lucky, though, your dreams cannot even begin to touch the reality of the actual event. Chances are you have a bright future ahead as a station owner.

Preparation is the best way to avoid a disappointment. Unless you are prepared for that closing, you will know what the dog thinks when he finally catches the car he's been chasing: Okay, I'm out of breath, still pumping the adrenaline and a little confused. Now what? Getting to this point can be so challenging and exciting in its own right, the closing can be almost anticlimactic.

The hallmark of real estate is location, location, location. The closing of a station deal requires preparation, preparation and preparation. Clear this hurdle and you enter the Promised Land of Ownership, where your real challenges begin.

## Details and choices

The preparation includes a brainstorming session with a pen and paper in hand. Start with a list of all your thoughts on the myriad details that need care and attention. While you brainstorm, keep in mind those needs will change and increase in importance just before the closing, during the process of the purchase and again after the deal is closed. Also, you want to list those details that will need a double-check. There are always some issues that require a second fix. Unfortunately, there is no such thing as the Closing Fairy, who will show up and take care of all of these details. You have to take care of them, or they won't get done.

Consider this experience to be like the most colossal move you've ever done. When you relocate, there are a thousand things to do right before you leave your former residence. Soon after you reach your new home, you are again faced with the many things you must put in place.

The principle applies here. For example, someone must change all of the station's utility accounts to new company name. Ditto on phone services, the newspaper, the cable company, the bank accounts and the janitorial service. Someone must re-title the station vehicles. Don't forget to get an insurance binder so the new company has insurance covered and you can avoid a lapse in any policies. Then there's the locks on the doors (if needed) and a new business license.

Do you get the idea? Many seemingly small details, when put together, add up to a lot of time and energy. Nevertheless

they must be attended to, in order to complete the close.

## The last inspection

Will you be leasing the studio, office or tower site space? If so, make sure that you have taken care of the deposits. (Yes, more cash flows.)

Walk through the station inventory again and make sure everything is there as advertised. If you videotaped it the first time, tape it again and compare the two tapes. You may have nothing to worry about. Beware, however; items can disappear in the middle of the night. It's the craziest thing; they just sprout legs and walk out.

Stick to the Cold War adage: trust, but verify.

## There is no such thing as the Closing Fairy, who will show up and take care of all of these details. You have to do it.

Your engineer should make one more inspection of the equipment to make sure everything is in full compliance with applicable FCC regulations.

This is your last chance to call something to the attention of the seller. After the closing, it won't be so easy to take care of. In fact, it may be impossible to get something handled in a timely manner, if at all.

Prior to the closing, your local attorney or the seller's attorney, in conjunction with FCC attorneys, will begin drawing up the closing documents. I have attended closings at which the minimalist approach was taken, and it worked okay. Others resembled the paperwork necessary to end the Vietnam War at the Paris Peace Table, with a full conference table loaded down with documents to be signed and passed around the room. As always, somewhere in the middle may be the correct procedure. It depends on the mood of the attorneys, or so it seems.

If you are supposed to bring checks instead of handling the money through wire transfers, be prepared to do so, and make sure the checks have the correct names and amounts. Bring at least two blank company checks. Inevitably, something else will come up, involving more money.

This also is the last chance to avoid seller's or buyer's remorse. Real, strong emotions can grab hold and take your breath away. Have you ever bought a car where the payments were really more than you could handle, but you really wanted it regardless of the logic or the lack thereof involved? The purchase of a radio station can produce much of the same feeling. The realization of what you're about to do can be scary as hell. Take a deep breath and do it anyway. It's too late to turn back now.

Besides, you'll do fine with the station. It will have a happy ending. If not, I have a list of really good brokers to whom I can introduce you.

## Memories for sale

The seller is, in many cases, going through mental (and sometimes physical) anguish, too. Perhaps the couple selling the station look upon the business as their

baby. You weren't with them that time their news person won a state association award. Nor were you present when the local high school team won the state championship, and everyone in town was listening that night to this radio station and talked about it for weeks after.

You are too young to remember what it felt like to sit in the control room with a full room of equipment instead of just a mixer, computer, monitor and a microphone.

Agree with every one of their stories and reminiscences. No matter what they say about it, they're right. Reassure them that you, too, will bathe, diaper, nurse and nap the baby correctly. Giving any less emotion won't do.

Besides, you owe it to that station to give it your full attention. That station is, in many cases, a link through the generations of a community.

Savor the moments of this time. The first closing always will be the most important one. Good, bad or ugly, it



becomes a part of your personal broadcast history.

A small point, but important just the same: Make sure you have a "ceremonial treaty pen" (a term defined by one of my attorneys) with which to sign the closing documents. It doesn't have to be gold-plated, but it should be more than one of the ball-point pens you picked up at the last radio convention. Something that you can put in your trophy case and gaze upon proudly later.

See how simple all of this is? We'll tackle the post-closing chores in the next installment. Until then, time to shake hands and have your picture taken with the seller for the local newspaper.

■ ■ ■

*RW welcomes other points of view.*

## The playlist editor is just part of our picture.



- Easy on-line playlist editing capability.

Pristine RapidFire:  
the all-in-one digital broadcast  
system.

Pristine  
**RAPIDFIRE**

[www.pristinesys.com](http://www.pristinesys.com) (310) 670-7500

# Barter Works for 'Judy Jarvis Show'

April Bartel

Before money there was barter. It's a little something for a little something in return, like apples for hickory nuts or a really nice basket for a fresh-caught fish.

How about a nationally syndicated talk-radio program for advertising inventory? The concept may be ancient, but it works for Judy Jarvis.

Emerging and established radio personalities and networks are using the barter method to break into new markets and establish a market position. Such is the case with "The Judy Jarvis Show."

"An awful lot of radio is done that way," said the show's business manager, Debbie Shillo. "Dr. Laura did it that way. Now she is starting to charge for her program as well."

Since 1993, Jarvis, a writer-turned-talk show host, has been growing her budding business on the barter system, winning over affiliates with the promise of a good deal. Her show broke the 50-affiliate milestone in September. Competitors Rush Limbaugh and Dr. Laura are heard on 590 and 440 stations respectively.

Many of the stations that carry the program are in the Northeast, the same neck of the woods as her studio in Farmington, Conn. But a number of affiliates of "The Judy Jarvis Show" are as far-flung as Oregon, Kansas and Florida.

WSYB(AM) in Rutland, Vt., picked up the show last fall, replacing Rush Limbaugh in the midday time slot that the latter had occupied for eight years.

WSYB General Manager Tom Barney said the bottom line was money. "The real truth is we dropped Rush because we had to pay for him and we can't sell him."

Barney said, "Fifty percent of the people love him. Fifty percent hate him."

The sales people suffered when the show didn't seem to measure up as an appropriate venue for advertising in the minds of many local business owners. "Many people who do like him don't spend money on him because they're afraid they'll offend the

other 50 percent of potential customers."

"It's a very difficult sell. I don't think it sells better in a major market, but in a major market it can get you ratings," Barney said.

With the exception of annual county-by-county ratings for persons 18+, his market doesn't have ratings, he said.

"A 50 share here ... it doesn't do me any good if I can't get people to buy the program," Barney said.



Judy Jarvis works with her son, broadcast engineer Jason.

Premiere Radio Networks carries both the Limbaugh and Dr. Laura programs. Vice President and COO Kraig Kitchen said both shows have proven their worth with advertisers and are two of the top three most successfully sponsored programs in the history of radio.

"Generating the kind of income and revenues they are — that would allow the Dr. Laura radio program to be the single largest purchased radio program in the his-

tory of national radio at \$71.5 million — would tell any common business person that it is a very successful sales vehicle."

Kitchen said the sale of the Limbaugh and Dr. Dean Edell programs in 1998 for a reported \$80 million are further proof that advertisers are buying the time.

Barney is pragmatic about the cost savings that barter programs can offer. "Let's just say, if everybody charged what Rush charges, \$20,000 a year for each daypart, five shifts a day, less the morning show which is live and local, I could save about \$70,000 a year."

Looking at the bottom line, Barney thinks the trade is fair. "If I can take a good national program and just give up inventory, I have lots of inventory. If I ever get to the point where I don't have inventory, that would be a nice problem."

Shillo hears similar comments from affiliated stations all the time. Regarding Rush, Shillo said, "Some (advertisers) just don't want to be connected to his news. It's purely a business decision. We're there and we offer a quality show."

Jarvis' online newsletter is quick to position her against Limbaugh and to proclaim competitive success. Last spring, it ran an article titled "Slappin' Rush Around: The Bigger You Are the Harder You Fall," after Jarvis beat Limbaugh in the Arbitron ratings for New Bedford, Mass.

Elbow to elbow or head to head, the word from her company headquarters is that Jarvis is holding her own alongside radio heavyweights like Rush Limbaugh and Dr. Laura. Limbaugh supporters tell a different story, pointing to the number of stations that carry each program.

"I haven't had any negative feedback about her," Barney said. "People called in angry when we first dropped Rush, but those were the people who were listening. Since Judy's been on the air, I've gotten a lot of comments from people who have discovered the show and really like it. They

are just not as vocal as the Rush people."

In June 1998, "The Judy Jarvis Show" announced a new partnership with WinStar Affiliate Sales. The syndicated radio clearance firm took on the job of extending the program to more affiliates. And last fall the show expanded to five hours, now broadcasting from 10 a.m. until 3 p.m. every weekday via satellite.

John Speeney, program director for WFPG-FM in Atlantic City, N.J., added the show to his lineup in early December. He said he was looking for a program to strengthen midday and afternoon, but, unlike WSYB, didn't drop other programs.

Speeney didn't ditch Dr. Laura when he added Judy. He reorganized. "The benefit is, as a small-market station, to be able to carry a nationally syndicated program and not have to pay for it, does wonders," he said. Judy Jarvis is "wedged between Debbie Nigro and Dr. Laura."

Speeney said he would track ratings and feedback for about six months before pronouncing Jarvis a "thumbs up" or "thumbs down" in his market.

A self-proclaimed "independent-minded broad," Jarvis doesn't limit show topics to partisan issues. "Most of us, even those who aren't as politically independent as I am, think both parties' politicians are more interested in their jobs than our country," Jarvis said. She welcomes any subject, from government to television and the Internet, sex, feminism, road rage, workplace issues or parenting. She doesn't mince words when giving her opinions. Guests on Jarvis' show have included Bill and Hillary Clinton, Bob Dole, Michael Keaton, Anne Rice, Jane Fonda and Walter Cronkite.

A former Boston Globe and Time magazine writer, Jarvis is a political science graduate from Boston University and a former teacher. These days, Jarvis often contributes to op-ed pages of newspapers around the country. Shillo said research and reading are keys to Jarvis' ability to stay current and keep the audience involved.

## Music Gives Way to Talk at L.A. Legend

Bob Rusk

The radio station that brought the Beatles to the Hollywood Bowl on the Fab Four's first U.S. tour in 1964, KRLA(AM), has dropped its legendary rock music format and switched to talk.

The new lineup, which debuted late last year, includes nationally syndicated hosts Don Imus, Dr. Toni Grant and G. Gordon Liddy. The lone, local weekday host is British-accented Michael Jackson in the 9 a.m. to noon shift, the same slot he held for 30 years at cross-town talker KABC(AM).

Jackson was relegated to a weekend-only shift at KABC more than a year ago, but resigned from the station to go back on the air full time at KRLA.

Bob Moore, KRLA vice president and general manager, said the response to hiring Jackson, a pioneer of Los Angeles talk radio, has been "unbelievable."

"People have been calling, faxing and sending e-mails and letters to congratulate us."

The change at KRLA was the culmi-

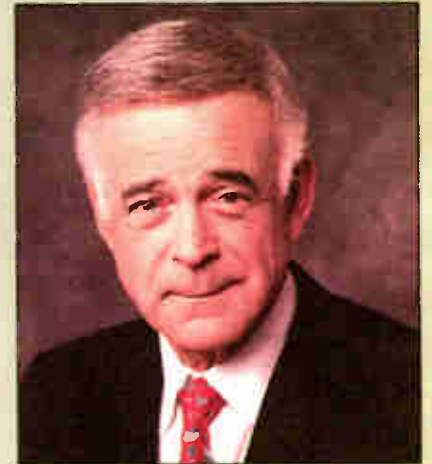

Michael Jackson is the mid-day host on KRLA.

nation of an 18-month study in which 250 phone calls were made per week to adult households in Los Angeles and Orange counties, Moore said.

"This started when CBS took over the station (from Greater Media) in 1997. When you're running a music format on

See KRLA, page 35 ▶



### How much would you pay for this response?

>100dB S/N • 2.5 mile line driver • Ground/Lightning isolation  
90-day satisfaction guarantee. 3 year parts and labor warranty.  
2 channels for less than \$1,650.

[www.kci-dfw.com](http://www.kci-dfw.com)

Knight's Communications Inc., 2219 West Broadway,  
Fort Worth, Texas 76102 800-880-5061





# Get Hip to Radio Web Site Rules

**Alan Haber**

The time has come for us to regroup and be sure that we're all on the same page with regard to what works and what fails for radio station Web sites.

It's time to lose those dated promotional patterns that took shape in the early Internet days. Start here while we establish a few things that are not cool and never will be cool. What have we learned in our recent talks on distance? Let's quickly review: You're never closer to there than here. But first you've got to get there, and some of us aren't quite there yet.

You may still be presenting such cool stuff on your site as your executive hierarchy and a snazzy welcome message from your program director. If that's you, you're really not as cool as you think you are and, by the way, you never looked good in platform shoes — not even with that stripes-vs.-polka dots ensemble.

It's hard to fathom, but I still see some stations violating the basic Rules of Never, which were created here in the Cyber House by our staff of weary Web surfer dudes.

Follow the following scrupulously, and you'll surely find yourself on the path of least resistance — the path on which Web surfers who suck up everything you have

happy and engaged, not imprisoned.

Have faith that your station's site is good enough to entice visitors to return after they've gone to surf elsewhere. Believe me, if you offer enough cool information and make your site an interactive one, they'll come back.

2. *Never use greetings like "This site is under construction," "This site is perennially under construction," or "Under Construction! Check back soon!"* For that matter, anything with the word *construction* in it. Your site is *not* under construction. I repeat: Your site is not



under construction. It was when you were developing it, but as soon as you published it, it ceased being thus. Sure, you're always adding to your site, making changes and redesigning every so often, but you are *not* under construction. This message appears as though you're always apologizing for your site. Never use the slogan,

"Pardon our mess" or any similar messages. Make the decision to include information on your site in a form you like, have faith in that decision, and stick with it. That is, until you change your mind

down the line, but always lead from strength. Leading from strong decision-making begins with avoiding the use of those groovy little animations on your pages. The perennially opening envelope, the mailbox next to your e-mail link, the ditch digger and all the rest are commonly shared figures that add an amateur look to your Web site.

3. Here's the most important "never" of all: *Never listen to anyone else, including me, when it comes to your station's Web site.* Well, uh, maybe listen to me but nobody else. Only you know what's right for your station's Web site. For most stations, the site value is in making money. Try to remember, there's more to this Web site game than increasing the financial bottom line. Next time, we'll explore another bottom line you hardly ever hear about. Meanwhile, never say I never said never.

**The key is to keep visitors and travelers happy and engaged, not imprisoned.**

on your site come to hang out. They're like sponges, these people. The kind of folks you want to visit your site again and again. And they will, you know, as long as you have something cool to give them.

**Bring 'em back home**

1. *Never program your site so that when visitors link to other sites from it they appear to be still on yours.*

This kind of thing irritates me to no end. There you are at the Kickin' Up a Storm Country 107 site, perusing a list of links to hot country artist Web homes, and you find one that purports to be the most complete, up-to-date, *whiz-bangy* source of Garth Brooks info on the Net.

So you do what anyone would do: you click on the Brooks link. It appears as though you are taken to the Babbling About Brooks site, but wrapped around the Brooks site home page on your screen is a frame that looks like it's part of the Kickin' Up a Storm Country 107 site. And what's more, the Brooks site address isn't showing on your browser. You're still seeing the Web site address for the Kickin' site.

Only a station lacking full confidence in its cyber-home would do this to visitors. Part of the fun of surfing the Web is to find cool sites and bookmark them so you can easily go back to them. Using your Web site as a trap with the theory "we'll keep 'em here until they bleed," will not be a winner among surfers. You may end up only alienating your visitors instead of keeping them interested in your site.

The key is to keep visitors and travelers

## Get the full picture.

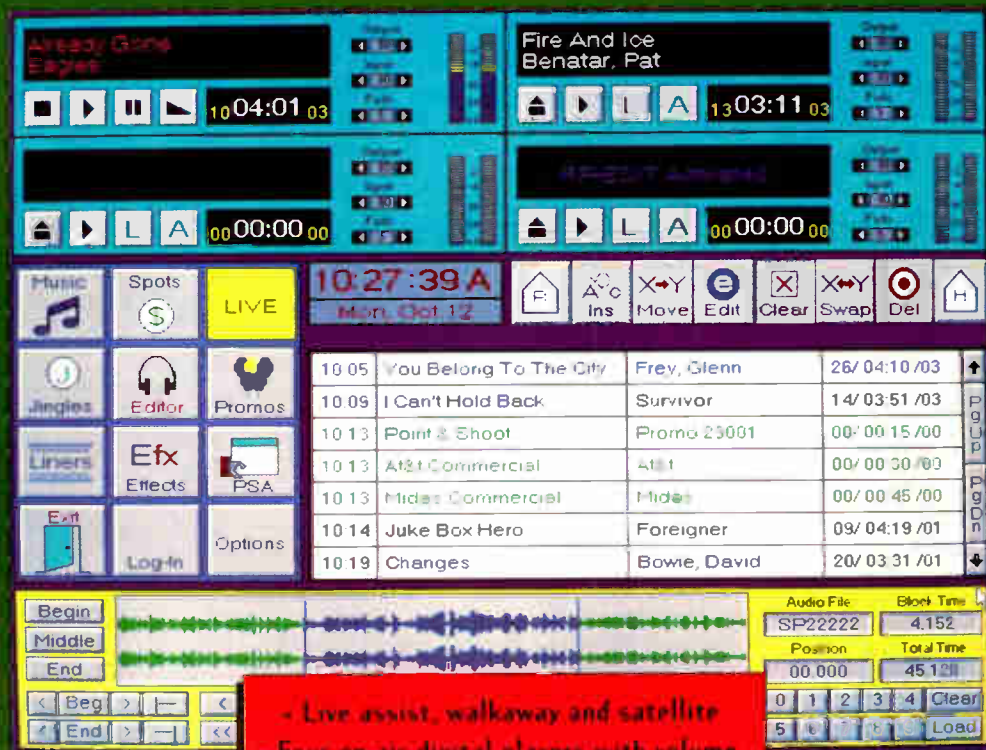

- Live assist, walkaway and satellite
- Four on-air digital players with volume, fade and segue control
- Easy playlist editing capability
- Access your entire audio library
- RF edit on-air waveform editor
- Instant jock "audio drop box"
- Bulletproof reliability
- Satisfaction guaranteed

**Pristine RapidFire:**  
the all-in-one digital broadcast system.

Access **Pristine RAPIDFIRE** on the web at [www.pristinesys.com](http://www.pristinesys.com) or call (310) 670-7500

Pristine RapidFire is a product of Pristine Systems, 5841 Uplander Way, Suite A, Culver City, CA 90230



# ◆ STATION SERVICES ◆

## Programs and Services for Radio Stations

Mail info and photos to: RW Station Services, P.O. Box 1214, Falls Church, VA 22041

### Hyuk, Hyuk Hits for Harris on Radio

The political comedy of Bob Harris has won audiences in many entertainment arenas: on stage as a stand-up comic; in print for National Lampoon, Mother Jones Online and The Funny Times; as a speaker at more than 300 colleges and, now, on a weekly radio show.



Bob Harris

The Harris radio program, aired on flagship CBS station KNX(AM) in Los Angeles, has been syndicated in a three-year deal with Dick Brescia and Associates to be delivered nationwide. At the outset, his show will be broadcast on more than 100 stations, according to DBA.



The radio shows will be recorded at the Museum of Television and Radio in Beverly Hills every other Thursday at 3 p.m. The show is free and open to the public.

Harris won the 1998 Associated Press award for Best Radio Feature and the L.A. Press Club award for Best Specialty Feature.

For more information contact Kathy Gronau at (323) 655-5214 or circle Reader Service 90.

### Sound Bites From AP to Radio Via the Net

The Internet can deliver natural sound and audio material to your radio station through the new Associated Press archive, AP SoundBank.

The new archive provides AP affiliates with more than 500,000 soundbites including audio reports on politics, entertainment, business, sports and general news. The archived database covers sev-

en decades from AP's audio collection. Correspondent reports, interviews in a question/answer format and natural sound also are available through the AP SoundBank.

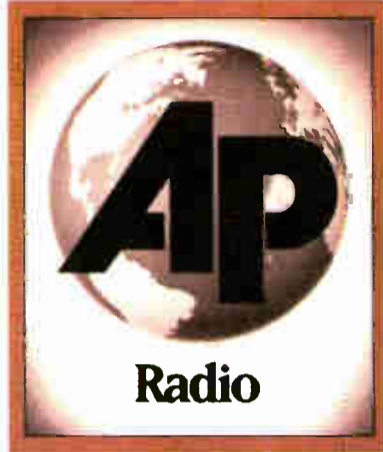

A standard Windows operating system, a sound card, an Internet connection and a browser are needed to access the AP SoundBank. AP lets users search, retrieve and preview digital soundbites before downloading the files. Users also will receive a software package designed for use with AP SoundBank, called AP SoundDesk, which allows users to edit, store and play back the audio tracks.

For more information call John K. Jones at (202) 736-1152 or circle Reader Service 116.

### Gospel Gets Down

This one-hour countdown of the nation's top 10 gospel hits offers more than just the songs. Listeners stay informed with Myriad Communications Network features "Gospel Industry Report," the "Myriad Health News" and the "Myriad Inspirational Moment," among other news and inspirational features.



Ron Marshall

"The Myriad Gospel Music Countdown" is a one-hour weekly re-cap of the top 10 gospel albums in the country. Less than three years ago, Myriad Communications Network and the radio program hit the airwaves from Birmingham, Ala. The countdown is now 24 affiliates strong and remains distinct as the only syndicated radio or television program to be distributed from Alabama.

For more information call Ron Marshall at (800) 964-0510 or circle Reader Service 79.

### Get 'Em While They're Fresh

An old advertising dog with a new marketing trick can help you to be among the first to welcome new listeners into your territory. Welcome Wagon and the advertising company Getting to Know You have designed a direct advertising campaign that enables radio stations to reach people before, during and after their re-location.



The marketing concept offers standard and new methods of getting the names of local businesses in the hands of potential future customers. Included among the standard marketing tools like gift certificates, pre-printed address books and insertions in the Welcome Wagon direct mail package, are opportunities to create custom programs for advertisers by searching the company's database on new homeowners.

Customers or businesses using Welcome Wagon can create marketing lists or mailing lists according to geographical location, financial income, sex, age and other demographic criteria. Welcome Wagon has 725 radio clients and began serving new homeowners and local businesses in the United States in 1928.

For more information contact Brian Moran at (908) 277-0955 or Scott Shapiro at (606) 253-9550 or circle Reader Service 53.

### 'Rockline' Adds Wednesday to Interactive Broadcast

On the air for more than 18 years, "Rockline" is the kind of radio program that rolls with the changes. The interactive broadcast allows listeners to talk live with popular musicians and to hear live concerts.



The syndicated program from AM/FM Radio Networks is now broadcast on Wednesdays in addition to its Monday-night feature. Both shows air at 11:30 p.m. EST. All genres of rock are featured on "Rockline," which has hosted artists such as Johnny Lang, Metallica and Monster Magnet.

John Mellencamp launched the Wednesday night "Rockline" program Jan. 6. The new Wednesday-night show debuted in major markets including New York, Los Angeles and Chicago. "Rockline" is aired on more than 100 stations.

For more information contact Martin Raab at AM/FM Radio Networks in Dallas at (972) 239-6220 or circle Reader Service 1.

# KRLA: A Rock Radio Institution

► KRLA, continued from page 32  
the AM dial in a major market, you have to know what your options are," he said.

"We wanted to find out what people thought was missing on the AM dial in the English-language music and talk formats. We found that nothing was

Angeles on Chancellor Media station KLAC, but his syndicator, CBS-managed Westwood One, liked the idea of moving the show to KRLA, Moore said.

"I knew (the Imus) contract was coming up for renewal," Moore said. "I went in and made the pitch to put him on an

which puts him in direct competition with former employer KABC, Jackson said, "I really intend to compete with a passion."

Jackson, however, said he has no ill feelings about the station. "I put things in perspective," he said. "I had 32 years there. Why should I let any unpleasantness at the end of it color most of my professional life? I had a wonderful career there. It was good for me and I think I was good for them."

KRLA began playing rock music in 1959, and through the years the station was home to some of the most popular disc jockeys in the business — including Casey Kasem, Wolfman Jack and Bob Eubanks, who would later make his mark in TV as host of "The Newlywed Game."

It was Eubanks, in association with KRLA, who brought the Beatles to the Hollywood Bowl.

Don Barrett, author of the book "L.A. Radio People," said, "The decade of the 1960s was when KRLA created great memories. By the 1970s, times had changed and the station never did. By the 1990s, time had passed the station by. The fact that the station played top 40 and oldies for 39 years places it at the top of the heap for longevity. If longevity stands for endurance, it endured."

"But it was time to put the oldies to rest. There is now jammin' oldies, K-EARTH oldies, and mega-100 oldies," said Barrett. "The memories of KRLA

when it was great will last a lifetime."

KRLA General Manager Moore said the station has been "an institution in L.A. radio," and it was a "huge emotional feeling" when he decided to change the format. "We wanted to do everything we could to preserve its dignity," he said.

"But this is also a business and you have to play to the largest audience you can, like any other form of entertainment," Moore said. "Unfortunately, our best opportunity at KRLA was not in keeping the music format."

■ ■ ■

Reach Bob Rusk via e-mail at [brusk@pacifier.net](mailto:brusk@pacifier.net)

**We wanted to preserve its dignity, but this is a business and you have to play to the largest audience you can, like any other form of entertainment.**

— Bob Moore, KRLA

missing in music. The choices listeners had were more than plentiful; listeners told us they just don't use the AM dial for music anymore," Moore said. Those choices include oldies station KRLA and adult standards KLAC(AM).

In talk programming, "the predominant comment was that people missed Michael Jackson on a weekday basis," said Moore. The opportunity to sign Jackson and grab Imus were key factors in Moore's decision to change the format at KRLA, which had been a rock outlet for almost 40 years.

Imus previously was heard in Los

all-talk station, which made sense."

KRLA now uses the slogan, "L.A. Talk 11-10." The station is targeting the 35-54 demographic group and is positioned with sister talk station KLSX(FM), targeting the 25-54 demo.

"It's a perfect match," said Moore, who also manages KLSX. "We cross both sides of the demographic parallel."

**Jackson ecstatic**

Jackson said he is "ecstatic" about his move to KRLA.

"They are committed to making this a significant talk station," he said.

Commenting on the new position,

**Attention: News Service Providers**

The April 28 issue of *Radio World* will feature a special Focus on News Services. If your organization provides news services to radio stations, including programs, audio and text feeds, software packages and consulting, you should be included in this editorial feature.

We're looking for your list of offerings, contact information and artwork. The deadline is March 23. For more information or to send your material, contact Radio World Business Editor, P.O. Box 1214, Falls Church, VA, 22041 or send e-mail to [lcebula@imaspub.com](mailto:lcebula@imaspub.com)



**MAGER SYSTEMS**  
The Best in Sound Furniture

Designed, Fabricated, Delivered and Installed  
21602 N. Central Ave., Suite 1  
Phoenix, Arizona 85024  
TEL: 602-780-0045  
FAX: 602-780-9860



**KMCG - San Diego**

**TIRED OF THE SAME OLD STUDIO FURNITURE?**



For over 18 years Broadcasters nationwide have come to Mager Systems for our exquisitely designed studio furniture. Our unique construction, along with solid wood and quality materials, means your furniture is built to last. In fact, we've made the design and construction of studio furniture as much an art form as it is a business. Every installation is backed by a 10 year warranty. Our quality is affordable and can accommodate every budget from economy to showplace. Call today and discover why Mager Systems is the best in Sound Furniture.

**AVONITE®**

Mager Systems is very proud to offer Avonite Solid Surface. Avonite is a non-porous solid surface material with depth and richness of stone in an easy-to-care for composite surface. Avonite is available in over 60 natural looking colors. Highly stain and scratch resistant, it boasts durability with confidence of a full 10 year warranty.



**KXGL - San Diego**



**KXGL - San Diego**



**KOOL - Phoenix**



radio SYSTEMS

# radio systems millenium products

Broadcast Consoles, Audio Distribution Amplifiers, Timing Systems, Digital Phone Hybrids

601 Heron Drive, Bridgeport, New Jersey 08014, (609) 467-8000 voice, (609) 467-3044 fax, [www.radiosystems.com](http://www.radiosystems.com)

Circle (10) On Reader Service Card

## MP3 Delivers Audio for Stations

Jeff Laurence

My company, Jeff Laurence Audio Productions and Autumn Hill Studios in North Carolina, produces audio for broadcast. Thankfully, quite a large amount goes out every week to television stations, advertising agencies and radio stations. Most of our work is radio station imaging and voice tracks, where

Stations deemed it important enough to receive their product the same day or overnight, but not necessarily at the same time I was producing it. Although most overnight delivery services do a superb job at getting it there on time, sometimes weather or other problems would hold up our product.

DG Systems and Digital Courier were hesitant to set my studio up with a trans-

my audio tracks in stereo to anywhere, ready to air.

### Enter MP3

I had spent some time talking to Rolf Taylor and the people at Telos Systems at the New Orleans NAB Radio Show in 1997. I inquired about the Zephyr and audio-transfer questions and Taylor directed me to the Telos Audioactive display area.

The company was just starting to tout the new Audioactive MP3 player and encoder, but had not gotten the ball rolling yet. RealAudio, LiquidAudio and a few others at the show wanted to be the format of choice for Webcasters, but my needs were less demanding.

They listened when I explained my desire to create a sort of "audio locker" on the Web where my clients could download their required audio tracks from a menu at their convenience.

See MP3, page 45 ▶



Jeff Laurence, Studio Owner and MP3 Aficionado

timing is of the utmost importance.

I opted to spend the money for an ISDN line. No small task, seeing how we live on a mountain way up in the Smoky Mountains, miles from the nearest telephone central office. When the local phone folks got it together, we finally connected almost three years ago. This after a three-year wait.

On my ISDN line, I use the Telos Zephyr. I do not represent Telos in any way, but I do own several cheerleader sweaters with big letter-Ts on them!

My dilemma came when I found that many of my client stations did not want to spend the money on ISDN. Most were happy with recorded media delivered overnight at their expense. Some had signed on with commercial digital audio delivery services.

mit terminal because I did not have enough clients to suit them. Besides, their systems were ideally set up for one studio to send one spot or track to multiple stations. What I needed was something with the quality of digital, the speed of the World Wide Web and the cost of a local phone call.

It occurred to me that most every station I knew had access to a computer or could trade one out for their production room. A reasonably equipped PC with a good sound card, minimum 1 GB storage and Internet access would complete a most powerful production room tool.

There is an astounding on-line world of audio waiting to be downloaded: music clips, MIDI files and samples galore. With this system, I could send

### PRODUCT EVALUATION

## Otari Joins MD Arena With MR-30 Recorder

Flip Michaels

The Otari Corporation has stepped onto the playing field of MiniDisc competition, joining with other companies such as Denon, Sharp, Yamaha, Tascam and Sony. Each company offers its own version of what a professional MD recorder should be with what kinds of features.

station's playlist that you have not heard in years. Either way, a flashback is triggered. Well, just hearing the name Otari makes my mind wander.

Founded in Japan 35 years ago, Otari has been active on the American radio scene for the past quarter century. Most of us remember when, back in the Bronze Age, some MX-5050 reel-to-reel editing



The Otari MR-30 MiniDisc Recorder has Big, Clear Play Buttons.

Otari's approach: Why not take the most innovative, successful and welcomed features of each corporation's unit and make something new? Enter the Otari MR-30.

### Memory trip

Maybe it is the '67 Mustang Convertible that passes before one's eyes one morning. Perhaps it is a hit song resurfacing on your

experience was a feather in a production pro's cap, and only the top stations possessed new Otari decks.

Rocking the reels became the bread and butter of the production department. "Yes, I'll take three razor blades, a pancake of quarter-inch Ampex and some splice tape to go, please."

See OTARI, page 44 ▶



## Trash your carts, burn CDs

Give all your production material the performance and reliability that only comes from CDs. CDs are the new standard in audio – compact, easy to use and efficient.

CD Architect is the professional mastering software that's accessible to untrained users. It verifies Red Book

standard audio before burning, fully supports PQ code editing, and lets you prepare the material in its own editor with multi-level undo.

From Sonic Foundry, the leader in Windows-based digital audio. Visit [www.sonicfoundry.com](http://www.sonicfoundry.com) or call us at 800-57-SONIC for more information.



# The Session From You-Know-Where

## Travis

The following story is true. Some of the names and minor details have been changed to protect the announcer.

One windy, sunny day in Los Angeles, I was on my way to a morning recording session, a voice-over job for two TV commercials. Beyond that, I had no further details, except that someone in the advertising agency really liked what I had done in the audition several months previously. I did not remember the audition.

Traffic was good to me that morning. In fact, I arrived at the studio almost an hour early. The commercial was being produced by a large ad agency — one that would use me for more commercial work if they liked my stuff.

## Palatial

I had worked at the particular recording studio only once before. The facility is designed to be impressive. In the lobby there are large areas of open space sprinkled with directional signs leading you to Studios A through M.

They have a staffed snack room, and I was soon offered coffee, along with the usual Hollywood morning fare of low-fat fruit accompanied by high-fat croissants.

After about an hour, I was directed to Studio G, where I was told the recording engineer and client had already situated themselves.

I was introduced to the recording engineer and his assistant. A woman with two young children sat in a sofa in the back of the control room. The engineer told me that the agency personnel were located on the "other" coast and would be directing me from there. We were connected by an ISDN system.

I've worked with ISDN feeds before, although I prefer to have the director in the control room. I like the personal contact. I also like to see the expression on the face of the director. Often a director will tell you he likes a take, while his expression is saying something different. By watching the director's face, often I will know when to make an adjustment the director hadn't considered.

The engineer explained that they had to make a few more adjustments and would then be ready to record, so I could go ahead and make myself comfortable in front of the microphone.

I did not see any copy anywhere, so I asked where it was. The engineer looked at

me blankly. He then picked up the phone and asked someone if the copy for our session had arrived yet.

He hit the talkback button on the console and said to someone at the other end of that line. "It seems that we don't have our announcer copy yet. Anybody there have a copy they could fax us?"

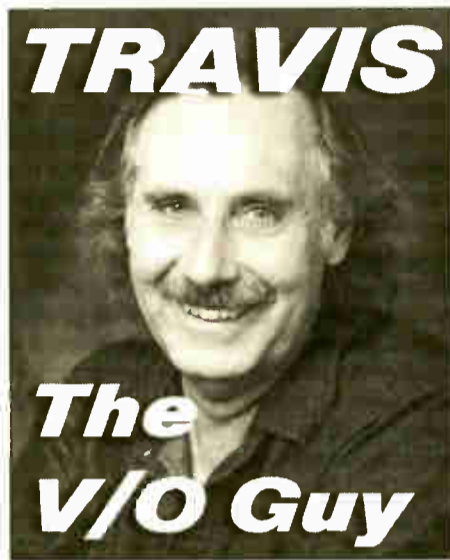

A voice from the studio speaker responded, "We have a 'rough,' which doesn't have approval. We need to make a phone call."

The engineer on our side replied, "We have only about an hour and a half to do this thing. We have another session booked for noon."

I introduced myself to the people on the other end of the ISDN connection, explaining that I was having trouble talking to them because of the ISDN delay. If the talkback system is on at the other end of the line, you hear yourself about a second later. Drives me crazy and makes me sound as if I'm trapped in time.

"That won't be a problem while we're recording," I explained, "because the talkback will be turned off."

"You'll have to do that there," the east coast engineer said to our engineer. "I'm not set up to shut off the talkback from our end."

"That's going to be tough," my engineer said. "I'm going direct from our box to his phones. It's about five minutes to reconfigure it."

I said, "What if I just take off the phones when I record?" Everybody seemed to think that was a good solution.

Just then, still warm from the fax machine, the copy was brought into the stu-

dio. Two spots, both basically the same. Two voice-over parts: mine about 20 seconds and a 10-second intro to be done by a "little girl," which explained the woman and children in the back of the control room.

There were four people on the other end of the ISDN connection: the engineer, the copywriter, and two men who never told me what their position was. I asked, "Which one of you is the director?"

One replied, "She's downstairs on the phone. She won't be back here for a while, so the three of us will be directing you."

## Uh-oh

The missing copy and the ISDN delay were minor issues I knew how to deal with. However, I have never been in a session with three "directors" that was not a catastrophe. I have done sessions with two directors and some with as many as five. But for some mysterious reason, three has always been the magic number for guaranteed disaster.

"Why don't you go ahead and try a first take?," one of the "directors" requested. I went ahead and took a first pass at the copy.

The response was positive. "Excellent," said one. "Let's do another take for a back-up." I'm sure they all heard my huge sigh of relief.

Then came a response from Director Two. "Are you sure that's what you want?" he said. There was no reaction from Director One. "I think we need to work on the second sentence. Read it this way." Director Two gave me his rendition of the sentence.

I underlined the words Director Two wanted punched up, and re-read the spot. Director Three now felt he had some ideas that needed to be incorporated. We worked on the spot for another 20 minutes, until my copy had almost every word underlined.

Each director had a different idea of what the actual spot should sound like, but had no idea his viewpoint was different from his compatriots. This was the same thing that had happened in my previous "three-director" sessions. The engineer in the control room was looking at his watch.

Just then a female voice came across the headphones. "I don't think he knows what we're looking for," she said.

"Well, I think Take One is actually pretty close," came the voice of Director One.

"No, on Take Four, he's got it," said Director Three. I could see my local engi-

neer behind the glass bury his head in his hands. They then played back takes one, four, and a few others for the woman director that had joined the group.

"Well, none of those are any good," said the woman. "Tell you what, let's record the girl, and then come back to Travis." I said that would be fine, since my next session was not for four more hours.

They spent another 45 minutes trying to get the six-year-old to say her eight lines. The woman on the east coast wanted the girl to keep the headphones on so she could coach her. The youngster was a trouper in spite of the ISDN delay.

Meanwhile, our studio engineer was trying to find room for our session in another studio at the facility. "I've got to get them out of here," he whispered on the telephone. "The people coming in at noon get me Dodger Tickets. I can't send them somewhere else!"

Two hours later we were in another studio. The female director was gone. The three other voices said they had all agreed that our previous Take One was fine for the first spot, so we were ready to record the second spot. All the directors agreed the first take was "perfect," so we recorded a back-up, which was also "perfect."

## One more time

Since that went so well, Director Two decided we should try *one more pass* at the first spot. I tried it again, and again the three directors were at odds as to how it should be read. After another hour and a half trying to satisfy all three directors, they listened again to the original Take One and, yes, decided it was good enough.

I called ahead to my next session. Unless traffic was especially good, I was probably going to be late. The director said that was fine, as he would much rather be at the video facility than at the office. Recording those spots took less than 10 minutes, three takes each.

Sometimes things go wrong, sometimes they go right.

Several months have passed since that session. A planned radio version of the campaign either never materialized, or they chose another announcer. Just last week I received an additional residual check for those spots, which means the sponsor decided to run them for another 13 weeks.

I really must remember that the next time I get a three-director session.

■ ■ ■

"Travis the V/O Guy" is a veteran voice-over artist writing from California. Send e-mail to vo-guy@pacbell.net

# PORTABLE ONE

## DUAL DOMAIN

True Dual Domain Audio Testing at an Attractive Price Point

- Comprehensive analog audio analyzer
- True digital domain analyzer with -140 dB residual noise
- Independent analog & digital audio generators and analyzers
- Generate and measure interface jitter
- Digital interface analyzer
- View AES/EBU status bits
- Loudspeaker monitor for digital & analog signals
- Internal save and recall of 30 test setups



Audio precision

Audio Precision  
PO Box 2209  
Beaverton, Oregon 97075-2209  
Tel: (503) 627-0832; Fax: (503) 641-8906; US Toll Free: 1-800-231-7350  
Email: techsupport@audioprecision.com; Web: www.audioprecision.com



# A digital PR&E console starting at just \$11,010.\*

(So advanced, even the price is digital.)

Airwave™ Digital. Three program busses. Two mix-minuses. One remarkable board.

\$11,010. Now there's a string of binary code anyone can understand. So if you're budgeting to go digital—and running tight on budget—take a close look at a 12 or 20 input Airwave Digital on-air console. Its familiar layout flattens the digital learning curve. And with 3 program busses, talent can be playing Madonna, time shifting a Dr. Laura feed, and laying down voice tracks—all at the same time. So you can squeeze more production out of your payroll.

Airwave's flexible, too. One or two telco modules and B-side logic are among a host of available options. And unlike some digital consoles, you can reconfigure input modules from analog to digital—or vice versa—at your studio, just by changing a card.

Best of all, Airwave Digital comes with that “no-need-to-rationalize-to-anyone” PR&E quality. Want to know more? Call 760-438-3911, visit [www.pre.com](http://www.pre.com) or email [sales@pre.com](mailto:sales@pre.com).



PACIFIC RESEARCH & ENGINEERING

\*12 input mainframe, standard clock/timer, monitor and output modules, standard 5-mic preamp module, 3 analog inputs, 1 digital inputs and 1 one telephone input/output module.

Circle (140) On Reader Service Card

## PRODUCT EVALUATION

# Zap Noise With Ray Gun Software

Read G. Burgan

I must have been seven or eight years old when I got that Buck Rogers ray gun for Christmas. It brought many exciting hours into my life as I played space cadet, '50s style.

It took a lot to believe the glorified plastic flashlight with its color filters and hokey sound was a ray gun. But imagination comes easy to an eight year old, and you'll simply have to take my word that it was I who single-handedly made our planet safe for another generation by destroying numerous colonies of space aliens.

Once again I have a ray gun. This one is made by Arboretum Systems and is a noise-reduction software package that promises, "Just point and shoot. Ray Gun will search and destroy the noise in any sound file, automatically."

## Zap!

I am no longer eight years old and my imagination needs more than ad copy to persuade me of a product's virtues. So I set off to see for myself what the Arboretum Ray Gun could do by testing it against other noise-reduction software.

Ray Gun comes in two forms: a stand-alone version that you can use by itself, and a DirectX plug-in version that will work with any program supporting DirectX plug-ins. It will run on either Mac or Windows 95 platforms.

The first thing I look for in any digital audio noise-reduction software is an

impulse filter for removing pops and clicks and a broadband noise filter for removing continuous noise. Ray Gun has tools for each of these functions.

This level controls the sensitivity of the impulse filter on a scale of 0 to 100 percent. You place the plug-in in the Preview mode and move the lever until the material starts



Keeping It Simple: The User Interface of Ray Gun From Arboretum Systems

First, the Impulse Noise filter. The goal of Arboretum was to provide a simple, uncomplicated means of digital noise removal. And the operating interface of the Impulse Noise filter is as easy to use as you can possibly get, short of eliminating all controls. It has just one lever marked "Pop."

to distort, and then back it off until it no longer distorts. Then you run the filter.

How effective is this simplistic approach to removing pops and clicks? I compared it to the software I usually use, and found it to be quite close in its results. It was surprisingly effective at removing pops and clicks from various vinyl sources. I would rate it A-minus.

Before we look at the Ray Gun Noise Reduction tool, we need to define some terms.

Most broadband noise-reduction software works by having the user select a silent portion between words or the silent portion between cuts of a record. Any sound in this sample should represent the noise present in the sound file. The noise reduction software then takes a "snapshot" of this noise and creates a filter that is designed to fit that precise snapshot.

Most noise reduction software has several onscreen controls that adjust parameters like the attack and release time, degree of noise attenuation and others. One software I use has seven adjustable parameters plus the ability to individually adjust the shape of the filter at more than 2,000 individual points in an x/y graph.

This creates a filter that "fits" the noise profile like a glove, and can result in a very quiet recording, even from one that seemed impossibly noisy. In an effort to maintain its commitment to user-friendly software, Arboretum uses a different approach. Instead of applying a noise print, the company uses a dynamic noise filter.

Never used a dynamic noise filter? Maybe you have. The old Burwen Laboratories hardware dynamic noise filter was popular in the '70s and was sold as the KLH 1201A Dynamic Noise Filter.

These essentially are downward expanders. You establish a threshold for noise and everything below that threshold is considered noise and is summarily expanded downwards. As an additional step in increasing the effective noise reduction, a filter is applied to the low-level signal (noise), but not to signals above the threshold (music).

## Product Capsule:

### Arboretum Systems Ray Gun Noise Reduction Software

#### Thumbs Up

- ✓ Reasonably priced
- ✓ Mac/PC versions
- ✓ DirectX compatible
- ✓ Simple to operate

#### Thumbs Down

- ✓ Dynamic filter limited
- ✓ Non-adjustable notch filter

For information, contact Arboretum Systems in California at (415) 626-4440 or circle Reader Service 37.

The assumption is that the psychoacoustic phenomenon of *masking* will cause the noise to be inaudible when the program material is present. This works out better with music than with spoken-word recordings. Arboretum carries this one step further by evaluating the noise and applying a 512-band filter to reduce the noise.

The advantage to this approach is simplicity. Ray Gun has only two controls: Threshold and Attenuation. The software automatically sets the threshold of the filter. The threshold control is an additional means for the user to fine-tune the effect. Attenuation controls how much the noise is attenuated, up to a maximum of 36 dB.

The problem is that you trade off effectiveness for simplicity. While dynamic noise filters were big in the days before digital audio processing — they are limited in the amount of noise they can remove.

Ray Gun's Noise Reduction filter does remove noise. But it is not able to eliminate all audible noise. If you are using a fairly clean vinyl LP or a tape with only a moderate degree of hiss, you might find its noise reduction performance satisfactory.

But if you are looking to seriously clean up analog material with continuous noise problems, you will probably want to look at one of the several noise reduction packages that uses a true noise-printing approach. To this end, I would rate Ray Gun's Noise Reduction filter a C-minus.

Ray Gun also includes a filter tool using notch filtering techniques to remove either 50 or 60 Hz hum and rumble. The operating manual does not indicate what settings each filter uses, nor are they user-adjustable. They are either on or off.

In applying them to recordings needing notch filtering to deal with rumble and hum, they did reduce low-frequency noise. But since they are not adjustable, their application is limited. I would rate these filters as a B-minus.

Arboretum's Ray Gun is designed for users who don't want to be bothered with the nuisance of setting parameters and learning new applications. Ray Gun meets its stated goal to provide a user-friendly package that will provide a moderate amount of noise reduction with no user intervention.

If you do not already have any noise reduction software and want a basic package that will require no learning curve, then the stand-alone version of Ray Gun may be just the ticket for you. The suggested retail price is \$99.

Arboretum Systems is at 915 Cole St., Suite 387, San Francisco, CA 94117. The company maintains a Web site at [www.arboretum.com](http://www.arboretum.com)

Read Burgan is a free-lance writer and a former public radio station manager. He can be reached at (906) 296-0652 or through e-mail at [rgb@up.net](mailto:rgb@up.net)

## SHORT TAKE

# CD CyClone Speeds Dupes

The CD CyClone Duplication System is available in three configurations, the latest being the T-8, an eight-drive duplicator with pre-mastering capabilities.

The large interactive LCD touchscreen at the top of the case offers future expansion of add-on features as they are developed. The T-8 is capable of pre-mastering CDs, negating the need for additional hardware and software. Color printing is possible with an optional color printer and 50-CD autoloader. An image is loaded into the host computer, the Print key is pressed and each disc receives color labeling and artwork.

A DAT capture card can be added to the CD CyClone T-8, allowing the import of audio from a DAT source. The duplicator has built-in support for 16 drives total, and each can be a 4X, 6X or 8X recorder. Future upgrades will include job queuing, which will let the T-8 duplicate different jobs simultaneously.

Specific broadcast uses of the T-8 include archiving, data duplication, "greatest hits" compilation discs for live on-air backup to automation systems, and as an option to short-run out-of-

house CD replication. As a revenue generator, the T-8 can be used to create quarterly station profiles on CD; personalities, music format and spot production samples can be brought to potential clients in a convenient, durable format.

The T-8 joins other products in the CD CyClone lineup, including the T-30 system, which uses 30 CD recorders and can dub up to 120 discs per hour.

The unit can record almost any data, hybrid, audio or multimedia CD format from an internal hard drive, or from a source CD within its CD-ROM drive.

A PC workstation and 30 4X read/write recorders are housed in one cabinet.

For less elaborate needs, the inexpensive One-2-One compact duplicator is a disc-to-disc copying machine with simple operations for Copy, Copy and Compare, Verify and Emulate Write functions.

Information on the CD CyClone product line can be obtained by contacting the company in California at (949) 470-4795; on the Internet at [www.cdyclone.com](http://www.cdyclone.com) or circle Reader Service 11.

—Alan R. Peterson



# Products & Services Showcase

For more information on the products shown below, circle the appropriate Reader Service No.(s) on the enclosed Subscription/Reader Service card or contact the advertiser directly.



## Has Your Automation Sailed... Without Your Weather?

Face it. An automation system isn't very automated when someone has to manually track and record constantly changing weather. Now, listeners can hear up-to-the-minute weather information in high-fidelity with no staff-intervention what-so-ever. The solution? A *Digital Weatherman™* from *Weatheradio™*! No Equipment to purchase. One low monthly fee includes system, data, and local weather sensors. Interfaces directly to EAS! Used daily by more than 350 radio stations as well as by AccuWeather™, Broadcast Electronics, Citadel, Capstar, Register Data Systems, Smarts Broadcast Systems, and many more. Call today for information!

DIAL 1-800-728-4647

Tom Churchill's  
**weatheradio™**

Do You Want Weather With That?

DEMO EXTN 199 SALES EXTN 100

READER SERVICE NO. 77

**SOLID STATE AM  
1 to 100 Watts  
PART 73 Type-Accepted**

**\$995 to \$3995  
Quick Delivery**

1-877-LPB-COMM (toll free)  
<http://www.lpbinc.com>

**YOU CAN RELY ON LPB  
SINCE 1960**

READER SERVICE NO. 24

**1,000 Hits on  
HARD DRIVE  
for \$695!**

**Compatible with Arrakis, BE,  
BSI, Enco, Prophet, Smarts,  
Register Data, others...**

All formats! Oldies, '70s, AC, Country  
1-day service at no extra charge!  
We load IDE, SCSI, JAZ

Just call our name

**800-HALLAND  
800-425-5263**

**HBS**  
HALLAND BROADCAST SERVICES, INC.

1289 East Alosta Avenue  
Glendora, CA 91740 USA  
Tel 626-963-6300  
Fax 626-963-2070  
[www.h-b-s.com](http://www.h-b-s.com)

For Music  
on CD  
call 800-759-4561

READER SERVICE NO. 50

## Affordable Custom Broadcast Furniture



32 Pennsylvania Avenue, Malvern, PA 19355

Delivered and  
installed by

**STUDIO  
TECHNOLOGY**

TEL: 610-640-1229  
FAX: 610-296-3402

email: [sales@studiotechology.com](mailto:sales@studiotechology.com)  
web: [www.studiotechology.com](http://www.studiotechology.com)

READER SERVICE NO. 103



## Econco REBUILT POWER TUBES



Approximately One Half  
the Cost of New

3,000 Hour Unconditional Guarantee

Call for Our Price List

Econco 1318 Commerce Ave. Woodland, CA 95695  
Phone: 530-662-7553 Fax: 530-666-7760 Telex: 176756  
Toll Free: 800-532-6626 From Canada: 800-848-8841

READER SERVICE NO. 23



**Silicon Valley  
POWER**  
AMPLIFIERS

The RF People

## FM Broadcast Power Amplifiers

Designed for reliability, durability, & efficiency.

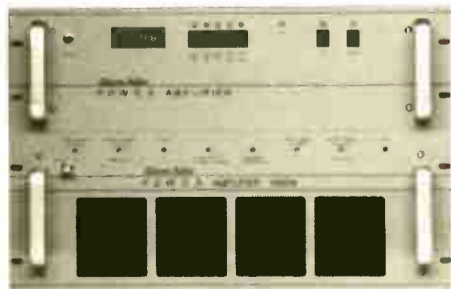

Models from 165 watts to 2.4 KW

Solid state. Frequency agile.  
VSWR foldback. Digital display.  
Remote operation. Easy installation.  
Full documentation. Modular construction.

1-800-986-9700

[www.svpa.com](http://www.svpa.com) e-mail: [sales@svpa.com](mailto:sales@svpa.com) Fax 1-408-986-1438

READER SERVICE NO. 76

## Tri-Maze Complete AM FM Processing Package



**Model TM4013  
Tri-Maze**

- 60 dB control range.
- Meets all NRSC requirements.
- Time domain contoured, integrated release.
- Easy access compression and mix controls.
- Dip switch selectable pre and de-emphasis, 75 or 150 uS.
- Mix down peak metering, permits precise yet simple setup.
- Triggered absolute level expansion, auto-mode for voice or music.
- Zero hysteresis post filter clipping, provides up to 2 dB loudness without center channel distortion products

Reliable, Quality Processing From:

**Broadcast Technology Company**

PO Box 751, Lamar, Colorado 81052 Phone: 719-336-3902

READER SERVICE NO. 129

# Bring Back Wacky DJ Stunts!

Alan R. Peterson

The debate rages on as to whether radio station automation is helping or hurting radio in general. It all depends on whether you speak with out-of-work jocks or the company comptroller.

I will not take sides in the debate for a number of reasons. On one hand, yeah, some jocks are unemployed and the ones that remain have heaps of responsibility piled on them. On the other hand, running an operation inexpensively under machine control has kept alive numerous AM and Docket 80-90 FM stations that could be called marginal at best and on life support at worst.

Besides, programming remains diverse and reasonably well-executed and there is still some well-known name in town we have listened to and trusted for at least a decade.

No, if there is one thing I bemoan about the state of computerized radio today, it is the near-extinction of the wacky DJ stunt.

## 'I have an idea ...'

Stations often could not go an entire week without some wild and highly visible stunt taking place. Weekends would bring out the entire morning show to take part in the dunk tank or the demolition derby at the local theme park.

April Fool's day events, whether real or created in the studio, never fail to get headlines. Jocks brand new to their market would do live appearances everywhere to drum up an audience.

Today, those jocks that are live still get out and have fun, but it seems as if it has become *predictable* fun. The



To-ga, to-ga ... The author in 1985, ready to welcome 'Animal House' band Otis Day and the Knights to WHMP-FM, Northampton, Mass.

transparent booth that blows money around inside. The living-on-a-billboard-for-a-week and the annual food drives. The Mystery Man in the white tuxedo that pays for groceries. We've

done it, we've heard it.

And if one more station does that "takes over another station in the market" gag (spoiler: it's always a gas station), then it may be possible that the machinery won.

Please understand I am all in favor of stunts and events that do good for the community. The food drops and blood drives are important, as are the drunk-driving demonstrations where the on-air jock gets tanked during a show under the watchful eyes of the law.

But whatever happened to the nut who swung by his knees from the chandelier in Macy's window, or rode a horse in the parade dressed (?) as Lady Godiva? Where is the newspaper person that swats the morning host with a pie when the circus is in town? The beefy sportscaster in a cameo ballet role, trotting across the stage in a production of Swan Lake? Has anything caught your attention since Mancow Muller got his haircut on the bridge and snarled traffic in San Francisco?

Surprises like this have always made radio fun for its listeners and special for its community. Small and medium-sized cities generally have no other "celebrities" to speak of, and frankly it is hard to get excited about a market's TV weathercaster being the closest they will get to someone famous.

## Err conservatively

I can understand the trepidation of today's owners going out and doing something wild and creative. Live stunts these days have a sad history of going bad.

Remember the cable that got cut on the live Howard Stern show feed from Ohio? How many times did the competition park their van across the street from your event to steal your thunder? How often have we

heard about twists on the "WKRP Turkey Drop" bringing out protesters? Permits, clearances, insurance — why bother, right?

And who has not grown weary of someone in the crowd yelling out the name or names of syndicated personalities competing with your station? It is reason enough to leave the van at home and "let the music do the talking" after all.

But even with the chance that somebody in the crowd will inevitably yell out "Frick and Frack Rule!", the best stunts for me have been the ones that put the listener right in the heart of the action. A live mic becomes necessary.

Some years back, I heard about a rock station in Boston that decided it was time to retire its old station van. Rather than sell it, donate it or otherwise retire it in a dignified manner, in the grandest rock-n-roll tradition they hauled the into the air by a crane and dropped it to the ground. Inside the van was an E-V 635 mic, capturing the moment of impact and airing it live.



The act of disposing an old vehicle became a listener event.

## The human Hershey bar

You want wild and wacky? The Westwood One duo of "Don and Mike" celebrated a past Valentine's Day by dipping themselves in molten chocolate and inviting listeners to break off pieces after it hardened. Unusual? Yes. Memorable? You bet, and great radio to boot.

You want service to the community? I heard where Doug "Grease Man" Tracht collected several thousand teddy bears for law enforcement officers to give to confused and frightened children at crime and accident scenes.

And visibility? It doesn't get much better than the CDs, calendars and giveaways associated with the syndicated "Bob and Tom" show, originating from WFBQ(FM), Indianapolis.

Look at the lists of radio stations that win NAB Crystal awards. Service to the community. Visibility. Dependability. A face that goes with the station. True, wild stunts don't win awards, but they still make a station visible and garner priceless publicity and awareness.

Tell me how you will get a computer to ride the float and wave to the crowds in the Memorial Day parade. Can a flat-screen monitor sky-dive out of an airplane and describe the journey to the

ground? It isn't a PC that ascends the stage to introduce the Rolling Stones — it's the wild and crazy morning talent that whips up the audience to expect a great show.

Successful radio operations know how to digitize and stay popular with listeners. This frequently means *not* rotating the same three or four voices around to all the stations under the same roof, and by utilizing the over-the-top talents most radio personalities were born with that made them enter the field to begin with. The overall personality of the station is uncompromised and leaves room for creativity.

I still enjoy turning on a radio and being entertained by something that is just flat-out fun — not necessarily angry, negative or provocative. A few more fun-loving folks ready to shave their heads on-air or smear themselves with strawberry jam and sprinkles to raise funds for the children's health clinic might be the recharge some stations need.

Wacky DJ stunts have been around as long as Top 40 radio itself, back when computers themselves weighed 20 tons and filled a gymnasium. Some things deserve to continue.

**Whatever happened to the nut who swung by his knees from the chandelier?**

## THE ONLY OFFICIAL DAILY NEWSPAPER OF NAB99!



The NAB99 Daily News

covers every

inch of the NAB99

convention, with two

issues on site daily,

morning and afternoon.

Inside you'll find daily convention news, product coverage, exhibit maps, exhibitor listings, late-breaking news, and more!

If it happens there, it'll be printed here.

Las Vegas

Produced by  
IMAS Publishing Group,  
the publisher of  
Radio World,  
TV Technology,  
Pro Audio Review,  
Pro Video Review,  
Broadcast & Production  
and more!

**Don't forget to pick up your copy!**

Advertising in the daily is the best way to turn attendees' attention to your products and your NAB exhibit.

Ad space reservation deadline: March 12

For more information, call your IMAS Publishing sales representative or 1-800-336-3045 x151

# Pop Quiz: 1941 Broadcast Terms

**Rich Rarey**

It is time to take inventory of what you know about broadcasting.

This quiz will cover common studio expressions, as found in this semester's text, the Handbook of Broadcasting by Waldo Abbot, second edition, tenth impression, copyright 1941.

Match each of the following expressions with the correct definition, from the list that follows. No peeking at the answers in the box at the end. Ready? Begin.

1. Audition
2. Blasting
3. Beard
4. Bug
5. Bug Juice
6. Cans
7. Build it up
8. Drooling (seldom used)
9. Feeding
10. Gobos
11. Hot Platter
12. In the Beam
13. Key Station
14. Jacks
15. Mike Hog
16. Mud, in the
17. Patch Cord
18. Production Director
19. Remote Control
20. Round Robin
21. Tag Line
22. Wrapping it Around the Peak

A. Carbon tetrachloride, which is used for cleaning the equipment and which usually corrects these intermittent troubles.

B. The delivery of a program over a telephone line, either to a network or to some other station.

C. A program which originates outside the studios of the station.

D. A record on which the music is very lively.

E. The telephone line that connects stations upon a network returning to the key station.

F. Intermittent trouble in the equipment which is not easily found.

G. The studio testing of talent for a presentation or of an applicant for a position. It generally consists of presenting material over a public-address system.

H. A line in the copy that must be "hit" or given emphasis. It may either be the gag that ends a short scene or the climax spoken before a musical transition.

I. The headphones that are used by the control operator.

J. Implies the filling in of time on a program by means of speech.

K. An actor or speaker who stands in the beam, preventing other speakers from getting right positions before the microphone.

L. The instruction given to the operator to increase the volume.

M. Screens for deadening or livening studios. One side of the screen is faced with folded monk's cloth backed with hair felt. The other side has a plain wooden facing. With several (of these) it is possible to vary the quality of the pickup, either by livening it or by deadening it.

N. An error made by an announcer, such as the announcer who was introducing the "Early Bookworm" program and his fluff resulted in his announcing "Burly Hookworm" program.

O. That territory where speech is most effectively picked up by the microphone.

P. The point of origination or the first station in the network.

Q. Means that if the speaker shouts, he will send the needle to the very top of the dial. This results in blasting.

R. An expression used to denote that the speaker's or actor's voice has an improper pitch and is picked up faintly so that he sounds as if he were bubbling through the mud.

S. The official who is responsible for the preparation of a program. He combines the work of the music director, dramatic director and the announcers into a single program, building and shaping the program by bringing all these factors into harmony.

T. The sockets into which the plugs of a patch cord are pushed.

U. Putting too much volume into the microphone. This formerly threw the equipment off the air, but now is taken care of by automatic methods.

V. An emergency hookup of electrical impulses, merely a short utility cord of insulated wires used in the control room.

Bonus Pronunciation Question: With which word does *what* rhyme — "dot" or "rut"?

How well did you do? Rate your score using this completely arbitrary scale:

0 to 5 correct: You might be new to broadcasting, or were born after man landed on the moon.

6 to 12 correct: Good test-taking skills, you toughed out the answers.

13 to 18 correct: Seasoned broadcaster, might be thinking about retirement or changing careers.

19 to 22 correct: You obviously have been around, and probably have owned or managed radio stations in your career.

The fun part of discovering books like these — this text was used in the 1951 speech class at the University of Wisconsin, Madison — is to note the redefinition of terms, and reflect on broadcasting "then and now."

This does not mean that "then" was better broadcasting, or that present-day broadcasters are superior, or that pondering the differences is some arcane acade-



mic exercise. But rather, this gives the modern reader some benchmark of how regulation, society, technology, big business, government, academia and even word pronunciations have evolved in the last 58 years.

When this book was published, there were 881 AM stations and 17 FM stations (in the old 42 to 50 kHz FM band). There also was excitement in a technology called "facsimile" which was viewed then as a potential adjunct to audio broadcasts, much as RDS is today.

The handbook believes that, "There has always been considerable glamour (sic) attached to radio, and this fact largely explains the interest that so many people have in it as a possible vocation. Furthermore, broadcasting offers a career that is not seasonal, for the station operates upon a nearly full schedule, summer and winter."

It seems too, there is money in this business. The handbook lists the network average announcer salary as \$65.54 per week. Network writers fared much better, earning up to \$1,250 per week, depending on his or her serial scripts.

The last section of the Radio as a Vocation chapter, "Women In Radio," illustrates the changes since 1941.

See QUIZ, page 44 ►

## If your car radio sounds like this...

Why should webcasting sound like this?

Bring OPTIMOD sound to your webcast with Orban's new **OPTIMOD-DAB 6200**. Customize the processing for any sample rate while creating a loud, clean, punchy sound that stands out over the internet. The 6200 ensures maximum fidelity by minimizing stress on your server's perceptual encoder (an essential component in all webcasting software). OPTIMOD-DAB makes your webcast sound like major-market radio and keeps users logging onto your site.

For details, visit:

[www.orban.com](http://www.orban.com)

**You can measure...**  
with the best monitor and the most accurate test set.

The FMM-2/FMS-2 series monitors provide an even greater degree of precision measurement than ever before... You can measure S/N below 90 dB, You can measure crosstalk below 85 dB, You can measure separations of better than 70 dB, You can measure frequency response to better than 0.25 dB, You can measure distortions to lower than 0.01%, and much more... Our uncluttered panels and autoranging voltmeters make these measurements a dream.

**BELAR** (610) 687-5550  
**ELECTRONICS LABORATORY, INC.**  
LANCASTER AVENUE AT DORSET, DEVON, PENNSYLVANIA 19333  
Call or write for more information on Belar AM, FM, Stereo, SCA and TV monitors.

# MR-30 Otari MD Entry

► OTARI, continued from page 37

The MD format has followed as interesting a political path as that of the DAT format. In the consumer market, it was Sony's second attempt to rid the world of cassettes. But high costs and a Ross Perot-like late entry into the competition — along with the launch of the Digital Compact Cassette — added to the consumer confusion on which candidate to choose.

Subsequently, MD has caught its second wind as a consumer format, but it has also found a home in radio facilities across the globe. Today, both engineers and programming professionals are seeking a viable alternative to analog cart decks — making the MD format both a fast and easy replacement during that six-station, one-production director consolidation.

## Opening the box

The Otari MR-30 came packaged tight, smelled like a new car and came out rack-ready with the ears already attached.

At first glance, I got the impression I was looking at the Denon DN-M1050R MiniDisc Recorder. The placement and size of just about everything on the face of both units are quite similar.

It is satisfying to see large-style Play, Stop and Record buttons showing up on all the latest inventions. From a programming and operational standpoint, this cosmetic feature is essential for broadcast applications: push *here* to start, push *here* to record.

The simplicity of a new product is very important, especially when a company is looking to gain popularity in radio stations abroad. Shock value needs to be at a minimal level for jocks, and the MR-30 is as easy as it gets.

My installation was uneventful, more or less a few plugs here and there — deciding whether to use XLR-type or RCA pin-type connectors for the analog signal and SP/DIF or AES/EBU for the digital signal.

As with any piece of gear, it is obviously important to have options, and the Otari engineers again get high marks for making my hook up stupid-proof.

The MR-30 features stereo I/O with sampling frequencies of 32, 44.1 and 48 kHz.

Each MD holds the standard 74 minutes of stereo audio or 148 minutes of monaural.

Recording is effortless. Insert the MD into the unit as if putting a floppy disk into a computer drive. To record, press the Record and Play/Pause buttons. Check the recording levels and press the Play/Pause button again to begin.

## Auto-record

What I like about the MR-30 is the ability to record automatically by using the recording start function.

This feature senses the audio-input level and initiates recording once a pre-programmed threshold has been reached. This threshold can easily be changed to a desired setting. Track numbers can also be automatically incremented by sensing dead-roll sections within your recording. Can you see why this is replacing analog cart decks in a lot of stations? Yep.

Editing functions within most MD players work like the Undo option found in word processing programs. The concept is parallel in the Otari MR-30. Set the Undo mode by holding the Edit button for about 3 seconds. Turn the Select Knob and select Undo. You now have three options: Undo, Redo and First.

Undo undoes the last editing operation. Redo resets the editing originally undone with the Undo function. First returns to the top, undoing all the editing options.

In the Edit mode, it is just as easy to find the track you would like erased, drop A-B markers and hit the Erase button. You can also move, combine, divide and erase all tracks depending on your preference.

Considering some short-term automation? Program playback can specify playback order of up to 25 tracks. Either single- or continuous- mode can be selected — even if main power to the box is lost. Also, the signal level for detecting the precise audio can be adjusted and changed at anytime.

If you are pretty handy with a DAT deck, you will find MD no great challenge, especially when using the shuttle/jog-wheel.

"But I love my DAT player," you say. Understandable, as the format is great for

archiving. But does your DAT player come with varispeed control ( $\pm 9.9$  percent)? Will it give you an instant, accurate cue for a tight playback? Can you name your cuts with a spin of the happy-wheel? These are just some of the reasons for the rise in popularity of MiniDisc in the broadcasting realm.

For example, when recording with the pitch control in use, you can actually set and store that certain speed to disc, so that it will always play at that pitch. Or say you have a cue signal you would prefer to erase. No problem: hop into Edit mode again by pressing the Edit key. The MR-30 guides you along via with display prompts such as, "Cue Erase?", "A-B Erase?", "Track Erase?" and "All Erase?".

Another bonus with the MR-30 would have to be its keyboard compatibility. This Otari deck will work with any IBM PS/2-type keyboard with a 6-pin mini-DIN plug. One simple plug-in to the MR-30 and you can now hit F3 to play and

pause, F4 for standby and cue, F5 to stop, F6 to record, and so on. Practically everything on the entire keyboard gets used — even the numerical keypad goes to work as pitch controls.

## Seal of approval

The Otari MR-30 is a superb MD recording unit. News formats will love to use this one to play back and store reports and actualities. Morning shows will need to flip a coin between MD or something like the 360 Systems Short/Cut. Production directors may give up their cart decks for good.

Otari is at 378 Vintage Park Dr., Foster City, CA 94404. Contact the company at [www.otari.com](http://www.otari.com) or at the phone number given in the product capsule.

■■■

*Flip Michaels is director of multimedia development and DTV express coordinator for WITF-FM/TV in Harrisburg Pa. He also manages FM Productions, a free-lance jingle production company.*

# Pop Quiz, 1941-Style

► QUIZ, continued from page 43

Abbot wrote, "The small number of women announcers is to some extent due to the fact that they are not physically able to endure the long hours of work."

However, many women would enter this type of work were it not for the prejudice the public has against women announcers."

Abbot wryly apologizes in his preface to the first edition.

"Possibly these 11 years of introducing educational programs have eliminated any tendency upon my part to be frivolous," the preface read. "I have read a talk for an absent speaker on 'How It Feels to Be a Mother.' I have taken the part of a moral degenerate in an interview with a psychiatrist. I have stood ready to read a dignified introduction of a former president of the University, who was publicly interested in birth control, only to hear the student orchestra, which preceded him, unwittingly

blare forth the selection 'Whose Baby Are You?'

"I have struggled to introduce in a conversational style the Curator of Lepidoptera of the Insect Division of the Museum of Zoology, and the Curator of Phanerogams of Basidiomycetes of the University Herbarium. I hope that the students who plod through this book will understand my resultant seriousness."

Until next time, I remain, Your ob'd't eng'r

■■■

*Rich Rarey is managing editor of EUOnline, the NPR online engineering resource. He can be reached at [rrarey@npr.org](mailto:rrarey@npr.org).*

## ANSWERS:

1-G; 2-U; 3-N; 4-F; 5-A; 6-I; 7-L; 8-J; 9-B; 10-M; 11-D; 12-O; 13-P; 14-T; 15-K; 16-R; 17-V; 18-S; 19-C; 20-E; 21-H; 22-Q.

"What" rhymes with "dot." Really.

**ALTRONIC RESEARCH INC.**  
Performance By Design



**MANUFACTURER  
OF RF COAXIAL LOAD RESISTORS.**

**DUMMY LOADS FROM 1 KW TO 1500KW,  
AVAILABLE IN AIR, WATER OR SELF  
CONTAINED HEAT EXCHANGERS.**

**HIGH POWER NON-REACTIVE CERMET  
RESISTORS FROM 1 OHM TO 20 MEGOHMS.**



**ALTRONIC RESEARCH INC.**

P.O. Box 249 • Yellville, Arkansas 72687 870-449-4093 • Fax: 870-449-6000  
E-mail: [altronic@mtnhome.com](mailto:altronic@mtnhome.com) Web Site: <http://www.altronic.com>

# MP3 Compression Takes 'Pressure' off Delivery

► MP3, continued from page 37

The Telos Audioactive format is MP3, the high-grade compression algorithm we are hearing so much about right now. I was intrigued and excited. The Webmasters at Smoky Mountain Internet Services in Franklin, N.C., finished designing our Web page and integrated an audio locker into it: a password-protected area for client's audio files. The MP3 system provides for a compression ratio that is fully compatible with other digital devices like a workstation, or on-air hard drive.

With Audioactive MP3 I can send a stereo promo and several liners — approximately 2 minutes of audio — in a file only a little larger than 3 MB. This same file in WAV format would be greater than 18 MB. Similar ratios and greater space-savings are possible by adjusting the sample rate and choosing either a mono or stereo file.

The result is a fully produced stereo promo and six sweepers shipped flawlessly in less than 20 minutes total download time at 56 kbps.

For the purposes of this article I will not go into the specific technical aspects of how MP3 works. However, I have come up with a combination of hardware and software that works well for us.

We use a plain vanilla Intel 233 MHz Pentium machine with 64 MB RAM and a 1.9 GB hard drive. A Digital Audio Labs CardD Plus audio card and

56k/V.90 internal modem round out the hardware. We connect to a standard POTS phone line.

All of our multitrack production is done on the Spectral Studio Tracks XP V3.03 workstation, then mastered to DAT and to the CoolEdit 96 two-track digital editor. The DAT contains an archived master of the production, while CoolEdit gives us a working WAV master.

In the same computer is the Telos Audioactive Production Studio Pro. This program converts the huge WAV files into MP3 files for transfer to radio stations or ad agencies over the Internet.

The program has various sampling rates and bit rates. We like the 48 kHz/256 kbps setting best for stereo CD quality, but have found that 48 kHz/64 kbps works fine for mono voice track transfers and is much faster to upload.

## Kickback

MP3 files can be e-mailed to individual station's accounts, but this plan has a flaw. An e-mail server close to capacity will kick our file back to us, so I like to upload the files to the audio locker on my Web site using the FTP client program "CuteFTP." It asks the right questions as to where I want the file to go, connects me to my site, then uploads the file and updates the menu.

There are other fine products on the market, including shareware MP3

codecs and numerous audio editors, but we have found these to be most useful in uploading and downloading MP3 files over the Internet.

For less than \$200, our studio was Internet-ready audio transfer.

The Telos Systems Audioactive Production Studio is available in both Pro and Lite versions. Both work well, but Pro has more sample/bit rate options. You can download an evaluation copy of the Lite version for free, but it is well worth the \$59 asking price for this encoder. The Pro version lists at \$369. Find this program and the free player at [www.audioactive.com](http://www.audioactive.com)

Few production people have not heard of Cool Edit from Syntrillium Software. Cool Edit 96 is also available online at \$25 for the "Lite" version and \$50 for the full version that includes compression,

noise gates, special effects, echo and reverb and more. Scare up a demo at [www.syntrillium.com](http://www.syntrillium.com)

CuteFTP is our FTP client of choice. It has instructions that are straightforward enough, although you may want to sit with your Web designer or service provider to get acquainted with the procedure of uploading your files. This package can be had for \$34.95 at [www.miningco.com](http://www.miningco.com)

■■■

Jeff Laurence and his wife Carol own Jeff Laurence Audio Productions and Autumn Hill Studios in Otto, N.C., providing production to numerous radio stations. He also hosts a Saturday night show on WSB-FM, Atlanta, via Telos Zephyr from his mountain studio. Reach him at [jeff@jefflaurence.com](mailto:jeff@jefflaurence.com)

## What Broadcasters Are Saying About MP3 Audio

**Bob Walker, operations director at KLCA(FM), Reno, Nev.**

"The MP3 audio is like having an ISDN line without having to get your boss to fork over the bucks. I will fax a script to Jeff, and sometimes the audio is posted in his audio locker before I even get into the studio to produce.

"All of our production rooms are networked so I can produce in any open studio. The audio is CD quality, and you can use any browser to download. Even over AOL.

"The MP3 Audioactive system has allowed me to have quality production on the air almost immediately."

**Ron Anthony, program director, WINC/WAPP, Winchester, Va.**

"Our stations are unique in the market, and for 92.5 WINC-FM we use Jeff Laurence as our primary station image voice. With the MP3 file transfer, I send the script and he either sends me an e-mail attachment, or I have our imaging producer — who is more than two hours away — pick up the voice tracks directly from Jeff's Web site, produce the piece, and send me the finished product again via MP3.

"We get superior quality and equally superior turnaround time. This will be standard equipment in the production rooms of the next millennium."



Ray Anthony of WINC/WAPP, Winchester, Va.

## MP3: What It Means

Do a Web search for "MP3" and you will find countless sites filled with music, sound effects and famous historical speeches, but very little in terms of what it actually is.

Contrary to assumptions, MP3 is shorthand for *MPEG Layer-3* and not *MPEG-3*. According to the Moving Picture Experts Group (from which the acronym MPEG is derived), there is no actual defined standard called "MPEG-3." An *MPEG Layer-3* file, however, is defined within the audio section of existing MPEG standards.

The *MPEG-2 Layer-3* (MP3) coding most users are familiar with has roots in the algorithm developed by Fraunhofer Gesellschaft Laboratory of Germany. The company's MP3 encoder is licensed to Telos Systems for its Audioactive Production Studio.

### Layers

What do layers have to do with it? Each one represents a successively higher level of performance and complexity. From Layer-1 to Layer-3, both the encoder number-crunching and sound quality-per-bit rate increase. The layers also follow a hierarchy: A Layer-3 decoder can decompress all layers below it, whereas a Layer-2 decoder can only handle Layer-2 and Layer-1.

MP3 files are currently popular with Web users because they easily decompress into decent quality audio. *MPEG Layer-3* performs at "FM quality" at low bit rates of 64 kbps per audio channel or lower. At bit rates of 112 to

128 kbps for a stereo signal — a 1:10 to 1:12 reduction ratio — an MP3 file can maintain CD sound quality. A 60 MB WAV file can become a 5 MB MP3 file after conversion.

Higher reduction ratios result in more limited bandwidth. It is possible to compress a file 96:1 using an 8 kbps bit rate, but the result is a 2.5 kHz signal, considered telephonic in quality.

### The next step

So what is next? Pay attention to *MPEG-4*, released at the end of 1998 and intended as a universal language across broadcast, movie and multimedia applications.

Where previous MPEG standards addressed only compression, the *MPEG-4* coder comes with a well-stocked toolbox including parametric audio coding, synthetic audio, speech coding and subband/transform coding.

The process remains a works in progress. Following the release of Version 1, work on Version 2 is continuing. Technology to be added in the next incarnation of *MPEG-4* will be error resilience, 3-D spatialization and low-delay audio coding. The *MPEG-4* Version 2 Standard should become available one year after Version 1.

More technical information can be found at [www.audioactive.com/intro/papers/backbone.html](http://www.audioactive.com/intro/papers/backbone.html) and at the Fraunhofer IIS Web site [www.iis.fhg.de/amm/techinf/layer3/index.html](http://www.iis.fhg.de/amm/techinf/layer3/index.html)

— Alan R. Peterson



- Full featured, low cost remote transmitter control
- New Accessory! Model PA-1 Parallel Printer Adapter
- New Accessory! Model MA-1 Modem Adapter
- Watch for the new RAK-1 'Intelligent Rack Adapter'!
- Y2K compliant -- visit our web site for details

Why spend more than you have to?

 Sine Systems, inc.

615 • 228 • 3500 (vox)  
615 • 227 • 2367 (fax)  
615 • 227 • 2393 (f.o.d)  
[www.sinesystems.com](http://www.sinesystems.com)

# Products & Services Showcase

For more information on the products shown below, circle the appropriate Reader Service No.(s) on the enclosed Subscription/Reader Service card or contact the advertiser directly.

**Excalibur Electronics**  
**CDA-1**  
Composite Distribution Amplifier



This 1 in, 3 out distribution amplifier allows you to distribute stereo composite and/or subcarrier signals as easily as audio.

- DC-100 kHz frequency response
- 90 dB signal/noise ratio
- +6 dB to -20 dB gain range
- Individual 20-turn output trimmers
- 1 1/4" rack mount enclosure

EXCALIBUR ELECTRONICS, INC., CHANTILLY, VIRGINIA  
Please circle our bingo number for a data sheet and a dealer list.

**READER SERVICE NO. 49**

*Match-Maker™*      *Disc-Patcher™*



**IHF ↔ PRO**  
Level and Impedance Converters

**BI-DIRECTIONAL FOR**

- Reel to Reel and Cassette Recorders
- Graphic Equalizers and Noise Reducers
- Audio Effects Processors and Digital Reverb
- Dual Line Amp, DA, Splitter or Combiner

**UNI-DIRECTIONAL FOR**

- Digital Compact Disc Players
- ENG Cassette Dubbing
- Off-Air Monitor Tuners
- Console Audition Outputs

Interface consumer/industrial IHF (-10db) stereo source equipment and signal processing devices into professional studio +4dBm, 600 ohm systems without loading distortion, crosstalk, hum, response roll-off or RF pick-up.

True transformer output isolation, balance and protection with less than .01% THD even at 20Hz and +22dBm peak output!  
102 db dynamic range...greater than a Compact Disc system!  
Self contained power supply, Velcro™ and dual rack mounting.  
Free Detailed Brochure and Specifications Available

**AUDIO TECHNOLOGIES INCORPORATED** **ATI**  
328 Maple Avenue, Horsham, PA 19044, USA  
(215) 443-0330      FAX (215) 443-0394  
<http://www.atiguys.com>

**READER SERVICE NO. 102**

From the "Specialists in Practical Precision Engineering"™



Anywhere you need

- ✓ Unparalleled Audio Performance
- ✓ Stereo Balanced/Unbalanced Conversion
- ✓ Connectorized Audio Interface
- ✓ Balanced Connections Available on Rear
- ✓ Bi-Directional Audio Interface
- ✓ Gain Adjustments for Both Directions

You Need:      RU-LA2D

**RDL**      Toll free (800) 281-2683  
Radio Design Labs      Local (805) 684-5415  
Document Server (800) 391-0017  
Web Page [www.rdl.net](http://www.rdl.net)

**READER SERVICE NO. 75**

**Fits In Even "STINGY" Budgets!**



The **HOT NEW "DELUX"** quality built **SPACEWISE** system!  
BASIC SYSTEM \$1555!  
FULL SYSTEM \$3195!

**HOME OF VOLUME VALUE PRICING**

**GENERAL FEATURES:** Basic system consists of main counter top and two PC system pedestals ... then you add on what you need from there, such as racks and shelf wings or talk table wings for a full system.

**USER FEATURES:** Two PC system base pedestals ... heavy rack rail systems with easy access standard ... passive ventilation systems throughout ... adjustable shelves ... wiring block backplane ... customizing ... quick installation.

**DURABILITY BUILT IN:** Top counters are two ply 1 1/2" thick with quality name brand laminate with protective 1 1/2" solid wood trim raised on the outside perimeters. Plus ... generous vertical and horizontal solid wood trim and recessed kickboards.

**SPACEWISE® Broadcast/Furniture**  
CALL 800-775-3660  
Visit our web catalog: [www.spacewise.com](http://www.spacewise.com)  
"The Broadcasters Furniture Store"

**READER SERVICE NO. 22**

**PSI**  $\Psi$   
QUALITY ANTENNAS AT AFFORDABLE PRICES



**FM BROADCAST ANTENNAS**

- » Power Levels from 500W to 50 kW
- » Multi Station Antennas
- » Circular or Vertical Polarization
- » Directional Antennas

.....PROPAGATION SYSTEMS, INC.....  
719 Pensacola Road  
Ebensburg, PA 15931 USA  
814-472-5540 Fax 814-472-5676  
E-mail: [psiba@surfshop.net](mailto:psiba@surfshop.net)

**READER SERVICE NO. 48**

Your best source of quality rebuilt transmitter tubes since 1940





**Freeland Products, Inc.**  
75412 Highway 25  
Covington, Louisiana 70435 U.S.A.  
1-800-624-7626  
(504) 893-1243 FAX (504) 892-7323  
[www.freeland-inc.com](http://www.freeland-inc.com)  
Email [freeland-inc.com@freeland-inc.com](mailto:freeland-inc.com@freeland-inc.com)

**READER SERVICE NO. 74**

**The Perfect Digital Console Interface**

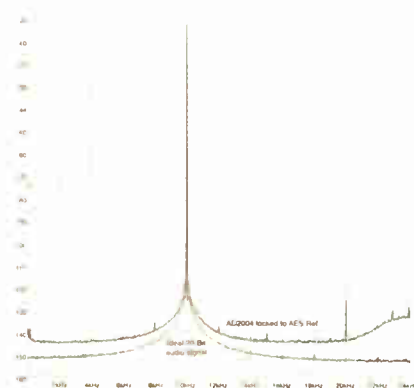
The AD2004 A-to-D converter is the cleanest, quietest, most neutral sounding converter available! It was designed for the 20-bit multichannel user who insists on the very finest performance. This device introduces ground breaking improvements in A to D conversion. Analog preprocessing significantly reduces distortion products, while a custom phase lock loop IC all but eliminates jitter induced sidebands, under all operating conditions. The graph shows an FFT analysis with virtually no jitter induced sidebands. Best of all, the AD2004 comes in at the most affordable price of \$2200 for four channels. And now the eight channel AD2008, housed in a full width 1 RU chassis, is available for \$3950. Protect your investment: get next generation performance today with the BENCHMARK converter series. Call Rory Rall today!

Now recording at: The San Francisco Symphony, Telarc Records, Encore Recording, and other notable facilities.

**BENCHMARK MEDIA SYSTEMS, INC.**  
800-262-4675, 315-437-6300, <http://www.benchmarkmedia.com>

**READER SERVICE NO. 101**

# Buyer's Guide

Putting  
Intelligent  
Monitoring to  
Work  
Page 49

Radio World

Test, Monitoring, Remote Control

February 17, 1999

## SPECIAL REPORT

# Many Options for Quality Test Equipment

Bob Shotwell

When considering the range of prices, options and sophistication of test equipment available to broadcast engineers, this is both the best and worst of times.

continues to shrink. It goes without saying that the best equipment made is but a depreciating asset on a ledger sheet without a trained, qualified and experienced engineer attached to it. More on this later.

being recorded or stored on Hard, Jaz and Zip drives, MiniDiscs, CD-Rs and DATs. An analog STL is now but one of many choices. Shall we go compressed or non-compressed digital, spread spectrum or T1?

Broadcast Labs. used to advise, "Repeat after me: 'Our Father ...'"

### The future is now

Fortunately, what the engineer needs to test and maintain this equipment is readily available.

Audio Precision, a manufacturer of high-end digital and analog test equipment, recently introduced the System Two audio analyzer, a marvel in ruggedness, portability and capability. It's available as analog-only with or without DSP enhancement, or the digital-only System Two Dual Domain.

At the transmitter end, you may find a fully digital or digitally controlled modulation processor and an exciter with a choice of composite or AES/EBU input. Even the AC power meter has a digital readout. It would seem only the actual modulating method is lagging behind ... for now! So if you're poorly equipped to trouble-shoot, what do you do when something goes wrong? As a good friend, mentor and well-known industry figure, Bill Bingham, founder of Northeast

Of the latter, Tom Mintner, director of sales and marketing for Audio Precision, said, "To my knowledge, this

See TESTING, page 53 ▶



The Harris Audio Bit Buddy can trace and monitor a digital signal.

From my experiences, what we can obtain in the line of test equipment not only gets better and better, but in actual dollars — adjusted for inflation, as some might put it — becomes less and less expensive.

However, the pool of broadcast engineering talent available to the industry

Although the prospects of a terrestrial digital broadcast standard are getting closer to reality — maybe another year or so — the infiltration of digital audio products in the overall broadcast plant cannot be escaped. It is now more the norm than the exception to find audio

## USER REPORT

# Reduce Costs With The Davicom MAC

by John McCloy  
Technical Installer/Designer  
Dundas, Ontario, Canada

Recently, I encountered the niftiest remote system I have worked with to date: the Davicom MAC remote control system. It costs much less than similarly featured systems I have seen or installed, and has features that go well beyond the competition.

I have installed radio and TV transmitter plant control systems in Canada for approximately 15 years. Most of my contracts have been in new facilities installed by Gus Sondermeyer of Broadcast Technical Services. Two years ago, Bob Burger of Caveco showed me a product he was recommending to a local broadcaster for their network expansion. By coincidence, they chose me for the installation.

Until the MAC came along, the "remote" part of the package had always required various relays, optoisolators, diode busses and the like to

build up a completely functional plant. This always added to my installation cost. With the MAC, I have been able to assemble complete systems with a bare minimum of support circuitry and provide better automation at a substantially reduced cost to my customers.

### Hardware information

The hardware for the MAC system can be purchased in four different sizes: there are one to four I/O cards in each system. Each card has eight differential analog inputs, 16 opto-isolated digital (or status) inputs, 16 dry relay contact outputs, four RS232 serial inputs and four audio-monitoring inputs

An external rack-mount 12 V power supply runs the MAC. I always specify the optional lead-acid backup battery — standard in the U.S. — for up to an hour of runtime on a completely cold site. I use a KHU-type relay in conjunction with three of the output relays, to exercise the battery

See DAVICOM, page 52 ▶

## Affordable Digital Automation

24 HOUR  
FREE  
TECH SUPPORT

NEW

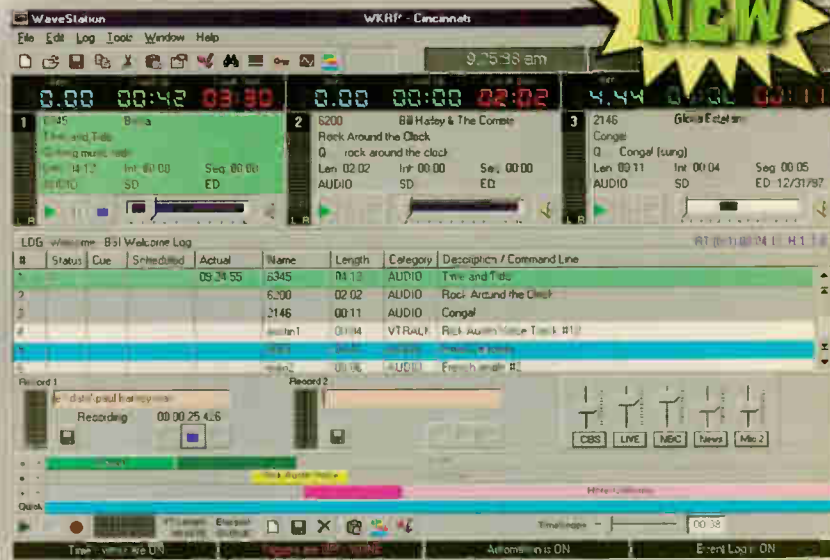

Our new WaveStation 3.0 has all the features of the \$50,000 automation systems, but is priced reasonably like software, not gold-plated broadcast hardware. We often hear, "It can't be true!" More than 1000 satisfied users worldwide prove the contrary. WaveStation includes a powerful digital audio editor and uses standard or compressed audio files, including MP3. On-screen Voice-Track editing, time-shift recording, serial port control. WebCast ready. Full automation, satellite, voice track and live assist. No recurring fees, Free upgrades. Microsoft Windows 95, 98 or NT.

888-BSIUSA1

Only

\$999

Try Before You Buy

Download the Actual Software!

www.bsiusa.com

BSI

## USER REPORT

# DSP-Based SCA Monitor From Belar

by Dennis J. Martin  
Chief Engineer  
KZLA-FM  
Los Angeles

The Belar SCMA-1, the newest member of the Wizard System family, is the first FM SCA Modulation Analyzer of its type because it is DSP-based. As a result, setup and operation are menu-driven, yielding a new level of flexibility.

A DSP design is inherently stable; there are no adjustments internal to the SCMA-1, and temperature variations and component aging do not affect its performance.

The SCMA-1 requires a low-distortion composite signal of 1.0 to 2.0 VRMS (2.8 to 5.7 V peak to peak), which it digitizes to decode the selected subcarriers within a range of 41 to 100 kHz in 0.5 kHz increments. The unit can be programmed to monitor up to five different subcarriers, including RBDS and Cue Paging injection.

In all, it measures Total, Main (L+R) and Subcarrier Peak modulation in percent and RMS level in dB, and subcarrier injection in percent. Like all Wizard family devices, it can be interrogated remotely using supplied PC software.

The SCMA-1 front panel is uncluttered, with a three-digit display that indicates modulation to 150 percent, a 16-character alphanumeric Menu/Parameter window, and Carrier and Peak LED indicators. Up/Down Menu and Parameter buttons allow you to select which function you need to program or monitor.

## Subcarrier setup

Programming a subcarrier is simple: You first select one of five SCAs, switch the bandpass filter (BPF) to In or Out (normally it is set to In), adjust the BPF center frequency and select its band-

width, choose the modulation type (FM or RBDS), set the detector response (flat, 75, or 150 microseconds), pick the detector bandwidth and calibrate the deviation sensitivity. This process is repeated for each subcarrier you intend to monitor.

The BPF can be set from 1 to 16 kHz in 1 kHz steps. Normally this filter is set to 16 kHz for flattest frequency response and lowest distortion, but it can be narrowed as necessary to reduce interference and noise.



The SCMA-1 is the most recent addition to the Belar Wizard family.

Detector bandwidth adjusts the cutoff frequency of a low-pass filter (LPF) applied to the demodulated signal; it can be programmed from 1 to 8 kHz in 1 kHz steps. It is usually set to 8 kHz for wide bandwidth music subcarriers — like the BPF, it too affects frequency response. An LPF setting of 3 or 4 kHz is appropriate for narrowband voice and data, which will improve the signal-to-noise ratio.

Deviation sensitivity calibrates the subcarrier's 100-percent modulation indication. Any deviation from 1 to 7 kHz, in 0.1 kHz increments, can be selected to indicate 100 percent. Calibration of the monitor is checked using an internal 67 kHz FM subcarrier that is deviated 6 kHz by a 1 kHz signal, and injected at a level of 10.0 percent.

## Monitor outputs

The Belar SCMA-1 provides six audio outputs: main L+R and subcarrier audio on separate XLRs at +10 dBm, main and subcarrier test on two BNC terminals at 5 VRMS, and scope (2.5 VRMS auto-ranged) and subcarrier BPF outputs (0.1414 VRMS at 10.0 percent), both on BNC connectors. The

XLR outputs are transformerless and true balanced outputs at 600 ohms. The BNCs are unbalanced at 75 ohms. Contact closures and open collector outputs of carrier presence and modulation peaks are included, as is a remote meter output.

Operationally, its specifications are impressive: main L+R frequency response is  $\pm 0.1$  dB, THD+N is 0.01 percent and the S/N ratio is 80 dB — all in a 20 Hz to 15 kHz bandwidth. Crosstalk — sub to main, main to sub, and stereo to

sub — are all 80 dB.

Demodulated FM subcarrier response is +0.1, -1.75 dB BPF In, and  $\pm 0.1$  dB BPF Out, 20 Hz to 8 kHz, 6 kHz deviation; THD+N at 1 kHz, 6 kHz deviation, 150 microsecond de-emphasized is 0.25 percent BPF In and an extremely low 0.05 percent BPF Out. The signal-to-noise ratio using 150 microsecond de-emphasis is 80 dB. These specifications are based on a BPF bandwidth of 16 kHz and a detec-

tor bandwidth of 8 kHz. We found the unit to be quite intuitive, even considering its level of sophistication, so installation and setup were quick. Because subcarrier frequencies are synthesized from a common system clock, we did not have to install different crystals for the various subcarriers we check. Overall, it has simplified our monitoring and substantially increased its precision.

The unit has certainly distinguished itself during the past several months, but there is one feature that might be changed. Since we use only three of the five possible subcarriers, we would like to flag subcarriers four and five in setup so they do not display in the Menu/Parameter window during operation. Although they can be programmed to duplicate other subcarriers in use, our preference is to have them disappear until needed.

In a single-rack-unit package, the Belar SCMA-1 FM SCA Modulation Analyzer allows us to measure virtually any subcarrier using the analysis power and precision of DSP technology.

For more information from Belar contact Arno Meyer at (610) 687-5550; fax (610) 687-2686 or circle Reader Service 36.

## USER REPORT

## TCI Enjoys A Slice Of the PIE

by David Swan  
Business Development  
Manager  
TV and Radio Systems, TCI  
Sunnyvale, Calif.

Transmitters are not normally operated as stand alone devices. Provisions must be made for processing the audio signal to permit the highest modulation level of which the transmitter is capable without undesirable side effects. Achieving this effectively extends the range of the broadcast service by maintaining maximum peak level, and therefore, loudness without distortion.

Other items of equipment must be provided to enable the incoming and radiated signals to be monitored both visually and aurally. Another important requirement: Transmitter modulation levels must be measured continuously.

Finally, test equipment must be incorporated to enable measurements to be made of the overall system for general maintenance and emergency troubleshooting purposes.

Efficiently processing, modulating and testing the audio signal both pre- and post-transmission is the basic purpose of the PIE (Program Input Equipment) system from Broadcast Richmond (BR). Additionally, the PIE system facilitates immediate emergency audio bypass of a problem point



The PIE From Broadcast Richmond

and then audio re-insertion after the identified problem. This latter function can put your station back on the air in seconds rather than hours.

See PIE, page 50 ▶

## Telephone Line "Eliminator"

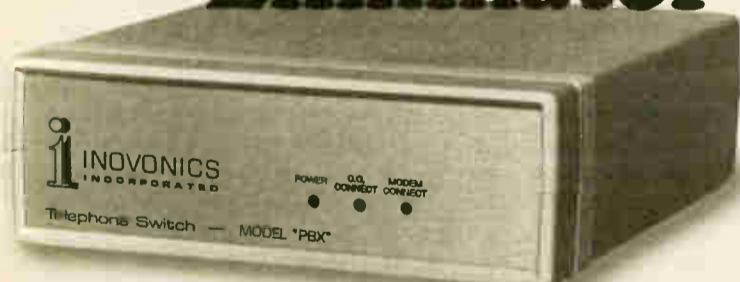

### 7 DIAL-UP DEVICES CAN SHARE ONE CENTRAL-OFFICE LINE

Inovonics' PBX is a cost-saving alternative to the multiple telephone lines otherwise needed for modems, alarms and other dial-up apparatus installed at remote equipment sites. The PBX allows as many as seven devices to share a single central-office line, for outgoing calls and with selective incoming access as well.

The PBX finds immediate application with the expanding use of unattended remote equipment:

- Broadcast Transmitters/Translators
- Cellular/2-Way Radio Facilities
- Microwave Relays
- Geophysical Monitors
- Pumping Stations
- Security Systems

PBX  
\$420

**Inovonics, Inc.**

1305 Fair Ave., Santa Cruz, CA 95060 USA  
TEL: (408) 458-0552 • FAX: (408) 458-0554

www.inovon.com





SPECIAL REPORT

# Sophisticated Control In St. Louis Complex

Jeff Detweiler

Broadcasters know QEI Corp. as a manufacturer of both high- and low-power solid-state and single-tube transmitters. But many are not aware that the company was the first manufacturer to offer an integrated microprocessor remote control in its transmitters back in the early 1980s.

A lot has changed since then. We have learned to live with computers controlling virtually every part of our lives, and certainly, transmission sites have not emerged untouched by this technology.

In recent years, QEI produced mobile and transportable RF transmission systems that include, as an option, an intelligent monitoring and control system. This system was originally developed for industrial, scientific and medical (ISM) applications of its transmission products.

The monitoring and control system is capable of making high-speed calculations on multiple RF output port loads and then addressing these changes by matching the output tuning to the changing condition. It was obvious to the QEI systems engineers that there was a broadcast application for this technology in sophisticated transmission system control and monitoring.

### System replacement

QEI recently was awarded a contract to apply this technology to replace an existing monitor system for an eight-station combiner and antenna in St. Louis. With more than 2 megawatts of instantaneous peak input power into the antenna, speed and accuracy of control are paramount.

The system design specification calls for continuous monitoring of each station's forward power and calculated VSWR into the combiner module. Furthermore, the system must maintain watch over antenna forward power, antenna VSWR, patch-panel interlock status and nitrogen flow rate. This must all be accomplished in real time using a graphical interface to visually depict the status of the event, sending appropriate alarms and taking corrective action.

Additionally, the monitor and control system must log data for each station, combiner and antenna at the occurrence of a critical change in status.

In the event of combiner or antenna component failure, the QEI monitor and control system applies priorities to algorithms for controlling the transmitter modes of operation. The following conditions could be monitored and addressed (see diagram for display):

Priority 1: In the event top or bottom half of the antenna VSWR exceeds 1.3:1, a warning relay is closed to alert the stations. As VSWR reaches the critical set point of 1.5:1, all stations are taken off air for five seconds. The monitoring system is then automatically reconfigured to trip on reflected power and the transmitters are brought back on the air at half power. The

system then waits 30 seconds for the transmitters to stabilize and sets a new algorithm for reflected power and maximum forward power. In the event they exceed these parameters, all stations are shut down.

Priority 2: If a station combiner module input VSWR exceeds 1.3:1, a warning relay is closed to the station. At 1.5:1 VSWR, the system will take the station-using module off the air.

See QEI, page 50 ▶

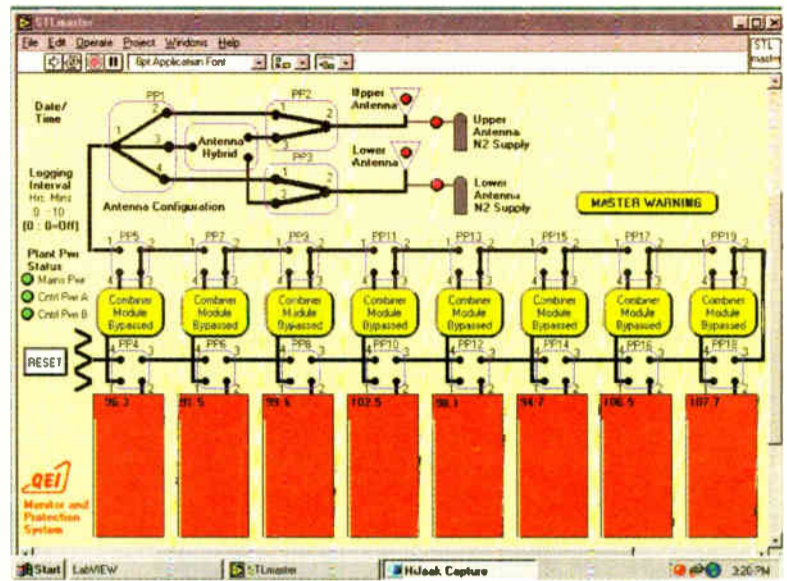

A Display of All Eight Stations in the St. Louis Combiner System

## Confiability with Life Time Warranty

### EDUCATIONAL CIRCULAR SERIES

Model	Bays	Power	Gain	Price
MP-1	1	600W	-3.3	\$250
MP-2	2	800W	0	\$680
MP-3	3	800W	1.4	\$980
MP-4	4	800W	3.3	\$1,280
MP-2-4	4	2,000W	3.3	\$1,820
MP-3-5	5	3,000W	4.1	\$2,270
MP-3-6	6	3,000W	5.2	\$2,740

### LOW POWER CIRCULAR SERIES

Model	Bays	Power	Gain	Price
GP-1	1	2,000W	-3.1	\$350
GP-2	2	4,000W	0	\$1,350
GP-3	3	6,000W	1.5	\$1,900
GP-4	4	6,000W	3.4	\$2,600
GP-5	5	6,000W	4.3	\$3,150
GP-6	6	6,000W	5.5	\$3,700

### MEDIUM POWER CIRCULAR SERIES

Model	Bays	Power	Gain	Price
SGP-1	1	4,000W	-3.3	\$690
SGP-2	2	8,000W	0	\$2,690
SGP-3	3	10,000W	1.4	\$3,595
SGP-4	4	10,000W	3.3	\$4,500
SGP-5	5	10,000W	4.1	\$5,300
SGP-6	6	10,000W	5.2	\$6,100

The antenna gain may vary with the frequency. For powers up to 20 KW please, make the request to provide the specific configuration.

OMB also Manufactures:  
 FM transmitters  
 TV transmitters  
 FM and TV Links  
 TV antennas  
 Medium power FM antennas

Connectors



OMB America  
 3100 NW 72 Ave #112  
 Miami, Florida 33122  
 Phone: 305-477 0974  
 Fax: 305-4770611  
 Toll free: 888-OMB4USA

# Custom-Built PIEs for Radio

► PIE, continued from page 48

BR designs and supplies prewired PIE Rack Systems for AM, SW, FM and TV applications. The company has supplied radio and TV PIE Systems around the world, including several for Telefunken and many to Middle Eastern and African countries for TCI, to the Americas and elsewhere.

Based in Richmond, Ind., BR serves the worldwide broadcast community by marketing, selling and integrating 200 product lines of professional radio and television equipment, as well as designing and supplying custom prewired PIE racks, pre-connectorized console harnesses, and turnkey on-air and production studios.

BR pre-wires specified equipment into their PIE racks, but typically utilizes the following:

- Audio/Video Distribution (ATI, Leitch)
- Audio/Video Monitoring (Crown, Electro-Voice, JBL, Barco)
- Audio/Video Patch (ADC)
- Audio Processing (CRL, Orban)
- Modulation Monitoring (Belar)
- STL (if required) (Marti, Moseley, RF Technology)
- Test Equipment (Tektronix, Potomac, Modulation Sciences)

For each custom PIE, BR brings the required components into its facility, then racks, wires and tests all as a complete, integrated system. Its racks feature AC distribution with terminal block input, 20 amp breaker protection, front-panel master on/off; a minimum 240 cfm fan assembly for efficient ventilation, a one-point grounding system to be tied to station ground and neatly bundled cabling, labeled for immediate reference.

A custom systems manual, complete with operational instructions and thorough easy-to-follow schematics,

accompanies its prewired racks.

In our experience, the BR PIE racks are always shipped intact and on time, and are operational within two or three hours upon arrival. This is appreciated by engineers who have frustratingly labored for weeks, spending too many midnight hours in attempts to "get the rack up and running" without the conveniences of a laboratory environment.

I would like to put on record how much TCI appreciates the excellent support we have received

from Broadcast Richmond over several years. TCI looks to BR for all of its pre-wired program input and test equipment systems, which BR has always supplied correctly and on time.

TCI just completed an important AM installation in the Middle East which incorporated a unique and complicated dual-signal-path PIE System. Broadcast Richmond designed and built this complex system in record time to the full satisfaction of this customer.

Everything TCI has received from BR has been of the highest quality in terms of workmanship, technical documentation and price competitiveness. We will continue to work with them for all of our radio and TV installations in the future.

For more information contact Broadcast Richmond in Virginia at (765) 966-646; fax (765) 966-5505 or circle Reader Service 14.

David Swan has worked in the broadcast industry for more than 30 years, including time with the BBC in England and 12 years as technical advisor to the Sultanate of Oman. He can be reached at (408) 747-6116.

## Intelligent Monitoring At Work in St. Louis

► QEI, continued from page 49

Priority 3: Should the top or bottom half of antenna forward power exceed 115 kW, a warning relay is closed to all stations. At 125 kW forward power, all stations are put into half-power mode. After a 30-second wait, if forward power still exceeds 115kW, all stations are taken off the air.

Priority 4: If a module input exceeds 35kW on any station, a warning relay is closed to those stations exceeding the limit. At 40 kW, the station using that particular module is placed into half-power mode. If input power still exceeds 35 kW after 30 seconds, the station-using module is taken off the air.

Priority 5: Should the top or bottom half of the antenna lose nitrogen pressure, the warning relay to all stations is closed and all stations are taken off the air.

Priority 6: When the nitrogen supply needs to be changed, a warning relay to all stations is closed.

This represents how a typical high-power combining system can use this

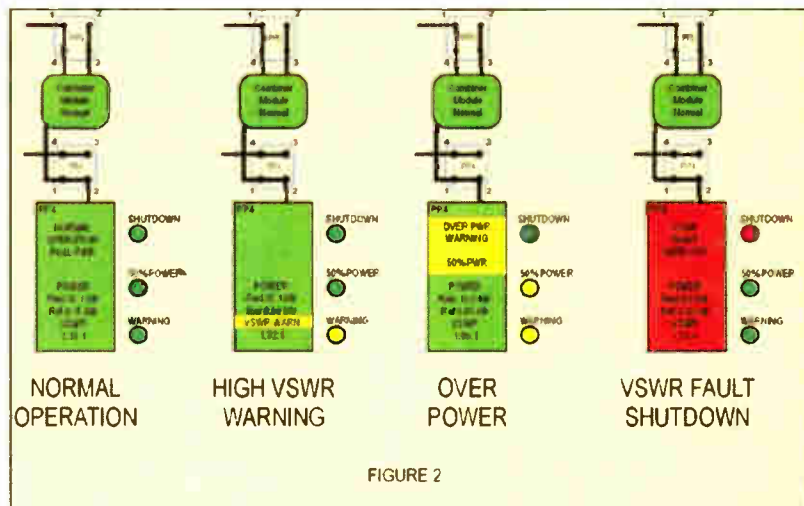

other control and monitoring sequences are possible.

Through careful analysis of combiner and antenna failure modes, a monitoring system may be developed to not only provide early warning of component failures but also can limit costly damage and downtime.

FIGURE 2  
Different Modes of Status Change

fault detection and corrective action sequence. Since the QEI monitoring and control software is uniquely adapted for each installation, many

For more information contact Jeff Detweiler at QEI in New Jersey at (800) 334-9154; fax (609) 629-1751 or circle Reader Service 40.

# Products & Services Showcase

For more information on the products shown below, circle the appropriate Reader Service No.(s) on the enclosed Subscription/Reader Service card or contact the advertiser directly.

**EQUIPMENT LEASING**

**START UPS  
TURNAROUNDS**

**\$100,000  
TO  
\$1,500,000**

**CALL ... (617) 267-2900**

**BOSTON FINANCIAL & EQUITY CORP.**  
20 OVERLAND STREET BOSTON, MA 02215  
WWW.BFEC.COM

READER SERVICE NO. 99

**Designed for Broadcasting!**

**MINI-MIX 8A**

**\$2499 List**

12 Stereo Inputs    2 Stereo Outputs  
2 Dedicated Mikes    1 Mono Output

Service & Affordable Quality for Over 28 Years

**AUTOGRAM CORPORATION**

1500 Capital Avenue (972) 424-8585  
Plano Texas 75074-8118 1-800-327-6901  
FAX (972) 423-6334  
info@autogramcorp.com

READER SERVICE NO. 124

**Attention Advertisers!**

Reach **18,000+** broadcasting professionals!

**RADIO WORLD'S Product Showcase** provides a perfect medium for test marketing your products and services.

**It's an efficient, effective & affordable advertising option!**

For more information, including rates and deadlines, fax **Simone Mullins** at **703-671-7409** or call **703-998-7600 ext. 154**

**TECHNOLOGY UPDATES**

**Broadcast Electronics**

The AS10 modulation monitor from **Broadcast Electronics** is considered by the company to be an improvement in C-QUAM AM stereo monitoring technology, offering design innovations with features absent from other C-QUAM monitors.

According to Lee Bramer, chief engineer at KSUM(AM) in Fairmont, Minn., the AS10 has run properly nearly a year after its installation. "We ran tests through it (after installation) and it has worked fine ever since."

The unit features RF AGC for quality C-QUAM decoder performance and has minimal overshoot for accurate modulation level measurement. Digital pilot detection is included for long-term stability, and a front panel audio output assists transmitter alignment

and proof of performance.

Bramer said the scales can be adjusted manually, or put in the auto-ranging mode. "If you have a low level come in, the range can change automatically if desired," he said. A switch on the back panel alters the RF level display. "Normally, it's just a pot that runs up and down," said Bramer.



Also featured are built-in selectable NRSC filters for audio outputs as well as the availability of either 9 or 10 kHz spacing for U.S. or European AM radio.

For more information contact **Broadcast Electronics in Illinois at (217) 224-9600; fax (217) 224-9607 or circle Reader Service 41.**

**Gentner**

The GSC3000 remote facilities management system from **Gentner** has a modular approach that allows the user to remotely control a single site as easily as multiple sites.

A stand-alone monitoring and control unit, the GSC3000 is event-driven and features time-based automatic command capabilities to insure smooth operation. Alarms



and site conditions are communicated to the engineer by phone, pager or data transfer. Corrective action is taken by the unit when necessary.

Each I/O unit has 16 analog metering units, 16 binary status inputs and 16 command channels. Up to 16 I/O units can be networked together per site, providing up to 256 metering, status and command channels each. Only one phone line is necessary for

remote control of all 16 units.

Several accessories are available for the GSC3000, including a Silence Sensor that turns off the user's transmitter when audio is lost for a predetermined period; Temperature Sensor

unit, providing accurate air temperature monitoring between -40 and 120 degrees Celsius; AC Current Sensor, for measuring samples of AC power lines; and Four-Wire Modem, for interfacing the GSC3000 to dedicated four-wire telephone lines and radio links.

For more information contact **Gentner in Utah at (801) 975-7200; fax (801) 977-0087 or circle Reader Service 16.**

**Burk Technology**

The ARC-16 remote control system from **Burk Technology** offers the choice of full-time transmitter control, dial-up telephone control or both.

The modular design of the ARC-16 allows the user to configure a system that fits specific needs of the



station. With a full-time system, the studio controller gives operators a constant link to the transmitter for instant response to any problem. In the single-unit stand-alone configuration, the speech interface allows control using a telephone DTMF keypad. A self-prompting, digitally recorded human voice helps guide

operators through transmitter readings and adjustments.

The ARC-16 includes 16 channels of analog metering, 16 status channels and 32 command outputs (16 raise and 16 lower). Subcarrier generators, demodulators and communication modems are built-in. The system is expendable to include multiple transmitter sites or multiple studios within a single system. All units within a system can monitor and control all other units.

Studio units can be equipped with inputs/outputs that provide control and monitoring of automation and EAS equipment as well as audio sources.

For more information contact **Burk Technology in Massachusetts at (978) 486-0086; fax (978) 486-0081 or circle Reader Service 42.**

**ATI**

ATI offers several studio metering systems for simple reading of important signal lines and critical level checks.

Among the models manufactured by the company are the VU200, one stereo pair with a single centered mount; VU400, two stereo pairs, symmetrically mounted; VU600, three stereo pairs with the center and end mounted; and VU800, four stereo pairs, symmetrically mounted. Each mounts in standard 19-inch racks, measures 3-1/2 inches high and 7 inches deep, and weighs under ten pounds.

The units feature luminous, three-col-

or, 16-segment LED displays that can be seen clearly across brightly lit studios. Average and peak levels can be compared with simultaneous VU and PPM indications. Continuous VU bar graphs cover -20 to +5 VU and bright moving-dot PPM type indicators cover +1 to +8 VU.

All input connections are through rear barrier strip terminals and are supplied with fanout strips for pre-wiring and quick-change servicing.

For more information contact **ATI in Pennsylvania at (215) 443-0330; fax (215) 443-0394 or contact Reader Service 15.**



**And You Thought You Knew Us.....**



**Solid-State and Single Tube Transmitters**



**Low Power Transmitters**



**Digital STL / TSL Systems**

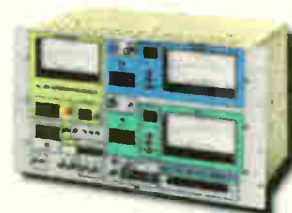

**Modulation Monitors**



**Pre-Built Modular Transmitter Sites**

**For More Information Call Us Toll-Free At (800) 334-9154**

**QEI Corporation**  
One Airport Drive, P.O. Box 805  
Williamstown, NJ 08094  
e-mail: qeisaless@qei-broadcast.com

Toll-free Sales (800) 334-9154  
Fax (609) 629-1751  
Emergency Service (609) 728-2020  
Web Site: <http://www.qei-broadcast.com>

# Complete Control With MAC

► DAVICOM, continued from page 47  
once a week. The circuit is available upon request by e-mail at [jemccloy@interlynx.net](mailto:jemccloy@interlynx.net)

The MAC system communicates through a 14.4K modem or a DTMF/voice interface. This modem will fax out, call a pager (voice, numeric or alpha), report back to a central terminal and/or call a home office or cell phone in any desired combination or order.

It is possible to call in with a DOS or Windows 95/98 PC for complete control and programming, or use telephone DTMF tones to check status, execute commands and/or disable alarms that can wait until morning.

The unit has a 512-event history log with time and date stamping. It can be viewed on-line, be faxed to a location or printed to a file. The optional MACNET software will append the log to a central terminal database to view trending data for single or multiple sites. Logging can be automatically timed for preset intervals or when the log reaches a certain size.

The serial ports can talk to other equipment equipped with similar ports. This means activation of HVAC systems (now in development), diagnosis

of satellite receivers, and communication with generator switching gear, audio processors and transmitters under RS232 control.



The MAC Remote-Control System From Davicom

The MAC unit is configured by direct RS232 terminal or modem by the DOS or Windows 95/98 program. The alarm conditions can be set as major or minor,

which can be programmed for whatever action you deem fit — I send minor alarms to the fax machine and major alarms to phones and pagers.

The MAC I/Os are connected to rack-mount panels with terminal blocks, which are connected to the main chassis by pre-made cables. Only the RSR232 DB9 connectors appear on the main chassis. All I/Os are silk-screened for easy identification.

I prefer to demount the terminal blocks and have custom lengths of cable made up by Davicom so the I/Os can be mounted in NEMA enclosures, marshaling all system control wiring into one location.

## Configuring and programming

Before a MAC unit can be used, it must be programmed. Inputs and outputs must be labeled and their states or levels defined. The MAC configuration file can be downloaded and stored on a disk. It is readily translated to a readable format and can be printed as part of the documentation package.

Analog inputs have two sets of high and low levels (each with programmable hysteresis) that can be assigned as major or minor alarms. Time delays can be assigned to each to prevent annoyance trips.

Digital inputs can be assigned as normally high or low and set as major or minor alarms (or not as alarms at all), and time conditioning can be added. Another feature is a timer, which can go into alarm mode if the input has not been active over a long period of time (such as a generator run).

Relays can be defined as pulse or latch for remote, remote/automatic, or automatic-only type of operation. The latter enables me to use them in certain programmed routines.

The virtual inputs and outputs are workbits which exist in memory only and are the means by which the unit can be programmed for decision-making and commands. Analog or digital inputs — or relay states for that matter — can be logic-gated to build up a series of statements. I program these to perform program chain switching, transmitter changes, generator exercising, battery testing and building-entry detection. Each virtual input can pulse or latch up to six relays.

In unattended remote sites, the MAC can detect an RF failure, call the standby transmitter to air and restore the signal. The engineer then diagnoses the original problem from the data log and decides on a course of action.

Five years ago, a large transmitter project required 21 relays, three timers and a lot of custom interface assemblies. This past summer, an identical plant engineered with the same people required only three relays. A substantial saving in time and money was noticeable due to the power of the MAC. Additionally, transmitter troubleshooting during the burn-in phase was quickened by the accurate information available from the MAC's event history log, which we e-mailed to the manufacturer.

■ ■ ■

John McCloy is a self-employed installer and designer of technical equipment. Reach him at [jemccloy@interlynx.net](mailto:jemccloy@interlynx.net)

For more information contact Elaine Jones, Davicom's U.S. contact, in Utah at (801) 256-3729; fax (801) 256-9625 or circle Reader Service 43.

## Things you can say about our old fashioned meters



"2 or 4 VU meters"

"2RU enclosure"

"Familiar"

"High impedance inputs"

"Lighted VU meters"

"XLR connectors"

"Priced right"

"Phase reading"

"Balanced bridging inputs"

"Easy to install"

"Sturdy"

"Zero adjust control"

"Reliable"

"Easy to read"

2VUB or 4VUB Mechanical Meters

How to say "MINE" --

Call us

**Logitek** digital with a better difference!

3320 Bering Drive, Houston, TX, 77057 USA Voice: North America 800.231.5870  
Others: 713.782.4592 Fax: 713.782.4592 e-mail: [info@logitekaudio.com](mailto:info@logitekaudio.com)

Visit our home page at [www.logitekaudio.com](http://www.logitekaudio.com) for more information

# Test Devices: Plenty to Consider

► TESTING continued from page 47

is the only true digital audio test set which both generates and analyzes digital tests without using A/D converters. This is important because it ensures that the specs of the test equipment remain better than that of the equipment under test."

This is no small feat considering most modern audio devices have specifications that far and away exceed those of the test equipment on many benches.

Sophistication comes at a price. Audio Precision equipment, well worth the money, is in the more-expensive range. More affordable and relatively new are the Bit Buddy and Bit Spitter, distributed by Harris Broadcast. According to Brian Szewczyk, sales specialist for Harris, these are as handy as a bridging amp or Fox and Hound, and are perfect for injecting, tracing and monitoring a digital signal.

More often than not, knowing where a problem is versus what it might be is all that's necessary. Let's face it, when the clock is ticking and spots are being bumped, removing or bypassing the weak link is as good as fixing the problem.

## Scope of the scene

Another piece of must-have test equipment is the oscilloscope. Whether tracing audio or RF bits, there's probably no single piece of equipment that is equal in utility to an engineer. And we've come a long way, baby, from the old Eico blurry-eyed monster.

New to the market is the Tektronix TDS3000 DPO. This digital phosphor oscilloscope, according to the Tektronix Web site, "provides the intensity-graded display and responsiveness of an analog scope, combined with the storage and measurement capabilities of a digital storage scope."

As with most modern equipment, it will interface with a PC, extending its capabilities. Tipping the scales at a mere seven pounds, it is a lightweight unit in the best sense. Less complex, but workhorses none-the-less, are Fluke's handheld oscilloscopes. New CRT scopes continue to be introduced by Tektronix, Leader, Protek and other manufacturers.

Conventional analog audio test equipment continues to be manufactured and purchased. Potomac Instruments line of AA/AG audio tests sets, field strength meters and antenna monitors are almost ubiquitous. Few and far between is the engineer who hasn't spent a long day or evening with the familiar brown paint of PI equipment.

"This equipment is still much in demand and will continue to be available for a long time," said David Harry, president of Potomac Instruments.

On the drawing board at PI is a field strength meter aimed at the DTV market, of which Harry said "a proof of concept device is planned for the spring NAB." Although it is intended to "bridge the gap between a carrier and non-carrier based TV broadcast," I wouldn't be surprised if the basic design is put to use with an eventual IBOC system once fully implemented.

In the broadcast monitoring realm, FCC deregulation notwithstanding, a modulation monitor is still needed, if only from time to time. For FM, the

Inovonics 530 tunable monitor, introduced about a year ago, is providing an option to the QEI 691, a staple with most consultants. And modulation "analyzers" continue to increase in popularity: Modulation Sciences ModMinder and Belar's Wizard are alternatives to the traditional three moving meters and (hopefully not frequently) blinking light.

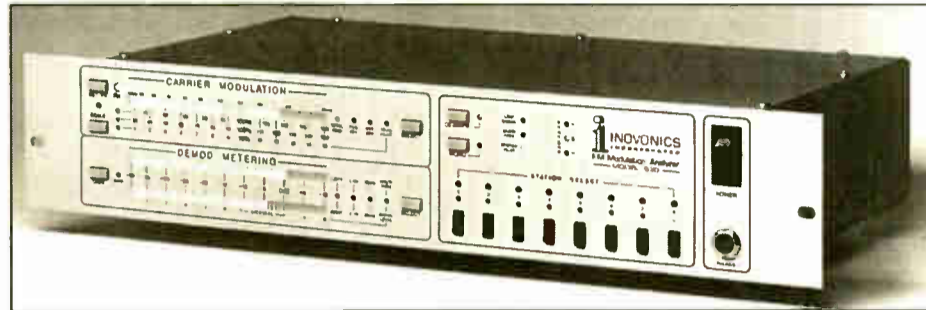

The Inovonics 530 Tunable Monitor

Also from Belar is the Composite FFT Spectrum Analyzer, a 1998 RW Cool Stuff Award winner. It is being outfitted with new A/D converters, and Belar President Arno Meyer said he expects to have the improved version ready for shipping by the spring NAB show. Likewise, the SCMA-1 DSP-based subcarrier monitor will also be ready to hit the streets sporting new A/D converters by NAB season. With specs that exceed -80 to 85 dB separation and noise figure, you should be certain that it's the broadcast equipment being tested and not the test equipment itself!

For AM DAs there's no getting around the antenna monitor and, hopefully, an OIB. There's not much new here, but if you have more than one tower in the backyard, you need to have them.

## Time to buy

There are goodies galore on the market, but who's buying them?

Without a doubt, the trend is toward the group director of engineering as the most likely candidate to be purchasing

and (at least at first) playing with the big boys toys. Consulting engineers, and more and more regional consultants, are also purchasing equipment as the ranks of the traditional chief engineer shrink.

Lament broadcast consolidation all you want, but there is an upside. With a dozen or more stations in a group, the cost of buying a good spectrum analyzer, IFR, high-powered audio/digital test set,

FIM-71 Field Strength meter, whatever, is easier to justify. A \$30,000 equipment investment is insane for most single stations or AM/FM combos. Spread the utility of the equipment throughout a group of thirty stations and the economics just became quite sane.

All is not lost, however, in creating a serviceable workshop or bench, even though this seems to be a quaint idea in new station construction. Many decent and talented engineers can do incredible things with a simple set-up. This is especially true if you prioritize your needs.

Some things just don't need to be fixed. Some computers, CD players and MiniDiscs come immediately to mind. Why bother? For less money than the investment of time, you can replace them with better, newer, less expensive — and — more reliable units.

So, suggestions for a decent workbench setup?

Anthony Kord, a New England-area contract engineer and Dick Rzeszutek, chief engineer for public radio's power

house WFCR(FM) in Amherst, Mass., suggest the following: a quality set of hand tools, a digital and analog VOM, a 1 GHz frequency counter, a digital LCR meter, a 50 MHz or better dual-trace scope, an audio oscillator, a butt set and/or audio bridging amp, a Fox and Hound signal tracer, a Bird 43 Wattmeter and a variety of slugs, many coax adapters and a 1/5/8 to N reducer, and, if you can find one, an inexpensive distortion analyzer or audio VTVM. Many serviceable shops have been put together with a phone in one hand and a "Tech America" catalog in the other.

Other important items, not strictly speaking test equipment, that you should have at the ready, according to Stan Miastkowski, an internationally published computer consultant with a long background in radio: DOS boot disks, Windows (of whatever flavor) startup disks and utilities disks such as Norton. If it hasn't happened yet, it will — the traffic or studio PC crashes and while you look at a blinking cursor, you hear the curses of those who failed to backup the system. Get that balky 486DX to a DOS prompt and you've got a fighting chance. The heat is on, and as Charlie Brown says, it's time to be the hero or the goat.

Finally, returning to my opening thought, there are less of us today than there were yesterday. Keep in touch with other broadcast engineers. If there is an SBE chapter nearby, attend a meeting from time to time. This is critical if your station is not part of a large group with larger resources at your disposal. That odd tool, part, or piece of test equipment you have could be just what someone else needs in a pinch. And don't worry, your turn will come soon too.

■ ■ ■

Bob Shotwell is SBE and NARTE certified. A broadcast engineer for more than 20 years, he co-owns and operates WPVQ(FM), South Deerfield, Mass. Reach him at bob@wpvq.com

RW welcomes other points of view and your opinions about test and monitoring equipment not mentioned here.

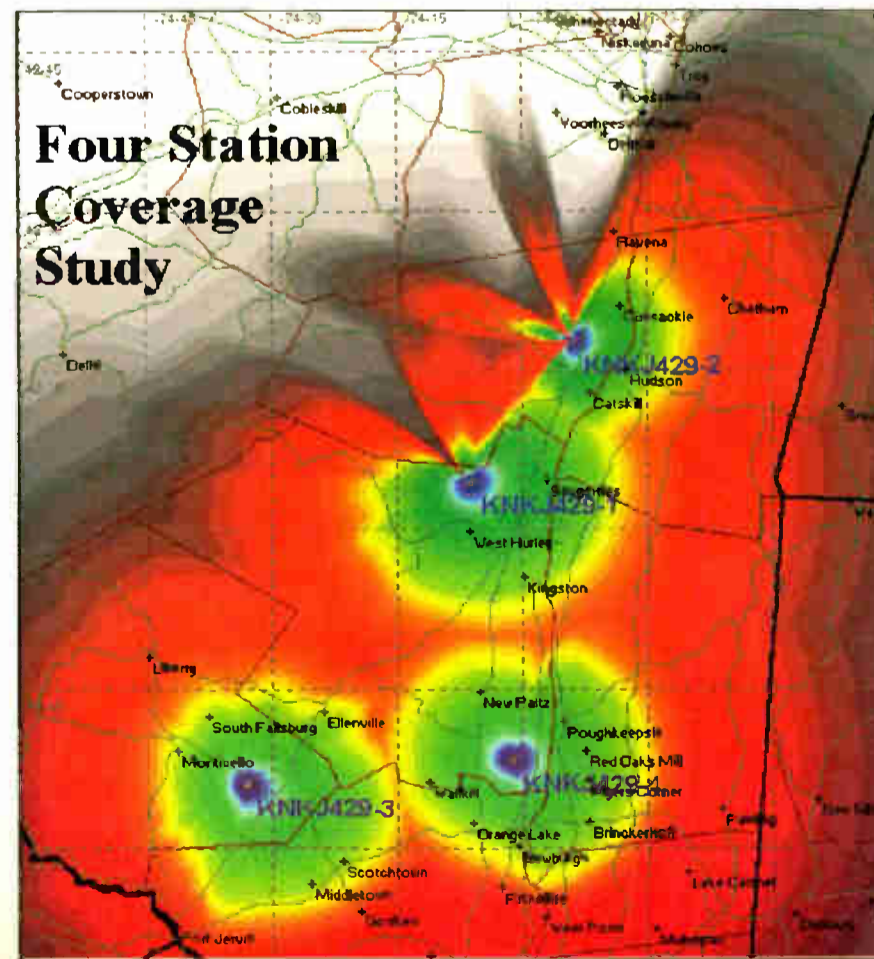

## RadioSoft

Announces the release of the NEW Version 2.0 of ComStudy for Windows

You asked for lots of expanded features:

- 256 Colors for Contours and Coverage
- TIA Frequency Coordination Compliance
- Simple Runtime Overlay Management
- Transmitter Database Import/Export
- Individual Station Editing in Systems
- Individual System Matrix Recalculation
- Area Reliability Analysis and Mapping
- True 32 bit Operation (Win 95, 98, NT)
- Increased Accuracy (Land Uses added)
- More Interference Algorithms

**And RadioSoft Delivers!**

ComStudy 2.0 is available as a 15 day evaluation: call 888.RADIO95 (USA) or 904.426.2521 or check our website: [WWW.RADIO95.COM](http://WWW.RADIO95.COM) for details.

**Aggressively Priced!**

Special pricing for all current users of propagation software and overlays!

RADIO95 IS A CUSTOMER FRIENDLY COMPANY  
100 W. KNAPP AVENUE, EDGEWATER FL 32132

**TECHNOLOGY UPDATES**

**Audio Precision**

The Portable One Dual Domain audio/interface analyzer from **Audio Precision** makes all required measurements for modern analog/digital radio stations and audio production facilities.

The most recent addition to the Portable One line features a 96 kHz sampling rate option (96K-PIDD) for testing digital devices. Each unit features a variety of digital interface test and monitoring functions: jitter generation and measurement, audio bit error rate and sample rate measurement are among them.

The analog/digital/interface tester also generates and measures analog and digital audio signals in their native domains. Unlike "mixed signal" analyzers, the

Portable One Dual Domain includes analog hardware for analog measurements and digital hardware for digital domain and audio interface measurements.

The unit can be connected to digital audio signal chains without difficulty, with its separate digital input/output connectors and separate



generator/analyzer functions. Save and recall functions are utilized for stored tests and data.

For more information contact **Audio Precision in Oregon** at (503) 627-0832; fax (503) 641-8906 or circle **Reader Service 17**.

**Ward-Beck**

**Ward-Beck** offers several products in the metering realm, including POD 11 and the M445.

POD 11 is an AES/EBU digital audio monitor; it is dual channel with a 20-segment LED level display and



eight signal-status LED indicators. Three analog outputs allow aural monitoring of the digital signal through a headset or an external power amplifier and speakers.

Its LED status indicators display sample rate (32, 44.1 or 48 kHz), signal lock, CRC error, confidence, consumer mode and phase error. A front-panel headset jack with level control is included.

The M445 is an extended-range metering and monitoring system that can be used as a rack-mount or portable precision instrument. In its docked position, the rack-mounted unit serves as a stereo meter and monitor for plant levels. When undocked, it functions as a portable stereo audio meter, operating on ready-charged NiCad batteries.

The unit's integral amplifier-driven stereo speakers provide the monitoring function. The M445 meter measures the stereo signal in the left and right mode. To monitor phase integrity, the sum and difference (L + R, L - R) mode is utilized.

For more information contact **Ward-Beck in Toronto, Ontario**, at (416) 438-6550; fax (416) 438-3865 or circle **Reader Service 44**.

**Dorrough Electronics**

**Dorrough Electronics** offers several lines of loudness meters for dimensional audio metering. The most recent families from the company include the 40, 12, 10 and 400 Series.

The DSP audio metering system is incorporated into all models in each series. The advantages of LEDs are exploited with the ergonomics of DSP plus its patented metering ballistics. The result is a meter that reads sound dimensionally, providing both qualitative and quantitative information. According to the company, this ballistic, along with its persistence scale, makes these meters superior to oscilloscopes in allowing the human eye and brain to perceive the peak reading. Also included is the Peak-hold feature,



as well as an alarm function that alerts the user of undesirable operating parameters such as total audio drop-outs and over-driven levels. Several user-supplied visual and audible warning devices can be accommodated with a built-in relay. Inputs to these features are accessible by way of the computer-style connector.

The meters can be configured to monitor individual channels or both the left and right channels.

For more information contact **Dorrough Electronics in California** at (818) 998-2824; fax (818) 998-1507 or circle **Reader Service 66**.

**Sine Systems**

The **Sine Systems RFC-1/B** remote facilities controller is a single-point dial-up system that allows control over a transmitter from a regular telephone.



The RFC-1/B receives commands from the user through key sequences on a telephone keypad. A natural-sounding human voice provides responses. Additionally, the system can perform user-programmable automated tasks, including daily power changes and transmitter monitoring for out-of-tolerance operating

conditions. Station personnel are warned when necessary.

The basic system consists of the RFC-1/B and one RP-8 relay panel. The RP-8 provides an interface for up to eight channels of telemetry (status readings) and control (On/Off or Raise/Lower functions). Additional relay panels may be added to increase the system capacity to a maximum of 64 channels of telemetry and control.

Among the accessories which can accompany the RFC-1/B is the SP-8 surge protector to protect the system from lightning. The SP-8 was designed specifically for this system, providing surge suppression for eight telemetry channels and the telephone line.

For more information contact **Sine Systems in Tennessee** at (615) 228-3500; fax (615) 227-2367 or circle **Reader Service 88**.

**Prism Media**

The DSA-1 from **Prism Media** is a portable test instrument for specialized measurements and checks of digital audio systems. It's used in distribution systems or at equipment ports.

These "connectivity" checks, combined with automatic test sequences, allow quick and reliable go/no-go indications for several situations. The unit's user-defined test sequences allow tailoring of system

parameters and test limits to suit the application to ignore harmless conditions and apply user-defined failure criteria.

For more information contact **Prism Media in New Jersey** at (973) 299-7790 or circle **Reader Service 89**.



**A Best-Value FM Mod-Monitor**

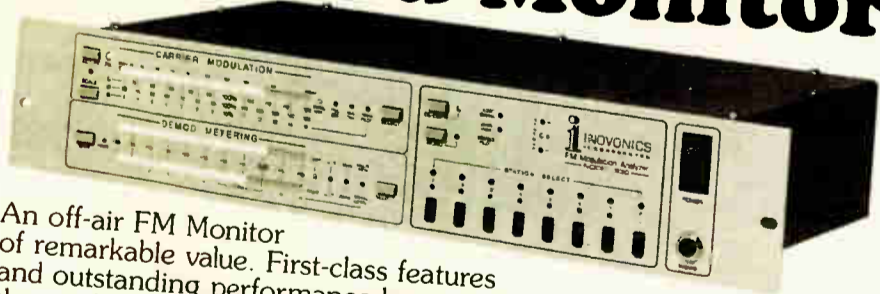

An off-air FM Monitor of remarkable value. First-class features and outstanding performance have made the Model 530 a favorite the world over. Check these product highlights:

- Accurate, high-resolution bargraph metering of carrier deviation and demodulated program audio; pilot, subcarrier and residuals. Meter also displays signal strength and multipath distortion to aid antenna alignment.
- Pushbutton tuning with 8 station presets for "comparative market evaluations."
- Rear-panel outputs for composite MPX and balanced program audio; plus remote peak flasher, carrier-loss and program-loss alarms.

**MODEL 530 FM MODULATION MONITOR**

**Inovonics, Inc.**

1305 Fair Ave., Santa Cruz, CA 95060 USA  
TEL: (408) 458-0552 • FAX: (408) 458-0554

www.inovon.com



Circle (12) On Reader Service Card

**Dove Systems**

The DRC200 transmitter control system from **Dove Systems** can monitor up to 254 sites simultaneously. An unlimited number of user-defined screens will show data from multiple sites on each screen.

The transmitter site unit includes 48 analog inputs, 48 status inputs and 48 open collector control outputs. Also featured is an internal 2,400 baud modem, a VGA monitor, a serial mouse, keyboard and printer. If studio control is desired, a transmitter site unit may be used.

A typical user screen features controls activated by keyboard and/or

mouse commands. The screens are protected by unlimited user names and passwords. There is also a user-defined log format; multiple sites may be printed on the same log.

Sites may be linked using a two-wire voicegrade dedicated circuit, UHF packet radio links, ISM spread-spectrum links or user-supplied RS232 digital data links. A user-defined calibration formula for each channel allows linear, square, deviation, indirect power and other displays.

For more information contact **Dove Systems in California** at (805) 541-0200; fax (805) 541-8293 or circle **Reader Service 67**.

# Products & Services Showcase

For more information on the products shown below, circle the appropriate Reader Service No. (s) on the enclosed Subscription/Reader Service card or contact the advertiser directly.

Would you believe that you can visit a dozen markets in an hour without leaving your desk?



If you have the TeleRadio from CircuitWerkes at your stations, you can listen to every radio station in each of your markets.

Old-fashioned air-checks are okay, but they have some real drawbacks. Among them are:

1. You have no control over what is recorded on an air-check. You may be hearing only what someone else wants you to hear.
2. Your own air staffs usually know when they're being recorded and react accordingly.
3. By the time you get an air-check in the mail, it may be too late to respond to the competition.

The TeleRadio beats those problems by letting you listen to both your station and the competition in **real-time**. If you have a TeleRadio, you simply dial it up from any phone. As soon as it answers, the internal radio begins playing down the phone line to you. You can control the radio by using the buttons on your phone. It's just like being there!

The TeleRadio even has a DTMF selectable external audio connection so it can be used as a standard telephone coupler too. An optional call progress decoder is available for using the TeleRadio on PBX analog lines and in areas that don't support CPC.

CircuitWerkes - 3716 SW 3<sup>rd</sup> Place, Gainesville, FL 32607  
(352) 335-6555 / fax 380-0230 - www.circuitwerkes.com

READER SERVICE NO. 21

## How Loud Do You Want To Be?

It takes an assault weapon to dominate the dial...

**KAMIKAZE!** PUTS TEETH IN YOUR SIGNAL WITH INTENSITY PROCESSING. WHEN LOSING IS NOT AN OPTION, RELY ON OUR PROPRIETARY LOUDNESS ENHANCEMENT SYSTEM: **KAMIKAZE!** WITH VARI-CLIP. BE THE LOUDEST ON THE DIAL OR YOUR MONEY BACK! ANOTHER PROCESSING SECRET WEAPON FROM THE MINDS OF MICROCON.

**KAMIKAZE! High Intensity Proc-Stereo Coder \$2500. pro net**

CAN WE BUILD ONE FOR YOU?  
MORE INFO @ WWW.MICROCONSYS.COM

**MicroCon Systems Inc.**  
(440) 546-0967

Only one to a market - Don't be left out!  
Claim your **KAMIKAZE!** today... before your competitor!  
In Your Face Processing from Jim Somich  
**Warning: This is not your father's processor!**

READER SERVICE NO. 47

REMOTE  
MONITORING  
AND  
CONTROL  
FOR ANY  
SIZE SITE

Davicom systems provide all the automated monitoring, reporting and control functions you need to keep your site(s) operational and legal. Our systems are practical: they are sized for every type of operation from small AM sites to large TV facilities, with set-up and operational software that even casual computer users can understand.

**davicom**  
technologies

Call us today  
for more information!  
Toll Free: 1.877.327.4832  
(609) 653.1065

READER SERVICE NO. 73

## NEW! World's Most Advanced CD Duplicator



CD-3707

**AUTOMATED**  
Spindle Based CD-R Copier

- Industry's First System with Pro Audio Compare Mode
- 7-Drive / 200 CD Capacity
- Networkable to 28 CD-R Drives
- Simple Unattended Operation
- Analog/Digital Audio Import Options
- ONE-BUTTON Operation
- Copies All Current CD Formats

Mitsui Silver as Low as \$1.35



**GLOBAL DATA INC**

SINGLE SOURCE SOLUTION FOR ALL YOUR CD/DVD NEEDS

**CALL 414-797-9772**  
FOR ADDITIONAL DUPLICATORS AND CD ROM PRINTERS

READER SERVICE NO. 20

## Eliminate Lightning

15 Years of Success

with the



The **Gila-Stat** is designed to reduce lightning damage by lowering the likelihood of a direct lightning strike to:

- Buildings
- Communication Towers
- Electric Utility Substations
- Industrial Facilities

**nott ltd.**

3801 La Plata Hwy  
Farmington, NM 87401  
phone 505-327-3646 fax 505-325-1142  
800-443-0966

READER SERVICE NO. 46

## EQUIPMENT FINANCING

**FIRSTCORP**<sup>SM</sup>  
First In Equipment Leasing

- Specializing in Studio & Transmission EQ
- Lease-to-Own Financing
- Direct Lender
- Customized Lease Programs
- Creative Financing
- Challenging Credit



**BEN WEINGARTEN**  
(800) 810-8434

(949) 727-7400 FAX (949) 727-7473

E-mail: Ben@FirstCorp.com

READER SERVICE NO. 72

## Shively Labs

Reach for Ratings!

Shively Antennas Deliver Coverage!

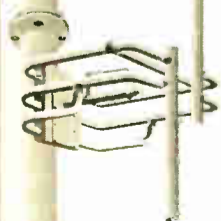

- Superior Engineering
- Multistation Solutions
- Filters & Combiners
- Translators
- Reliable Pattern Studies
- Coax

**FM & TV Antennas and Related RF Equipment**

**because ... it pays to be heard!**

P.O. Box 389, Bridgton, ME 04009 USA  
Tel.: (207) 647-3327 FAX: (207) 647-8273  
1-888-SHIVELY e-mail: sales@shively.com  
Web: www.shively.com  
An Employee-Owned Company

READER SERVICE NO. 98

## Switcher tools

Designed by broadcast engineers for broadcasters, our audio and digital audio switchers offer excellent sonic quality, removable I/O connections, contact closures and serial remote control capabilities and flexible mounting accessories.



SS 12\*4

Active crosspoint switching/routing with 12 stereo inputs and 4 stereo outputs.



10X1

Passive switching/routing with 10 stereo inputs and one stereo output or vice-versa.



SS 8.2

Active crosspoint switching with 8 stereo inputs, 2 stereo plus 2 mono outputs.



8x1 OAS

Routes any one of eight AES/EBU digital inputs to split outputs.



8X2D

Active crosspoint switcher with 8 stereo inputs, 2 stereo and 2 mono outputs



6X1G

Passive switching/routing with 6 stereo inputs and one stereo output, or vice-versa.



3X2B

Active crosspoint switcher with 3 stereo inputs and 2 stereo outputs.



SS 3.1

Passive switching/routing with 3 stereo inputs and one stereo output or vice-versa.



SS 2.1/BNC

Passive switching/routing with 2 composite audio, video, or AES/EBU inputs to 2 composite audio, video, or AES/EBU outputs, or vice-versa.



SS 2.1/TERM

Passive switching/routing with two stereo inputs to one stereo output or vice-versa.

Check out our web site for product information, list pricing and a list of distributors!

Internet: www.broadcasttools.com E-mail: bti@broadcasttools.com

Voice: 360.428.6099  
Fax: 360.428.6719

**BROADCAST**  
**tools**.inc

READER SERVICE NO. 100

## TECHNOLOGY UPDATES

## Neutrik

The Minirator MRI from Neutrik is a portable handheld audio generator that functions as a studio problem solver for radio stations.

The MRI features a polarity test signal to check PA speaker arrangements, and has precise digital accuracy and sweep capabilities. Its signal outputs include white noise, pink noise, square and sinusoidal modes. It also serves as a noise generator for acoustics analysis.

There is an RCA connection for unbalanced connections, and flip-out XLR pins for direct console injection or cable connection. It has an automatic power shut-off, selectable to 10, 30 or 60 minutes, or can be manually shut off from one of the three buttons on the



front of the unit. The MRI weighs six ounces with batteries. Approximately 20 hours of use can be realized with two 1.5 V dry or NiCad type cells, LR 6, AA or AM3 type batteries.

For more information contact Neutrik in Montreal, Canada, at (800) 661-6388; fax (514) 344-5521 or circle Reader Service 105.

## Holaday Industries

The HI-3804 RF industrial compliance meter from Holaday Industries can sense electric and magnetic fields with a single isotropic test probe.

With this device, EMF detection and measurement solutions are possible for applications in the 10 to 42 MHz ISM frequency bands. The HI-3804 RF simplifies testing methods required to determine electromagnetic field emissions such as RF heating and welding.

Among the features of the HI-3804 are on-board data logging and review; electric and magnetic field strength measurements; and linear, squares and power density units dis-



play. A dynamic range of 0.05 to 50 mW/cm<sup>2</sup> is provided.

For more information contact Holaday Industries in Minnesota at (612) 934-4920; fax (612) 934-3604 or circle Reader Service 209.

## Potomac Instruments

Potomac Instruments offers the 1900 series of digital antenna monitors, for digital display of ratio and phase of up to 12 towers. The three units in the series are Models 1901, 1902 and 1903.



All models provide continuous analog outputs of tower measurements and are compatible with any standard remote-control system. Sample ratios are indicated with little modulation effect and independent of the power level. All active circuitry is contained in modules that plug into the rear of the chassis.

Model 1901 is a 5-1/4-inch unit, containing control and measurement cir-

cuitry for up to 12 towers, digital display of all measurements, local operating controls and a remote-control interface. The monitoring system is controlled with four push-buttons. Model 1902 contains virtually the same display and control circuitry as 1901, but this unit is smaller at 1-3/4-inches.

Model 1903, while equivalent to Model 1901, does not have any front-panel control or display circuitry. It does provide a direct interface to a remote-control device, however. External control inputs, in the form of contact closure to ground, can switch the 1903 (as well as the 1901) to the correct pattern as well as select amplitude and test modes.

For more information contact Potomac Instruments in Maryland at (301) 589-2662; fax (301) 589-2665 or circle Reader Service 131.

## M&amp;C Systems

The Presence system from M&C Systems is a Windows NT-based monitoring and control system which can place control of all desired stations in one location.

As this is a configurable, software-based system, an engineer can monitor and control several functions from a computer console. The software may be custom-tailored for the user. Continuous 24-hour operation and built-in redundancy with high availability is provided. There is also signal path animation for the user to view.

The Presence system features visual and audible alarms as well as data and event logging. Its architecture allows the system to initially poll for the existing state of the monitored device, reporting changes as they occur. Automated database synchronization is accomplished locally and remotely. There are drop-down menus and point-and-click functions for easy use; the user can add or delete system devices locally or remotely.

For more information contact M&C Systems in Texas at (972) 422-5524; fax (972) 422-0790 or circle Reader Service 106.

## Delta Electronics

The PRH-1 from Delta Electronics is a high-powered pulse reflectometer intended for measurements on RF transmission line systems.

Ideal for use in high RF field environments, the PRH-1 can determine the location/nature of faults and is useful for periodic system maintenance. It operates with up to 500 W continuous or 1,000 W intermittent induced power. While designed for use with unbalanced trans-

mission line systems, the PRH-1 may be used with balanced lines, provided a suitable balun transformer is utilized.

The reflectometer drives the transmission line with a high-voltage, gaussian-shaped pulse. An oscilloscope provides amplitude-vs.-time display of echoes, which originate from line discontinuities and faults and the antenna or load terminating the line.

For more information contact Delta Electronics in Virginia at (703) 354-0212 or circle Reader Service 157.

## Fluke Corp.

The ScopeMeter B from Fluke Corp. is a portable and integrated digital storage oscilloscope and multimeter. The B series offers two 100 MHz models (105B and 99B) and two 60 MHz models (96B and 92B). Both 100 MHz models use repetitive sampling techniques for time resolution down to 200 picoseconds.

Weighing four pounds, the Scopemeter B simultaneously takes meter and scope readings with a single probe. RMS AC



and DC voltages can be measured up to 600V RMS and resistance up to 30 Megohms. Current and temperature is measured with optional probes.

The ScopeRecord function provides a memory of 30 kb for extended waveform recording, and can time-stamp events. Complete events such as long machine cycles and pulse train activity are utilized.

For more information contact Fluke Corp. in Washington at (425) 347-6100 or circle Reader Service 183.

## Avcom

Avcom offers the MSA-90A, a recent addition to the company's line of microwave spectral analyzers. Its frequency range covers an area of 50 kHz to greater than 1 GHz.

The MSA-90A uses direct frequency synthesis for accurate center frequency measurements with accuracy to 1 kHz. The design of its front panel allows fast input of operating parameters by using a rotary encoder and push-button selections.

Frequency resolution is accomplished by seven IF bandwidth filters ranging from 3 kHz to 3 MHz. Center frequencies are monitored by pressing one button that sets the frequency span to zero and enables the built-in modulator and audio amplifier. AM and FM audio demodulation are standard.

The operating parameters are displayed by two LCDs. One in the upper

display shows the dBm reference level and input attenuation amount; the lower LCD shows the center frequency, span-width, the selected resolution filter and sweep rate. The CRT displays



the RF spectrum with 65 dB of on-screen dynamic range.

For more information contact Avcom in Virginia at (804) 794-2500; fax (804) 794-8284 or circle Reader Service 132.

## Broadcast Tools

Broadcast Tools offers the DC-8A dial-up remote control for controlling and monitoring external devices from a touch-tone telephone.

When called, the DC-8A answers the phone line following a user-programmable number of rings, then waits for a valid access code to be received. It will then allow the control of eight relays and the monitoring of eight logic-level status inputs.

Equipped with a basic audio hybrid, the DC-8A allows the user to send and receive external audio while controlling the unit. The pager alert function can activate up to

three pagers by up to eight of the status inputs. All functions may be programmed remotely, with the exception of the factory defaults and setting of the access code.

The DC-8A features a DTMF transceiver, a single-rack chassis, a user-programmable tone acknowledgment defeat and screw-style wire captive terminals for connection. Easily distinguishable tones indicate the high-low or open-closed condition of the eight status inputs and relays. The unit may be configured for standalone DTMF tone decoding.

For more information contact Broadcast Tools in Washington state at (360) 428-6099; fax (360) 428-6719 or circle Reader Service 158.



## TECHNOLOGY UPDATES

## Auditem

The Audemat RXFM-MC3 receiver from Auditem monitors the coverage area and modulation quality of programs broadcast through FM transmitters and low-power translators. Installed in a car, the unit performs "in-running" measurement on several FM-band stations.

Each value is automatically indexed to a defined geographical location (GPS function) after selection of the best reception frequency (RDS function). The measurements can be operated in manual or automatic modes, according to distance or time-lapse intervals.

Windows-based software manages the RXFM-MC3 and a portable host micro-computer stores the measurements.

Several modes of data display can be selected: the geographical display in average area, full circle or digital value modes; the smooth or full curve display; or the measured value chart. With the Zoom function, the user can display a detailed view of measurements from 125 miles away. Up to 99 stations can be simultaneously measured and various data windows can be viewed on the same screen.

For more information contact Auditem in France at +33-557-928-928; fax +33-557-928-929; e-mail [auditem@audemat.com](mailto:auditem@audemat.com) or circle Reader Service 107.

## Modulation Sciences

The ModMinder from Modulation Sciences is a digital device for measuring, displaying and analyzing peak FM deviation. It processes modulation information digitally using an 80C88 microprocessor.

The unit provides a simple front-panel display of modulation information as well as remote control and data transfer capabilities. Interface to a conventional broadcast remote control is provided by relay contacts and slowly varying DC signals. The ModMinder functions with any wide-band demodulator, high-quality tuner or with the company's internal RF demodulator card.

When in "FCC Mode," the unit ignores brief overshoots that contain little power.

Because of this, the average modulation can be raised or the amount of processing can be reduced. Typical modulation improvements range from 1 to 4 dB.

Several displays are utilized with this system. The Peak Modulation display shows the highest peak attained during the previous second on a three-digit numerical display. With the Overmod display, a red LED lights for one-quarter of a second every time the preset overmodulation threshold is exceeded. During audio failure, a red LED is lit; any total loss of dynamic range triggers this alarm during and after the preset waiting period.

For more information contact Modulation Sciences in New Jersey at (732) 302-3090; fax (732) 302-0206 or circle Reader Service 185.

## FM Systems

FM Systems offers the SPM-1 stereo performance meters for measuring stereo separation in source program audio content. The SPM-1 meters are ideal for measuring stereo mid-down and left/right blending, and setting them to consistent, repeatable standards.

In addition to measuring stereo separation of program material, the SPM-1 can measure the stereo separation of recording and playback, stereo multiplexing and transmission channels using actual program signals as well as with test tones.

The display is a bar graph calibrated in 1 dB increments. It may be placed atop the VU meters on the console or incorporated into the VU meter display panel. Field tests may be performed on FM stations by connecting the SPM-1 to an FM receiver. At the audio console, the operator can track the stereo separation of the program being transmitted at that time.

For more information contact FM Systems in California at (714) 979-3355; fax (714) 979-0913 or circle Reader Service 133.

## Logitek

The MON-10 multi-source meter/monitor from Logitek routes any of ten stereo inputs to a single stereo output, while directing the selected input to a multi-range meter, a 6 W speaker and a front-panel stereo headphone jack.

Once an input is selected, the user can choose the left (A) or right (B) channel, the mono sum (A + B) or the out-of-phase sum (A - B) to feed the meter. The headphones are fed stereo signal (A and B) and the monitor speaker is fed the mono sum.

Line output switching is passive so the output level impedance and balancing is the same of the selected input. The unit features wire-capturing terminal blocks as connectors.

For more information contact Logitek in Texas at (800) 231-5870; fax (713) 782-7597 or circle Reader Service 159.

# Create. Communicate. Innovate!

You do it every day.  
How can you do it better?

**NAB99** NAB99 is your one-stop shop for ideas, innovations and solutions. If you've never been to the NAB in Las Vegas, ask anyone who has and you'll learn just how much there is for Radio! Regardless of your market size or your role in your station, there's something for you. Explore the convergence markets and uncover new opportunities.

Celebrate creativity. Spark innovation. Discover real business solutions. And decide what technology, products and services to buy, and from whom -- all in one place, all at one time.

*This is the power and spirit of NAB99!*

**Start planning today!**

[www.nab.org/conventions/](http://www.nab.org/conventions/)

Or call 1.800.342.2460

or 1.202.429.4194



April 18-22, 1999  
Exhibits/April 19-22  
Las Vegas  
Nevada/USA

# Radio World

## Broadcast Equipment Exchange

"Broadcast Equipment Exchange" accepts no responsibility for the condition of the equipment listed or for the specifics of transactions made between buyers and sellers.

### ACOUSTICS

Want to Sell

## ACOUSTIC FOAM

Broadband Absorbers • Modular Systems • Sound Barrier • Diffusers • Bass Traps & More!  
We can solve any sound problem & we're the hands down value leader! That's why so many famous users trust Auralex...so should you! Our line is available through major broadcast suppliers, so pick up the phone & call today for your free sample & info kit!

**Auralex**  
ACOUSTICS  
317-842-2600  
Fax 317-842-2760  
www.auralex.com

Circle (234) On Reader Service Card

### AcousticsFirst™

Toll Free 888-765-2900

Full product line for sound control & noise elimination.  
www.acousticsfirst.com

### AMPLIFIERS

Want to Sell

Anchor AN1000 powered monitor speaker, 50 W w/manual & cables, new cond, \$550/pr; Melcor AB-49 100 W SS power amp, 4, 8, 16 ohm, 3.5" RM, gd cond, \$100; Sound Design/3M SP-60 60 W PA amp input for 2 mics & music output of 8 ohm, 25/70V w/manual, new cond, \$100. L Zieglermeier, 201-501-0088.

### ANTENNAS/ TOWERS/CABLES

Want to Sell

S.W.R. FM Antennas  
Great Antenna  
Great Price!



**HALL** Electronics (804) 984-4255

ERI 1105 7-bay FM CP antenna, tuned to 92.7, \$3000/BO; Comark/Cablewave CFM-LP 3-bay FM CP antenna w/radomes, tuned to 94.3, used as backup, \$1500/BO. L Fuss/K Harnack, 601-846-0929.

ERI 3 bay ring stub FM antenna w/mounting hardware, \$1600; ERI 8 bay ring stub FM antenna w/mounting hardware, \$3600, both on ground, pick up or pay shpg. M Casey, 803-275-4444.

Bogner 16B00 top mount antenna, 4 yrs old, on ground, BO; Scala 4DR panel antenna (8), BO; Cablewave 1-5/8 transmission line, 370' air line w/2 EIA flanges, \$1000. R Tanner, 419-224-8867.



**ICE KRACKERS, INC.**  
Inexpensive permanent protection of guy wire anchor hardware from guy wire ice slides.  
Average cost \$400 for 400-foot tower.  
ICE KRACKERS sized by guy wire diameter.  
All sizes available.  
273 Circle Drive, Springfield, IL 62703  
(800) 747-8921  
Ask for Jim Newbanks

Piroid 24" face, 205' w/lighting, 2 yrs old on ground, \$10,000. J Fuller, 401-539-1180.

### 3" HELIAX STANDARD COAXIAL CABLE

50-Ohm, unused, cut to length. Priced below market. Shipped instantly.  
Call Basic Wire & Cable  
(NANCY) 800-227-4292  
FAX: 773-539-3500

FUN, 9' MW Antennas 500Khz-2Mhz Tunable. PT15, TIS, 160M \$139 +shipping. Helixing Inc., POB 804, Lockport IL 60441.



**TOWER SITE REQUIREMENTS**  
We make custom  
FCC Antenna Structure  
Registration Signs  
Guy Wire ID Warning Balls  
Fence CAUTION signs with your message  
Road entrance sign with Co. & phone No.  
Antenna ID Tags for Tenants  
CALL FOR FREE INFORMATION  
**610-458-8418**

### AUDIO PRODUCTION

Want to Sell

Altec 1567A tube type mixer, 4 mic, 1 line inputs, w/plug in transformers, in wood case, \$1200. E Duellman, 920-468-4100.

Lang PEQ-2, excel cond. A Polhemus, 212-302-9010.

Sansui PCM converter, \$500; Burwen DNF1201 noise filter, \$200; Shure AMS8000 mic mixed, 8 chnl, \$1500/trade for studio gear. M Hughes, 301-962-6823.

ANTEX AUDIO CARDS, will not be undersold. A.S.C. (619) 523-1575.

### AUTOMATION EQUIPMENT

Want to Sell

Cartworks Digital Audio System w/switcher, \$2750/BO; Mueller TS-25/35 tone decoder, like new, \$175. L Fuss/K Harnack, 601-846-0929.

### BUSINESS OPPORTUNITIES

#### PRODUCE Host your

Call Ken... own  
212-740-1050 radio show  
Generate hundreds of qualified leads  
50,000 W NYC radio station

### Advertise!

Call your advertising representative  
**703-998-7600**  
for details & deadlines

### CART MACHINES

Want to Sell

Harris cart machines (3), mono, \$50 ea. L Fuss/K Harnack, 601-846-0929.

ITC Delta (2), stereo PB, vgc, \$375 ea/\$700 pr. T Gontarski, 215-340-1777.

Tomcat triple rack mounts, mint, 2x3 units, \$1000 ea; Tomcat Master record deck, rack mount (2), mint cond, \$1000 ea. W McAllister, 407-933-6594.

### COMPLETE FACILITY



**Picture This: Your 1999 Complete Equipment Dealer**

\* Experienced Professionals  
\* RF and Studio Packages  
\* Personal Service \*  
New Stations and Rebuilds

Your Project is Important to Us

Atlantic Media Broadcast  
Call - Rick Johnson -

\* Toll Free \* 888-744-6635  
email - rick@cstone.net  
**?Vegas?**  
Let's get together!

### CONSOLES

Want to Sell

Ramsa WR-8210A, 10x4x2 mixer, ea chnl has 3 selectable inputs, 3 band sweepable EQ, 2 pre- or post-fader aux sends, insert in/out, direct out, \$1300/BO; Quantum QM8P vintage 8x4, some stereo chnl, 3 band EQ, +4, \$1500 or trade for rcdrg gear. M Hughes, 301-962-6823.

RCA 10 chnl console, great for parts or restoration, \$450; Cetec Sparta A-15B 5 chnl mono console w/pwr supply, \$200. L Fuss/K Harnack, 601-846-0929.

Harris stereo 8 chnl & LPB stereo 8 chnl, both in gd cond, \$800 ea/BO. J Lalino, 315-891-3110.

MCI/Sony 618, 24x24, \$6.5K; Quantum 24x24, \$4.5K; Soundcraft 600, 32x16, \$5.5K, like new; Model 30, \$295; 512, \$950; 520, \$1450. W Gunn, POB 2902, Palm Springs CA 92263. 760-320-0728.

Want to Buy

LPB Signature C10-5, 10 mixer dual stereo, Citation mdl, excel cond, \$3500 +shpg. R Osborne, 304-273-2544.

Soundworkshop 40 for parts, modules or console. A Polhemus, 212-302-9010.

### DISCO-PRO SOUND EQUIP

Want to Sell

JBL 2482 2" drivers (2), \$560; (2) JBL 2328 throat adapter for 2" to large radials, \$60/pr; (2) JBL 2350, 90x40 degree bi-radial horn, \$275/pr or trade for studio gear. M Hughes, 301-962-6823.

Conn trombone, mouthpiece, HDS case, \$75. W Dougherty Jr, 573-998-2681.

### LIMITERS

Want to Sell

Orban 414A stereo compressor, \$500 or trade for studio gear. M Hughes, 301-962-6823.

Orban 418A FM audio processor w/selectable pre-emphasis input, output, gain reduction meter, 2 space rack mount, excel cond, \$300. C Marion, 215-289-8295.

Gates M5167 Sta-Level tube type AGC, works, fair cond. E Duellman, 920-468-4100.



**HALL Electronics**  
706 Rose Hill Dr. Charlottesville Va. 22901  
804-984-4255 (Voice) 804-984-3299 (Fax)

This Month's Special !!  
**BSI** Broadcast Software International  
Broadcast Automation Software  
JUST \$999 List  
Turnkey Systems Starting at \$2995  
Call or visit our web site for your discount price  
sales@halls.com www.halls.com tech@halls.com

Circle (233) On Reader Service Card

Want to Buy

Tube limiter for studio. M Hughes, 301-962-6823.

CRL 3 part AM system w/APP 400 processor, SEP 400A processor, PMC 300A peak controller & Radio Design Labs NRSC system, \$1000/BO. R Miller, 808-572-5534.

RCA BA-86 or BA-6 in repairable cond or better. M Schackow, 605-374-3424.

Teletronix LA-2A's, UREI LA-3A's & LA-4's, Fairchild 660's & 670's, any Pultec EQ's & any other old tube compressor/limiters, call after 3PM CST, 972-271-7625.

### MICROPHONES

Want to Sell

Neumann UM-57 tube M-7 capsule, remote switching, \$2000/ea; Neumann CMV-563 tube M-7 capsule, orig P/S & cables, \$2100/ea; Telefunken M221B tube 934B capsules, orig P/S & cables, \$2200/pr; Neumann SM69 tube/FET, one SM69 tube, two SM69 FETs, orig P/S, cables, \$2300-2700. F Danner, 781-294-1218.

Prof mic shock mount w/extra elastic bands, fits handheld sized mics, new, \$20. W Dougherty Jr, 573-998-2681.

RCA 77-DX's & 44-BX's, any other RCA ribbon mics, on-air lights, call after 3PM CST, 972-271-7625.

RCA 77-DX's, 44-BX's, WE KU-3A's On-Air lights, recording lights. Top price paid. Fast response. Bill Bryant Mgmt, 2601 Hillsboro Rd, G12, Nashville TN 37212. 615-269-6131, FAX: 615-292-3434.



**WINDSCREENS**  
The Auralex WIND JAMMER 2421  
AVAILABLE THROUGH MAJOR BROADCAST SUPPLIERS  
\* Fits RE20, MD421, AKGs, A1s, big Neumanns, etc!  
\* Cost up to 63% less than competing brands  
\* Won't crumble like other brands  
\* Sounds great & available in 6 vivid colors  
**1-800-95-WEDGE**

Want to Buy

Sennheiser MD431 vocal mic, new demo, \$325; Sony ECM16 guitar lavalier 125, ECM16T electret condenser lavalier mic, \$125; F99LT one point stereo dynamic mic, mini jack new/demo, \$99; ECM33P w/windscreen, condenser, \$170; Shure Prologue 10HLC (3), \$39 ea; Prologue 12HLC, \$59 ea; TEAC ME15 electret condenser w/box, \$75; Tele-dyne 341 condenser (4), \$75 ea; Phillips 8200 lavalier condenser mic 200 ohms (2) one new, one new demo, \$75 ea; Knight 100; EV PL9, \$90; PL95, \$100 CO85 condenser lavalier minus element, \$100; Crown CM300 differoid, \$200. M Hughes, 301-962-6823.

RCA 77DX, TV finish, original carry bag w/manual, excel cond, \$1200. M Schackow, 605-374-3424.

Neumann U47, \$3900; U67, \$3300; U87, \$1800; KM83 or 84 pairs, \$1400; KM88s, \$950 ea; RCA 77DX, \$1200; BK5, \$700; BK1A, \$300. W Gunn, POB 2902, Palm Springs CA 92263. 760-320-0728.

Want to Buy

Tube or ribbon mic for studio. M Hughes, 301-962-6823.

RCA 77-DX's & 44-BX's, any other RCA ribbon mics, on-air lights, call after 3PM CST, 972-271-7625.

RCA 77-DX's, 44-BX's, WE KU-3A's On-Air lights, recording lights. Top price paid. Fast response. Bill Bryant Mgmt, 2601 Hillsboro Rd, G12, Nashville TN 37212. 615-269-6131, FAX: 615-292-3434.

### MISCELLANEOUS

Want to Sell

Onan electric plant, older but working, 25 kW, 3 phase gen, diesel engine, BO. R Haag, 605-665-7442.

MISC cont....

**RF Warning Signs**  
 9"x 12" \$13.95  
 10"x 19" \$19.95  
  
**HE HALL Electronics** (804) 984-4255

**ROTRON BLOWERS AND PLATE BLOWERS** new & rebuilt for Elcom, Harris, CCA, CSI, McMartin. Goodrich Ent. 11435 Manderson St, Omaha, NE 68164 402 493 1886 FAX 402 493 6821

**Gentner G2500 Super Hybrid.** \$950. Gentner Tele-Switch \$350, both items like new. S Kirsch, 516-763-1776.

**Want to Buy**

**UTC transformers, WE 111C** repeat coils. Triad R6A pwr transformers: MXR effects rack modules, UREI compressor. tube echo unit. panning device. M Hughes, 301-962-6823.

**Service manual on PE-197** military AC generator. F Shetler, WMGM/WOND, 133 Buffalo Ave, Egg Harbor City NJ 08215-1921.

**Jazz record collections, 10" LP/12" LP** be-bop, swing, dixie. highest prices paid. B Rose, Program Recdgs, 228 East 10th, Nyny 10003. 212-674-3060.

**MONITORS**

**Want to Sell**

**Belar FMM-1 mod mon** tuned to 103.5 & Belar FMS-1 stereo monitor, \$850/BO; Belar RFA-1 FM RF amp tuned to 103.5, \$250/BO or all for \$1000. L Fuss/K Harnack, 601-846-0929.

**Belar FMM-1 mod mon** tuned to 92.7 & Belar FMS-1 stereo monitor, \$850/BO; Belar RFA-1 FM RF amp tuned to 92.7. cracked meter but otherwise OK, \$225/BO or all for \$975. L Fuss/K Harnack, 601-846-0929.

**Belar RFA-2 AM RF amp** tuned to 1450 kHz, \$250. L Fuss/K Harnack, 601-846-0929.

**General Radio 457-A mod** monitor, 1920's, in wood case with hinged lid. E Duellman, 920-468-4100.

**Used Mod Monitors,** McMartin & Belar. Many to choose from, tuned & calibrated on your frequency. full guaranteed. Goodrich Ent. 402-493-1886.

**RECEIVERS & TRANSCEIVERS**

**Want to Sell**

**SCA RECEIVERS—ALL TYPES**

*Will work to meet your receiver needs*

Professional / Table / Portable  
 Field Strength Meters  
 Reading Service / Ethnic / Data

**DAYTON INDUSTRIAL CORP.**

2237 Industrial Boulevard  
 Sarasota, FL 34234-3119  
 Tel: 941-351-4454 FAX: 351-6081  
 E-Mail: SCARadio@aol.com

**Comrex 2-line freq extender,** xmtr & rcvr, \$1995 for both ends. Steve Kirsch, 90 S Long Beach Rd, Rockville Centre NY 11570. 516-763-1776.

**RECORDERS**

**Want to Sell**

**DAT Machine Service**  
 Digital Audio Tape

Fast, expert repairs on all DAT recorder brands & models including ADAT and DA-88

Warranty Service on Most Brands

Over 3000 Machines Serviced!

New/Refurbished DATs Available

Compare Our Rates!

**Pro Digital Inc.**  
 DAT Recorder Service Specialists  
 (610) 353-2400

**Tascam 32 2 trk r-r 700,** tweaked, aligned, great cond, \$800/trade for studio gear; Fostex 80 8 trk, in box. low hrs, \$1000/trade for studio gear. M Hughes, 301-962-6823.

**Otari 5050 BII, 15-7.5 ips** prof tape deck, low hrs. vgc, \$800. J Dentici, 205-271-2900 x2017.

**IF YOU NEED PARTS FOR AMPRO-SCULLY CONSOLES CART RECORDERS call SEQUOIA ELECTRONICS**  
 1-(408) 363-1646  
 FAX 1-(408) 363-0957

**HEAD RELAPPING/ REPLACEMENT**

All tape and film formats  
 30 years experience



350 N. Eric Drive  
 Palatine, IL 60067  
 800-227-4323

**Sharp stereo cassette deck,** rec metal & high bias tape, tape counter, FL meters. works gd, \$50; Marantz SD155 stereo double cassette deck with high speed dubbing, \$140. W Dougherty Jr. 573-998-2681.

**STUDER REVOX PARTS/SERVICE**

Cassette-CD-Open reel  
 Capstan resurfacing. ALL BRANDS.  
**JM TECHNICAL ARTS**  
 1515 Elm Hill Pike #203  
 Nashville, TN 37210 (615) 365-9030

**Ampex 4 trk tube deck.** \$2500; stereo 351 (recond), \$1800; Akai Adam. new, digital 12 trk, \$3500; MM1000-16 w/new heads. \$4500; Otari MTR10-4, \$3500; Ampex ATR102s, search to cue, \$495; Ampex locator for ATR or 1200, \$895; MCI 110C-8. \$3.5K; Tascam 85-16 recond w/dbx. rc & loc, \$3K. W Gunn, POB 2902, Palm Springs CA 92263. 760-320-0728.

**Sony PCM-F1 vintage digital** recorder, vgc + companion SL2000 Beta VCR, slow rewind, \$150/all +shpg. T Gontarski, 215-340-1777.

**Want to Buy**

**Inovonics 375 or 370 R/P** electronics; also RCA RT-21 electronics. D Dintenfass, 206-784-6963.

**Need parts, accessories, etc** for Revox A-77, TEAC A3300. Otari 5050 & other pro r-r equip for blind radio reading service. R Patterson, 215-922-0250.

**Ampex ATR100 taperecorders** for parts. Circuit cards, heads, motors. machine parts, or electronic parts. Call 818-907-5161.

**Ampex PR10 tape recorders.** W Gunn, POB 2902. Palm Springs CA 92263. 760-320-0728.

**REMOTE & MICROWAVE**

**Want to Sell**

**TFT 7700B composite STL** xmtr & companion rcvr, 950.0 MHz, type-accepted, \$3000; TFT 770B composite STL xmtr & companion rcvr, 944.5 MHz, type-accepted, \$3000. L Fuss/K Harnack. 601-846-0929.

## CONSULTANTS

**EVANS ASSOCIATES** Consulting Communications Engineers  
 FCC Applications, Design, Field Engineering & Tower Detuning  
 Video/Data/Voice • Statewide Networks • Wide-Area Networks  
 EXPERTS IN:  
 TV • AM • FM • ITFS • MICROWAVE • PCS • FIBER  
 210 S. Main St., Thiensville, WI 53092 (414) 242-6000 FAX (414) 242-6045  
 Internet: http://www.avansassoc.com Member AFCCE

**Consulting Communications Engineers EMC Test Lab**  
 • FCC Applications and Field Engineering  
 • Frequency Searches and Coordination  
 • AM-FM-CATV-ITFS-LPTV  
 • EMC Test Lab-FCC and European (IEC)  
  
**OWL ENGINEERING, INC.**  
 1-800-797-1338 Fax (612) 785-4631  
 8899 Hastings St NE, Minneapolis, MN 55449 (612) 785-4115 Member AFCCE

**PC - SOFTWARE**  
 AM FM TV Search Programs  
 Signal Mapping—STL Paths  
 RFHAZ—US Census PopCount  
 FAA Tower—Draw Tower  
**Doug Vernier**  
 Engineering Consultant  
 1600 Picturesque Drive  
 Cedar Falls IA 50613  
**800-743-DOUG**

**WE RENT**  
**TELOS ZEPHYR**  
**CCS "Prima" Codex**  
 Frank Grundstem  
 Audio/Video Consultants  
**COMREX**  
 3 line extender  
 610-642-0978

Comrex 2xP encoder. \$650.  
 Tom, 1-800-860-9771.

**WE RENT FOR LESS**  
 Hotlines FM Exciters  
 Zephyrs STL's  
 Nexus FM Pwr Amps  
 Audio Test Equipment  
 If we don't have it, we will get it!  
**SCMS, INC. (800) 438-6040**  
 "You Know We Know Radio"

**Fairchild Dart 384 sat rcvr** w/down converter, 15 kHz dual audio card, excel cond, \$1200; Moseley MRC 1600 remote control, excel cond, \$1000. D Wootala. 626-947-3220.

**T. Z. Sawyer Technical Consultants**  
 AM-FM-TV-LPTV  
 • FCC Applications & Exhibits • Frequency Studies  
 • Experimental Authorizations • Class Upgrades  
 • AM Directional Antennas • STL Applications  
 • High Power Antenna Arrays • Station Inspections  
**1-301-913-9287**  
 FAX: (301) 913-5799 • 5272 River Rd. #460 • Bethesda, MD 20816

**MLJ**  
 Moffet, Larson & Johnson, Inc.  
 Consulting Telecommunications Engineers  
 1110 North Glebe Rd. #900  
 Arlington, VA 22201  
 (703) 741-3500  
 FAX: (703) 741-0312  
 www.mlj.com  
 Member AFCCE

**dataworld**  
 Market Analysis  
 Engineering Software  
 Ethnic/Demographic Data  
 Custom Full-color Mapping  
 Sales Marketing Packages  
 www.dataworld.com info@dataworld.com  
 800-368-5754 fax: 301-656-5341

**Where In The World Are You?**  
 Reach radio professionals worldwide by advertising in Radio World's international edition.  
 Call for more information.  
**703-998-7600**

**MULLANEY ENGINEERING, INC.**  
 Consulting Engineers  
 • Design & Optimization of AM Directional Arrays  
 • Analysis for New Allocation, Site Relocation, And Upgrades AM-FM TV LPTV  
 • Wireless Cable (MDS/MMS/ITFS/OFS)  
 • Environmental Radiation Analysis  
 • Field Work  
 • Expert Testimony  
 9049 Shady Grove Court  
 Gaithersburg, MD 20877  
 Phone: (301) 921-0115  
 Fax: (301) 590-9757  
 email: mullengr@aol.com

**E. HAROLD MUNN, JR. & ASSOCIATES, INC.**  
 Broadcast Engineering Consultants  
 AM - FM - TV  
**THE BROADCAST ENGINEERING CONSULTANTS**  
 Box 220, 100 Airport Rd.  
 Coldwater, MI 49036  
**517-278-7339**

**GRAHAM BROCK, INC.**  
 BROADCAST TECHNICAL CONSULTANTS  
 Full Service From Allocation to Operation AM-FM-TV-ATX Services.  
 Field Work, Antenna and Facilities Design  
 Over 35 years engineering and consulting experience  
**912-638-8028**  
**202-393-5133**  
 www.grahambrock.com

**System One Communications**  
 Broadcast Constructors & Consultants  
 Houston, Texas  
**888-625-5649**  
 Complete Turnkey Construction  
 Antenna Line Testing  
 AM Directional Field Work  
 AM and FM Applications  
 Tower Services  
 Studio Designs  
 Custom Studio Furniture

**R. MORGAN BURROW, P.E. & ASSOCIATES, P.C.**  
 ALLOCATION STUDIES  
 FIELD WORK A SPECIALTY  
 • AM/FM Allocation • AM/FM STL Allocation  
 • AM/FM STL Allocation • AM/FM STL Allocation  
 • AM/FM STL Allocation • AM/FM STL Allocation  
 • AM/FM STL Allocation • AM/FM STL Allocation  
**ELECTROACOUSTICS**  
 301-948-3844 • Fax 301-330-5565

**C.P. CROSSNO & ASSOCIATES**  
 CONSULTING ENGINEERS  
 P.O. BOX 180312  
 DALLAS, TX 75218  
**AM, FM & TV Broadcasting**  
 ANTENNA DESIGN, ALLOCATIONS, FCC/FAA  
 CHARLES PAUL CROSSNO, PE  
 (214) 321-9140 MEMBER AFCCE

**EME COMMUNICATIONS**  
 Consulting Engineer  
 AM-FM-TV-LPTV  
 FCC APPLICATIONS • STATION SERVICE  
 FREQUENCY SEARCHES • FIELD STRENGTH METER  
 CLASSIFICATION • FACILITY CONSTRUCTION  
 REGULATORY INSPECTIONS • SITE ANALYSIS  
 912-890-2506 912-985-0864 FAX  
 www.emecom.com

Without Advertising  
 a Terrible Thing Happens . . .  
  
**. . . NOTHING**

**MORE EQUIPMENT**

**RENTAL EQUIPMENT**  
 COMREX Vector, Hotline, ISDN codecs  
 TELOS Zephyr, Zephyr Express, digital hybrids  
 MUSICAM Prima 120 and 230

**MORE EXPERIENCE**

**Silver Lake Audio**  
 516 763-1776  
 fax 516 763-1750  
 internet: silverlakeaudio.com

- Remote Audio Packages
- Mixers
- Microphones

**Want to Buy**

Gentner 1000 remote control for xmtr. D Swanson, 712-252-4621.

**SATELLITE EQUIPMENT**

**Want to Sell**

Scientific Atlanta 7300 wideband BPSK rcvr, \$500; Scientific Atlanta 7325 digital processing unit, card cage, w/1 7.5 kHz DATS card & 1 15 kHz DATS card, \$750 or both for \$1200; Comstream ABR-100 rcvr, \$600. L Fuss/K Harnack, 601-846-0929.

Comstream ARB 200 dig audio rcvr, like new, \$1200/BO. J Lalino, 315-891-3110.

**For details on space availability contact Simone at 703-998-7600**

**SOFTWARE/DATABASES**

**RadioSoft**

**RF Mapping Software**  
 109 W Knapp Ave.  
 Edgewater, FL 32141  
 888-723-4695  
 www.radiosoft.com

**ADVERTISE!**  
 703-998-7600  
 call now!

**STEREO GENERATORS**

**Want to Sell**

50 kW 3 phase gen currently running on natural gas w/spare carburetor, 1940's Minneapolis-Moline in excel cond w/custom controller, wired to 120/208Y, can be rewired to 240/440/660, buyer removes & pays shpg, BO. C Allen, 785-263-1263.

Potomac Instruments test equipment from broadcast engineering business: VHF field strength meter FIM-71 with carrying case, AC adapter, manual; AT-51 audio test system including AA-51 audio analyzer and AG-51 audio generator with manuals. Excellent condition. Call Bill Marshall (814) 454-2792 after 3:00 PM EST.

**TUBES**

**Want to Sell**

**AMPEREX, EIMAC, RCA, SVETLANA** 3CX400A7/8877, 3CX3000A7, 3-500ZG, 4CX250B, 4-400, 4CX400A, 807, 833C, ETC. Westgate 800-213-4563.

**D & C Electronics Co.**

**NEW TUBES**

We have the alternatives for all your needs, at the lowest prices, direct from OUR STOCK!!!  
 EIMAC, SVETLANA, PRO-TEK®, EEV and many others.  
 (352) 688-2374  
 PH: (800) 881-2374  
 FAX: (352) 683-9595

SE HABLA ESPAÑOL WE EXPORT  
 VISA MASTERCARD ACCEPTED

**ECONCO**

**Quality Rebuilt Tubes**  
 Approximately 1/2 the Cost of New

Call for Our Price List

**800-532-6626**  
**530-662-7553**

**FAX 530-666-7760**  
 Circle (230) On Reader Service Card

**FOR THE BEST PRICE**  
 & 24 Hr service on transmitting tubes & sockets/parts, new & rebuilt call Goodrich Ent. at 402-493-1886 day or night, FAX 402-493-6821

**SATELLITE SYSTEMS**

Satellite Equipment for Radio

**Off the air? Looking for reliable repair service?**

**Rely on us!**  
 Satellite Systems is respected industry-wide for prompt, accurate service to radio stations and networks. Whether you have a Dart 384 or Scientific Atlanta 7300/7325 we can repair your equipment. Pre- and post-service technical support, along with a 6-month warranty. Turn to the leader in repair, new equipment, used equipment and accessories. We can answer all your questions.

**Celebrating 7 years of providing reliable repair service**  
**SATELLITE SYSTEMS**

615 East Brookside Street, Colorado Springs, CO 80906  
 Phone: (719) 634-6319 Fax: (719) 635-8151

Circle (232) On Reader Service Card

**STUDIOS**

**INSTALLATIONS & FABRICATION**  
 STUDIO & CONTROL ROOM  
 40 YRS OF QUALITY WORK  
 CAD DESIGN  
 CLOYD PETERSON  
**SHOWTECH**  
 1-813-886-8246  
 FAX 1-813-963-6481

**TAPES/CARTS/REELS/CD'S**

**Want to Sell**

Used carts, 10.5" empty reels, \$1; other various, \$.50. J Lalino, 315-891-3110.

**TAX DEDUCTIBLE**

High school radio station seeks donations of audio & RF equip, AM/FM, for start-up. M Starin, 603-673-4201 x103.

**TELEPHONE EQUIPMENT**

WE BUY AND SELL BUSINESS TELEPHONE EQUIPMENT. DOMINION TELECOM. 800-998-3281.

**TEST EQUIPMENT**

**Want to Sell**

Potomac Instruments FIM-71 Field Intensity meter in excellent condition with Oak carrying case. \$6,750.00. B Bingham (518) 793-7748.

**Portable Audio Generator**

The RX-11 Tone Jack is a battery operated, hand-held portable audio generator.

**FEATURES include:**

- 1 Hz - 29,999 Hz (1 Hz steps)
- Sine and Square wave outputs
- RS-232C controllable
- Store and recall 10 user frequencies
- Log sweep from 50 Hz to 20 kHz
- Tone burst (1 ms to 29,999 seconds)

SLP \$229.00

FOR MORE INFORMATION  
**800-645-1061**

**CONEX ELECTRO SYSTEMS**  
 1500 Carolina Street, Raleigh, NC 27601  
 (919) 734-1177 FAX (919) 734-1199  
 www.conex-electro.com

**Quality Power Tubes**

3CX10.000H3	4CPX800A	5CX1500B	SV572-3
3CX15.000A3	4CX1500A	572B	SV572-10
3CX15.000A7	4CX1600B	6550C (See SV6550C)	SV572-30
3CX15.000H3	4CX3500A	6AS7G	SV572-160
3CX20.000A7	4CX5000A	6BM8	SV6550C
3CW20.000A1	4CX5000R	6D22S	SV6L6GC
3CW20.000A7	4CX7500A	6L6GC (See SV6L6GC)	SV811-3
3CW20.000H3	4CX10.000D	6N1P	SV811-3A
3CW20.000H7	4CX12.000A	811A	SV811-10
3CW30.000H3	4CX15.000A	812A	SV811-10A
4CX250B	4CX15.000J	833A	TH5-4
4CX250BC	4CX20.000A	8161R	TH5-6
4CX250BT	4CX20.000B	8560AS	TH6-3
4CX250R	4CX20.000C	EF86	TH6-3A
4CX350A	4CW10.000A	EL34	YC130/9019
4CX350AC	4CPW10.000R	EL509	SK300A
4CX400A	4X150A	SV83	SK1300
4CX800A	5CX1500A	SV300B	SK1320

**Watch this list GROW!**

• Manufactured in Russia's largest power tube factory • Generous warranty based on high quality • Honest prices based on quality at low cost • Check our Stocking Distributors for best price and delivery

**www.svetlana.com**

Headquarters: 256-882-1344 Fax: 256-880-8077 • Engineering: 650-233-0429 Fax: 650-233-0439

Circle (229) On Reader Service Card

**TUBES, Eimac, Svetlana,**  
 800-430-6683, F(905)844-6263. www.hard-to-find.net; ams@hard-to-find.net.

**RF POWER**

*The Best of Two Worlds!*

**Eimac**  
 Immediate Shipment from Stock

**Svetlana**

Broadcast & Communications Tubes • Transistors • HV Rectifiers  
 Se Habla Español  
 760-744-0500 • 888-744-3500  
 Fax: 760-744-1943  
 e-mail: rfp@rfparts.com  
 http://www.rfparts.com

**RF PARTS**

435 SO. PACIFIC ST. SAN MARCOS, CA 92069

Circle (231) On Reader Service Card

**TURNTABLES**

**Want to Buy**

TURNTABLES, LIMITERS, RECORD CUTTING MACHINES. 612-869-4963.

**Advertise in**

**Radio World**

For Details Call (703) 998-7600

**TODAY!**

**DISTRIBUTOR DIRECTORY**

The following distributors serving the broadcast industry would be glad to help you with any of your requirements.

- CORNELL-DUBILIER MICA CAPACITORS**  
FROM STOCK
- JENNINGS VACUUM CAPACITORS**  
FROM STOCK
- JENNINGS VACUUM RELAYS**
- SURCOM ASSOCIATES**  
2215 Faraday Ave., Suite A  
Carlsbad, California 92008  
(760) 438-4420 Fax: (760) 438-4759  
e-mail: link@surcom.com web: www.surcom.com

...Some people get hooked on broadcast equipment big time...they think about it...dream about it...talk about it all the time...for example...us...  
**RADIO! The beat goes on!**  
**CROUSE-KIMZEY OF ANNAPOLIS**  
 tops in broadcast equipment  
 1-800-955-6800  
 ask for Kathleen  
 kkannapolis@worldnet.att.net

**INEXPENSIVE PC SOFTWARE**  
 for Radio Broadcasters  
 Traffic, Billing, Accounting & Music Scheduling  
 (941) 643-3689  
 www.aba-software.com  
 email: demo@aba-software.com

**STATIONS**

**Want to Sell**

500 Watt AM Sunrise to Sunset Daytimer, New Transmitter, Studio Satellite Automated, \$75,000  
 Bartlesville OK. 1-800-541-9587.

**Want to Buy**

Network looking for stations! dark, brokered, AM & FM, fax details to programming: 954-735-0370.

Advertise in **Radio World**  
 For Details, Call 703-998-7600 TODAY!

SERVICES

**SIMPLE CONNECTION**  
Prewired Racks & Console Harnesses

Connect to the Turnkey Distributor...

**BROADCAST RICHMOND**

E-mail broadcast@infocom.com  
Tel 765-966-6468 Fax 765-966-5505  
www.broadcast-richmond.com

**UTAH TOWER CO.**  
COMMUNICATIONS CONSTRUCTION AND MAINTENANCE AM/FM CELLULAR, PCS, TV DIGITAL MICROWAVE ANTENNAS & TOWERS  
SERVING THE WESTERN U.S.  
FAX/PHONE (801) 667-3490  
CELLULAR (801) 368-4809

**ACTION-GRAM**

EQUIPMENT LISTINGS

Radio World's Broadcast Equipment Exchange provides a FREE listing service for radio stations and recording studios only. All other end users will be charged. This FREE service does not apply to Employment Help Wanted ads or Stations For Sale ads. These are published on a paid basis only. Send your listings to us by filling out the form below. Please be aware that it takes one month for listings to appear. The listings run for two consecutive issues and must be resubmitted in order to run again. Thank you.

Please print and include all information:

Contact Name \_\_\_\_\_  
Title \_\_\_\_\_  
Company/Station \_\_\_\_\_  
Address \_\_\_\_\_  
City/State \_\_\_\_\_  
Zip Code \_\_\_\_\_  
Telephone \_\_\_\_\_

Are you currently a subscriber to Radio World?  
 Yes  No

Signature \_\_\_\_\_ Date \_\_\_\_\_

Please check only one entry for each category:

I. Type of Firm  
 D. Combination AM/FM station  
 A. Commercial AM station  
 B. Commercial FM station  
 C. Educational FM station  
 E. Network/group owner  
 L. Consultant  
 N. Delivery Service (Internet/Cable/Satellite)

F. Recording Studio  
 K. Syndicator/Station  
 M. Ind. Engineer  
 G. Audio for Video/TV Station  
 H. Consultant/ind engineer  
 I. Mfg. distributor or dealer  
 J. Other

II. Job Function  
 A. Ownership  
 B. General management  
 C. Engineering  
 J. Promotion  
 H. Programming/production

G. Sales  
 E. News operations  
 F. Other (specify)  
 K. Production Mgt or Staff

Brokers, dealers, manufacturers and other organizations who are not legitimate end users can participate in the Broadcast Equipment Exchange on a paid basis. Line ad listings & display advertising are available on a per word or per inch basis.

WTS  WTB  Category: \_\_\_\_\_ Model: \_\_\_\_\_  
Make: \_\_\_\_\_  
Brief Description: \_\_\_\_\_  
Price: \_\_\_\_\_

WTS  WTB  Category: \_\_\_\_\_ Model: \_\_\_\_\_  
Make: \_\_\_\_\_  
Brief Description: \_\_\_\_\_  
Price: \_\_\_\_\_

WTS  WTB  Category: \_\_\_\_\_ Model: \_\_\_\_\_  
Make: \_\_\_\_\_  
Brief Description: \_\_\_\_\_  
Price: \_\_\_\_\_

WTS  WTB  Category: \_\_\_\_\_ Model: \_\_\_\_\_  
Make: \_\_\_\_\_  
Brief Description: \_\_\_\_\_  
Price: \_\_\_\_\_

WTS  WTB  Category: \_\_\_\_\_ Model: \_\_\_\_\_  
Make: \_\_\_\_\_  
Brief Description: \_\_\_\_\_  
Price: \_\_\_\_\_

\*Closing for listings is every other Friday for the next month's issue. All listings are run for 2 issues unless pressed for space or otherwise notified by lister.  
**Broadcast Equipment Exchange**  
PO BOX 1214, Falls Church, VA 22041 • Tel: 800-336-3045 • Fax: 703-998-2966

TRANSMITTERS

Want to Sell

Bext TEX-20 20 W FM exciter, front panel programmable in 10 kHz increments, clean, just removed from service, \$1800. E Duellman, 920-468-4100.

**OFF THE AIR? EMERGENCY BACK-UP RENTALS**  
FM Exciters - STLs -  
FM Pwr Amps - Antennas -  
Studio & Test Equipment  
SCMS Inc (800) 478-6040  
"YOU KNOW WE KNOW RADIO"

Gates M6095 exciter, 10W tube type FM mono, works on 101.7 MHz, \$150 +shpg. E Duellman, 920-468-4100.

**REBUILT TRANSMITTERS**  
Call  
**ARMSTRONG TRANSMITTERS**  
Ph: 315-615-1269  
Fax: 315-615-9912

Gates FM3H 3 kW FM xmtr w/CSI EX-20F exciter, currently on air at 101.9, exciter is freq agile, operates on 3-phase pwr, \$6000, buyer picks up. L Fuss/K Harnack, 601-846-0929.

Nautel AMPFET ND1, can modulate 150% positive on 1570 kHz, low pwr consumption, manuals & spart parts, excel cond, \$13,000/BO. R Miller, 808-572-5534.

Harris MW-50C 50 kW xmtr in gd cond, \$25,000. J Weitzman, 202-682-3536.

Want to Buy

Harris/Gates MW-1 or MW-1A solid state xmtr for AM back-up. M Heller, 920-794-1800.

McMartin AM/FM xmtr, any model, exciter or stereo modules. Goodrich Ent., 11435 Manderson, Omaha NE 68164. 402-493-1886.

Advertise in Radio World!  
Call 703-998-7600 TODAY!

**TRANSCOM CORP.**  
Serving the Broadcast Industry Since 1978

Fine Used AM & FM Transmitters and Also New Equipment  
For the best deals on Celwave products, Andrew cable and Shively antennas.

- 100 W FM 1985 Harris FM100K
- 100 W FM 1985 Harris FM100K
- 2.5 KW FM 1974 Harris FM 2.5H3
- 2.5 KW FM 1984 Continental 814R1
- 3 KW FM 1985 CSI T3-F
- 3 KW FM 1975 CSI FM300E
- 5 KW FM 1988 Harris FM 5K1
- 5 KW FM 1983 Harris FM 5K
- 5 KW FM 1982 Continental 816R1
- 5 KW FM 1967 Collins 830E
- 5 KW FM 1967 Collins 830E
- 10 KW FM 1962 RCA BTF 10D
- 20 KW FM 1970 Harris FM 20H3
- 25 KW FM 1981 Harris FM 25K
- 25 KW FM 1981 Harris FM 25K

- 1 KW AM 1979 Harris MW1A
- 1 KW AM 1978 Collins 820D1
- 5 KW AM 1980 CSI T-5-A
- 5 KW AM 1978 Collins 828E1
- 50 KW AM 1978 Continental 317C-1
- 50 KW AM 1982 Harris MW-50B
- 50 KW AM 1981 Harris MW-50B

2655 Philmont Ave #200, Huntingdon Valley, PA 19006  
800-441-8454 • 215-938-7304 • FAX No. 215-938-7361  
**FOR INFORMATION AND THE LATEST PRICES...**  
VISIT OUR INTERNET SITE: WWW.TRCORP.COM  
SEND YOUR E-MAIL REQUESTS TO TRANSCOM@TRCORP.COM

Circle (228) On Reader Service Card

**Radio World**

Call Simone Mullins, Classified Ad Manager, to reserve space in the next issue. Use your credit card to pay, we now accept VISA, MASTERCARD, and AMEX.  
5827 Columbia Pike, 3rd Floor  
Falls Church, VA 22041  
PHONE: 703-998-7600 • FAX: 703-998-2966

Select from these categories for best ad positioning:

Acoustics	Consoles	Recorders	Tax Deductible
Amplifiers	Disco/Pro Sound	Remote & Microwave	Test Equipment
Antennas & Towers & Cables	Financial/Leasing Services	Repair Services	Transmitter Exciters
Audio Production (Other)	Limiters	Satellite Equipment	Training Services
Business Opportunities	Microphones	Software	Tubes
CD Machines	Miscellaneous	Stations	Turntables
Computers	Monitors	Stereo Generators	Positions Wanted
	Receivers & Transceivers	Tapes, Carts, Reels & CD's	Help Wanted

**Classified Advertising Rates Effective January 1, 1999**

	1x	6x	13x	26x
1-9 col inch (per inch)	\$79	77	75	72
10-19 col inch (per inch)	\$74	72	70	67
Distributor Directory	\$121	118	115	110
Professional Card	\$84	82	80	76
Station/Studio Services	\$175			
Classified Line Ad				
Blind Box Ad				

\$2.00 per word  
\$15 additional

To compute ad costs: Multiply the number of ad inches (columns x inches) by the desired rate schedule for your per unit cost.

## EMPLOYMENT

### HELP WANTED



### WANT TO EXPAND YOUR RADIO RF SALES?

Join the fastest growing, most advanced radio transmitter manufacturer in the world.

- Hot Products
- Enthusiastic Customers
- "Can-Do" Tech Team
- Dedicated Sales Support

Independent Sales Representatives are needed in certain areas of the United States to sell Broadcast Electronics' radio RF products on an exclusive basis. If you are interested, contact Tim Bealor via phone: 217-224-9600; fax: 217-224-9607; or e-mail: tbealor@bdcast.com.

**Radio is changing. Will you join in or watch from the sidelines?**

*Do you know your stuff?*

Prophet Systems, the leader in digital audio broadcast systems, might be the place for you. Opportunities for tech support, programmers, engineers and sales. Great salary and benefits.

Check out listings on the web: [www.prophetsys.com](http://www.prophetsys.com) or call (308)284-3007.



"nuff said!!"

Team up with the #1 manufacturer of digital music systems. **Scott Studios** is looking for computer specialists with great people skills. Must have in depth knowledge of broadcast operations. Experience must include hardware/software troubleshooting, network installations (Windows/95/NT, Novell, Lan-tastic). Send resume to Scott Studios, Attn: Brian A Chase, 13375 Stemmons Fwy, Suite 400, Dallas TX 75234. Fax: 972-620-2707, E-mail: [brian@scottstudios.com](mailto:brian@scottstudios.com)

**ADVERTISE!**  
703-998-7600  
call now!

### Engineering

Command Audio Corporation, located in Redwood City, is developing an exciting new wireless audio information and entertainment service. See us on the web: [www.commandaudio.com](http://www.commandaudio.com). We have a dedicated team of experienced professionals and are looking for a:

**Technical Maintenance Engineer** to assist in constructing and maintaining broadcast studios and production facilities. Duties include installation, maintenance, and repair of equipment including audio consoles, DAT, minidisk, and cassette recorders, as well as other tools of the broadcasting trade. This position will report to the Director of Operations in assisting editors, producers and the CAC staff with general maintenance of our production facilities.

We seek an individual with a minimum of 2 to 5 years experience in a broadcast environment who possesses knowledge of routine and preventive maintenance, intermediate electronics, audio cable installation, and basic construction skills. Some travel and schedule flexibility will be required.

Command Audio Corporation offers a comprehensive benefits package that includes a stock option program. For immediate consideration, write us at: 101 Redwood Shores Parkway, Suite 100, Redwood City, CA 94065, fax your resume to (650) 631-6155 or email us: [jobs@commandaudio.com](mailto:jobs@commandaudio.com). EOE/mfh

### SALES ENGINEER

Due to promotion, Scott Studios has a rare opening for a sales engineer. Ideal qualifications include:

- Radio station experience
- Broadcast engineering
- Sales background
- In depth computer experience
- Precise with digital drawings
- Ability to juggle multiple projects
- Experience with Scott Studios digital system
- preferred, also knowledge of other systems helpful

Successful candidate will handle technical questions from new customers, create drawings for installation assistance, make presentations at regional SBE meetings, assist with design and setup of convention exhibits, assist sales reps with on-site presentations and demonstrations. This position will also require extensive travel.

This is a demanding position with a high profile company and is Dallas based. Contact David Gerety phone 1-800-SCOTT777 (+109) fax 972-620-8811 or email: [david@scottstudios.com](mailto:david@scottstudios.com)

**ADVERTISE!**  
in **RADIO WORLD'S**  
**BROADCAST EQUIPMENT EXCHANGE**  
CALL  
**703-998-7600**



### POSITIONS WANTED

Broadcast grad ready to hit the radio world running, prod. boards, copywriting, air shifts, will relocate. Craig, 405-527-0033.

Excellent, knowledgeable NYC metro area bdcst meteorologist avail for any market, TV/FM/AM & contract weather broadcasts via ISDN, will relocate anywhere Northeast. Liam 917-372-5426.

# ADVERTISER INDEX

This listing is provided for the convenience of our readers. Radio World assumes no liability for inaccuracy.

Page No.	Advertiser	Reader Service No.	Page No.	Advertiser	Reader Service No.
15	360 Systems	31	48	Inovonics	62
20	Advanced Furniture Systems	25	54	Inovonics	12
44	Altronic Research	118	20	JK Audio	51
3	Armstrong Transmitters	80	25	Klotz Digital	59
11	Arrakis	30	32	Knights Communications Inc	35
22	Arrakis	84	52	Logitek	63
46	ATI	102	41	LPB	24
38	Audio Precision	143	17	Lucent Technologies	83
2	Audioarts Engineering	28	35	Mager Systems	87
58	Auralex	234	55	MicroCon Systems	47
50	Autogram Corporation	124	24	Moseley Associates	33
43	Belar	221	27	Netia	8
46	Benchmark Media Systems	101	55	Nott Ltd.	46
19	Bext	32	49	OMB America	27
50	Boston Financial & Equity	99	26	Orban	85
20	Broadcast Devices, Inc.	26	43	Orban	195
3	Broadcast Richmond	-	39	PR&E	140
47	Broadcast Software Int'l (BSI)	120	31	Pristine Systems	-
41	Broadcast Technology Company	129	33	Pristine Systems	61
55	Broadcast Tools	100	46	Propagation Systems	48
6	BSW	29	20	PTEK	130
18	BSW	6	51	QEI	64
4	Burk Technology	3	46	Radio Design Labs	75
20	Circuit Werkes	78	12	Radio Frequency System (RFS)	56
55	Circuit Werkes	21	36	Radio Systems	10
7	Comrex	55	53	RadioSoft	65
1	Continental Electronics	2	60	RF Parts	231
20	Cortana	52	60	Satellite Systems	232
21	Crown Broadcast	58	14	Scott Studios	5
13	Cutting Edge	82	55	Shively Labs	98
55	Davicom Technologies	73	41	Silicon Valley Power	76
41	Econco	23	45	Sine Systems	144
60	Econco	230	37	Sonic Foundry	117
23	Enco Systems	7	46	Spacewise Broadcast Furniture	22
46	Excalibur Electronics	49	41	Studio Technology	103
55	FirstCorp	72	60	Svetlana Electron Devices	229
46	Freeland Products, Inc.	74	10	Syntrillium Software	4
30	Gentner	86	9	Telos Systems	81
28	Ghostwriters	128	61	Transcom Corp.	228
55	Global Data Inc.	20	41	Weatheradio	77
20	Gorman-Redlich Mfg. Co.	104	28	Webster Audio Products	34
58	Hall Electronics	233	63	Wheatstone	192
41	Halland Broadcast Services	50	64	Wheatstone	218
29	Harris	60	16	Whirlwind	57
28	IBN Radio	127			

Production Director	Lisa McIntosh	Production Assistant	Anastacia Stormetta
Production Manager	Jeff Fisher	Marketing Manager	Heather Harris
Ad Traffic Manager	Kathy Jackson	Ad/Classified Manager	Simone Mullins
Publication Managers	Cristina Strigel, Brien Edenhart	Circulation Director	Sheryl Unangst
Showcase Coordinator	Vicky Baron	Accounts Receivable	Steve Berto

### Advertising Sales Representatives

U.S. Southeast: Simone Mullins, Associate Publisher ..... 1-800-336-3045 ext 154 Fax: 703-671-7409 email: [smullins@imaspub.com](mailto:smullins@imaspub.com)  
 U.S. West: Dale A. Tucker ..... 916-721-3410 Fax: 916-729-0810 email: [RadioRUs@NS.net](mailto:RadioRUs@NS.net)  
 U.S. Midwest & Northeast: Sandra Harvey ..... 703-998-7600 x154 Fax: 765-966-0669 Fax: 765-966-3289 email: [ads4sales@aol.com](mailto:ads4sales@aol.com)  
 Classified Ads: Simone Mullins ..... 703-998-7600 x154 Fax: +1-703-671-7409 email: [ads4sales@aol.com](mailto:ads4sales@aol.com)  
 Germany, Austria: Dagmar Hanle ..... +39-02-7030-0310 Fax: +39-02-7030-0211 email: [smullins@imaspub.com](mailto:smullins@imaspub.com)  
 France: Silvia Di Stefano ..... +33-1-45-48-42-17 Fax: +33-1-45-48-42-19 email: [sdsimas@aol.com](mailto:sdsimas@aol.com)  
 Europe, Africa, Middle East: Raffaella Calabrese ..... +39-2-7030-0310 Fax: +39-02-7030-0211 email: [smullins@imaspub.com](mailto:smullins@imaspub.com)  
 Japan: Eiji Yoshikawa ..... +81-3-3327-2688 Fax: +81-3-3327-3010 email: [callemms@msn.com](mailto:callemms@msn.com)  
 Asia/Pacific: Wengong Wang ..... +852-2787-4727 Fax: +852-2787-4041 email: [imashk@compuserve.com](mailto:imashk@compuserve.com)  
 Latin America: J.O. Lima e Castro ..... +55 (011) 3641-4511 Fax: +55 (011) 3641-4511 email: [Lmccas@uol.com.br](mailto:Lmccas@uol.com.br)

For address changes, send current and new address to RW a month in advance at P.O. Box 1214, Falls Church, VA 22041. Unsolicited manuscripts are welcomed for review: send to the attention of the appropriate editor.

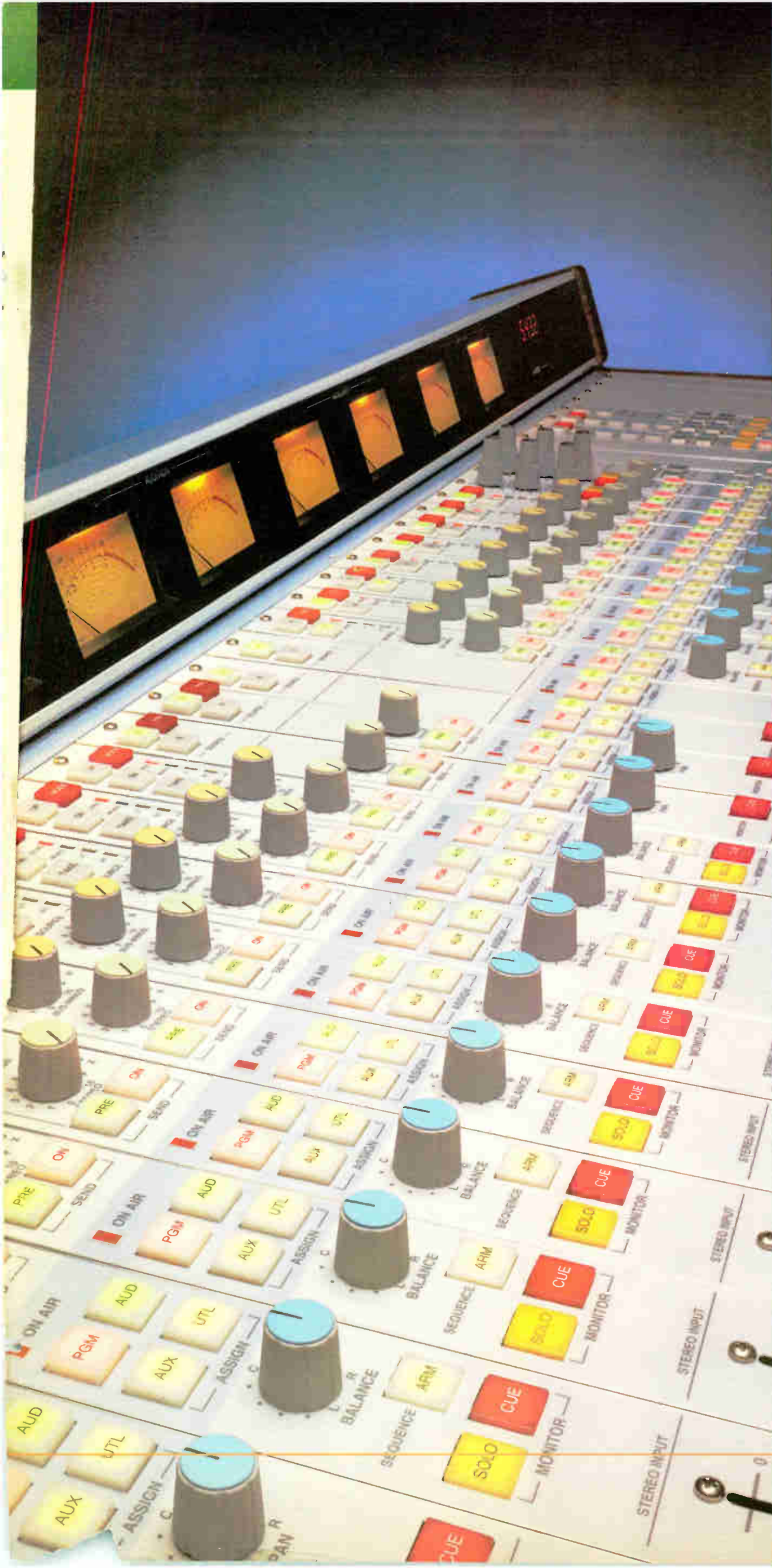

Sometimes  
we have to  
settle for  
what we  
need...

Wouldn't  
you rather  
Get what  
you  
**WANT?**

We've taken the very **best** technology, components and field engineering input to make this the **FINEST** console available.

The **A-6000** is engineered specifically for major markets that demand a lot of attention and need to lead with technical excellence. It's based on an open architecture mainframe that lets you change module locations with **no** restrictions, giving layout top priority and allowing easy reconfiguration as format needs change.

The **Wheatstone A-6000** has the appearance, features and power to excite the most demanding program and production staff; its engineering, performance and thoughtful design will help your personnel achieve broadcasting excellence.

 **Wheatstone**

252-638-7000

Circle (192) On Reader Service Card

