

Radio World



Photo by James Blank, San Diego CVB

**Covering the
Football Playoffs
See Page 3**

Vol 21, No 26

Radio's Best Read Newspaper

December 24, 1997

1997: Radio Trades Rocked On

by Leslie Stimson

WASHINGTON Radio transactions continued their record-setting pace in 1997 with \$17.4 billion in properties changing hands through the end of November for 2,042 transactions, according to BIA Research Inc. That compared to almost \$13.9 billion for 2,208 transactions for all of 1996. Some stations changed hands more than once, and these figures reflect the total dollar value of all transactions.



Stockholders approved the \$5 billion deal merging Evergreen Media Corp. and Chancellor Broadcasting on Sept. 3. Shares of what was the biggest radio-only company (to be called Chancellor Media Corp.) began trading on the NASDAQ on Sept. 8 under the symbol "AMFM." The new Chancellor would acquire properties from Viacom, Gannett, Bonneville and others, for a total of 99 stations (see chart).

Former Viacom President William Figenshu became president of the new

Chancellor Media Corp.

Weeks of rumors that American Radio Systems was in play were quieted with the Sept. 19 announcement that CBS signed an agreement to purchase ARS for \$2.6 billion, expected to close in the second quarter of 1998. The acquisition would leave CBS with about 170 stations.

American Tower Systems, a subsidiary of ARS, will be spun off into a standalone company once the CBS/ARS

purchase closes.

Joining in the tower business was Kline Iron & Steel and OmniAmerica Wireless. Kline sold a third of its business to OmniAmerica, which was formed by Carl Hirsch and Anthony Ocepek, along with group operator Hicks, Muse, Tate & Furst to build and manage broadcast and telecommunications towers. Clear Channel also entered the tower business this year (RW, Aug. 20).

Westinghouse/CBS was renamed CBS Corp. The new company started selling off the former Westinghouse industrial assets with a \$1.5 billion sale of the

See DEALS, page 8 ▶

Top 10 Groups 1996:

COMPANY	'96 REVENUE (millions)	NO. OF STATIONS
GBS Corp.	\$1,013.70	79
Jacor	\$407.125	112
Evergreen Media	\$399.85	42
ARS	\$376.85	93
ABC Radio	\$295.35	21
Clear Channel	\$291.675	101
Chancellor	\$272.35	51
SFX	\$270.45	75
Cox Radio	\$197.675	41
Heftel	\$131.35	37

Top 10 Groups 1997:

COMPANY	'97 REVENUE (millions)	NO. OF STATIONS
CBS Corp.	\$1,384.325	170
Chncllr Media	\$816.20	99
Capstar	\$579.05	325
Jacor	\$557.85	186
Clear Channel	\$408.35	169
ABC Radio	\$306.25	27
Cox Radio	\$216.525	49
Emmis	\$140.25	14
Heftel	\$137.65	37
Sinclair	\$129.15	58

Source: BIA Research Inc.
1997 Revenue is estimated

1996

1997

IBOC Team Advances U.S. DAB Research

by Alan R. Peterson

WASHINGTON While satellite-delivered digital radio moved closer to reality in 1997, proponents of an in-band, on-channel (IBOC) approach to terrestrial digital audio broadcasting spent the year refining the process for another round of tests, which began earlier this month.

The year also saw an agreement between the two in-band proponents jointly to develop suitable technology for an IBOC system. An FM system created by this consortium is being tested in suburban Washington, with a potential round of AM testing only a few months away.

New partners

The original IBOC concept was developed into working systems by USA Digital Radio (USADR) and separately, by AT&T in partnership with Amati Communications. AT&T/Lucent Technologies developed an IBAC solution (in-band, adjacent channel) as well. The IBOC process allows a digital signal to

share an FM analog frequency while maintaining an equivalent coverage area.

Flaws were revealed in 1996; the original USADR system had problems with first and second adjacency interference and multipath, as well as interference to the main frequency. IBOC developers withdrew from field tests in San Francisco and set out to refine their systems.

Results of tests during 1995 and 1996 were used as fuel for debate between proponents of the Eureka-147 plan and the IBOC camp.



In May 1997, RW reported that USADR and Lucent Technologies agreed

See IBOC, page 6 ▶

SATISFY YOUR TASTE FOR THE BEST



Known throughout the world as the best performing, most reliable FM transmitters available, Continental's 816R Series combines superior design and audio quality with exceptional workmanship to give broadcasters an unmatched, field-proven record.

The 816R Series comes in power levels from 10 to 70 kW. Available as an option is an internal control and monitoring unit which tracks trends, stores data and provides an exact visual replica of the transmitter's control panel.

STANDARD FEATURES

- Solid-State IPA
- Internal Harmonic Filter
- Automatic Power Level Control
- Automatic Filament Voltage Regulation
- Exclusive "Soft-Start" Protection Circuit
- Broadband Quarter Wave Cavity
- Totally Self-Contained In a Single Cabinet

For over 50 years, Continental Electronics has provided excellence in broadcast transmission products worldwide. Refuse to compromise... call Continental first!

Continental Electronics Corporation

PO BOX 270879 • DALLAS, TEXAS 75227-0879 • 214-381-7161 • FAX 214-381-3250

800-733-5011

Visit our web site: www.contelec.com



Products in This Issue:

**Four EAS Tools
You Don't Know About**

**Two Sony Portable
MD Recorders**

Fender Passport PA System

And More!

NEWSWATCH

FCC Decides on Broadcast Spectrum Auctions

WASHINGTON In order to clear out a backlog of 1,790 competing radio and TV license applications, the FCC has tentatively decided to auction the licenses.

New FCC Chairman Bill Kennard said the comparative hearing process the FCC used to use to resolve license disputes did not work. He said a case he worked on before becoming FCC general counsel dragged on for nine years. In the budget bill passed this year, Congress mandated the FCC to use auctions for license applications filed after July 1, and to decide cases where there are competing appli-

cants for the same broadcast license.

The criteria the FCC used to use to decide such cases was struck down by the D.C. Circuit Court of Appeals in 1993. In a Notice of Proposed Rule Making passed in late November, the FCC asked for comments on whether some cases should still be decided with comparative criteria, and if women or minorities should be given special consideration in the auction process.

The FCC hopes some broadcasters will choose to settle their cases, rather than continue the process.

Arbitron Expanding to Europe

NEW YORK Ceridian Corp., the parent company of Arbitron, acquired

London-based Continental Research. The purchase gives Arbitron a U.K. base from which to bid for the U.K. radio industry audience research contract tendered by Radio Joint Audience Research. Terms were not disclosed. Continental announced \$5 million in revenues for 1996. British clients include Capital Radio, Classic FM and CNN International.

Enter Those Crystals

WASHINGTON NAB is accepting entries for the 1998 Crystal Radio Awards through Feb. 3, 1998. This will be the 11th year for the awards, given to stations in recognition

of exceptional service to their communities.

The winners will be honored at the Radio Luncheon, Tuesday April 7, during NAB '98 in Las Vegas.

Index

FEATURES

- New Piece of AM Band Awaits**
by W.C. Alexander 18
- Towering Holiday Greetings**
by Troy Conner 19
- A Tale of Two MiniDisc Recorders**
by Frank Beacham 20
- The Right Time to Upgrade**
by Barry Mishkind 20
- Take Your Network Wireless**
by Tom Osenkowsky 22
- Radio, Twisted to Evil Ends**
by John Montone 23
- Robust Modem And Coding Techniques for FM Hybrid IBOC DAB**
by Brian Kroeger & Denise Cammarata 26
- Backing Up: Smoke and 'Mirrors'**
by Ron Burley 31
- Radio Chronicle** 31
- Workbench**
by John Bisset 32
- Remember the British Invasion?**
by Richard O'Donnell 34

RUNNING RADIO

- Karate Hits National Airwaves**
by Dee McVicker 37
- EAS Radios, Tools Are Now Available**
by Gary Timm 37
- Presidential Pitch for Fast Food**
by John Montone 39
- Crucial First-Quarter Promotions**
by Mark Lapidus 43
- Learn the ABCs of EBITDA**
by Dain Schult 45

STUDIO SESSIONS

- Passport P.A. a Hit at Remotes**
by Flip Michaels 47
- Attack Noise With Sound Forge Plug-in**
by Read G. Burgan 47
- A Kind Word to Holiday Airstaff**
by Alan R. Peterson 49
- Neumann 'Volksmic' for the People**
by Ty Ford 50
- No Noise at All With Troy Wall**
by Alan R. Peterson 51
- Pull a Few Strings to Make a Great Spot**
by Gowan Gray 51
- Interactive Radio: On the Way?**
by Mel Lambert 55

Take a LOOK at THIS:

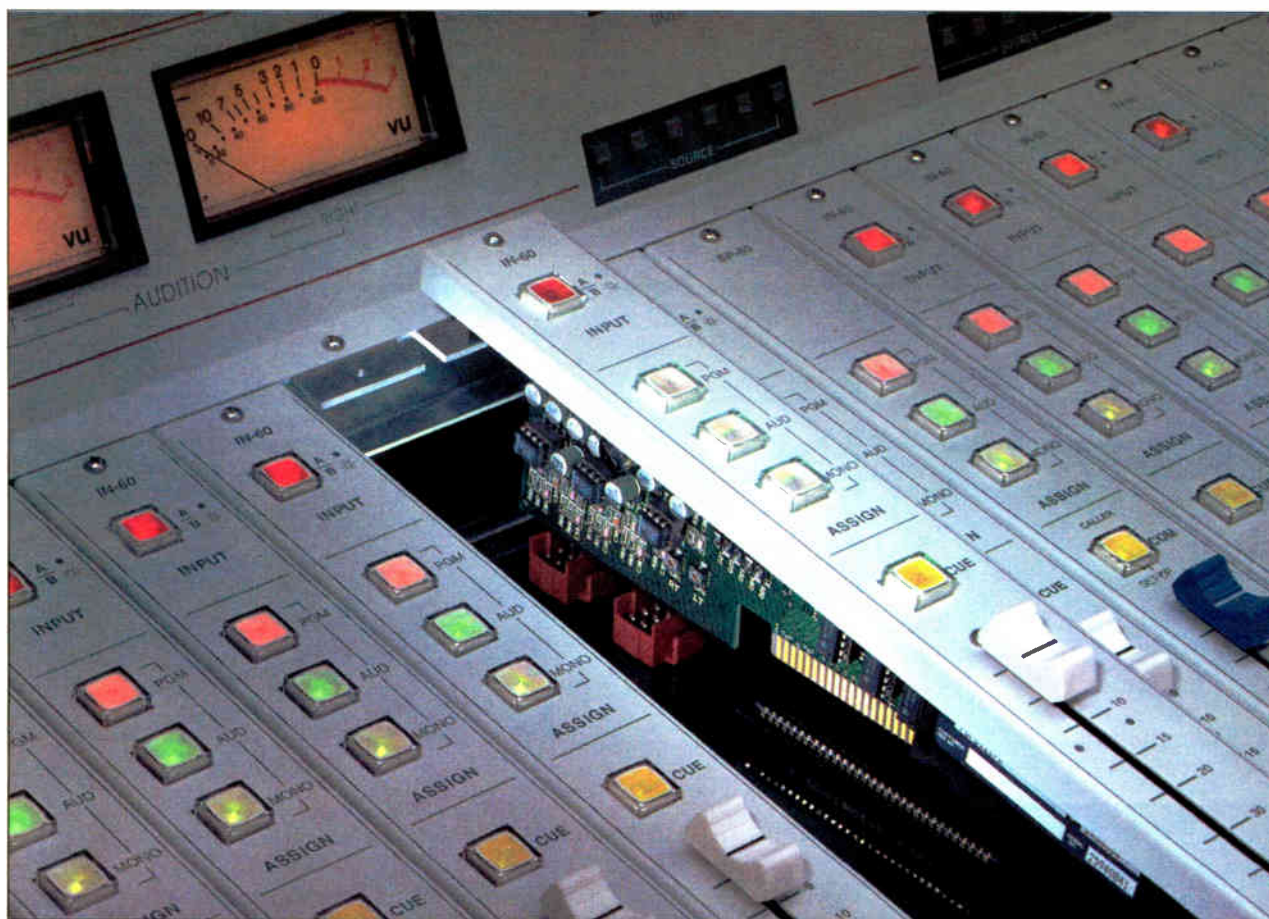

Then look at our competition.

OF COURSE many stations are cost-conscious these days—just remember why you wanted a new console in the first place: to **UPGRADE**.

The R-60 has what's needed, with all the right features: our **SIMPLE PHONE®** module for easy error-free talk segments; twin six bank preselectors, so you won't run out of input capacity; onboard machine control panel, clock, timer, a well-designed cue system, and a truly effective control room and studio monitor interface. And because it's totally modular, service is easy—even while you're on-the-air! Documentation: this can determine whether you have an installation day or an installation *week*. We've done it right to guide you through. And **PERFORMANCE?** Of course we've handled that; simply compare our specs.

DON'T MISS your opportunity to upgrade. Choose the R-60 radio console from **AUDIOARTS**.

FREQUENCY RESPONSE	
Line (10Hz-20KHz)	±1/10dB
Mic (20Hz-20KHz)	±1/10dB
THD+N (20Hz-20KHz)	
Line, +4dBu	.005%
Mic & Line, +16dBu	.005%
IMD (SMPTE)	
Mic & Line, +4dBu	.004%
DIM	
Mic & Line, +16dBu	.005%
DYNAMIC RANGE	
Line	114dB
Mic	98dB
HEADROOM	
ref +4dBu	24dB
OFF & ASSIGN ISOLATION	
1 KHz	-110dB
20 KHz	-105dB
BUS CROSSTALK	
1 KHz	-100dB
20 KHz	-75dB

7305 Performance Drive Syracuse, NY 13212
tel 315-452-5000 · fax 315-452-0160
E-mail: Wheatstone@aol.com

 **AUDIOARTS® ENGINEERING**

Backstage at CBS NFL Coverage

by James Careless

NEW YORK A handful of CBS Radio Sports broadcasters have more than the holidays on their minds. Instead, they're pondering the National Football League playoffs, and where in the United States they may end up in the run-up to — and including — the Super Bowl on Jan. 25, 1998.

Organized into teams, these people are the heart and soul of the CBS Radio NFL

broadcasts. Although the audience they service is large, up to 350 stations throughout the country, the teams themselves are small. Each consists of just a play-by-play announcer, color commentator, and field producer. They are mostly freelancers, flown around the country as needed. Meanwhile, the "per diem technicians," the statisticians, and any other needed bodies are hired on-site, often from local radio stations. (Both CBS Radio Sports and its management company Westwood One cover NFL football during the season; only CBS has rights for covering the post-season.)

ISDN is key

Coordinating everything are Bruce Berenson, CBS manager, traffic, Ron Rubin, Westwood One telecommunications manager, and Dick Owen, Westwood One director of special events. In a recent interview with *RW*, Dick Owen explained this "lean and mean" approach to National Football League coverage.

At the heart of it all is ISDN, which gives CBS a high quality transmission path at reasonable rates. During the regular season, ISDN circuits are ordered in all of the stadiums visited by CBS and Westwood One, to transmit coverage back to both broadcasters' main studios. Hence, the major concern is to ensure that the ISDN and phone circuits and installed and turned up, and to get the necessary equipment to the right team in the right city on the right date. Because of this, CBS relies on Federal Express to send its gear. When it comes to shipping CBS Radio broadcast equipment, "it absolutely, positively has to get there."

To do the job, the engineers send out

Equipment List

- Telos and MUSICAM USA ISDN transmission equipment
- Comrex HotLine POTS codecs
- Shure 367 mono mixers
- Sony headsets
- Crown noise-canceling headset microphones
- Rane headset amplifiers

just a few boxes to each broadcast site. The ISDN units are small enough to be hand-carried: they consist of Telos Zephyrs and MUSICAM USA CDQ1000 ISDN audio codecs. Overall, typical NFL game kits

include an ISDN codec, Shure six-channel M-367 mixers, Sony headsets equipped with Crown noise-canceling microphones, and a Rane headphone amplifier. Usually shipped as a backup is a Comrex HotLine POTS (plain old telephone service) codec which is capable of reliably delivering a 7

kHz audio channel over a regular telephone line, should the ISDN circuit crash.

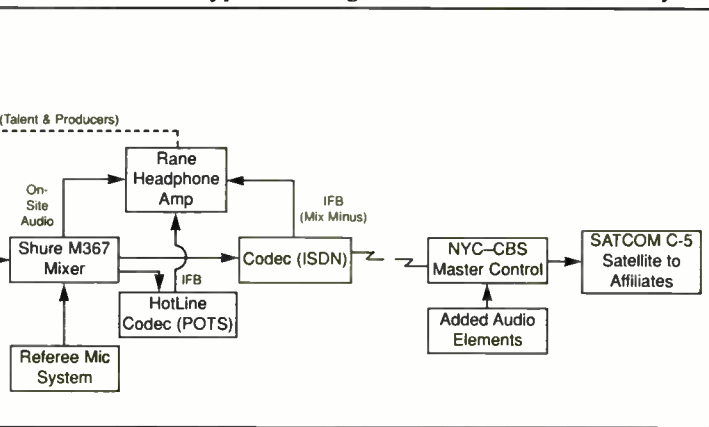

include an ISDN codec, Shure six-channel M-367 mixers, Sony headsets equipped with Crown noise-canceling microphones, and a Rane headphone amplifier. Usually shipped as a backup is a Comrex HotLine POTS (plain old telephone service) codec which is capable of reliably delivering a 7

kHz audio channel over a regular telephone line, should the ISDN circuit crash. Westwood One paid for the game rights is a tightly guarded secret. "The rights are worth whatever the top bid is at the time of the bidding," said Larry Michael, vice president of sports for Westwood One. He refused to set a cash value on the Westwood One contract with the NFL,

beyond saying, "It's a multi-year deal, and our management views major events as something we want to be associated with." Certainly listeners across the United States will be associating CBS Radio Sports very closely with the NFL as Super Bowl Sunday approaches. Hard to believe that so many listeners and so much money ride on four teams.

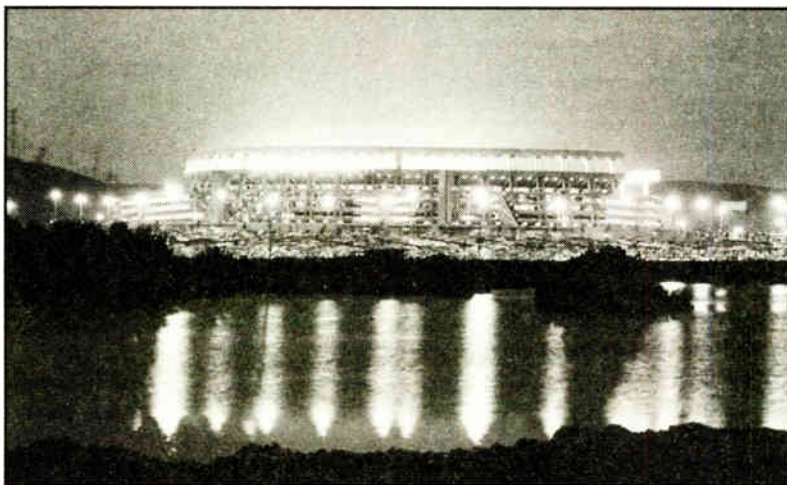

San Diego's Qualcomm Stadium will host the Super Bowl.

Photo by San Diego Convention & Visitors Bureau

"We don't run an open intercom system like TV does," said Owen. Instead, "we send mix-minus audio with a producer interrupt back down the ISDN return to the site. This is combined in the headphone amplifier with the on-site audio mix to give the talent a full mix of the show: themes, spots, interviews, and the studio producer's directions."

The station approach

The "thrill" of the game is captured by omni-directional crowd microphones. They and a feed from the referee's mic are brought up to the broadcast booth via "house telco pairs." The talents' mics are mixed in with these elements, and back-hauled via ISDN to the network studios where music, commercials, automation tones, and live score updates are inserted to complete the show. This is then delivered to the affiliates over the Satcom C5 satellite.

It isn't glamorous or fancy, but it works: that's the best way to sum up CBS Radio Sports' approach to NFL coverage. By keeping things simple — and by having ISDN lines already in place — the network is able to dispatch crews to wherever they're needed, even on a moment's notice. Yet, by insisting on ISDN quality, and high production standards, CBS Radio is able to keep its affiliates happy.

"It's a great product," said Ron Gleason, director of sports and program-

An NFL Producer on The Road

AUSTIN, Texas Bill McConnell is one of the CBS Radio Sports "wandering souls." As a freelance NFL field producer, he's been jetting from Austin, Texas, all over the United States since 1983.

McConnell ensures everything is in place for his broadcast team as they shuttle from town to town.

"I make sure that things don't fall through the cracks," McConnell covers everything from checking ISDN lines, to making hotel reservations.

When things go wrong

Getting the actual broadcast on air is easy, as long as everything comes together. When it doesn't? McConnell said, "The main thing for a producer to do is keep his head and not get excited. Because if you, as a producer, get excited, then everyone around you gets excited, and you don't want that."

But sometimes the equipment fails. McConnell said, "Some of the digital circuitry from some ballparks seems to be, if not inadequate, then under-used to the extent that some kinks have not been worked out." When this happens, it is time to turn to other means, which doesn't faze McConnell. In his pre-NFL days, he once covered the Orange Bowl through a payphone.

Bad weather can be a nuisance, such as an NFL game in New England that has since become known as the "Fog Bowl." McConnell said, "We get to the game, we couldn't see the field. What do you do?"

The unexpected keeps the job fun, McConnell said. "Quite frankly, it's fun to think about the things that are going to go wrong, and what you're going to do about it."

— James Careless

Frequency Agile STL Systems

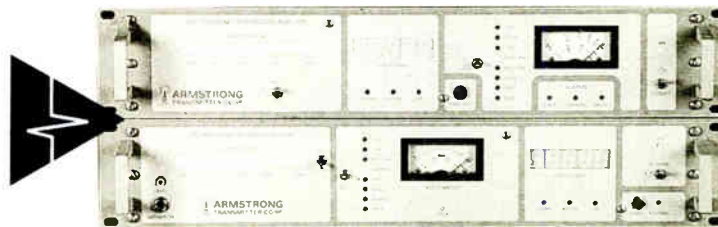

If you are looking to deliver clean, crisp audio to your transmitter via microwave, Armstrong FML-10 STL system offers unsurpassed audio purity in a rock-solid, feature-packed package.

Built to tough manufacturing standards throughout, FML-10 system features microprocessor controllers, advanced PLL circuitry, ultra linear VCO and front panel frequency programmability with digital frequency readout.

Currently in service at over 300 stations in 21 countries, this field proven design is a "rock-solid" STL choice for any station.

COMPLETE SYSTEM UNDER \$5000.00 **SAME DAY SHIPPING** **30 DAY MONEY BACK GUARANTEE**



ARMSTRONG
TRANSMITTER CORPORATION

4835 N. Street • Marcellus, NY 13108 • Phone 315-673-1269 • Fax 315-673-9972

Dallas Companies Host RW Editor

WASHINGTON Wasn't it just Christmastime last year a blink-of-an-eye ago?

Whatever the reason(s), 1997 blew by at an extremely high kilobit-per-second rate and 1998 is staring us squarely in the face. First and foremost, though, I hope all of you have a wonderful holiday season and even better New Year ... certainly a less turbulent one than 1997 proved to be.

As is our end-of-the-year tradition, we've recapped for you the most significant stories of 1997. CBS reigns as the No. 1 radio group in the land with a roster of 79 top-market stations that rake in \$1.0137 billion in advertising revenue per annum. USA Digital Radio with rock solid financial and brain-power support from (you guessed it) CBS is moments away from rewriting radio for the next 100 years. Overseas, the world continues to embrace the Eureka-147 solution for DAB.

Speaking of digital radio, the satellite-delivered variety (DARS) licenses were issued in 1997 and construction began on the birds to deliver the signals. 1999 is the target date for DARS delivery into the consumer's home.

The Clinton administration made headlines in 1997 when it successfully nominated an entirely new group of commissioners (save one, incumbent Commissioner Susan Ness who will continue to serve) to guide the Federal Communications Commission. Former FCC General Counsel William Kennard is the new chairman of the FCC as well as the first African-American appointed to the chairman's seat.

And of course, what **RW** year-end wrap-up would be complete without the requisite story on the Expanded AM band. Yes. It is still a story, and we are still telling it.

Dig in for the evening folks, this issue will, in one sitting, prep you for the quickly approaching 1998.

Cheers!

★★★

RW Editor Paul McLane took time during a recent trip to Dallas to visit with two companies of interest to radio managers. One is relatively new to the radio business; the other is a long-time industry friend.



Bob Brandt, left, and Hamilton Johnson pose with the Lightwave Systems Fibox in Dallas.

Lightwave Systems manufactures digital transmission systems, multimode and single-mode converters and line boosters. Of most interest to radio managers is the Fibox, a fiber optic audio transmission system that earned "Cool Stuff" honors from **RW** at the NAB convention.

Paul met with Senior Vice President Hamilton Johnson, whose enthusiasm for the applications of Fibox in radio is infectious, and with Bob Brandt, the president of Knight's Communications, a dealer for the product.

These fellows are prophets of fiber. Johnson and Brandt believe the technology offers radio stations new, powerful ways to set up studio-to-transmitter links and to manage audio in consolidating facilities. Big selling points of the Fibox include lightning isolation, improved signal quality, no EMI or RF interference,

and a capacity of eight AES or 12 analog channels. The price, they say, need not be prohibitive; in fact, one of the appeals of Fibox is its economical, modular packaging.

Among the prominent companies that have chosen Fibox are WBUR(FM) in Boston, WDCG(FM) in Durham, N.C., Disney, 20th Century Fox, The Tonight Show and Microsoft.

For information, call (800) 525-3443. If you are involved in an SBE chapter, Bob Brandt, himself an engineer, is interested in visiting your group to discuss fiber optic technology. (We told Bob that this is also an excellent way to learn about radio engineers and how his products can better serve them.) You can reach him at (800) 880-5061.

★★★

Well known to radio people is Continental Electronics Corp., also in Dallas. In fact, the company just celebrated its 50th birthday in 1996. Paul McLane, Skip Tash and Sandy Harvey-Coleman met with marketing executives Adil Mina and Steve Claterbaugh to learn more about developments at this RF transmission equipment manufacturer.

Continental is positioned to serve customers across international boundaries and across spectrum blocks, whether the application is longwave, mediumwave, shortwave or VHF-FM. In fact, Mina estimated that three-quarters of the company's business comes from outside the U.S. commercial radio market. He is particularly excited about Beijing New Continental Electronics Co., a new joint venture with China's broadcast ministry announced earlier this year. It will give Continental better, broader access to that huge marketplace.

Continental also is working with other manufacturers on developing standards for digital transmission systems around the world. And the firm continues to work on large government contracts and special projects, as a tour of its 137,000-square-foot plant

PAGE FOUR

by Lucia Cobo

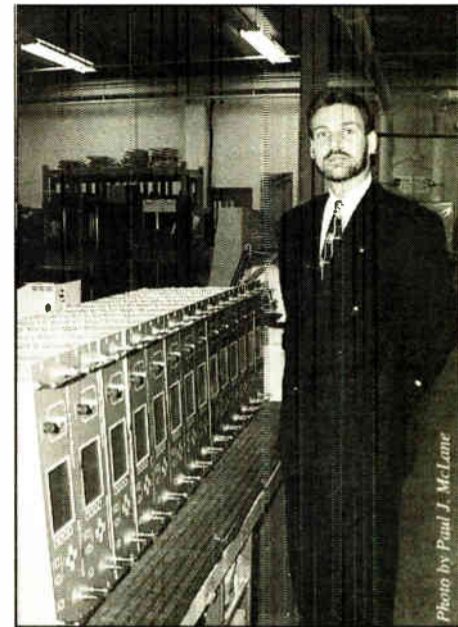

Continental is ready with an ample supply of digital exciters. That's Steve Claterbaugh conducting our tour.

demonstrates. (If you go, bring a pair of roller skates!)

A tour of Continental is a dream for anyone interested in RF applications ... the higher the power, the better. Particle accelerators, submarine communications, line-of-sight and over-the-horizon radar, fusion plasma heating and radio astronomy are examples of projects Continental either is working on or has done in the past.

The company clearly is committed to terrestrial radio and to the U.S. market as well, as its success with its sophisticated 816R Series FM transmitters shows. For information about Continental products, call (214) 381-7161.

Thanks to the folks at Lightwave Systems and Continental Electronics for their grace in hosting our staff.

That's it for now. Until next year!

Remote Control can be this easy.

BURK
TECHNOLOGY

7 Beaver Brook Road, Littleton, MA 01460
Phone 508-486-0086 • Fax 508-486-0081
email: control@burk.com

ARC-16
Transmitter Remote
Control System

For information and our new catalog, call TOLL FREE 800-255-8090

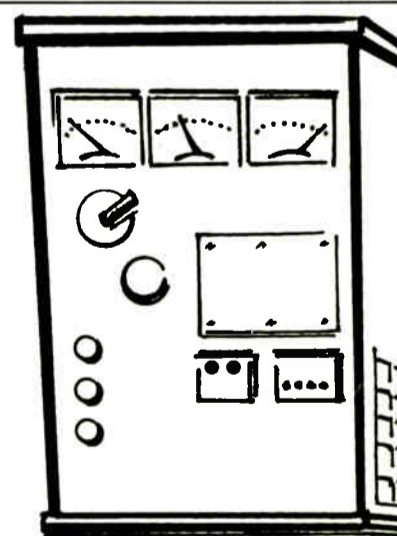

AVAILABLE THROUGH:
CROUSE-KIMZEY
1-800-955-6800

READERS FORUM

If you have comments for Radio World, call us at (800)336-3045 or send a letter to Readers Forum (Radio World, P.O. Box 1214, Falls Church, VA 22041 or e-mail radioworld@imaspub.com). All letters received become the property of Radio World, to be used at our discretion and as space permits.

Snapshot snippet

Dear RW,

Regarding Claudia Tucker's Radio Advertiser Profile in your Nov. 12 issue, it is propounded that assessing response from radio is more difficult than other media, a subject under discussion since the days of the crystal sets.

Moto-Photo targets a 25-to-54, relatively highly educated, 40K-plus-income demo. For the most part, I believe such people know when they are being manipulated and therefore are reluctant to say, "I heard it on WXYZ and I want my 10 percent discount."

"Tell 'em Groucho sent ya"

Radio World

Vol. 21, No. 26 December 24, 1997

telephone: (703) 998-7600
editorial fax: (703) 820-3245

The editorial staff can be contacted at the
phone extensions listed below

Lucia Cobo ext. 115	Editor in Chief
Paul J. McLane ext. 117	Editor
Sharon Rae ext. 126	Managing Editor
Alan Peterson ext. 135	Technical Editor
Leslie Stimson ext. 129	News Editor/ Washington Bureau Chief
Chris Hamaker ext. 147	Associate Editor
Susan Gary ext. 144	Assistant Editor
John Bisset Thomas R. McGinley	Technical Advisors
Stevan B. Dana	Publisher/CEO
Carmel King ext. 157	Chief Operating Officer
Robert "Skip" Tash ext. 160	Associate Publisher
Marlene Lane ext. 128	Editorial Director
Alan Carter ext. 111	Editor in Chief (International)
T. Carter Ross ext. 137	Editor (International)
Christine Joaquim ext. 138	Managing Editor (International)
Rogelio Ocampo ext. 121	Latin America Managing Editor
Marguerite Clark	European Editor
Linda Sultana ext. 141	Editorial Assistant
Stephanie Muller ext. 130	Editorial Assistant

Contributors: W.C. Alexander, James Careless, Harry Cole, Troy Conner, Ty Ford, Alan Haber, Harold Hallikainen, Lee Harris, Mel Lambert, Mark Lapidus, Dee McVicker, Lynn Meadows, John Montone, Rich Rarey, Bob Rusk, Tom Vernon.

Radio World (ISSN: 0274-8541) is published bi-weekly by IMAS Publishing (USA), Inc., P.O. Box 1214, Falls Church, VA 22041. Phone: (703) 998-7600, Fax: (703) 998-2966. Periodicals postage rates are paid at Falls Church VA 22046 and additional mailing offices. POSTMASTER: Send address changes to Radio World, P.O. Box 1214, Falls Church VA 22041. REPRINTS: Reprints of all articles in this issue are available. Call or write Giselle Hirtenfeld, P.O. Box 1214, Falls Church, VA 22041; (703) 998-7600; Fax: (703) 998-2966. Copyright 1997 by IMAS Publishing (USA), Inc. All rights reserved.

—PRINTED IN THE USA—

Next Issue of Radio World
January 7, 1998

hearkens back to a time when broadcasting was a novelty.

In the '70s, I wrote and produced a spot for a deli in which it said they offered "free do-it-yourself valet parking." That tangible, traceable, bank-

MOTOPHOTO

The Experience Makes the Difference™

able line brought in new, verifiable customers every day. It was funny, disarming and most important, memorable. Moto-Photo's agency should try to come up with something equally conducive to eliciting detectable listener comment.

Norm Hankoff
Fair Oaks, Calif.

A long time in coming

Dear RW,

I'm delighted to see the debut of Dain Schult's column, "Station Financing" (RW, Aug. 6). In my opinion, it's long overdue. I know that I would have benefited from it directly, had it appeared about 10 years earlier. As it is, I managed to escape the worst pitfalls, and purchased WLMI(FM) in 1992. Some thoughts:

His estimate of "north of \$50,000" as the sum required to undertake a station purchase strikes me as too low. We had just over \$100,000 in hand

Write to Us

RADIO WORLD
READERS FORUM

P.O. Box 1214
Falls Church, VA 22041

radioworld@imaspub.com

when we bought a small stand-alone FM in a town of 4,600 people. In retrospect, I wouldn't want to have started with a penny less. We made a cash down payment of just under 20 percent (\$45,000), and also paid for local and Washington attorneys, a local accountant, and various filing and financing costs.

An unseen but very real cash demand is operating capital. Few deals involve sale of receivables, so the buyer must be able to operate the station with virtually no income for at least three months, all the while buying stationary, upgrading equipment, etc. A shoestring is not a form of financing; it's a noose to hang yourself. And the lower the purchase price, the more the buyer is likely to have to spend to get the station into shape.

To any prospective purchaser who thinks he can skimp on professional assistance, think again. We engaged one of the most prestigious Washington attorneys, and I have nev-

Ch-Ch-Ch-Changes

So ... was it a good year?

The answer depends on where you sit, or more accurately, where you work. For many in radio, 1997 was unforgettable. It's hard to overstate the importance of the sweeping ownership changes that have hit radio since early 1996.

Will the pace slow down? Can radio managers start making financial decisions for two or three years out, without wondering if their property

will have changed hands twice in that time? Don't bet on it. We see much more consolidation to come.

Radio, still bearing the characteristics of a protected, regulated industry, has quite a way to go before it is shaped like other, more open businesses. If the company you work for has not yet been sold, it may yet be. If it was sold once, it may be sold again.

But that's just the beginning. Once ownership mergers settle down, we predict far more changes in other parts of radio. Managers will see benefits to consolidating sales teams further by groups of stations or region, rather than by station. Engineers will be asked to reconsider how they manage their facilities, and how they could do so more efficiently. PDs will call more shots from corporate headquarters. Owners will want to bring their various stations under one roof. Regional and corporate overseers will play a more prominent role.

These trends will vary by group. The changes raise many questions about how radio can maintain the powerful weapon of localism, in both programming and expertise. Just as one could argue that a PD can best judge music tastes in a market by living there, an engineer may be best suited to make decisions about a multistation RF plant by working in it regularly. Will radio's new superowners continue to see it that way? Will they even be around in another year or two? Or will they be replaced by another group, even less aware of the structure and history of the medium?

Some will cling to familiar models, in which educated, experienced professionals at the local level make the decisions. But inevitably, the pressures of consolidation will make that approach the exception rather than the norm.

The ride's not over.

—RW

er regretted it. We also hired a local accountant, who was essential to our obtaining a local bank loan, and hired a local attorney. The first year is extremely difficult for a first-time station owner in a new town. The hours are horrendous, surprises lurk everywhere, and you don't yet have rules of thumb to tell whether you're doing things right. Adequate capital makes the difference between seeing your fifth anniversary as station owner, and having a bundle of hair-raising tales to tell about back when you used to own a radio station.

I'm looking forward to Schult's columns on this topic. I expect that they'll be among the most popular features in *Radio World*.

Chuck Crouse
President/General Manager
WLMI(FM)
Kane, Pa.

Design a silence sense alarm

Dear RW,

I have long been intrigued by so-called "Silence Sense" circuits, but since I am not an engineer, my fantasies on this subject have only been theoretical. Your circuit in the Aug. 20 issue, like so many commercially available units, would appear to handle alarm at a total loss of audio just fine. But what these "black boxes" cannot do, and something critically needed, is a similar circuit that will alarm at "hash" noise typical of a satellite transponder uplink or STL failures.

Your "Mission Impossible" assignment, should you decide accept it, is to design a comparative circuit that can discriminate between variable modulated audio (typical broadcast matter) and a consistent modulated audio (typical with hash noise) so that it will "alarm" not at loss of audio but at loss of variable modulation. For a piece of the

profits, I'll even contribute to the R&D!

James U. Steele
General Manager
Radio Kings Bay, Inc.
Kingsland, Ga.

Technical Editor Al Peterson replies: Most satellite receivers have a "signal lock" LED that comes on when audio is present and goes out when there is nothing on the channel. Put an optical sensor (photocell, phototransistor, LASCR, etc.) in front of it. When the channel goes down, the light goes out; the sensor trips a comparator circuit and triggers an alarm.

Transportable, not mobile

Dear RW,

Regarding my article "Mobile AM for Missile Crisis" (RW, Nov. 26): I have a complaint of sorts: Why did you select "Mobile" for the title of the article? A mobile transmitter or mobile transceiver is definitely one that is set to operate while a vehicle is in motion. That transmitter system was "transportable" and that is what I called it!

Allowing for transport time, it would still take hours to set up towers, ground system, trailers, connect all the cables interconnecting the trailers, RF transmission lines to the dual towers, 208V AC, 9,100 V AC, HV DC, 52-conductor #12AWG control cable to the Low-Boy Switchgear cabinet. All very un-mobile. It takes hours to set up, and can only operate in that unmovable condition.

Even in the more-modern world of Vietnam where we built "transportables" for the Army Sig Corps, the equipment was air-dropped, tower base and tuning unit, transmission lines, tower sections and guywires, and a transmitter trailer dropped intact, for low-power AM field operations, but never mobile.

James F. Pinkham
Hudson, N.Y.

DAB a Reality Around the World

by T. Carter Ross

WASHINGTON Around the world, adoption of Eureka-147 DAB continues apace. Europe and Canada are moving away from DAB tests to regular DAB services.

Four Eureka-147 transmission "pods" are to be established at the CN Tower in Toronto, with a target of early 1998 for actual transmissions. At a convention in October, broadcasters announced the purchase of DAB transmitters from Itelco USA and antennas from Scala Electronic Corp. Digital radio receiver manufacturers showed receivers at a fall trade show in Canada, with predictions



that consumers would start to see them next summer.

In the United Kingdom, some 19 DAB transmitters are in place, transmitting DAB signals to nearly half of the population of Great Britain.

In Spain, Catalunya Ràdio and Cadena SER both sponsored DAB demonstrations, and Catalunya Ràdio introduced trial broadcasts of its music channels, RAC 105 and Catalunya Música.

Italy proceeds

In Italy, several private efforts were launched to help speed the introduction of DAB there. During 1997, private broadcasters and broadcast equipment manufacturers formed two organizations — Club DAB Italia and DAB Servizi SpA — to help promote the technology and to pro-

vide DAB technical and facility services.

The Italian public broadcaster Radiorai (RAI) also announced plans to begin DAB service in Turin, Milan, Rome and Naples, and the regional broadcaster Rundfunk Anstalt Südtirol (RAS) announced its own DAB trials for Bozen, in the German-speaking region of South Tyrol. The RAS tests are interesting in that they will link with DAB services from both RAI and Bayerischer Rundfunk, the German regional broadcaster for Bavaria.

Throughout Scandinavia and Germany, public broadcasters continue their push toward increasing DAB services. The Scandinavian DAB services, in particular, are noteworthy for their close cooperation throughout the region. Danmarks Radio in Denmark, Sveriges Radio in Sweden and Norsk Rikskringkasting (NRK) in Norway are working together to test different technical and programming ideas for DAB.

DAB trials in Croatia

The beginning of 1997 saw the purchase of 14 Thomcast Crystal line DAB transmitters by Vlaamse Radio en Televisie (VRT), as the Flemish broadcaster began testing DAB. And the end of the year saw the start of DAB trials at Hrvatska Radio-Televizija (HRT) in Croatia and the approval for DAB trials in Portugal by Radiodifusão Portuguesa (RDP), Rádio Comercial and Rádio Renascença.

But without receivers, all these projects are for naught. The year also saw the introduction to consumers of DAB receivers by some 15 or so companies at the Internationale Funkausstellung (IFA) in Berlin.

Most of the receivers on display were geared toward in-car listening and were expected to be on store shelves in spring

of 1998 at the earliest.

Increasing public awareness about DAB was a major task for many broadcasters during the year. In addition to the DAB push at IFA, auto shows from Toronto to Barcelona to Paris included demonstrations of DAB technology.

Outside of Europe and Canada, several other nations were looking toward their plans for DAB. Australia and South Korea both announced their adoption of the Eureka-147 standard, and Australia began the process of reserving frequency space for its adoption.

In Taiwan, DAB trials were scheduled to commence this year, but military officials re-fused to release needed frequency space for the trials. The tests were rescheduled for January 1998.

DAB tests are also being conducted in China, India, South Africa and other nations throughout Asia and Europe.

In Latin America, broadcasters are standing by their go-slow approach, waiting to see how the dispute between Eureka-147 backers and U.S. broadcasters is resolved. Some broadcasters in Mexico, however, are urging rapid adoption of Eureka-147 DAB technology.



While L-band vs. in-band DAB may be the main debate for U.S. broadcasters, Eureka-147 backers did stumble upon a few rows regarding DAB technology during 1997.

Although a united front was presented at the IFA, British and German researchers soon went public during IBC '97 with a dispute about how to best implement digital data services with DAB. Once in the public spotlight, the European Telecommunications Standards Institute (ETSI) found a way to smooth over the dispute by creating a two-step phase-in of DAB data capabilities, meeting the immediate needs of the German researchers while still addressing the long-term concerns of the Britons.

Digital AM

1997 also saw a public disagreement between Eureka-supporters WorldDAB and the WorldSpace, satellite-based DAB system that is geared toward the developing world.

Finally, 1997 was the year for digital solutions for digital AM, longwave and shortwave. Both Thomcast with its Skywave 2000 and Telefunken with the T2M system highlighted digital modulation and broadcasting solutions for these wavebands at broadcast conventions around the world.



T. Carter Ross is the editor of Radio World International. James Careless contributed information for this article.

Joint Team Presses Forward With IBOC

► IBOC, continued from page 1

to jointly develop a digital transmission and reception system for in-band, on-channel digital radio. Lucent would assist USADR in designing effective hardware, refine error correction algorithms and provide the Bell Labs PAC (perceptual audio coding) compression scheme to replace MUSICAM USA coding used in the initial USADR offering.

Cooperative effort

Rick Martinson, manager of DAB systems at Westinghouse Wireless Solutions, said, "It has nothing in common with our earlier system. We have two companies building upon what we've learned with our systems." Westinghouse Wireless Solutions is a sister company to CBS, which, along with Gannet, constitute USADR.

The National Association of Broadcasters supports an IBOC solution for digital radio. Commenting on the cooperative effort, NAB President Edward Fritts said, "A partnership between USADR and Lucent can only be viewed as an extremely positive development towards that goal."

CEMA President Gary Shapiro said, "I think it's always valuable when there's a competitive situation between companies for a standardized technology, where you take the best aspects of each company's technology and they agree to work together."

The combined "dream team" of

Lucent/USADR engineers have worked extensively on bringing a product to market and approached the end of 1997 working on a series of fundamental on-air tests of the new system. (See related technical paper, page 26.)

FM testing

The FCC granted Lucent/USADR an experimental license to test FM channel characterizations, the first step leading to actual in-band on-channel testing in the Washington area. A test site was established in Bethesda, Md., using the backup tower site of a Washington radio station and a 600 W transmitter.

Before the license was granted, Lucent/USADR had to prove there would be no interference to television channels in nearby markets (the bottom of the FM band is adjacent to television channel 6).

The tests were to commence earlier this month with a series of simple pulses intended to check only for multipath in the FM band. Martinson said, "We want to see how it behaves in a typical eastern market," noting the earlier Salt Lake City tests done in 1995. Following the multipath tests, the same site will be used to evaluate actual IBOC broadcasts.

IBOC AM also is closer to its testing phase. Martinson said, "We have a very good model simulated now and we're writing code. Although we don't have a test site yet, we are hoping for summer 1998."

RDS/RBDS "Mini-Encoder"

With this simple, "dirt cheap" encoder, your station can begin transmitting

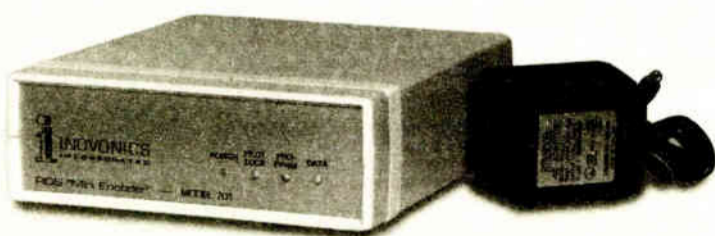

the more important radio-data IDs, service flags and text messages.

Use any PC to quickly and easily enter your station's call letters or "street name," format identifier, translator frequencies and scrolling ads or promos. Menu-driven software transfers this information to the encoder's own non-volatile memory.

This nifty little encoder installs in minutes, locks to any stereo generator and works in to any FM transmitter.

Don't let your station be skipped-over by the new generation of "smart" radios! At just \$390 there's no excuse for waiting to put RDS to work for you right now.

MODEL 701 — \$390

Inovonics, Inc.

1305 Fair Ave., Santa Cruz, CA 95060 USA
TEL: (408) 458-0552 • FAX: (408) 458-0554

www.inovon.com



DARS Providers Look to 1999

by Alan R. Peterson

WASHINGTON Satellite-delivered digital audio radio services (DARS) began moving forward in earnest during 1997, when licenses were granted to American Mobile Radio Corp. and CD Radio. Both services intend to launch 50 channels each of digital audio, with the first working system expected to be in operation in the United States by late 1999.

The year began with a debate over spectrum, moved through the auction phase and concluded with a global perspective on digital broadcasting voiced at the fall AES convention in New York.

Spectrum debate

In February, NAB President Eddie Fritts traded words with Gary Shapiro, president of the Consumer Electronics Manufacturer's Association over allocation of spectrum for satellite-delivered DARS.

CEMA said that the S-band was not a suitable choice for DARS, as a mobile signal would suffer degradation or blockage by building structures and foliage. Terrestrial repeaters or "gap fillers" would be needed in areas where signal integrity would be compromised, said CEMA. CEMA claimed the repeaters would not be necessary if DARS were to be allowed in the L-band or in the UHF or VHF bands.

The allocation for the S-band had been mandated by Congress, and the FCC had no plans to reconsider placing DARS in the L-band. The NAB, meanwhile, requested the FCC phase in the satellite service rather than begin it all at once. The commission rejected the request.

When the auction process began in April, four companies entered into bidding: CD Radio, American Mobile Satellite Corp., Primosphere and Digital Satellite Broadcasting. The successful bidders were AMRC (nearly \$90 million) and CD Radio (\$83 million).

Auction payments

After a series of payments, both companies received FCC approval to begin construction and operation of their satellite-based systems.

NAB raised a technical objection, and asked the FCC to deny a license to CD Radio, based on what NAB said was the inability of CD Radio to provide service to certain areas. The NAB stated that CD Radio "will only be able to provide service to rural areas and suburban areas with south-facing windows because its proposed link margin will not provide high-quality service."

In response, the commission stated CD Radio's use of spatial and time diversity would avoid outages. "In core urban areas and tunnels," the FCC continued, "CD intends to augment its DARS transmissions implementing terrestrial repeaters."

AMRC also intends to use repeaters, but the commission is delaying until later a plan for regulating gap fillers. The NAB opposed the use of terrestrial repeaters and filed comments with the FCC, asking for a technical analysis

before creating new regulations.

Of technical interest, the latest generation of mobile dish antennas for reception of digital signals are only about the size of a person's hand.

A bumpy beginning was also felt by AMRC, with opposition from competing bidders Primosphere and CD Radio. Surviving the bidding, AMRC announced its intentions to launch its first satellite by the end of 1999 with service in place

sometime in 2000.

The threat presented by the DARS

providers to traditional terrestrial radio broadcasting is unclear. Judging by trade publication coverage and comments during panel discussions at conventions, many radio managers are unaware of the DARS developments or do not consider them a serious problem.

DARS at AES

At the Audio Engineering Society 103rd convention in New York in September, a special workshop on digital audio broadcasting was held to familiarize the professional audio community with developments in digital radio. The pending satellite services

were part of the discussion.

Robert Briskman of CD Radio voiced his company's position and current developments.

CD Radio

"Three satellites are being built now," said Briskman. "Two are planned to be launched in August and October 1999." He was hopeful that CD Radio can have 30 narrowcast music channels and 20 voice channels operational by the end of 1999.

Session chair Judith Gross of JG Communications said of DARS, "This is the silent threat that broadcasters know about and they oppose, but there is nothing they can do about it. ... Satellites could conceivably be on the air prior to U.S. broadcasters going on with terrestrial (DAB) service."



Use the *HotLine*

...when ISDN doesn't make sense

One-time remotes just got easier!

Sometimes it's impractical to install a special circuit like ISDN for a one-time remote. However, a plain telephone line is usually available. Wouldn't it be nice if you could have high quality two-way audio on that plain line? That's just what you get with the *HotLine*.

Special introductory price: \$2995

Call us for details

800-237-1776

<http://www.comrex.com>

COMREX
We make great connections



**Wideband two-way audio on POTS
(Plain Old Telephone Service)**

COMREX Corporation, 65 Nanset Path, Acton, MA 01720 USA Tel: 978-263-1800 Fax: 978-635-0401
Email: into@comrex.com Fax-on-Demand: 978-264-9973 Toll-free: 800-237-1776 in North America
or 0-800-96-2093 in the U.K.

The Changing of the FCC Guard

by Leslie Stimson

WASHINGTON Congress passed the Telecommunications Act of 1996 and the FCC set out to implement it. By mid-1997, FCC commissioners whose terms were up started thinking less of the Telcom Act and more about life beyond the commission.

In January, 23-year Commissioner Jim Quello told the White House he was willing to serve for another term, but the administration had other plans. At that time, the White House was putting together

FEDERAL COMMUNICATIONS COMMISSION

a package of two nominations, one for Quello's seat and another for former Commissioner Andrew Barrett's seat.

Senate Commerce Committee Chairman was an early supporter of Michael Powell for Barrett's old Republican slot, while then-FCC General Counsel William Kennard was mentioned by several sources to fill Quello's seat.

By February, the field for potential commissioners became more crowded as Senate Majority Leader Trent Lott, R-Miss., and House Commerce Committee Chairman Thomas Bliley, R-Va., supported chief economist for the House Commerce Committee, Harold Furchtgott-Roth to fill a Republican slot.

McCain then said that when Rachelle Chong's term ended in June, she should leave, and he would still support Powell. McCain said he had no specific complaints about Chong, but that commissioner terms were finite, and he thought it was time for her to move on. Chong wasn't sure she wanted to be re-appointed. When she decided she did, it was too late.

By April, rumors of chairman Reed Hundt leaving were stronger than usual, and other names were floated for possible commission seats. There was a push for a rural candidate by members of the Congressional Black Caucus. They and Sen. Ernest Hollings, D-S.C., supported a rural candidate, former Hollings aide Ralph Everett.

Hundt announced his plans to leave in May, and told the president he would stay on until his successor was installed. Hundt called the chairman's position "the best job I'll ever have." He said because of the long hours required at the commission, he was missing his kid's childhood and it was time for him to go. Critics called him a lame duck during the last year of his term, and said he was ineffective in getting the administration initiatives passed.

One example was the 2-2 deadlock on whether the FCC should review broadcast liquor ads.

Hundt listed the FCC accomplishments during his term: on-time implementation of the Telcom Act and successful spectrum auctions. During his tenure, the FCC had its first downsizing and came into the computer age with a website and the beginnings of electronic filing.

The new guys

Most of the mass media issues that were left hanging at the commission at the beginning of 1997 are still undecided at this time, because of all the uncertainty of who would be the new commissioners. The FCC in 1996 issued licenses for satellite DARS and the first construction permits for the expanded AM band. But broadcast ownership issues left pending include the ownership attribution rules, the waiver policy for radio-newspaper crossownership and new EEO and indecency guidelines.

Under new Chairman Kennard, the FCC has begun its biannual review of ownership regulations, mandated by the Telecommunications Act. Kennard started the review during his first week in office.

Kennard also came out of the gate right away for the FCC to take up its pending broadcast liquor ad review. For the first time ever, an African-American leads the FCC and most of the commissioners are minorities. In the early weeks of their service, Kennard, Tristani and Powell have all expressed concern over the stagnant state of broadcast minority ownership and have pledged to improve things.

Tristani and Furchtgott-Roth are still learning about broadcast issues, while Powell is an antitrust lawyer.

Several communications lawyers who do business with the FCC had nothing but praise for Kennard.

"The agency will be more cohesive and get along better internally," said Richard Wiley, former chairman from 1974 to 1977. Wiley called Kennard "a collegial person by nature." Of Powell, Wiley said, "He has a lot of political savvy. He knows how to handle himself

... Gloria has a background as a state regulator. That will be an asset to the commission and Roth has good ties on the hill."



William Kennard

Photos by Alan R. Peterson

Communications lawyer Steve Lerman said he worked mostly with Kennard in settling the Howard Stern indecency cases for Infinity in 1996. "If there's a fairer guy around, I don't know him."

Frank Montero, Fisher Wayland Cooper Leader & Zaragoza, said that Hundt had not worked too often with small, independent broadcasters and Kennard has. Montero remembered when Kennard testified before Congress opposing the elimination of the minority tax certificate in 1995.

The Deals of 1997

► DEALS, continued from page 1

Westinghouse power generation unit to Germany's Siemens AG. The rest of the industrial businesses were to be sold by mid-1998.

Studio and transmission systems firm Broadcast Electronics Inc. changed hands in August in a management buy-out led by former Heritage Media owner Jim Hoak. Former majority shareholders Cirrus Technologies sold its shares in BEI to Hoak Communications Partners, LP. Included in the sale were two BE subsidiaries, Broadcast Programming of Seattle and Marti Electronics of Cleburne, Texas. Hoak sold his radio group, Heritage Media, to Rupert Murdoch's News Corp. for \$1.35 billion in August.

Cable programmer C-SPAN got into radio with the purchase of WDCU(FM) in Washington. The financially strapped University of the District of Columbia sold the station for \$13 million to help erase a budget deficit.

Getting out of radio

Nationwide Mutual Insurance got out of radio. The company put its entire 17-radio station group on the block on Oct. 8. Broker Gary Stevens said that radio "was not a core business for Nationwide ... and now is an attractive time to sell if it's not your main business."

Jacor announced on Oct. 27 that it would snatch up the Nationwide group for \$620 million.

The entry of "Radio Disney" into the children's market siphoned off affiliates from Children's Broadcasting Corp. CBC notified affiliates it would stop distributing its 24-hour children's format "Radio Aahs" by Jan. 30, 1998.

CBC sold its owned and operated AMs

to Global Broadcasting for \$72.5 million.

Factoring in the DOJ

Compared to the year before, the first half of 1997 was a more normal year for radio and the Department of Justice. The industry got used to the idea that now some radio deals were large enough for antitrust review. At the same time, DOJ attorneys were making the rounds at various meetings to explain what the DOJ was doing and why.

The DOJ position is that radio is its own advertising market — separate from other media in a market. Ad agencies tell the DOJ they can't buy around certain stations to get preferred demos when certain radio groups merge. The DOJ listens to the ad agencies because it defines them as radio station customers, and the DOJ fights anti-competitive practices. (For example, if radio groups merge and stop pricing their spots competitively.) Stations deny they do this, but the DOJ says its lawyers have found documents to back up the DOJ position in paperwork filed for antitrust scrutiny.

The DOJ held its ground Nov. 6 when it sued to block Chancellor Media from acquiring four Long Island, N.Y., stations from SFX. It was the first time the antitrust division went to court to challenge a radio merger.

In Long Island, the DOJ said the proposed SFX/Chancellor merged entity would garner 65 percent of the radio advertising market — way over the approximately 40 percent the DOJ has held stations to in the past. The court complaint also sought to end a local marketing agreement under which Chancellor had been operating the Long Island radio stations of SFX. Justice said the companies began the LMA too soon, before the deal passed antitrust review.

SINE SYSTEMS
Innovative Solutions

Voice: 615-228-3500

Fax: 615-227-2367

Fax-On-Demand: 615-227-2393

Web: www.sinesys.com

RFC-1

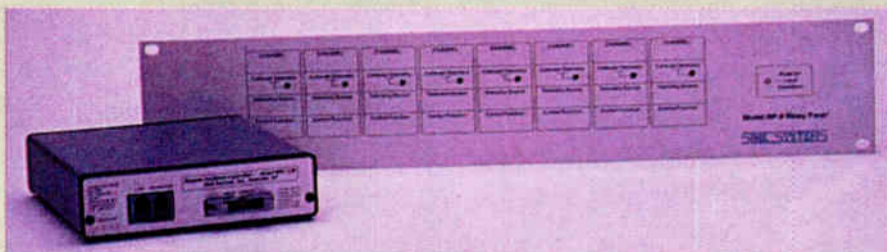

Dial-Up Remote Control: Control and monitor your transmitter from any telephone with the famous RFC-1: the world's most affordable full-featured dial-up remote control. It speaks to you with a natural human voice! It can also telephone you to report out-of-tolerance conditions and can automate transmitter power/pattern changes. It is expandable to 64 channels and has many optional accessories.

The Ubiquitous Zephyr...

Zephyr™ makes me happy
 I like it quite a lot
 I'm not alone with Zephyr
 it connects me on the spot

I push a single button
 and instantly I'm there
 destination doesn't matter
 'cause Zephyr is everywhere

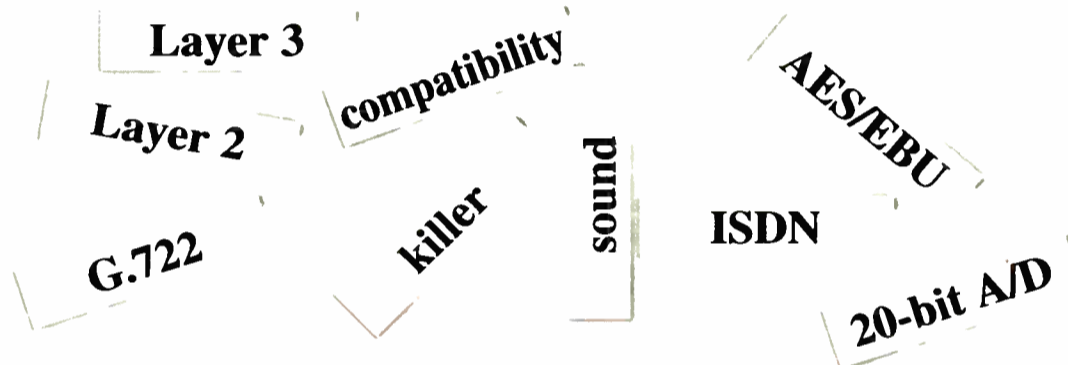

Everyday, we see more signs that Zephyr is everywhere. So, if you've ever thought about remote broadcasts or linking up with other studios, there's never been a better time to act than now. Zephyr has quickly become the standard, with thousands already in use.

Zephyr is number one among radio stations and studios. It is the best sounding, lowest cost way to send high-quality audio over ISDN. Once programmed, anyone can Auto Dial ISDN calls. Not sure what to do next? Press the help button for simple instructions.

Zephyr is full-duplex for two-way transmission. And you don't have to worry about what codec is on the other side — with Layer 3, Layer 2, and G.722, Zephyr can handle whatever is thrown at it — even bad poetry. With Zephyr, the whole country—even the world—is your studio.

- The ideal solution for remote mixing and broadcasts, ad hoc networks, recording sessions, voiceovers, distribution of commercials, backup to satellite and microwave links, and many other applications.
- Designed by Telos specifically for radio/audio applications over ISDN.
- Optional AES/EBU digital audio input/output module with sample rate conversion.
- Clean, uncluttered front panel for simple operation. Full metering, call duration timer, headphone jack, and mic/line inputs.
- Built-in input protection limiter. When your talent screams, your audio doesn't distort.
- Zephyr has an integrated ISDN terminal adapter designed for the non-technical operator. You can even place a standard voice-grade call to a Plain Old Telephone Service (POTS) telephone.



Telos Zephyr: The Best Way to Hear from There™



Telos Systems • 2101 Superior Avenue • Cleveland, OH 44114 • Tel: +1.216.241.7225 • Fax: +1.216.241.4103
 E-Mail: • info@telos-systems.com • <http://www.telos-systems.com>

Telos Systems, the Telos logo, Zephyr, and The Best Way To Hear From There are trademarks of TLS Corp. Other trademarks are the property of their respective holders.

Circle (33) On Reader Service Card

World Radio History

A Funding Crisis, a Funding Hike

by S.D. Yana Davis

WASHINGTON Public radio stations stood to do no better than break even with federal funding through two key sources, the Corporation for Public Broadcasting and the Public Telecommunications Facilities Program, when the year began.

But by July, proponents of increased federal funding, led by U.S. Sen. Ted Stevens, R-Alaska, had gained the upper hand in both houses of Congress, with no small help from station listeners who had called, written and e-mailed Congress over the funding issue consistently for the last two years.

The result was an increase in CPB funding, which is authorized two years in advance, from \$250 million to \$300 million for fiscal 2000, and an upgrade in PTFP funds from \$15.25 million to \$21 million for fiscal 1998. President Clinton signed the bills authorizing the increases in November.

Merger talks

Another major development in 1997 was the first serious discussion about merger between the two largest networks providing programming to noncommercial stations, National

Public Radio and Public Radio International.



Discussions apparently began when PRI President Steve Salyer was approached late this spring by NPR President Delano Lewis about expanding cooperation between their networks beyond "America One," a joint venture that syndicates both NPR and PRI programs to stations in Europe. Lewis indicated to Salyer that a merger was among the possibilities.

Talks stalled after the PRI board of

directors, meeting in October, made merger conditional on a number of points, chief among which was PRI retaining its independent corporate structure. NPR, the older network, is a membership organization owned by its 550 affiliate stations. A proposal by Lewis a couple of years earlier to change NPR's ownership structure had already received stormy opposition from affiliate managers and had been dropped.

PRI left open the possibility that merger talks could resume in the future, providing its conditions are addressed in any proposal from NPR.

NPR shuffle

NPR conducted an internal restructuring to improve station services. Lewis axed the Program Strategy Board that had determined much of NPR programming. The board was composed of top NPR executives and program producers. Two key executives, Leslie Peters and Sandra Rattley-Lewis, left in the wake of the elimination of the board in July. By November, the former executive director of the Public Radio Program Directors' Association, Steve Olson, had joined NPR in a position created to coordinate program offerings to stations.

Scott Studios' Breakthrough: Uncompressed Digital Audio at a Compressed Price!

Your station can make the quantum leap to *uncompressed* digital music from hard drives! You'll hear the difference in quality from this superior system!

Best of all, Scott Studios' *killer* new linear audio costs *no more* than compressed systems! Scott Studios is the *only* company playing *four* great sounding *uncompressed* digital stereo streams at 24kHz, 32kHz, 44.1kHz, 48kHz or any mix *with overlap* and *while recording!* No other system uses the sizzling hot new Motorola 56301 DSP chip and *32-bit PCI bus* audio cards! *Only* Scott Studios' system prevents dueling algorithms and eliminates compression artifacts with linear audio *at no extra charge!*

You also get a fail-safe watchdog for *unequaled* reliability, a 6x6 preview switcher that lets you hear ends of spots or songs while the middle is on-the-air, superior headroom, General Purpose Interface, digital ins and outs, optional timing stretch & squeeze, optional MPEG or APT, and more.

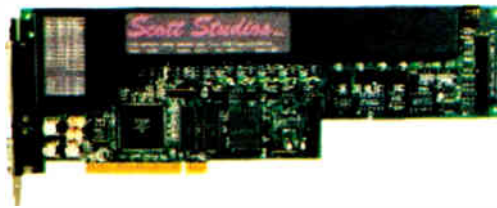

Scott Studios exclusive new 32-bit PCI audio card plays up to four CD quality uncompressed stereo channels while recording!

Several stations joined a trend ... to drop music from prime dayparts and more to a news/talk format.

Good Spot Box



Scott's new digital Spot Box triple-deck "cart" replacement delivers awesome *linear* CD quality sound.

Spot Box is the *easiest* digital system to use! There's only one screen, so your jocks always know what's happening. At the left, three players give you legible labels, countdowns and End-of-Spot signals, with big well-lit buttons that show what's playing. Even though it uses Windows 95 or NT, Spot Box works like carts, *not* a computer. At right, there's a "rotary cart rack" that lets you pick and play any recording by number or name. Or, number keys at the bottom load your cut quickly.

As options, Spot Box can automatically load logs from traffic by diskette or LAN. You can record spots and edit phone calls at the right of the screen. Starting at \$5,000, Scott's Spot Box is so affordable many stations can even put two in an air studio for redundancy.

Better AXS



AXS⁺ (pronounced ax'-cess) is radio's premier digital audio system for satellite or news/talk formats, CD automation and cart replacement for live jocks. AXS⁺ gives you instant play Hot Keys, log editing, music on hard drive, Power Fill, satellite jock substitution, link to NPR's SOSS, an easy-to-use Real Time Scheduler, the industry's simplest and best net catcher, and an optional production or phone recorder and editor in the air studio.

Scott Studios offers AXS⁺ satellite systems as low as \$7,500 complete.

With Spot Box, AXS⁺ or a Scott System, you can get 24 hour, 7 day support from Scott's 45 person staff—the biggest (and best) in digital audio! With several of these systems, any can record a spot once for all! Also, for spot or music on hard drive with typical playlists, you choose whether to get *uncompressed*, MPEG or APT digital audio cards at no difference in price.

Best Scott System

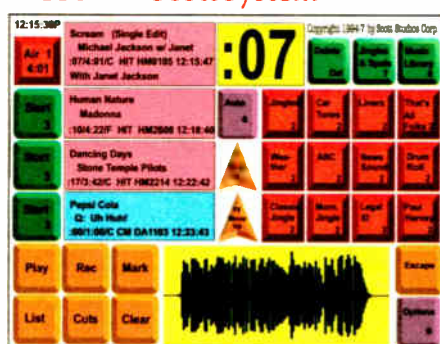

The Scott System is radio's top-of-the-line for digital music on hard drive. You get instant play Hot Keys, touch screen music libraries for instant requests, log editing, built-in phone recorder, pre-recording Voice Trax in context, and production that imports from any WAV digital multi-track.

Scott also offers an *invincible* seamless redundancy option. It's self-healing, so regardless what happens, your spots and hits just keep on comin'!

Good. Better. Best. Scott Studios' three digital systems can be tailored to *your* needs and budget. Call or E-Mail info@scottstudios.com for details.

Scott Studios corp.
13375 Stemmons Freeway, Suite 400
Dallas, Texas 75234 USA
(972) 620-2211 FAX: (972) 620-8811
800 726 8877
(800) SCOTT-77



GSC3000 SITE CONTROL SYSTEM

Set Your Sites High.



Site control has never been so easy. Gentner's GSC3000 is the next generation in site control.

Building on the breakthrough technology of the VRC2000, Gentner puts you in complete control of multiple sites at one time with the GSC3000!

Control all your transmission sites from a single PC or multiple PCs at different locations with the software that is included with each GSC3000. The limits are up to you. Get the benefits you enjoyed with the VRC2000 plus features that help you adjust to the changing broadcast workplace.

But, Gentner didn't stop there.

They made the GSC3000 the only modular, fully programmable, intelligent, stand alone remote control in the world.

Also, in emergencies, it will capture and log data. This will aid in the diagnosis and analysis of the event sequence that caused the emergency.

In other words: Sit back. Relax. And let the GSC3000 do the work.

Staying in control gets even easier when you accessorize.

Those options available include the Silence Sensor, Temperature Sensor, Wiring Interface, and/or a Command Relay.

It all comes down to this: You can set your sites as high as you want when you purchase a Gentner product— especially the GSC3000 Site Control System.

No matter what your site control needs, we have a solution for you. Call the Harris Broadcast Sales Center today for the details!



Control all of your sites in the comfort of your office from your computer.

Harris Corporation Broadcast Division

U.S.:
1-800-622-0022
FAX: 765-966-0623

Canada:
1-800-269-6817

<http://www.broadcast.harris.com>



The Big Story Was ...

Walden

Consolidation! The Telecommunications Act of '96 changed the face of ownership and radio probably forever. I think in the long run, it is going to be a good thing and help the radio business to remain economically healthy.

This year, broadcasters awoke to the fact that the entire world is changing to digital. Every other industry, except AM and FM broadcast in the U.S. has a clear path into the digital era.



Glynn Walden

Cell telephones are going digital, analog television is going digital, analog telephones are moving virtually to all digital, and radio too will be all digital in the not too distant future.

Consolidation and the ownership of AM/FM radio clearly make the case for an IBOC system for digital broadcasting in the United States.

Glynn Walden
Director of Engineering
CBS Radio

Fries

Obviously the number one issue is the change in ownership of radio stations due to consolidation. Close behind it, in my opinion, is the issue of the strong image of radio in regard to revenue ... the fact that radio has become a major item on the radar screen of the advertising community, and has become a major part of the marketing campaign of more advertisers that we've ever seen in the past.

I believe the benefit of the large groups to the advertising community has been the image awareness

that has come about by the megaplayers and the visibility that radio has gotten from these major companies, and the visibility that we've received in the standard press and the advertising trade press.

The image of radio, its notoriety and visibility, has been established in print. We see a lot more positive press, many articles ... in the "Wall Street Journal" and "USA Today" that have caused a very strong awareness of what the radio industry is doing and its relationship with its listening audience. ...

We have come to understand the requirements and the feelings of the DOJ as it applies to consolidation. A major portion of the year was consumed with just understanding the rules of the game and I think that the stage is now



Gary Fries

set for the radio industry to try to revisit some of those rules and explain to DOJ how the advertising income of radio truly works.

Gary Fries
President/CEO
Radio Advertising Bureau

Fritts

While, admittedly, self-promotion has not been our forte in the past, we have reached a time where it is necessary to point out to government policy-makers the amazing amount of public service that the broadcast industry provides this nation. I am confident the compilation currently underway of our nation's broadcasters' public service efforts will show that our industry is the country's largest public service provider.

Other stories include the enthusiasm of radio operators at our radio-only show this year that attracted a record crowd and left many attendees with standing room only. Our exposition in Las Vegas was attended by over 100,000, including a record number of radio attendees.

Radio also continued to fare well in Washington with bills calling for free and discounted political air time thwarted, attempts by lawmakers to eliminate the tax deductibility of advertising defeated, enforcement against pirate radio stations stepped up, and lines of communication enhanced with the Justice Department.

Eddie Fritts
President/CEO
National Association of Broadcasters

Arrakis Studio Furniture systems are #1 with over 1,000 sold!

The Master Control Studio, shown right, is one of seven Arrakis studios in Sony's Manhattan network origination center for SW Networks.



Arrakis furniture is #1 ...

- Off the shelf -or- Custom
- Easy to design & assemble
- Very fast delivery !!!

call today to find out why Arrakis studio furniture is the choice of broadcasters worldwide... from Moscow, to Tokyo, to Manhattan...

(303) 224-2248

or (970) 224-2248

1995 Arrakis Systems inc. 2619 Midpoint Drive, Fort Collins, CO. 80525



DB's new FM Mos-Fet power amplifiers.

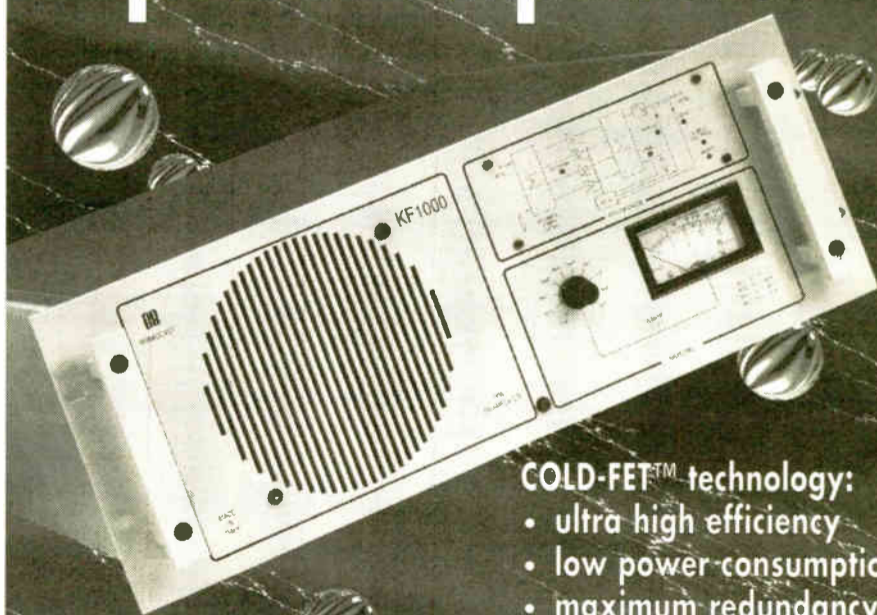

- MODELS:
- KF 300: 300 W
 - KF 500: 500 W
 - KF 1000: 1000 W
 - KF 2000: 2000 W
 - KF 3000: 3000 W
 - KF 5000: 5000 W

- COLD-FET™ technology:**
- ultra high efficiency
 - low power consumption
 - maximum redundancy
 - simplified set-up
 - proportional foldback protection system for uninterrupted service

DB

Electronica Telecomunicazioni

Via Lisbana, 38 - Zona Industriale Sud - 35127 Padova - Italy - Tel. +39 - 49 - 8700588 (3 lines) - Fax +39 - 49 - 8700747 - Telex 431683 DBE I
Internet: <http://www.dbbroadcast.com> - E-mail: sales@dbbroadcast.com

A 'Shakedown' Year for EAS

by Lynn Meadows

WASHINGTON Dec. 31 marks the end of the "shakedown" year for the Emergency Alert System. The first day of January 1998 marks the official A-OK date to retire your EBS decoder with a sledgehammer.

Frank Lucia of the EAS office at the FCC said his office had 32 final and 14 draft state plans in hand at the end of November. The remaining states were working on their plans and using interim plans to get by.

Many stations began the year with a last-minute shuffle to receive their new EAS equipment and install it. Rumors of visits by FCC officials checking on the status of EAS equipment stirred many stations out of complacency. According to Lucia, the compliance bureau did issue some violations, but he could not say how many. A spokesperson for the compliance bureau said no forfeitures were assessed for EAS violations this year.

Pro and con

Fresh from the experience of spending money on a government-mandated equipment purchase, and struggling to implement it locally, station managers and engineers expressed frustration early in the year. The debate over the worthiness of EAS spilled into the pages of *RW*. In a Guest Commentary, attorney Tom Taggart, part-owner of two West Virginia stations, dismissed EAS as a way of "preserving government jobs and creating new methods of legal extortion for those freeloaders at the FCC."

Taggart said his listeners had been better served during the Ohio River floods in 1996 by a dedicated fax line with reports from the local sheriffs and state patrol.

His blunt comments generated praise from some broadcasters who cheered Taggart for speaking out, and defense of the new EAS system from radio professionals involved in its design.

Paul Luke, president of the Emergency Communications Auxiliary of the Mid-South, agreed with Taggart's dismissal of EBS as a Cold War relic, but defended the new EAS.

"For those managers and owners who didn't care to take part in the development of their state plan, you have only yourselves to blame if you don't like the plan you were given," Luke wrote.

The contentiousness seemed to cool as the months passed and broadcasters began to work out the details of local implementation. By mid-year, EAS proved its worth in several states. During the Colorado floods, when a 20-foot wall of water tumbled down from the Rockies, the EAS alerted the public 75 minutes before the gush came through, Lucia said.

Lucia also cited an instance in rural western Nebraska in which a local sheriff got a message on the LPI station warning of a tornado heading towards the city. When a NOAA weather transmitter was knocked off the air in the Shenandoah Valley in Virginia, local LPI and LP2 stations sent out EAS bulletins regarding a tornado in the area.

EAS blunders made the news, too. One of the most notable was a test in April that caused hundreds of radio stations in Ohio, Florida and Louisiana to

transmit dead air. The test was meant only for WLS(AM) in Chicago, but a FEMA operator neglected to de-select stations in the other states.

The cause of that error became one of the items in the Society of Broadcast Engineers petition for rule changes submitted to the FCC.

Leonard Charles, chairman of the SBE EAS Committee, accepted hundreds of suggestions and complaints about the new system throughout the year. These were whittled down into 11

suggestions and submitted to the FCC.

The first three suggestions dealt with testing issues, a sore subject for many stations. For instance, there is a 15-minute relay window for the monthly test. The SBE suggested changing that monthly test to a quarterly test and extending the relay window to 60 minutes.

The FCC issued a Notice of Proposed Rule Making on the changes, as well as some suggested by the National Weather Service to add extra event codes. In late November, Lucia said a Further Notice of Proposed Rule making was pending.

Manufacturers are gearing up for the next EAS box purchase deadline. According to the FCC, all wired cable sys-

tems that serve 10,000 or more subscribers have until Dec. 31, 1998, to install EAS equipment and provide EAS audio and video messages on all channels.

Still looming over the manufacturers of EAS equipment is a patent issued to Larry Ganzer et. al. in 1992.

The technology in that patent addresses geographically specific emergency alerts and uses a composite code string that includes a location code string and alert code component. It is so similar to the technology used in the EAS boxes that Ganzer requested licensing agreements from some of the EAS manufacturers.

One source said the Department of Commerce Patent and Trademark Office has proceeded with a reexamination of the 1992 patent and in late November was awaiting a response from Ganzer.



Industrial Strength Digital Audio Delivery

Digital Audio Delivery systems are now recognized as a must for every broadcast facility. But few systems provide the features, flexibility or reliability required to maintain profitability in this demanding and fault critical application, nor the support mechanism to maintain them.

The ENCO DAD_{PRO32} Digital Audio Delivery System is simply the most powerful On-Air & Production system available. Based on the already widely accepted and mature DAD_{PRO} product, but now optimized for the Windows NT[®] operating system, DAD_{PRO32} is unique in its uncomplicated user interfaces and adaptability to any format, yet harnesses the power and reliability of proven technology.

- Intuitive On-Screen User Interfaces that are immediately familiar to operators. Optional Touchscreen makes Live Assist operation quick and easy.
- Complete On-Air flexibility for Live Assist, Automated, or Satellite Programmed operations, with transparent transitions between modes. Seamless Segues and Voice Tracking provide a continuously "Live" image.
- Powerful Production and Call Processing capabilities, including Graphic Cut & Paste Assembly Editing. Automatic Recording features are included for catching network feeds.
- Interfaces to all Music and Traffic Scheduling and Billing systems.

- Features full 32-Bit Processing and True Multitasking capabilities. Many third party programs, such as Multitrack Editors, Wire Capture systems and Word Processors may be directly embedded into DAD, or operated on the same Workstation.

- Inherent support of Global Wide Area Networking, for sharing of data between multiple facilities. Ancillary products are available for Store Forward operations and remote management of unmanned downlink sites.
- Operates on commonly available "off-the-shelf" computer hardware and network architecture, utilizing any of a wide variety of redundancy configurations.
- DAD is an outright purchase, and there are no monthly licensing fees. Free software upgrades are provided for the first year. ENCO technical support is legendary as the best in the business.



**Digigram
POWERED**

Call Your DAD Dealer or ENCO For Complete Information or Demo

**Check Out The ENCO Web Page At:
www.enco.com**

**ENCO
SYSTEMS, INC.**

24555 Hallwood Court, Farmington Hills, MI 48335 USA
Tel: 800-362-6797 or 248-476-5711
Fax: 248-476-5712 • www.enco.com

A New Piece of the AM Action

WASHINGTON For the past three years, news about the AM expanded band (1605-1705 kHz) was like a skipping record. First, the Federal Communications Commission would issue a proposed allotment plan. Next, petitioners filed Petitions for Reconsideration. Then, based on those petitions, the FCC would tweak its computer program and begin the process over again.

Construction permits granted

In 1997, the Audio Services Division attempted to push the record stylus ahead. After issuing a third proposed allotment plan in March, the agency

gave the 88 stations on the list 90 days to file an application for a construction permit. Sixty-seven filed in time.

In September, with two Petitions for Reconsideration still pending, the FCC granted two construction permits. KQXI(AM), Arvada, Colo., and KKSL(AM), Lake Oswego, Ore., both Christian broadcasting stations, were authorized to use 1690 kHz and 1640, kHz respectively. The two entities with outstanding Petitions to Reconsider had jointly filed a Petition to Deny all 67 applications.

Since September, more than 50 construction permits have been granted for the AM expanded band. Stations are

cropping up on the air up and down the new band. The only clouds are the two petitions and one case that has gone to the court of appeals. Stations still must apply for their licenses, but they will remain pending until the petitions and court case are finalized.

The ultimate goal of this process is to "improve and revitalize" the AM broadcast band. Stations will have five years to use both their old and new frequencies before they must decide which one to give back. Stations on the new band are authorized for 10 kW daytime and 1 kW nighttime.

—Lynn Meadows

The Top Radio Story Was ...

A "Wall Street Journal" article recently referred to the transformation of the "once sleepy" radio industry into a "red hot" industry, thanks to the merger activity permitted under the 1996 Telecommunications Act. I think that this characterization is very apt.



Linda Blair

Other important developments this year, from the regulatory perspective, have included proposals to relax other ownership restrictions such as the radio-television cross ownership rule; passage of the Balanced Budget Act, which mandates the use of auctions to resolve situations involving mutually exclusive broadcast applications; continuing initiatives to reduce regulatory burdens on radio broadcasters (e.g., the EEO rule making proceeding, the main studio rule making proceeding and the one-step licensing "Report & Order"); recent issuance of another experimental digital audio broadcasting license to USA Digital Radio; and issuance of over 50 construction permits for AM expanded band stations, with operations on several commencing before year's end.

Linda Blair
Chief, Audio Services Division
Federal Communications
Commission

DO THE MATH.

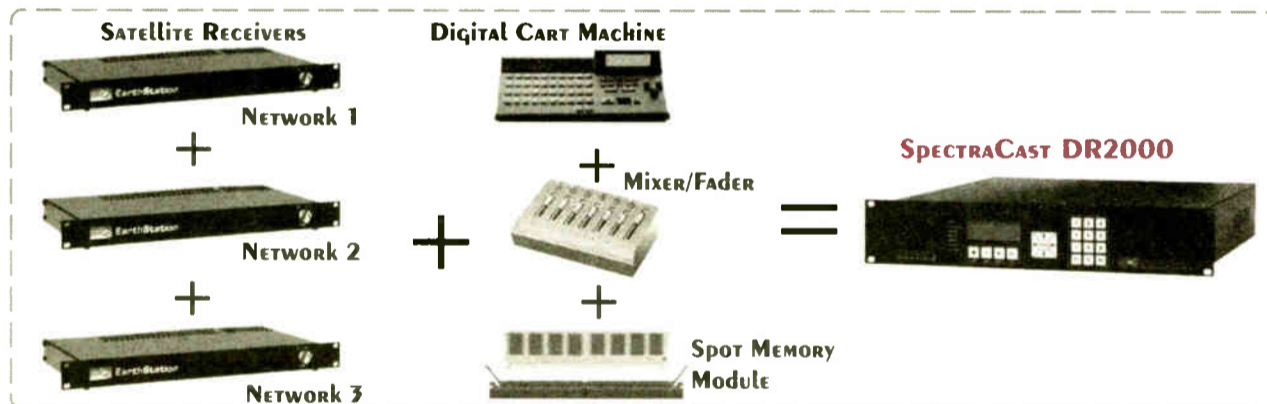

At Crown, we've been integrating technology since 1947. Our latest equation offers MPEG audio solutions for satellite network content delivery. We started with a bit-rate agile receiver. We added flash memory for store and forward use. We gave it multiple MPEG audio decoders and mixer faders. We put in Crown quality and reliability. It all adds up to the SpectraCast™ DR2000—an SCPC/MCPC receiver decoder.

For you, the sum total is a more efficient way of doing business. Now you can use one receiver for multiple network audio feeds and simultaneously record and play commercials, liners, PSAs, IDs, and even short format programs such as newscasts. In other words, you get the freedom of localization and all of the advantages of network programming—seamlessly—from one piece of equipment.

*Can we help you calculate
the possibilities?*

CROWN Satellite Receivers

- have *built-in, solid-state* flash memory for *store and forward*.*
- call for *spot rotations and playlists* under network or permissioned local control.
- allow for *spotcasting of regionalized commercials and local ad insertion*.
- offer multiple, stereo *MPEG audio decoders* and audio *mixers/faders*.
- include *bit-rate agile RF tuners* (BPSK/QPSK, operating from 64 kbps–2 Mbps in 1 bps increments).
- are *addressable* as individual units, as part of a group, or as part of a set of groups.



Phone: 800-598-6270; Fax: 219-294-8120
Email: spectracast@crownsat.com; Web: www.crownsat.com

*patent pending. SpectraCast is a trademark of Crown International, Inc.

MOVING?...

Don't leave us behind!

Mail or fax your current label and new address (with effective date) to:
Circulation, RW,
PO Box 1214
Falls Church, VA 22041 or
FAX 703-998-2966.

Address changes will be processed within four weeks of receipt. Thanks!

D I G I T A L F M T R A N S M I T T E R S

Someday They'll Wonder How We Did It!

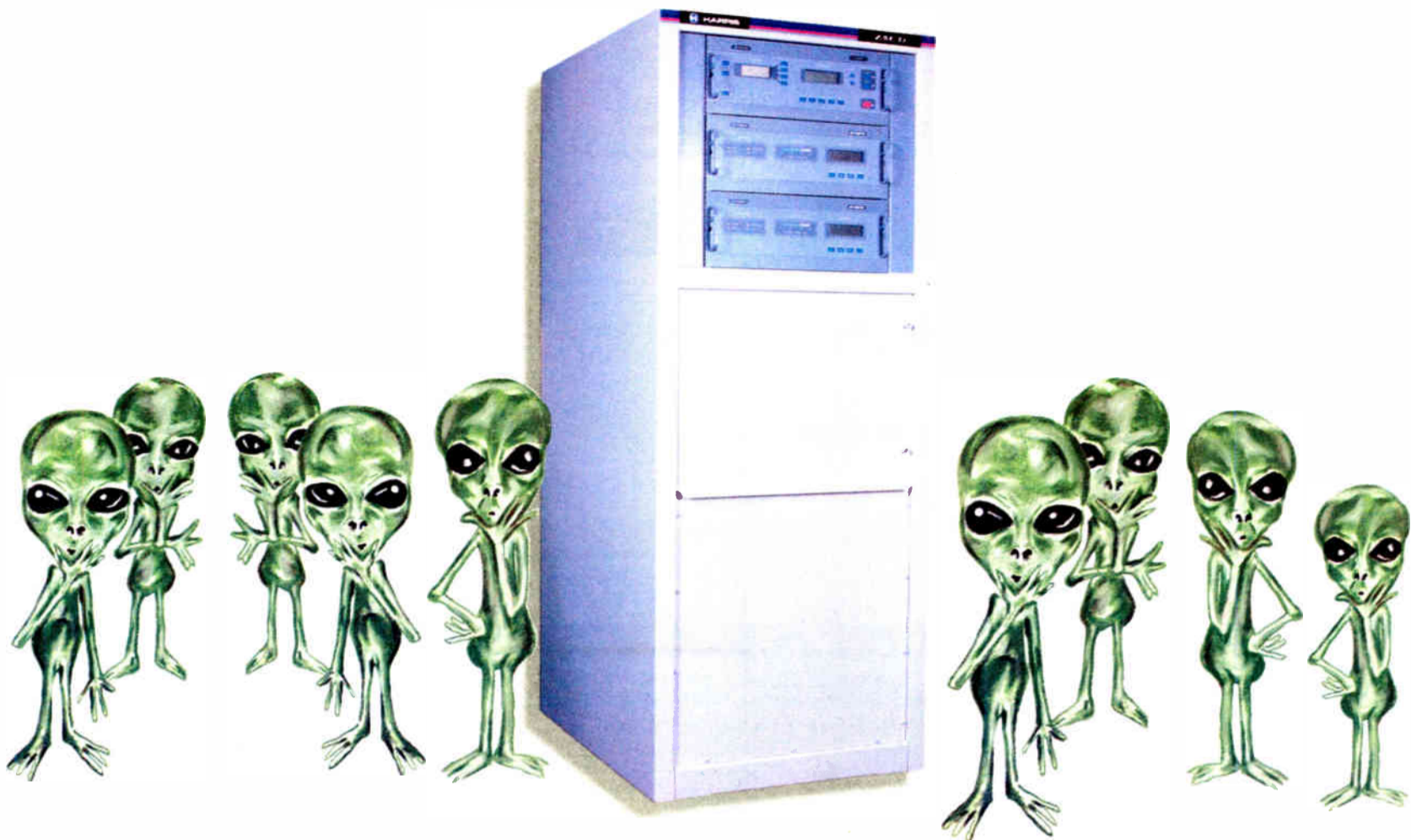

Platinum Z Solid-State FM Transmitters. "Here for future generations"

You have to encounter it to believe it!

Extraterrestrial CD-quality sound is provided by true digital FM generation. The **Platinum Z** provides the reliability of solid-state digital technology. The performance of digital modulation, and the confidence of third generation solid-state amplifier technology.

Platinum Z transmitters also use innovative Z-plane combining, which enable seamless transmission during maintenance and enhances redundancy. If you remove a hot-pluggable RF module from a **Platinum Z** transmitter at any time, for any reason, the remaining modules will compensate to continue broadcasting at nearly full power. Incredible RF module MTBF of 250,000 hours further ensures the reliable performance of **Platinum Z**.

Digital CD-quality phenomenal performance... solid-state reliability and redundancy...with a price comparable to tube type transmitters.



Harris Platinum Z Transmitters - Harris is not responsible for any extraterrestrial activity that might occur in the presence of a Platinum Z*
**Shown with optional second DIGIT CD™ Exciter*

Platinum Z features:

- Digit CD exciter (digital or analog input)
- Hot-pluggable RF modules
- Redundant IPA system
- Redundant power supplies
- Broadband design (N+1 capable)
- Life support backup controller
- Dual output power switching
- Built-in auto exciter switcher
- High overall efficiency

If you're wondering how the **Platinum Z** will fit in your budget, your space or how your human listeners and your ratings will increase... Stop wondering and give us a call, we're conveniently located right here on earth!



HARRIS CORPORATION BROADCAST DIVISION

U.S. and Canada
TEL:+1 217 222-8200
FAX:+1 217 224-1439
Elsewhere
TEL:+1 217 222-8290
FAX:+1 217 224-2764

<http://www.broadcast.harris.com>



HARRIS

A new world of broadcast solutions

Radio-FM: DIGIT CD™ Digital FM Exciter • SuperCiter™ Analog FM Exciter • CD LINK™ Digital STL • Quest Platinum and Platinum Z Solid State FM Transmitters • HT Single-tube FM Transmitters • FM Antennas **Radio-AM:** DX Digital Solid State AM Transmitters • GATES® Solid State AM Transmitters **Radio DAB:** DAB 2000 Transmitters **Studio Products:** Digital and Analog Studio Equipment **Systems:** Mobile and Fixed Studio and Satellite Systems

© 1997 Harris Corp.

Circle (106) On Reader Service Card

World Radio History

The Year of the Radio 'Pirate'

by Sharon Rae

WASHINGTON Perhaps it was a side effect of radio consolidation, or perhaps it was just part of a regular cycle. But 1997 seemed to bring more reports of low-power radio broadcasts, more cases of interference with licensed operations, and more FCC enforcement action.

Members of the low-power community, some of whom do not like being called "pirates," took a higher profile in 1997.

Calling the year's developments "a mixed bag" for micro-power broadcasters, Stephen Dunifer, founder of Free Radio Berkeley and a guru of the movement,

reports no "negative progress" in the quest for freedom of the low-power airwaves.

"The increased resistance we're getting from the NAB and the FCC are clear indications of the degree of success we're having," said Dunifer. "We've seen a lot of growth in the number of stations ... becoming true community stations with a lot to offer. Programming is getting better every month."

Dunifer, whose 24-7 Free Radio Berkeley runs on a staff of more than 100 volunteer programmers, is calling for



A New Jersey pirate rented billboard space.

what he calls "democratic communications media" in the United States. Dunifer was in the news in late 1997 when a U.S. District Court judge delayed action on an FCC request to shut him down. The case has been ongoing for almost two years. The FCC and Dunifer were due to back up their arguments in December. Both sides planned to argue the constitutionality of the FCC's request for an injunction.

Do it legally

"Some of the pirates say that the NAB is cracking down because we are against the various media voices," said John Earnhardt, director of media relations for the National Association of Broadcasters. "That is so far from true. In fact, we encourage it, just in a legal realm. Pirate radio stations are illegal. They interfere with legal broadcasters, not only through any advertising they may sell, but also through the wavelengths and strict interference."

Earnhardt said his focus is on protecting NAB members.

"We have encouraged the FCC to crack down on pirate broadcasters and they have done a good job with that," he said. "We are pleased the FCC has taken those actions; however there are still pirates out there ... and we certainly want them off the air because they are illegal."

An FCC spokeswoman told RW that, in a majority of cases, her office has been able to gain compliance with a simple warning.

"A lot of that has been through visits, warning letters and phone calls," she said. "In those areas where they have not fostered compliance, we have taken other measures such as seeking forfeiture of the equipment."

According to the spokeswoman, the FCC, in 1997, sought assistance through the courts in seven cases in which equipment was seized.

Sour grapes?
"1997 has been one step forward and two steps back," said Paul Griffin, founder of the Association of Micro-Power Broadcasters. "I think the FCC has been a sore loser because they were beat in the Dunifer court case and I think that's why they are being so hard core and trying to shut down these broadcasters."

Griffin said he believes both the level of enforcement against low-power broadcasters, and the number of such stations, increased in 1997.

"Because of media mergers there is a lack of local programming," he said. "In some areas people can't even get school closing information on local radio stations because (they are) satellite controlled. ... If people want to hear local information and news, they've really got to get their own radio station going."

Here are some of the enforcement actions taken against unlicensed broadcasters in 1997:

- "Party Pirate" Doug Brewer in Tampa, Fla., reportedly found himself in the

See PIRATE, page 17 ▶

See PIRATE, page 17 ▶

Who can help you utilize your top talent across all your locations?

WAN Wide Area Network



'nuff said!!

PSi
Prophet Systems, Inc
AudioWizard™ for Windows

Sales: (800) 658-4403
Support: (308) 284-8450
Sales & Support Fax: (308) 284-4181
E-mail: sales@prophetsys.com

► PIRATE, continued from page 16
middle of an enforcement raid in mid-November. One micro-power supporter described the enforcement tactics as "Gestapo," citing information from a Free Radio Berkeley press release: "Busting down the door ... by a Multi-Jurisdictional Task Force ... led by the FCC. With automatic weapons trained on them, they were ordered to the floor where they were handcuffed face-down with gun muzzles at their head."

The FCC had no comment for **RW** about the reported raid, referring only to a Justice Department press release dated Nov. 19, which made no direct references to it.

- Earlier this year, acting on a complaint from a licensed station, the FCC field office in Tampa shut down an FM operation in Fort Walton Beach. FCC Engineer Brian Marengo said illegal radio operations are "a fairly large problem" in Florida.

- The FCC sent warning letters to several low-power broadcasters in Milwaukee in July. The agency responded after an unusual joint complaint from all 20 licensed stations that make up the Milwaukee Area Radio Broadcasters Association. They complained that seven pirates were causing interference. The FCC district director said that both the number of illegal operators, and the joint response from the city's radio stations, were unusual.

- In November, the FCC seized equipment from an unlicensed broadcaster in Kansas City. FCC officials also shut down operations at a pair of Florida pirate stations that "were interfering with safe air traffic control communications at Miami International Airport and West Palm Beach International Airport."

- In September, federal marshals and an FCC field engineer pulled the plug on an FM operation in New Jersey. As reported in **RW**, the station had taken a public approach, renting a billboard and operating at an estimated 1.3 kW.

NEWS WATCH

Strawcutter Returns to Air

After a four-and-a-half month hiatus off the air, Pastor Rick Strawcutter is back broadcasting his anti-government, low-power message to southern lower Michigan from the Church of the Lord Jesus Christ in Adrian. Strawcutter voluntarily ceased operations mid-summer after allegations of interference with a Toledo translator.

"We have a new frequency at 99.3 from 97.7 FM," said Strawcutter. "We did a frequency search and see no way in the world we can interfere with anybody ... we added to our tower and put a new broadband directional antenna up. It works excellently and directs our signal toward the northeast."

Strawcutter's 95W signal has been a bone of contention with the FCC for over a year (**RW**, Jan. 8).

"He has been defiant and continues to do so," said John Winston, an FCC spokesman. "We cannot comment on the case under investigation."

The Top Story Was ...

I think if there is something to float to the top, it's the multiple ownership and multiple purchasing that has gone on across the entire country. From an engineering standpoint it's certainly had an impact.

For example, in some cases there has been one full-time chief engineer who is expected to keep four or five ... stations alive and well, and that can become a juggling act. There used to be a little more contract engineering done, but now it seems to be going toward one full-time chief engineer working for multiple stations. Now if all goes well, it's perfect, but if one,

two, three or more stations need attention in the same timeframe, it becomes kind of a risky business to keep everyone up and running.

Also, the frequencies required to conduct day-to-day business for both radio and television are becoming more scarce because the FCC has been mandated by Congress to share frequencies and to make frequencies available for other services. This could lead to interference issues down the road, especially in larger markets where there are multiple users.

Ed Miller
President

Society of Broadcast Engineers



Ed Miller



RDS is like a bumper sticker on your dashboard...



And now it's **FREE!**

Flash Comm announces
Free RDS for FM stations!

RDS is here today. Over 700 stations use it - many in large markets.

The radios are in the stores and on the car lots NOW. Most new '98 Ford Explorers have RDS radios.

They are also in Rangers, Cadillacs, Lincolns and all Jaguars.

Other manufacturers are following.

We offer the same digital features that big stations have, plus your own paging system. You get a full featured RDS encoder, control software, Alphanumeric RDS pager and an ADS Cadet PC card RDS radio. We pay for everything.

Then we'll pay you monthly to use it!

We only need one station per market, so even if you already have RDS, call us to get on the list and make sure that one station is yours.



Station Relations: tel (407) 752 3015

Email: Radio@Flashcomm.com

Visit www.flashcomm.com for more information.

FEED LINE

New Piece of AM Band Awaits

W.C. Alexander

This is the second in a series of articles about constructing an expanded-band AM facility. The first appeared Dec. 10.

The next step in planning your new expanded-band plant is to lay out a transmitter building. The best structure for a 10 kW transmitter building is a 20-foot by 20-foot masonry building. This is big enough to provide plenty of room for equipment, and plenty of air volume to aid in cooling. Masonry is the best choice for fire resistance and insulating properties, and, along with steel doors, provides

the best security.

Give careful thought to equipment layout, cooling airflow, lighting and the like. Floor troughs are a good, inexpensive means of getting the wiring around to the various racks and transmitters; or you may prefer to use overhead conduits.

Consider how you will get the transmission line or RF feed out of the building. If the building will be located adjacent to the tower, think about whether RF radiation shielding of the building will be necessary. Sketch out your ideas before presenting them to a local architect.

Before you can obtain a building permit, you will need sealed construction

drawings from an architect. Even if you plan to minimize cost and use some sort of



prefabricated building or trailer, you will still need a building permit and installation drawings.

With the transmitter building construction or installation drawings and tower foundation drawings in hand, you should be ready to go to the local building department and submit them for review

and a permit. A fee almost always is required, and the amount of the fee is based upon the projected cost of the job. If the architect did his or her job well, you will receive a permit within a few days. It is possible that the plan checker will find some deficiencies which must be corrected. If so, revisions will have to be made and submitted. At the end of this process, you will be ready to proceed with construction.

When selecting a contractor, do so carefully. Interview at least three general contractors to get a feel for how they work. Call their references and look at some of their building projects. Pay attention to the electrical and mechanical subcontractors selected by the general contractor.

Supervising the construction

The general contractor you choose will be acquainted with the building plans and certainly will know the applicable construction techniques. However, unless he has previously built a radio transmitter facility, he will not be familiar with many things particular to your project. You will need to be on hand to supervise as much as possible. Plan on making site visits at least once daily if you can, and bring up any concerns as they come up.

You should spend considerable time with the electrical contractor. Lightning protection is a big concern at radio station transmitter sites, and the electrical layout and grounding scheme will determine, to a large degree, how susceptible the site is to lightning damage. Wye connections are preferable to delta connections in almost every case, and you should make this clear to the electrical contractor. Surge suppressers should be installed on all solid-state transmitters, and depending on the geographical location and incidence of lightning strikes, you may wish to consider installation of some high-end lightning protection equipment on the AC distribution system.

Conduits will be needed to feed AC power, remote control, audio and monitor wiring to your transmitters and racks. You will have to supervise this part of the construction personally. Unless you are using floor troughs, you should plan on running everything in conduit.

The time to check for the proper placement, orientation and spacing of floor troughs is before the slab is poured. Immediately prior to pouring, you should check the position and construction of the forms personally.

The mechanical contractor is another sub with whom you should plan on spending time. The path of cooling airflow through the transmitters should be considered and planned. For example, if the transmitters draw air from the rear and exhaust it from the front, as many modern solid-state rigs do, plan for a cooling or ventilation airflow in that same direction. If you install a closed-loop cooling system, think about what will happen if the air conditioning fails. You will need some emergency means of ventilating the building that is consistent with the cooling airflow of the transmitters. A thermostatically controlled rooftop exhaust blower and louvered intake will do the trick nicely.

Cris Alexander is director of engineering for Crawford Broadcasting in Dallas. Contact him at (972) 445-1713 or via e-mail at cbceng@compuserve.com

Control Multiple Transmitter Sites from Anywhere



Gentner GSC3000 Radio Transmitter Remote Control

Key Advantages

- Control multiple transmitter sites from one location
- Access system via phone or by computer/modem
- Program unit to take its own corrective action
- Receive notification by phone, pager or computer
- Affordable modular system to handle from 8 to 256 channels of metering, status and control

Call BSW Today for Complete Details and Excellent Pricing on the GSC3000!

1-800-426-8434

Receive better value from BSW!

- Lower prices on all professional audio and broadcast equipment
- The most comprehensive inventory representing over 200 manufacturers
- Knowledgeable sales representatives with broadcast and studio engineering experience
- Fast, customized delivery to meet your needs
- Integrity, support and lasting commitment to you

BSW
BROADCAST SUPPLY WORLDWIDE

7012 27th Street West Tacoma, WA 98466 USA

FAX 800-231-7055
http://www.bswusa.com

Towering Holiday Greetings

Troy Conner

Unlike many folks, I actually look forward to winter. The cold and occasional snow drive me indoors and to introspection. The tower business usually slows down just enough for me to relax a bit and enjoy the season.

For me it is a time for family and friends, a time for good food and holidays. As always, it is also a good time for each of us to say thanks for our many blessings. During the extremes of the winter months I get a chance to catch up on planning and belated paper work.

Thanks to my readers

During the past year many of you have written, faxed or e-mailed comments and questions. I appreciate you taking the time to do this, and I hope I have answered your questions either directly or in a subsequent **RW** article. Please continue to pass on thoughts and ideas.

I would like to take the time to respond to a few of your many questions. Randy Henry from Titusville, Fla., asked about finding a capstan winch, a.k.a. a "cat head"-type rope puller. The last one I bought was a 12 V unit from the Surplus Center in Lincoln, Neb. (See box for the phone number.) We power our DC puller with a big deep cell marine battery and turn it on with a foot switch.

The larger winches typically used by tower crews are, for the most part, no longer part of marine use. Both offshore oil rigs and barge tugs use big double- and triple-drum machines. Winches from the timber, mining and general construction industries also show up here and there.

A true tower winch must be designed specifically for the long line/light load type. This is true particularly for gearing and braking. Most sizable tower firms have a number of winches appropriate for various loads and heights of towers. The weight of the line and headache ball of a big tower rig (1,000 to 2,000 feet) would probably collapse a small 200- to 300-foot AM tower. So mostly it is a matter of

matching the tool to job a hand, just like any other task.

Glenn Williams of Rio Grande, Texas, inquired about safety equipment. There are a multitude of manufacturers and even more distributor/retailers. One company that immediately comes to mind is DBI/SALA in Red Wing, Minn. They produce a full line of fall protection equipment.

Another company I often call for climbing equipment is Safety Test in Shelby, N.C., which supplies all kinds of neat stuff used by electrical, telephone and tree folks.

Miller, Klein and French Creek Products are also common names of safety equipment suppliers. Another name to add to this list is J.E. Weinel Inc. in Valencia, Pa., which has a catalog full of fun gear for rock climbers, SWAT and rescue teams, window cleaners, tree trimmers and cavers. As with any safety equipment, proper training and application are critical for safe use.

Stainless hardware

While I'm on the subject of suppliers, let me mention Site Advantage, based in Islandia, N.Y. These folks manufacture stainless transmission line hardware and associated supplies. The prices are right, and the stuff looks equal to the big-name guys.

Ed with Ed's Radio Service in New Strawn, Kan., is a contractor like me. He bemoans the condition of his clients' access roads. I couldn't agree more. Site access, specifically bad gravel roads, are a headache for many of us.

My guess, Ed, is that no one out there is familiar with the use of a machete or bush ax or chainsaw, and tractors with scrape blades and bulldozers are beyond their realm. Do what I do, Ed: Complain loudly and tell them next time there will be an additional charge if you have to

clear the road.

As I write, my mind is on Thanksgiving, which I plan to spend in Hilton Head, S.C., with my mom and girlfriend. Actually, my mind also is pondering all of the nit-picky problems I need to fix on my little sailboat before I can actually do some sailing.

Like they say, a boat is a hole in the water that you throw money into. If I do get everything running, I hope to run down to Savannah and meander my way up the river, if there is time. The marshes, islands and estuaries of coastal Georgia are some of the most inaccessible, and therefore, they are still relatively unspoiled and stunningly

beautiful to explore by boat.

Hopefully, a little sunshine on my cheeks will serve to lessen the memories of bitter cold and biting winds of February at 1,500 feet. Until next time, be safe, have great holidays and start the year renewed and motivated. 1998! Wow, can you believe 2000 is just around the corner?

■ ■ ■

Troy Conner is the owner of Tower Maintenance Specialists. Reach him by phone at (704) 837-3526 or via fax at (704) 837-1015.

Here are phone numbers for the companies mentioned in Troy Conner's story:

Surplus Center (800) 488-3407
DBI/SALA (800) 328-6146
Safety Test (800) 438-0671

J.E. Weinel Inc. (800) 346-7673
Site Advantage (888) 748-3238



63 Years Ago

Reprinted from Radio World
(November 10, 1934).

Editor's note: The RW of old, printed for a time in the 1920s and 1930s, and today's RW are unrelated except in name.

PROGRAMS CALLED VERY INFERIOR

By BRUCE BLIVEN
Editor, "The New Republic"

In advocating that we should put an end to the ceaseless flow of oral garbage into our homes which the radio at present provides, I am not suggesting that we should slavishly imitate the experience of any other country. I happen to believe after a good deal of first-hand experience that radio broadcasting in England is much better than in the United States; but I am sure that if we set to work really to reform broadcasting, we should be able to produce something better than exists anywhere else in the world. Certainly, being Americans, we should try.

I remember the days, fifteen years ago, when radio broadcasting was just making its appearance. At that time, we were all tremendously excited about the marvelous possibilities of this new force, which we believed would have the utmost usefulness, as a musical instrument, as a means of education and information, as a device for political debate. So far as America is concerned, these promises have not been fulfilled. What it does in the realm of serious music is a disgrace. What it does in the field of education is pitiful. What it does in the field of news is, broadly speaking, nothing. Our friends, the newspaper publishers, have effectively stopped all this work.

To be sure, an opponent of my views can bring forward a few good programs, most of them lasting the conventional fifteen minutes. It is like saying of a beautiful woman that she appeared in a white dress only part of which was dirty. Radio as at present constituted has driven away all persistent listeners except the morons—if you don't believe this, ask your friends. The rest of the population will never come back until they are assured that turning on the idle set will not be the equivalent of letting off a stench bomb in the family living-room.

ALTRONIC RESEARCH INC.

Performance By Design

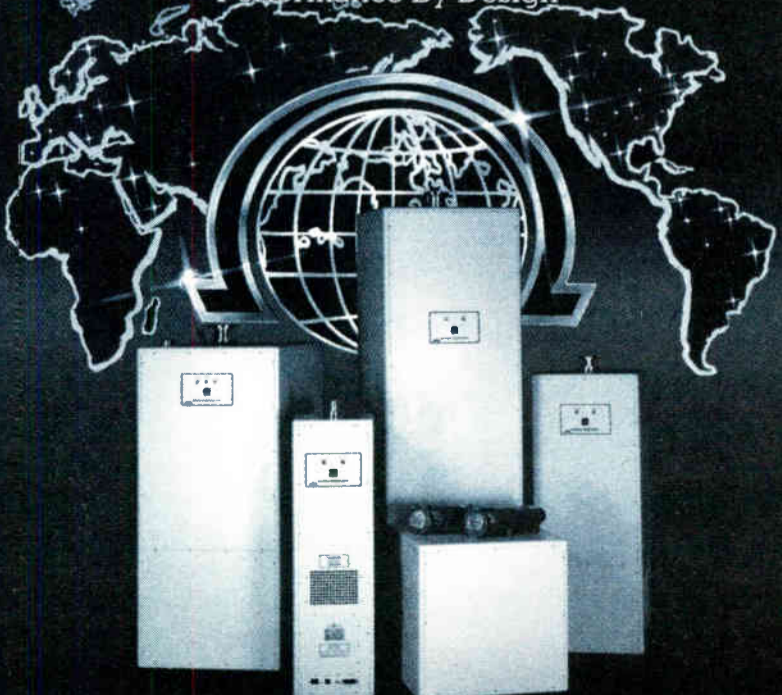

MANUFACTURER
OF RF COAXIAL LOAD RESISTORS.

DUMMY LOADS FROM 1 KW TO 1500KW,
AVAILABLE IN AIR, WATER OR SELF
CONTAINED HEAT EXCHANGERS.

HIGH POWER NON-REACTIVE CERMET
RESISTORS FROM 1 OHM TO 20 MEGOHMS.



ALTRONIC RESEARCH INC.

P.O. Box 249 • Yellville, Arkansas 72687 870-449-4093 • Fax: 870-449-6000
E-mail: altronic@mtnhome.com Web Site: <http://www.altronic.com>

SIGNAL TO NOISE

A Tale of Two MiniDisc Recorders

Frank Beacham

Over the past year radio journalists have discovered MiniDisc. The portable magneto-optical format from Sony, originally designed to replace the consumer audio cassette, is catching on because it clearly is superior to tape for news and documentary recording in the field.

Top choice

The 14-ounce Sony MZ-B3 MiniDisc portable has emerged as the recorder of choice for radio journalists. Not only is it "bullet-proof" reliable and compact, but it is the only portable MD model available with built-in microphone and speaker. Put that together with its non-linear, random-access search capabilities and the B3 adds up to a dream machine for audio journalists.

Yet, the B3 is not perfect. It could use a line-level output and sturdier connectors.

Then there is the issue of Automatic Gain Control. It works fine for most voice recording applications in the field, but at times it can cause problems. The inability to turn off AGC on the B3 can be troublesome when using the recorder for interviews with two microphones.

First, a little background. As is available on many audio recorders, Sony includes a feature on all their MD portables called "Plug In Power," a phantom power system for consumer mics. What Sony does not tell you is the 2.71 V delivered at this connector can power a pair of professional-quality lavalier condenser microphones as well.

With a custom wiring configuration that sends one mic output to the left channel and the second mic to the right channel, I use a pair of Millimics to record two-person interviews. I picked these tiny condensers, manufactured by Professional Sound Corp. in Calif., because they require only 0.9 V each to operate and can be powered directly off the mic connector for the recorder.

I use a special Y-cable adapter so I can

route a mic to each channel with full recorder powering. The male mic cable connectors are wired so that if I choose to use only one mic, it can be plugged directly into the recorder and will deliver sound to both channels.

This little rig was created to ease post production. By isolating the output of each mic to a separate channel in a two-person interview, editing becomes much easier. Being able to select either channel is especially useful when one of the speakers steps on the words of another speaker.

However, the AGC on the B3 introduces a potential problem with such a set-up. Because the recorder rides gain

ate phase cancellation between the two microphones. At least that is the way it sounds.

MZ-R30

I was able, however, to end-run the unwanted effects of AGC with the portable Sony MZ-R30 MiniDisc recorder (now with a new lower list price of \$449). The R30, introduced earlier this year, has no built-in mic or speakers, but it has the ability to set recording levels manually without automatic gain. When in the manual mode, recording with our two microphone set-up was artifact free and quieter than with the B3.



The Sony MZ-R30 With Headphones

on both channels in simultaneous lock-step, it forces the gain up on the mic that is not being used at any given moment. Here lies the trouble.

Best guess

Not only does this increase noise and sometimes cause unwanted pumping effects, but I found instances where an artifact resembling phase cancellation occurred. Though no definitive tests have been conducted to determine exactly what happened, a good guess is a bleed-through occurred somewhere in the signal path that allowed the AGC to cre-

Though the R30 is designed primarily for music recording and lacks some of the built-in conveniences of the B3, it should be considered seriously by audio professionals seeking the convenience of MD field recording. The manual level record feature alone makes it a perfect companion to the B3 when doing interviews on separate channels.

There is, however, a quirk with the manual record function of the R30. The mic level must be adjusted when the recorder is in the standby mode. You cannot ride levels while the recording is taking place. This is not as ominous as it might sound at first. I found the R30 to have a lot of headroom and this function is not a major inconvenience in most recording situations.

Because the target market for the Sony R30 does not include audio professionals, some of the features of the recorder are a bit buried beneath the surface. Example: Though the R30 has both mono and manual record capability, the instruction booklet provided with the recorder does not tell you how to use both at the same time.

The Sony U.S. marketing staff had to go to Tokyo to get the answer. First, follow the normal instructions to put the R30 in the manual level mode, then press the "mode" switch and wait until the words "Mono Record" appear and then disappear on the LCD. Now you can set levels. Once set, hit the "pause" button to begin manual level, mono recording.

The MZ-B3 and MZ-R30 from Sony are both excellent field recorders for audio journalists. The trick is to understand which recorder does what best and use it accordingly. One day, hopefully, Sony will acknowledge that their MD portables are being used by professionals. Then the company might muster its extraordinary engineering skills to combine the best attributes of both models into a single, compact, pro-level MD recorder truly optimized for audio journalism.

■ ■ ■

Frank Beacham is a New York-based writer and producer.

Do you have a field recording experience to share with RW readers? Tell us about it. E-mail your tale to pmclane@imaspub.com or write to the address on page 5.

KEYBOARD CONNECTION

The Right Time to Upgrade

Barry Mishkind

It is much like the day of the "Big Sale." Hundreds of people standing behind the counters, with hundreds of thousands waiting outside for the doors to open. As I write this, I'm getting ready to attend the annual playground for computer nerds, COMDEX. The fall trade show is where all the newest and best cybertoy can be found, with product introductions galore.

New and improved

Among the most "celebrated" introductions will be updates for some of the most popular programs. These may already be on your computer: word processors, graphics programs, office suites and utilities. In fact, you may have even recently received one or more notices by mail, inviting you to get the *very latest version* of your favorite software.

This leads to an important decision: Should you upgrade to the newer versions, or stay with what you have? For larger facilities using multiple copies of programs, it can be an expensive proposition, involving both the cost of the upgrade itself, plus the time to implement it at each work station. And remember, software companies expect you to have a "license" for each copy in use. Twelve workstations running 12 copies of Office97 require 12 licenses.

Now that you've returned from calculating (and/or fainting over) the cost of making every computer in the house "legal," let's talk about *why* you would want to upgrade.

Consider your options

There are two major reasons for the upgrade path. Obviously, if you buy a program and it does everything you could want, you don't need the upgrade. So software companies strive to add new features extending the capabilities of the program. In other words, you can do more, and do it more easily. That's one positive reason to consider some upgrades.

A second purpose of upgrades is to generate income. Only by encouraging you to acquire additional features can the company continue to generate money from the program's users. Normally, the upgrade price is a fraction of the normal retail cost, and a good deal.

On the other hand, I have several programs in my library in which upgrade fees actually have exceeded the cost of the original programs.

See PROGRAM, page 21 ►

Superior Broadcast Products

Quality FM Transmitters at Reasonable Prices

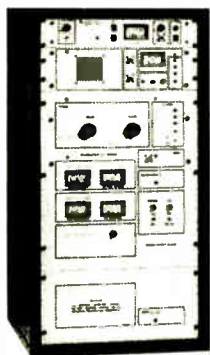

High Performance Solid State Exciter
Solid State IPA Amplifier
One Year Limited Warranty
Factory Service

On site check out by factory personal

1,000 watt	5,990.00
2,500 watt	10,990.00
5,000 watt	19,990.00
10,000 watt	22,990.00
15,000 watt	27,990.00
20,000 watt	32,990.00

Solid State FM Transmitters with Digital Exciter

120 watt	2,500.00	2,000 watt	12,990.00
300 watt	2,990.00	3,000 watt	19,990.00
1,000 watt	5,990.00	5,000 watt	29,990.00

STL Transmitter and Receiver Both Units ... 3,500.00

FM Translator Frequency Agile 2,500.00

Contact Jimmie Joynt/Superior Broadcast Product

Ph. 800/279-3326 972/473-2577 Fax 800/644-5958 972/473-2577

17194 Preston Road, Suite 123-297 Dallas, Texas 75248

► PROGRAM, continued from page 20

A survey by the CEO of a major software company found that as program version numbers increase, the number of features used by the average user rapidly decreases. It appears the average user simply needs fewer of the enhancements. But if you are satisfied with a program, and it does everything you need, keep it and be happy.

Many Windows users still use Windows 3.1, for example. In fact, at the corporate level, many have not upgraded to Windows 95 and don't intend to use Windows 98, waiting instead for NT5. Even your humble correspondent is composing this column on a DOS program from 1987. It works well, and doesn't get in the way of writing. (For more complex needs, I run WordPro, a graphical Windows application.)

Know your needs

Again, it is a matter of what you need to do the job. Just as some of the newer programs need faster processors and more memory, they may also require the newer operating systems. There are programs, for instance, that will run on Windows 95 and not Windows 3.1. Your choice in such situations is clear: You need to upgrade.

In general, if you find you can't do something important easily, an upgrade may solve your problems.

As you consider what features are needed at your facility (remember, not every user needs all the same features), don't forget to consider the programs from competing software manufacturers. Each continually leapfrogs over others with new features. Furthermore, many of the mainstream programs offer something called "competitive upgrades," a chance to upgrade from a competitor's program to theirs for a modest price. This can be an excellent way to meet your needs.

Bookshelf

Whether or not you decide to upgrade any or all of your programs, consider how you will support the upgrade.

With more companies charging for support, a natural place to turn is your local bookstore. You will find a wide selection of books designed to help you get the most from the different software programs.

As software matures, the list of features grows. So do book sizes, as authors try to explain everything about each feature in a program. Often, though, the process ends up providing so much information that sometimes you don't learn anything at all.

One of the most vexing problems in this situation is figuring out how to set up the programs so an application doesn't "get in the way" of user productivity. Furthermore, with Windows 95 and NT, the Registry has added a new level of complexity and annoyance in trying to get things set up right.

Indeed, "annoyance" is the way many people describe the hassles of trying to customize an application to their routine needs. O'Reilly and Associates have met this challenge by producing a series of "Annoyances" books, focusing on popular software programs, and how to find out what features solve your problems and just how to take control the interface. "Windows Annoyances" is set up to deal with customizing the Windows shell, and helping integrate different software

packages and utilities. Tips and workarounds are described in detail.

The information in these books from O'Reilly is complete with a number of

For larger facilities using multiple copies of programs, upgrading programs can be an expensive proposition.

Other "Annoyances" books focus on Excel97, Word97, even Office97. Would you like to know the quickest and easiest way to customize the toolbar, to make it do what you want it to do? Would you like to concentrate on the data and not the software? These books will assist you in doing just that. They will also tip you off to some useful features literally "buried" deep in the menus of the interface.

visual examples and how-to instructions. They are among the more readable books of this sort available. Further information can be found in your local book shop, or at www.ora.com

Barry Mishkind hasn't upgraded his e-mail address, and can still be reached at barry@broadcast.net or via his home page www.broadcast.net/~barry/

COMING SOON

Coming in
Buyer's Guide

-  Test, Monitoring & Remote Control
-  Microphones & Headphones
-  Digital Editing & Production

Only in
Radio World



102mkII \$369.00* FaxBack#1320
Legendary value and years of trouble-free operation in a rack-mountable mixdown cassette deck. Dolby B & C, Bias adjustment. A sweet machine for serious musicians.



112mkII \$849.00* FaxBack#1340
This classic TASCAM production workhorse is for personal and project studios. High stability servo direct-drive capstan, 2-memory locate, return to zero and rack-mountable.



112RmkII \$1,149.00* FaxBack#1360
Loaded with features, this 2-head, auto reversing workhorse is perfect for continuous play and many other applications. Exclusive Acculign™ rotating heads. A sound investment!



122mkIII \$1,349.00* FaxBack#1380
TASCAM'S best. The industry's finest 3-head stereo cassette mixdown deck. That's why it's the industry standard for production and broadcast. Balanced and unbalanced I/O. Bias, level and pitch controls. A true recording legend!

*All prices and specifications are subject to change without notification. "Retail" suggested prices are listed in the Manufacturer's United States Suggested Retail - ACTUAL PRICES MAY VARY BY DEALER.

CASSETTE DECKS BUILT TO LAST.



TASCAM cassette decks are overworked by the best in the business. Musicians, engineers, producers, broadcasters and contractors agree: TASCAM delivers performance that just won't quit. Look into nearly any recording studio, post house, broadcast facility or commercial operation. Odds are you'll find a TASCAM deck faithfully recording and reproducing on demand... day after day, year after year. The transports are legendary for their dependability. The standard for audio quality, every TASCAM cassette deck is engineered for lasting performance, from the drive motors to the electronics to the output jacks. And there's a model with the features — and the price — that are right for you. Even in these digital days, it's impossible to do business without a cassette deck. So choose the nameplate that gives you the edge in value, quality and longevity. Choose TASCAM.

Find out which cassette deck is right for you. Simply note the FaxBack number of the decks that interest you, call 1-TASCAM-8 or 1-800-827-2268, then follow the instructions. And comprehensive product info will be faxed to you within minutes.



TASCAM
TAKE ADVANTAGE OF OUR EXPERIENCE.

©1997 TEAC America, Inc., 7733 Telegraph Road, Montebello, CA 90640 (213) 726-0303 • TEAC Canada LTD., 5939 Wallace Street, Mississauga, Ontario L4T 1Z8, Canada (905) 890-8008
TEAC Mexico, S.A. de C.V., Privada Camino #18, Colonia del Carmen Coyacan, Mexico D.F. 04100 (525) 658-1943

Take Your Network Wireless

Wireless WANs Allow Exchange of Voice, Music, Logs and Data Without Licenses or Land Lines

Tom Osenkowsky

Wireless wide area networks (WANs) offer station owners a powerful way to manage multiple facilities.

Most of us are familiar with computer networks. They allow desktop computers, often referred to as workstations, to communicate with each other through a file server that acts as a storage facility and transfer point for our data. Most broadcast station networks are in-house, that is, under one roof. Today's broadcast environment may consist of one or more studios that are remote from each other. This would be the case for multiple-owned, or LMA-operated, stations.

In-house networks may be connected by twisted pair or coaxial cable. Networks often integrate digital automation systems, traffic, billing, programming and accounting systems.

Wireless networks have become popular in the business world, where offices frequently are relocated in a building in order to meet dynamically changing demands. Workstations can be moved in an instant, obviating the need for running new cables.

Many laptop computers are equipped with infrared ports that allow wireless interfacing to a workstation computer or laser printer. The wireless mode eliminates hardware interfacing and compatibility issues.

There are a number of wireless network options for broadcasters. Infrared or laser wireless transmission generally is used for short hops, such as between adjacent buildings. It is strictly a line-of-sight, short-range medium subject to snowfall, fog or heavy rainfall interruption. Transmission speeds can reach 115 Mbps (megabits per second). For those not familiar with common transmission speeds, the de facto standard for Ethernet transmission today is 10 Mbps, with 100 Mbps on the very near horizon.

RF transmission of network data ordinarily would require substantial bandwidth for high-speed operation. Two frequencies would be necessary for bi-directional operation. A newer technology, adopted from the military, solves the bandwidth issue and allows for a spectrum-efficient service. This is known as spread-spectrum mode.

You may have seen ads for secure, digital 900 MHz cordless telephones; most broadcasters know what GPS (Global Positioning System) is. These technologies use spread-spectrum mode for transmission.

Spread it around

Broadcasters are assigned one center frequency for their service. The main carrier is either amplitude or frequency modulated and occupies a certain amount of bandwidth in which the desired information is transmitted. AM stations, for example, occupy 10 kHz of bandwidth, and television stations occupy 6 MHz of bandwidth. FM stations are assigned a channel of 200 kHz bandwidth.

Spread-spectrum operation does not depend on one center frequency. Instead, a number of frequencies are employed, changing at a rapid rate. The dwell time, or amount of time any one frequency is employed before switching to the next, may be in the order of microseconds (millionths of a second). Spread spectrum may employ direct sequence frequency change, where each frequency is chosen in ascending order, or dynamic sequence, where the next frequency is chosen by a proprietary algorithm. The latter increases security and immunity from interference.

Spread spectrum has the obvious advantage of being less prone to interference than its fixed frequency counterpart. It also allows a greater number of users in a given band of frequencies. Imagine, for example, a music-oriented AM station that breaks for a five-minute voice newscast. Generally, voice frequencies are not very intense above 5 kHz. If we could "rent out" the unused bandwidth from 5 to 10 kHz during the newscast, the spectrum usage would be that much more efficient. This is where spread spectrum shines in comparison to fixed-mode

operation. It is spectrum efficient, allowing multiple users simultaneous operation in the same band.

The FCC has recognized the advantages of spread spectrum. Part 15 of the rules allows unlicensed devices such as spread-spectrum wireless networks to operate in the 915 MHz and 2.4 GHz region, among others. The 915 MHz region may be familiar to amateurs who share this 902-928 MHz band with Part 15 users. Analog and cordless telephones are found here, as are a number of other consumer devices. If you received a radar speeding ticket in the 1960s or early '70s, it was probably an S-band radar, one with the pen chart recorder and parabolic antenna, that nailed you.

Tonight's meal may be prepared in a microwave oven. The latter devices operate near the 2.4-2.4835 GHz ISM (Industrial Scientific Medical) band in which Part 15 license-free users reside.

Hardware

Typical Wireless Area Network 2.4 GHz antennas have a gain of 21 dBi (dB over isotropic radiator) with a 17.5 degree beamwidth and a maximum range of 25 miles. Typical range under rural environment is 16 miles, requiring at least 93 feet of Fresnel Zone clearance. (See page 23 for Fresnel Zone calculation.) Urban environment range typically is seven miles. The maximum EIRP available under FCC Part 15.247 Rules is 4 W. Other short-range systems operate in the 24 or 31 GHz range. For those familiar with frequencies this high, some long-distance telephone networks operate in the 23 GHz region and Ka band radar (Stalker brand being the most popular) reside here. Short-range broadcast STLs also operate in this region.

By now it should be obvious that an entire broadcast operation can be exchanged freely in a wireless digital environment. A completely digital broadcast operation, including all voice, music and data such as traffic logs, music logs and control tones, can be sent and received between two or more distant locations without the need for leasing expensive land lines.

While not inexpensive, WAN technology virtually is on par with digital STL systems as far as cost. If, for example, a licensee wished to have one air talent do voice work for several stations, he could "WAN" to all stations involved. The owner can perform all traffic, billing and programming functions from a central location to his remote "main studios." This would reduce the number of personnel and allow the most efficient use of talent and resources without leased line costs.

A single program director, news anchor, traffic manager and bookkeeper could, from a single site, operate several radio stations, each with its own distant automation and/or satellite system. Because the operation is bi-directional, any site could be used for control or programming, thus giving the station operator complete control over all facilities. Most WAN systems are Ethernet compatible with coaxial or 10 base-T interfacing. This means virtually any digital automation system, traffic and music system can be seamlessly connected via wireless LAN.

Wireless WAN technology is here. It is license-free and allows broadcasters to function efficiently in today's consolidated environment. Next time, we'll discuss

See WAN, page 23 ▶

Affordable Digital Automation

The screenshot shows the WaveStation software interface. At the top, there's a menu bar (File, Edit, Log, Tools, Setup, Window, Help) and a status bar showing the time (10:08:14) and date (February 26, 1997). Below the menu bar is a playlist table with columns for Row, Q, AirTime, Actual, Name, Length, Category, and Description / Command Line. The playlist includes items like 'CONGRATS', 'RADIO', 'CONGA', 'EURO', 'HARVEY', and 'WINNER'. At the bottom, there's a recording status bar showing 'Recording File: c:\baudio\HARVEY.wav Length: 01:30 Elapsed: 00:15' and buttons for 'Stop' and 'Cancel'.

Broadcasters around-the-world are discovering our easy-to-use WaveStation automation. Install our software on your PC and you have a powerful, versatile music-on-hard drive or satellite automation system. WaveStation comes with its own digital audio editor and uses standard or compressed WAV files. Full automation, voice track or live assist. Win 3.1 or 95.

**24 HOUR
FREE
TECH SUPPORT**

888-BSIUSA1

Only

\$999

Try Before You Buy.

Download the Actual Software!

www.bsiusa.com

BSI
Broadcast Software International

Circle (83) On Reader Service Card

Problem:

I need a new FM transmitter but prices are so high I may have to settle for used.

Solution:

The **ECO Series!** Rugged, Feature Packed & Reliable the **ECO** series was built with you in mind.

We've kept the cost low and the quality unsurpassed!

Benefit from lower operating cost with extra long tube life and lower power consumption.

Available in powers from 2-50 KW

**Great Products
Great Solutions!**

"The Transmitter People"

Energy-Onix

BROADCAST EQUIPMENT CO., INC.
PO BOX 801 ♦ 1306 RIVER ST.
Valatie, NY 12184
Phone 518-758-1690 ♦ Fax 518-758-1476
energy-onix @ energy-onix.com

Circle (153) On Reader Service Card

► WAN, continued from page 22
some specific facilities that have taken this approach.

Calculation

For those wishing to operate *extra ordinaire*, an on-site fully digital remote is possible, assuming adequate line of sight and Fresnel Zone clearance can be achieved. This would allow the on-site talent to access all music cuts, jingles and promos instantly. If your operations must be consolidated in the terms described above, it will first be necessary to determine if your facilities have the required line-of-sight clearance.

This determination usually is performed by a consulting engineer who is familiar with microwave transmission. For the do-it-yourselfer, topographic maps of the sites involved need to be purchased. Next, spot both sites and draw a radial line between them. Using X-Y graph paper, plot the intervening terrain vs. distance in appropriate increments. Mountainous terrain requires close-spaced intervals; relatively flat terrain requires less. Now calculate the required mid-path first Fresnel Zone clearance in feet using the following equation:

$$\text{clearance} = 1140\sqrt{d/f}$$

where *d* is path distance in miles, and *f* is frequency in MHz (i.e., 2400).

This equation yields the full first Fresnel clearance at a 4/3 earth curvature, however, in practice only 60 percent of the above amount is required. Check your X-Y graph to ensure that the tower heights chosen at each end yield the required Fresnel clearance at the path's midway point and complete line of sight is achieved.

Computer programs perform these calculations in a fraction of the time it takes to do them manually if you have the appropriate terrain data files.

If you clear this first requirement, you are all set to take the next step and plan out your network. If path clearance is a problem, a midspan repeater may be employed. This is not unlike a two-hop STL. It simply means the above calculations must be repeated for a third site. This repeater may be located at a mountaintop, tall building or multi-user site.

Once you arrange the network sites, the next step is to plan your system. System planning would now be no different than a hard-wired network, except the distances are greater and there are no ISDN, T1, Switched 56, modem or other leased land line costs.

■ ■ ■

Tom Osenkowsky is a consulting engineer based in Brookfield, Conn. He has written extensively for RW. Reach him at (203) 775-3060 or e-mail at tosenkowsky@delphi.com

BOOK REVIEW

Radio, Twisted to Evil Ends

John Montone

As the Nazis were coming to power in Germany, radio was coming into its own as the dominant medium of the era, a fact not lost on Joseph Goebbels, the propaganda minister of the Third Reich.

How Goebbels used radio to further the evil objectives of the Nazi regime is the subject of "Hitler's Airwaves," a meticulously researched book that comes with a compact disc containing many of the news reports and musical parodies emanating from the studios of the German Broadcasting Company, Reichs Rundfunk GmbH or RRG. "Hitler's Airwaves,"

co-authored by Horst J.P. Bergmeier and Rainer E. Lotz, is published by Yale University Press.

Nazi propaganda

The Nazis, recalling the reluctance of the German high command to use propaganda during World War I, were obsessed with propaganda as a means to gain an upper hand. To Goebbels, "radio was central to the concept of an all-embracing propaganda at home and abroad." He also spoke of a combination of military "air strikes" and "mind-bombing."

Goebbels' problem at home was that many Germans did not own radios. To

remedy that, the Nazis produced an inexpensive radio called "The People's Set," or "Volksempfänger," giving Hitler access to almost the entire population.

In 1938, the Nazis began foreign-language broadcasts that spread a message of anti-communism and anti-Semitism. The main target of the Third Reich was England. Later, over shortwave, the Nazis broadcast across the globe to North America, Africa and Asia.

The announcers often were from America and Britain, and after the war many would be tried and convicted of treason. One of the most notorious was

See NAZI, page 25 ►

Bringing Portable Mixing to the Next Level.



Impressively quiet and with more features than many mixers twice its size, the Shure FP32A set a new standard in field production.

Now comes the FP33. With new high-precision sealed input potentiometers, an improved battery switching circuit, internal headphone level adjustments, and durable 3.5mm jacks, the FP33 takes portable mixing to the next level.

Professional Mixing That Goes Wherever You Do.

The Shure FP33 is a 3-input, 2-output portable mixer specifically designed for:

- Remote audio recording
- Electronic field production
- Electronic news gathering
- Location film production

The FP33 weighs just 3.5 lbs and is about the size of two video cassettes. Providing 8 hours use with just two 9V alkaline batteries — or powered by any 12 to 30 VDC power supply — the FP33 will go wherever you do.

Quiet Enough For DAT.

The FP33 has an exceptionally low self-noise and a wide dynamic range — making it perfect for use with DAT and other digital recording media.

So Many Features In So Little Space.

The new FP33 gives you all the features of the FP32A and more, including:

- Sealed, conductive plastic input potentiometers
- Dynamic range of over 100dB
- 48V phantom, 12V phantom and 12V T (A-B) power
- LED indicators of input levels, output peaks, limiter action, and low battery
- Pop-up pan pots
- Link switch to couple inputs 2 & 3 into a stereo pair
- Mix bus to connect an additional FP33 or FP32A
- Comprehensive headphone monitoring control with MS stereo matrix
- Internal DIP switches for over 4,000 customized set-ups

If you're looking to bring your mixing to the next level, make sure to pick up a Shure FP33 portable stereo mixer.

THE SOUND OF PROFESSIONALS... WORLDWIDE® **SHURE**

SAS 16000



Wired thing

Y O U M O V E M E

The 16000 Audio Routing System is the powerful new compact switcher from Sierra Automated Systems.

This spirited performer really moves audio around—with operational ease and long-term reliability.

Completely self-contained, the 16000 handles 32x32 routing in a mere two rack-units. Through a variety of schemes utilizing off-the-shelf, pre-made cable assemblies and cross-connect blocks,

system interconnect is now faster than ever before.

This switcher gives you full-system access 'XY' controls; plus a bright read-out for displaying inputs/outputs, and system settings. Source and destination confidence monitoring is available via the convenient front panel speaker.

The 16000 makes everything easy—with programmable salvo switching, stereo linking, PC software control,

scheduled event switching, universal serial ports for distributed control networks, and employs the full range of SAS remote control panels.

The 16000 moves with high-octane performance. The control system is versatile and thorough. Quality and reliability are never compromised.

Wired thing... We think you'll love it. For more information about the SAS 16000, please give us a call.



Sierra Automated Systems and Engineering Corp.

2112 North Glenoaks Boulevard
Burbank, California 91504

818 840 6749 Voice
818 840 6751 Fax

'Hitler's Airwaves'

► NAZI, continued from page 23

Mildred Gillars, a failed actress from the United States who broadcast under the name "Axis Sally." Through words intended for the ears of American GIs, Axis Sally worked to lower the morale of those troops by wondering aloud what their girlfriends were doing back home while they "carried out the orders of Roosevelt, Churchill and the Jewish Gangsters."

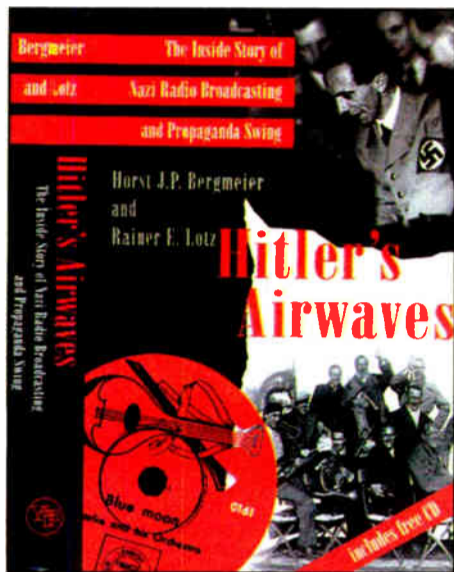

Propaganda on the radio took many forms. One was the use of so-called "Black Stations." These broadcast outlets operated from covert locations and their programs mixed truth with outrageous lies. One such outlet, called "Station Debunk," claimed to originate in central Iowa. A typical news flash reported that General MacArthur's car had just run over and killed several American soldiers. One covert station mimicked the British Broadcasting Corporation, confusing listeners by running actual BBC programs with propaganda spliced in.

Set to music

Another form of Nazi radio propaganda was known as "Propaganda Swing," political parodies set to American jazz and big band music.

The use of jazz to make American soldiers feel homesick or just to mock the enemy was somewhat controversial in that the Nazis considered such music, with its black origins and sensuous rhythms, to be decadent and below German moral standards.

Although various methods were used to wage the propaganda war, Eugen Hadamovsky, the program director for the RRG, summed up the Nazi Propaganda Ministry's golden rule when he said, "The only thing that matters in broadcasting is the Fuhrer's voice."

Co-author Lotz said the book is purposefully divided into two parts, one dealing with radio propaganda in general and the second with the use of jazz, particularly a band called Charlie and His Orchestra.

Clever campaign

As for the radio campaign, Lotz said the Germans were "very clever" in getting British listeners to think they were tuning in the BBC and then interrupting those broadcasts with propaganda messages. Lotz said, "The announcers on the BBC would hold their breath during announcements and then the German propagandists would invade the airwaves."

Lotz also explained why the Nazis felt the need to aim jazz broadcasts at the Americans, essentially entertaining the enemy even when the often-changed lyrics

mirrored the Nazi philosophy.

"The idea was to make the listener think about your point. Make him laugh but also make him have second thoughts," Lotz said. "It was satire. They didn't believe the enemy would throw up their arms and surrender or the English would change their minds about the Nazis just because they said, 'Churchill was a drunk ruling England from a bathtub.'"

Audio accompaniment

A compact disc containing news and musical programs broadcast by the RRG comes with the book. Lotz said it was important to include the spoken word, even though the CD contains material that some might find offensive.

"Some people have objected to the CD as sick," he said. But similar criticisms were not made about printed quotes within the book of those same broadcasts, Lotz said.

There is a notable absence in both the book and CD: The authors never indicate whether the Nazi use of radio to spread propaganda was successful. Perhaps anticipating that question, Lotz said, "It was the one thing we were unable to find out. The people most likely to be involved did not want to talk about it. We ran into closed doors."

But Lotz said the number of people in Britain tuning into German broadcasts did decline steadily. "In the beginning," he said, "a lot of people in Great Britain were sympathetic to the Third Reich. But the BBC stayed true to the facts and eventually the British

people realized the Nazis were lying. They then lost credibility."

Like the BBC, Lotz and Bergmeier stick to the facts in "Hitler's Airwaves." Their book is written with such painstaking attention to detail that the compelling narrative of the Nazi radio propaganda blitz often takes a back seat to the exploration of such tangential subjects as the internecine battles for control of the Propaganda Ministry.

Still, the book is a treasure trove for serious students of broadcasting, and the CD is an invaluable piece of oral history.

"Hitler's Airwaves" is available from Yale University Press in Connecticut. Call (800) 987-7323.

■ ■ ■

John Montone is a radio reporter for 1010 WINS(AM), New York. Send him e-mail at jfmontone@worldnet.att.net

Holiday Cheer²



The latest innovation from Tascam gives you double the DAT power of anything else out there this season.

THE TASCAM DA-302 IS IN STOCK, AND NOW COMES WITH EXTRA CHEER: 10 FREE TDK DAR-60 DAT TAPES!



Tascam DA-302

- **Duplicating double DAT recorder/player**
- **High-speed dubs**
- **2 masters at one pass**
- **8 hours of continuous record/play**
- **Dual S/PDIF connections**
- **Optional balancing and interconnection kits**

Tascam brings a whole new meaning to the word "versatile" with the powerful DA-302. It offers options you simply could not have considered before, like high-speed DAT dubs complete with time code copying! The DA-302 functions as two completely separate units—to give you two masters in one single pass—or as one double, continuous recorder for up to 8 hours of record/play power. With Tascam's Append Dubbing function, you can start dubs at any location on the

master. And, of course, it features dual S/PDIF connections for digital transfers and archiving, plus output selection in either S/PDIF or AES/EBU. And just to underscore its amazing versatility, the DA-302 offers great expansion capabilities, such as the optional LA-D302 balanced analog I/O kit and the WR-7000 kit for interconnecting multiple DA-302s. Never has something so full of features been such a great gift.

Bradley

BROADCAST & PRO AUDIO

Our Service Makes The Difference

12401 Twinbrook Parkway • Rockville, Maryland 20852

Toll Free: 800-732-7665 • Tel: 301-231-7800 • Fax: 301-230-6526

<http://www.bradleybroadcast.com> • E-Mail: info@bradleybroadcast.com

World Radio History Circle (12) On Reader Service Card

Robust Modem and Coding Techniques for FM

Brian Kroeger,
Denise Cammarata

Part 1: FM System Overview, Channel State Information and Adaptive Weighting

Dr. Brian Kroeger and Ms. Denise Cammarata are working on the development of USA Digital Radio In-Band, On-Channel Digital Audio Broadcasting (IBOC DAB) system at Westinghouse Wireless Solutions. Westinghouse is leading the development and is working with USADR joint development partner Lucent Technologies. This article is the first of a four part series reprinted from a technical paper written by Dr. Kroeger and Ms. Cammarata on the IBOC FM system. The paper was presented during the Countdown 2000 — an Update technical session at the September 1997 NAB Radio Show. The second in the series will cover CPC (Convolutional Punctured Codes).

The third article will detail the interleaver design and the fourth will discuss the results of the FM system simulated in the presence of multipath fading and first adjacent interferers. More information on USADR and IBOC is available at www.usadr.com

Abstract

The design of robust modem and FEC (Forward Error Correction) code techniques with application to the transmission of an FM Hybrid analog/digital IBOC DAB signal is presented here. The FEC codes are derived from an original lower rate convolutional code ($R=1/3$). The original code is segmented into a pair of "complementary" components, which form independent codes, each with a higher rate (less redundancy) than the base code. The exploitation of Channel State Information (CSI) and special interleaving techniques are described for application to FM Hybrid IBOC DAB with its unique interference environment and selective fading due to multipath. Simulation results confirm the robustness of the design.

Introduction

The focus of this paper is on the FEC, interleaving, CSI estimation and adaptive symbol weighting for the FM Hybrid IBOC DAB system. A system overview along with analysis and simulation results on the mutual interaction among analog FM and DAB signals, adjacent channel interference, and time diversity of the analog FM and DAB signals were presented at the 51st Annual Broadcast Engineering Conference (NAB) in April, 1997 [1].

Forward error correction and interleaving improve the reliability of the transmitted digital information over a corrupted channel. Complementary Pair Convolution (CPC) FEC code techniques were developed for ARQ schemes where retransmissions were coded using complementary codes instead of simply retransmitting the same coded sequence [2]. Construction of CPC codes is derived from previously published puncturing techniques [2,3,4]. The CPC code technique allows individual transmissions to be combined to form a more powerful code than the sum of the individual transmissions.

IBOC DAB is an ideal candidate for the application of CPC codes because the digital DAB transmission is accomplished over two sidebands (upper sideband and lower sideband) which are potentially impaired by nearly independent interferers with independent fading. If one sideband is completely corrupted by a strong first adjacent FM signal in the vicinity of the receiver, the opposite sideband must be independently decodable at the receiver. Therefore each sideband must be coded with an independently decodable FEC code.

However, when both sidebands contain useful information that is not completely corrupted by an interferer, then CPC codes provide additional coding gain above that achieved by power combining the two sides. Furthermore, CSI and OFDM interleaving techniques have been developed to deal with the unique interference and selective fading characteristics of the FM IBOC DAB channel.

FM hybrid IBOC DAB parameters

A brief description of the FM IBOC DAB system is presented. Details of the FM IBOC system presented here are updated since the presentation of a previous paper [1]. The PSD of a typical FM broadcast signal is nearly triangular with a slope of about -0.35 dB/kHz from the center frequency. First adjacent FM signals, if present, would be centered at a spacing of 200 kHz.

Although FM channel spacing in some countries is 100 kHz, these first adjacents are geographically separated such that FM reception is not impaired within the coverage area. Therefore this should pose no problem to the FM IBOC system. The DAB to DAB interference at 300 kHz spacing can impair performance on one sideband, but the CPC code is designed to tolerate this condition.

In the baseline FM IBOC design, 95 OFDM subcarriers are placed on each side of the host FM signal occupying the spectrum from about 130 kHz through 199 kHz away from the host FM center frequency as shown in Figure 1.

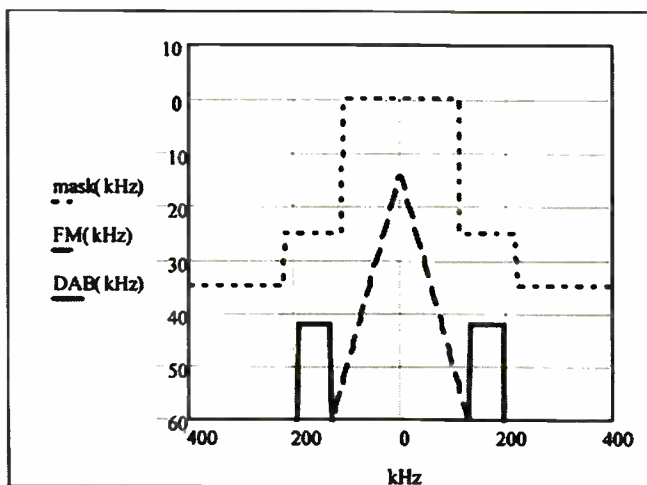

Figure 1. Power spectral densities of FM and DAB signals below FM spectral mask.

The total DAB power in each sideband is set to about -25 dB relative to its host FM power. The individual OFDM subcarriers are QPSK modulated at 689.0625 Hz (44100/64) and are orthogonally spaced at about 726.7456055 Hz (44100*135/8192) after pulse shaping is applied (root raised cosine time pulse with 7/128 excess time functions as guard time). The potential subcarrier locations are indexed from zero at the FM center frequency to plus or minus 275 at the edges of the 400 kHz bandwidth.

The outside assigned subcarriers are at plus or minus 274 with a center frequency of plus or minus 199,128 Hz. The inside information bearing subcarriers of the baseline system are located at plus or minus 179 with center frequencies of plus or minus 130,087 Hz. The pilot subcarriers are located at plus or minus 178 with center frequencies of plus or minus 129,361 Hz. The subcarriers are differentially coded across frequency using the inside pilot subcarriers as the reference for the first differentially detected symbol. These reference (pilot) subcarriers are modulated with an alternating sequence to permit assistance in frequency and symbol timing acquisition and tracking. Recent evolution of the design shows that adequate acquisition and tracking performance is achievable without the pilots.

In the presence of adjacent channel interference, the outer OFDM subcarriers are most vulnerable to corruption, and the interference on the upper and lower sidebands is independent. Because the PSD of an FM broadcast signal is nearly triangular, then the interference increases as the OFDM subcarriers approach the frequency of a first adjacent signal. The coding and interleaving are specially tailored to deal with this non-uniform interference such that the communication of information is robust.

The IBOC DAB system will transmit all the digital

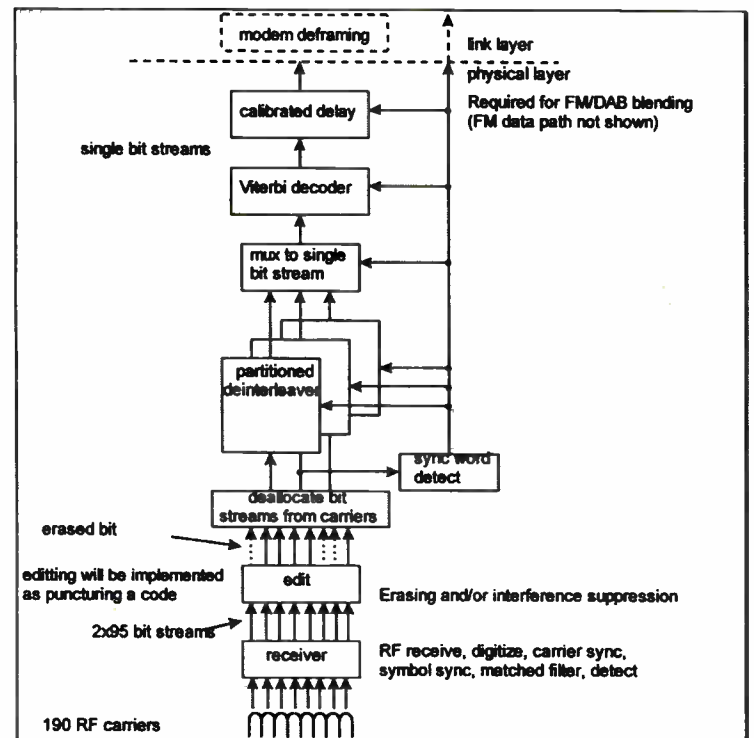

Figure 2. Functional diagram showing the mapping and processing of bits through the receiver, deinterleaver, and FEC decoder.

audio information on each DAB sideband (upper or lower) of the FM carrier. Although additional subcarriers beyond the baseline system can be activated to enable the transmission of all the code bits of the rate 1/3 FEC code, the baseline system employs a code rate of 2/5.

Each sideband can be detected and decoded independently with an FEC coding gain achieved by a rate 4/5 (optionally rate 2/3) convolutional code. This redundancy permits operation on one sideband while the other is corrupted. However, usually both sides are combined to provide additional signal power and coding gain commensurate with a rate 2/5 (optionally rate 1/3) code. Furthermore special techniques can be employed to demodulate and separate strong first adjacent interferers such that a "recovered" DAB sideband can supplement the opposite sideband to improve coding gain and signal power over any one sideband.

A simplified functional block diagram of the flow of the demodulated bits in an FM IBOC receiver is shown in Figure 2.

CSI and adaptive weights

Soft-decision Viterbi decoding with (near) optimum soft-decision weighting for maximum ratio combining (MRC) for differentially detected QPSK subcarrier symbols is employed to minimize losses over the channel. Because the interference and signal levels vary over the subcarriers (frequency) and time due to selective fading, timely CSI is needed to adaptively adjust the weighting for the soft-symbols. The CSI estimation technique should be designed to accommodate a fading bandwidth of up to 13 Hz for typical vehicle speeds in the FM band around 100 MHz.

An expression for the weighting factor can be derived assuming gaussian noise into a differential QPSK detector resulting in non-gaussian statistics at the output. The fading factor can be computed as a function of the statistics of the output of the differential detector where we define the soft decision of the form

$$S = (a + n_1) \cdot (a \cdot e^{j\phi} + n_2) \quad (1)$$

where ϕ denotes the phase information imposed between a pair of adjacent symbols in the differential encoding, and n are the independent noise samples. The fading factor a of the adjacent symbols is assumed to be approximately equal. The signal-to-noise ratio after differential detection is easily

Hybrid IBOC DAB Solution

computed to be

$$SNR = \frac{a^4}{2 \cdot a^2 \cdot \sigma^2 + \sigma^4} \quad (2)$$

The ideal weighting factor for the post-differentially detected symbols is therefore

$$w = \frac{a^2}{2 \cdot a^2 \cdot \sigma^2 + \sigma^4} \quad (3)$$

The first differential approach described here uses statistical estimates of the second and fourth moments of the differentially detected symbol magnitudes to form the weighting factor. These second and fourth are described by the following relationships:

$$E\{|S|^2\} = (a^2 + \sigma^2)^2 \quad (4)$$

$$E\{|S|^4\} = (a^4 + 4 \cdot a^2 \cdot \sigma^2 + 2 \cdot \sigma^4)^2$$

Then the fading factor can be estimated as

$$\hat{a}_k = \sqrt[4]{2 \cdot E\{|S_k|^2\} - \sqrt{E\{|S_k|^4\}}} \quad (5)$$

and the noise can be estimated as

$$\hat{\sigma}_k^2 = \sqrt{E\{|S_k|^2\}} - \hat{a}_k^2 \quad (6)$$

The estimates of equations (5) and (6) are inserted into equation (3) to obtain the weight.

Simulations were performed using adaptive weighting as described in equations (3), (5), and (6). Although long-term estimates without fading yielded good results, a compromise must be reached between long filter time constants for accurate estimation versus short filter time constants needed to track varying statistics due to fading.

In our Digital Audio Broadcasting simulation, the OFDM symbol rate of 689.0625 Hz was chosen with a fading bandwidth of 13 Hz. Then the reciprocal of the fading bandwidth is about 53 symbols in this case. A filter time constant of 16 symbols was chosen because this time constant must be small compared to the fading time. Unfortunately, the statistical estimation errors over this short filter time yielded poor performance results for the adaptive weighting compared to what would be possible with perfect statistical estimation. Even reducing the fading bandwidth down to 3 Hz and increasing the filter time constant to 64 samples left a significant loss.

Equations (5) and (6) reveal that, in effect, quantities raised to the fourth power are subtracted to yield smaller numbers. This situation is most pronounced when the signal and noise powers are approximately equal, resulting in large estimation errors. Simulation results support this observation. Therefore another estimator is sought that does not rely upon subtraction of fourth order statistics.

Pre-differential detection statistics

The optimum soft-symbol weight to be applied before differential detection of QPSK can be described as a function of time (k index) and OFDM subcarrier (n index). Similar to equation (3), this weight is

$$w_{k,n} = \frac{a_{k,n}}{\sqrt{2a_{k,n}^2 \sigma_{k,n}^2 + \sigma_{k,n}^4}} \quad (7)$$

where $a_{k,n}$ is the fading coefficient of the kth symbol for the nth subcarrier, and $\sigma_{k,n}$ is the corresponding standard deviation of the noise or interference, both prior to dif-

ferential detection. Notice that the weight of equation (7) is the square root of equation (3). This is a result of the reasonable assumption that the weight changes slowly over the symbol-pair time used in the differential detection. In effect, the differential detection squares the predetection weight of equation (7), which would result in equation (3). A method for improving the statistical estimates of equation (7) is sought.

Practical CSI and Pre-Detection Weighting

Practical methods for estimating CSI and weights using pre-differentially detected soft-symbols and weight also applied to the soft decision symbol prior to differential detection are explored here.

For moderate to high SNR, the weight of equation (7) could be conveniently approximated by

$$\lim_{SNR \rightarrow \infty} w_k = \frac{1}{\sigma_k} \quad (8)$$

where simple statistical measurements were used to estimate σ^2 . However, simulation confirmed that this weight estimate performed poorly during times when the SNR was very low due to fading interference. For example, the optimum weight would have suppressed the noisy samples more than the high SNR approximation to the weight. Therefore, another approximation was sought which would estimate CSI statistics over a large SNR range.

Furthermore the estimate should not be sensitive to a gaussian noise or interference assumption, and should be estimated with sufficient accuracy in a time (filter time constant) significantly less than the reciprocal of the fading bandwidth.

A simple and robust estimation technique evolved after simulation and some experimentation. This estimation technique approximates the previously defined weight expressions, but uses lower-order statistical approximations and satisfies the compromise between statistical accuracy and agility to track the fading signal. This technique is described in the following four steps:

1. Create a sequence $v_{k,n}$ for each QPSK subcarrier consisting of the magnitudes of the complex soft decision outputs $s_{k,n}$ from the matched filter for the nth subcarrier.

$$v_{k,n} = |s_{k,n}| \quad (9)$$

2. Create a sequence $d_{k,n}$ consisting of the differences of successive time samples of $v_{k,n}$.

$$d_{k,n} = v_{k,n} - v_{k-1,n} \quad (10)$$

3. Filter the sequences $v_{k,n}$ and $d_{k,n}$ using second-order digital IIR filters, then compensate for any differences in effective group delay to yield sequences $filtv_{k,n}$ and $filtd_{k,n}$. The time constant for the $filtv_{k,n}$ filter should be somewhat smaller than the reciprocal of the fading bandwidth, while the time constant for the $filtd_{k,n}$ filter can be somewhat larger. These sequences are representative (approximately proportional) of the local mean and standard deviation of the sequence $v_{k,n}$.

4. The sequence of weights for the soft decisions for each subcarrier to be applied prior to differential detection is defined as

$$w_{k,n} = \frac{1}{filtd_{k,n} \cdot \left(1 + \left(\frac{filtd_{k,n}}{filtv_{k,n} - filtd_{k,n}}\right)^4\right)} \quad (11)$$

To prevent numerical overflow, check to ensure that $filtv_{k,n} > 1.5 \cdot filtd_{k,n}$ in equation (11); otherwise, set the weight to zero. Simulation results verified that this weight yields good performance under a variety of channel impairments with fading and interference.



Smoothing filters for statistical estimates

The values of $filtd_{k,n}$ and $filtv_{k,n}$ are estimated using filtering techniques described next. Filtering is performed first for each subcarrier at the kth symbol instant in time. Then the rows of $filtd_{k,n}$ and $filtv_{k,n}$ are simply updated across the N subcarriers. Equation (12) filters the sequences $v_{k,n}$ with a time delay of approximately 16 symbols, and equation (13) filters the sequences $d_{k,n}$ with a time delay of approximately 64 symbols. Both filters have a zero frequency gain of nearly unity.

$$subv_{k,n} = \frac{960 \cdot subv_{k-1,n} - 451 \cdot subv_{k-2,n} + 3 \cdot v_{k,n}}{512} \quad (12)$$

$$subd_{k,n} = \frac{16128 \cdot subd_{k-1,n} - 7939 \cdot subd_{k-2,n} + 3 \cdot d_{k,n}}{8192} \quad (13)$$

Additional filtering is performed across the N subcarriers. Smoothing the estimates across the N subcarriers requires three passes of a simple IIR filter. The first pass sets the appropriate initial condition of the filter, but does not update the estimates. The direction of the second pass is reversed from the first, while the third pass is reversed again. This results in an approximately symmetric (linear phase) filter characteristic which is desirable for providing the estimates on the center carrier. Although it is impossible to provide this symmetric filtering for the subcarriers at each end of the band, the impulse response "tails" are folded back into the active subcarriers.

The first pass across the subcarriers sets the initial values of $filtv_{N-1}$ and $filtd_{N-1}$ without replacing the time-filtered values for each subcarrier. The time index k is ignored here because it is understood that the filtering over the subcarriers is performed over each kth OFDM symbol.

$$\begin{aligned} filtv_{N-1} &\leftarrow (1-\beta) \cdot filtv_{N-1} + \beta \cdot subv_n; \\ filtd_{N-1} &\leftarrow (1-\beta) \cdot filtd_{N-1} + \beta \cdot subd_n; \\ n &= 0, 1, \dots, N-1 \end{aligned} \quad (14)$$

The second pass smooths the values across the filtered estimates for each subcarrier, $subv$ and $subd$.

$$\begin{aligned} filtv_n &\leftarrow (1-\beta) \cdot filtv_{n+1} + \beta \cdot subv_n; \\ filtd_n &\leftarrow (1-\beta) \cdot filtd_{n+1} + \beta \cdot subd_n; \\ n &= N-2, N-3, \dots, 0 \end{aligned} \quad (15)$$

The third pass smooths the frequency values again to achieve a nearly symmetrical impulse response (except for the subcarriers near the endpoints).

$$\begin{aligned} filtv_n &\leftarrow (1-\beta) \cdot filtv_{n-1} + \beta \cdot filtv_n; \\ filtd_n &\leftarrow (1-\beta) \cdot filtd_{n-1} + \beta \cdot filtd_n; \\ n &= 1, 2, \dots, N-1. \end{aligned} \quad (16)$$

The resulting filtered values for $filtv$ and $filtd$ are used in equation (11) at each OFDM symbol time to yield the appropriate weight for each soft symbol prior to differential detection, but after matched filtering, in the receiver.

Products & Services Showcase

For more information on the products shown below, circle the appropriate Reader Service No.(s) on the enclosed Subscription/Reader Service card or contact the advertiser directly.

Composite Audio DA and Switcher!



The CDS-200 Composite DA/Switcher

APPLICATIONS

- Switching Between Composite STL's
- Main/Alternate Processing Switching
- Feed Two Transmitters and an RDBS Encoder
- Feed one SCA Generator to Two Transmitters
- Distribute Composite with the Ease of Audio

FEATURES

- 2 Input Switcher
- 3 Isolated Outputs
- Individual Level Control for Each Output
- Front Panel and Remote Control with Full Status
- Power Fail Memory with Bypass Mode
- Inputs Selectable for Balanced or Unbalanced Operation
- Front Panel Test Jack



Broadcast Devices, Inc.
5 Crestview Avenue, Peekskill, NY 10566
broadcastdevices@worldnet.att.net

Tel: (914) 737-5032 FAX: (914) 736-6916

READER SERVICE NO. 24

Phase 3 4x1 Routing



RS-41A 4x1 Stereo Audio Router, RS-41V 4x1 Video Router, RS-41S 4x1 SVHS Video Router, and RS-41D 4x1 Data Router

Desktop or rackmount. No AC adapters.

Broadcast quality throughout. No compromises. Please call for a complete catalog of Phase 3 products.



(416) 293-1042 Fax: (416) 297-4757 www.videoquip.com

READER SERVICE NO. 48

Earn some Christmas cash...

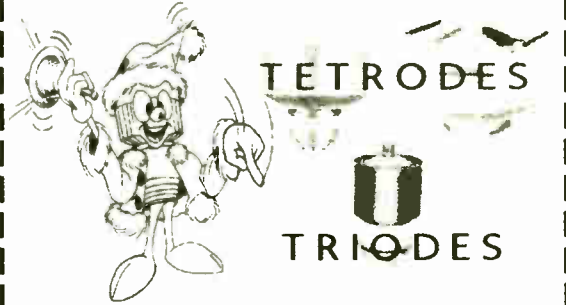

We Buy Duds (used tubes)

Freeland Products, Inc.

"Your best source for quality rebuilt transmitter tubes since 1940."

75412 Highway 25
Covington, Louisiana 70435 U.S.A.

1-800-624-7626

(504) 893-1243 FAX (504) 892-7323

www.freeland-inc.com

Email freelandproducts@worldnet.att.net

READER SERVICE NO. 72

Remote Satellite Control!



List \$299.00

DSC-20 Dual Satellite Controller

The DSC-20 adds remote control capability to the Scientific-Atlanta ENCORE, DSR-3610, AD-4595 and Virtex StarGuide II receivers, allowing channel memory changing by automation systems or simple push buttons. The DSC-20 can be configured to control any two of the above mentioned receivers. Customized programming is accomplished with a non-dedicated computer.

- Two separate 20 contact closure remote ports
- 100 memory selections in PC mode (ENCORE)
- 20 memories for ENCORE in contact closure mode
- 20 eighteen-character printable ASCII serial strings in PC mode (StarGuide II)
- 20 network channels for StarGuide II in contact closure mode
- Supports channel swapping function in StarGuide II receivers
- 9600 baud RS-232 or RS-485 PC control programming port (either locally or remotely via optional modem)
- Two 9600 baud RS-232 receiver serial ports
- Nonvolatile program memory plus a password ID option

Check out our web site for product information, list pricing and a list of distributors!

Voice 360 428 6099
Fax 360 428 6719



Internet: www.broadcasttools.com E-mail: bti@broadcasttools.com

READER SERVICE NO. 96

Buy simplicity, reliability and service

EAS

Price \$1750.00

Equipment is in stock for immediate delivery!

Phone 740-593-3150

GORMAN-REDLICH MFG. CO.

257 W. Union St. Athens, Ohio 45701

FAX 740-592-3898



- 5 two-way RS-232 inputs/outputs for computer, remote signboard & character generator
- 4 audio inputs on standard models (expandable to 6 audio inputs). All audio inputs & outputs are transformer isolated from encoder-decoder board.
- Automatic interruption of program audio for unattended operation.
- 4 line 40 character LCD display with LED backlighting
- 20 key keypad to program unit, set modulation level, set input levels
- Will handshake with automation equipment.
- 2 year warranty
- 2 minutes of digital audio storage (expandable to 4.5 minutes)
- 25 pin parallel printer port for external printer
- 52 terminals on the rear to interface with other equipment by removable plugs.

Web Site: www.gorman-redlich.com

◆ Also available: printers, weather radios, antennas for weather radios, crystal controlled synthesized FM digitally tuned radios, remote signboards, cables for interconnection, character generators.

READER SERVICE NO. 120

NEW LOW COST FM TRANSMITTERS & POWER AMPLIFIERS



PRICES

Exciters	Power Amplifiers
10W.....\$1375	150W.....\$1,815
	300W.....\$2,750
	500W.....\$3,663
	1000W.....\$7,326

All of the above need just 10W drive

CALL 408-448-3342 FOR DETAILS

READER SERVICE NO. 144

Attention Advertisers!

Reach 18,000+ broadcasting professionals! Place your ad in **Products & Services Showcase** advertising section and it will appear bi-weekly in the pages of **Radio World**.

For more information on rates, deadlines contact

Christopher Rucas at Radio World
Phone: 415-922-5595
FAX: 415-922-5597



Putting Live Audio in the Mix

Mike Sokol

One of the more interesting challenges of radio work is live recording of a performing group.

If you are not careful, the end product can turn out unbalanced, distorted and over-reverberant. Most of these challenges remain when performing a live mix for a radio or television feed.

The problems occur when the same mixer is used for both "front of house" (FOH) sound and a record/broadcast feed.

Stage sounds

In normal-sized venues, some stage sounds need a lot of reinforcement and others need little. An FOH mix yields very loud vocals and almost no backup.

In dedicated recording situations, a mic splitter sends one signal to three mixers, allowing individual FOH, stage monitor and recording mixes.

At a live event, such luxuries are not likely to be available. So here are four ways to make your recordings or broadcasts better.

Split the stereo feed. When recording a full act directly to two tracks, split the feed into instruments and vocals.

Pan the vocals hard left and the instruments hard right, recording them on separate tracks. This split helps yield the proper level of vocal-to-instrument mono mixing in post-production.

Use a Mix-B bus. If recording real stereo is a priority, use the Mix-B bus. This is a "board-within-a-board" with separate tone, pan and level controls.

Typically it can be fed from the

multitrack Tape Returns or from the input channels themselves. A separate, unaffected mix for recording or broadcast can then be built.

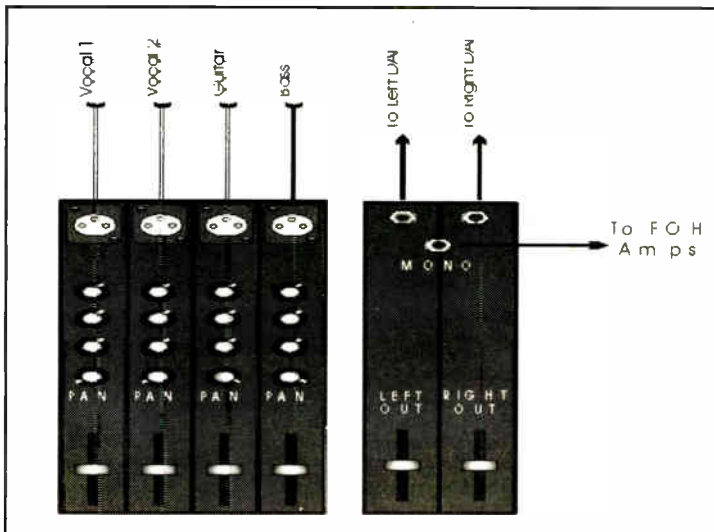

Hard-pan vocals and instruments for post-production.

get custom in-ear monitors. Top-level stage performers use them with wireless feeds, but they also work great when plugged into the mixing board.

The drawback: A set of silicone molds must be made by an audiologist. Silicone is pumped into the ears. The compound hardens after 10 minutes and the molds are sent to a company to be duplicated in soft rubber with high-quality transducers imbedded in them.

These monitors cost about \$700, not including the molds. It seems like a lot of money for something that only fits one person, but it is worth it. They create an entirely isolated mixing world, cut off from all surrounding room noise.

Short of being in a separate room isolated from house sound, in-ear monitors are the best way to mix for recording or broadcast in a live venue.

Limit effects

Finally, *easy on the effects.*

Everyone likes reverb and echo. That extra room tone instills confidence in performers and makes the FOH mix seem bigger.

The only problem is that, without the visual reinforcement of the large room, a mix with a lot of reverb will sound awful when played back. If a Mix-B bus is being used, then there is no problem — unless one of the input channels is being used as a reverb return. In that case, add little (if any) of the reverb return back to the recording mix.

It is possible to add reverb in post

Mackie, Behringer, Allen & Heath and other eight-bus boards offer Mix-B buses.

Monitor everything. You can't know what is being recorded without being able to hear the mix. Use good, closed-ear headphones or invest in in-ear monitors.

Isolate the ears

These allow an engineer to get a proper balance without compensating for the sonic bleed of the room noise into the brain.

For instance, when mixing bass guitar, low-frequency sounds can leak through just about any headphone, causing an engineer to reduce the bass in the mix.

Closed headphones are much better than open-air phones, but still lack some isolation. If the price tag is manageable,

FM Hybrid IBOC DAB Techniques

► DAB, continued from page 27

REFERENCES:

- [1] B. Kroeger, P. Peyla, "Robust IBOC DAB AM and FM Technology for Digital Audio Broadcasting," 51st Annual Broadcast Engineering Conference (NAB), Las Vegas, Nevada, April 1997.
- [2] J. Cain, G. Clark, Jr., & J. Geist, "Punctured Convolutional Codes of Rate $(n-1)/n$ and Simplified Maximum Likelihood Decoding," *IEEE Trans. Information Theory*, Vol. IT-25, pp. 97-100, Jan. 1979.
- [3] Y. Yasuda, K. Kashiki, Y. Hirata, "High-Rate Punctured Convolutional Codes for Soft Decision Viterbi Decoding," *IEEE Trans. Comm.*, Vol. 32, #3, Mar. 1984.
- [4] J. Hagenauer, "Rate-Compatible Punctured Convolutional Codes (RCP Codes) and Their Applications," *IEEE Trans. Comm.*, Vol. 36, No. 4, pp. 389-400, April, 1988.

Belar Stereo Monitor

You can measure...

with the best monitor and the most accurate test set.

The FMM-2/FMS-2 series monitors provide an even greater degree of precision measurement than ever before... **You can measure** S/N below 90 dB, **You can measure** crosstalk below 85 dB, **You can measure** separations of better than 70 dB, **You can measure** frequency response to better than 0.25 dB, **You can measure** distortions to lower than 0.01%, and much more... Our uncluttered panels and autoranging voltmeters make these measurements a dream.

BELAR ELECTRONICS LABORATORY, INC.
LANCASTER AVENUE AT DORSET, DEVON, PENNSYLVANIA 19333
Call or write for more information on Belar AM, FM, Stereo, SCA and TV monitors.

(610) 687-5550

Circle (36) On Reader Service Card
World Radio History

production, but once a recording has a lot of reverberation, it cannot be removed from the mix.

If the outputs are being summed and the channels split for vocals and instruments, then the only possibility is to use as little reverb as possible with the FOH sound and hope it is not too much for recording.

I like to record the soundcheck with effects and listen back to see how the reverb sounds in the mix, then adjust to taste.

By following these four tricks of the live-sound trade, an ideal broadcast feed is sure to result.



Mike Sokol can be reached at his audio/video production studio, JMS Productions, via e-mail at jmsokol@intrepid.net

Problem:

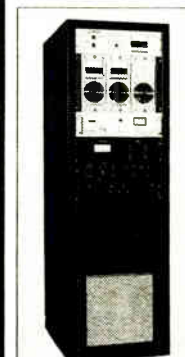

I have a duopoly. I need back-up transmitters for my stations:

Solution:

Don't buy two transmitters-- buy ONE!

Our Legend Series, Solid State, FM transmitters are Frequency Agile and Broadband. Your engineer can instantly tune one to any frequency!

We've designed the Legend Series to ensure long transistors life with "wind tunnel" cooling & brute force power supplies.

Legend Transmitters make perfect main transmitters too!

Available from 1KW - 11KW

Two or more stations;
One back-up transmitter.
GREAT IDEA!

**Great Products
Great Solutions!**

"The Transmitter People"



BROADCAST EQUIPMENT CO., INC.
PO BOX 801 ♦ 1306 RIVER ST.
Valatie, NY
Phone 518-758-1690
Fax 518-758-1476
energy-onix @ energy-onix.com

Circle (60) On Reader Service Card

Products & Services Showcase

For more information on the products shown below, circle the appropriate Reader Service No.(s) on the enclosed Subscription/Reader Service card or contact the advertiser directly.

* Receive FREE gift with catalog *

FREE
1997
H.L. DALIS
CATALOG
OVER 350 PAGES

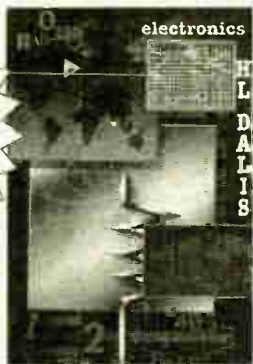

Audio, Video & Broadcast Engineering Supplies

Since 1925

Authorized Distributor for over 250 Major lines including Kings Broadcast, Belden, Neutrik, Canare, John Fluke & Motorola

Call, Fax or E-mail Stanley Marks for your Free Copy
[NY] Ph.: 718-361-1100 Fax 718-392-7654

Nationwide **1-800-HLDALIS**

E-mail: Hldalis@aol.com

H.L. DALIS Inc.

35-35 24th St, Long Island City, NY 11106

TRIED THE REST? NOW TRY THE BEST!

READER SERVICE NO. 47

HIT THE ROAD, JOCK!

Produce and run your show On Location **EXACTLY** the way you would from your studio!

THE MITS ROADSHOW SYSTEM

The first and only system that lets you use and control your multi-line phone system from your remote broadcast location. Includes full status and control of up to 15 lines, LCD "screener" call-data display, 5 ACTION KEYS for remote control functions and much more!



Take control of your phones! CALL:

Broadcast Telephone Systems



email: info@innovadev.com
web: www.innovadev.com

1-888-890-7424

Innovative Devices, Inc.

READER SERVICE NO. 71

WATTCHMAN® TRANSMITTER PROTECTION SYSTEMS



WATTCHMAN® protects your transmitter and transmission line system. A permanent 19" rack installation used with any dual socket line section 7/8" through 6 1/8" and elements (additional) to monitor CW, TV, and FM power. Model 81070 features two easily read meters to monitor both forward and reflected power. Abnormal conditions quickly cause transmitter shut down.

TERMINATING LIQUID/AIR LOADS (84000/85000 series) available to cover CW power ranges of up to 10,000 Watts over a frequency range of DC to 2.4 Ghz. All models are available with optional thermal overload switches to interface with the user's interlock or warning circuit.

NEW

COAXIAL DYNAMICS, INC.

15210 Industrial Parkway
Cleveland, Ohio 44135 (216) 267 2233
Toll Free 1-800-COAXIAL (262-9425)
FAX: (216) 267-3142

Web Site <http://www.coaxial.com>
Email: coaxial@apk.net



READER SERVICE NO. 95

Uh-Oh...  ...We Should Have Called **CORTANA**

STATI-CAT for Affordable Lightning Prevention.

Let Us Design a System for You

Stati-Cat provides a continuous, low-resistance discharge path for the static electric charge on tall structures. Dissipation points are 1/8", type 304 stainless steel rods ground to needle sharpness. They won't bend, not even from ice and severe weather.

Cortana
Corporation

Write to us today for a **FREE** brochure!

P.O. Box 2548, Farmington, N.M. 87499
Call 800-325-5336 FAX (505) 326-2337

READER SERVICE NO. 22

"Real-time" 15 kHz ISDN Audio



When you need to send wideband ISDN audio without long coding delays, look to Comrex. Our "turbo" G.722 codecs deliver 15 kHz bidirectional audio with minimal delay.

List price only \$1500. Call today!

COMREX® Comrex Corp, USA

Tel: 978-263-1800 Fax: 978-635-0401

Fax-on-Demand: 978-264-9973 (Doc #101)

READER SERVICE NO. 46

ATI Audio DA's. The



HEIGHT

of performance.

CALL OR WRITE NOW FOR FREE DETAILED BROCHURE.

328 W. Maple Ave.
Horsham, PA 19044, USA
(215) 443-0330
FAX: (215) 443-0394
(800) 959-0307
<http://www.ATiguys.com>



AUDIO TECHNOLOGIES INCORPORATED

READER SERVICE NO. 70

The best way to squeeze a great sound through a telephone line...

Zercom
CORPORATION 

You don't have to settle for less than the best!

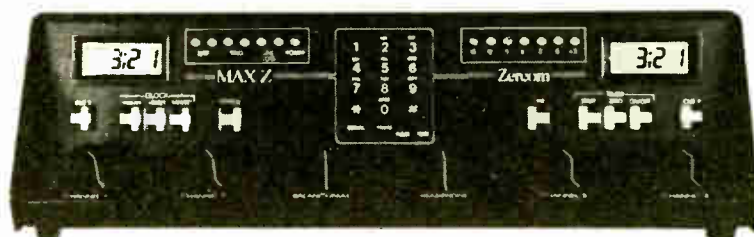

The 'Max-Z' 4 channel remote console

P.O. Box 84, Zercom Drive
Merrifield, Minnesota 56465-0084
760/765-3151 - Fax 760/765-3900

Available through all major dealers

READER SERVICE NO. 119

World Radio History

Attention Advertisers

Reach 18,000+ broadcast equipment buying prospects at AM, FM and AM/FM radio stations, networks and groups, recording studios, engineering and consulting firms every month.

Products & Services Showcase appears in every issue of Radio World.

For detailed information, contact Christopher Rucas or your sales representative.

RADIO WORLD
Tel: 415-824-3499
FAX: 415-824-4738

Backing Up: Smoke and 'Mirrors'

Ron Burley

I recently got off the phone with a fellow who spent more than \$8,000 on a "mirrored-drive" setup. He bought it so he would be protected if he ever had a hard-drive crash.

Instead, a PC virus got him and he lost all his commercial production and all of his recorded music.

"How could that happen?" you ask. "After all, he was mirrored." I will get to that in a moment, but first, take a look at what we really face in the studio as far as drive failure.

Failure rate

The newest hard drives are rated at seven years mean time between failures (MTBF). This means that, on average, you can use a drive for seven years before it will cease to work right.

Seven years is a long time. So how come we always hear about hard-drive failures?

When someone says their hard drive failed, often it actually means they need to reformat it for some reason or reinstall Microsoft Windows. The drive itself did not fail at all and the audio data still is intact.

So if hard drives do not fail that often, what do radio stations really have to be concerned about? Check the Worry List:

1. Person deletes important data, system or audio files.
2. Same Person brings floppy from home with virus that damages or erases all hard drives on system.
3. Same Person pours coffee into computer.
4. Same Person plugs PC directly into wall, bypassing UPS. PC gets fried by lightning strike.

All of these occurrences are many times more likely to happen than a hard-drive failure, and mirrored drives or RAID arrays offer no protection against any of them.

When you change or add a file to your primary drive, the file also is added on the mirror drive. Conversely, when something is deleted on the primary, it also is deleted on the mirror. You can see this provides no security against Worry List Item 1.

What about Item 2? If the virus gets to the main drive, it will quickly get to the mirrored drive as well. No protection there, either.

The coffee in Item 3 will wipe out the entire PC, including the mirror drive. And the lightning strike in Item 4 will kill everything.

So why would anyone spend money on a mirrored system if it does not actually do what they need? Probably because many people confuse mirroring with backing up. Mirrored drives are not backup devices.

Saving face and audio

So the next question becomes, "How should we protect our digital spots, commercials, liners, promos, jingles and music?" The answer is easy and relatively inexpensive: JAZ drives, CD-R or tape backup.

Removable Iomega JAZ disks hold about 1 GB of data. CD-R, or recordable CD, is like a regular CD and holds about half a gigabyte. Tape drives come in all sizes.

What each of these systems has in common is that they will protect you against all Worry List Items. They also provide the most important element of a "secure" backup system: They can be removed from the building.

You can take the disks or tapes and stick them in your garage or safe deposit box. There, they will be safe from anything the

person in the Worry List can come up with.

When you need to restore data, hook up the JAZ or tape drive to the parallel port of the PC, or put the CD in the CD-ROM drive.

Even if you have lost an entire 10 GB music library, you can have it restored in less than an hour.

The best news is that these backup systems cost much less than mirrored-drive systems. A JAZ or tape backup drive will run from \$300 to \$400. JAZ disks or tapes run from \$30 to \$80. JAZ disks for backing up 10 GB of data will cost about \$500.

CD-R drives start around \$400 and can climb to \$1,000, but the discs cost

only about \$5 each in volume. Tapes can be extremely cheap, but prices vary a lot.

JAZ drives and CD-R are fast enough to let you play files from them directly, in a pinch. This is why BSI recommends not using backup software to transfer files to JAZ disks or CD-R; just copy the files directly.

The process will use up only a little more disk space — audio files do not shrink much in backup programs — and they will be useable instantly.



Ron Burley is the founder of Broadcast Software International, which makes WaveStation radio automation and other audio products for Windows. He has written about backing up and other topics on the BSI website.

RW welcomes other points of view.

Quantum FM

Solid State

Solid Reliability

from QEI



- Proven reliability
- Maintenance-free FET technology
- Self-contained modules with own power supply regulator
- Compact size reduces shipping costs, allows affordable air shipment
- Power levels between 300 Watts and 6 kW
- Modular design offers buy-only-what-you-need affordability and convenience

For the same price you pay for a tube transmitter, you can now have a superior solid state FM transmitter with high-power, advanced technology exciter and cableless combiner. The modular design of QEI's QUANTUM-Series FM transmitters offers the advantage of buying only the amount of power you need...and means that you can upgrade to higher power levels whenever you're ready.

QUANTUM from QEI—the people who have been designing and building solid state transmitters longer than anyone else in the industry.

You need to know more! Call Jeff Detweiler today toll free (800) 334-9154.

QEI Corporation
One Airport Drive • P.O. Box 805
Williamstown, NJ 08094

Tel (800) 334-9154
Fax (609) 629-1751

24-Hour Service Hotline
(609) 728-2020

RADIO CHRONICLE

Although it was apparent by the end of the 1920s that radio could deliver to advertisers a mass audience the likes of which never had been imagined, there was not a wholesale rush of sponsors to the nascent and, to some minds, unproven medium.

Many agencies contended that the inherently transient nature of radio — the belief that the commercial message would be too fleeting for consumer comprehension — made it a less effective advertising tool than print.

This 1929 CBS pamphlet claimed that broadcast advertising was "intimate and sensitive, subtle and emotional, and in tune with the times."

Within two years, all sponsor reluctance had vanished, and radio proved enormously profitable even in the depths of the Depression.

The Library of American

TL665
C
COLUMBIA BROADCASTING SYSTEM

Broadcasting welcomes your questions, comments and donations. You can contact the Library at (301) 405-9160 or send an e-mail to bp50@umail.um.edu

Visit the LAB website at www.lib.umd.edu/UMCP/LAB



Radio World, December 24, 1997

How Much for a Good T-Shirt?

John Bisset

I have received some nice comments about our *Workbench* Business Contact card file. Keep sending those great suggestions.

We used to have a company here in Washington that sold scrap clean T-shirt material. You could buy a 3-foot-square box of these rags for about \$10. The material, leftover scraps from some company that made cotton T-shirts, would last for years.

The rags-in-a-box you can buy at Home Depot are nice, but you could not beat the value and quality of these scraps. If you know of a similar company, fax me the particulars for a future column. The one here in D.C. has disappeared, and we have several dirty transmitters screaming for nice clean rags.

Remember to check your deicers. A consultant just told me of a station where the management refused to pay for the repair of the deicers. Shortly thereafter, a rain storm at the mountaintop transmitter site turned into a ice storm. The VSWR protection circuit did not work, and the transmitter smoked the final. I guess that is one way to get a new transmitter.

After we printed the contact card for

MCM Electronics, engineer George Zema wrote that in addition to Switchcraft and Belden products, you can find a good assortment of the oddball semiconductors used in the Otari MTR-10, not to mention VCR and microwave oven parts. George likes the delivery, too. With a warehouse in Reno, Nev., it is not unusual to get next-day service to San



Francisco. In case you missed it, the MCM Electronics toll-free number is (800) 543-4330.

Robin Cross, CE for many years at WNIJ(FM) and WNIU(FM) in DeKalb,

Ill., made mention of the RPU static problem frequently discussed in this column. Robin calls this phenomenon "precipitation static." The antenna used has a gamma match. This is an ungrounded antenna. With an ohmmeter at the receiver end of the coax and with the antenna still connected, check the impedance. It should be almost infinite. If a grounded antenna is installed, the problem should disappear.

Another solution is to install a shorted quarter-wave stub at the receiver. A pass cavity also would do the same thing because it uses a shorted coupling loop to excite the quarter-wave tuning rod.

This column has often been used as a soap box for the dilemmas of broadcast engineers. I thought you might enjoy hearing some comments from the other side of the phone: the equipment vendor.

First is the general manager who calls these vendors to get a reference for another contract engineer. Seems he fired his engineer to save money, and now is angry that his new contract guy will not drop what he is doing to help this fellow out of a bind. Makes no difference that the other guy is off the air. "We pay him more than they do!" the GM says, or "We're in a bigger market!"

Then you have what I call the "New Age engineer," better known as the gen-

eral manager engineer-wannabe. One rep could not remember how many calls he has received from GMs wanting to buy an FM OPTIMOD to install on their home stereo so it would sound better. These managers get angry when the rep will not sell it to them!

How about the people who can't understand why tubes will not last more than a year? Who knows where they get the idea that tubes should run for at least five years?

One sales rep confided that you cannot blame these guys for wanting to save money. But it is scary to think of the situations they get into just to save a buck.

Speaking of saving buck, another rep vented his spleen on UPS. His company is continually receiving boxes with fork-lift holes in them, or bent panels, smashed meters — you get the idea. He asked, "Who do you trust to deliver your items in one piece?" Several manufacturers are using FedEx exclusively, primarily because there is less handling with FedEx than the four or five days that UPS ground service takes. Any suggestions? Send them to wrwbench@aol.com

In our Aug. 6 column, I wrote about a Studer A807 reel-to-reel that failed, causing the transport motors to run backwards and a total loss of transport controls. Michael LeClair, the chief at WBUR-AM-FM in Boston, responded. He has experienced this same problem, and found the usual cause to be one of the front-panel transport control pushbuttons stuck in a pushed down position for a long period of time. The microcontroller that reads these commands will lock up under these conditions. Once the microcontroller locks, all pushbutton functions are disabled, and the machine will free-run in whatever state it chooses. The simple 30-second solution is to look for the stuck switch, and pry it up with the edge of a greenie. Be careful, though, the switches are plastic.

In my Studer story, the switch contacts were shorted due to internal gunk or dirt. This caused the processor lockup. A possible cause is the use of editing tape dispensers that are loaded with fine sand as ballast. The weight of the sand keeps the dispenser in place as you pull the editing tape. Studio engineers placed these dispensers on top of the A807s while editing. A couple of the dispensers began to leak sand, and over the course of two to three weeks all 30 to 40 pushbuttons on the A807 would jam whenever they were pressed.

The dispensers went in the circular file, and only after several thorough cleanings was the problem cleared.

■■■

John Bisset is a principal with Multiphase, a technical services company. Reach him at (703) 323-7180. Printed submissions qualify for SBE recertification credit. Fax submissions to (703) 764-0751, or send them via e-mail to wrwbench@aol.com

Program Audio Data ISDN Voice

OutBack™
One-Touch Remotes

IntraLink™
Studio Flexibility

www.intraplex.com
Intraplex, Incorporated
3 Liberty Way, Westford, MA 01886
Tel: 978 692-9000 Fax: 978 692-2200

Intraplex, the leader in broadcast digital transmission.

Intraplex ISDN.
Broadcasters rely on Intraplex for high-quality, flexible T1 transmission solutions. Now, Intraplex quality and flexibility are available over ISDN.

IntraLink™, the industry's first fully modular ISDN multiplexer, allows broadcasters to combine high-quality program audio, voice and data on a single ISDN circuit. Connect and configure up to six individual BRI's in a single rack unit shelf, and manage multiple channels and codecs from a single PC. Flexible and space-efficient, IntraLink™ redefines ISDN for broadcast.

OutBack™ ISDN audio codec is the ideal companion for remote broadcasts. Compact and affordable, the OutBack™ provides "plug and play" ISDN connections, one-touch call set-up and auto-detection features that simplify use, with ISO/MPEG Audio Layer II coding up to 20 kHz.

Maximize your investment. Call us today.

That big, loud
OPTIMOD sound
now in a thinned
down box.



O P T I M O D - F M 2 2 0 0 D I G I T A L P R O C E S S O R

DIGITAL SOUND THAT ANY FM STATION CAN AFFORD.

When it comes to attracting and keeping an audience, nothing surpasses OPTIMOD for big, loud sound. Which is why so many FM stations have bought our digital processors, and even more have coveted them from afar. Until now. Introducing the 2200. It could be just what you need in a digital FM processor, less the hefty price. In one slim package you get features found only in high-end processors. Like fully digital stereo encoding, eight factory audio presets and the ability to program eight unique settings of your own. Plus there are two OPTIMOD-quality processing structures: protection for a remarkably transparent sound, and two-band with high frequency enhancement for a competitive sound. No matter which structure you choose, the 2200 gives you big, loud sound at a remarkably thin price.

2200: \$3,850 US USER PRICE; 2200-D WITH DIGITAL I/O: \$4,450

orban[®]

H A Harman International Company

© 1996 Orban, Inc. Orban and OPTIMOD are registered trademarks. 1525 Alvarado St., San Leandro, CA 94577 USA
Phone 1-510-351-3500 Fax 1-510-351-0500 E-mail custserv@orban.com

ROOTS OF RADIO

Remember the British Invasion?

Richard W. O'Donnell

The British launched a major invasion of a different kind in the early 1950s.

Such shows as "Horatio Hornblower," "The Queen's Men," "The Goon Show" and other London-based programs came aboard as summer replacements in 1952. Most did not last too long, but a few managed to survive for a while.

Down the tubes

Why did this invasion take place? About that time, television had started to flex its muscles. Expensive American radio shows were losing their audiences

to the tube. Transcriptions of the British shows, made primarily for home consumption, were available for a lot less hard cash, and NBC, Mutual and others put them on in key time slots.

"Theatre Royal," produced by the Tower of London Syndicate, was the most distinguished of the imports. Hosted by Laurence Olivier, the program featured classic yarns written by Charles Dickens, Stevenson and other greats. Guest stars included Sir Alec Guinness, Robert Morley, Robert Donat, Margaret Lockwood and other British stars of the first rank.

Host Olivier also acted in several of the dramas. A Dickens buff, he played

Micawber in a short version of "David Copperfield" and had a field day performing "The Pickwick Papers." The show was aired in 1953. It might have lasted longer, but Olivier was in poor health at the time and had to bow out.

Then there was "The Scarlet Pimpernel," heard on NBC on Sunday nights. This show had Marius Goring as Sir Percy, the London dandy who really was the elusive Pimpernel. He rescued Frenchmen from the guillotine during "the Revolution," with the help of a few close friends — the only ones who knew his true identity. This thriller lasted a couple of seasons.

"Horatio Hornblower," starring Michael



John Gielgud

Redgrave, was a one-hour show about the fictional British naval hero. NBC aired this one, too. "Horatio" was a smooth production with an excellent cast of supporting actors, but at times it could get confusing. One week our hero would be a veteran warrior, and the following week he would show up, in flashback, as a young sailor. Still, the show was exciting.

American Orson Welles hosted "The Black Museum" on Mutual. The great actor was hired by Towers of London while he was living in England; he was a big name who could attract an American audience. Towers produced several of these syndicated shows.

The museum was the place where Scotland Yard displayed relics of its famous murder cases. Each week Welles would pick out a different relic — a hatchet, a scarf used in a strangling, even a bathtub used in a drowning murder — and relate the details behind the crime. The show survived for only a year. By then, Welles was playing Harry Lime in "The Third Man," another syndicated radio show.

"The Black Museum," we should note, actually was an updated rerun of another English radio show, "The Secrets of Scotland Yard," also syndicated in the United States. Clive Brook, an English actor who was a popular film star in America during the early '30s, was host of this show, produced in the late '40s strictly for British consumption.

However, the show did make it over here. In addition to narrating, Brook would play several parts in a show, changing his voice to match the character.

Heroic Mounties

"The Queen's Men," another Mutual show, was about the Royal Canadian Mounted Police. Actors from Canada as well as England performed. Fictional cases involving the Mounties were told.

Towers of London also came up with its own "Sherlock Holmes" series, marketed in the United States in 1955 on NBC. John Gielgud played a gentle Holmes, and Ralph Richardson was a splendid Watson. Original stories by Sir Arthur Conan Doyle were used. Harlow Wilcox was the American announcer.

Since syndication to the United States was all the rage in the early 1950s, these programs also were shipped over here. They never really caught on, probably because, by 1955, network radio in the United States had lost its old identity, and taken on a new face.

Television was in charge — for a while. The British invasion was over.

■ ■ ■

Dick O'Donnell is a freelance writer and old-time radio buff living in Florida. Reach him at (813) 842-6638.

25 Years Strong!

Inovonics

continues to meet the everyday needs of broadcasters the world over with sensible, top-quality audio-broadcasting products at down-to-earth prices.

Audio Processing and Air-Chain

A broad range of great-sounding processors for every AM, FM, TV and Short-wave need. From our time-honored, programmable 5-band to a very basic multi-purpose unit, feedforward-PWM technology yields a strong, clean sound that won't wear-out your listeners.

The legendary "DAVID-II" FM Processor/Generator persists in surprising users with its major-market performance at a budget price. Both the "DAVID-II" and our basic FM Stereo-Gen-only utilize digital synthesis for unassailable specs.

Instrumentation, Radiodata, Etc.

Inovonics' full-featured, off air FM Mod-Monitor gives accurate total-mod, pilot and program audio readings; a companion unit measures SCA and high-speed data subcarriers.

And our FM "Relay Receiver" is sensitive, selective and, most of all, professional. It's ideal for FM translator and other demanding off-air pickup applications.

A selection of RDS/RBDS products includes an easy-to-use PROM-based Encoder, and a "dirt cheap" Mini-Encoder that fits any station's budget. A professional Decoder-Reader works with any mod-monitor to qualify and display all data groups.

Inovonics, Inc

1305 Fair Avenue • Santa Cruz, CA 95060
Tel: (408) 458-0552 • Fax: (408) 458-0554

www.inovon.com



MARKETPLACE

Recently Introduced Products for the Radio Broadcast Professional.

Got a product for Marketplace? Mail info and photos to:
Marketplace, Radio World, Managing Editor, P.O. Box 1214, Falls Church, VA 22041.

Auralex LENRD Bass Trap

Auralex Acoustics introduced LENRD, or Low End Node Reduction Device, a corner-mounted studio bass trap engineered from acoustic foam. Pronounced "Leonard," it features a triangular shape with a height of 2 feet; each flat side is 12 inches long.

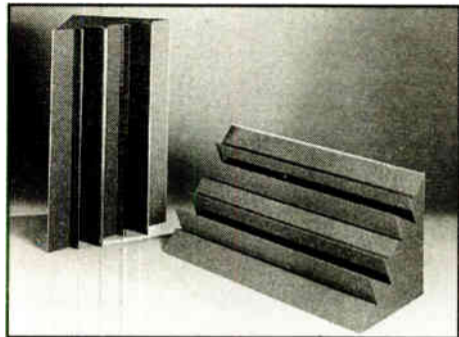

According to Auralex, eight LENRDs trap 16 lineal feet and yield an NRC rating of 1.35.

For more information, contact Auralex Acoustics in Indiana at (800) 95-WEDGE or circle Reader Service 25.

RF Connectors Toggle Switch Attenuator

RF Connectors, a division of RF Industries, recently released the RFA-4056-03 BNC toggle switched attenuator. The attenuation range is 0 to 31 dB in 1 dB steps, and the frequency range is DC to 1,000 MHz.

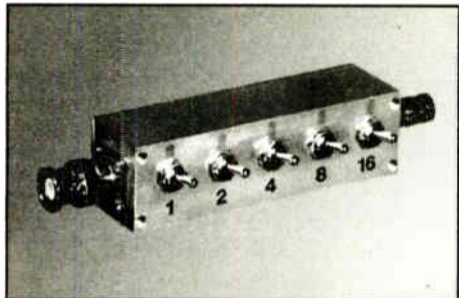

The attenuation steps are 1, 2, 4, 8 and 16 dB with attenuation accuracy of ± 0.2

dB per step at DC to 500 MHz, and ± 0.3 dB per step at 501 to 1,000 MHz. Insertion loss is 1 dB maximum, and the maximum SWR is 1.4:1.

For more information, contact RF Connectors in California at (800) 233-1728 or (619) 549-6340; fax: (619) 549-6345, via e-mail: 102061.2261@compuserve.com or circle Reader Service 49.

GEPSCO 5526EZ Audio Cable

GEPSCO International has developed the 5526EZ single-pair, 26-gauge audio cable. The company said it developed the small, lightweight cable for applications where weight and space are factors.

The 5526EZ cable is an addition to the line of AES/EBU 110-ohm digital audio cables and has two, 26-gauge copper, color-coded conductors and a 26-gauge drain wire. Housed in an overall foil shield, the cable is wrapped in a polyvinylchloride black outer jacket that carries an NEC type CM rating.

The characteristic impedance is 110 ohms and the mutual capacitance is 13-1/2 pF per foot.

For more information, contact GEPSCO International in Illinois at (312) 733-9555; fax: (312) 733-6416 or circle Reader Service 73.

New Rack Cases From SKB

SKB Corp. has created a new generation of rack cases. According to SKB, the new cases were designed based on information and recommendations from touring professionals and performers.

The features include an extra 1-1/4

inch of rackable space, redesigned handles for a better grip and stronger handhold and a rack rail on both front and back. The cases also have new latches that "utilize cam action closing, are lockable and are field-replaceable." The SKB engineers also redesigned the bumper system, which now has 3/8-inch bumpers to protect the valences; there are also bumpers installed on the lids.

For more information, contact SKB Cases in Florida at (305) 378-1818; fax: (305) 378-6669, visit the website: www.skbcases.com or circle Reader Service 97.

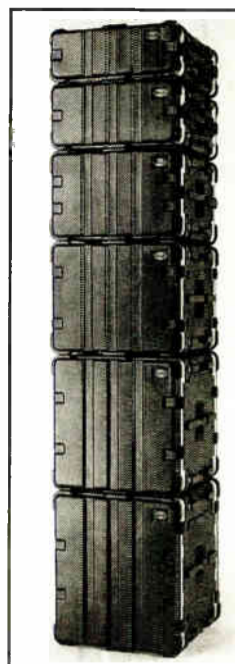

DataTel Swing Gate Racks

DataTel has introduced a series of swing gate racks, designed to simplify wiring and maintenance tasks.

The new series features an open wall-mount design that allows equipment to swing into the open. The racks are equipped with tie points and nylon loop fasteners that control and route challenging bundles of cable. According to DataTel, each rack can hold as much as 150 pounds of components.

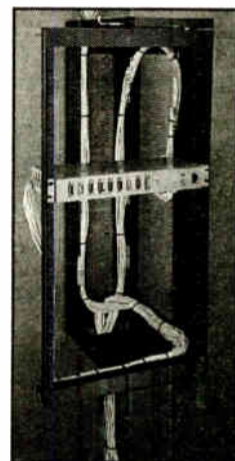

DataTel offers racks with depths of 12 and 18 inches, with heights of 2 or 3 feet.

For more information, contact DataTel in New Jersey at (201) 839-1011 or circle Reader Service 121.

DTRS 30-Minute Tape

JR Pro Sales, the North American distributor of BASF recording media, recently announced the addition of a 30-minute tape to its line of DTRS Master tapes.

BASF DTRS Master tape is designed for professional digital audio applications. According to the company, DTRS Master tape features a new metal particle formulation, and an improved, ultra-smooth back-coated tape surface that helps extend head life and minimizes dropouts from tape shedding.

The DTRS Master is also available in 60- and 113-minute lengths.

For more information, contact JR Pro Sales at (888) 295-5551; visit the website at www.jrpro.com or circle Reader Service 145.

TH 2440 Klystron for Digital Radio

The lack of a DAB standard in the United States has not stopped suppliers abroad from rolling out products for other markets.

Thomson Tubes Electroniques developed the TH 2440 klystron for digital radio applications. According to Thomson, the product delivers an average power of at least 1 kW and operates in the 1,440 to 1,510 GHz band.

The TH 2440 is based on klystron technology employed in telecommunication and radar applications.

For more information, contact Thomson Tubes Electroniques in France at 011-33-01-30-70-35-00; fax: 011-33-01-30-70-35-35 or circle Reader Service 169.

SYSTEMS INTEGRATION

- On Air / Production Studio systems
- Broadcast On-Air and Production Consoles
- Digital Station Automation systems
- Multi Track Digital Editing Suites
- Custom / Modular Studio Furniture Systems
- Transmitter / RF systems
- Digital / ISDN Telephone systems
- Audio / Video Multimedia systems
- Complete Line of Source Equipment

REAL WORLD SOLUTIONS FOR YOUR DUOPOLY, LMA, GROUP OR SINGLE STATION OPERATION



Please contact us today and put ABG to work for you!

ABG
Audio Broadcast Group Inc.

MAIN/MIDWEST OFFICE

Voice: 800-999-9281
Fax: 616-452-1652
E-mail: support@abg.com

SOUTHEAST OFFICES

Voice: 800-369-7623
Voice: 800-951-7443
Fax: 919-934-8120
Fax: 803-951-3123
E-mail: cindy_edwards@abg.com
E-mail: jgeorge@abg.com

SOUTHWEST OFFICE

Voice: 800-858-9008
Fax: 805-273-3321
E-mail: tmezey@abg.com

FOR INFORMATION ANYTIME:
VISIT OUR WEBSITE
www.abg.com

Products & Services Showcase

For more information on the products shown below, circle the appropriate Reader Service No.(s) on the enclosed Subscription/Reader Service card or contact the advertiser directly.

Would you believe that you can visit a dozen markets in an hour without leaving your desk?



If you have the TeleRadio from CircuitWerkes at your stations, you can listen to every radio station in each of your markets.

Old-fashioned air-checks are okay, but they have some real drawbacks. Among them are:

1. You have no control over what is recorded on an air-check. You may be hearing only what someone else wants you to hear.
2. Your own air staffs usually know when they're being recorded and react accordingly.
3. By the time you get an air-check in the mail, it may be too late to respond to the competition.

The TeleRadio beats those problems by letting you listen to both your station *and* the competition in **real-time**. If you have a TeleRadio, you simply dial it up from any phone. As soon as it answers, the internal radio begins playing down the phone line to you. You can control the radio by using the buttons on your phone. It's just like being there!

The TeleRadio even has a DTMF selectable external audio connection so it can be used as a standard telephone coupler too. An optional call progress decoder is available for using the TeleRadio on PBX analog lines and in areas that don't support CPC.

CircuitWerkes - 3716 SW 3rd Place, Gainesville, FL 32607
(352) 335-6555 / fax 331-6999 - www.circuitwerkes.com

READER SERVICE NO. 94

The Emergency Alert Sentinel™

Finally, the EAS link to YOUR listeners!
Designed in Iowa to help Alert the Nation - 24 Hours a Day
The Emergency Alert Sentinel is the FIRST EAS receiver designed to reach your listeners at their home or office.

• **Features:**

- > AM/FM receiver with station tune indication
- > Turned on/off by EAS data tones
- > Silent until activated
- > Weekly/Monthly test indicator
- > Flashing red alert light
- > Concealed tuning and volume for safety
- > AC Powered & battery backup
- > Options include external contacts, monthly EAS test monitor for unmanned stations



• **For Promoters:**

- > No Capitol outlay
- > No Stocking, S&H
- > Your Station logo on every unit

For information about the Emergency Alert Sentinel promotional agreement contact

ASi Industries at
PH: 800-382-9686
FX 319-390-5590
asisystem@netins.net

READER SERVICE NO. 143

Designed for Broadcasting! MINI-MIX 8A

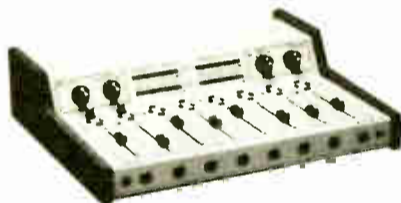

\$2499
List

12 Stereo Inputs 2 Stereo Outputs
2 Dedicated Mikes 1 Mono Output

Service & Affordable Quality for Over 28 Years

AUTOGRAM
CORPORATION

1500 Capital Avenue (972) 424-8585
Plano Texas 75074-8118 1-800-327-6901
FAX (972) 423-6334
info@autogramcorp.com

READER SERVICE NO. 21

THE COST EFFECTIVE ALTERNATIVE TO MANUFACTURER SERVICE

**SERVICE, REPAIR &
CALIBRATION**

- STL's • RPU's • TSL's
- Exciters • Optimods
- AM/FM Monitors
- Remote Control Systems

**SPECIALIZING IN
EQUIPMENT BY**

- Belar • Marti
- Moseley
- McMartin
- TFT
- And others...

WE ALSO PROVIDE

Free, over-the-phone technical assistance
STL loaner/rentals
PCL 505 Certification



2198 Hubbard Lane, Grants Pass, OR 97527

(541) 471-2262

READER SERVICE NO. 45



Our **Wired STL** lets you locate your audio processor and stereo generator in the studio. It transmits composite audio baseband through 2500 feet of inexpensive twinax line, so you can reach your STL on the roof or your transmitter down the hall.

Get our full story—contact your authorized Modulation Sciences Distributor, or the Composite Audio Authority...

modulation sciences, inc.
12A World's Fair Drive • Somerset, NJ 08873 USA
Voice (908) 302-3090 • Fax (908) 302-0206
Toll Free in USA (800) 826-2603

READER SERVICE NO. 69

Call **MYAT** For Rigid Line & Components

Facing a "right now" emergency? Planning a new installation? Upgrading your facility? Whatever the need, **MYAT** is the solution. **MYAT** products are quality-built for maximum performance and long life. And we take delivery commitments seriously.

Call your favorite RF distributor or **MYAT** direct at 201-767-5380, or fax 201-767-4147 for our complete catalog and reference guide.



380 Chestnut St

P.O. Box 425

Norwood, NJ

0 7 6 4 8

READER SERVICE NO. 118

Attention Advertisers:



Combine Direct Mail With Advertising in a Total Marketing Package!

RADIO WORLD reaches **18,000+** equipment buying prospects. The list can be customized for your specific needs. Select by geographic region, firm type, occupational breakdown or other sub-divisions.

Call **Sheryl Unangst** at
800-336-3045 x164
for more information!

Running Radio

VRP
Virtual Radio Programming

Station Services
Page 44

Radio World

Resource for Business, Programming & Sales

December 24, 1997

OFFBEAT RADIO

Karate Hits National Airwaves

Dee McVicker

Programming doesn't come much more action-packed than "Warrior Talk," a martial arts radio talk show that hit the national airwaves over the summer as one of the new hard-hitting niche programs.

Hosted by black-belt master Dr. Jerry Aiello from a "dojo" in Royal Oak, Mich., the two-hour show made its syndication debut on June 7 after two years on flagship station WPON(AM) near Detroit. It is now heard in 10 cities, including Houston, Denver and Chattanooga, Tenn.

"I've been a guest on so many shows around the country, especially locally in Detroit," said Aiello, a ninth-degree black belt and a master-level instructor in Isshin Ryu and Shito Kan who owns three karate schools in Detroit. Aiello is a prominent chiropractic doctor and the international director for the Shito Kan Karate Do Association and the Midwest director for the Okinawan Kobudo (ancient weapons) Association.

"Every station I've been on as a guest, the switchboard's overloaded," he said. At one station, listeners from 13 surrounding states called in. "I thought that was unbelievable. Everyone at the radio station was shocked. They thought, 'Karate is cute for kids, but why are all these adults calling?'"

The answer, according to Lowell Homburger of Abernat, Roxben & Boggs

in Charlotte, N.C., the show's syndicator, is that karate is marketable. Homburger pointed to the dojos, or karate schools, cropping up on what seems like every other city block. "We did a little research and found out that the growth in martial arts places is significantly more than health clubs," he said.

Karate paraphernalia is no small industry, either. Martial arts headgear, footgear, and gi's are just the basics. Until recently, trade magazines had the only hold on these advertising dollars.

"The only outlet for martial arts merchandising and advertising has been the journals," said Aiello. "So what has happened is we've become a nice little conduit for the people supplying the martial arts products, whether it's education or instruction or magazines or books or tapes."

Sporting for dollars

As a bartered show, "Warrior Talk" draws national advertising patrons that typically manufacture products, whereas local advertising patrons typically are local karate studios and event sponsors. According to Aiello, karate training schools were the second largest start-up business in the country last year. With more than 2 million practitioners, martial arts is the eighth-largest sport in the United States, he said.

To reach this market, Aiello and his on-air co-host, "Sensei" (teacher) Dina Baganz, a third-degree black belt, bring in

authors and masters of the discipline for in-depth discussions, while taking call-ins from listeners. Listeners have talked to notable experts such as Master Harold Long, patriarch of Isshin Ryu Karate Do in the United States; Dr. Peter Urban, grand

arts, such as Judo, Jujitsu, Tai Chi, Aikido, UFC, Iaido and Tae Kwon Do.

In radio terms, both Aiello and Homburger see the show as a way to reach an otherwise unreachable listening audience.

"We actually bring an audience to the station that they can't get otherwise," said Aiello, citing the karate dojos, clubs, suppliers and karate students themselves, who he believes make up roughly 10 per-



Dina Baganz (left) and Dr. Jerry Aiello

master of American Goju Karate, who is recognized as the first American to have devoted a lifetime to the discipline; and Dr. Yang Jwing-Ming, a master in the Chinese martial arts who spoke during one broadcast about how and why the monks developed the martial arts.

BRC Productions in the Detroit area produces and engineers the two-hour weekly show, which is fed by Aiello's Warrior Broadcasting Network live Saturdays at 4:06 p.m. to 6 p.m. on SAT-COM C-5, Transponder 19.

Spiritually fit

Insightful and often humorous, the show adds a spiritual and fitness bent that appeals to karate buffs as well as the general audience.

"We're not one of those slam-bam, cult-like programs," said Aiello, a 30-year veteran of martial arts who himself has authored a few books on the subject. The show is inclusive of all the martial

cent of any given community, as a niche listener base.

"Radio always talks about there's 7 percent of the pie, and not being able to get any more. Well, sometimes you have to look at the unconventional to get dollars in," said Homburger, who is cultivating his own niche market by supplying niche programming to radio stations. Among the niche programs on his company's roster are a Dr. Laura Schlessinger-like children's talk show. "We did a lot of research and found that kids are the only ones without a talk show," said Homburger. Another offering is a Broadway musical format called "WILD About Broadway!" that just cleared 20 stations.

Dee McVicker, a regular contributor to RW, has been tuned in to karate for some time as the parent of a Little Dragon and the wife of blue-belt Chuck Adams, engineering manager for Circuit Research Labs.

EAS Radios, Tools Are Now Available

Gary Timm

As broadcasters mark nearly a year of EAS operation, EAS-related products for both consumers and broadcasters are on the market.

EAS-Code weather radio

Radio Shack is the first company to come out with a weather radio that reacts to the NOAA version of EAS codes, Specific Area Message Encoding (SAME). The National Weather Service encodes most of the alerts it sends via NOAA Weather Radio with the type of alert and the county the alert is for. This new radio can be programmed to respond to codes for only the counties you choose, up to 15, ignoring alerts for all other counties.

The unit cannot be programmed for specific types of alerts. It will react to all alerts for the programmed counties.

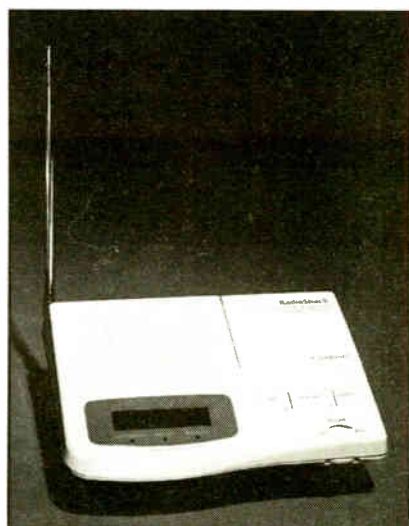

The NOAA Weather Radio, From Radio Shack

An LCD readout shows the event, such as "Tornado." An LED will indicate See EAS, page 40 ▶

RADIO REVENUE: YEAR TO DATE

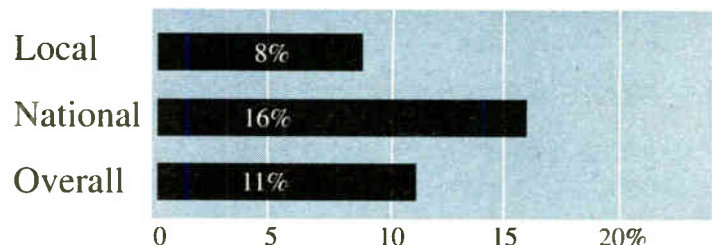

Strong Start for Fourth Quarter

National radio revenue continues to set the pace in a year of big revenue gains for the medium.

"While exceptional returns at the national level continue to fuel radio's double-digit growth, consistently strong local sales figures indicate that this period of sustained growth is filtering down into medium and small markets as well," said Gary Fries, president and chief executive officer of the RAB.

The year-to-date numbers closely match the numbers for the month of October alone. National revenue was up 15 percent, local revenue was up 9 percent and combined revenues increased 10 percent.

Products & Services Showcase

For more information on the products shown below, circle the appropriate Reader Service No.(s) on the enclosed Subscription/Reader Service card or contact the advertiser directly.

The CircuitWerkes AC-12 Telephone Autocoupler Bay

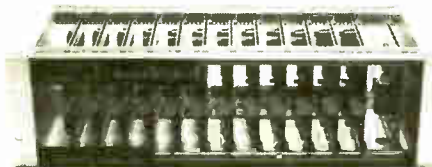

Get up to 12 couplers in a neat, compact chassis

- Auto answer & disconnect.
- 2 audio busses for mass feeds.
- Individually card selectable buss or auxilliary audio I/O.
- LED indicators for ring, clipping, power & online.
- Ring counter answers on user set ring number.
- Momentary or latching dry contact outputs at pickup.
- Remove & install cards without affecting the rest.
- The aux. audio jack is ideal for multiple IFB feeds, etc.
- Check out our www site for more info and tech manuals.

The AC-12 rack-mounted coupler bay is the best way to eliminate a wall or cabinet full of yesterday's couplers. Our unique dual audio busses eliminate the tedious and messy wiring associated with networks and other mass feeds. Each card can also individually either send or receive telco audio. Best of all, a fully loaded AC-12 lists for under \$175 per coupler.

CircuitWerkes

3716 SW 3rd Place
Gainesville, Florida 32607
(352) 335-6555 / fax 331-6999
<http://www.circuitwerkes.com>

READER SERVICE NO. 93

1,000,000 LNBS and growing!

Norsat celebrates the shipment of 1,000,000 Low Noise Block Amplifiers to the satellite industry

Since its first shipment of an all GaAs FET LNA in 1983, Norsat has consistently introduced LNBS recognized for quality and performance. Our dedication to industry-leading reliability, combined with innovative new technology, has enabled Norsat to ship 1,000,000 Low Noise Block Amplifiers and earn recognition as the world's #1 commercial LNB supplier. Today, we supply C, Ku and Ka-band LNBS and block converters to customers in more than 50 countries worldwide.

For next day delivery or consultation on customer products, contact Norsat today.



Contact Norsat at:
#302-12886 78th Avenue, Surrey, British Columbia, Canada V3W 8E7
Canada • Tel 1-604-597-6203 • Fax 1-604-597-6214
<http://www.norsat.com/> • info@norsat.com



READER SERVICE NO. 117

AUTOMATED FM ANTENNA PATTERN MEASUREMENTS

Signal problems? Using the Dept. of Defense Global Positioning System (GPS), and our hi-tech airplane, let us show you the signal your station is really transmitting. We measure each and every degree of your station's pattern.

Your signal is your most important asset. Don't guess. Be sure you're getting the maximum possible coverage. Call us today for a free brochure or confidential consultation.

STEPHENS COMMUNICATIONS INC.
Little Rock, AR. • (501) 821-5756



READER SERVICE NO. 20

Fits In Even "STINGY" Budgets!



DOZENS SOLD!

The hot new "DELUX"™ quality built SPACEWISE system!

BASIC SYSTEM \$1245!
FULL SYSTEM \$2540!

GENERAL FEATURES: Basic system consists of main counter top and two PC system pedestals ... then you add on what you need from there, such as racks and shelf wings or talk table wings for a full system.

USER FEATURES: Two PC system base pedestals ... heavy rack rail systems with easy access standard ... passive ventilation systems throughout ... adjustable shelves ... wiring block backplane ... customizing ... quick installation.

DURABILITY BUILT IN: Top counters are two ply 1 1/2" thick with quality name brand laminate with protective 1 1/2" solid wood trim raised on the outside perimeters. Plus ... generous vertical and horizontal solid wood trim and recessed kickboards.

SPACEWISE® Broadcast/Furniture

CALL 800-775-3660

Visit our web catalog: www.spacewise.com

"The Broadcasters Furniture Store"

READER SERVICE NO. 44

Your Bottom Line Is Only as Good as Your Coverage. Shively Can Predict Your Coverage Better than Anyone Else.

- 30 Years Experience
- Full-Service Provider
- Multi-Station Solutions
- FM & UHF Antennas
- Filters & Combiners
- New B-Line Coax

Shively Labs, because ... it pays to be heard!

P.O. Box 389, Bridgton, ME 04009 USA
Tel.: (207) 647-3327 FAX: (207) 647-8273
e-mail: sales@shively.com
- An Employee-Owned Company -

READER SERVICE NO. 68

1000 HITS on HARD DRIVE for \$495!

Don't waste time dubbing music! Halland will dub 1,000 songs of your choice for only \$495!

Pick from our inventory of Oldies, '70s-Gold, Classic Rock, AC or Country. One-day service no extra charge!



1289 East Alost Avenue
Glendora, CA 91740 USA
PH 626-963-6300
FX 626-963-2070

Music on CD also in stock!
Song lists on the Internet
<http://www.h-b-s.com>

1-800-HALLAND
1-800-425-5263

READER SERVICE NO. 116

32K, MPEG-II, .WAV files compatible with:

Arrakis, BSI, Enco, Pristine, Prophet Systems, Register Data, Smarts and others.



World Radio History

Attention Advertisers!

Reach over 18,000 subscribers! Radio World's **Product Showcase** provides a perfect medium for test marketing your products and services. It's an efficient, effective and affordable advertising option!

For more information on rates and deadlines, fax Christopher Rucas at
415-824-4738

or call
415-824-3499

.....

RADIO ADVERTISER

Presidential Pitch for Fast Food

John Montone

Dana Siller calls it "black sheep marketing" — radio advertising that is "topical, with an edge. Otherwise, the big guys, McDonald's and Burger King, would kill us."

Siller is the director of corporate marketing for Jerry's Subs and Pizza, a fast-food chain headquartered in Gaithersburg, Md. Jerry's has more than 100 franchises in Washington, D.C., Maryland and Virginia and is expanding into several new markets. That means radio listeners in other places will soon hear someone who sounds a lot like the guy residing at 1600 Pennsylvania Avenue demanding, "Show me the cheese!"

Political parody

Siller is the man behind the controversial and wildly popular President Clinton commercials. Last spring the White House actually asked Jerry's to "cease and desist" the campaign, which is paying off in a big way.

When Siller joined Jerry's 11 years ago, he pulled the company ad dollars out of TV. Ever since, Siller said, "All of the company's money has gone into radio. Next to McDonald's, we're the biggest radio advertiser in the market."

"Radio is a terrific medium for us because we're selling a lunch item, so we're able to get people while they're out in their cars. ... The stores tell me they can tell when the spots have run because people are pulling into their parking lots."

In explaining his decision to stay away from television, Siller said, "Jerry's doesn't deliver. If I were running TV and reaching people in their houses, they would still have to call the stores and come pick up their food. This way, when we're running radio ads in p.m. drive, they're already in their cars. All they have to do is pick up their car phones and drive directly to our stores. And we believe in the power of radio because we can paint some pretty vivid images that we wouldn't be able to do on TV."

Buying service

Although Siller does the creative work, Jerry's does employ a buying service: Capital Media, in Maryland. Siller described the advertising strategy: "Go 12 stations deep in the market. Fifty-five, 3+ the first week," meaning the goal is to get 55 percent of Jerry's target audience of 18-to-49-year-olds to hear the spots at least three times during the first week of the flight.

Jerry's runs its spots on a wide variety of formats including classic rock, adult contemporary, R&B and all news. Siller believes people in the White House listen to WTOP(AM) in Washington and calls that station "our executive buy." But Siller stays away from classical and talk stations because they skew older than the 18-to-49-year-olds who consume most of the nation's pizzas and sub sandwiches.

The original Jerry's radio spots evolved from the company's old TV commercials, which featured an interviewer and a character named Jerry whose face was never seen.

"Radio let us continue the mystery of 'Who is Jerry?'" Siller said.



"Show me the cheese! The Jerry's cheesesteak, which inspired a successful radio ad campaign. A variety of subs and pizza round out the Jerry's menu."

And for the next 10 years, Jerry and the interviewer talked about pizza and subs in more than 100 different commercials. "It was unheard of. Nobody keeps a campaign alive that long."

Except for Jerry's.

Larger cast

Three years ago, Siller decided to freshen up the spots. New characters were added including Jerry's mother and the president. The first Clinton spot had the president jogging and salivating over a Jerry's cheesesteak with bacon. In a memorable line, Clinton refers to a well-known Washington figure he calls his buddy Newt, saying, "Newt loves bacon."

That spot aired in 1994, when House Speaker Gingrich was trying to rid the

See SUB, page 42 ▶

All-Digital Studio-Transmitter Link For T1/E1 Lines

The Starlink 9003T1 offers all the features and performance you require to take advantage of decreasing T1 rates for STL/TSL programming feeds:

- Provides uncompressed 16-bit linear audio
- AES/EBU and analog I/Os on a single module
- 32, 44.1 or 48 kHz sample rates
- Intelligent multiplex with drop and insert
- Optional voice, data, ISO Layer II and apt-X cards
- Flexible full duplex network configurations

Moseley

Moseley Associates, Inc.
111 Castilian Drive
Santa Barbara, CA 93117

The Trusted Name In Communications

Phone 805-968-9621 Fax 805-685-9638 Website <http://www.moseleysb.com>

Four EAS Products Introduced

► EAS, continued from page 37

whether it is a "Warning," "Watch" or "Statement." These indications stay on for the duration of the alert. Up to three overlapping alerts can be stored. The radio has an external antenna connector and external alarm terminals which output 7.5 VDC during an alert. It sells for \$79.99, and is catalog #12-249.

In-home EAS receiver

Perhaps the most exciting new product is an AM/FM radio that reacts to EAS alerts. The "Emergency Alert Sentinel" from ASi Industries is a receiver that measures 3-1/2 inches by 3-1/2 inches by 6 inches. It reacts to EAS codes received

from the AM or FM station to which its radio is tuned. For real alerts, it puts the audio on its internal speaker and lights an "ALERT!" light. The EAS EOM turns off the speaker, but the light stays on until reset. This unit reacts to *all* EAS alerts received from the tuned radio station. It cannot be programmed for specific counties or events. For a required weekly or monthly test, the "TEST" light comes on, but no audio is put on the speaker.

Designed for in-home use, the radio tuning and volume controls are accessed through the battery compartment to keep children from tampering with these settings. A "SIGNAL" light on the front of the unit constantly veri-

fies reception. Normal power is from the provided adapter; batteries provide a three-day back-up in stand-by mode. It sells for \$60.95, including shipping.



The Emergency Alert Sentinel
From ASi Industries

ASi plans to sell these units through promotional agreements with radio stations. They do not intend to utilize retail sales outlets. Stations will receive a commission on each unit sold to one of their listeners. ASi will affix your station logo to each unit, if desired. Your listeners can call an ASi 800 number to order, or you can buy the units at a bulk discount for distribution locally.



The In-Home Alerting Device (IHAD) From TFT Inc.

ASi also is working on a version of this receiver meant specifically for the broadcast stations themselves. The special version will have an "Alert Received" relay closure. It also will lock the speaker on when a Required Monthly Test is received. Stations visiting the ASi booth at the NAB convention requested these changes so that this receiver could be used at remote control locations to monitor for the RMT. There will be a slight additional cost to purchase this specially-customized broadcaster version of the radio.

ASi Industries, an Iowa-based company, has been in business since 1979 making FSK equipment for other industries. For more information, call (800) 360-5440 or circle Reader Service 217.

Turn wire text into alerts

The Digital Weatherman III is a computer storage device loaded with pre-recorded audio that can take a weather

bulletin from the news wire service and assemble the recorded words to make it an audio message that is broadcast on the air.

This year, Weatherman developed an option for its system called "EAYES," which takes these wire weather bulletins and turns them into



The Digital Weatherman III,
From weatheradio

an EAS header. This header can be fed to your station EAS unit, along with the audio output by the Weatherman computer. Your EAS unit then would treat this wire-generated EAS alert as a normal incoming audio EAS alert.

The EAYES system software can be purchased alone for \$495, or with a computer for \$1,995. It can also be added to the \$195/month full-service Weatherman package as an option for \$10 per month.

The basic EAYES program can handle alerts for up to five counties, with additional counties added as an option. The cost to have the announcements presented by your own announcer's pre-recorded voice is \$500 per announcer. You can also use the EAYES program to schedule and run your Required Weekly Test, complete with header generated by their unit. For more information, call (800) 728-4647, ext. 100, or circle Reader Service 193.

IHAD for Cable TV

TFT Inc. is now beta-site testing its In-Home Alerting Device (IHAD) for release in the spring of 1998. The unit loops through a subscriber's in-home cable TV feed, reacting to alerts sent by a special TFT-IHAD modulator card fitted into the TFT 911 EAS unit at the head-end. A specific signal is sent down the cable that communicates only with the IHAD units.

The units can be assigned to any one of 16 IHAD zones, these IHAD zones then being linked to the actual EAS header county subdivisions. Upon receiving an alert for its IHAD zone, the unit flashes, beeps and gives an external closure. An RWT or RMT test yields a different, distinct flash/beep pattern.

The unit has a target price of \$29.95 and is expected to be sold directly to cable TV companies. For more information, call (800) 347-3383, ext. 215, or circle Reader Service 26.

■ ■ ■

Gary Timm is chairman of the Wisconsin State Emergency Communications Committee (EAS Committee), a member of the FCC EAS National Advisory Committee (NAC), the SBE EAS Committee and the SBE Chapter 28 Executive Board, and has worked at WTMJ(AM)-WKTI(FM) since 1973.

Tell us about your experiences with EAS receiver equipment. Write to RW at chamaker@imaspub.com

WEGENER DIGITAL SATELLITE

If you need audio transmission...



We've got you covered.



Wegener Digital SCPC Family

- Highest quality audio with ISO-MPEG
- Wegener offers both QPSK and BPSK
- Addressable with Wegener ANCS
- Auxiliary data for printer and e-mail



Wegener Digital Sub Carrier Family

- Three times the channel efficiency
- Video and FM2@ sub carrier
- CD quality, mono and stereo
- Balanced audio or AES/EBU outputs optional
- All this in just one rack unit!

Contact your Harris Satellite Salesperson Today!



Harris Broadcast Satellite

TEL: 888-729-0082

FAX: 765-962-8961

<http://www.broadcast.harris.com>

How can a 15 channel Console be at the unheard of low price of **\$3,995** ?

Rugged, durable, reliable, high performance, and fully featured, the 1200 series is ideal for On Air, Production, & News in any market size studio.



10 ch model
Sale - \$2,995
(List- \$3,495)



Because Arrakis is #1 in Consoles, Digital, & Studio Furniture for Radio !!!

and we are #1 because of Quality, Features, Performance, & Price...

- **Quality-** Penny & Giles slide faders, 5 million operation On/Off switches, ITT Schadow switches, solid oak trim, .125" hardened aluminum panels, DC controlled with no audio on pots or switches, External power supply with current limiting protection. *And much, much more...*
- **Features-** Program & Audition output buses with mono mixdowns and two mix minus buses for telephone interface. Momentary & sustained remote start control of sources. Talk turret interface with channel On/Off, Cough, and Talkback. Optional control interfaces for Arrakis digital workstations. Ideal for On Air, Production, News, Talk studios and *much, much, more...*
- **Performance-** digital audio level performance with greater than 100dB dynamic range (CD's are only 96dB). THD<0.02%, Ultra high performance mic preamps, Very low crosstalk, High quality VCA's, reed relay audio switching, and *much, much more...*



5 ch
model
\$1,795

To find out more, call- 970-224-2248

arrakis
SYSTEMS INC.

Ad Campaign With all the Fixin's

► SUB, continued from page 39

federal budget of pork. It was the type of Beltway humor sure to attract attention.

"Each time we use Clinton in a spot," Siller said, "we find we get high visibility, the sales go out of control and people tell us it's the funniest commercial they've ever heard."

Not everybody finds them amusing. White House lawyers took the time to demand that Jerry's drop Clinton from the spots. The demand to "cease and desist" came last spring, after the first "Show me the cheese" spot aired. It features a Clinton impressionist doing a take-off on Cuba Gooding Jr.'s "Show me the money" line from the movie

"Jerry Maguire."

Rather than pull the spots, Siller came back with more. In the next commercial, a famished president calls Jerry, eager to chow down in the Oval Office. Included is this exchange of dialogue:

Jerry: "How do I know it's really you?"

Clinton: "Who else would it be?"

Jerry: "I don't know, maybe it's someone impersonating you."

Comedy

It was a light jab at the lawyers, mocking the notion that listeners thought the spots features the actual voice of Bill Clinton.

In the latest spot, the president purchases a New York Style Pizza and wolfs it down:

Jerry: "Gosh, sir, you ate that so fast, you practically —"

Clinton: "Inhaled it?"

Siller defends his use of Clinton to sell pizza and subs, saying it is necessary to compete with the fast-food giants. "One way to get visibility," Siller said, "is to impersonate the president, because whatever he does is news."

Siller also said Clinton is no stranger to fast-food. "He's a big-time eater, and I'd love to have him try one

Jerry's

Subs • Pizza

Headquarters:
15942 Shady Grove Rd.
Gaithersburg, MD 20877
(301) 921-8777

Ad Agency: Capital Media

Ad Info: Capital Media (301) 468-8929

of our cheesesteaks."

Siller is convinced that the president has a good sense of humor and would probably laugh at the spots if he heard them. Others certainly have heard the spots, which have captured several awards, including, the Excellence in Advertising in Radio award from Multi-Unit Food Service Operators.

As much as Siller enjoys creating the radio commercials, the fun is secondary.

"There is product-sell throughout the commercials. The extra spin is fun, but it's all for one goal: buying up the product is what this is all about."

"Black Sheep Marketing" is doing just that.

**You
Read
It
Here**



One Year Ago

Call it greed or call it business savvy, but the Department of Justice called the Rochester acquisition plans of American Radio Systems Corp. too much. ...

ARS originally wanted to buy four Rochester Stations from The Lincoln Group. ... The purchase would have given ARS a total of seven stations in Rochester, the local limit for markets with 30 to 45 stations.

Justice determined that ... gave ARS control of more than 60 percent of the sales of radio advertising time in the city. That proved too much for the Justice Department.

"Radio Ponders DOJ Action"
News Item
Nov. 27, 1996

Five Years Ago

"How soon will it be practical to design and build the all-digital facility?" That question and others were explored during a session titled "Building the Digital Facility — Managing the Transition to the Future," during the Digital Radio Seminar at the NAB Radio Show.

As session moderator Donald Lockett of National Public Radio observed, many station today are a hybrid of digital and analog technologies. Yet, while digital technology is increasingly commonplace at radio stations, it is still developing. "Are the benefits worth the capital investment when considering new facilities?" Lockett asked.

"All-Digital Station Still in the Future"
NAB Radio Show 1992 Wrap-up
Oct. 21, 1992

Y O U R O N E



FOR SATELLITE SERVICES.

NPR Satellite Services can customize your package to include any of the following:

- ✦ Full-time Service - 24 hour programming capability;
- ✦ Occasional Service - lease according to your need -- whether it's for an hour, a day, or an event;
- ✦ Digital equipment;
- ✦ Uplinking services - either portable or fixed - can get you up and running FAST!
- ✦ Top-notch, 24 hour-a-day troubleshooting and monitoring by our System Technical Center (STC).

STOP Your Search...

Call NPR Satellite Services at (202) 414-2626 for more information on your customized satellite services package today. Link up with us for a one-stop solution to your satellite services needs.



NPR Satellite Services®
Link Up With Us

635 Massachusetts Avenue, NW, Washington, DC 20001
(202) 414-2626

PROMO POWER

Crucial First-Quarter Promotions

Mark Lapidus

The longed-for break that the holidays provide leads many of us to feeling a bit confused after the first of the year. We worked hard in summer and fall. Now that the first quarter has arrived, the pace of life has relaxed.

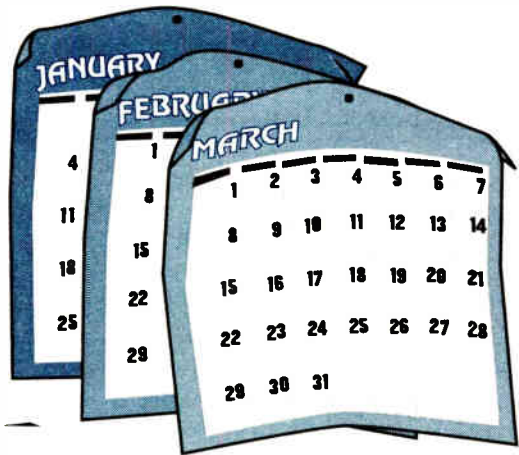

Business is slow. Meetings happen less often and the sense of urgency one feels in the spring is months away. For programming and promotions people, this is valuable time. Used properly, it can give your station the advantage over those who languish in first-quarter hibernation. Work on just a few of the following items and reap the benefits that can set you up for a terrific year.

Advertising awareness

In most of the United States, as folks experience the chill of winter, homes using television go way up. Folks are stuck inside and they are bored. Use that to your advantage, and advertise your station on TV.

As in radio, television advertising rates are at their lowest demand in most markets. This leaves room for trade and good deals for units in prime-time shows that you could never afford in the spring. Many managers pooh-poo the idea of advertising in the first quarter because they feel the winter book just isn't that important. Wrong!

Sampling and top-of-mind awareness is a year-round game. Entice people to listen in the winter, and your odds increase for spring. Perhaps the strongest case I can make for television advertising

in the winter is that few stations do it. Contrast that with spring, when you can see spots for different radio stations within the same show in some markets.

As for telemarketing and direct mail, again your odds are better when your potential listeners are at home to receive your message. Two media that are not ideal for winter are transit and outdoor. Unless you're buying lighted signage, the visibility is limited with shorter and cloudy days. Signs also get dirty and damaged due to sleet and snow.

Review and revive

January is the best month to get together privately with each staff member for a performance review and motivational session. Learn their goals. Hear their ideas. Make a pact for an outstanding year.

Meet promoters and event planners. These people are hard to see during the season. Renew your friendship and make plans for the coming season, while you can do so without standing in line.

If your annual promotion calendar is not complete, this is the ideal month to finalize and disseminate your plans to the entire station staff. Too often, promotions are not sold or even planned properly because the facts are not known far in advance by other staff members. For those who need a few quickie first-quarter promotions, allow me:

Groundhog Day, Feb. 2: Set-up two voice-mail boxes and encourage listeners to vote "Yes" or "No" as to whether Phil will see his shadow. Randomly select a winner from the correct voice-mails, and award him or her a prize suited to six more weeks of winter or an early spring. These prizes come from sponsors who pay for this promotion. You could also allow people to register in "Yes" and "No" boxes at sponsor locations. Another quickie promotion for today is simply to give away ground hog (sausage). The trigger to call and win could be a clip from the movie "Groundhog Day," or just a squealing pig.

Valentine's Day, Feb. 14: Idea No. 1, The Ultimate Blind Date: Have listeners enter at retail locations by dropping off a picture of themselves and a description of

their dream date. Match as closely as possible. Blindfold your two winners. Your morning person picks them up in a limo, carefully blindfolding them before they meet. Take them to dinner and a show, still blindfolded. The next day, these two join the morning man on the air to describe their date and what they think the other person looks like.

Idea No. 2: Hold a mass wedding (or renewal of vows) with free services and lots of on-air attention. Begin by seeing if anyone in your audience would like to propose on-air. This gets television coverage in most markets.

Idea No. 3: Maybe a surgeon in your area needs a little publicity. Give away free vasectomies for Valentine's! This makes a very unusual live broadcast.

Idea No. 4: Valentine's Shopping! Hold your singles night at a grocery store. The women get roses. The guys get carnations. Match up couples for a scavenger hunt of items. Invite the media.

President's Day, Feb. 19: George Washington couldn't tell a lie, but you can. Tell listeners that at least once an hour you'll lie about something. Every time someone catches you, they win dead presidents: \$5 (Lincoln), \$20 (Jackson), \$50 (Grant) and so forth.

St. Paddy's Day, March 17: Invite listeners by your live morning breakfast broadcast to show off "their green thing." The strangest win prizes. Serve green

eggs and ham.

Idea No. 2: Find the largest parade in your market and reserve a spot. If you don't have something to enter, rent a hot car that you can attach banners to, or get a bunch of golf carts, attaching one call letter to each cart, until your letters and frequency are spelled out.

Avoid the first-quarter 'sag' by following these tips.

Idea No. 3: Have free cabs for drinkers who are too green to drive.

Oscars, end of March: Look in your phone book for a family named Oscar. Get their predictions. Make them celebrities. Invite a select group of listeners to your private "Oscar Party."

And don't forget, *April Fool's* is right around the corner. Even a stupid practical joke takes planning! Do it now and you can have great ratings, get a raise, retire early and hit the lottery. Okay, maybe not ... but at least your odds will be better if you use the first quarter to your advantage.

■■■

Mark Lapidus is president of Lapidus Media, now launching "UPCOUNTRY," an Uptempo 90s Hits niche to compete with mainstream country. Call (703) 764-3994 or e-mail lapidus@erols.com



Is Your News Feed Eating Away Your Profits?

United Press International's radio network is substantially less expensive than your current news feed!

How? For starters, UPI has no required packages. You pay for only the programming you need. With UPI you're never charged for special events coverage.

UPI offers news 24 hours a day, sports 16 times a day, and business all day long, including morning reports live from London, all without network commercials. We also have the industry's widest variety of one-minute features that are topical, timely and keep listeners interested.

Call now to find out how much you can save by gaining the UPI advantage.

UNITED PRESS INTERNATIONAL

UPI

(800)

503-9993

RADIO BUMPERS

WCMF-FM, in Rochester, N.Y., has been around a long time, as its bumper sticker amply demonstrates.



Lori Baister, marketing director for WCMF, said the sticker "represents WCMF's 29-year rock heritage, yet

displays edge and attitude about the station."

What message does your station bumper sticker convey? Send the sticker, and a 100-word explanation, to:

RW Bumper Sticker, 5827 Columbia Pike, Third Floor, Falls Church, VA 22041.

STATION SERVICES

Companies with announcements for Running Radio Station Services should send them to:
Radio World, c/o Running Radio Editor, P.O. Box 1214, Falls Church, VA 22041

Learn About the Senior 'Experience'

Check out a radio program that eschews the young male demo and instead aims solely for senior citizens. "The Voice of Experience," co-hosted by actor Hugh Bogan and columnist Jane Glenn Haas, is a good fit for news/talk, MOR and Nostalgia stations that cater to older demos.



Hugh Bogan

Blu's Alley Productions produces the call-in program, which it bills as a "news magazine dedicated to the Senior." Special guest segments include "Cherney's Corner," with author Walter J. Cherney and "Buying Money," with Mike Pikkell.

For information contact Craig Ginsburg at Blu's Alley Productions in California, (805) 948-9796; or circle Reader Service 50.

Satellite Alternative

Customized programming — from music and jocks, to jingles and liners — can now air on your station without satellite delivery.

Virtual Radio Programming is delivered to the computer control room system via ISDN, a wide area network, compact disc or portable hard drive. VRP will provide whatever your station needs, and will customize the programming for your station. Your listeners will not hear it anywhere else.



VRP uses air talent from the top-20 markets, incorporates any previous music testing done for your station and allows you to choose the shifts you want customized, all without interfering with commercial inventory.

For information contact Matt Killion at The Research Group in Seattle; (206) 443-3888; or circle Reader Service 74.

Do You Pass the 'Diner Test'?

How does a talk show host who wants to "be the voice of hardworking middle Americans" tap into that sentiment from a diner in Massachusetts? Answer: link up with other diners and discuss issues of the day with patrons across the country.

It's all part of the "diner network," from "America, Good Morning." The Talk America Radio Networks program is hosted by Phil Paleologos, who stated "We'll see what passes the 'Diner Test' across the nation and question 'the conventional wisdom.'"

Paleologos is joined on each broadcast by the morning team of Scott Montminy, Jeff Clothey and Emiko Tamagawa.

For information contact Talk America Radio Networks Station Relations in Massachusetts, (617) 828-4546; or circle Reader Service 98.

Format-Specific Holiday Fare

Country stations and oldies stations still searching for holiday programming can find a programming solution if they move fast.

MJI Broadcasting tailors "Jingle Bell Rock" for the oldies format and "Home for the Holidays" for country outlets.

Former Herman's Hermits member Peter Noone hosts "Jingle Bell Rock," which includes standards such as Bing Crosby's "White Christmas" and holiday songs that are not ubiquitous, such as "Christmas Message," by the Beatles.

Country performers featured on "Home for the Holidays" reminisce about their fondest memories of spending the holiday season with family. These reminiscences are accompanied by songs from performers such as Garth Brooks and LeAnn Rimes.

For information contact Lauren Alperin at MJI Broadcasting in New York, (212) 896-5224; or circle Reader Service 122.

Music to Your Ears

Are you afraid this could be the last time? If you could not get tickets or simply need an encore, you can get satisfaction from Westwood One, the exclusive Rolling Stones "Bridges To Babylon" Radio Network.



Westwood One delivers a series of Rolling Stones concerts and specials nationwide, culminating with a live broadcast of their performance from San Diego on Feb. 3, 1998. Other programs slated to air are "Across the Bridge to Babylon With the Rolling Stones," a three-hour comprehensive look at the Stones airing Dec. 29 through Jan. 5, 1998, and "BBC Classic Tracks," a sequence of 15 classic live performances available to stations in mid-January 1998.

Westwood One also announced that Ramblin' Ray, a morning personality on country station WUSN(FM) in Chicago,

now hosts "Country's Cutting Edge," a one-hour, weekly program from Westwood One that looks at "what's on the horizon for country music."

For more information contact Peggy Panosh at Westwood One in New York, (212) 641-2052; or circle Reader Service 170.

Fresh From the Oven

Radio Potato has put together a buffet of commercials for small and medium market radio station sales departments. Dubbed "Spud Spots," this series of commercials is fully customized with major-market voice talents; the spots are delivered via the Internet.

Each Spud Spot is customized by the original voice talent. The vast list of categories to choose from include Appliance/Furniture, Auto Parts/Repair, Car Dealer, Computer/Office, Nightclub and Restaurant. New categories are added monthly.

Benefits of Spud Spots include samples for prospective clients, Internet delivery (eliminating duplication and shipping costs), new commercials every month, cost effective pricing and a 24-hour turnaround time.

For more information contact Marshall Such at Radio Potato in Texas, (817) 481-4453; or circle Reader Service 194.

The Morning Road

Looking for a change of pace during your dreaded crawl to work? United Stations has come to the rescue.



Recently launched and airing live daily from 7 a.m. - noon (EST), "The Morning Show" is a syndicated program featuring celebrity interviews, song parodies, topical comedic skits, hourly news updates and listener phone calls. Hosted by former New York and Boston morning man Alan Colmes, the show is designed to appeal to talk, sports and AOR formats. Rounding out "The Morning Show" are news anchor Shelli Sonstein, stand-up comedian Louise Violano, who brings several characters and voices to the program, and actor Spruce Henry.

United Stations also has acquired "The Road," a weekly two hour show featuring live concert performances by various country artists. The program captures the excitement of country music's top performers in concert, and ventures backstage to present the music and stories of those writing, producing and recording the music. Hosted by Tony Russell, each broadcast features a headliner, one or two performances from an exclusive arena, an in-depth interview with a country music artist and a rotation of country hits.

For more information contact Julie Harris at United Stations in New York, (212) 869-1111; or circle Reader Service 218.

No salary,
no benefits, no ego.
Isn't it everything
you've always wanted
in a medical reporter?

The Johns Hopkins Health NewsFeed is a daily sixty second radio program that lets you bring your listeners the very latest medical news from the world's finest health care institutions. What's more, this first-rate programming featuring world-

renowned doctors, scientists and health care experts from the Johns Hopkins Medical Institutions is available every weekday **FREE OF CHARGE**. For more information, contact Tom Haederle at 410-955-2877 or 1-800-MED-RADIO.

HEALTH NEWSFEED
A SERVICE OF THE JOHNS HOPKINS MEDICAL INSTITUTIONS

Available on The USA Radio Network

Circle (38) On Reader Service Card

STATION FINANCING

Learn the ABCs of EBITDA

Dain Schult

This is the sixth in a multipart series about buying and financing radio stations. The previous part appeared in the Nov. 26 issue.

With the love affair that most Americans have had with automobiles throughout this century, there probably is not one reader who has not, at one time or another, been struck by "new car fever." You know that feeling, when you absolutely, positively have to have that new sheet metal sitting in your driveway and nothing, including logic, will stand in your way.



Savor it. Enjoy it. But do not ever let it spill over to your desire to own a radio station. This thinking will be the death of your ownership dreams.

Radio, by its nature, is a closed-ended universe. Unlike the millions of cars that Detroit, Europe and Japan crank out each year, there are only so many commercial stations available for sale at any given time, and there are a finite number of stations in broadcast spectrum.

Therefore, it is always more likely that it will be a seller's market rather than a buyer's market. This is good news for all

of the potential station sellers, but not necessarily the best news for us would-be buyers and owners.

It is a seller's market again out there on the streets. Since I began this series of



John Saunders

articles for RW, I have watched sales prices start to climb again, and there has not been a break yet. Unlike the latter part of the 1980s, without the old FCC ownership caps, there is nothing to stop prices from creeping upward in some cases and raging upward in others.

"Sales prices even in the smallest markets are climbing," said Jack Riley, president of Dallas-based Riley Representatives. "The owner in one of those markets will read the trades and see what something in Dallas, Houston or New York just went for, and then think he or she should be able to get the same kind of multiples."

Freak show

The key is to take a deep breath and not become completely freaked out every time you read the latest releases from the FCC regarding station transactions and the prices. When you are a major-market player, the whole country is your market.

You have public money to work with, and rising cash-flow multiples become minor speed bumps instead of the insurmountable hurdles they are for you or me.

You must remain firm to what you have to work with in terms of your capitalization. But what are fair multiples these days?

Here's my read on them. These are the numbers I work with each day in trying to buying more stations for my own group:

- Between 3 to 3.5 times gross annual billing on stations (AM/FM combos or stand-alone FMs) without any profits or cash flow. This is the formula you use for turnaround deals. The number would drop to between 1 and 2 times gross for a stand-alone AM.

Try to stay away from the term "stick value," though it appears to be in vogue again. A lot of buyers got in serious trouble in the late '80s and early '90s by purchasing stations on stick value. While the term is supposed to convey the alleged value of a standalone FM station in a rated market (normally considered on a 100 kW FM), I have seen it bastardized to mean the value of any FM or AM station in a particular market.

- Between 4.5 and 7 times cash flow in a small (unrated) market; between 6.5 and 10 times cash flow in a rated medium market; and between 12 times and infinity (no puns intended) in major markets.

"As with any business transaction there are exceptions to the industry formulas," said John Saunders, a Houston media broker. "Some stations go higher, others lower. It's all a matter of what a buyer and seller finally agree upon."

But what is cash flow? The term that

The term 'EBITDA' means Earnings Before Interest, Taxes, Depreciation and Amortization.

seems to drive financing types crazy is "broadcast cash flow." They do not understand it. In the radio business, broadcast cash flow means how much a station has earned in profit plus back depreciation, amortization, non-recurring expenses, interest on loans, lease payments that go away when the station sells and extraordinary one-time charges.

Bankers prefer the term "EBITDA," which means Earnings Before Interest, Taxes, Depreciation and Amortization. In any event, it is a study of what capital will be available at the end of month and the year to repay the loans made on the deal.

While reviewing the financials on a potential acquisition, beware the temptation to start adding back costs that

See CASH, page 46 ▶

ATTENTION P.D.s

Schedule the best in "CLASSIC RADIO" with

When Radio Was ...

Hosted by Radio Hall of famer **STAN FREBERG**, the man who drained Lake Michigan and filled it with hot chocolate

THE LONE RANGER

THE BICKERSONS

THE GREAT GILDERSLEEVE

THE SHADOW

JACK BENNY

THE LIFE OF RILEY

THE CHARLIE McNEARLY SHOW

LIBBER M'GEE AND MOLLY

SUSPENSE

OUR MISS BROOKS

SHERLOCK HOLMES

LIGHTS OUT

BURNS & ALLEN

ESCAPE

XMINUS ONE

Now in its 8th year

Five shows per week—54 minutes each.

BARTER, NO CASH PAYMENTS!

For a free CD contact David West.

DICK BRESCIA ASSOCIATES (201) 385-6566

Heard on 300 Radio Stations

THE WATER FOUNDATION

Radio Tips On Conservation

- ★ **Eco-Auto® Tips:** Money saving :60 automotive conservation tips. NEW
- ★ **Outdoor Trivia®** 2:30
- ★ **Ocean Planet Trivia** 2:30
- ★ **Frog Friendly® Tips** :60

• Award Winning Programs • Fits ANY Format
• Barter Basis • No Long Term Contracts
• Easy Local Sponsorships

Phone 218-764-2321 • FAX 218-764-3582
e-mail: boginfo@brainerd.net; <http://www.bogfrog.com>

The WATER Foundation P.O. Box H20, Brainerd, MN 56401

Conservation Pays!

How Much Should a Station Cost?

► CASH, continued from page 45

you know will drop off because of how you plan to operate in comparison to the operation of the current owner. If you add the back costs, you are in essence giving the seller the benefits of all your hard work in the future actually to effect these positive changes at the station.

Everybody else may appear to be doing deals that make no sense to you, but this is no license for you to do likewise. I face this dilemma daily. My company, Texrock Radio Inc., just closed on our first two acquisitions here in Texas, and we have another 19 stations in the hopper at various stages of the closing process. Every time I do another deal, I set the benchmark for what the next

seller thinks is my threshold for pain in station pricing. So far we have been fortunate to maintain a cash flow multiple for the whole group that is still under 7 times cash flow. I realize that multiple will not stay there forever, and the pressure for it to inch up into double digits is constant.

Resist temptation

It comes down to the personal discipline to resist the temptation of paying more than I know we should. If I do not resist, someone else will. In just the last two weeks, we have lost three deals, outbid on all three by bigger groups. Because I am not privy to their rationale for purchases, perhaps these groups are better able to justify the sales

prices they have agreed to than I would be. In any event, all the money spent has to be paid back to somebody, whether it is banks, venture capitalists or stockholders. Never, ever forget that if you want to survive the competition. Stay alive for the next installment, when we will work toward your first purchase.

■ ■ ■

Dain Schult is a 30-year broadcast veteran and consultant with experience as a DJ, general manager and group operator. He is based in Austin, Texas.

Got a question or suggestion for Dain to address in an upcoming part of this series? Send an e-mail to RW at chamaker@imaspub.com and let us know.

Make Crown Broadcast your next move. . .

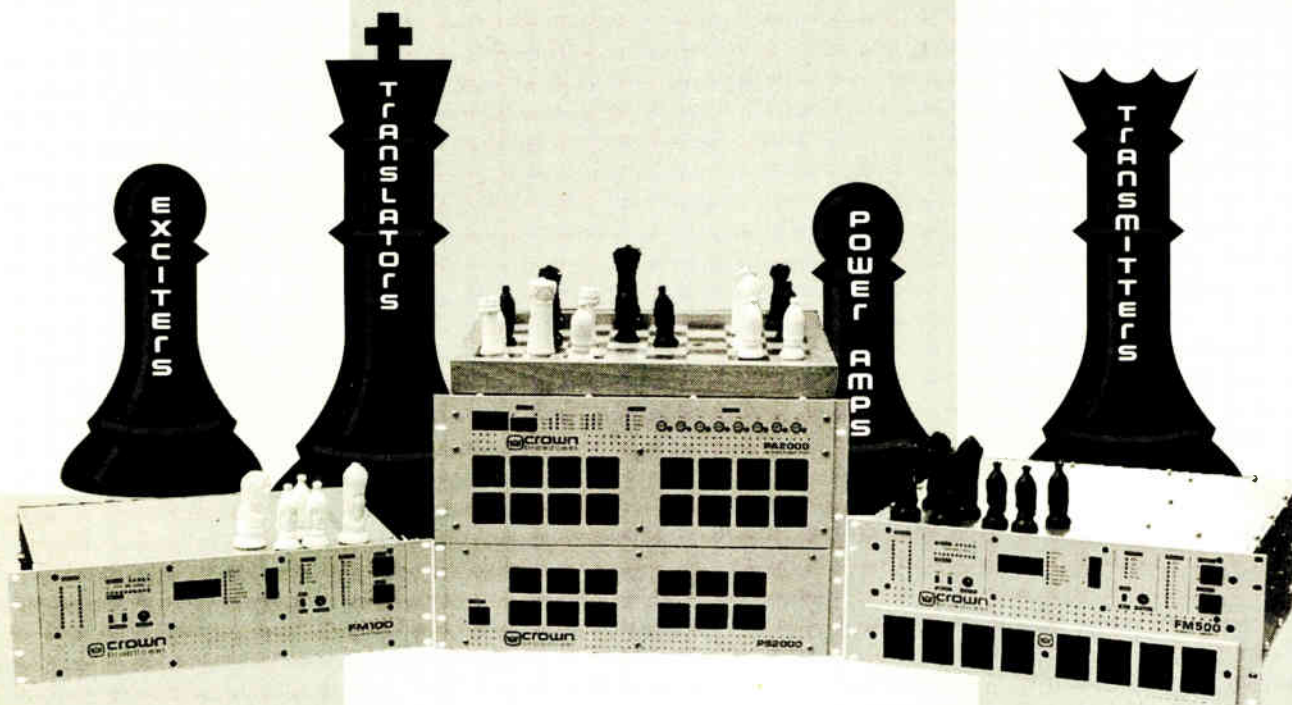

when you want to "checkmate" the competition!

Crown Broadcast offers you versatility and flexibility in every broadcasting move you make. Our fully integrated transmitters can be configured for stand-alone applications, including satellite-fed networks, as repeaters for terrestrial-fed applications, or as exciters providing the most cost effective way to get Crown-quality components into your system. When you want to extend your broadcast coverage, add one of our highly efficient amplifiers. Like all Crown products these units are designed to provide modularity, reliability, and ease-of-use to strategically position you in the marketplace.

Crown Broadcast champions our customers by providing knowledgeable technical staff, a 3-year limited warranty, and comprehensive product information. This powerful trio is designed to support you through any broadcasting challenge. Need to make your next move fast? We can deliver product built to your requirements within ten days (or overnight in emergency situations). Just one more way that Crown Broadcast provides versatile solutions for lasting value.



1718 W. Mishawaka Road, PO Box 1000, Elkhart, Indiana, U.S.A. 46515-1000

Phone: 800-294-8050 or 219-294-8050; Fax: 219-294-8222

Email: broadcast@crowntnl.com; Internet: www.crownbroadcast.com



Hafler Promotes Gentry

Hafler, a division of Rockford Corp., promoted **Rick Gentry** to national sales and marketing manager. Gentry's responsibilities will include advertising, management and training of sales representatives and dealers and developing new product lines.

Gentry brings 25 years of experience with the music and audio industry to his new position.

Logitek Appoints Marketing Director

Richard Byrne has been appointed marketing director for Logitek. Byrne is the former vice president of Radio Computing Services and current president/owner of Mediacom.

Byrne's responsibilities include developing both domestic and international markets for new Logitek digital consoles. He also will be involved with creating advertising schedules and budgets.

LBA Promotes Two

LBA Technology, Inc. announced the promotion of two employees. **Walter Aytch** will assume the position of production manager; **John Hunter** has been named production engineer.

Aytch joined the company in 1992 as a technical assistant and was promoted to manager of custom

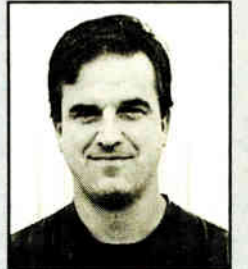

John Hunter

products. Aytch brings experience he received as a United States Air Force avionics electronics technician to his new position. Hunter has been with LBA since 1993 and as technician and manager of assembled products. As production engineer, he will be responsible for product design and testing of a variety of electromechanical assemblies.

Studio Sessions



Radio World

Resource for Radio Production and Recording

December 24, 1997

PRODUCT EVALUATION

Passport P.A. a Hit at Remotes

Flip Michaels

Most folks recognize the name Fender for its electric guitars and amplifiers. The company's famous Stratocaster has launched a thousand superstar careers and even more mid-life crises.

You will want to get to know Fender for its line of P.A. amplification, especially the new portable Fender Passport. This self-contained, fold-out public address system made a pretty good impression on the promotions folks here at WBIG(FM), "Oldies 100" in Washington.

Captain Kirk's luggage

When the Passport arrived on my doorstep, I didn't realize at that time what exactly was in view. In travel mode, the Passport looked like a next-generation mid-sized suitcase, packed for a trip to the stars.

When opened, the Fender Passport revealed two full-range cabinets, a powered mixer, two Fender P-51 dynamic mics and all necessary mic and speaker cables needed to patch everything together. The portable sound system from

Fender Pro Audio is ready to handle just about anything: nightclub acts, seminars, aerobics classes, and — in our case — deluxe station remotes.

Kudos to the Fender management guru who thought up the name for this unit. I kid you not when I say everyone from the air talent to the receptionist was seen carrying this compact, 53-pound public address package around. Did they ever think they would see the day when remote gear could be stored in a coat closet? The universal answer: "Never."

The Passport allows eight inputs — four line, four mic — across four stereo channels. Its 250 W mixer powers four full-range, 6.5-inch transducers per cabinet. Red and blue color-coded controls on the mixer surface show what each dial does.

The Fender Passport can run off any AC outlet or DC source such as a car-type battery when used with an optional DC-to-DC converter. The device adjusts load requirements to eliminate potential speaker damage from unreliable power. That is especially desirable when non-technical staff such as interns are assigned to a last-minute, we-need-to-

make-more-money remote appearance.

Other formidable features include built-in digital reverberation with footswitch on/off capability; patch points for outboard gear; stereo RCA inputs allowing both CD and cassette playback; and VIP (Vocal Input Priority), which

into the Tape Out RCA jacks on the Passport panel. You will capture a full mix output that is independent of the master level controls. At the end of the remote, smile and hand your client a copy of the full broadcast from start to finish.

In use

"The sound quality is great," said Tuesday Georges, part of the promotions department for WBIG. "People were always wondering how we sounded so big with a unit so small."

"The Passport's size is great for both transport and storage," Marcos Davila, a partner in promotions with Georges, said. "It took little or no knowledge of the gear to operate."

The Passport comes with two Fender mics, but if you care to use a favorite station mic, "EQ Contour" tone controls let you dial in the right sound to make your live talent sound great.

"Set-up took about 10 minutes for one person," Georges said. "We tested the Passport on some 15 remotes, including the Virginia Wine Festival, Red Cross Blood Drive, Food Lion, Radio Shack, a

See FENDER, page 55 ▶



The Passport Portable P.A. System From Fender

automatically ducks background audio when speaking to the masses through the Mic 1 input.

If you really want to get sales-ey, you can plug a tape deck or DAT recorder

Attack Noise With Sound Forge Plug-in

Read G. Burgan

Sonic Foundry's Noise Reduction Plug-In (SFNRP) for Sound Forge is well-established as an effective means of removing both impulsive and broadband noise.

with the noise specifically associated with records and transcriptions including surface noise and pops and clicks.

What time is it?

With its new DirectX version, Sonic Foundry has taken this tool to its next

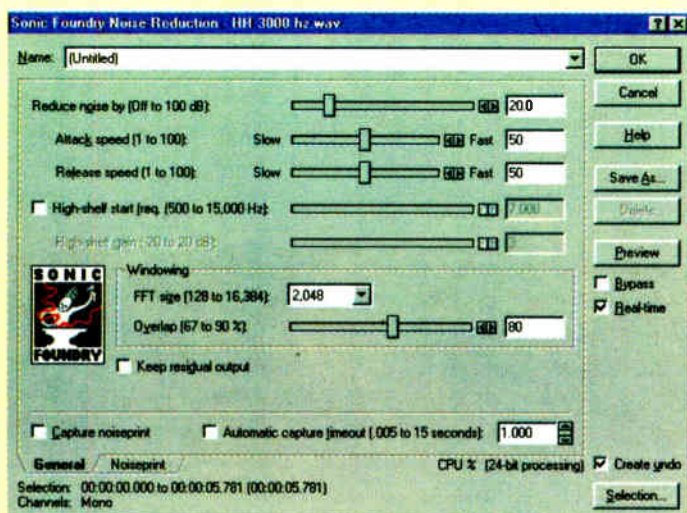

SFNRP contains three tools to attack noise: Noise Reduction, to deal with broadband continuous noise such as tape hiss and record surface noise; Click Removal, for pops and ticks; and Vinyl Restoration, with tools to deal

logical plateau: previewing in real time.

I have used SFNRP almost since its inception and have found it to be a most useful tool. But until now, you

See PLUG-IN, page 53 ▶

NAUGHT. NADA.

BE It's Back.

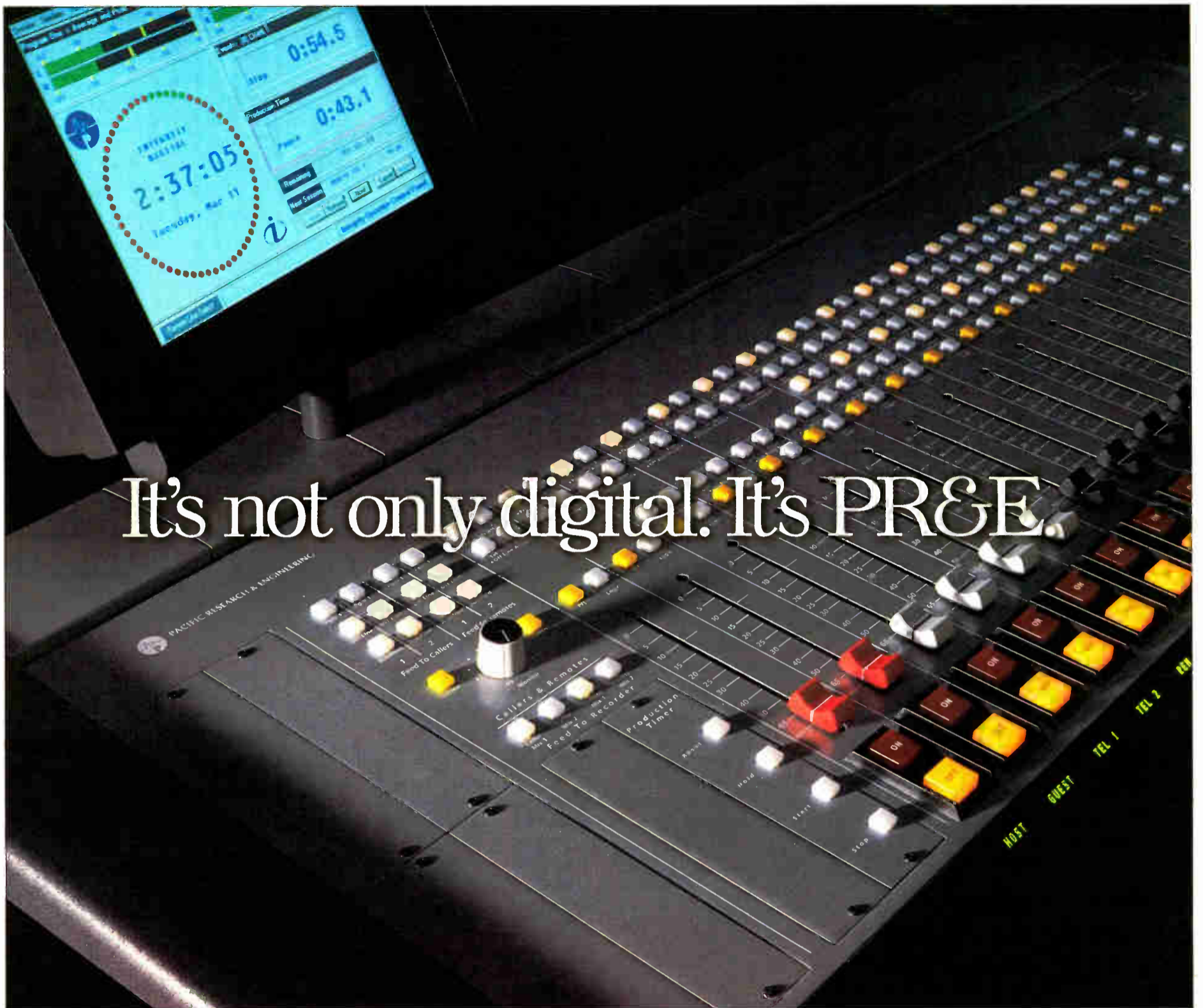

It's not only digital. It's PR&E.

Now you can get digital technology and PR&E reliability in the same console. Integrity.[™] It's the first digital on-air board that also speaks fluent analog. All 16 inputs can handle analog signals. Ten can also accept digital inputs at any sample rate. So you can deal with the hodge-podge of equipment in real-world studios. A unique architecture also guarantees a level of reliability other digital consoles can't match. So you can rest assured your signal will stay on the air.

What's more, you get on-board DSP voice processing, remote or local configuration controls, and channel-specific remote control connections. And you can set, save and recall each board configuration at the touch of a button for seamless transitions from show to show.

For a brochure, call us at 760-438-3911, visit www.pre.com or e-mail sales@pre.com



The LCD displays audio levels, time-of-day clocks, session status and event timers with a Windows[®] interface to powerful configuration management and session-based features.



Integrity's difference is more than just digital. It also offers four special-purpose buses to provide automated mix-minus for telephone and remote feeds, each with IFB.

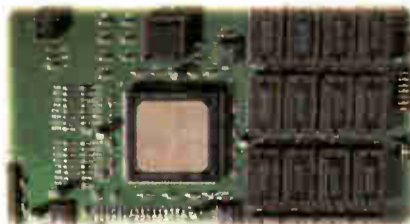

Integrity uses an array of state-of-the-art floating-point digital signal processors to perform its mixing, routing and other functions.



Each fader has a 10-character alphanumeric display. The display changes when another audio source is assigned, which can happen either manually or at a preassigned time.



PACIFIC RESEARCH & ENGINEERING

Circle 52 On Reader Service Card
World Radio History

A Kind Word to Holiday Airstaff

Alan R. Peterson

Memo to managers and engineers: This column is intended for those hard-working folks assigned to airshifts on Christmas Day. Please clip and leave in the main studio for all to see. Thanks and Merry Christmas.

—Al Peterson

So, you poor blighter, you got stuck having to work Christmas. I don't know if this is your first time or 20th time, but welcome.

This is supposed to be the happiest time of the year for all, but I know exactly how you feel: cheated, lonely, perhaps a little angry and a little sad. Same as the folks at home who were counting on you to be around and will remind you every chance they can how your job let them down. It is especially hard if you are a new broadcaster and this most likely, is the first holiday you will miss with your family.

Been there. Hated it. But stay with me for a few moments.

When I was on college radio back

during the Bronze Age, I got the bad news: I had to stay on campus to run the newsroom Thanksgiving Day. My plans were upset, my parents were horrified, my grandparents were insulted and my girlfriend wanted me dead. How dare I wreck all their holiday plans?

So I did my four hours and made it home for the celebration, but I never shook the memory. Nor did they.

My first year as a pro, I was 400 miles from home. After a late six-hour airshift, my holiday dinner was taken alone in a dim yellow booth at a Howard Johnson's restaurant somewhere in Noplace, U.S.A. I was all of 22 years old and felt like the last man on earth.

The telephonic voices of my family telling me how much they missed me weren't angry that time, but reassuring; knowing I was pursuing a passion and getting paid (very badly) in the pursuit. I was alone, but *I was working*.

In subsequent years, I have had to pull holiday shifts. Even when I made it to program director a couple of times, I ended up doing shifts on Christmas and New Year's Eve. I missed a lot of fun, but *I*

was working.

It stung every time I had to tell those around me, "I have to go in for five hours on Christmas." But I loved what I did for a living and few others around my table could honestly say the same.

In 1989, tired of feeling sorry for myself, I volunteered to be a cook and server for a mission house, serving Thanksgiving dinner to folks a lot worse off than I could ever expect to be. It turned out to be the most memorable holiday that I ever had to pull an airshift.

Buck up, Bucko

It is little consolation to be hearing it from me, but my friend, you are *working*. Look at the number of your friends and co-workers who ended up out of a job once the computer and/or syndicated show took over their shifts. Look at other friends who have jobs they despise who quietly envy your passion for your work.

OK, you have to work the holidays, enduring the scorn of family members who wanted you home, demanding someday you grow up, find a real job and stop "playing radio" already.

The point is, you are still in the game. You are gainfully employed in a career you are passionate about while others not as dedicated, talented or lucky have fallen by the wayside.

I am sorry they tapped you to work Thanksgiving, Christmas or both, but *you are working*, providing your family with the rewards the season has to offer and getting better at what you do, paving the way for greater rewards down the road. Hopefully someday they will see beyond the tinsel and understand.

What if all you have to do is open the mic every 20 minutes between Christmas songs to read some maudlin liner? Hardly worth the effort, right?

Perhaps not to you; but to your audience, you are providing the soundtrack to their happiest times. Everything going over the air brings back a cascade of

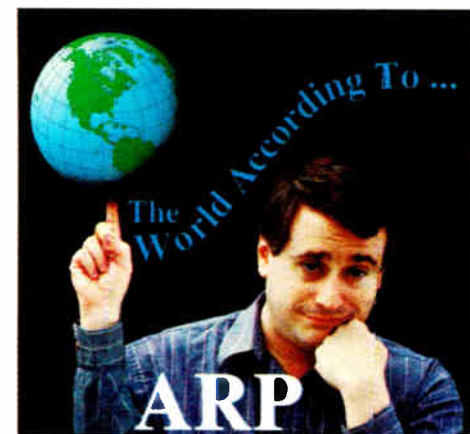

memories for them: the lean years, the successes and maybe even the time that they, too, had to work Christmas. Today they smile at the memories, as you will too someday.

It's a stretch, but take some comfort in the fact your performance is being appreciated, even if you are not running all of your boffo bits and nutty humor. Your listeners had a choice of dozens of stations, yet on the holidays, they still came back to *you*.

You heard it here first

You won't be hearing this from your intimate circle of family members, but you will hear it from me: Thank you for working on the most difficult days of the year. Try not to let it get to you. Remember, you are joined by emergency medical people, fire and police professionals, television crews, newspaper employees, restaurant staff and the poor convenience store clerk who probably feels lower than you do.

It is easy coming from me, as I do not have to work the holidays anymore. Someday you won't have to either, but in the meantime, know that it hasn't been such a long time ago for me that I have forgotten what it feels like.

Be pleased and proud you are doing what you love for a living, even if you have to do it on days you would rather not. Lots of out-of-work jocks would trade places with you in a heartbeat.

So open that mic and have a great show. Watch out for those booby-trap spots that say "Thru 12/24," and Merry Christmas.

I hope, at least, they gave you New Year's off.

SHORT TAKE

Meet 'Mackie HUI' ProTools 4 Expert

ProTools users now have a dedicated console designed to take advantage of a number of features formerly accessible by mouse or keystroke only.

The HUI (Human User Interface) console from Mackie offers control over many of the functions in ProTools, including levels, transport, input assigns and DSP. All functions and manipulation of audio still take place within ProTools; direct computer connection is through an RS422/RS232 port on the back of the HUI console.

The Assign section in the upper left of the HUI includes familiar conventions such as Pan, Input Assign, Send and Mute. Eight touch-sensitive hardware faders are motor-driven for automated mixing. Over each fader is an LED "scribble strip," where the user can label each fader's function.

DSP control is done in the upper right corner of the work surface. An LCD display and four "V-Pots" allow viewing and adjusting the most oft-used DSP plug-ins for ProTools. A V-Pot is a *virtual potentiometer* that combines a rotary encoder with an 11-segment LED position marker.

As a volume control, the LED segments would begin at an 8 o'clock position much the same as any conventional volume pot. As a parametric EQ, the value begins at the 12 o'clock position and wraps equally in both directions. It is also possible to show the LED as a single moving point, as if the

pointer of a knob.

Navigation around the various windows of ProTools can be accomplished with a cluster of Windows buttons to the left of the work surface. Directly within thumb's reach of the large jog/shuttle wheel is a quartet of cursor



control buttons that move the on-screen cursor in four directions. A button in the center operates the Zoom function.

"Tape" transport buttons handle transport control within ProTools and a numeric keypad inputs memory and edit locations. Another set of keys moves the user directly to Cut, Paste Copy and Delete commands.

Besides being a digital controller, the HUI also has two Mackie low-noise mic preamps with balanced XLR inputs.

Mackie designed the HUI at the same time Digidesign had ProTools version 4 in alpha form, so the two products complement each other. For information, contact Mackie Designs in Washington state at (800) 898-3211 or **circle Reader Service 75**.

—Alan R. Peterson

ZERO. ZILCH.



The Engineer's Dream Machine.

PRODUCER'S FILE

Neumann 'Volksmic' for the People

Ty Ford

Nothing creates pangs of hunger more than something highly desired and just out of reach.

With a list price well over \$3,000, the Neumann U87 has been out of reach for a lot of people. Having successfully tested the market with its simplified version of the TLM 170 — the \$1,495 TLM 193 — Neumann is testing again ... this time with the TLM 103, a condenser mic priced at a remarkable \$995 with swivel mount and box.

In theory, the TLM 103 is one-half of a U87: a cardioid-only version with no rolloff, no pad and a FET-driven preamplifier. In practice, the K103 capsule from the TLM 103 is different than K87 capsule used in the U87.

New design

The K103 capsule is specially designed with a single, large-diaphragm membrane. According to Neumann's Karl Winkler, a close check also will reveal that the holes in the backplate are of a different size and pattern than those of the U87.

In an effort to reduce manufacturing costs to make the price point, Neumann engineers figured out how to put all the works and capsule on one printed circuit board. The edges of the circuit board are enveloped by a synthetic rubber ring that

suspends the PCB and capsule into the body of the mic. The size, shape and



A Real Neumann for \$1,000: The TLM 103

parts of the head grille are identical to those of the U87 and TLM 170.

Not a bad idea, seeing as how these elements make up a noticeable part of the sound of the capsule.

To get to the heart of the matter, I

arranged to compare the TLM 103 with a recently cleaned U87 at Flite 3 studios in Baltimore. Both mics were run through API mic preamps and through the API console to Urei monitors.

Several things quickly became obvious. The TLM 103 has 9 to 10 dB higher output than the U87 (not a U87ai). The TLM 103 also has noticeably less self-noise. It does not, however, sound like a U87.

The high-frequency response of the two mics are different. The HF lift of the TLM 103 happened at 8 to 9 kHz, where on the U87 it happened at 5 to 6 kHz. Later we tried the dreaded "jangling key" test to see how well the FETs handled the transients. Both mics clipped the sound, but contradicting the HF response, the U87 appeared to reproduce a higher frequency range than did the TLM 103.

Using a middle-weight male voice working the mic at 4 to 5 inches, we had to roll the TLM 103 off 4 dB at 200 Hz to get it to approximate the U87 bottom end, when worked at the same distance. The TLM 103 sounded warmer and thicker than the U87.

Engineer Frank "Four" Ayd pegged the description when he said the bottom sound was reminiscent of an RE20. Lou Mills and I added that it reminded us of an RCA 44B ribbon mic's bottom.

When I took the mic apart to get a

before they made the drivers too bass heavy).

The TLM 103 was warmer than the RE27 and much smoother on the mids and top. It also was not quite as warm as I remembered it going into the API mic preamps at Flite Three. In fact, I could skootch in to 3 inches away from it without proximity becoming a problem.

Guitar solo

I hesitate to use a large-capsule condenser in cardioid pattern up close on acoustic guitar because the proximity effect usually results in the heavier sixth and fifth strings overwhelming the low end. I positioned the TLM 103 about 5 inches out from the sound hole of my D28S Martin guitar and pointed the capsule to the rear edge of the sound hole.

In that position the sound waves glance across the diaphragm at almost a 45 degree angle rather than smacking directly into it. A little angling here can do a lot to control the proximity effect, which I manipulate as an EQ control.

I slid my right hand back between the rear edge of the soundhole and the bridge and began finger-picking. In that position I got a nice clear tone with a very full, but not overblown bottom.

On the Web

Just for kicks, I recorded about 15 seconds of 16-bit, 44.1 kHz voice and uploaded it to my website www.jagunet.com/~tford

Go there and look in the audio archive for the TLM 103 files. The weakest part of the transfer probably was the A/D conversion from my DAT into my Mac 840AV Quadra, but you can still hear the warmth of the mic.

The TLM 103 is a good addition to the Neumann line, at a price almost everyone

It will make a great mic on any voice or instrument that could benefit from warmth and a little sheen.

closer look, Mills picked up the wind-screen and, after blowing through it, commented on how well it stopped the wind. Although it does the job remarkably well, I suggest a good pop filter for work within a foot. You cannot eat this mic unless you have a really thin voice, because the proximity will make the bass just too woofy.

Closing in

After a bit of experimentation, I found that the 4-to-5-inch average was about as close as I wanted to get to it myself. As quiet as it was and as much output as it had, the TLM 103 sounded great at that distance.

Even though the mic was decidedly warm-sounding — almost to the point of being tube-like — I decided to use it on a series of fairly aggressive radio spots. At Flite 3, I normally record with a U87, a Urei 1176 limiter in low ratio with mild gain reduction and no EQ. That worked for the TLM 103 as well. The tracks came out fine, no problem.

Back at my studio, I put an EV RE27N/D (the louder brighter version of the RE20) up against the TLM 103 to check our earlier feelings. I was using GML mic preamps, line-level out into a Mackie 1604 mixer and monitoring on AKG K240 headphones (the old K240s

with even the most meager setup can afford. In addition to the applications mentioned, I suspect that it will make a great mic for female vocalists or on any voice or instrument that could benefit from warmth and a little sheen.

It also sounds like a good prescription for an on-air mic, provided you do not eat it. I found that 3 inches was about as close as I could get. The optional suspension mount for the TLM 103 (the EA 103) lists for \$175.

■ ■ ■

Ty Ford's new "Homely Page" contains review articles, audio and video clips. Get there by visiting www.jagunet.com/~tford



One Month of Audio on One Drive? See the Jan. 7

RadioWorld



BAYS

Stainless steel construction, input connector type N, Maximum input power per Bay 600W, circular and vertical polarization

POWER DIVIDER

Brass made, chrome plated, EIA 78 input connector, Broadband 88-108 Mhz, maximum input power 2 Kw, Stainless steel mounting brackets included double step.

JUMPER CABLES

1/2 inch coaxial cable, included male

PRICE

\$1,650.00

Offer valid until May 1997

OMB America
3100 NW 72 Ave #112
Miami, Florida 33122
Phone: 305-477 0974
Fax: 305-4770611
Toll free: 888-OMB-4-USA
E-Mail: info@omb.com

MP 2-4

OMB also Manufactures:

FM transmitters
TV transmitters
FM and TV Links
TV antennas

Medium power FM antennas **1-888-OMB4USA**

For other radiating systems please contact us

No Noise at All With Troy Wall

Alan R. Peterson

"Troy Wall" may sound like the name of a '50s-era matinee idol, but is actually a patented product that combines new construction materials with conventional sheetrock and metal studs to attain "the highest transmission loss values ever recorded under laboratory conditions," according to company literature. Facilities considering highly accurate and noise-free studio space should know about the Troy Wall.

Troy Sound Wall Systems, of City of Commerce, Calif., has created a building element that has a previously unattainable Sound Transmission Class (STC) rating of 72. By contrast, conventional double-stud construction with fiberglass insulation and 5/8-inch sheetrock is capable only of about STC 58. The Troy Wall

can attenuate sound 72 dB from the source side of the wall to the receiving side.

In fact, the Troy Wall performed so well under laboratory tests at Riverbank Acoustical Laboratories in Geneva, Ill., that Riverbank intends to modify its test facility with its own Troy Wall.

To achieve this degree of isolation, the walls normally are as thick as 19 inches, making the technology impractical for small-room radio studios, but desirable for larger recording areas and control rooms.

The blend

A cutaway diagram of the Troy Wall is shown in Figure 1. Conventional gypsum sheetrock panels sandwich an interesting blend of semi-rigid materials that work together to offer up to 77 dB

transmission loss at 500 Hz.

Isolation figures this high surpass even *THX certification*, preferred in the motion picture theater industry for multi-theaters using digital sound. The Troy Wall would keep explosive sound effects inside one theater without disturbing viewers in the theater next door.

The sheetrock and common 10-inch steel studs used to support the Troy Wall keep costs reasonable, wall mass to a manageable level and construction simple. The "insulation material" shown in the diagram actually is mineral wool, compressed into a semi-rigid state.

"This is better than fiberglass," said Bill Bergiadis, president of Troy Sound Walls. "Fiberglass is useless when it gets wet and it melts in a fire. Our material is called Troy Wool and is specially made for us out of spun basalt mineral in Canada."

The "wood fiber" shown in the diagram is not the typical particleboard found at home improvement centers, but a 50/50 blend of wood fiber and portland cement, called Troy Board.

Bergiadis said, "There is a similar product out called Tectum, which is wood fibers and resin. But that can't get wet either, and the resin can be combustible. Troy Board is non-combustible and water-resistant." Tests show a Troy Wall offers fire protection of at least two hours.

An equivalent masonry wall offering similar transmission losses would be weighty and expensive to build. By comparison, 2-inch-thick Troy Board is 5.25 pounds per square foot, or 168 pounds for a standard 4-by-8 construction sheet.

When fully constructed with the 10-

inch metal studs, a Troy Wall is about 19 inches thick. Substituting 6-inch metal studs makes the wall narrower and drops the STC rating down to about 67, still considerably higher than a double-stud lumber wall.

Another advantage is gained in thermal protection: The layered materials help minimize the amount of energy

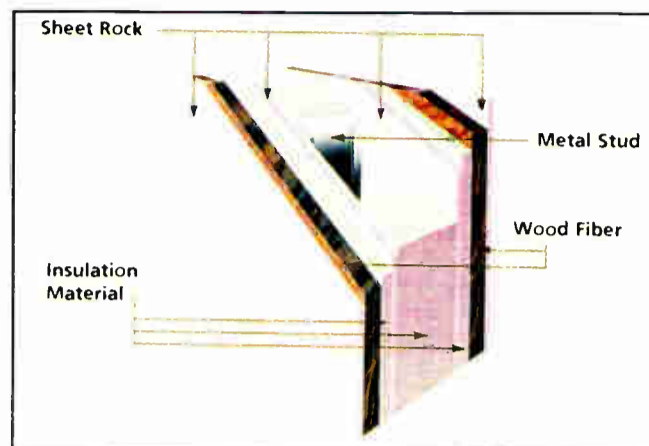

Cutaway View of the Troy Wall

Pull a Few Strings to Make a Great Spot

Gowan Gray

Need a last-minute effect to make a Christmas spot sound like a million? Try the "talking doll" trick.

Talking dolls have been around since the introduction of the Mattel "Chatty Cathy," around 1962. A nylon cord winds a spring-driven motor and drops a stylus randomly on a small phonograph record, playing back the character's prerecorded phrase.

Pull my string, baby

This machinery was used inside hundreds of toys and talking dolls until the advent of EPROM-recorded voice chips. For many, the talking doll effect is not complete without the sound of a pull-string first.

The character voice is easy to perform: Simply use your "phone effect" EQ setting on a mic.

To make the effect more authentic, record straight voice first, then patch the playback through the board's Audition line. Set the headphone source to Audition as well.

Now put your mic (in Program) up against a bad set of headphones — not the Walkman variety — monitoring the playback in Audition and cranked up to a healthy level. You will be recording Audition audio through the headphone and directing it to a second machine. There is something about the brittleness of cheap headsets and an inch or two of air that makes the process work better than EQ.

Nothing like the real thing

The pull-string and motor wind-up effect is difficult to do artificially. One effect that came close in my experience was a string and an empty oatmeal box, put together like a "tree-house telephone." Dragging the string between fingernails sounded a little like a windup motor, but the process was more trouble than it was worth. Sampling an actual talking doll's motor worked infinitely better.

I ended up using an Ernest P. Worrel ("Ernest Goes to Camp," et al.) figure. Several samples were recorded, with the best being a fast pull on the string; the slower ones just didn't give me that great mechanical "voop" noise that made the effect complete.

Acquiring two seconds of record surface noise was a bonus. Toy manufacturers place silent leader at both ends of a phrase so the motor can come up to speed and phrases are not cut off. My two-second sample can be indefinitely looped to cover the voice track and make the effect sound authentic.

A 13-year-old Tascam model 22-2 reel machine is still in my rig, as there are things I can do with it I cannot do in digital form, like have a talking doll start to break down.

Good old tape

The voice tracks are flown over to the reel machine, where the reels and pressure roller are manipulated during playback. By selectively dragging the feed reel or forcing the pressure roller off the capstan, the playback slows down, leaps ahead or drops out, all in real time. By taking the tape out of the path between the capstan and pinch roller, the tape runs free in Play mode.

This is a wonderful way to create the sound of a talking Christmas present gone wrong. Mix the sound of the pull-string first, then the sample of the motor ramping up, followed by the character voice. For a truly slapstick finish, drop in a few boings to sound as if Chatty Cathy stripped a gear and exploded.

This effect is great any time of the year, but try to use it to create a hysterical spot before your station starts that non-stop Christmas music special.

■ ■ ■

Gowan Gray is a former radio production director, now doing audio-for-video in cable TV production.

needed to cool down or heat up the studio space.

Cost-wise, the Troy Wall is said to cost less per square foot than concrete-masonry construction and double-wall designs. Bergiadis said a 6-by-6 foot isolation booth, 8 feet tall, would cost less than \$3,000, "without the sound-lock door."

Bergiadis said the name came from his 6-year-old son Troy during early tests of the wall.

The product is in use at NBC Studios, Bouquet Digital Studios and Occidental Studios in California, and Trafford Studios in Pennsylvania.

As digital radio plants deeper roots over the next two years and new studios are built for multiple station operations in one facility, the need for pristine, noiseless audio and high-isolation studios will increase. It will be interesting to see how the radio industry embraces new construction products such as the Troy Wall.

For information, contact Troy Sound Walls, an E.R. Don Cerritos Company, in California at (800) 987-3306.

NIL. ZIP.

BE No More, No Less.

Products & Services Showcase

For more information on the products shown below, circle the appropriate Reader Service No.(s) on the enclosed Subscription/Reader Service card or contact the advertiser directly.



Excaltibur Electronics

CDA-1

Composite Distribution Amplifier



This 1 in, 3 out distribution amplifier allows you to distribute stereo composite and/or subcarrier signals as easily as audio.

- ◆ DC-100 kHz frequency response
- ◆ 90 dB signal/noise ratio
- ◆ +6 dB to -20 dB gain range
- ◆ Individual 20-turn output trimmers
- ◆ 1 3/4" rack mount enclosure

EXCALIBUR ELECTRONICS, INC., CHANTILLY, VIRGINIA
Please circle our bingo number for a data sheet and a dealer list.

READER SERVICE NO. 92

RemoteAmp

Headphone/Earpiece Amplifier



1/4" 8 ohm Headphone Jack
1/8" 150 ohm Earpiece Jack

Battery Test Indicator
Easy Change Battery Door

\$215.00

JK Audio

Remote Broadcast Gear

Call 800 JK AUDIO (800-552-8346)
815-786-2929 • Fax: 815-786-8502
www.kaudio.com

READER SERVICE NO. 19

Solid State, FM Broadcast

POWER AMPLIFIERS

TO 1200W



P.A. Modules

50W, 150W, 300W, 500W, 700W
In stock for immediate delivery
Repair service available, MMD, AMT modules



Silicon Valley POWER

AMPLIFIERS

The RF People
115 Phelan Ave., Unit 10, San Jose, CA 95112
1-800-986-9700 or Fax 1-408-986-1438
www.svpa.com e-mail: sales@svpa.com

READER SERVICE NO. 43



Econco

REBUILT POWER TUBES



Approximately One Half the Cost of New
3,000 Hour Unconditional Guarantee
Call for Our Price List

Econco 1318 Commerce Ave. Woodland, CA 95695
Phone: 916-662-7553 Fax: 916-666-7760 Telex: 176756
Toll Free: 800-532-6626 From Canada: 800-848-8841

READER SERVICE NO. 67

Eliminate Static Electricity

with the **Gila-Stat**

15 Years of Success



The **Gila-Stat** is designed to reduce lightning damage by lowering the likelihood of a direct lightning strike to:

- Buildings
- Communication Towers
- Electric Utility Substations
- Industrial Facilities

nott ltd.
3801 La Plata Hwy
Farmington, NM 87401
phone 505-327-5646 fax 505-325-1142

READER SERVICE NO. 91

Look At Systems Design With A Fresh New Perspective & Limitless Tools



RDL

Radio Design Labs

Specialists In Practical Precision Engineering

USA Phone (800) 281-2683 Europe Phone (+31) 20-6238 983
USA Fax (805) 684-9316 Europe Fax (+31) 20-6225 287
Internet Access: www.rdinet.com

READER SERVICE NO. 18

The Right Radio Tools!

Lesser products limit your station's sound by their poor performance and RF susceptibility: rock solid Benchmark interfaces have performance way beyond the limits of 16-bit digital!



- The Audio World Interface™ - Recorder Interface/Line Amp
- The Junior Audio Director™ - Stereo Mode Controller
- The Junior Audio Director™ Plus - 8 Channel Mode Controller

The Audio World Interface™ is a two-way recorder interface that is switchable to a line amp or a mono mix amp. The balanced inputs and electronic transformer outputs both have front panel recessed gain controls. The rack mountable chassis includes LEDs to indicate signal overload, switch position, and power presence.

Use it to mate R-DAT and analog recorders, to generate Mono from Stereo, or as a balanced line amplifier to compensate for level mismatches. Superlative performance, versatile operation, and an incredibly low price, make choosing the Audio World Interface™ a no-brainer!



...the measure of excellence!™

BENCHMARK MEDIA SYSTEMS, INC.
http://www.benchmarkmedia.com Phone 800-262-4675 • 315-437-8119

READER SERVICE NO. 115

Attention Manufacturers!

Is your company or product featured in our pages? Distribute extra copies of Radio World articles to your customers with Radio World's reprint service.



For rates and more information, call Giselle Hirtenfeld at

800-336-3045

extension 159

Plug Into Some Noise Reduction

► **PLUG-IN**, continued from page 47

had to select a portion of a sound file to test the SFNRP settings on and then wait while the program created a preview. It worked fine, but could get time-consuming when you were working on a particularly troublesome sound file.

The new version of SFNRP runs all previews in real time. The most obvious benefit is that everything runs much faster. You can now know immediately how your SFNRP setting is affecting the noise and the sound itself.

Perhaps the most important benefit of real-time programming is the ability to more precisely tailor the noise reduction tool to your particular need. For example, the Noise Reduction plug-in contains seven different adjustable parameters — some with up to 100 different settings.

Time out

With the previous versions, it could have taken several hours or even longer to try each possible combination of parameters, as it was necessary to wait for the program to build a preview after each change. Now each of the parameters can be adjusted as the sound file plays and the effect is immediately noticeable. This results in maximum noise removal with little or no remaining artifacts.

In addition, it is now possible to test the SFNRP settings on as much of the sound file as you like. Because of the time necessary to build a preview in previous versions, it was impractical to test the SFNRP preview on more than five or 10 seconds of the sound file.

The problem is that both the nature of the source sound and the noise can change. What could sound perfectly fine at the beginning of a recording may sound terrible a minute or two later if the source or background noise were to change. Even a dramatic reduction in the volume of the source sound can affect how the SFNRP settings will affect the recording.

Labor saver

The new version of SFNRP makes it easy to preview as much of the sound file as desired and to continue tweaking the parameters as this is done. In the past, I would have had to go back and redo all of my work as the nature of the noise changed but my original settings were still applied to the entire sound file. This has saved me a great deal of work and makes the DirectX version a solid addition to the Sound Forge arsenal.

Real-time previewing also redeems the Click Removal tool. SFNRP actually has two click removal tools: a stand-alone version and a second version incorporated into the Vinyl Restoration plug-in. The click removal tool in the Vinyl Restoration module has become a valued weapon for me; I have never found much use for the stand-alone plug-in.

When you can adjust the parameters of the click removal tool over a larger portion of the sound file in real time, you can set it so that it does a useful job of removing pops and clicks without adding echoes and artifacts. The added benefit is being able to hear

the Preview right away and not wait until the file is massaged.

needs to be “un-noised”; the Sound Forge DirectX Noise Reduction Plug-In

SFNRP makes it easy to preview as much of the sound file as desired and to continue tweaking the parameters.

Sonic Foundry has done a good job of improving an already fine tool. There is a lot of vinyl left out there that

will provide an effective way of dealing with both transient and constant sources of noise.

SFNRP will run under Windows 3.x on a 486 processor, but Windows 95 or NT is recommended along with 16 MB or more RAM. My tests were on a Pentium 100 with 16 MB and a Pentium 166 with 32 MB, both using Windows 95. I had no problem previewing any of the functions in real time on either computer.

The DirectX Noise Reduction Module comes on a CD, requires Sound Forge 4.0c to function and is available for a suggested price of \$349. Upgrades from previous versions are available for \$99.

Call Sonic Foundry in Wisconsin at (800) 57-SONIC or circle Reader Service 51.

■■■

Read Burgan is a freelance writer and former public radio station manager.

ABSOLUTELY NOTHING.

Nothing at all.



Exactly what our new DSTL does to your audio. **Absolutely nothing.** The new digital DSTL featuring the Dolby® AC-2 Digital Audio System. So robust that if it's not the best sounding STL you've ever heard, we'll take it back, no questions asked.

Its digital audio coding and modulation schemes assure that your audio comes out exactly the way it went in. For more information, contact Broadcast Electronics at 1-800-4STL-RPU or at www.bdcast.com/dstl.

Isn't it time you invested in something that does absolutely nothing?



BE[®] BROADCAST ELECTRONICS, INC.

THE WORLD'S RADIO COMPANY

4100 N. 24th Street/P.O. Box 3606/Quincy, IL 62305-3606/(217)224-9600/Fax: (217)224-9607
Internet: <http://www.bdcast.com> • E-Mail: bdcast@bdcast.com

Dolby® and AC-2® Audio System are trademarks of Dolby Laboratories.

© 1997 Broadcast Electronics

Test drive theirs then test drive our DigiCart®/II Plus.



We've got more under the hood.

In fact, a lot more. We've just added a built-in Zip™ drive and D-NET file transfer network.

You'd think all that would add to the cost of the unit.

Not so. The price of DigiCart/II Plus is the lowest it has ever been. And, it's still got the reliable features you've come to expect from DigiCart recorders. It stores almost

50 hours of audio on hard disk, provides instant access to thousands of cuts, and has your choice of Dolby® AC-2 *Drive it Hard* or true 16-bit linear recording.

We invite you to take it out for a test drive and make the comparison.

We're that sure that after you test drive it, you'll want to park it at your place.



Attention call letter stations.* You're only a phone call away from a free 10-day Test Drive.

So try it out. We'll understand if you don't give it back.

(818) 991-0360

360 Systems®

PROFESSIONAL DIGITAL AUDIO

For more information call (818) 991-0360 / Fax (818) 991-1360 / e-mail: info@360systems.com / Website: www.360systems.com

*Offer good in U.S. and Canada only.
© 1997-360 Systems

Circle (39) On Reader Service Card
World Radio History

DIGITAL DOMAIN

Interactive Radio: On the Way?

Mel Lambert

A wit once remarked that radio with pictures was television. I disagree.

Radio with interactivity, courtesy of the Internet — in whatever format that may take — could rekindle interest in what some observers are concluding is a moribund industry.

With so many alternatives vying for our attention and our hard-earned dollar, and perhaps due to a lack of imagination upon the part of too many program directors, radio needs to offer more than droning voices and tightly formatted music wheels.

What I have in mind is something that can take advantage of current 14.4 and 28.8 kbaud modem technology and will run nicely on the enhanced bandwidth of the new web cable services being offered in major urban areas. Using hardware and software already in place, listeners can provide themselves with a level of real interactivity with on-air talent. This might be just what the doctor ordered.

Enlightened thinking

Just what has sparked my imagination into considering these and other possibilities? A few days spent at the recent TeleCon XVII Conference in Anaheim, Calif.

During this trip, a number of organizations spotlighted the use of LANs, WANs, ISDN, T1 and the Internet to provide teleconferencing, telemedicine, remote learning and related services. The accompanying technical exhibition also provided a fascinating glimpse into state-of-the-art conferencing systems, interactive website development and other emergent technologies.

I would be the first to admit that, for many reasons, radio is a monodirectional medium. We simply absorb the information, with little need for any degree of involvement. For people living alone, the radio is a primary form of communication while they are active with other chores around the house. For listeners on the move, radio provides virtually instant access to information that can offer alternate routes around traffic congestion.

But I would suggest it is time that radio evolve into a more appropriate medium for the 21st century; one that involves an enhanced degree of bidirectionality. It is high time that we listened to what the audience has to say in a more interactive way.

The one major advantage that radio has over other media is that it is highly cost-effective, with operational budgets at a fraction of what television or cable would cost. But to remain in the forefront, radio needs to consider ways of augmenting its appeal.

For music-based stations, it could be possible to institute programming that utilizes a website to provide additional data about the current playlist or — a bold move — to enable listeners to develop lists of their own favorite songs for the targeted era or musical genre. With data-gathering screens and companion-analysis software, it would be relatively easy to refine a current playlist to accommodate an enhanced degree of audience participation.

For news and talk formats, the possibilities are more exciting. Imagine websites that provide edited highlights of current news stories with much greater detail than a tightly segmented, rolling-news format would allow. You would be one

click away from background material on ongoing developments.

Taking the technology a stage further, information requested over the air could be made available via an on-line service or even a low-cost BBS (Bulletin Board Service). Surveys of listener opinion could be conducted with an accelerated turnaround time simply by inviting listeners to complete basic forms that would gather comments and opinions on a variety of subjects.

In many ways, what radio audiences lack is a sense of involvement. For many of them, that is just fine. All they want is something familiar and predictable at the touch of a dial. But I suspect that, for a growing number of people, in numbers that could transcend age and cultural differences, listeners may be looking for more. Ancillary services such as those available via the Internet or related information networks might delay the inevitable.

It is time for alternatives to the conventional passive appeal of the majority of radio outlets. We have access to an exciting spectrum of interactive data channels,

many of which already are installed or will be added to listeners' homes across the country soon.

Our industry runs the risk of being eclipsed by alternate means of communications and should come to terms with the increasing number of ancillary services that we should be offering *now* rather than later.

A number of stations around the country may have implemented such schemes. Even though I am active on the Internet and make extensive use of a variety of search engines, I may be unaware of what some notable stations are doing in the way of interactive programming. If your station is doing something revolutionary in this respect, drop a message to mediapr@earthlink.net

If the reaction is as I predict, I will return with a follow-up overview in a future column.

■ ■ ■

Mel Lambert is principal of Media&Marketing in Los Angeles. Reach him at mediapr@earthlink.net or (818) 753-9510.

Fender Passport a Pleaser

► FENDER, continued from page 47
Kids-R-Us grand opening and five 'Breakfast with Bonnie' Silver Diner appearances throughout the metro area. We gave it a real test drive."

At the Silver Diner appearances, the Passport's speakers were placed on stands. Each

We really liked the ability to adjust all the levels on simple, color-coded knobs.



— Marcos Davila

speaker comes with an integral stand adapter. Stands are optional equipment and it is likely your station already has a couple for the remote P.A. gear you now use.

The Passport is user-friendly, too. "We really liked the ability to adjust all the levels on simple, color-coded knobs," said Davila.

The Fender Passport eliminates the need for a "true engineer" to attend live appearance remotes on a mandatory basis, giving both the promotions and engineering departments a bit more freedom and flexibility with their day-to-day interaction.

Product Capsule:
Fender Passport P.A. System

 <p>Thumbs Up</p> <ul style="list-style-type: none"> ✓ User-Friendly control ✓ Quick set-up ✓ Compact for storage/transport 	 <p>Thumbs Down</p> <ul style="list-style-type: none"> ✓ Mic cables plug into the front (visually weird)
--	---

For more information call Fender Musical Instruments in Arizona at (602) 596-9690, or circle **Reader Service 27**.

"Fifteen remotes in 30 days is not uncommon for Oldies 100," Georges said. "I guess you can see why we don't want you to take this thing back."

The Fender Passport self-contained P.A. system retails for about \$900. Fender Pro Audio is at 7975 North Hayden Street, Scottsdale, AZ, 85258.

■ ■ ■

Flip Michaels is production director for classical-formatted WGMS(FM), sister station to WBIG(FM) in Washington. His most recent article for RW was on repetitive stress injury from radio production equipment.

STATION/STUDIO SERVICES

Radio Station Data Base

Only \$149!

Addresses, Formats, Phone, FAX
Market Size, Ratings & More!

Also: Group mailing to
GMs, PDs, SMs & CEs.

The Radio Mall
1-888-97-RADIO

TOLL FREE

READER SERVICE 42

630
Sound Effects
on CD - \$99

60 day money-back
guarantee! Call Ghostwriters
at 612-522-6256 or write to:

Ghostwriters
2412 Unity Ave N., Dept RW,
Minneapolis, MN 55422

For complete track listings, go to
web site: <http://radio-mall.com>

READER SERVICE 66

Instant Access Music

- 3 Volume CD Set
- Ideal for Commercial Broadcast
- 60-30-15 Second Cuts
- Buy Out Royalty Free
- Total of 159 Cuts!!
- All Digital

Call us at:
309-342-6721

Hear a Telephone Demo
Demo Line
801-343-0345

All 3 CDs for the
One Time Buy
Out of \$120.00

READER SERVICE 114

BUY-OUT MUSIC — \$49

82 :30 & :60 music beds for ... \$49

328 :30 & :60 music beds for ... \$198

120 production effects "Zings, Zaps
and Zoodads" for ... \$99

122 New Lasers & Sweepers for ... \$99

For FREE DETAILS on
production music, sound
effects, call

.....
Ghostwriters (612) 522-6256

READER SERVICE 66

1012 hit songs from 1980-1995
1229 hit songs from 1954-1969

545 hit songs from the 70's
819 Kickin' Country Hits

on CD for Only \$499 each
(per set plus shipping)

For complete track listings
NOW go to web site:

<http://radio-mall.com> or
Email: radiomall@aol.com or

Phone or FAX Ghostwriters at
612-559-6524

For radio broadcast only!
READER SERVICE 90

Are you reading
someone else's
copy of Radio World?

If so why not apply for your
personal free subscription?

Simply complete the
subscription card & return
it to us! You'll never have
to risk missing an issue of

Radio World

ATTENTION PROVIDERS!

Promote your services to **Radio World's** 18,000+ readers. Reach Radio Station and Recording Studio owners/managers and engineers with your message. For information on affordable advertising call **Simone** at **1-800-336-3045, extension 154**.

PRODUCT GUIDE

Companies with new product announcements for Studio Sessions Product Guide should send them to:
Radio World, c/o Studio Sessions Editor, P.O. Box 1214, Falls Church, VA. 22041

Sony Oxford Digital Console

The new Sony OXF-R3 Oxford console is a digital mixer designed for high-end audio for broadcast, film and video. With built-in multichannel capability, it is ready for DVD production as well.

Separate panels for dialing in dynamics control, EQ and input channel inserts eliminate the need for multi-level menuing on common controls. All settings are shown on a series of backlit display screens.

Combinations of rotary encoders, linear faders and buttons offer control over the Oxford's functions.

Automation and machine control is

provided through a Session Management panel. Four machines can be controlled at one time through this panel. A Multi-format panel allows the setting of surround-sound formats of up to eight channels. Once set, all console functions, including

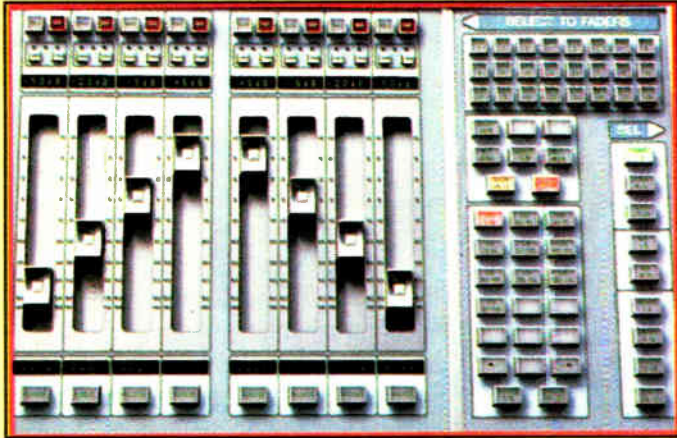

panning and routing, follow the format.

For information, contact Sony in New Jersey at (201) 930-1000 or circle Reader Service 123.

Shure New Generation EQ

Shure Brothers Inc. has updated its computerized DFR11 EQ with version 4 software. The new software expands the capabilities of the two-in-one EQ and feedback reducer.

Via PC, a user can select either a 30-band constant-Q graphic or 10-band parametric EQ, each with graphic displays showing frequency response and adjacent filter interaction. The EQ interface comes with XLR and quarter-inch inputs and outputs.

The DFR11 features a 24-bit signal path, 20-bit A/D and D/A converters and 48 kHz sample rate. List price for the DFR11 EQ is \$735, including version 4 software and the EQ interface.

For information, contact Shure Brothers in Illinois at (847) 866-2200 or circle Reader Service 99.

TC Electronic PurePitch Software

Users of the TC Electronic M5000 Digital Audio Mainframe can now perform formant-preserving pitch-shifting with PurePitch processing software.

PurePitch can shift the pitch of the human voice up or down, while leaving the formants (harmonic structure) of the voice intact. This allows radical pitch changes to occur in real time without "chipmunking" or "DarthVadering."

PurePitch requires an included memory expansion upgrade that is user-installable in the M5000.

For information, contact TC Electronic in California at (805) 373-1828 or circle Reader Service 147.

Spacewise CD Rack

Spacewise Broadcast Furniture has a new lineup of CD racks for studio use.

Shown is the rotating CD Susan that holds 80 compact discs and their

plastic shells, either jewel cases or Denon-style CD caddies.



Two wall-mount racks are made to hold 100 or 200 CDs respectively. All CD products are made from solid oak.

For information, contact Spacewise Broadcast Furniture in Arizona at (800) 775-3660 or circle Reader Service 171.

Hyperprism Effects for PC Platform

Arboretum Systems has moved its Hyperprism effects software package over to the Windows platform with Hyperprism-DX.



The package works with all Microsoft Direct-X or Active Movie-compatible audio applications, including Cool Edit Pro, Sound Forge, Cakewalk Pro Audio and others. Effects include pitch change, ring modulation, reverb, dynamics,

flanging and others.

Simple on-screen faders offer control over all parameters, or values can be mapped to the "Blue Window" interface which expresses each setting on an X and Y axis. A Pentium computer is necessary to run Hyperprism-DX.

Suggested price is \$389.

For information, contact Arboretum Systems in California at (415) 626-4440 or circle Reader Service 219.

Allen & Heath Mixer

The Allen & Heath DR12:8 digital mixer combines an entire console's functions and puts it into a 2RU enclosure.

Designed for contractor installation, the DR12:8 is suitable for mixing speech, music and satellite broadcast audio to multiple zones.

Infinite parameters and configurations can be saved on the unit's 16 internal memory locations or stored to disk.



The DR12:8 is a 12-in/8-out cross-point matrix mixer with comprehensive mixing, ducking, panning and compressing capabilities. All control is performed through 12 user-definable soft keys and an LED screen on the front panel.

For information, contact Allen & Heath in Utah at (801) 568-7660 or circle Reader Service 28.

MOTU Products for Production

Mark of the Unicorn (MOTU) features two products for MIDI music production and synchronization of digital audio equipment.

FreeStyle 2.0 is a sequencing program for Mac computers that can record, edit and print MIDI music. Color screens and a "piano roll" window allow easy viewing and editing of a recording.

FreeStyle also transmits MIDI Time Code (MTC) for synchronizing to external equipment.

The MOTU Digital Timepiece is a synchronizing hub that links all digital equipment in a studio, locking them all to a stable timebase. It is capable of connecting and synchronizing ADAT, DA-88, ProTools, video decks and computers. The Digital Timepiece

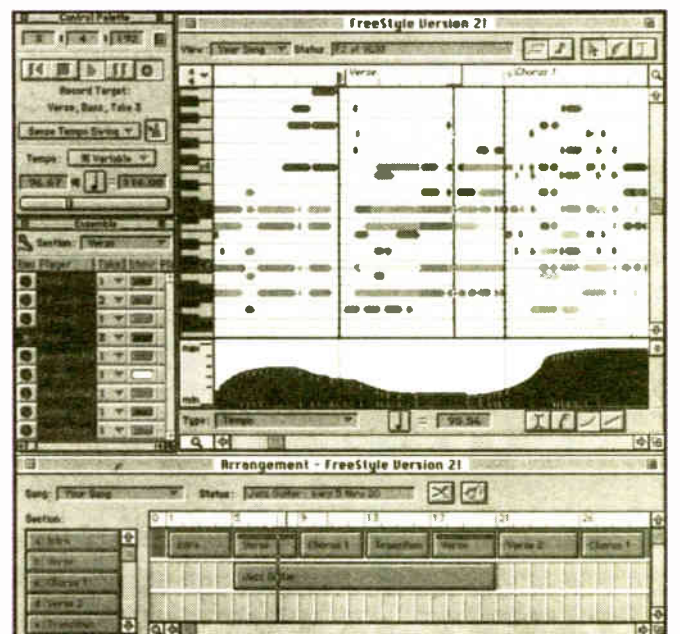

DigiTech Talker

The DigiTech Talker is a self-contained "stomp box" processor designed to impress vocal characteristics onto sounds, creating talking music tracks and special vocal effects. The resulting sound is similar to recordings done by Electric Light Orchestra or Peter Frampton.



Building on vocoder concepts realized decades ago, the Talker uses new circuitry and a process DigiTech calls Advanced Vocal Synthesis. The new process is the result of research into physical modeling of the human voice.

Six presets are available on the Talker, accessed through the footswitch button in the lower left corner of the chassis surface. Three rotary controls regulate input and output levels.

The back panel is equipped with both XLR and quarter-inch inputs and outputs. The mic input includes a switchable pad to accommodate varying levels. LEDs indicate the selected program, level clipping and bypass.

The DigiTech Talker has a suggested price of \$299.95.

For information, contact DigiTech in Utah at (801) 566-8800 or circle Reader Service 124.

supports S/PDIF, all SMPTE formats and word clock, as well as third-party formats such as Digidesign's 256x "superclock."

A nine-pin Sony machine control port allows the Digital Timepiece to lock a nine-pin-compatible video deck to all other equipment.

For information, contact Mark of the Unicorn in Massachusetts at (617) 576-2760 or circle Reader Service 195.

Radio World

Broadcast Equipment Exchange

"Broadcast Equipment Exchange" accepts no responsibility for the condition of the equipment listed or for the specifics of transactions made between buyers and sellers.

ACOUSTICS

Want to Sell

ACOUSTIC FOAM

Sound Barrier · Diffusers · Bass Traps & More!

- ★ Consistent Pattern....No Innies & Outies
- ★ Long-Lasting....Won't Crumble!
- ★ 1, 2, 3, 4 & 12" Thicknesses
- ★ 10 Vivid Colors In 2 Styles
- ★ Super Flame Retardant
- ★ 60% Better Absorption
- ★ Best Value By Far!

Call for a FREE Sample Kit, visit our website or ask for Auralex products by name at your favorite broadcast supplier.

Users: ABC Radio Network · NPR · James Taylor · Clint Black · Christopher Cross · Doane Perry (Jethro Tull) · Dennis DeYoung · James Young · Todd Sucherman (Styx) · Mike Wanchic (J. Mellencamp) · Ross Vannelli · George Terry (Eric Clapton) · SkidRow · Mark Lindsay (P. Dinklage & the Raiders) · John Baxter (Re-Flex) · Berklee College Of Music · JBL · Walt Disney Co. · LucasArts · Pat Duke (Voice of McDonalds & Miller Brewing) · Dick Ervasti (Voice of Sports on Fox) · MSNBC · NBC Sports · CBS Sports · ABC TV · Polygram · Sear Sound, NYC · AT&T · NASA · Sony · Shure · Ford · Show Co · Kodak · Mormon Church TV · Warner Bros · 20th Century Fox · Universal Studios · Murray Polich Show · Ensoniq · The Lincoln Center · Hitachi · KG Royals · General Dynamics · Toshiba · Hunter Fan Co. · Baldwin · Adaptec · Paramount · Rockwell · US Gov't · Oryland · Fruit of the Loom Country Comfort Tour · Carvin · WhisperRoom · Martin Marietta · Manley Audio Labs · Rainbow America (Disney, Microsoft) · Pelonis Acoustics · Macromedia · Plus People Who Do Work For: ABC News/Sports, Fox TV, NBC News, ESPN, Late Show With D. Letterman, Cellular One, Texas Instruments, Stevie Nicks, Kurzwelt, Turner Broadcasting, Wal-Mart, Coke, Taco Bell, Levis, Mattel, Apple Records, TUP, etc. Shouldn't You Join 'Em?

Auralex
ACOUSTICS

11571 East 126th Street, Fishers IN 46038 • Voice 317-842-2600
Fax 317-842-2760 • Toll Free Order Line 1-800-95-WEDGE
Website: www.auralex.com • E-Mail: auralex@auralex.com

Circle (234) On Reader Service Card

AMPLIFIERS

Want to Sell

Crown D150 amplifier, excel cond, \$300. D Kocher, Digital Sound Makers, 1919 Hanover Ave, Allentown PA 18103. 610-776-1455.

FM amplifier, 60W, excel cond, \$1500/BO. L Brent Oliphant, KMXE, POB 1678, Red Lodge MT 59068. 406-446-1199.

Fostex PH-5 headphone amp, excel cond, \$95; Rolls RA62HA headphone amp, perfect, \$80. J Coursolle, WPKR 2401 W Waukau Ave, Oshkosh WI 54903. 920-236-4242.

Fostex PH-5 headphone amp, excel cond, \$95; Rolls RA62HA headphone amp, perfect, \$80. J Coursolle, WPKR 2401 W Waukau Ave, Oshkosh WI 54903. 920-236-4242.

Fostex PH-5 headphone amp, excel cond, \$95; Rolls RA62HA headphone amp, perfect, \$80. J Coursolle, WPKR 2401 W Waukau Ave, Oshkosh WI 54903. 920-236-4242.

Fostex PH-5 headphone amp, excel cond, \$95; Rolls RA62HA headphone amp, perfect, \$80. J Coursolle, WPKR 2401 W Waukau Ave, Oshkosh WI 54903. 920-236-4242.

Gates M6244 phono preamp, \$20; Sparta TEP 35 phono preamp, \$10. E Swanson, WPKR, POB 3450, Oshkosh WI 54903. 920-236-4243.

McIntosh stereo pwr amps (6), mint cond, in dbl rack mounts, sold in pairs or all, \$1100 ea +shpg; (3) dbl amp racks w/spk inputs & audio

outputs built into rear rack w/cooling fans, \$100 ea. F Baranowski, 25-27 Lee St, Johnston RI 02919. 401-274-1999.

Spectro Acoustics 200W audio power amps, \$200/BO. L Brent Oliphant, KMXE, POB 1678, Red Lodge MT 59068. 406-446-1199.

Kenwood KA-5700 stereo amp & loudspeaker system w/(4) Radio Shack Minimus-7 loudspeakers w/mounting brackets & speaker cables, complete system, \$265. R Streicher, Pacific A/V Enter, 545 Cloverleaf Way, Monrovia CA 91016. 626-359-8012.

Uher CV-140, high end, new in box, \$100. J Morinelli, Joe Morinelli Entertainment, 901 Fairfax Rd, Drexel Hill PA 19026. 610-715-1720.

ANTENNAS/ TOWERS/CABLES

Want to Sell

Allen Dick 6 bay, 99.5 MHz, 10 kW, \$400; RCA/Dielectric 6 bay, 99.3 MHz, 20 kW, \$1000. E Swanson, WPKR, POB 3450, Oshkosh WI 54903. 920-236-4243

S.W.R. FM Antennas

Great Antenna
Great Price!

HE HALL Electronics (804) 984-4255

ERI FMXH 3AE high pwr 3 bay rototiller antenna w/radomes, 1.5588 gain, tuned to 104.7 MHz, \$4900/BO. M Osborne, WKSQ, POB 9494, Ellsworth ME 04605. 207-667-7573.

ERI LP-6C 6 bay half wave spaced antenna, 12 kW input,

tuned to 99.1 MHz, \$4900/BO. M Osborne, WKSQ, POB 9494, Ellsworth ME 04605. 207-667-7573.

Shively 6810 5 bay high pwr antenna, tuned to 94.5 MHz, \$4900/BO. M Osborne, WKSQ, POB 9494, Ellsworth ME 04605. 207-667-7573.

3" HELIAX STANDARD COAXIAL CABLE

50-Ohm, unused, cut to length. Priced below market. Shipped instantly. Call Basic Wire & Cable (NANCY) 800-227-4292 FAX: 773-539-3500

Cablewave coax, 300' w/connectors, \$3000; Jampro 3 bay on 101.9, \$1500. S Yates, Yates Bldg, POB 1345, Lufkin TX 75902. 409-634-6661.

Coaxial cable, new, 121' 3", \$15/ft. J Lee, KGND, 410 E Illinois, Vinita OK 74301. 918-256-7224.

Our Short Hit List (Over 150 Additional Lines Available)

AIR CORP
ANDREW
ATI
AUDI-CORD
AUDIO-TECHNICA
AUTOGRAM
BBE SOUND
BELAR
BROADCAST TECH.
BURK
CABLEWAVE
CMBE INC.

COAXIAL DYNAMICS
CROWN
EAGLE HILL
ELECTRO-VOICE
ENERGY-ONIX
FIDELIPAC
GENTNER
GORMAN REDLICH
HNAT HINDES
INOVONICS
JAMPRO ANTENNA
MARK ANTENNA

MARTI
MIDDLE ATLANTIC
MOD. SCIENCES
MURPHY FURN.
MUSICAM USA
ORBAN
PSI INC
PHASETEK
RADIO DESIGN LAB
RADIO SYSTEMS
REGISTER DATA
SCALA

SHIVELY ANTENNAS
SHURE
SINE SYSTEMS
SONY
SWR
SYMETRIX
TANNOY
TASCAM
TEPCO
TFT
TTC
WEST PENN WIRE

Southeast - Bob Stewart

Phone: 770-992-2230
Fax: 770-992-6538
roscom@mindspring.com

MidAtlantic - Rick Johnson

Phone: 804-974-6635
Fax: 804-974-9942
rick@cstone.net

West - John Shideler

Phone: 970-482-9254
Fax: 970-482-6123
shideler@webaccess.net

Circle (233) On Reader Service Card

Tower, 500', 36" face, solid rod, hot dip galvanized, up to 110 mph wind zone, \$35K. M Barinowski, WLPE, 3213 Huxley, Augusta GA 30909. 706-733-1286.

Towers, 220' (2), 18" face, excel cond, recently removed from service, solid steel legs, can be stacked, some guy wires & hardware, FOB site, \$7500 ea or \$12500/both. Steve, WDEE, 101 S Higbee, Reed City MI 49677. 616-832-1500.

Want to Buy

AM tower, 190'. B Hearst, WWCH, Greenville Ave, Clarion PA 16214. 814-226-4500.

AUDIO PRODUCTION

Want to Sell

Advantage One 8 chnl bi amp mixer, \$375; Voice-Over

booth, \$950; audio rack mount patch bay, \$150. J Baltar, New Musik Directions, 67 Green St, Augusta ME 04330. 207-623-1941.

Digitech studio vocalist, new, \$500. D Kocher, Digital Sound Makers, 1919 Hanover Ave, Allentown PA 18103. 610-776-1455.

ESE up/down rack mounted timer, \$150. P Cibley, Cibley Music, 166 E 35th St, NUNY 10016. 212-532-2980.

Roland VS880 digital workstation w/VS8F-1 effects board, 540HD, mint, \$1495; Tascam DA30 MKII DAT, less than 50 hrs, \$775. M Buccia, The Michael Thomas Group, 407 Society Hill Blvd, Cherry Hill NJ 08003. 609-489-9866.

Studer 2706 monitor speakers, ported 3 way w/built-in protection, \$750/pr +shpg. M Halleck, KSTP, 2792 Maplewood Dr, Maplewood MN 55109. 612-481-9333.

Brand New from

APHEX

Sounds Great & IT'S LOUD!!!

FM Pro 2020
FM Audio Processor/
Stereo Generator
Digital Control,
set-up screen.

List From \$4,995

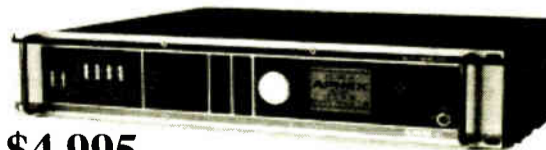

Call Now...Your HE Price is much Lower!

www.halls.com

Email sales@halls.com

706 Rose Hill Drive, Charlottesville, VA. 22901 (804) 984-HALL (4255) Fax: (804) 984-FAXX (3299)

HE HALL Electronics

Circle (232) On Reader Service Card

AUDIO PRODUCTION continued...

Texar/Gentner Audio Prism w/phase rotator card & manuals. J Bahr, POB 6556, San Juan PR 00914. 787-756-5914.

Yamaha BP-2 bass pedals in portable case, BO. B Meuse, Muse Audio Arts, 191 E El Camino Real #209, Mtn View CA 94040. 650-969-2433.

Advantage One 8 chnl bi-amp mixer, \$375; audio rack mount patch bay, \$150. J Baltar, New Musik Directions, 67 Green St, Augusta ME 04330. 207-623-1941.

Burwen TNE 7000A transient NR, \$140; KLH/Burwen DNF 1201A dynamic noise filter, \$140; SAE 5000A pop & click filter, \$150; Phase Linear 1000 NR system, \$100. P Combs, Only Son Prod, 2120 W Batman Dr, Dayton OH 43420. 937-253-1912.

Dolby 361 Type-A NR, 2 chnls, in sturdy road case, complete package, \$600; JBL 4612B Cabaret loudspeakers w/stands, steel stands fitted w/casters & adjust to 6' high, excel cond, sold as pair, \$750. R Streicher, Pacific A/V Enter, 545 Cloverleaf Way, Monrovia CA 91016. 626-359-8012.

ESE rack mount up/down timer, \$100. P Cibley, Cibley Music, 166 E 35th St, Nyny 10016. 212-532-2980.

Otari MX-5050 MKIII 4 trk r-r, excel cond, trade/BO; Otari

MX-5050 MKIII 8 trk r-r, excel cond, trade/BO. S Portier, Sinclair/WWL AM, 1450 Poydras St #440, New Orleans LA 70112. 504-593-2106.

Tannoy 15" speaker pair, newly recond, \$1450; vintage recond tube mic pre's & mixers, \$300-\$700; new ADC patch bays 1/4" 52 points, \$169; ADC TT bays, \$129 up; new ADC TT or 1/4" TRS cords, \$9; Furman 1/4" to 1/4" patchbays, \$95 ea; like new tape, 1/2"x2500' 456, \$15 ea; 1" 456, 226, 250, \$25 ea; Digitec 3.6 sec delay, \$150; new pwr dist/filter rack mt, \$75. W Gunn, Box 2902, Palm Springs CA 92262. 760-320-0728.

Want to Buy

Compressors & EQs, tube and solid state. W Gunn, Box 2902, Palm Springs CA 92262. 760-320-0728.

AUTOMATION EQUIPMENT

Want to Sell

Air Century automation controller, \$700. E Swanson, WPKR, POB 3450, Oshkosh WI 54903. 920-236-4243.

Schafer 800T automation controller, \$600/BO. J Bahr,

POB 6556, San Juan PR 00914. 787-756-5914.

Arrakis Digilink GEM-600 Gemini System w/1.2 gig + network board & software, w/cart wall; Arrakis TS-8C Trak Star workstation w/270 MG w/network board & software, units are 1 yr old, currently on air & working, \$8,500/BO. L Zeve, WHYL, Box WHYL, Carlisle PA 17013. 717-249-1717.

Smarts Bdct automation system including (2) Generation 2000 R/P audition unit; (2) Generation 2000 prod unit; (4) DA-4000-SCS; (4) Akai; (2) SC-45; SS-1; (2) SW-4; (2) MOD-2; traffic network SC-500-5; (4) Isobar power filter, call for details, \$60,000. E Swanson, WPKR, 2401 W Waukau Ave, Oshkosh WI 54903. 920-236-4242.

SMC 3050 Brain, 2 cabinets, limiter, clock, remote control, 2 random select w/random select racks, Carousels, manuals, gd cond, u-haul, \$500. C Jones, WMNY, 7620 Old #6, Santee SC 29142. 803-854-6396.

Want to Buy

McKay Dymek DA5, 6 or 9 directional rcvg antenna. J Hartt, Hartt Audio Transfers, 2418 36th Ave West, Seattle WA 98199. 206-282-0720.

CART MACHINES

Want to Sell

ITC triple deck, \$900; ITC Delta, \$875; (3) SMC 712, \$200 ea. E Swanson, WPKR, POB 3450, Oshkosh WI 54903. 920-236-4243.



Great Prices on original equipment tape heads for ITC, BE, Fidelipac, Otari, Tascam & others!

(804) 984-4255

ITC upgrade PB to record, amps only-no deck, 3 tone, stereo, \$175. W Gunn, Box 2902, Palm Springs CA 92262. 760-320-0728.

CD PLAYERS

Want to Sell

Denon 950 single PB, tracking module needs work, BO. J Randolph, New River Media, 604 N 3rd, Danville KY 40422. 606-236-9447.

Denon 950FA (3), \$500 ea; (18) Technics SL-PG-300, \$50 ea. E Swanson, WPKR, POB 3450, Oshkosh WI 54903. 920-236-4243.

COMPUTERS

Want to Sell

Computer Concepts DCS control room & prod room & server, assume payment. G Wilkes, KTBQ, 422 E Main #124, Nacogdoches TX 75961. 409-564-4559.

CONSOLES

Want to Sell

Howe 12 pots, \$1500. J Arzuaga, WLAZ, Curry Ford Rd, Orlando FL 32812. 787-895-0000.

Panasonic Ramsa WR8112 12 chnl mixing board w/road case, \$800 +shpg. F Baranowski, 25-27 Lee St, Johnston RI 02919. 401-274-1999.

Altec 1567A portable case, \$75. J Morinelli, Joe Morinelli Entertainment, 901 Fairfax Rd, Drexel Hill PA 19026. 610-715-1720.

Howe-Tech 20 chnl bdct console, \$600. S Portier, Sinclair/WWL AM, 1450 Poydras St #440, New Orleans LA 70112. 504-593-2106.

Ramko DC-5 5 chnl mono w/manual, \$100. M Koscak, WSKB, 605 Loomis St,

Westfield MA 01085. 413-562-1950.

Sparta RS-30 4 chnl stereo mixer, desk, 2 TT's, 2 pre-amps, 2 monitor speakers, cue speaker, mike, u-haul, \$500. C Jones, WMNY, 7620 Old #6, Santee SC 29142. 803-854-6396.

Spirit Live/4, 12x4x2 w/2 additional stereo inputs & 5 aux busses, custom modifications, excel cond, \$1150. R Streicher, Pacific A/V Enter, 545 Cloverleaf Way, Monrovia CA 91016. 626-359-8012.

Soundcraft 600 32x16 w/patchbay, mint, \$4950; Tascam 512 12x8 mixer, \$750; Tascam 520 20x8x16 mixer, \$1750; Tascam 30 8x4, \$450; Allen & Heath Syncon 28x24, great sounding, \$5000. W Gunn, Box 2902, Palm Springs CA 92262. 760-320-0728.

Want to Buy

RCA console modules, BA-71/72, BA-73, BA-74, BX-71 pwr supply. J Ballard, NBC, 30 Rockefeller Plaza Rm 1101W, Nyny 10112. 212-664-3033.

DISCO-PRO SOUND EQUIP

Want to Sell

Outdoor fiberglass 70V horns (22) w/xtra drivers, Columbia, EV & Corbraflex, \$1100 +shpg. F Baranowski, 25-27 Lee St, Johnston RI 02919. 401-274-1999.

CONSULTANTS



Consulting Communications Engineers

FCC Applications, Design, Field Engineering & Tower Detuning
Video/Data/Voice • Statewide Networks • Wide-Area Networks

EXPERTS IN:
TV • AM • FM • ITFS • MICROWAVE • PCS • FIBER

210 S. Main St., Thiensville, WI 53092 (414) 242-6000 FAX (414) 242-6045
Internet: <http://www.evansassoc.com> Member AFCCCE

Consulting Communications Engineers EMC Test Lab

- FCC Applications and Field Engineering
- Frequency Searches and Coordination
- AM-FM-CATV-ITFS-LPTV
- EMC Test Lab-FCC and European (IEC)

OWL ENGINEERING, INC.
E-mail: Owleng19@skypoint.com 1-800-797-1338 Fax (612) 785-4631
8899 Hastings St NE, Minneapolis, MN 55449 (612)785-4115 Member AFCCCE

MLJ

Moffet, Larson & Johnson, Inc.
Consulting Telecommunications Engineers

1110 North Glebe Rd, #800
Arlington, VA 22201

(703) 741-3500
FAX: (703) 741-0312

Member AFCCCE

PC - SOFTWARE

AM FM TV Search Programs
Signal Mapping—STL Paths
RFHAZ—US Census PopCount
FAA Tower—Draw Tower

Doug Vernier
Engineering Consultant
1600 Picturesque Drive
Cedar Falls IA 50613

800-743-DOUG

DON'T GAMBLE WITH YOUR ADVERTISING DOLLARS!



Advertise in Radio World and reach 18,000+ broadcast professionals.

Call Simone TODAY!

703-998-7600

FINANCIAL/LEASING SERVICES

FINANCING

LOANS BY PHONE
(800) 699-FLEX

- We finance all types of Broadcasting Equipment
- Flexible Credit Criteria
- Flexible Payment Plans
- No Down Payment, No Payments For 90-Days Available

To apply or request additional information call Jeff Wetter.

FLEX LEASE, Inc.

LIMITERS

Want to Sell

Optimod 8000 audio processor, excel cond, \$1200/BO. L Brent Oliphant, KMXE, POB 1678, Red Lodge MT 59068. 406-446-1199.

Orban 8000A stereo gen, \$1000; Microcon Flexmod composite processor, \$750; (2) Dorrrough 610 3 band processors, \$300 ea. E Swanson, WPKR, POB 3450, Oshkosh WI 54903. 920-236-4243.

Orban XT-2, 6 band limiter for the Orban 8100-A1 unit. J Bahr, POB 6556, San Juan PR 00914. 787-756-5914.

Modulation Sciences CP-803 composite clipper, rack-mount, like new, \$375. D

T. Z. Sawyer Technical Consultants

AM-FM-TV-LPTV

- FCC Applications & Exhibits
- Experimental Authorizations
- AM Directional Antennas
- High Power Antenna Arrays
- Frequency Studies
- Class Upgrades
- STL Applications
- Station Inspections

1-800-255-2632

FAX: (301) 913-5799 • 6204 Highland Dr. • Chevy Chase, MD 20815

MULLANEY ENGINEERING, INC.

Consulting Engineers
• Design & Optimization of AM Directional Arrays
• Analysis for New Allocation, Site Relocation, and Upgrades
• AM-FM TV LPTV Wireless Cable (MDS/MDS/ITFS/OFS)
• Environmental Radiation Analysis
• Field Work
• Expert Testimony
9049 Shady Grove Court
Gaithersburg, MD 20877
Phone: (301) 921-0115
Fax: (301) 590-9757
email: mullengr@aol.com

E. HAROLD MUNN, JR. & ASSOCIATES, INC.

Broadcast Engineering Consultants

AM - FM - TV

WAYNE S. REESE
PRESIDENT

Box 220, 100 Airport Rd.
Coldwater, MI 49036

517-278-7339

GRAHAM BROCK, INC.

BROADCAST TECHNICAL CONSULTANTS
Full Service From Allocation to Operation AM/FM/TV/AUX Services:
Field Work; Antenna and Facilities Design

Over 35 years engineering and consulting experience

912-638-8028
202-393-5133

www.grahambrock.com

R. MORGAN BURROW, P.E. & ASSOCIATES, P.C.

ALLOCATION STUDIES
(AM, FM, TV, LPTV)
New facilities, site relocation, FM upgrade, duplex
FIELD WORK A SPECIALTY
• AM Directional • FM & TV field intensity antenna adjustment, measurement & proof • Facility inspections for purchase/insurance purposes
• RADHAZ measurements - RADiation HAZard evaluation • CATV Leakage Testing

ELECTROACOUSTICS
OSHA measurements
301-948-3844 • Fax 301-330-5565

C.P. CROSSNO & ASSOCIATES

CONSULTING ENGINEERS

P.O. BOX 180312
DALLAS, TX 75218

AM, FM & TV Broadcasting

ANTENNA DESIGN, ALLOCATIONS, FCC/FAA

CHARLES PAUL CROSSNO, P.E.

(214) 321-9140 MEMBER AFCCCE

COMPLETE TURNKEY CONSTRUCTION

ANTENNA & LINE TESTING
AM DIRECTIONAL FIELD WORK
AM & FM APPLICATIONS
TOWER SERVICES
STUDIO DESIGNS
CUSTOM STUDIO FURNITURE

SYSTEM ONE COMMUNICATIONS

888-625-5649



Web Access
RF Engineering Tools

CDS OnLine is the first Web-based RF Engineering System providing remote access to a host of FCC, FAA, USGS, and US Census databases. CDS OnLine offers a familiar look and feel to web users, instant graphical output, comprehensive help, and accessible technical assistance.

Up-to-date Databases.
No hidden or automatic charges.

Communications Data Services
800-441-0034

- DTV Study
- Master Frequency File Search
- FM Study
- Population Count
- Terrain Averages
- Within Study
- Terrain Profile
- Contours

www.commdata.com

LIMITERS continued...

Kiker, WCOA, Box 12487, Pensacola FL 32573. 850-477-8500.

Orban 8100A, \$2500. WC Florian, WNIB, 1140 W Erie, Chicago IL 60622. 312-633-9700.

Want to Buy

Orban 8100 AXT2 panel to add to our FM 8100 Optimod. A Sutton, WCRS, POB 1247, Greenwood SC 29648. 864-223-8553.

Teletronix LA-2A's, UREI LA-3A's & LA-4's, Fairchild 660's & 670's, any Pultec EQ's & any other old tube compressor/limiters, call after 3PM CST, 972-271-7625.

MICROPHONES

Want to Sell

AKG M17A shock mount for 414 Series (2), \$150 ea. P Cibley, Cibley Music, 166 E 35th St, Nyny 10016. 212-532-2980.

EV RW20, perfect, \$295; **EV 309A** mic shockmount, perfect, \$65; **Telex V220** sports-caster headset w/cord, XLR plug, excel, \$145; **OC White M2MDUR** mic arm/R, excel cond, \$65; **Symetrix 528E** mic processor, perfect, \$285. J Coursolle, WPKR, 2401 W Waukau Ave, Oshkosh WI 54903. 920-236-4242.

Neumann U87A, \$1500. J Arzuaga, WLAZ, Curry Ford Rd, Orlando FL 32812. 787-895-0000.

RCA BK53, \$50; (2) Mike crane light duty, \$20 ea. E

Swanson, WPKR, POB 3450, Oshkosh WI 54903. 920-236-4243.

Shure SM59, \$125; **Sennheiser ECM 10**, \$120; **EV 635A**, \$140. J Baltar, New Musik Directions, 67 Green St, Augusta ME 04330. 207-623-1941.

Sony ECM 377 condenser w/papers, mint cond, \$450. D Kocher, Digital Sound Makers, 1919 Hanover Ave, Allentown PA 18103. 610-776-1455.

Countryman TVH tie-clip mic, requires phantom pwr, \$165; **AKG D-140** dynamic cardioid mics (3), \$100 ea. R Streicher, Pacific A/V Enter, 545 Cloverleaf Way, Monrovia CA 91016. 626-359-8012.

EV CO-90 (5) condenser mics, \$1.25 +shpg; (2) **Sony ECM-50** condenser mics, \$25 +shpg; **Sennheiser MKE-2**, great cond, \$75 +shpg; (2) **Sennheiser MD-421**, new in box, \$300 +shpg. J Swafford, P.S. Audio, 2810 W Co Farm, Springfield TN 37172. 615-384-4121.

Midland 13-601 mic level controller, solid state, never used, \$50. J Morinelli, Joe Morinelli Entertainment, 901 Fairfax Rd, Drexel Hill PA 19026. 610-715-1720.

Shure SM59, \$125; **Sennheiser ECM 10**, \$120; **EV 635A**, \$140. J Baltar, New Musik Directions, 67 Green St, Augusta ME 04330. 207-623-1941.

RCA 77DX, BK1A, \$395; vintage PA mics, **Shure 51 Elvis**, \$75, **EV731**, \$95, **EV 630** or **635**, \$75, **RCA mini 77** shaped, \$295. W Gunn, Box

2902, Palm Springs CA 92262. 760-320-0728.

Want to Buy

Broken E-V RE-20/PL-20 mics for parts. D Rumble, Toursound, 2918 N 47th Dr, Phoenix AZ 85031. 602-272-4724.

Neumann, Sennheiser, AKG, many models. W Gunn, Box 2902, Palm Springs CA 92262. 760-320-0728.

RCA 77-DX's & 44-BX's, any other RCA ribbon mics, on-air lights, call after 3PM CST, 972-271-7625.

RCA 77-DX's, 44-BX's, WE KU-3A's On-Air lights, recording lights. Top price paid. Fast response. Bill Bryant Mgmt, 2601 Hillsboro Rd, G12, Nashville TN 37212. 615-269-6131, FAX: 615-292-3434.

MISCELLANEOUS

Want to Sell

ROTRON BLOWERS AND PLATE BLOCKERS, new & rebuilt for Elcom, Harris, CCA, CSI, McMartin, Goodrich Ent, 11435 Manderson St, Omaha, NE 68164 402 493 1886 FAX 402 493 6821

Andrew 78ARF female connector for Andrew 3" Helix cable w/new hardware & re-attachment kit, gd cond, \$125. D Payne, WZPL, 9245 N Meridian St #300, Indianapolis IN 46260. 317-816-4000.

David Clark H7041 behind the head style headset w/boom mic, new in box, \$100. P Russell, Boudoin College, Sills Hall, Brunswick ME 04011. 207-725-3066.

Devry electronics training course, 11 vol w/test equipment, \$700/BO. R Chrystafis, C&M Comm, 809-1/2 Mulberry St, #1, Williamson WV 25661. 304-235-2292.

Eventide BD500, perfect, \$1795; **ESE ES185** GPS/master clock, perfect, \$1575; **ESE ES161A** slave clock, perfect, \$140; **ESE ES166A** slave clock, perfect, \$198; **Gentner TS612** 6 line/exp, w/screenware pkg, excel, \$2000; **Gentner TS 612** network interface, excel, \$275; **Gentner TS612** control surface, excel, \$275; **Telos One 120-1** hybrid w/rack mount, excel, \$410; **Best UPS L1 3KL**, \$1275. J Coursolle, WPKR, 2401 W Waukau Ave, Oshkosh WI 54903. 920-236-4242.

Modulation Sciences CLD 2501/2502, 2 pair, composite line drivers, \$900 ea pair/\$1700 both. B Landry, WLMG, 1450 Poydias St #440, New Orleans LA 70112. 504-593-2107.

RCA rack 7' x 19-1/2" deep brown, tapped equip, \$175; **Gates rack 78" x 17"** deep gray, tapped equip, \$150; **Gray rack, 28" x 15"**, deep gray, tapped equip, \$50; rack, telephone relay, tapped, gold, \$20; **Thunder Bay** effects library LP's, \$50; **Gorman Redlich CD EBS** decoder, \$25; (2) **Symetrix SX-203** telephone hybrid, rack mtd, \$150 ea. E Swanson, WPKR, POB 3450, Oshkosh WI 54903. 920-236-4243.

RF Warning Signs
9"x 12" \$13.95
10"x 19" \$19.95
HE HALL Electronics (804) 984-4255



Kintronics 500-200 or less power reduction, \$250. C Jones, WMNY, 7620 Old #6, Santee SC 29142. 803-854-6396.

NBC Chimes, mint cond, \$50; **TAC** telephone coupler, never used, \$50; **Sountrack** novelty record player, \$25; **Capitol** audio tape (5) from 1970 in sealed Peter Max type artwork box, \$50; **Cooke** vintage album sampler, mono, 1958, New Orleans jazz, etc, sealed, \$25; **Crown 700** series ops service manual, \$20; **Howard Stern** Crucified by the FCC, mint cond, \$75. J Morinelli, Joe Morinelli Entertainment, 901 Fairfax Rd, Drexel Hill PA 19026. 610-715-1720.

Simpson 260 Series 5P AC/DC voltage & ohm multimeter, complete w/manual, test wires & carry case, mint cond, \$160; **Philips 22RH 567** electronic crossover, 3 way speaker system w/built in pwr amps, motion feedback system, 22"H, 13"W, 11"D matched pair, \$500. S Barker, KAK Prod, 1994 Sillick Terr, Santa Rosa CA 95404. 707-528-4055.

Want to Buy

DeVry 34 manual or copy, beginning construction DeBry mdl 34 scope kit circa 1975, already have manuals 9031, 9034, 9037, 9040. S Della, Sound, 9404 N 47th Ave, Glendale AZ 85302. 602-937-9088.

Keith Monks record cleaning machine. A Lanset, Film-Audio Services, 430 West 14th St, #308, Nyny 10014. 212-741-9524.

Magazines: RCA Broadcast News, any issue or cond, single issues or bound set; also any other RCA or other broadcast catalogs. S Horner, Salem Comm, 4880 Santa Rosa Rd, Camarillo CA 93012. 805-654-0577.

Jazz record collections, 10" LP/12" LP be-bop, swing, dixie, highest prices paid. B Rose, Program Recdgs, 228 East 10th, Nyny 10003. 212-674-3060.

MONITORS

Want to Sell

Used Mod Monitors, McMartin & Belar. Many to choose from tuned & calibrated on your frequency. Full guaranteed. Goodrich Ent. 402-493-1886.

Belar RFA-1 FM RF amp, \$150. C Siegenthaler, KSIW, 612 S 14th Ave, Yakima WA 98902. 509-453-5492.

RECEIVERS & TRANSCEIVERS

Want to Sell

Vertex VX500 32 chnl VHF handheld scan dual priority, can program charger speaker mic, \$250. P Russell, Boudoin College, Sills Hall, Brunswick ME 04011. 207-725-3066.

SCA RECEIVERS—ALL TYPES

Will work to meet your receiver needs
Professional / Table / Portable
Field Strength Meters
Reading Service / Ethnic / Data
DAYTON INDUSTRIAL CORP.
2237 Industrial Boulevard
Sarasota, FL 34234-3119
Tel: 941-351-4454 FAX: 351-6081
E-Mail: SCARadio@aol.com

RECORDERS

Want to Sell

Ampex 601 stereo TR, needs electr work, also have (2) 620 speakers & amp, \$400/all +shpg; **Ampex 620** & speaker amp, \$100 +shpg. P Paquin, Sound Dynamics Assoc, 41 Scargo Hill Rd, Dennis MA 02638. 508-385-0805.

DAT Machine Service
Digital Audio Tape
Fast, expert repairs on all DAT recorder brands & models including ADAT and DA-88
Warranty Service on Most Brands
Over 3000 Machines Serviced!
New/Refurbished DATs Available
Compare Our Rates!
Pro Digital Inc.
DAT Recorder Service Specialists
(610) 353-2400

Harris stereo PB, new motor & heads, BO. J Randolph,

New River Media, 604 N 3rd, Danville KY 40422. 606-236-9447.

Marantz PMD 220 prof 3 head mono 2 speed portable cassette rcdr, excel cond, \$175. S Barker, KAK Prod, 1994 Sillick Terr, Santa Rosa CA 95404. 707-528-4055.

STUDER REVOX PARTS/SERVICE
Cassette-CD-Open reel
Capstan resurfacing, ALL BRANDS.
JM TECHNICAL ARTS
30 Music Sq. W. #156
Nashville, TN 37203 (615) 244-6892

Nakimichi cassette rcdr, \$160; **Otari 5050**, \$1400; **ITC** decks, BO. J Baltar, New Musik Directions, 67 Green St, Augusta ME 04330. 207-623-1941.

Otari ARS-1006-L (3) automation PB decks, \$1500/all +shpg. J Bahr, POB 6556, San Juan PR 00914. 787-756-5914.

HEAD RELAPPING/REPLACEMENT
All tape and film formats
30 years experience
iem
350 N. Eric Drive
Palatine, IL 60067
800-227-4323

Tascam 32 r-r, perfect, \$1375; **Panasonic DAT SV-3700**, excel cond, \$600; **Marantz PMD-222**, R/P XLR, 2 sp, in in/out, perfect, \$300; **Telex ACC-4000** duplicator, perfect, \$1800. J Coursolle, WPKR, 2401 W Waukau Ave, Oshkosh WI 54903. 920-236-4242.

Tascam 38 r-r 1/2" 8 trk, \$1950; **Otari MX-5050 r-r 1/4"** 2 trk, \$700; (2) **Ampex 1/2"** 499 tape on 10" reel, \$30 ea; **JVC TDW 201** cassette deck, \$50. E Swanson, WPKR, POB 3450, Oshkosh WI 54903. 920-236-4243.

Tascam DA-88 hi 8, 8 trk digital rcdr, low hrs, \$2000. A Brooks, Procomm Studios, 3 Whiteoak Rd, Arden NC 28704. 704-684-1461.

Crown SX824, 4 trk, 3.75 & 7.5, original carton & manual, serviced by Boho, excel cond, BO. MG Morris, NBC, 20 E 9th St #8-P, Nyny 10003. (no phone# given)

DISTRIBUTOR DIRECTORY
The following distributors serving the broadcast industry would be glad to help you with any of your requirements.

CORNELL-DUBILIER MICA CAPACITORS
FROM STOCK

JENNINGS VACUUM CAPACITORS
FROM STOCK

JENNINGS VACUUM RELAYS

SURCOM ASSOCIATES
2215 Faraday Ave., Suite A
Carlsbad, California 92008
(760) 438-4420 Fax: (760) 438-4759

...Some people get hooked on broadcast equipment big time...they think about it...dream about it...talk about it all the time...for example...us...
RADIO! The beat goes on!
CROUSE-KIMZEY OF ANNAPOLIS
tops in broadcast equipment
1-800-955-6800
ask for Kathleen
kkannapolis@worldnet.att.net

BUY FROM THE LEADER.
CUSTOM steel, anodized aluminum, or laminated - plates, panels, rack mounts, and floor boxes built to your specifications.
Fast and Accurate!
Any way you need them:
blank, punched, engraved, loaded, even pre-wired!
Call 800-733-9473.
whirlwind™



RECORDERS continued...

DO YOU NEED PARTS FOR SCULLY TAPE RECORDERS ???

SEQUOIA ELECTRONICS
1-(408) 363-1646
FAX 1-(408) 363-0957

Metrotech 554A 2 chnl, 2 pass, 10" r-r magnetic audio tape logging rcd in gd cond, can record up to 307 hrs on one 0.5 mil reel, \$200. D Palmer, WXTQ, 300 Columbus Rd, Athens OH 45701. 614-593-6651.

Nakimichi cassette rcd, \$160; Otari 5050, \$1400; ITC 8 trk decks, BO. J Baltar, New Musik Directions, 67 Green St, Augusta ME 04330. 207-623-1941.

Scully 280B 2 trk 7.5-15, rack mountable w/separate electronics, \$300, leave message. J Congdon, IMG, 35 Lancaster Dr, Greenacres FL 33463. 561-433-8823.

ITC Reel-to-Reel Specialists. Complete stock of spare parts. Motor rebuilding and heads for both reel-to-reel and cart machines.

VIF INTERNATIONAL
PO Box 1555
Mtn View CA
94042 U.S.A.

USA & Canada: 1-800-848-4428
Elsewhere: 1-408-739-9740
FAX: 1-408-739-0809
VISA & Mastercard now accepted

Sony M2-R2 w/lithium-IOU rechargeable battery & accessories, \$300; Sony TCD-07, new in box, \$350; Audiosphere vintage binaural tape player, staggered, vgc, \$50; Tandberg 11 classic portable tape rcd from 1960, excel cosmetics, \$100; Uher 4400 1/4 trk. needs cleaning or parts set, \$35; Tandberg 6, tube unit, \$35; Ampro vintage portable, crank rewind, line powered, \$35; Sony 111, 5" capacity, red, \$25; Crown Series 700 & 800 parts, \$75. J Morinelli, Joe Morinelli Entertainment, 901 Fairfax Rd, Drexel Hill PA 19026. 610-715-1720.

MX70 video playback system, \$900; Gd used "x2500" 456 tape, \$20, 1"x2500" 996 & 250, \$35; new MRL short test tapes, \$229 for 2", save \$400. Save on all other formats too. W Gunn, Box 2902, Palm Springs CA 92262. 760-320-0728.

New & used Ampex 350 style tape transports, motors & parts, various prices. M Crosby, 408-363-1646.

Tascam ATR60-2, in stand, \$1200; Tascam 58, 8 trk, \$1950; Tascam 38 8 trk, \$1650; Otari 5050-8 Mk III, \$1900; Ampex 1200 PURC cards (5), \$125 ea; Custom locator for any deck, \$495; Sony 2 trks, \$195 ea. W Gunn, Box 2902, Palm Springs CA 92262. 760-320-0728.

Want to Buy

MCI JH-110 A, B, C 1/2" 2 trk heads, new or used. J Borden, Handbasket Prod, 2909 S Logan Ave, Milwaukee WI 53207. 414-482-8954.

Stellavox rcds & parts. C King, King Audio, POB 116, East Bevilin CT 06023. 860-665-2881.

Miniature & classic portable recorders, tape & wire configurations, access, manuals, literature, photos & documentation on usage; Stancil-Hoffman minitape port tape rcd, manuals, photos, promotional literature; Minifon mini German wire & tape rcds & access, manuals, photos & literature; miniature metal tape reels, 3" or smaller, except Nagra; Technics RS-1500, must have 1-7/8 speed; Technics SP-10 bases, must be original equip, need 1-2; Uher CV-240/CR-210; Magnecord PT6-BN; Crown 10" reel hub adapter, original rack mounting hardware w/decorative blk plastic washer. J Morinelli, Joe Morinelli Entertainment, 901 Fairfax Rd, Drexel Hill PA 19026. 610-715-1720.

Ampex ATR100 taperecorders for parts. Circuit cards, heads, motors, machine parts, or electronic parts. Call 818-907-5161.

Ampex machines, recorder electronics, mixers. W Gunn, Box 2902, Palm Springs CA 92262. 760-320-0728.

REMOTE & MICROWAVE

Want to Sell

RENT IT HERE!

COMREX New/HotLine ISDN Codecs Frequency Extenders
TELOS Zephyr Hybrids Digital Phone Hybrids
CCS MUSICAM Prima Codecs
SHURE PP 410 Automatic Mixers
SCOOP REPORTER 7kHz single POTS line codec

SILVER LAKE AUDIO • 516-763-1776 • FAX: 516-763-1750

Comrex LTX/R (2) \$700 ea; US Audio Whirlwind Mix-5S stereo mixer \$225; SKB rack-mount case-4 unit \$120, excel cond. The Voice Box. 313-480-9981.

Comrex Nexus ISDN, perfect, \$1350; Comrex Codec Buddy, perfect, \$1200; Comrex DXP.1 G.722, excel, \$950; Comrex TCB-1A telephone coupler, excel, \$95. J Coursolle, WPKR, 2401 W Waukau Ave, Oshkosh WI 54903. 920-236-4242.

Gentner DH1 digital telephone hybrid w/manual, new in box, \$875, KTBQ, 422 E Main #124, Nacogdoches TX 75961. 409-564-4559.

Marti STL-8, 2 rcvrs, 2 xmtrs, 946.875 MHz, 947.125 MHz, excel cond, \$2000. A Fairchild, 2250 Holly Hall

WE RENT FOR LESS

Hotlines	FM Exciters
Zephyrs	STL's
Nexus	FM Pwr Amps
Audio	Test Equipment

If we don't have it, we will get it!
SCMS, INC. (800) 438-6040
"You Know We Know Radio"

ADVERTISE! 703-998-7600 call now!

#115, Houston TX 77054.
713-797-6173.

Marti subcarrier gen STL data SCG-10, \$400; Marti subcarrier demod STL data SCD-10, \$400; Marti subcarrier gen 67 kHz SGC-10, \$400; Marti subcarrier demod 67 kHz SCD-10, \$400; Moseley subcarrier demod 110 kHz, \$200; Marti 67 kHz amp in mini box, \$20; Marti RMC remote control, \$500; Marti RR30/45D/30000 rcd, 450.02 MHz, \$750; Racom 1300AP Morse identifier, \$50. E Swanson, WPKR, POB 3450, Oshkosh WI 54903. 920-236-4243.

Inexpensive Satellite Time!
Low cost satellite airtime available for remotes, programs, concerts etc. WE use only 4 hrs per day, can you use any of the other 21 & weekends? Substantial savings, this opportunity won't last! Uplink form anywhere in the USA or use our studio. Call IBN Radio, 954-735-4070 or email info@ibnradio.com

Moseley DSP-6000 digital STL transmission system, \$3500/BO. M Osborne, WKSQ, POB 9494, Ellsworth ME 04605. 207-667-7573.

Burk ARC-16 w/3 control panels, digital speech module & computer interface, can be used dial-up voice, computer or radio (SCA builtin), BO; Moseley SCD-8 demodulator & SCA system for 110 kHz, BO; Moseley TRC-15 w/meter panel, set up for wired operation but also includes modules for radio operation, BO. P Guello, KUWS, 1800 Grand Ave, Superior WI 54880. 715-394-8187.

Motorola UDS UTA220K ISDN desktop terminal adapter, like new, \$450; CDQ 2000 ISDN codec encoder, like new, \$1500. D Cowley, KYXS/KJSA, 114 N Main St, Weatherford TX 76086. 817-594-9409 or 817-589-7312.

WE RENT

TELOS ZEPHYR
CCS "Prima" Codecs
COMREX 3-line extender
Frank Grandstein
Audio/Video
Consultants
610-642-0978

Moseley MRC-2 w/MDC-2, (2) CIP-2 relay panels, Viewpoint CRT & keyboard, clean, \$975. D Kiker, WCOA, Box 12487, Pensacola FL 32573. 850-477-8500.

Telos Zephyr w/built-in terminal adapter, 20-bit D/A converter, \$3599. B Christensen, Paragon Engrg, 11142 Raizy Creek, Jacksonville FL 32225. 904-619-3899.

Gentner G3200 digital telephone hybrid, like new, \$875; Broadcast Electronics mono R/P cart machine, unused, \$385. Contact D Harris, 703-319-1431.

SATELLITE EQUIPMENT

Want to Sell

Chaparral Cheyenne C and Ku rcd, older descrambler module, \$50. P Russell, Boudoin College, Sills Hall, Brunswick ME 04011. 207-725-3066.

Wegener DRI85 QPSK sat rcd, \$1200; Westwood One data demod, \$100; ABC network decoder, \$20. E Swanson, WPKR, POB 3450, Oshkosh WI 54903. 920-236-4243.

Scientific Atlanta 7300 rcd w/7.5, 15 K cards, \$1300. M Rogers, KISE, POB 3320, Monterey CA 93942. 408-373-2250.

Wegener DR960, 3 mos old, \$450. M Rogers, KISE, POB 3320, Monterey CA 93942. 408-373-2250.

SATELLITE SYSTEMS

Satellite Equipment for Radio

Off the air? Looking for quick repair service?

Rely on us!

Satellite Systems is respected industry-wide for prompt, accurate service to radio stations and networks.

Contact us for Ariel and Zephyrus 700 SCPC receivers. Upgrade your Fairchild Dart 384 and Scientific Atlanta 7300/7325 to LNB receivers — use existing equipment as trade-in.

Pre- and post-service technical support, along with a 6-month warranty.

Turn to the leader in repair, upgrades, new equipment, used equipment and accessories. We can answer all of your questions.

SATELLITE SYSTEMS

615 East Brookside Colorado Springs, CO 80906
Phone: (719) 634-6319 Fax: (719) 635-8151
Circle (231) On Reader Service Card

SOFTWARE

Want to Sell

Affordable TRAFFIC & BILLING

PC SOFTWARE for DIGILINK & other popular digital systems. Now available with MUSIC SCHEDULER. Excellent for non-automated stations, too. Try it for 90 days. No obligation. For demo, call ABA Software: (941) 643-3888 email abasoft@naples.net

STATIONS

Start your own commercial radio station with only \$5000 or less!

Yes it's possible & legal. Part 15 of FCC rules allows low power AM radio stations to operate without a license!! Cover an entire town & bill \$1500 a month!! It has been done!! Order the newsletter booklet that tells you all you need to know to get started for just \$29.99. Send check or money order payable to: WCTD AM 1670, 4 Canal St, Westerly RI 02891 or call 401-348-9222 for more info. FCC Inspected.

Want to Sell

Florida AM CP on 780 kHz, 500 W, near St Petersburg, gd coverage. Freddie, WPNP, Box 154, San German PR 00683. 787-264-3802.

10K AM in North Central AZ. 520-774-0864.

TAPES/CARTS/ REELS/CD'S

Want to Sell

3M 10" (100) reels, used once as master, \$1500/lot. D Brunelle, ECB, 50 Albion St, Methuen MA 01844. 508-245-2383.

But I Don't Need 500 Discs!

If you're a syndicator and require your radio shows on Compact Discs and out there **FAST** call

DIGI-ROM

1 to 300 discs duplicated **OVERNIGHT**. We'll even print a label right on the disc!

(800) 815-3444

NYC (212) 730-2111 • www.digirom.com
130 West 42nd Street • New York, NY 10036

Dynamax ESD-10 splice locator, \$500; cart rack Carousel holds 200 carts, \$150; cart rack wall blk plastic 36 slot, \$10; (2) cart rack, wall, wood, 84 slot, \$50 ea; (3) cart rack, wall, wood, 108 slot, \$50 ea; AA-3 tape cartridges, \$1 ea. E Swanson, WPKR, POB 3450, Oshkosh WI 54903. 920-236-4243.

Metal reels, 10", vgc, approx 200, \$5 ea. G Morgan, Master Audio Prod, 2 Robin Court, Morristown NJ 07960. 973-539-5200.

Major prod music library from 50s or 60s, mint cond, \$150; Scotch 177 empty metal reels (30), \$35. J Morinelli, Joe Morinelli Entertainment, 901 Fairfax Rd, Drexel Hill PA 19026. 610-715-1720.

Microtran table top tape degausser, handles 1"-2" tapes, \$150/BO; mechanical tape timers, Lyrec & Seike/Spotmaster, new & used. M Crosby, 408-363-1646.

Want to Buy

McGregor, Capitol, NBC 16" radio transcriptions, music library. J Hartt, Hartt Audio Transfers, 2418 36th Ave West, Seattle WA 98199. 206-282-0720.

Westrex tape cartridges & equipment. J Morinelli, Joe Morinelli Entertainment, 901 Fairfax Rd, Drexel Hill PA 19026. 610-715-1720.

TEST EQUIPMENT

Want to Sell

HP 8444A tracking gen, \$1000; Tektronix DC502, FG501, 508 counter, \$600/all; Wavetek spectrum analyzer 512FFTS, \$650. J Baltar, New Musik Directions, 67 Green St, Augusta ME 04330. 207-623-1941.

Sencor SC-61 waveform analyzer, like new, \$500. P Russell, Boudoin College, Sills Hall, Brunswick ME 04011. 207-725-3066.

Tektronix 585A w/202-1 scope cart, all manuals, lots of plug-ins & probes in excel

TRANSMITTERS

TRANSCOM CORP.

Serving the Broadcast Industry Since 1978

Fine Used AM & FM Transmitters and Also New Equipment
For the best deals on Celwave products,
Andrew cable and Shively antennas.

- | | |
|-----------------------------|----------------------------------|
| 100 W FM 1985 Harris FM100K | 1 KW AM 1970 Collins 820D |
| 10 KW FM 1986 ITA 10,000B | 2.5 KW AM 1975 McMartin BA2.5K |
| 20 KW FM 1977 RCA BTF 20E1 | 5 KW AM 1969 Harris BCH5H |
| | 5 KW AM 1979 Harris MW-5A |
| | 5 KW AM 1980 Harris MW-5A |
| | 5 KW AM 1980 Collins 828E-1 |
| | 5 KW AM 1982 Continental 315F |
| | 5 KW AM 1982 Continental 315R-1 |
| | 50 KW AM 1978 Continental 317C-1 |
| | 50 KW AM 1981 Continental 317C-1 |
| | 50 KW AM 1981 Harris MW-50B |
| | 50 KW AM 1982 Harris MW-50B |

1077 Rydal Road #101, Rydal PA 19046

800-441-8454 • 215-884-0888 • FAX No. 215-884-0738

VISIT OUR INTERNET SITE: WWW.TRCORP.COM

SEND YOUR E-MAIL REQUESTS TO TRANSCOM@TRCORP.COM

Grade (230) On Reader Service Card

Harris MX-15 FM exciter, needs work, on 106.1 MHz, \$1500/BO; Harris/Gates TE-3 FM exciter on 104.1 unknown cond, \$850/BO; Harris 2.5K 2.5 kW FM xmtr, needs work, no exciter, tuned to 106.1 MHz. J Bahr, POB 6556, San Juan PR 00914. 787-756-5914.

RCA BTA-1R 1 kW AM xmtr, immaculately maintained in studio in TX. hi-pos mod modification, tubes, documents; Kintronics LTU-7B ATU, both on 1030 kHz, \$1000/both you pick up. B

Savage, WYSL, 5620 S Lima, Avon NY 14414. 716-346-3000.

Translator 10W, excel cond, \$1000/BO; 20 W Bext program-able exciter, excel cond, \$1500/BO. L Brent Oliphant, KMXE, POB 1678, Red Lodge MT 59068. 406-446-1199.

Gates & RCA BC5P, BTA-5H, BTA-10H, \$1000 ea or \$2500/all, you haul. B Zellmer, KSIR, POB 2224, Greeley CO 80632. 970-353-6522.

Gates FM-1C 1 kW FM w/TE-3 exciter & stereo gen, gd working

cond when removed from service, \$2000. J Towne, KOLU, 4921 W Wernett St, Pasco WA 99301. 509-547-2062.

Gates Vanguard II AM, 1kW-.5KW on 1590, gd tube & spare, you pick up in SW Iowa, \$1000/firm. C Maley, KSIB, 514 N

BESCO World Leader in AM - FM Transmitters
Internacional "Now in our 30th year"

116 AM & FM Pre-Owned Units in Stock

- ✓ ALL - Powers
- ✓ ALL - Manufacturers
- ✓ ALL - Instruction Books
- ✓ ALL - Complete
- ✓ ALL - Spares

Call and take advantage of our liberal trade-in plan. Tune and test on your frequency, available on site. Complete inventory on request.

Phone: 1-214-630-3600
Fax: 1-214-226-9416
e-mail-besco@why.net.com

17th, Clarinda IA 51632. 712-542-4858.

LPB 25C AM, 25W w/coupler & 2 crystals, \$600 or trade for vintage portable or miniature recorder. J Morinelli, Joe Morinelli Entertainment, 901 Fairfax Rd, Drexel Hill PA 19026. 610-715-1720.

RCA BTA-1R original modulation xfmr w/matching reactor from a BTA-1R, \$200. M Koscak, WSKB, 605 Loomis St, Westfield MA 01085. 413-562-1950.

RCA BTF5E1 5 kW FM, \$6000. WC Florian, WNIB, 1140 W Erie, Chicago IL 60622. 312-633-9700.

TFT 7700 STL xmtr for parts only, BO. P Guello, KUWS, 1800 Grand Ave, Superior WI 54880. 715-394-8187.

CHEAP! CHEAP! CHEAP! SPARE IPA'S (MMD) 700W Solid State for Harris HT20-35 FM, \$500 ea. Also Harris FM 3.5/K IPA. All working modules. Call Mark 1-800-750-1071, leave message.

Eimac 4CX15000 (Y456) Tetrode. Very low hours. Guaranteed to produce power. \$1000. 702-386-2844.

Aphex Type III, \$400. J Arzuaga, WLAZ, Curry Ford Rd, Orlando FL 32812. 787-895-0000.

Used PTEK 500W FM amplifier, \$2950, full manufacturers 2 year warrentee. Other power amps and exciters also available. 408-448-3342.

Want to Buy

1 kW bdct xmtr in gd cond for conversion to 160 & 75 meter bands, prefer close to Buffalo NY for pick-up, up to 8 hr drive OK. W Gittere, Poly Materials, 10510 Clarence Ctr Rd, Clarence NY 14031. 716-741-3776.

McMartin AM/FM xmtr, any model, exciter or stereo modules. Goodrich Ent., 11435 Manderson, Omaha NE 68164. 402-493-1886.

WHEN YOU'VE GOT  SOMETHING THIS GOOD, YOU CAN'T HELP BUT BLOW YOUR OWN HORN!



There comes a time when a company knows it has a break through product. And for Energy-Onix, that time is now.

The **ECO 15-30**, Single tube, High Power Grounded Grid Transmitters up to 32 KW.

- ◆ Solid State driver up to 2 KW serves as emergency transmitter
- ◆ Straight Forward field proven control system
- ◆ VSWR Protection & More

◆ BEST OF ALL THEY ARE ECONOMICALLY PRICED!



"The Transmitter People"
Energy-Onix

1306 River St, Valatie NY 12184

518-758-1690
FAX: 518-758-1476

Circle (229) On Reader Service Card

Superior Broadcast Products

Quality FM Transmitters at Reasonable Prices

20 watt Exciter	\$ 995.00	5 Kw.	\$ 19,990.00
120 watt	\$ 2,500.00	10 Kw.	\$ 22,990.00
300 watt	\$ 2,990.00	15 Kw.	\$ 28,990.00
2.5 kw	\$ 10,990.00	20 Kw.	\$ 34,990.00
STL Transmitter	1,990.00	STL Receiver	\$ 1,790.00
Both	\$ 3,500.00	20 w Translator	\$ 2,500.00

FM Antennas as low as \$ 395.00 Per Bay

Jimmie Joynt / Superior Broadcast Products
Ph. 973/473-2577 800/279-3326 Fax 800/644-5958
17194 Preston Rd. #123-297 Dallas, TX 75248

TEST EQUIPMENT CONTINUED

cond, \$6000/BO. R Chrysfafis, C&M Comm, 809-1/2 Mulberry St, #1, Williamson WV 25661. 304-235-2292.

HP 8444A tracking gen, \$100; Tektronix DC502, FG501, 507 counter, \$600/all; Wavetek spectrum analyzer 512FFTS, \$650. J Baltar, New Musik Directions, 67 Green St, Augusta ME 04330. 207-623-1941.

Want to Buy

Heathkit IO-10 small portable tube type oscilloscope from late 1960s. W Gunn, Box 2902, Palm Springs CA 92262. 760-320-0728.

SERVICES

Tower Sales & Erection

Turnkey Site Development
Installation & Maintenance
AM/FM Broadcast, TV
Microwave Systems,
Antennas & Towers

TOWERCOMM
Communications Specialists

Ben Wall
President
6017 Triangle Dr.
Raleigh, NC 27613
(919)781-3496
Gen. Contractor #25891 Fax (919)781-6454

ADVERTISE!
703-998-7600
call now!

Want to Sell

EIMAC, RCA, AMPEREX, 3-500, 3CX1500A7, 4-400, 4X150A, 4CX250B. 572B, 807, 833C. Westgate 800-213-4563.

Advertise! Call your advertising representative
for details & deadlines **703-998-7600**

TUBES

Quality Power Tubes



300B (See SV300B)
3CX300A1
3CX400A7
3CX2500A3
3CX2500F3
3CX2500H3
3CX3000A7
3CX3000F7
3CX4500F3
3CX6000A7/YU148
3CX10,000A3
3CX10,000A7

4CPX800A
4CX1500A
4CX1600B
4CX3500A
4CX5000A
4CX5000R
4CX7500A
4CX10,000D
4CX12,000A
4CX15,000A
4CX15,000J
4CX20,000A
4CX20,000B
4CX20,000C
4CW10,000A
4CPW10,000R
4X150A
5CX1500A

5CX1500B
572B
6550C (See SV6550C)
6A57G
6BM8
6D22S
6L6GC (See SV6L6GC)
6N1P
811A
812A
833A
8161R
8560AS
EF86
EL34
EL509
SV83
SV300B

SV572-3
SV572-10
SV572-30
SV572-160
SV6550C
SV6L6GC
SV811-3A
SV811-10
TH5-4
TH5-6
TH6-3
TH6-3A
YC130/9019
SK300A
SK1300
SK1320

• Manufactured in Russia's largest power tube factory •
Generous warranty based on high quality • Honest prices based on
quality at low cost • Shipment from USA stock

www.svetlana.com

Headquarters: 205-882-1344 Fax 205-880-8077 • Marketing & Engineering: 650-233-0429 Fax 650-233-0439



Circle (228) On Reader Service Card

BEE EMPLOYMENT

D & C Electronics Co.

NEW TUBES

We have the alternatives for all your needs, at the lowest prices, direct from OUR STOCK!!!

EIMAC, SVETLANA, PRO-TEK®, EEV and many others.
(352) 688-2374
PH: (800) 881-2374
FAX: (352) 683-9595

SE HABLA ESPAÑOL WE EXPORT VISA/MASTERCARD ACCEPTED

ECONCO

Quality Rebuilt Tubes

Approximately 1/2 the Cost of New

Call for Our Price List
800-532-6626
916-662-7553
FAX 916-666-7760

Circle (227) On Reader Service Card

RF POWER

The Best of Two Worlds!

Immediate Shipment from Stock

Svetlana

Se Habla Español
(760) 744-0500 • (888) 744-3500
Fax: (760) 744-1943
e-mail: rfp@rfparts.com

RF PARTS
435 SO. PACIFIC ST.
SAN MARCOS, CA 92069

Circle (226) On Reader Service Card

FOR THE BEST PRICE

& 24 Hr service on transmitting tubes & sockets/parts, new & rebuilt call Goodrich Ent. at 402-493-1886 day or night, FAX 402-493-6821.

TURNTABLES

Want to Sell

Rek-O-Kut Rondine JRL-34 (2) in working cond, \$200 ea +shpg; Shure SME 3009, sine arm, GE arm, \$300/both +shpg. P Paquin, Sound Dynamics Assoc, 41 Scargo Hill Rd, Dennis MA 02638. 508-385-0805.

Empire 298, disassembled w/belt, \$150; Empire 598-gold w/top of line cartridge w/base, excel cond, \$150; Ortofon 212 tonearm setup gauge, mint cond, \$50. J Morinelli, Joe Morinelli Entertainment, 901 Fairfax Rd, Drexel Hill PA 19026. 610-715-1720.

Technics SP10/15, record cutters, tube equipment. 612-869-4963.

Want to Buy

Cooke binaural tonearm, must be in excel cond. J Morinelli, Joe Morinelli Entertainment, 901 Fairfax Rd, Drexel Hill PA 19026. 610-715-1720.

Shure SME 3012R phono tonearm. J Hartt, Hartt Audio Transfers, 2418 36th Ave West, Seattle WA 98199. 206-282-0720.

HELP WANTED

Assistant Chief Engineer

Dame Media Group Harrisburg is in need of an Assistant Chief Engineer for their 6 stations in Harrisburg. Responsibilities would include maintenance and repair of broadcast transmitters and STL systems associated with their stations. Maintenance and repair of all studio and remote broadcast equipment. Meet and coordinate with all other department heads to provide engineering assistance for remotes, special projects and other misc. jobs. Candidate must comply with all FCC rules regarding the technical operations of the stations and function as the Chief Operator as defined in FCC part 73.1870

Please forward resumes to the Business Office with cover letter and salary requirements: Dame Media, Business Office, 600 Corporate Circle, Harrisburg, PA 17110-9787.

NO PHONE CALLS PLEASE

CHIEF ENGINEER

For a large Los Angeles audio production facility. Must have extensive experience in studio maintenance, digital work station operation and maintenance, as well as computer network skills. Position requires experience in designing and building new studios and familiarity with all building support systems i.e. air, power, etc. Strong people skills and work ethic a must. Full benefits, moving costs and a very competitive salary discussed upon formal inquiry. Send resume to: Radio World, POB 1214, Falls Church VA 22041. Attn Box #97-10-15-1AW.

CHIEF ENGINEER:

For growing Western Colorado Company. Experience in AM, FM, FM Boosters, STL's, computers, LAN's & studios. Resume & salary requirements to: General Manager, POB 60040, Grand Junction CO 81506. EOE.

MORNING TEAM HOST AND AIR TALENT FOR OTHER DAYPARTS:

Southern New Jersey's leading radio station, WRDR-FM is in the process of putting together the best morning show in the region. We are looking for a host who will compliment our Adult Standards format, and help bring the station to the next level. We are also accepting applications for other dayparts. T&R immediately to: Chris Edwards, Director of Programming, WRDR, 300 Philadelphia Avenue, Egg Harbor City NJ 08215. No calls please. EOE.

Small, N.E. FM group seeks Chief Engineer to join management team.

Must be computer literate and capable of buildouts as well as ongoing maintenance. Fax resume to (603) 668-6470.

L.A. area trombo has a rare opening for a chief engineer.

Minimum 7 years experience in all phases including studio construction. We are a growing company that offers good pay, benefits and work environment. If you're looking for the Southern California lifestyle, send your resume to Mark Elliott/O.D., KBBY/KHAY/KVEN, POB 699, Ventura CA 93003. EOE.

POSITIONS WANTED

30 yr pro seeks small market mgmt opportunity in SE, broad knowledge, creative, organized, high integrity. Potential, POB 14706, Greenville SC 29610.

CE will make FM worries go away, you have a steak, I'll make it sizzle, power house but clean audio & RF. 1-904-467-3122 or mychucky@funport.net

Hard working, friendly, outgoing CE seeks employment, FT, PT, contract work,

Northeast, TV/FM/AM, cable station, exper CET & FCC licensed, avail immed. M Rakoff, 81-12 Roosevelt Ave #413, Jackson Heights NY 11372. 718-969-5224.

News anchor/producer, prod talent, AT adult formats, exper, mature, available for livable salary, no tape collectors/curiosity seekers. Alex McKuen, 513-777-8423.

Looking for a dream job in sports/news talk radio, also interested in account executive position, very intense, team player. Shawn, 405-665-4862.

BOOST YOUR SALES

Advertise in the Classified Section -

You'll be impressed with the results!

ADVERTISER INDEX

This listing is provided for the convenience of our readers. Radio World assumes no liability for inaccuracy.

Page No.	Advertiser	Reader Service No.	Page No.	Advertiser	Reader Service No.
54	360 Systems	39	38	Halland Broadcast	116
36	ASI Industries	143	11	Harris	81
19	Altronix Research	11	15	Harris	100
3	Armstrong Transmitters	56	40	Harris	85
12	Arrakis	105	44	Health Newsfeed Radio	38
41	Arrakis	109	30	Innovative Devices	71
30	ATI	70	6	Inovonics	104
35	Audio Broadcast Group	37	34	Inovonics	13
2	Audioarts Engineering	32	55	Instant Access Music	114
63	Auditronics	63	32	Intraplex	108
57	Auralex	234	36	J Squared Technical Service	45
36	Autogram Corporation	21	52	JK Audio	19
28	BDI	24	36	Modulation Sciences	69
29	Belar	36	39	Moseley	61
52	Benchmark Media Systems	115	36	Myat Inc.	118
25	Bradley Broadcast	12	38	Norsat	117
47	Broadcast Electronics	-	52	Nott Ltd.	91
49	Broadcast Electronics	-	42	NPR Satellite Systems	133
51	Broadcast Electronics	-	50	OMB Transamerica	134
53	Broadcast Electronics	15	33	Orban	132
28	Broadcast Tools	96	48	PR&E	52
22	BSI	83	16	Prophet Systems	10
18	BSW	130	28	PTEK	144
4	Burk Technology	80	31	OEI	84
36	Circuit Werkes	94	45	Radio Spirits	62
38	Circuit Werkes	93	52	Radio Design Lab	18
30	Coaxial Dynamics, Inc.	95	62	RF Power	226
7	Comrex	128	57	Roscom	233
30	Comrex	46	60	Satellite Systems	231
1	Continental Electronics	8	10	Scott Studios	57
30	Cortana	22	38	Shively Laboratories	68
46	Crown Broadcast	110	23	Shure Brothers, Inc.	107
14	Crown Satellite	82	24	Sierra Automated	148
12	DB Elettronica	152	52	Silicon Valley	43
52	Econco	67	8	Sine Systems	9
62	Econco	227	38	Spacewise Broadcast Furniture	44
13	Enco Systems	129	38	Stephens Communications	20
22	Energy-Onix	153	61	Svetlana Electron Devices	228
29	Energy-Onix	60	21	Tascam/ TEAC	59
61	Energy-Onix	229	9	Telos Systems	33
52	Excalibur Electronics	92	55	The Radio Mall	42
20	Factory Direct Sales	35	45	The Water Foundation	86
17	Flash Comm	58	61	Transcom Corp.	230
28	Freeland Products, Inc.	72	43	UPI	14
55	Ghostwriters	66,90	28	Videoquip Research	48
28	Gorman-Redlich Mfg. Co.	120	64	Wheatstone	87
30	H.L. Dalis	47	30	Zercom	119
57	Hall Electronics	232			

Production Director	Lisa Stafford	Ad Traffic Assistant/ Classified Coordinator	Anastacia Stornetta
Production Manager	Lisa Hoagland	Ad Coordination Manager	Simone Mullins
Publication Manager	Jennifer West	Circulation Director	Sheryl Unangst
Showcase Coordinator	Vicky Baron	Circulation Manager	Robert Green
Ad Traffic Manager	Kathy Jackson	Accounts Receivable	Steve Berto
Desktop Management	James Cornett		

Advertising Sales Representatives

U.S. East: Skip Tash	703-998-7600 ext 160 Fax: 703-998-2966
U.S. West: Dale Tucker	916-721-3410 Fax: 916-729-0810
U.S. Midwest: Sandra Harvey-Coleman	765-966-0669 Fax: 765-966-3289
Other Regions: Stevan B. Dana	703-998-7600 Fax: +1-703-998-2966
Latin America: Alan Carter	+1-703-998-7600 ext 111 Fax: +1-703-998-2966
UK, Ireland: Phil Guy	+44(0)1869-337508 Fax: +44(0)1869-337509
Europe, Africa, Middle East: Raffaella Calabrese	+39-2-7030-0310 Fax: +39-2-7030-0211
Asia/Pacific: Eiji Yoshikawa	+81-3-3327-2688 Fax: +81-3-3327-3010

Free Subscriptions are available upon request to professional broadcasting and audiovisual equipment users. For address changes, send current and new address to RW a month in advance at P.O. Box 1214, Falls Church, VA 22041. Unsolicited manuscripts are welcomed for review: send to the attention of the appropriate editor.

Communications Sector

TV/DTV Field Service Engineers



The implementation of new digital television services has created career opportunities at Harris Corporation's Broadcast Division, the world's largest manufacturer of radio and television equipment. Currently, we have career opportunities for Field Service Engineers located at our Quincy, IL facility.

These positions require a Technical Associate's degree or equivalent work experience, augmented by a solid background in high power RF broadcast transmission systems. One or more of the following skills is also required: experience in maintenance/repair of VHF or UHF broadcast transmitters; knowledge of TV/BT series VHF, Platinum series VHF, or Klystron/MSDC transmitters; and/or experience in installation of transmitter systems (UHR and/or VHF).

If you have the utmost technical competence in broadcast transmission systems at high power levels, are customer service oriented, and ready to travel domestically and internationally for extended periods of time send your resume with salary history in confidence to: Ellen Agard, Human Resources, Harris Corporation—Broadcast Division, P.O. Box 4290, Quincy, IL 62305-4290 or email eagard@harris.com. EOE M/F/D/V

Harris Corporation offers a competitive starting salary with a competitive benefits package and opportunities for growth and advancement. Harris Corporation is an equal opportunity employer.

HARRIS

www.broadcast.harris.com



THE FUTURE OF RADIO IS HERE **NuStar is ON-AIR**

Cleaner, Clearer, Quieter
DIGITAL AUDIO IS THE DIFFERENCE

The sonic quality of WEGR-FM in Memphis is really very good and it just got better. Their NuStar 3000 Series installed quickly and operates flawlessly. The Morning Wake-up Crew, TIM, BEV, and BAD DOG are pictured above at the control surface. Tim Spencer (P.D.) says "The great thing about it is that it's Digital, but operates like the regular Board we're used to. We feel that's important because with the new console, our staff hasn't had any operator miscues at all. The transition was seamless."

- AND IT'S READY FOR YOU AND YOUR STATION -
With new equipment technology and your air time on the line
The Name You Can Trust To Deliver Is:

 **AUDITRONICS**

3750 Old Getwell Road, Memphis, TN 38118 USA
Telephone: (901) 362-1350 FAX: (901) 365-8629
www.auditronics.com E-Mail: sales@auditronics.com

We Needed More HEADROOM



So We Went Ahead and BUILT IT!

We're the LEADER in audio broadcast consoles. WHEATSTONE is the company that brings you cutting edge technology, the best in customer support, and the security of knowing we'll be there tomorrow when you need us. We are just completing a new advanced manufacturing facility

at our new home in New Bern, North Carolina. This investment in the future represents WHEATSTONE's commitment to give you the BEST. Our growth includes expanding our team; if you're interested send a resume to Dennis Murdock, 1706 Park Avenue, New Bern, NC. 28560.

7305 Performance Drive, Syracuse NY. 13212 (315-452-5000)

1/15/98: 600 Industrial Drive, New Bern NC. 28562 (919-638-7000)

 Wheatstone Corporation

Circle (87) On Reader Service Card