

Vandals Demolish Tower

by Eob Rusk

SACRAMENTO, Calif. A disastrous chain reaction knocked Tribune-owned KYMX-FM off the air, doing more than \$300,000 in damage.

Its antenna was on one of three towers used by sister station KCTC(AM). All four guy wires on one leg of a 200-foot tower were cut in the early morning hours of September 6th, causing it to topple into and knock down the 510-foot tower that held the FM antenna.

On the way down, the top 100 feet broke loose from the insulators and fell onto the adjacent transmitter building. One of the tower's strobe lights came loose and went through the roof and landed between the transmitters. The third tower was unaffected.

Miraculously, KYMX (Mix 96) was off the air for less than seven hours, due to the quick action of chief engineer Jim Balcom.

continued on page 7 ►

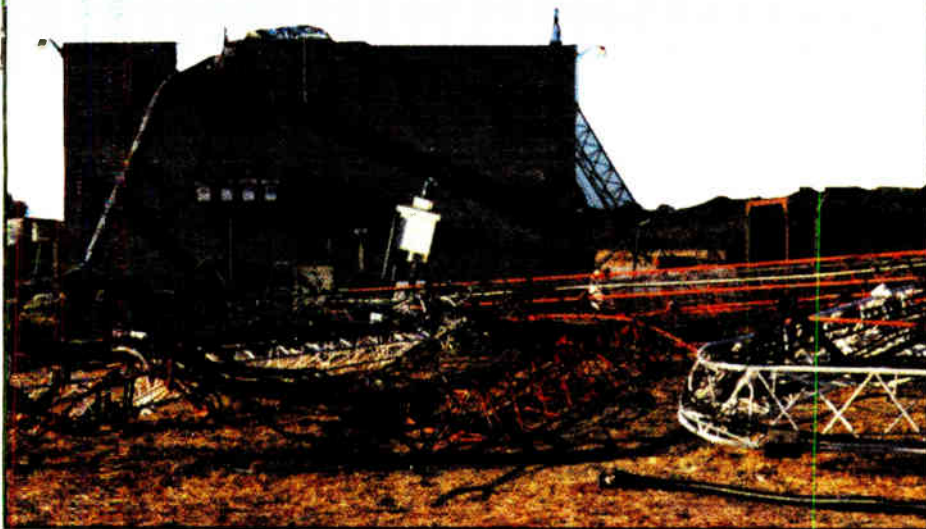

EIA Responds to DAB Proponents' Concerns

by Lynn Meadows

WASHINGTON Digital audio radio (DAR) proponents have the chance to prove the Electronic Industries Association (EIA) wrong.

Responding to charges that test results under the aegis of its DAR subcommittees are flawed, the EIA asked proponents late last month to turn over equipment and information used to gather data that differed so widely from its laboratory test phase.

The move is in response to concerns of three DAR system proponents expressed in a formal letter to the EIA.

DAR lab test results were released in August and brought a flurry of controversy surrounding the correctness of multipath simulations and compatibility tests between the digital signal and the analog host in the in-band, on-channel (IBOC) systems.

Subcommittees of the EIA and the National Radio Systems Committee (NRSC) are responsible for both lab and field tests of DAR systems. Results of the tests will be used to select a DAR standard so broadcasters can move forward

with digital broadcasting.

Nikhil Jayant of AT&T, Don Messer of VOA/JPL and Bernee Strom of USA Digital Radio (USADR) penned a letter in September raising several questions about the DAR laboratory tests.

According to the letter, Canadian and European organizations have already issued statements indicating that the lab tests prove that "in-band" systems do not work effectively.

These statements could have been avoided, the proponents wrote, "by suppressing laboratory data results until after field test results become available and until all test results had a thorough airing among the EIA/NRSC subcommittee, its consultants, and system proponents."

The EIA responded that reviewing the

continued on page 3 ►

Entrepreneur Mines Radio Overseas

BUDAPEST, Hungary Eastern Europe is taking a quantum leap through radio development history.

Metromedia International Inc. (MII) is trying to escort its stations in Eastern European markets through an evolutionary phase that lasted for more than 70 years in the United States.

Based in the United States, MII is a child company of Metromedia Company. It started in 1992 when Metromedia asked U.S. broadcasting veteran Carl Brazell to investigate broadcast opportunities in Eastern Europe.

"The rules were changing at the time," said Brazell, now president and CEO of MII. "Frequencies were being made available for the first time ever to private industry to get into broadcasting."

Brazell knew the opportunities and growth that the broadcast industry had produced over the past 75 years in the United States. He said he believed that

continued on page 7 ►

Continental To Acquire Telefunken

by Alexa Scanziani

BERLIN Continental Electronics Corp., a Dallas-based radio transmitter manufacturer, will buy out the German transmitter manufacturer Telefunken Sendertechnik GmbH effective Dec. 31 after months of negotiations.

This acquisition follows Continental's purchase last year of radio transmitter manufacturer Lensa of Santiago, Chile.

Financial terms of the agreement between Tech-Sym Corp. of Houston, parent company of Continental, and Daimler-Benz Aerospace AG, owner of Telefunken, were not disclosed.

Some in the industry were surprised at the announcement, noting Telefunken was sought by such companies as Thomcast.

Restructuring to come

The transaction is subject to an existing restructuring plan of Telefunken started by Daimler-Benz at the beginning of the year. It

continued on page 8 ►

DDS.
Digital Delivery System.
The one that really works.

1-800-622-0022 Fax 317-966-0623

HARRIS ALLIED

NEWSWATCH

Infinity Buys Alliance Stations

NEW YORK Infinity Broadcasting narrowed the gap that separates it from Group W Radio last month when it announced that it will acquire seven radio stations from Alliance Broadcasting for \$275 million.

BIA Publications estimated the 1994 combined revenues of Infinity and Alliance to be \$358.6 million while Group W revenues topped \$452 million.

With the deal, Infinity increases its holdings in Dallas, San Francisco, Detroit and Seattle and brings its station count to 34. Twenty-eight of those

stations are in the top 10 markets.

Infinity announced it will seek waivers from the Federal Communications Commission because the six new FMs will put its holdings over the national ownership limits.

SBE Election Results

INDIANAPOLIS Results are in for the recent Society of Broadcast Engineers elections. Serving one year terms are Terry Baun as president; Ed Miller as vice president; Sandy Sandberg as secretary and Troy Pennington as treasurer.

Board of Directors members were elected for two year terms. They include Jim

Bernier of Syracuse, N.Y.; Marvin Born of Columbus, Ohio; Andy Butler of Annandale, Va.; Rick Edwards of Ft. Lauderdale, Fla.; Robert Reymont of Mesa, Ariz. and Larry Wilkins of Montgomery, Ala.

Indecency Petition

NEW YORK A group of non-commercial educational radio stations and broadcasting and literary associations requested the Supreme Court overturn a lower court's decision to ban indecency between 6 a.m. and midnight.

Public Radio International, the Intercollegiate Broadcast System, and poet Allen Ginsberg are three of the petitioners who are asking the high court to review whether the ban is a violation of the First Amendment.

The National Association of Broadcasters filed a separate but similar petition on Sept. 28. The Supreme Court is expected to decide in January whether or not to hear the case.

Decline in Sales

WASHINGTON Despite rumors early this year of looming ownership deregulation, the National Association of Broadcasters said that the dollar volume of radio station sales decreased 10 percent in the first two quarters of 1995.

A report, "Trends in Radio Station Sales: 1993-1995" available from the NAB indicates that station sales were still 35 percent higher than compared to the same time period in 1993.

Broadcaster's Foundation Elections

GREENWICH, Conn. New board members and a new mission statement came out of the September meeting of the Broadcaster's Foundation.

Richard Foreman of Richard A. Foreman Associates; Gary Fries of the Radio Advertising Bureau; Lucille Luongo of

continued on next page ▶

Success Means Making the Right Decisions

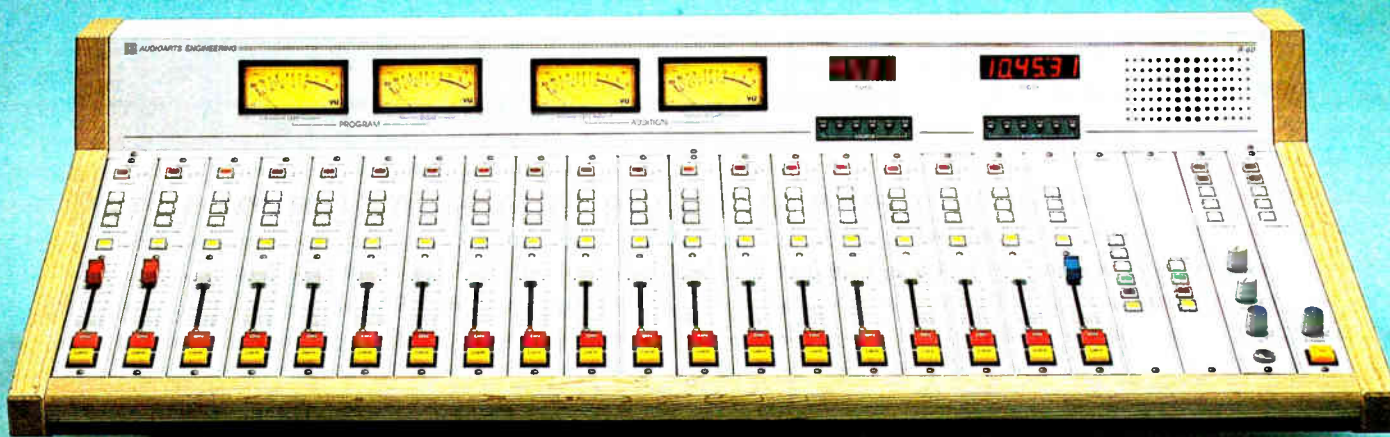

We DID.

OUR NEW R-60 CONSOLE has what stations really want: reliable illuminated switches—*everywhere*; smooth feeling P&G faders; a powerful monitor section. Our exclusive Simple Phone™ module is friendly and easy-to-operate, providing error-free talk segments.

The R-60 is **TOTALLY MODULAR** to streamline service—no motherboard mounted components. The quality of each module is unsurpassed; we even measure every resistor, capacitor, and diode

before it's installed. Completed consoles are burned in prior to final test. Meticulous care is the key here, so you can expect the ultimate in reliability.

Perhaps more important than high technology features and good looks is the fact that the R-60 is built and supported by Audioarts Engineering—a highly professional and dependable company you can count on.

A SUCCESSFUL STATION BEGINS WITH R-60.

 **AUDIOARTS ENGINEERING**

7305 Performance Drive, Syracuse, New York 13212 (tel 315-452-5000 / fax 315-452-0160)

Index

FEATURES

Use Superposition to Analyze Circuits by Harold Hallikainen	14
Sputnik Signal Captured for Radio by Chuck Crouse	16
Beware of So-called PC 'Experts' by W.C. Spenn	19
Workbench by John Bisset	20
Start-up Services Challenges NPR by Dee McVicker	22
Who Was First in Radio Still Debated by Barry Mishkind	70
How Ready Are You for Windows 95? by Richard Mertz	71

RUNNING RADIO

Exploit Benefits of Local Media by Mark Lapidus	25
Dissecting Ideas, Techniques behind Great Radio Spots by Ty Ford	27
'Net' News Abounded in New Orleans by Alan Haber	28
Job Description Key to Hiring Right Staff by Sue Jones	31
Invaders from Mars! in New Jersey by Richard W. O'Donnell	35

WME COVERAGE

Digital Redefines Workplace by Thomas R. McGinley	44
'New World' Possible with Digital by Thomas R. McGinley	44
Debunking Some of Radio's Oldest Myths Can Improve Business by Alan Haber	48
Sales Rates Mirror Station Worth by Bob Rusk	51
EAS Provides Significant Edge Over EBS by Thomas R. McGinley	53
Audio Tools on Display by Alan Peterson	54
Personality Radio Not Just for Mornings by Alan Haber	58
Management, Technology Focus of Ennes by Thomas R. McGinley	59
Engineering Primer on Art of Dealing with RF by Thomas R. McGinley	61
Source Gear Gravitates to Hard Disk by Alan Peterson	62
Editing, Production Gear Proliferates by Alan Peterson	63
WME Featured Wealth of Services by Alan Peterson	66
Consoles Heart of Studio	67
New Program Choices	67
Keep Audio in Line	67
Developments Fast and Furious in RF	68

EIA Responds to IBOCs

▶ continued from page 1

lab results before the field tests will help the EIA and NRSC Subcommittees "gain maximum value from the field tests" and "insure that questions raised by the lab results are investigated adequately during the field trials."

Multipath test

In November 1994, both the VOA/JPL and USADR proponents made oral and written objections to the exclusive use of the Rayleigh sampling technique. According to the EIA, they found the Rayleigh fading model used to simulate multipath impairments "unrealistically harsh compared with field conditions they assumed would be experienced by DAR systems." Not all proponents agree, replied the EIA.

EIA added that the Rayleigh multipath

simulation was included "along with other challenging tests to provide a wide range of data for evaluation."

The subcommittee asked USADR to provide its HP simulator to the NASA Lewis Research Center "to re-establish the testing configuration."

EIA also addressed USADR's assertion that the Hewlett Packard multipath simulators were calibrated using a procedure that would produce average power levels under Rayleigh conditions lower than those specified in the approved test procedures.

The subcommittees asked USADR to

provide its HP simulator to the NASA Lewis Research Center "to re-establish the testing configuration, to test varied calibration methods and to determine the extent of signal losses (if any) that differ from the intended test conditions."

transmission. According to the letter, the categorization and grouping given by the CRC to the systems tested during the quality level test did not include qualifications pertaining to bit rate. "The CRC was not supposed to 'evaluate;' it did," they wrote.

The EIA said that the matter has been referred to a task group for recommendations on how to restate the information.

Field tests

Field testing is supposed to begin this fall in San Francisco. The NRSC was planning to meet this month to discuss Eureka's request to add two transmitters to improve its coverage of the test routes.

The three proponents wrote that all terrestrial systems should have to use the one transmitter site located at Mt. Beacon.

Any use of another major L-band transmitter site, they wrote, should be considered a demonstration and no data should be gathered. "The alternative is to open up the field test process to system changes from the other proponents," they concluded.

EIA responded that the subcommittees hope to conduct testing on all locations and routes using both the single and dual transmitter configurations for the Eureka system and to report all data.

"Other system proponents can propose to the subcommittees their own system changes/configurations they desire to be incorporated into the field testing program for their systems," the EIA agreed.

Any new configurations will be considered by the subcommittee at a Nov. 1 meeting.

NEWSWATCH

▶ continued from previous page

American Women in Radio and Television; Edward F. McLaughlin of EFM Media; and William O'Shaughnessy of WVOX/WRTN were all elected to the board of directors.

The Foundation's new mission and theme is "Honoring Today's and Encouraging Tomorrow's Broadcast Pioneers." The foundation will offer a new membership package this fall to people who have completed twenty years as broadcast professionals. The package will include a customized desk piece with the name, date and place of entry into the business.

"This venerable organization has been an important part of the broadcast community since 1942," said Gordon Hastings, president and CEO. "We are now prepared and organized to be even more relevant to our membership and the broadcasting community at large."

Arbitron Ballots Coming

NEW YORK Arbitron Company clients should look for the election ballot for the Arbitron Radio Advisory Council Election to reach their mailboxes in early November.

Five format representatives including Adult Contemporary and CHR/Top 40 in non-continuously measured markets and AOR, Gold/Oldies, and Spanish in all markets will be elected to start three year terms on Jan. 1, 1996.

The council consists of 13 elected radio broadcasters who hold the position of general manager or higher and two appointed research representatives. Members are elected by their peers from stations in their formats and market size.

Legitimate Excuse

VIRGIN ISLANDS Hurricane Marilyn tromped over the Virgin Islands on Sept. 15, right about the

time broadcasters were sending the 1995 regulatory fees to the Federal Communications Commission (FCC).

The FCC agreed to extend the filing date for license renewal applications in the Virgin Islands to Dec. 1, 1995.

The National Association of Broadcasters (NAB) asked the commission to waive regulatory fees which were due Sept. 20 and extend the Oct. 2 filing date for renewal applications for all stations licensed to the Virgin Islands.

The NAB reported that on St. Thomas only WSTA-FM was broadcasting at full power. Three other stations were on the air with reduced power or lower antennas and four more were completely dark.

On St. Croix, the NAB wrote that WJKC-FM appeared to be on at full power while WAVI-FM had lost its tower.

"Even if stations had made their payments before the storms interrupted mail service, the costs of rebuilding facilities — combined with the disruption of normal advertising markets — will place virtually all Virgin Islands broadcasters into financial hardship," the NAB wrote.

Increase In Duopolies

CHANTILLY, Va. Research conducted by BIA shows that in a survey of all radio stations in the top 50 markets, 38.4 percent are in duopolies. That is 497 out of 1,296 stations.

BIA noted that this is a 44.9 percent increase since March, 1995 when only 343 stations were in duopolies. BIA added that the number of stations involved in LMAs also increased since March of this year from 48 to 69 stations.

The survey included all stations in the top 50 markets that had 12+ shares greater than zero percent in the Spring edition of BIA's Investing in Radio Market Report.

Going Codec?

Go Comrex.

Beyond superior broadcast quality and rugged reliability, Comrex codecs are backed with an invaluable extra: Direct, personal tech support from someone who is prepared to provide whatever level of assistance you need. Just one toll-free phone call away.

With our full range of codec technology and a reputation for integrity and objectivity, we're able to offer the best sounding, cost-effective solution for SW56, ISDN or dedicated digital lines.

Questions about compatibility, connectivity, delay, system and transmission costs? We have the answers. And we'd be happy to arrange a demonstration.

A partial listing of Comrex codecs:

DXR (rackmount) DXP (portable)	DX100	DX200
G.722 (CCITT)	apt-X	ISO/MPEG Layer II MusicLine™
Excellent for Talk, Sports, AM or Voice Programming	Good choice for STL, Studio-to-Studio and higher quality audio	Superb FM remotes, Studio-to-Studio Links, Music Programming

U.S. 1-800-237-1776 • UK 0 800 96-2093
Europe: Request your free Comrex calling card.

Dynamic, ongoing support is also available via:

- Comrex ACCESS — quarterly newsletter
- Fax-on-Demand — library of technical and applications information
- Comrex Users' Forum, PC-networked on CompuServe
- Comrex Handbook — "Digital Telephony"



COMREX®

Comrex Corporation, 65 Nonset Path, Acton, MA 01720
508-263-1800 • Fax-on-Demand 508-264-9973 • Fax: 508-635-0401

Open Discussion, Debate the Best Policy

WASHINGTON Expectations are running high (at least in my mind) with the Electronic Industries Association's (EIA) response to the digital audio radio proponents who expressed concerns about portions of the lab tests (see **RW**, Sept. 20).

Nikil Jayant of AT&T, Don Messer of VOA/JPL and Bernee Strom of USA Digital Radio (USADR) wrote EIA last month, raising several questions about the DAR laboratory tests.

consultants and system proponents. I don't think so.

Posturing by the Canadians and the Europeans is unavoidable — but it is simply that, posturing. The issue here is broadcasting's future *in the United States*. The dialog and discussion, and if need be, readjustments, need to be open and strong.

★ ★ ★

I like to give credit where credit is due. A few issues back, I complimented the Bayliss Broadcast Foundation on its efforts to brighten radio's future with its scholarship program and fundraising dinners.

Glenn Gutmacher, new media manager for Collegiate Advantage Inc. and member of the Board of Governors, WYBC-FM Yale Broadcasting, wrote to enlighten me about another, far-reaching scholarship program for student broadcasters.

I was unaware that the National Association of College Broadcasters (NACB) supports thousands of student radio broadcasters annually through a combination of:

- ◆ Subsidized conferences bringing media professionals together with students.
- ◆ Cash awards for outstanding student station operations, programming and promotions.
- ◆ National advertising on college radio stations via a partnership with the Interep Radio Store.
- ◆ Publications (magazine, station handbook, etc.).
- ◆ On-line listserv.

The NACB will host its eighth annual international conference at the Rhode Island Convention Center in Providence, Nov. 16-19. For more information, call them at 401-863-2225.

★ ★ ★

I'd like to draw your attention to John

Bisset's *Guest Commentary* on page 5. John makes some good points to station managers. But the onus of good communication

can think and act like a manager, in broad strategic terms that benefit the operation, then maybe, someday, engineers will



Open discussion is a healthy part of any process. By setting itself up as the sponsoring organization (through its subcommittees on digital audio radio) of testing designed to select *the* system to be used in the United States, EIA had to expect some tough questions as the process unfolded.

By allowing the proponents to submit gear and information for lab verification, the EIA will allow that DAR discussion to continue in an educated and informed manner.

According to the letter, Canadian and European organizations have gone to town issuing statements about how in-band doesn't work and yaddah, yaddah ...

The letter-writers say these statements could have been avoided, by suppressing lab results until after field testing and all the test results had a thorough airing among the EIA/NRSC subcommittee, its



Blackhawk Visits with Jones Satellite Networks

ENGLEWOOD, Colo. Henry Paul, Van Stephenson and Dave Robbins of Blackhawk made it a priority to stop by JSN's U.S. Country and CD Country studios during their recent visit to Denver, Colo. Blackhawk joined U.S. Country's Chad Peterson and CD Country's Cliff Powers for more than an hour of interviews and phone calls from fans nationwide.

should not fall only on the shoulders of those managers.

If you are a good engineer, communicate that to your manager in a language that he or she understands. Learn to see through his or her eyes, quantify things in his or her terms and do so with authority.

John is right, engineers are on the station team and should be proud to of it. Don't whine about not being involved in strategy sessions, take the initiative and present ideas and plans that show you can strategize and improve the bottom line.

It is amazing that perks, spiffs and bonuses exist only to motivate sales people. But maybe, just maybe, if the engineer can show management that he or she

once again be treated with the respect they deserve for their vital role in keeping the stations on the air and profitable.

★ ★ ★

Well, it is almost time to wrap up this issue. I, for one, am heading south to the Outer Banks of North Carolina for a week of rest and relaxation. (By the time you read this, I will have returned). I'll try not to think too much about radio — but with so much going on, I don't know that I can avoid it.

Does the concept of IBOC work? Is the RBDS rollout moving apace? (We seem to be getting a constant stream of calls and letters requesting placement in our RBDS Roll Call.) Are there really only six months to go for NAB? Aaahhh ...



ARC-16: the logical choice for LMA and duopoly transmitter control.

For more information on the ARC-16 family of transmitter controls, contact Burk Technology.

1-800 255-8090

BURK TECHNOLOGY

7 Beaver Brook Rd., Littleton, MA 01460
Phone (508) 486-0086. Fax # (508) 486-0081
email danrau@burk.com

COUNTRY WESTERN
 CLASSIC ROCK
 AIM

Put us in your sites.

READERS FORUM

If you have comments for Radio World, call us at 800-336-3045 or send a letter to Readers Forum (Radio World, Box 1214, Falls Church, VA 22041 or MCI Mailbox #302-7776). All letters received become the property of Radio World, to be used at our discretion and as space permits.

Not so anonymous

Dear RW,
I really enjoyed the article, "Radio Writers Toiled in Anonymity (RW, July 26)." However, as a person who actually lived — and listened — through the "Golden Age of Radio," I must make a couple of comments.

First, Mr. Morse was always given credit as the writer of the programs and was always called Carlton E. Morse. His home was a point of interest on the bus tour that covered the Golden Gate area of San Francisco, back in the 1940s and '50s.

Additionally, Barton Yarborough played Doc Long on "I Love a Mystery," not Reggie York(e)! Yarborough was also Joe Friday's first side-kick on both the early radio and TV editions of "Dragnet."

If I'm not mistaken, the Mutual version of "I Love a Mystery" was called "I Love Adventure," at least for a portion of its MBS run. Perhaps there was a copyright problem, etc. "Mystery" was heard on CBS, at least for a portion of its original run!

Carlton E. Morse also authored a soap opera known as "The Woman in My House," heard on NBC weekday afternoons in the early 1950s. It did not last long!

C. Howard McDonald
Veradale, WA

Farewell

Dear RW,
The radio engineering community lost one of its pioneers on Aug. 2. Thomas Kenneth "Uncle Ken" Abernathy died at 82. Uncle Ken was the director of engineering at Statesville Broadcasting Company in Statesville, N.C., from 1940 - 1985.

Although there was only one engineer who actually was his nephew, there are many of us across the Southeast that considered him our wise old uncle. From his vision and belief in FM in the 1940s to his tireless belief in me in the 1970s he carried the banner proudly of a "radio engineer."

His most important contribution to radio was not some new invention, but his principles and beliefs in sharing everything he knew with young, wet behind the ears, engineers like me. In addition to the sound engineering and electronics education he passed along to us, he gave something no school ever could, his wisdom of life.

As a great American once said, "Old soldiers never die, they just fade away." Farewell Uncle Ken, a grateful industry will now carry your message to another generation.

Jerry E. Brown, CPBE
Virginia Beach, VA

Radio Should Take The Lead

For most radio equipment exhibitors, the 1995 World Media Expo (WME) was as expected, weak but not bad. The second annual combined event boasted a larger number of attendees for the NAB Radio Show, SBE's National Convention and RTNDA but the SMPTE portion drew less than last year.

It also boasted some very concerned TV equipment exhibitors — with attendance down some 3,000 overall from last year — who are seriously considering whether the exposure per dollar they reaped at WME was worth the trip, or a repeat performance.

It was clear from the beginning that a combined event like the WME would impact the fall NAB Radio Show. With two years of WME down, the character of the fall NAB Radio Show has changed — and some of the change (more good sessions) is positive, but not all.

The WME concept was geared toward making the equipment manufacturers happy. Where they once had to attend four different exhibitions (or at least three for those that are radio-only), they now could handle all four with one trip.

It was also assumed that SMPTE, SBE and RTNDA would bring to WME their TV membership. This is not happening in sufficient quantity and is the main problem.

A partial fix would have NAB structure increased attendee time into the exhibit hall so that attendees are not torn between educational sessions and shopping for gear and services. In New Orleans, for much of the time, the sessions won. This is bad for the show, particularly because it returns to what is considered by many to be a weak venue, downtown Los Angeles, next year.

NAB is trying to put together a winning idea with the WME. It needs to structure it better and, at the same time, ensure that the Radio Show is not diffused by the TV events. But, in the end, if the WME concept can't be made to work, then NAB should focus on building the Radio Show again.

— RW

GUEST COMMENTARY

Radio Losing Best of Its Engineers

by John Bisset

WASHINGTON A story in the news a few weeks back had a doubly saddening effect, as I realized how analogous it was to what is happening in the broadcast engineering community today.

Hurricane Felix brought heavy surf and riptides to mid-Atlantic beaches. A father

and son were standing in waist-deep water, enjoying the waves, when a riptide literally tore the young boy's hand from his father's and swept him into the ocean. His body was discovered a few days later. That family will never be the same again.

Where is the analogy? It is being viewed regularly as the value of qualified broadcast engineers slips in the eyes of station owners and management.

Allure of other side

In radio's case, the riptide is the allure of other technical (non-radio) careers; those that do not require wearing a pager 24 hours a day, do not include maintaining everything from the copy machine to the toilets (oh, and a transmitter and studio too), do not require working seven days a week and actually pay decent money and benefits.

The jobs are there; in the computer, cellular, and electronics disciplines. Too many qualified broadcast engineers are leaving for those jobs, dismayed with the future of radio.

The riptide has arrived, folks, and just as that ocean wave changed that family's life in an instant, the loss of a qualified engineer will change yours and that of your station if you let it happen.

The result will hardly leave you better off. In addition to a protracted search for a competent replacement, you may find you have to offer twice as much in salary to attract a qualified candidate.

If you think your station is immune, do not underestimate the power of that riptide. Has your engineer been "offered" two or three other stations to take care of, with no additional help or compensation

to maintain those recently acquired properties? One engineer I know I was routinely putting in 18-hour days, running between five stations. The general manager had the audacity to complain that a new studio project was not being completed fast enough.

At another station, when the LMA went through, the engineer's protest at the escalating workload was met with the comment, "Just be glad you have a job."

In a budget-cutting move, was the engineering vehicle axed while those of the general manager and general sales manager got spared? Showing that even major players goof, the comptroller of a very large broadcast group slashed the four-wheel-drive vehicle from the engineering budget, even though the transmitter was atop a mountain and the only access was a four-mile, rutted, muddy logging trail. The comptroller saw no reason why the engineer couldn't drive his own vehicle — or walk — to the transmitter site. Anything for the bottom line. "Anything"?

Share in success

Does your engineer share in ratings bonuses when the station does well? How long do you suppose someone will tolerate being the unsung hero when the ratings go up, and be blamed for any ratings downturns, before looking at other career options?

Not long ago, a director of engineering complained to me that program directors in his chain were receiving quarterly bonuses equal to his own annual salary. To make matters worse, his request for a \$1,000 raise for one of his hardest working chiefs

was turned down as an "unnecessary and unjustified expense."

Are the bizarre working hours taken into account? I have known stations that required engineers to work all night, then be in attendance for a 9 a.m. staff meeting and be expected to put in a full day after that. Time off? Comp time? You've got to be kidding.

Lack of communication

So how did the industry get onto this track anyway? My guess is communication — or more likely, the lack of it. Too many managers refuse to involve themselves in the "black magic" of engineering. The less they hear the better, yet they still want their engineer to conform to their unrealistic standards.

The wise owner or manager knows that not just anyone can maintain a technical facility properly or competitively. If you think I am wrong, consider this: would you turn your BMW over to the high school kid that pumps gas the next time the car needs a tune-up?

If you have a good engineer, communicate that he is on your team and you are proud of that. Involve him in strategy to improve the bottom line, and don't be afraid to be generous when he goes above and beyond the call. I am still amazed at the thinking that perks, spiffs, and bonuses exist only to motivate sales people.

Question management styles that discount loyalty, and promote staff turnover as essentials to a better bottom line. The management gurus never tell you how costly and inefficient this practice is. When applied to a broadcast station's technical department, the results can be terminal.

Riptides will come and go, but it will be the effective manager that keeps a cautious eye out for them, and forms a bond with his chief engineer that no riptide can break.



Vol. 19, No. 21 October 18, 1995

Editor in Chief.....Lucia Cobo
Technical Editor.....Alan Peterson
Associate Editor.....Whitney Pinion
Staff Writer.....Lynn Meadows
Contributors.....Frank Beacham/N.Y., Bruce Ingram,
Pamela Watkins, Nancy Reist, Alan Haber
Technical Advisors.....John Bisset, Tom McGinley
Editorial Director.....Marlene Lane
Assistant Editorial Director/Audio.....Alan Carter



Radio World (ISSN: 0274-8541) is published bi-weekly by Industrial Marketing Advisory Services, Inc., 5827 Columbia Pike, Suite 310, Falls Church, VA 22041. Phone: 703-998-7600, Fax: 703-998-2966. Second-class postage rates are paid at Falls Church VA 22046 and additional mailing offices. POSTMASTER: Send 3579 forms and address changes to Radio World, P.O. Box 1214, Falls Church VA 22041. REPRINTS: Reprints of all articles in this issue are available. Call or write Christopher Rucas, P.O. Box 1214, Falls Church, VA 22041; (703) 998-7600; Fax: (703) 998-2966. Copyright 1995 by Industrial Marketing Advisory Services, Inc. All rights reserved.

—PRINTED IN THE USA—

Next Issue of
Radio World
November 1, 1995

DARS Harmful to Radio, Says NAB

by Lynn Meadows

WASHINGTON For whom does the bell toll?

Local stations and the National Association of Broadcasters (NAB) said it will toll for small market radio stations if the Federal Communications Commission (FCC) gives the go-ahead to satellite Digital Audio Radio Service (DARS).

Since the commission issued the Notice of Proposed Rulemaking (NPRM) on DARS in June, hundreds of local station operators have written. The comment period ended Sept. 15 and the response period was scheduled to end October 13.

Negative impact

The National Association of Broadcasters (NAB) opposes DARS on the grounds that it will have a negative impact on local radio especially in smaller communities.

In comments submitted in September, the NAB requested that if the FCC approves DARS, it should be confined to a subscription-only service.

The NAB urged the commission to use a "promise vs. performance" approach by requiring DARS licensees to provide a comprehensive list of the programming they plan to offer and then verifying that they make good on their promises.

In its comments, the NAB opposed the use of terrestrial "gap fillers." The repeaters "would effectively transform the satellite DARS service into a terrestrial-based one," the NAB wrote.

The promise versus performance issue was echoed by several broadcasters who fear the introduction of multiple digital quality stations with programming formats like their own.

Wait for terrestrial

Many broadcasters commented that the commission should wait until terrestrial digital audio radio was available before introducing the new satellite service.

One concern expressed by the NAB is that successful satellite radio will "siphon audiences and perhaps national advertising from the existing highly competitive, already 'over-radioed' terrestrial radio system."

The NAB wrote that such siphoning could be the "last straw" for many smaller market stations and "for the more vulnerable stations everywhere." Station operators who broadcast information about town meetings, hurricane evacuation routes and local events questioned who would provide those services after DARS put them out of business.

While FCC Chairman Reed Hundt has talked about the negative impact of Congress lifting ownership caps on terrestrial stations and the major consolidation that will follow, only four applicants are in the running for frequencies on the 2310-2360 MHz (S-Band) which will broadcast DARS.

"There is no sound policy reason that the universe of satellite DARS providers should be limited to four favored applicants who will simply be handed 50 MHz

of extremely valuable virgin spectrum," the NAB wrote in its comments. It added that the spectrum should be opened to new license applicants.

Another group wrote that the commission should be alarmed that "only whites" would operate the DARS facilities. They recommended the commission "start fresh" and take new applicants or hold auctions with minority sensitive bidding credits.

Pioneer request

However, Primosphere, one of the four companies in line for a license, submitted comments urging the FCC to grant it a pioneer's preference for a license.

"Participation in the commission licensing practices has and will continue to result in the loss of much of Primosphere's valuable intellectual property," the letter read.

Another issue is the proposed use of the 7 GHz band for DARS feeder uplinks. The Society of Broadcast Engineers (SBE) wrote to say that television broadcasters rely heavily on the 7 GHz Broadcast Auxiliary band for studio to transmitter links, intercity relays, and mobile and portable television pickup stations.

The SBE in conjunction with Capital Cities/ABC Inc., Association of Maximum Service Television Inc. and NBC Inc. commented that feeder uplink stations should not be located within 80 kilometers of any existing 7 GHz television broadcast auxiliary receive sites.

The SBE also wrote that an uplink station should not be located at a site with radio line of site to an existing co-channel or adjacent-channel television broadcast auxiliary receiving location unless it would provide a co-channel desired to undesired (D/U) interference ratio of 60 dB or better or an adjacent channel D/U ratio of 0 dB or better.

Further, the SBE wrote that no DARS feeder uplink should be located within 30 kilometers of a major racetrack or within 16 kilometers of a major stadium or golf course "so as not to preclude the use of 7 GHz TV broadcast auxiliary spectrum for use by TV pickup stations."

Further fragmentation

The most frequently mentioned concern expressed in the comments from broadcasters all over the country was that DARS will fragment local audiences and steal listeners away from valuable local programming. Many wrote that the 80-90 docket damaged their bottom line making it harder to get a smaller piece of the advertising pie.

Non-broadcasters wrote in favor of proceeding with DARS. Reasons ranged from seeing the technology advance or having more listening choices in rural and remote areas.

Some stressed the number of jobs that will be created from DARS especially in the manufacturing industry where millions of antennas will be built.

IEEE wrote that by adopting DARS, the U.S. industry will be better able to compete internationally in "an area where other countries are currently more advanced in the commercial exploitation of technologies relevant to DARS."

Groups that drive through remote areas were also interested in DARS. The Owner-Operator Independent Drivers Association wrote that DARS could

enhance the quality of life for the drivers "by expanding the diversity of information and entertainment options receivable while on the road in rural and remote locations."

Keeping those options as unique as possible from terrestrial radio was a priority for broadcasters who wrote to the FCC.

One broadcast company wrote that DARS applicants should demonstrate the necessity for each channel they plan to broadcast and "document that the programming to be offered is not being provided to any significant degree by existing radio stations."

Houston Pearce of Radio South in Alabama warned in his comments that the commission should be careful that DARS is satellite radio and not a new terrestrial service. ☹

MPR Leases AM Facility To Network

by Lynn Meadows

MINNEAPOLIS Call it Creative Public Financing 101.

Minnesota Public Radio is leasing its frequency at 1330 kHz in Minneapolis to the MNN Radio Networks. Conflict of interest it is not since the frequency is on the commercial band.

MNN Radio Networks is a regional radio network that provides news, farm, sports, lifestyle, and weather programming to over 100 commercial radio stations in the Upper Midwest.

MNN is actually a distant cousin of MPR. The network is a subsidiary of Greenspring Co. which is based in St. Paul, Minn. Greenspring is wholly owned by Minnesota Communications Group (MCG) which is also the non-profit support organization of MPR.

"From the MNN radio stations perspective, it is simply a business decision," said Tim Shears, president of the MNN Radio Networks. The company wanted to improve its presence in the Twin Cities market. "To serve Minneapolis-St. Paul, we felt we had to move into station management," said Shears.

This is the first station MNN actually manages. Shears said they are trying to come up with fresh ideas to serve the local community. That includes participating in a "Put the Kids in the Seats and Off the Streets" campaign with the Minnesota Moose Hockey team.

The format for WMNN will remain basically the same. MPR was broadcasting an Associated Press All-News format. MNN will supplement that with regional and statewide news, sports, and weather programming that it produces.

Although commercials have replaced public service announcements, Tim Shears, president of the MNN Radio Networks, said "The response that we received has been very favorable."

MPR has two more stations on the FM band playing Classical and News formats. ☹

We maintain a Double Standard

Audio Precision offers two different standard-setting product lines.

The automated System One — the industry standard for bench and factory.

- Graphic results on PC screen with hard copy to printers
- Automated proof procedures & limits testing
- State-of-the-art performance and speed

The self-contained Portable One Plus & Portable One — for service bench and field.

- Compact and affordable stereo test sets for applications not requiring automation
- Both offer comprehensive capability & high performance in a rugged package
- Portable One Plus adds sweeps, graphs and printer port

The System One and Portable One... two families of test sets designed for different jobs, each with the quality and performance that you have come to expect from Audio Precision.

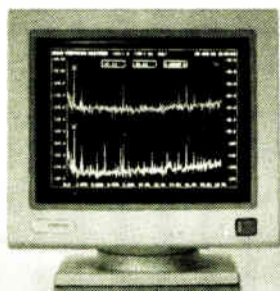

Audio Precision

RD, Box 2209, Beaverton, OR 97075
503/627-0832 1-800/231-7350
FAX: 503/641-8906, TELEX: 283957 AUDIO UR



Circle (212) On Reader Service Card

Vandals Destroy Tower for Copper

▶ continued from page 1

"The incident happened at 2:45 a.m.," Balcom said. "I got a call from our operator informing me that the station was off the air."

"As I was driving out to the transmitter site, I could see the red lights on one of the towers, but there were no strobe lights visible for the 510-foot tower. When I pulled up to the gate, I could see white stripes (from the strobe lights) on the ground."

The AM side runs different transmitter sites day and night, and was not affected by the incident. Balcom immediately began working to get the AC-formatted KYMX back on the air.

"That morning we borrowed a 300-watt transmitter from Sacramento High School," he said. "Three miles east of us, (competitor) KSEG has a 500-foot tower. They had a single bay antenna available. We're 96.1, they're 96.9. They happened to have an STL dish pointed in our general direction. So we were able to get on the air with 500 watts at 9:30."

"Meanwhile," Balcom continued, "I had called Jampro Antennas in Sacramento at

5:45 a.m. and told them I needed a single bay antenna and whatever line they could round up to mount on our 410-foot tower. At 1:00 that afternoon, they were here with an antenna and 200 feet of four-inch line."

Balcom had previously installed line running from the transmitter to the third tower—in case of an emergency such as this. By 5:30 the station was running 5 kW, which he said "gave us pretty decent coverage."

Balcom later put a five-bay antenna on top of the 410-foot tower and the station is now at 25 kW. Both downed towers must be replaced, and are being built by Magnum Tower of Sacramento. Balcom said it would be "sometime in November" before they are installed and KYMX is back to its full 50 kW. Total damage is estimated at \$375,000.

"Nothing was salvageable," he explained. "Everything was smashed to



KYMX's wreckage

smithereens. We have to replace the towers, strobe lights, FM antenna, plus do repairs to the transmitter building."

Sacramento County Sheriff's investigators suspect the wires were cut by vandals who were trying to steal copper that they then could sell to salvage yards.

"Copper is frequently stolen for scrap

metal," Sheriff's spokesman Sgt. John McGinness said. "Our investigation has focused on individuals who have been arrested (in another incident) for stealing copper using tools similar to that which were used in this case. We have a pair of bolt cutters at the crime lab that we believe were used in the crime. If it's found that they were used, the suspects will be charged with this crime."

McGinness described the suspects as "four white males in their 20s." It will be about a month before results are back from the crime lab.

The KYMX/KCTC transmitter site is on 30 acres of farmland about five miles northwest of downtown Sacramento. Most of what was destroyed in the vandalism was about 10 years old, according to Balcom, who has been chief engineer there for 24 years.

Radio in Budapest

▶ continued from page 1

would happen again in Eastern Europe, plus no one else from the United States was involved in that area on a grand scale.

Since that start, MII has acquired nine frequencies in five markets. Those markets include three Russian cities: Moscow, St. Petersburg and Sochi. The company also holds frequencies serving Riga, Latvia, and three cities in Hungary.

The first acquisition was Radio Juventus which is headquartered in Budapest and simulcasts to two other stations in Hungary.

Next came Radio Seven in Moscow and Radio Katusha in St. Petersburg. This year, MII added Radio Nika in Sochi, and Radio Skonto in Riga.

"In each case, with the exception of Sochi, Russia, we either bought into existing companies or formed new companies and acquired the interest in existing companies," said Brazell.

According to Brazell, no deals are signed unless MII has control. But part of the corporate strategy is also to have a national partner in every venture.

"We want to have local partners to help us understand the local cultures so we don't injure anyone's feelings and we don't injure ourselves in the process of trying to develop a business," said Brazell.

But MII is definitely applying western business strategies and western thinking to developing its new businesses. Brazell said "major changes" are being made at all of the stations MII has purchased. He was quick to add that MII is "absolutely not bringing American radio programming formats to these stations."

Brazell said radio is a local medium both in terms of town and culture. "We are developing local formats and putting them on the air to suite the tastes of the people in each country and each market." MII is using an American firm to do consumer

research to determine the best formats for its new markets.

The format changes have brought more music and "less irrelevant talk," said Brazell. "The talk that is on the air is specific and it addresses the kinds of needs that the consumers told us they wanted from a radio station."

The changes include a different mix of music, too. In Hungary, for instance, the playlist includes Hungarian music blended with music from Western Europe and some from the United States.

Brazell said one of the problems initially encountered was that the disc jockeys would play music because it was their favorite song or recorded by their favorite performer.

Early results in Hungary were promising according to Brazell. He said Radio Juventus has had an "upsurge" in advertising since the new format went on the air.

Brazell said he is not concerned about the lasting power of capitalism in Eastern Europe. "No one who does business there has any doubt that it's going to continue moving in the direction it's moving," he said.

"These people are taking a leap in five years in the radio business that we took in 75 years in this country," he said, speaking from Connecticut. "So there are all sorts of problems that come up that we have had to deal with on an evolutionary basis in the United States that they are having to deal with in a short turnaround basis in that part of the world"

Brazell admits solving those problems requires a lot of training. In the Moscow market, for instance, Americans work to increase the education of the seller and educate the advertisers.

Personality development is taking a little bit longer as well. A lot of the on-air personalities came from discos where they had fewer restrictions on what they played and said. As radio jocks, Brazell said they are often resistant to playlists and rotations that are carefully tested and mandated by management at a radio station.

Despite the evolutionary speed bumps along the way, Brazell said MII is either looking for or working on projects to expand into several new markets.

— Lynn Meadows

Question:
Ever wonder why transmitter manufacturers operate Altronic dummy loads at NAB and other trade shows?

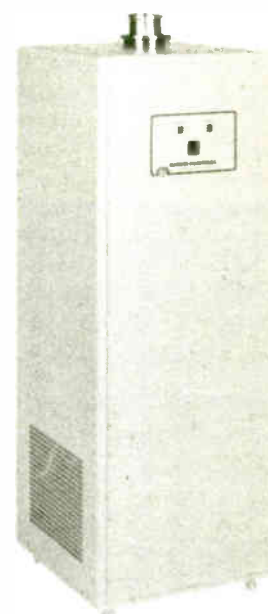

Answer:
The best performance and the most dependable dummy loads built.



ALTRONIC RESEARCH INC.

WATER AND AIR COOLED MODELS FROM 1000 WATTS TO 1,500,000 WATTS

P.O. Box 249
Yellville, AR 72687
(501) 449-4093

NANOAMP SERIES™ Mixer and Expander

MX100 Three Input Mic/Line Mixer
XP100 Four Input Companion Expanders

- Low noise Mic/Line switchable inputs • Phantom power
- Independent headphone and balanced line outputs
- Bright 3 color LED meter • XLR connectors
- Quiet external power • Rack and desk mounting

AUDIO TECHNOLOGIES INCORPORATED



328 W. Maple Avenue,
Horsham, PA 19044
TEL: (215) 443-0330 • (800) 959-0307
FAX: (215) 443-0394

Call or write for free detailed brochure

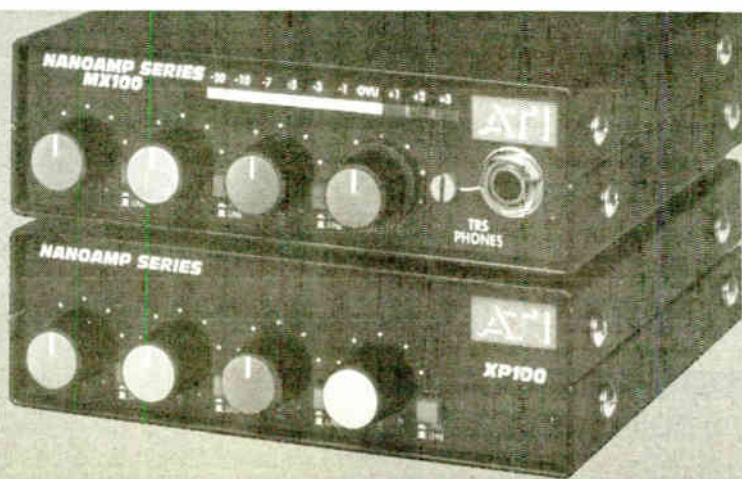

Continental Buys Telefunken

► continued from page 1

implies a repositioning and a reorganization of the company along with a drastic personnel reduction that will slash its work force in half.

"We do not know exactly how far it will go," said Bernd Sturzl, Daimler-Benz's spokesperson in Ulm, Germany, referring to personnel reductions. "All I can say is that out of 300 employees, we will not reduce more than 150."

Telefunken has been a leading European manufacturer of broadcast transmitting equipment for more than 90 years. In 1994, sales totaled about \$40 million. After its consolidation with Continental, Telefunken will retain its name.

"It will remain a German company," said Jurgen Graaff, Telefunken managing director in Berlin. "Only the share ownership is changing. It will be Telefunken Sendertechnik, a member of the Continental Group."

Commenting on this major consolidation, Graaff said, "Today, the broadcast transmitting market is a very difficult one. Other companies have merged together, such as Thomcast (formed when Thomson took over ABB). We must create synergies, simply because the costs of development are too high and not all companies can spend this money or will spend this money any more."

Continental Marketing Vice President Ross Faulkner, based in Dallas, reiterated Graaff's comments.

"Telefunken will be known exactly as it is today," Faulkner said. "The idea is that the three companies will operate in concert. There is no effort to diminish any-

Telefunken also puts Continental in the business of Digital Audio Broadcasting with a transmitter for Eureka-147.

one or lose their identity."

There will be some consolidation of distribution, Faulkner noted, with products from the three operations available from each respective company.

In addition to radio transmitters and antennas, Telefunken brings a line of TV transmitters and shortwave antennas to the range of Continental product. Continental offered FM antennas but has not made TV transmitters in more than 30 years.

Telefunken also puts Continental in the business of Digital Audio Broadcasting with a transmitter for Eureka-147.

Also expect to see a high-power digital radio transmitter, a unit that would compete with the new Harris DX series, Faulkner said. Telefunken and Continental already make a 500 kW shortwave transmitter.

Wendell W. Gamel, chairman and president of Continental's parent company Tech-Sym Corp., praised the broadcast range of products Telefunken brings to

his company. "The markets and products provided by Telefunken Sendertechnik will more than double our presence in the broadcast industry," he said in a prepared statement.

Gamel also noted that the combination of products from Continental, Telefunken and Lensa gives the operation the ability

to offer complete system engineering and turnkey services worldwide.

James Wood, a noted expert in high-power transmission and regular contributor to RW, said the purchase re-enforces

Continental's position in the world market.

Wood also said there is a shift of power in the shortwave business from Europe to the United States, with the ongoing consolidation.

The players in the high-power business are narrowed down to Thomcast, formed several years ago when Thomson of France bought ABB of Switzerland; Harris, based in the United States; Continental/Telefunken; GEC-Marconi, based in the U.K.; and Riz, based in Croatia.

"This consolidation has happened in other industries," Wood said, "and now it is happening in the broadcasting industry."

□ □ □

Alan Carter, Radio World International editor in chief, contributed to this report.

King Talks with President



LOS ANGELES Questions poured in by phone, fax and America Online on Sept. 21, when Westwood One broadcast a "Radio Town Meeting" with President Clinton hosted by Larry King.

On the show, Clinton addressed topics from the budget to Bosnia. Of special interest to the hundreds of radio stations that aired the show was the president's view on the Telecommunications Bill.

"I think the local concentration provisions ought to be changed before they send the bill to me," Clinton said.

The "Radio Town Meeting" is the first of six "Larry King Super Specials" from Westwood One.

TURN YOUR COMPUTER INTO A POWERFUL RADIO AUTOMATION SYSTEM WITH THE DIGITAL RADIO KIT



FOR ONLY \$2500
THE DIGITAL RADIO KIT
READY TO BE INSTALLED
IN YOUR COMPUTER
INCLUDING PROCAMS™
& REPROCAMS™
SOFTWARE, HARDWARE
PLUG-IN AND USER
MANUAL



- MANAGE SONGS, JINGLES, COMMERCIALS...
- A UNIQUE MUSIC STORAGE ON HDD AND / OR CDRECORDABLE
- 5 SPECIFIC RADIO FORMATS PROGRAMMABLE
- TRACK-MIXING, AUTO-START,
- BROADCAST SOUND QUALITY
- DOLBY AC2 OR MPEG FORMATS
- SEVERAL FUNCTIONS AND AUTOMATIC MODES
- PARAMETRIC COMPRESSOR / LIMITER
- PROGRAMMABLE PLAY-LIST
- SUPPLIED WITH QUANTITY OF SAMPLES
- USER MANUAL AVAILABLE IN ENGLISH, SPANISH, FRENCH
- EASY TO INSTALL
- THE BEST PRICE/QUALITY RELATIONSHIP
- ALREADY HUNDREDS OF KITS SOLD WORLDWIDE!
- WE ALSO HAVE COMPLETE SYSTEMS "READY TO USE"

KITS AND TURNKEY SYSTEMS AVAILABLE
FAX FOR COMPLETE DATA SHEET TO 34-5 / 281 42 15

INTERTEL c/28D N° 65-66 Las Brisas, 29660 Nueva Andalucía
Málaga, Spain Phone: Int (34-5) 281 42 15

Circle (12) On Reader Service Card

Do You Want A Better Sounding Station?

CRL CAN HELP YOU. No matter the size of your station or the size of your budget, we have an engineered solution for you.



Amigo FM.
Feature by feature the Amigo offers the best value in today's market. The Amigo has the ability to give any station a "big station" sound at half the cost of typical FM processors.

Call Today!

Give your station that distinctive sound you need to build bigger audiences.



Circuit Research Labs, Inc.
(602) 438-0888
FAX (602) 438-8227

Circle (80) On Reader Service Card

THE StereoMaxx 3-PACK: MARKET WINNING SOUND.

SOUND BETTER AND LOUDER WITH A REAL IDENTITY
WITHOUT SPENDING BIG MONEY FOR BIG NAME PROCESSORS.



The StereoMaxx: Spatial Image Enlargement.

When everyone in town is processed to the hilt, what can you do to win the sound battle? The answer is StereoMaxx. It makes your station sounds bigger, not just louder, by enhancing and enlarging your station's stereo image, making it wider and deeper beyond the boundaries of the speakers. No matter what type of radio your listeners tune, StereoMaxx will make your station sparkle with energy and excitement. While your competition will sound flat, dull and lifeless by comparison. And when you use it with our Composite Processor and the FM ModMinder, you get to be the most identifiable station in your market. Guaranteed.

The Composite Processor: 6 dB More Loudness. U.S. Patent 4,441,199.

Add up to 6dB more loudness, without ringing or overshoot, giving you the maximum modulation the law allows. Installed at your transmitter site, working with the StereoMaxx or any other existing processor, the CP-803 will make your air chain the loudest in town. This patented clever processor deals with the composite signal out of the stereo generator, avoiding many conventional audio problems associated with other (even some famous) processors.

Don't Pay Big Money For Big Name Processors.

Big name processors come in two basic versions: The economy model that does very little and the expensive models that do too much. Either way, your station may be stuck with the same sound as your competition. Big money for big name processors does not necessarily mean market winning sound.

The FM ModMinder: Absolute Max Modulation.

Digital technology and the FCC approved measurement method utilized in the FM ModMinder enable your station to operate at absolute maximum legal modulation. If your competition is not FM ModMinder equipped, your station will have them beat. Guaranteed. Easy dial-up access software included so you can perform a host of test functions by remote control from your office based PC (or from anywhere else in the world), giving you peace of mind every day.

Here's The 3-Pack Deal: Buy The StereoMaxx & ModMinder. Get a Free Composite Processor.

We give you a free CP-803 Composite Processor when you buy the StereoMaxx and the FM ModMinder together (you save \$1,495). Or, if you don't need all three, your MSI dealer will surely give you a great deal on any one or two of them. And if you're running duopoly, here's an opportunity to get the MSI processors you need on a great deal for all your stations. Act now, because this is a limited time offer.

Sound Better And Louder With A Real Identity.

*Call your MSI dealer or
call toll free (800) 826-2603
to receive full information and
to discuss your requirement.*

modulation sciences, inc.

12A WORLD'S FAIR DRIVE SOMERSET NJ 08873
TEL. (908) 302-3090 FAX. (908) 302-0206

Your Best ISDN Solution.

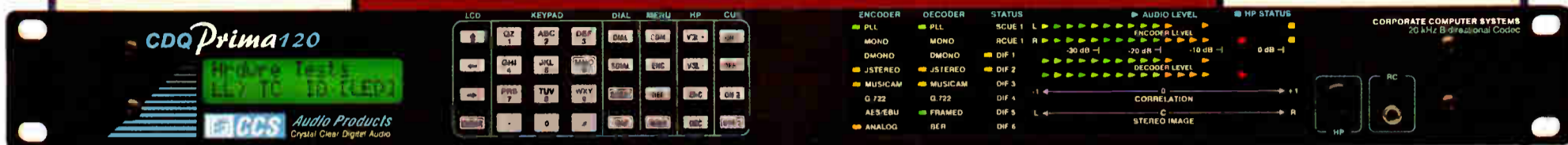

Money Back Guaranteed!

Only **CDQPrima™** with **MUSICAM®** is guaranteed to make your ISDN digital audio sound the best!

MUSICAM® is today's digital audio standard. Only **MUSICAM®** has enhancements designed to sound best over ISDN phone lines. Only **MUSICAM-USA®** gives you a 30-day money back guarantee.



Don't just take *our* word . . .

Ask over 10,000 **MUSICAM®** codec users worldwide

•

Ask USA Digital Radio DAB

•

Ask RCA DirecTV, LucasFilm and Top Recording Studios

We guarantee compatibility with MPEG II. Prima will even make your other brand decoder sound great!

Don't stake your next ISDN remote on five-year old Layer III or Layer II technology.

Call MUSICAM-USA® for the facts!



MUSICAM USA®

670 North Beers Street
Building 4
Holmdel, NJ 07733 USA
Tel: (908) 739-5600
Fax: (908) 739-1818

Formerly:
Corporate Computer Systems



Reporter Reveals All to President Clinton

by Gary Hart

MURPHYSBORO, III. You have probably heard of Carbondale. It is the home of Southern Illinois University. Every Halloween thousands of college students stampede through downtown Carbondale turning over cars, breaking windows and complaining when the police spray pepper mace.

Carbondale's Halloween-tarnished image was buffed to a high polish for at least a day. President Bill Clinton's visit

to the Southern Illinois University campus on Sept. 11 was the flawless media event White House staffers get the big bucks to fret over.

Like clockwork

The president was on time, for what might be the first time in his life. A damp, gray weekend was replaced by a warm, sunny Monday, streaked with feathery clouds. The clock on the Pulliam Hall tower ticked off the 30 minutes of the president's midday speech with an accuracy long-time Carbondale residents wouldn't recognize.

Local law enforcement met their goal: "Get him out alive." And only one person out of the 15,000 on what reporters dubbed "The Grassy Knoll" displayed the irresponsible exhibitionism that makes the City Fathers cringe. That person was me.

4:30 a.m.: Eight hours before The Incident, I was in bed, and my wife was taking a shower. My body wished it was still asleep; my mind was not cooperating.

My wife and I are both reporters. The president's visit infected our brains for more than a week. First, there was the rumor of a possible visit to check out. Then, when confirmation came, there were plans to be made. The planning couldn't get very far until we had an official itinerary in our hands, an itinerary that was days in the writing and a bit sketchy when it did show up on the fax machine.

The jitters got the better of the hour, so I put on my most comfortable pants and presentable shirt and fidgeted out to the Southern Illinois Airport between Carbondale and Murphysboro.

6:20 a.m.: Three hours before Air Force One would touch down, I pull onto the mist-shrouded airport parking lot. I was not the first journalist there. The press platform was a maze of power-suited television reporters, camera tripods and spike heels. The Secret Service and its bomb-sniffing wolfhound didn't arrive until the sun was high in the sky and the mist had burned off.

Credentials ready

While the White House demanded the name, birthdate, Social Security number and title of everyone wanting press credentials, the press people at the airport just glanced at my driver's license and handed over a green pasteboard card with a picture of the White House and space for me to write my name and station. That card is the journalistic equivalent of a backstage pass to Lollapalooza. If you've got press credentials on a string around your neck, you can sweep past the hordes of civilians at the metal detectors as grandly as the glitterati on Oscar night.

Out on the tarmac, men in Air Force and Army uniforms picked up any debris that could be sucked into the engines of the president's plane. Men in dark suits opened every door, every hood and every trunk on every one of the 30 cars, trucks and vans that made up the presidential motorcade.

The wolfhound sniffed professionally. In the terminal, invited guests of local, state and congressional Democrats assembled for a chance to shake the presidential hand, their reward for a lifetime

of party loyalty.

As I explored the roped-off press area for the best place to view the scene, I clonked my head on the platform. It still hurts.

A little while later, a silver, blue and white DC-9 with "United States of America" printed on the side landed and taxied to the terminal. The bevy of TV reporters and their dressed-down cameramen wondered aloud, "Is that him?" I wondered silently in my Dockers. The hatch opened, the auto-



President Clinton visited Carbondale.

matic staircase extended, and thundering down comes the herd of network and wire service reporters and photographers who document the president's every move.

Professional panache

9:20 a.m.: I am on the cellular phone doing another "The president's not here yet, but here's what it's like at the

airport" live report, describing a jet streaking overhead, when Air Force One swooshes out from behind the terminal, landing from the south on runway 36-right. A decade of professional experience enables me to respond smoothly. I blurt, "Oh, there it is!"

I filled the minutes from landing to chocks-around-the-wheels talking about the president's plans to make a "major policy speech about college education financial aid." Congressman Glenn Poshard deplanes, Congressman Jerry Costello deplanes, the Commander-in-Chief, the Leader of the Last Remaining Superpower, The Big Cheese is next.

I'm painting a word picture for my listeners when a horrendous buzz sounds in my ear and I lose contact with the station.

The president emerges. I'm tapping buttons. The crowd whoops. I'm hitting buttons. The president waves. I'm pounding buttons. Applause drowns out the buzz. The TV reporters are all on the air thanks to their powerful microwave links. The Secret Service forbids me access to the compound so that I can get far enough from the source of the jamming to file my story. I fume, and swear never to trust another cellular phone.

Really gleaming

Then I take a good look at President Bill Clinton. He's the tallest person in sight. Politician's families crowd around for photographs. The presidential head forms the peak in the middle of the broods. It is not just the hair, either. He's huge. A recent vacation left him with a Wyoming tan. He's bleary-eyed. He probably got up early, too, but he carries himself erect and his suit is well tailored.

After working the crowd, Clinton folded himself into a gleaming black Cadillac limousine and was whisked away. I know that sounds like a cliché, but the limo

continued on page 13 ►

FCC Asked To Review EEO Policy

by Lynn Meadows

WASHINGTON The National Association of Broadcasters (NAB) and the Minority Media and Telecommunications Council (MMTC) urged the Federal Communications Commission (FCC) in separate letters last month to issue a proposed rule in the Equal Employment Opportunity docket.

The NAB request came on the heels of the Haley, Bader & Potts August petition to the FCC to review its EEO policy. HBP suggested that the review be held in light of the June Supreme Court decision that said "strict scrutiny" should be applied to all government EEO policies.

The letter also followed forfeitures of several thousand dollars levied against stations for improper recruiting practices. Because some of the stations had hired minorities, the NAB wrote that "the current EEO enforcement mechanism unduly emphasizes efforts over results" and "provides little clear guidance regarding how a station may be in compliance with the EEO rules."

MMTC was confident that the Supreme Court's Adarand decision would have no effect on FCC broadcast EEO jurisprudence. "We agree that expedition of the EEO docket is appropriate to clarify the state of the law," they wrote.

MMTC also asked the commission if paperwork burdens especially on small broadcasters could be reduced without impairing the effectiveness of stations' EEO efforts. MMTC also questioned whether the FCC enforcement process can be made more efficient yet still be effective.

MMTC urged "the commission to adopt a policy of zero tolerance for discrimination by designating for hearing any renewal applicant whose performance, and whose defense of its performance, suggests that racial stereotyping rather than merit drives its hiring policies and procedures."

The NAB and MMTC had recently held a series of meetings on EEO issues to find a common ground on recommendations to the FCC. ☐

INSTANT COFFEE INSTANT REPLAY INSTANT OATMEAL



ONLY ONE CAN PROVIDE THE FOLLOWING:

- Fast access of up to 1000 cuts of audio
- 50 "Hot-Keys" for immediate access
- 4 or 8 hour internal hard disk
- Handles jingles, effects, commercials and full length songs with equal ease
- D-NET high speed file transfer
- AES/EBU & S/PDIF Digital I/O
- 360 systems design and quality manufacturing
- All of above and more starting at **\$2995⁰⁰**

Please call today for full color brochure and ABG package pricing.

SOUTHEASTERN SALES OFFICE
200 Fareway Drive, Suite 2
Smithfield, North Carolina 27577
Phone: 800-369-7823
Fax: 919-934-8120

MAIN SALES OFFICE
2342 S. Division Avenue
Grand Rapids, Michigan 49507
Phone: 800-999-9281
Fax: 616-452-1652

WESTERN SALES OFFICE
P.O. Box 1638
Palmdale, California 93550
Phone: 800-858-8008
Fax: 805-273-3321

YOU MAY ALSO REACH US ANYTIME VIA ELECTRONIC MAIL
cServe: 75371,144
internet: support@abg.com



Circle (140) On Reader Service Card

Museum Celebrates Radio Anniversary

Twentieth Anniversary of Museum Marks First Year For International Festival and Evolutionary Plan

by Lynn Meadows

NEW YORK The first annual Radio Festival begins next week and runs through Nov. 3, at the Museum of Television & Radio.

Although this is the first year for the Radio Festival, 1995 marks the 20th anniversary of the museum itself. Last month, the Museum announced seven major initiatives that are designed to "revolutionize" the Museum's programs

for exhibitions, education, preservation and fundraising and expand the Museum's reach to a national and international level.

Foremost in the list of initiatives was the founding of an International Museum Council to promote the international preservation of programming.

The council held its inaugural meeting in Rome on Sept. 17. Representatives from several countries including Mexico, India, Luxembourg and China met with

Museum Chairman Frank Bennack Jr. and Museum President Robert Batscha as well as other representatives from the United States.

and creating an electronic Museum Shop by selling products through a partnership with QVC.

The Museum is also launching a "television preservation partnership" with "Nick at Nite" both to find lost programs and increase awareness of the importance of television preservation.

Seven major initiatives are designed to "revolutionize" the Museum's programs for exhibitions, education, preservation and fundraising.

International relations, world trade and global economics were discussed.

"The Museum formed the International Museum Council as a preeminent intellectual and cultural resource where ideas can be exchanged in an impartial forum and where information can be shared among the world's leading communications executives," said Bennack.

Also on the list of initiatives announced was the creation of new media associations to increase revenue and reach new audiences. These include launching a site on the Internet, making the Museum's database available on TV Guide Online

In another new initiative, General Motors is underwriting a University Satellite Seminar Series to expand the Museum's educational programs nationwide.

Batscha also announced a new exhibit that will open in March 1996 called Stand-Up Comedians. The exhibit will open simultaneously in New York and Los Angeles.

The opening of the Museum of Television & Radio in Los Angeles was the final initiative announced. The entire collection of radio and television programs will be available on both coasts come March of next year. 

Simply the World's Best Acoustic Foam

CLIENTS: AT&T, Sony, Kodak, Ford, Hitachi, Toshiba, Universal Studios, 20th Century Fox, Maury Povich Show, Warner Bros., Rockwell, U.S. Government, Bell Research Labs, Chevron, Editel, Opryland U.S.A., Pat Duke (Voice of McDonald's, Miller Beer), UCLA, Dennis DeYoung (Styx), Baldwin, Dick Ervasti (Voice of NFL on Fox), Music Bakery, Martin Marietta, Manley Labs...

Top broadcasters, engineers and facility designers know there's no better way to absorb unwanted sound than with the highest quality foam. Ultrax from Harris Allied is that foam.

You have too much invested to let undesirable reflections ruin your monitoring, recording or broadcasting environment. Ultrax works up to 60% better than that other stuff—and it costs a lot less.

Now, you can actually afford as much acoustic foam as you need! Let us help solve your sound problems.

1-800-622-0022
Fax 317-966-0623

 **HARRIS ALLIED**

©1995 Harris Corp.

Circle (27) On Reader Service Card

Marconi Award Winners

Legendary Station of the Year

KGO(AM) San Francisco

Personalities of the Year

Network/Syndicated:

Rush Limbaugh, "Rush Limbaugh,"
EFM Media

Major Market:

Jonathon Brandmeier, WI.UP-FM
Chicago

Large Market:

Bob Kevoian & Tom Griswold.

WFBQ-FM Indianapolis

Medium Market:

Jerry Carr, WMT(AM)
Cedar Rapids, Iowa

Small Market:

J. Douglas Williams
& Becky Myles,
KWOX-FM Woodward, Okla.

Stations of the Year

Major Market:

WBZ(AM) Boston

Large Market:

WFBQ-FM Indianapolis

Medium Market:

WHO(AM) Des Moines, Iowa

Small Market:

WHIZ(AM) Zanesville, Ohio

Stations of the Year by Format

AC/EZ:

KOEL(AM) Oelwein, Iowa

CHR:

WNNK-FM Harrisburg, Pa.

Country:

WSIX-FM Nashville, Tenn.

News/Talk/Sports:

WLS(AM) Chicago

Religious/Gospel:

KKLA-FM Los Angeles

Spanish:

KLOK(AM) San Jose, Calif.

Big Band/Nostalgia:

KEZW(AM) Denver

Classical:

WCLV-FM Cleveland

Jazz:

WNWV-FM Cleveland

Oldies:

WWSW-AM-FM Pittsburgh

Rock:

KROQ-FM Los Angeles

Urban/R&B:

WVEE-FM Atlanta

RF ENGINEERING SOFTWARE

dataworld[®]

authorized distributor of
EDX Engineering Software

- ◆ **SIGNAL[™]**
MSITE[™] and TPATH[™] package
- ◆ **MSITE[™]**
Wide area coverage prediction
- ◆ **TPATH[™]/RPATH[™]**
Point-to-Point Link Studies
- ◆ **International Terrain Data**
- ◆ **New Release:**
30 Meter US Terrain Data



Established 1971

800-368-5754 FAX: 301-656-5341
e-mail: info@dataworld.com
http://dataworld.com/

Circle (203) On Reader Service Card

Reporter Reveals All

► continued from page 11

really does gleam and it really does whisk.

I slammed my deadweight cell phone into my shapeless bag, limped out to my dusty van and rattled off in hot pursuit.

10:30 a.m.: No one will be allowed to gripe about parking at S-I-U in my presence ever again. I found a space in sight of Pulliam Hall without driving around for an hour. Keep in mind you can see Pulliam Hall from a long way away.

Chugging along the sidewalk, I leave grade schoolers, high schoolers, co-eds, grad-schoolers, faculty, staff, parents and grandparents in my wake. I anticipate being able to settle down when I get to the press area. When President Reagan gave his big drought speech up the road in Du Quoin in 1988, there were coolers loaded with soda. It was so hot I could have sat in one. I learned that day that loose-fitting clothes can save your life.

The magical press pass admits me through the gate at which others stood for hours without moving. I rant at my wife how a cellphone ruined my life. She comforts me: "Get a grip!"

I find my boss. She's on the edge of panic.

WCIL used one of the hundreds of phone lines installed on the Grassy Knoll to get sound from the event to the station, from where the sound was broadcast. The line worked on Sunday. On Monday, it was dead.

A Secret Service agent who was a dead ringer for Denzel Washington used his cuff to order a telephone man who never turned up. My boss called WCIL on the cell phone that popped out at the airport. The problem wasn't on their end. She decided we needed the Marti.

Big walkie-talkie

The Marti is essentially a big walkie-talkie, a short-range radio that transmits on a reserved frequency. WCIL uses it all the time for remote broadcasts from car dealerships and fairs. The Marti is as heavy as an anchor. I recruit an intern to be a yak and trek back to the van.

The intern lugs the Marti while I wrestle the spiky antenna and miles of thick cable through the metal detector. The good news is my boss figured out one of the wires in our telephone cable is broken. All we need is something to strip the wire and we're in business. The bad news is that the Secret Service made me leave my pocketknife at the gate for security reasons. My boss tries to bite off the insulation.

The good news is I recognized an engineer in the crowd who repairs the cable in short order. The bad news is that the Marti has become a hindrance. The good news is I've been exercising and can survive another round trip. When I wheeze back to the press gate, the Secret Service agents recognize me, smile, and wave me through.

Noon: Lesser Democrats filled the previous hour introducing each other and speechifying about the importance of college and financial aid. For the second time in his life, Clinton was early, arriving at the podium about 10 minutes before he was expected. WCIL's live coverage of the president's speech came off without any minor hitches. My boss had

one microphone. I had another. We analyzed the speech with penetrating insight.

Hindsight is 20/20

The president was interrupted by applause an average of once a minute, then stepped off the stage and into the crowd, shaking hands for longer than he spoke.

My reporter's instincts told me to keep the president in sight, just in case something happened. I turned around, lifted my leg high to climb the riser and heard fabric tear like a sail in a hurricane. The chief executive's safety tumbled from first place in my list of priorities as my briefs flashed into the

presidential Line of Sight.

It is as much a cliché to say "reporters are coarse" as it is to say "the president's limousine gleams." It is just as true. The best evidence I have that no one noticed the gash in my pants is that none of the national or local press corps pointed and howled with laughter.

Gathering the last shreds of my dignity and my clothes around me, I slung my shoulder bag as low as it would go on my backside. I carefully picked my way through the departing crowd without being arrested.

I beat the motorcade out of town, rushed home and clambered into a pair of indestructible jeans. My crotchless dress pants splayed all over the bedroom floor as I ran out of the house and back to the airport.

Air Force One needed every inch of run-

way 36-Right to take off. Exactly on time, it was "wheels up." Carbondale survived the first presidential visit since Harry Truman drove into town in a convertible with a single Secret Service Agent in 1948.

Early this spring, I fell in a swamp in front of the Lieutenant Governor of Illinois. It was a full-immersion baptism. Fighting down images of parasites in my orifices, I interviewed the second most powerful man in the state as black water ran out my pants. The Incident on the Grassy Knoll was a quantum leap of embarrassment.

It is time for me to get out of broadcasting. As long as I stay in this business there's a chance I'll get an exclusive, in-person, live worldwide broadcast interview with the Pope. There's no telling what might happen. ☹

One Very Popular Efficiency Expert

Tell most station staffs that you're bringing in an efficiency expert, and you can count on elevating heart rates faster than an IRS audit or the word "downsize." But, not to worry, because the Continental 814J 3.8 kW FM broadcast transmitter provides exceptional performance and efficiency without all the turbulence.

Recently, we've incorporated some improvements into an already clean design, enabling the 814J to operate at a power consumption level nearly half its previous rating.* Over the long haul, those savings will make the utility bills considerably easier on your budget. Couple the increased efficiency with

performance features like 100% solid-state components, self-protecting amplifier modules, automatic power output control, automatic power interrupt recycling, and the "Soft-Start"™ SCR circuit. Plus, the 814J is a single cabinet, completely self-contained unit, so required floor space is kept to a minimum.

If you've been looking for an efficiency expert that even the most nervous staff member can live with, call Continental and ask about putting an 814J to work for your station today.

Call 800-733-5011
*6.8 kW nominal at 3.8 kW power output. 5.95.105

814J 3.8 kW FM Transmitter

For nearly 50 years, Continental Electronics has provided excellence in broadcast transmission products worldwide. Refuse to compromise... call Continental first!

Continental Electronics Corporation
 P.O. BOX 270879 • DALLAS, TEXAS 75227-0879 • 214-381-7161 • FAX 214-381-4949

Circle (86) On Reader Service Card

CIRCUIT THEORY

Using Superposition to Analyze Circuits

by Harold Hallikainen

SAN LUIS OBISPO, Calif. So far in this series I have looked at various methods of DC circuit analysis. Those methods include Ohm's Law with differential voltages, Kirchoff's Current Law with node voltage analysis, and Kirchoff's Voltage Law with mesh analysis.

This time, I'll look at superposition. Superposition allows you to apply

these currents is zero, according to Kirchoff's Current Law.

If you solve this for V1 (and use a calculator to get rid of the fractions), you get:

$$0.545V1 + 0.1818V2 = Vn$$

This shows that Vn is a linear combination of V1 and V2. If you set V2 to zero and solve for Vn, you get Vn "due to" V1. If you then set V1 to zero and solve for Vn, you get Vn "due to" V2. If you add these two Vn's, you end up with the Vn when both voltage sources are present.

Setting to zero

What does it mean to "set a voltage source" to zero? Let's look at the definition of a voltage source, an ideal voltage source.

Such a source would have the same voltage across it no matter how

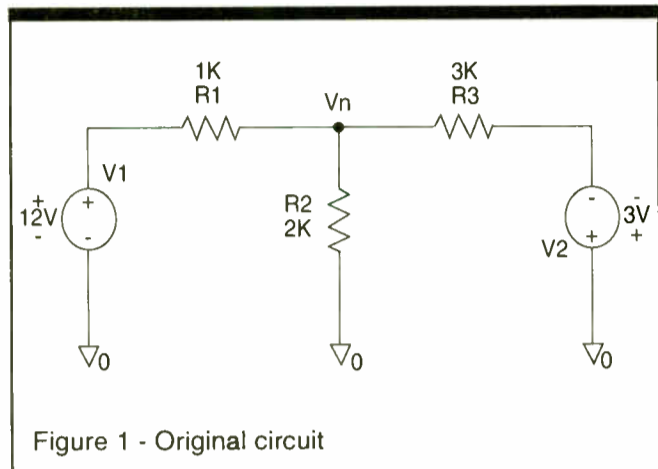

Figure 1 - Original circuit

sources one at a time to a circuit and determine the circuit parameters for that one source. To determine the circuit parameters when all sources are present, you sum the individual parameter values that you obtained when each of the sources were present.

Why does this work? If we apply node voltage analysis to the circuit of Figure 1, we get:

$$\frac{V1 - Vn}{1k} + \frac{0 - Vn}{2k} + \frac{V2 - Vn}{3k} = 0$$

I simply added the currents into the junction of R1, R2, and R3 using "differential Ohm's Law," with the voltage at the junction being Vn. The sum of

much current passes through it. Does an open circuit qualify? It does indeed have zero volts when no current is passed

through it (or no attempt is made to pass current through it), but any attempt to pass current through it results in a nonzero voltage across it.

In fact, an open appears to be an ideal current source with the current set to zero (no matter how much voltage you may apply, the current remains constant at zero amperes).

A short circuit, on the

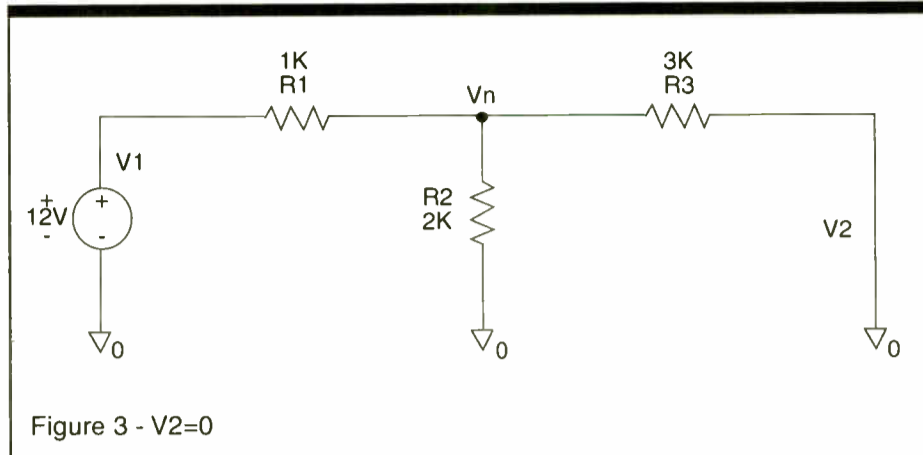

Figure 3 - V2=0

other hand, does act like an ideal voltage source where the voltage is set to zero.

Therefore, to guarantee that V1 or V2 is set to zero when applying superposition, replace the voltage source with a short circuit, which is really a zero volt source. If the circuit had any current sources, you would replace them with open circuits, which are zero amp sources.

Set V1 to zero volts

Set V1 to zero volts by replacing V1 with a short, as shown in Figure 2. This places R1 in parallel with R2, yielding 666.667 ohms for the parallel

combination. You can then find Vn using the voltage divider formula as:

$$Vn = \frac{666.667}{666.667 + 3k} \times (-3V) = -545.5 \text{ mV due to } V2$$

Set V2 to zero volts

Set V2 to zero volts by replacing it with a short, as shown in Figure 3. This places the 2k and 3k resistors in parallel to ground, yielding 1.2k for the parallel combination. You can then find Vn using the voltage divider formula as:

$$Vn = \frac{1.2k}{1.2k + 1k} \times (+12V) = 6.5455 \text{ V due to } V1$$

Add the results

To find the voltage at Vn, add the two results calculated above, which yields +6.000 volts, which agrees with the solution you got for this circuit in previous months. Knowing the voltage at this one point, you can calculate all currents using "differential Ohm's Law."

Superposition can be used to calculate any voltage or current in the circuit, though it cannot be used to calculate power in a circuit (because power is not linearly related to voltage or current). Although superposition can be used to calculate currents in multi-source circuits, it is quite easy to lose track of current direction and sign.

I, therefore, suggest superposition be used to calculate voltages with respect to ground (instead of voltages across components, where keeping track of polarity can again become confusing). Once voltages at all circuit nodes are known, any required currents or differential voltages are easily calculated.

Next month I will continue to look at this same circuit (analyzing it to death!), this time using Thevenin's Theorem. Stay tuned!

□ □ □

Harold Hallikainen is president of Hallikainen & Friends, 141 Suburban Road, Building E4, San Luis Obispo, CA 93401-7590; a manufacturer of transmitter control equipment since 1974. He teaches at Cuesta College and is an avid contradancer. He can be reached at 805-541-0200 (voice), 805-541-0201 (fax), E-mail at hhallika@slonet.org or on the World Wide Web at <http://slonet.org/~hhallika/>

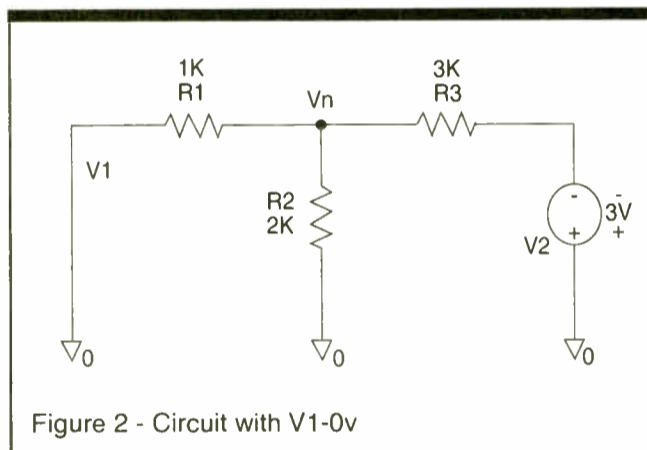

Figure 2 - Circuit with V1=0v

Analog & Digital A2-D The affordable instrument
Audio Measurement System
Designed to meet the challenges of tomorrow's testing needs

- Analog & Digital Generator and Analyzer
- User friendly front panel
- Stand-alone or remote control via RS-232 or IEEE-488
- Portable

We set the standard in making audio testing AFFORDABLE

NEUTRIK AG, Leuchtenstein, Tel: 075 1 237 24 24, Fax: 075 1 232 53 93
 NEUTRIK Instrumentation, USA / Canada, Tel: 0514 344 5220, Fax: 0514 344 5221
 NCY, Germany, Tel: 0941 98041, Fax: 0941 99 97 72
 NEUTRIK UK, Great Britain, Tel: 0983 811 441, Fax: 0983 811 439
 NEUTRIK Zürich AG, Switzerland, Tel: 01 734 0400, Fax: 01 734 3891

CONNECTING THE WORLD

Circle (170) On Reader Service Card

World Radio History

Step into the Future

If your on-air system is a little out of date, step into the future with Gentner and Harris Allied— your total audio conferencing solutions.

Gentner's TS612 simplifies the process of bringing callers together by putting the controls right at your fingertips. This means a smoother on-air sound with an audience less likely to switch.

The control surface is easy to use. It looks, operates and even feels like an ordinary business telephone.

But it's far from ordinary.

On-air talent can screen a call, transfer it from the handset to on-air, conference as many as four callers together, and lock in a VIP guest.

Thanks to multi-color line status indicators the user can instantly tell who's on the air, on hold, screened or talking to the producer in the other room.

Installation is a snap.

The TS612's dual superhybrid technology provides crisp, clean caller audio with much more flexibility.

With Gentner's SCREENWAIR software and a PC, a screener uses a keyboard and a headset instead of a control surface, and preselects calls for on-air, adding names, comments, city of origin and other information. An additional monitor is placed in the studio where the talent can see who is on screened hold.

NETWORK INTERFACE lets you expand the TS612 system into multiple studio configurations by adding a Network Interface for each mainframe. This provides the communications link between studios for proper management of 12 phone lines.

 **Gentner**
TS612
Multi-Line Telephone System



TeleHybrid
Telephone Hybrid

Telephone calls for broadcast teleconferencing and pro audio applications are made easier thanks to Gentner's TeleHybrid. Simply connect it to your existing telephone to deliver full duplex audio to your console or conference system without the fear of echo or feedback.

The TeleHybrid is the key to simple, great sounding telephone calls on your professional audio system.

Your telephone can be single or multi-line, analog or digital— the TeleHybrid doesn't care. The only requirement is that your telephone have a detachable handset with a modular connector.

The TeleHybrid "installs" between your telephone and its handset. Audio connections

to your equipment are made with XLRs.

With the TeleHybrid, the hassle and expense of dedicated phone lines are a thing of the past. Your regular telephone system becomes your "on-air" system. Anyone in your facility can screen a call or transfer it to the studio or boardroom. Best of all, the TeleHybrid is very affordable.

The future is with Harris Allied for your total audio conferencing solutions by Gentner..

1-800-622-0022 FAX 317-966-0623

 **HARRIS
ALLIED**

Sputnik Signal Captured for Radio

by Chuck Crouse

KANE, Pa. Radio people who routinely receive material via satellite feeds may be interested in the story relating the first time a radio station in the United States picked up audio from a satellite. It involved what was then high-tech, plus a lot of luck.

The Soviet Union launched Sputnik I on Oct. 4, 1957. The

satellite itself was primitive by today's standards, and the beep ... beep ... beep signal it transmitted contained no data. But it sent shock waves throughout the Western World.

WERE-AM-FM in Cleveland was in the habit of transmitting public affairs broadcasts over its otherwise underutilized FM signal. The station had arranged to broadcast an important United Nations debate by installing a

program line to the home of one of its engineers.

The engineer, Joe Zelle, was an

up the shortwave transmissions of United Nations Radio.

Zelle is also the son of

Satellite itself was primitive by today's standards.

accomplished ham operator (W8FAZ) and could easily pick

Slovenian-born parents, and is fluent in a number of Eastern

European languages, including Russian.

In the hours after Sputnik I went into orbit, Soviet news reports to the West were very sparse, and contained little information other than that the satellite was transmitting signals from orbit. Zelle learned of the launch through his sister, who had heard of it on a radio newscast.

Swinging into action, Zelle tuned to Radio Moscow, and heard a broadcast that specified the frequency being used by the satellite. He then tuned to that frequency, and found the satellite's beeps coming in loud and clear. Then he connected the output of his shortwave receiver to the broadcast line to the station and telephoned the WERE control room, only to find that the line had been disconnected. So Zelle rushed a tape of the beeps to the studio, arriving around midnight. Newsman Ken Courtright wasted no time in putting the signal on the air.

Because no other station — or network, for that matter — had precisely that collection of capabilities, WERE had an exclusive. But in the intervening 38 years, much of what was considered esoteric at the time has become part of the workday world of radio broadcasters.

□ □ □

The author was on the engineering staff of WERE at the time of the event described. He now owns WLMI(FM) Kane, Pa.

Move Up from Carts to Touchscreen Digital Audio

Play Any Audio at a Touch

Nothing else makes radio as fast or easy as having all your spots, sounders and sweepers start with your fingertip—**always on-line and ready** to play from hard disk. And **nothing else** makes your station sound as good or as exciting as touchscreen digital and creative talent with the **new Scott Studio System!**

Here's how it works: Six buttons on the left of the 17" computer touchscreen play what's on your program log. Scheduled spots, promos, PSAs and live copy come in automatically from your Scott System Production Bank and your traffic and copy computers. You see legible labels for everything, showing full names, intro times, lengths, endings, announcer initials, outcues, posts, years, tempos and trivia. Your jocks can rearrange anything easily by touching arrows (at mid-screen), or opening windows with the entire day's log and lists of all your recordings.

On the right, 18 "hot keys" start **unscheduled** jingles, sounders, effects, comedy or promos **on the spur of the moment**. You get 26 sets of 18 user-defined instant "hot keys" for your jocks' different needs.

Large digital timers automatically count down intro times, and flash at 60-, 45-, and 30-seconds before endings. You also get countdowns the last 15 seconds of each event.



The Scott Studio System is your **best** way to make the move to digital audio and eliminate troublesome carts. Each button on the touchscreen plays whatever you want instantly. All scheduled spots, jingles, promos and scripts come in from your traffic and copy computers.



The World's Fastest Playback!

Touch either of the two buttons at the top right of the main screen to see our "Wall of Carts" with all your audio **on-line!** Touch the sound, spot, jingle, promo, PSA or comedy you want and it plays **instantly**. Or, you can put it anywhere you want in the day's schedule. Audio is displayed any five ways you like.

The Scott System also gives you a "Make Good" button so it's quick and easy to reschedule missed spots or promos.

Instant Requests from Hard Drive

Our most popular option is a 9 gigabyte disk with digital music. The audio quality of the Scott System hard drive meets or beats the best CDs. We'll pre-dub **1,000 songs** from CDs off **your playlist free!**

Nothing is faster than requests from the Scott System! You get five "Wall of Carts" with music that plays at a touch! Songs are displayed by title, artist, year, length, category, or any ways you like.



Live Copy On Screen

Live tags, weather, promo copy, music trivia, contest copy and winners' lists automatically pop up on your Scott System's screen.

The Best Digital Audio

When spots, promos, PSAs, or any other digital audio events are recorded, they're immediately playable in **all** your Scott System air studios. Nobody wastes time carrying carts down the hall or redubbing spots for additional stations.

One question you **don't** have to worry about with the Scott System is "What if it breaks?" The Scott Cart Replacement System comes complete with **every** spot and jingle stored **redundantly** on **two** hard disks with a **split-second** switch to the "hot standby" computer and its own backup audio outputs! You get touchscreen convenience, digital quality, and backup redundancy for no more money than cart machines and commercial carts.



Sound Better With Digital Editing

Scott Systems' graphic waveform editors work wonders with phone calls in the air studio and creative spots and promos in production.

Your Best Investment

The Scott System **leads the industry** with the biggest broadcast groups like Shamrock, Alliance, Salem, Saga, Liggett, Regent, Tichenor, Heftel, Waterman, Max, Atlantic, and Rawlco in Canada. Our major markets include Detroit, D.C., Dallas, Miami-Ft. Lauderdale, San Diego, Denver, Oklahoma City, San Antonio, and others large and small from Bangor to Bakersfield.

Scott Studios Corp.
13375 Stemmons Freeway, Suite 300
Dallas, Texas 75234 USA
800 726-8877
(800) SCOTT-77

MOVING?

Don't leave us behind!

Mail or fax your current label and new address (with effective date) to: Circulation, RW, PO Box 1214 Falls Church, VA 22041

or FAX 703-998-2966. Address changes will be processed within four weeks of receipt.

Thanks!



out there

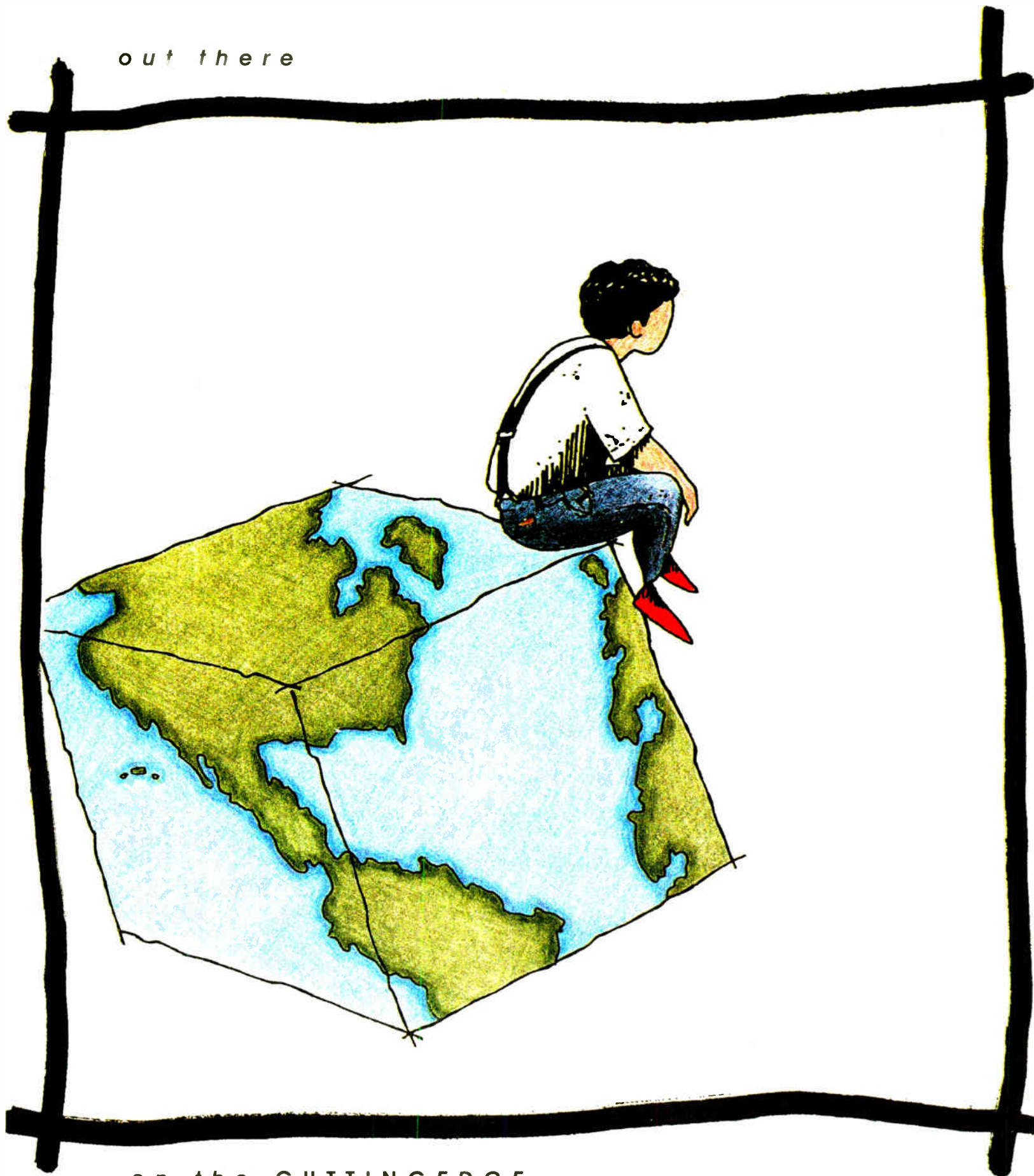

on the CUTTINGEDGE



change the way your listeners **think**

unity 2000i fm & unity am
broadcast processors



CUTTINGEDGE

With Instantaneous Access To 1,000 Cuts, This Could Be The Only Other Accessory You Will Ever Need To Buy.



Sure, go ahead. Put your feet up.

Because with Instant Replay's® fast radio, TV, live shows, sports events and work couldn't get any easier. Just push one of the 50 Hot-Keys and get immediate playback of your stored music, sound effects or spots—in stereo, with superlative quality.

cueing of audio for post production, your

50 Hot-Keys and get immediate playback of your stored music, sound effects or spots—in stereo, with

Instant Replay is completely self-contained, sports a four or eight hour hard drive, and stores up to 1,000 cuts. There's no limit to the length of any cut, and

no waiting for floppy disks to load. Professional features such as sample rate conversion, analog and digital I/O, automatic head trims, and even a printer port make this machine very agile and genuinely easy to use. *Best of all, it's only \$2,995.*

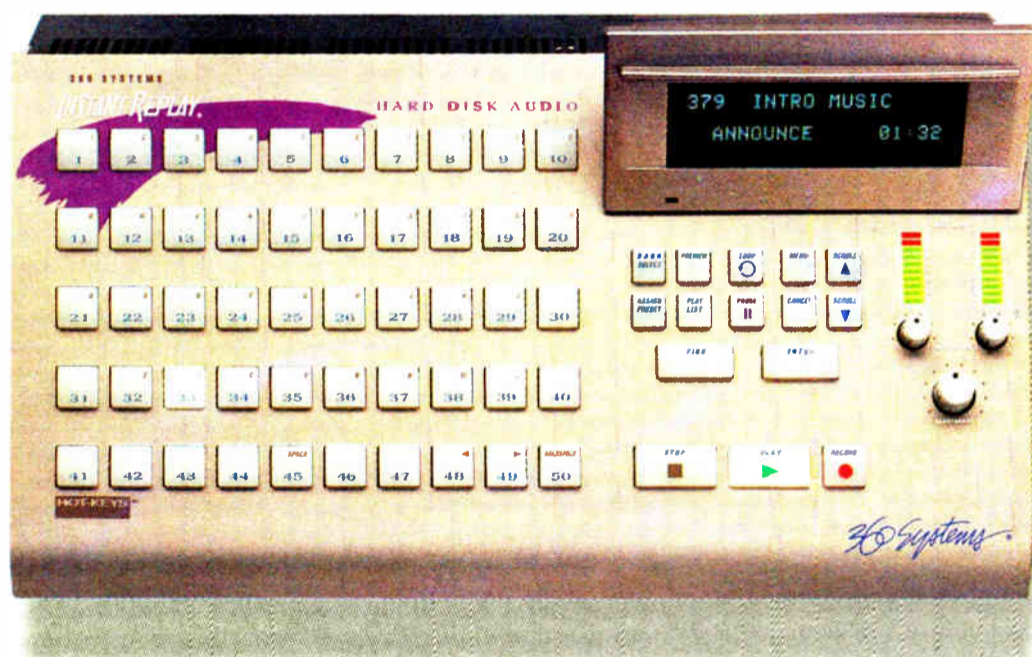

Instant Replay, the Hard Disk Audio Player

Instant Replay is a new breed of digital audio player—especially designed for people in a hurry. Call 360 Systems today and arrange for a quick demonstration at your facility.

Easy chair optional.



PROFESSIONAL DIGITAL AUDIO



5321 Sterling Center Drive Westlake Village, CA 91361 USA Phone (818) 991-0360 Fax (818) 991-1360
360 Systems, Instant Replay and Hot-Keys are registered trademarks of 360 Systems ©1995. Eames® Lounge Chair and Ottoman courtesy of Herman Miller, Inc. 800-646-4400

Circle (48) On Reader Service Card
World Radio History

Beware of So-called PC 'Experts'

by W. C. Spenn

SAN ANTONIO I could sense the desperation as I was welcomed warmly at the door. It was less than what I had encountered when I reluctantly answered the ringing phone at the office well after midnight.

Their computer suddenly started acting "weird" in the middle of producing a major project due later that day. Not wanting to make a service call, and hearing the bed calling my name, I quoted an exorbitant after hours rate. When that didn't stop them, I required a credit card number, in advance, with faxed verification before I would go to the customer site.

You really don't know what's happening these days, especially in the middle of the night. The FAX verification showed and the credit card cleared the verification, so I headed across town. Inhaling coffee and evaluating the situation during my travel time, virus kept intercepting my logic trail. So, I decided that was my starting point.

Starting point

I booted the computer on a known, virus-free diskette, and started the anti-virus software with the latest anti-viral information. It didn't find anything. I started another anti-virus software program, also with the latest anti-viral information. It didn't find anything either.

The next logical path pointed to hard disk problems. The first disk repair only found some minor problems, but nothing that would cause any real disk problems. I didn't fix the problems to see if I got the same results using another disk repair program. With the same results encountered, I allowed the program to repair the disk, and verified the repair with the other program.

The next logical step still involved the hard disk. Was it failing? I started a surface verification. No bad sectors found, but the disk looks suspiciously full. A directory command shows less than half a megabyte of free disk space. The directories on the disk didn't yield any large temporary files. I did delete some smaller ones, but that only recovered a few thousand bytes. While searching and deleting, I also kept a rough estimate of the directory totals to compare with the disk size indicated by the disk repair programs.

Even estimating file size high, I determine only 25 percent of the disk should be filled. Something was mysteriously occupying 75 percent of the hard disk.

Unbelievable files

Because it didn't look like a virus or a physical disk problem, I decided to optimize the disk by defragmenting the files, before starting the computer from the hard disk. In my caffeine heightened state, I almost fell off the chair. The defragmentation program showed three-fourths of the disk to contain nonmoveable files — unbelievable!

With the disk optimizing in operation, I had time to reflect and dig through my diskette case for my special system and hidden file finder program. The Windows permanent swap file (386PART.PAR),

showed on the screen almost before I took my finger off the ENTER key. Its file size was over 300 megabytes. Looks like a Windows problem. Time for Windows diagnostics.

The Windows diagnostics didn't ferret out any problems. A quick visual look at the Windows system files, verified the diagnostic results. After assuring Windows would not start automatically, it was time to start the system from the hard disk.

The computer starts as it should from the hard disk. I do another quick check of the hard disk. Things still look fine. Even Windows starts with no errors. The icons are sparse, with only an additional office suite icon. This matches the disk structure and initialization files.

Now it is time to look at the 300MB permanent swap file. Yes, Windows is configured for the huge swap file. However, when I reduce the size to 50MB, which I feel is still exceptionally large, my client opens his mouth and informs me that the permanent swap file had to be at least 100MB

for his system to work correctly. He knew this

because he had read it in a computer magazine article, and it had been verified by his regular computer expert.

I quickly changed the swap file size to 105MB and restarted Windows. Almost 200MB of disk space are now available. I now ask the client to run his programs to see if he still has problems.

Up and running

I hang around for another 10 minutes. Everything works fine. He is very happy and gladly signs the credit card slip and invoice. I walk out of the door with a lot of his money, and he is still overjoyed. I just want to get home and get some sleep.

The next morning, as the alarm kept probing into my consciousness, the night before didn't seem real. The signed invoice was still there. So I had to find out if I had missed something. I try to keep up with the latest computer stuff, but a minimum 100MB permanent swap file for Windows on an 8MB Random Access Memory (RAM) machine running a basic office suite, did not come from any part of my memory.

I pick up the phone and call my expert consultants. Three qualified consultants reinforce what I feel. A 50MB permanent swap file is more than sufficient for operations. In fact, a file about half the size will amply function for most program configurations. The unanimous consensus is to add more RAM, if the customer didn't want the programs swapped out of memory.

Later, I got a call at the office, from the customer, thanking me, most profusely, for my time and help. His presentation went well and he got the bid for big bucks. His regular expert, whom he mentioned by name, was back in town. In fact, they were installing a much larger disk later that evening, to get back the huge swap file. I casually asked about the size of the new swap file on the larger disk. "I want it to

be at least 400MB," he replied. I researched it. His nonexpert expert had been a bank teller less than 18 months previously.

Digging deeper

After the above incident, I decided to contact more real Windows experts to seek their opinions on swap files. For a standard Windows system with 8MB of RAM, only one had encountered an instance in over 10,000 installations that required a swap file larger than three times the RAM size, and it was a very special case. Specifically, for the above incident, most of the experts questioned the need for a permanent swap file.

The basic expert consensus was don't waste valuable disk space for a larger than necessary permanent swap file.

In another instance

Another situation occurred when all the Local Area Network (LAN) cabling firms I had recommended to a client were too expensive. He was going to use his telephone firm to do the LAN cabling at less than half the price. Not a problem for me. When the cabling is completed, fax me a certification that the cabling is completed, working, clearly labeled, and all parts meet Level 3 (Ethernet 10 base T 10 megabits per second unshielded twisted pair(utp)) or greater certification requirements for the specified LAN.

Only then, will we install the network

cards and file server. However, any cabling problems we have to troubleshoot are billable at our exorbitant after-hours rate. It is not a problem for my client. He will save big dollars.

I check out the telephone company in the phone book. It has a nice ad touting its network cabling. Maybe I have another cabling company when scheduling gets tight.

I get a telephone call and a fax certification. The cabling is complete and ready for LAN installation. I arrive at the site with the file server and network interface cards (NIC). None of the cables are labeled at either end. I notify the owner. The money time clock is running, and the cash register just rang.

I receive another telephone call and fax certification. The cabling is complete, labeled, and ready for LAN installation. The file server and the LAN NICs are already at the site. I install a NIC in the first workstation and test it, using a short jumper to connect it to the file server. I move the workstation to its prescribed place and connect it to cable number one.

Problem with cabling

The workstation cannot communicate with the file server. I dig out my multipurpose cable tester. I test the jumper first. It looks fine. Now to check out cable number one. The tester indicates a reversed pair. The owner doesn't believe my tester, so I dig out my heavy duty tester. It indicates the same problem. The money time clock starts running again, while I wait for the telephone firm cabling to arrive and look at the cable.

continued on page 22 ▶

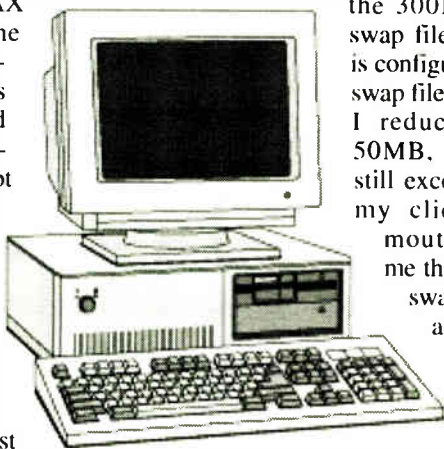

The FM Series

SWR's FM antennas, ranging from educational series to multi-station antenna arrays, are highly customized to meet broadcasters' needs.

Options

- Circular, horizontal, or vertical polarization
- Beam tilt
- Null fill
- Customized directional patterns

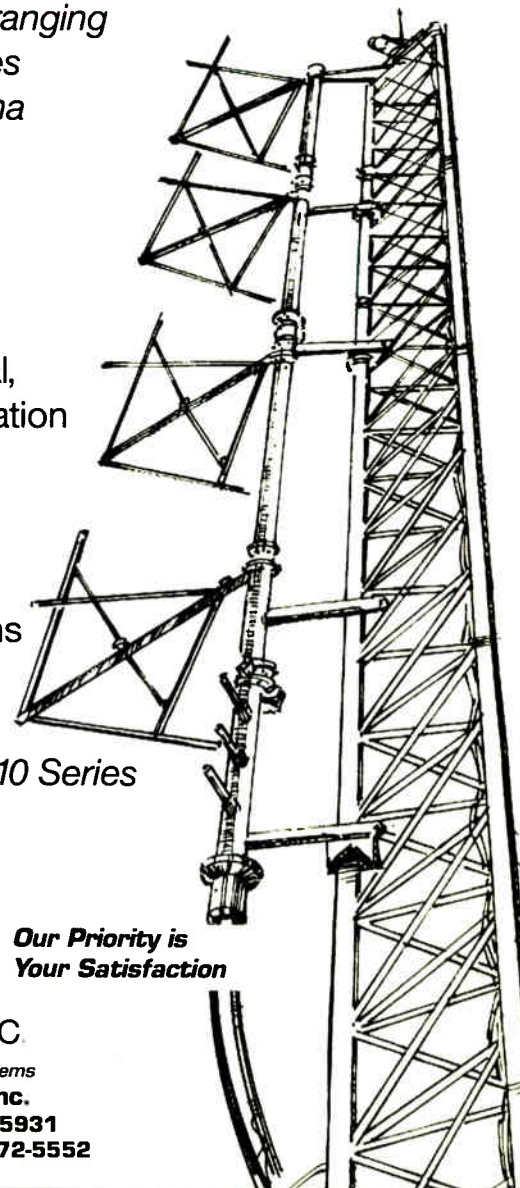

The FM10 Series

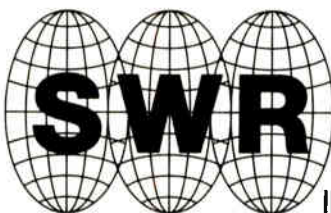

INC.

Our Priority is Your Satisfaction

Antennas and Transmission Line Systems
Systems With Reliability, Inc.
 P.O. Box 856, Ebensburg, PA 15931
 1-814-472-5436 FAX 1-814-472-5552

WORKBENCH

Resistor Color Code Contest Lives On

by John Bisset

SPRINGFIELD, Va. Got a fax from Leo Galletta, network operations manager at the Bible Broadcasting Network. He inquired about where he could find a mnemonic (memory aid) for the resistor color code.

Clark Wire and Cable has been holding a contest for the past several years, awarding cash prizes for the best entry. First place went to Steve Hill of E-

Systems: Booboo Bear Reports Old Yellowstone Geysers Burp Vicious Gulps of Water.

Second place was awarded to Pam Webb of Pause Productions for: Blushing Brides Ravishing Over Young Grooms Become Very Good Wives. An Honorable Mention went to the gang at KCBS(AM)-KRQR(FM) in San Francisco. One of their entries sounds like a play on that Holiday song, "Grandma Got Run Over By a

Reindeer." Their submission: Bowling Ball Rolls Over Your Grandma, But Victim Gets Well.

For information on the 1995 contest, give Susan Clark (President) or one of the other folks at Clark Wire and Cable a call at 1-800-CABLE-IT. Their Lavender/Red (Left/Right) stereo audio zipwire still remains a favorite — and the colors ensure you'll never mix up left and right again.

★ ★ ★

In this age of computers, it is real easy to forget about equipment like the UPS. BEST Power Technology does a pretty good job of sending battery replacement reminders to its customers. If you have moved, however, or don't have a BEST UPS, check with the manufacturer about battery replacement intervals.

For the FERRUPS series that BEST manufactures, batteries become unreliable after three years and should be changed. If you have questions about battery replacement, call Mike Woodmansee, BEST Battery Specialist, at 1-800-356-5737, Extension 7325. For faster service, have your UPS power supply serial number handy when you call.

★ ★ ★

The Fall show was a good time to renew industry acquaintances and update your rolodex. Here's another name change: Phil Blyveis, formerly with Audio Advantage, and famous for servicing Studer, Fostex, and Tascam equipment has joined TREW Audio. Phil will be in charge of the service department, and can be reached at 615-256-3542. His fax is 615-259-2699. TREW Audio is located at 45 Willow Street, Nashville 37210.

If you own Studer equipment, you'll find Phil's encyclopedic knowledge of the problems and quirks in servicing these machines priceless. In addition to providing service, TREW Audio will also sell repair parts.

★ ★ ★

Frank Folsom does contract work around Knoxville, and has inquired about modification information for an AVCOM EBS-300 EBS system. This is not the AVCOM located in Richmond, Va., which was my first thought. If a reader has any modification information, or knows how to contact the company, fax the information to *Workbench*, or leave it for us on America On Line.

★ ★ ★

It was only a matter of time before a coaxial wall entry system was combined with a grounding arrangement to reduce lightning damage. Andrew Corp. now offers a new ArrestorPort-Plus. This system consolidates the entry port with a rubber boot, and a ground bar to provide reliable protection against lightning strikes. Compared to conventional systems, the total component count is reduced, installation time is reduced, and the frustration of dealing with multiple vendors is eliminated.

Perhaps the best feature is the price,

which can vary from 30 to 75 percent less than conventional systems. Andrew has a free brochure and information bulletin on the product. To get your copy, call 1-800-255-1479, extension 67. Ask for bulletin 3625.

You can also circle **Reader Service 144**.

★ ★ ★

Now is a good time to seal up AM ATU boxes and buildings for the colder weather. Arm yourself with hornet spray and a box of mothballs for snakes. After sealing entry holes, drop a handful of mothballs on the floor. Snakes hate the smell, and will find shelter elsewhere.

We (at Multiphase) did some work a few years back on a little AM located in a swamp. The coax lines ran through big holes cut in the wall, over the top of the transmitter and into the phasor. Words cannot explain the reaction I had when the "moving 7/8-inch coax" proved to be a black snake.

I don't think it was the fear of the snake so much as it was knowing I hadn't been alone in that transmitter room for several hours! Moth crystals will work too, though the mothball will last longer. As they evaporate, replace them, and your problem will disappear.

★ ★ ★

If you service Otari reel machines, you know that the plastic feet that screw into the back of the machine must be removed to open the back panel. Bud Aiello at NPR passed on a tip that will prevent your machines from running at 85ips backward. As you disassemble the machines, note the bolt lengths. There are two different length bolts, and if you mix the bolts up, putting the longer bolts where the shorter ones should be, the additional length extends to the PC board.

The bolt took out the Low Voltage power supply fuses, and will result in the machine running backward at a very high rate of speed.

★ ★ ★

Next time you need a power supply for a project, don't build it — take a trip to your local thrift store. Goodwill Industries, the Salvation Army, and others run secondhand stores with electronics departments. As you can imagine, these groups get a lot of junk donated to them, VCRs, CD players, radios, etc. Every one has a power supply. You may be able to get the trashed equipment for free. At the very least, for only a few dollars, you can pick up the secondhand equipment and reuse the power supply.

RW's Alan Peterson has saved plenty on projects by using the secondhand supplies. We appreciate his sharing this tip, though his boss assures me he will not be receiving an honorarium for his submission! Hey, Al, it can still be used for SBE certification credit.

□ □ □

John Bisset is a principal with Multiphase, a contract engineering and special projects company based in Washington. He can be reached at 703-323-7180. Fax submissions for the Workbench column to 703-764-0751. The Workbench column can be reached on-line at wrwbench@aol.com. Printed submissions qualify for SBE Certification credit.

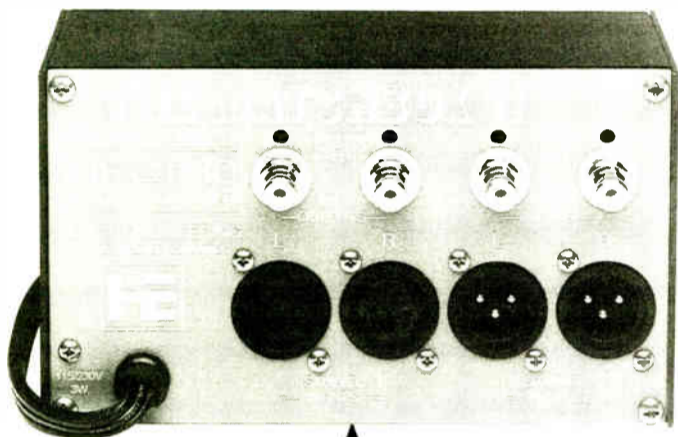

Balancing Box.

The Matchbox II is Henry Engineering's new version of the industry's most popular level and impedance converter.

Now it's even easier for you to use digital editors and computer sound cards with new user-programmable gain to properly match the low level outputs of these units. Matchbox II instantly brings your levels up to +4dbm, 600 ohm balanced lines.

All outputs are now adjustable, with four level controls for quick and accurate setup.

The dynamic range is increased to provide superb audio. And the best quality gold-plated RCA connectors are added for ultimate reliability.

All this and the price stayed the same. In stock and ready for immediate shipment from the broadcast pros at Harris Allied. Call us toll-free.

1-800-622-0022

Fax 317-966-0623

**HARRIS
ALLIED**

©1995 Harris Corp.

Circle (32) On Reader Service Card

World Radio History

Products & Services Showcase

For more information on the products shown below, circle the appropriate Reader Service No. (s) on the enclosed Subscription/Reader Service card or contact the advertiser directly.

S.C.M.S., Inc. Charlotte, N.C.

Low Prices – Experienced Staff
New and Re-built R.F. and Audio

THIS MONTH'S SPECIAL

WE'VE GONE DIGITAL!!

50% OFF ALL REEL TO REEL AND
MAB BROADCAST CARTS. EXCLUDES
3M, 996, 986 AND SPOT LENGTH
CARTS. ALSO 50% OFF ON ALL
DISCOUNTED HEADPHONES IN STOCK.

CALL FOR STOCK LIST!

— You Know We Know Radio —
Toll-Free 800-438-6040
FAX 704-889-4540

READER SERVICE NO. 179

Composite Audio DA and Switcher!



The CDS 200 Composite
DA-Switcher

APPLICATIONS

- Switching Between Composite STL's
- Main/Alternate Processing Switching
- Feed Two Transmitters and an RDBS Encoder
- Feed one SCA Generator to Two Transmitters
- Distribute Composite with the Ease of Audio

FEATURES

- 2 Input Switcher
- 3 Isolated Outputs
- Individual Level Control for Each Output
- Front Panel and Remote Control with Full Status
- Power Fail Memory with Bypass Mode
- Inputs Selectable for Balanced or Unbalanced Operation
- Front Panel Test Jack

bdi Broadcast Devices, Inc.
5 Crestview Avenue
Peekskill, NY 10566

Tel: (914) 737-5032 Fax: (914) 736-6916

READER SERVICE NO. 193

AXS (Ax'-sess)... Jocks Love It!

AXS is an entirely new approach to digital audio controllers. It starts with superb audio using the premium quality apt-X™ system. AXS is easy to learn, easy to use, and powerful beyond words.

AXS is a modular design that begins as a simple cart replacement and grows to any combination of CD, hard disk, satellite or specialty programming with ease.

AXS has all the sophisticated feature options including device independent multi-channel background audio record and replay. Macro programming makes tough to run event sequences easy. Software drives a powerful programmable real time IOMAP.

Jocks love AXS: A fast 99 page, 28 button Jock F/X panel that can be time linked and remote wired is standard.

Use a software driven four-channel stereo audio switcher with on-screen control or the powerful eight-channel dual-buss routing switcher, or include both if you wish. AXS is controlled through a trackball, touchscreen, keyboard, buttonbox, telco or remote modem.

AXS Systems...

From \$6000.00 using your 486 computers and hard disks.

READER SERVICE NO. 28



AXS

The Management

800-334-7823 • 817-625-9761
FAX 817-624-9741

P.O. Box 1-36457 Fort Worth, TX 76136
1700+ Stations • Our 14th Year

Can we make you

6db Louder?

(Probably not but...)

We can supply you with all
of your computer needs!

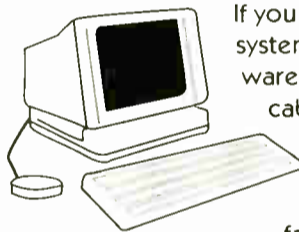

If you need computer systems, hardware, software, memory, modems, cables, etc... for ANY application (on-air, sales, traffic, etc.) at your broadcast facility... call us!

Broadcast
Computer
Distributors

1-800-670-2743

(And use the money you save to buy that new processor you've been wanting!)

READER SERVICE NO. 147



STAY ON THE AIR ...AND MORE!



Service & Affordable Quality for Over 23 Years

AUTOGRAM
CORPORATION

1500 Capital Avenue (214) 424-8585
Plano Texas 75074-8118 1-800-327-6901

FAX (214) 423-6334

READER SERVICE NO. 55

Shape Up!

Coverage. Saturation. DBk contours. In FM broadcasting, the "bottom line" is always based on your pattern.

More than any other manufacturer, Shively has the experience and reputation for providing crucial pattern solutions for critical propagation problems. On any tower. At any power level. Remember, *it pays to be heard.*

A good pattern. The shape you need. Talk to your consultant. And contact us.

Shively Labs

A Division of Howell Laboratories, Inc.

19 Harrison Road, Bridgton, ME 04009
207-647-3327 FAX 207-647-8273

READER SERVICE NO. 42

Call MYAT For Rigid Line & Components

Facing a "right now" emergency? Planning a new installation? Upgrading your facility? Whatever the need, MYAT is the solution. MYAT products are quality-built for maximum performance and long life. And we take delivery commitments seriously.

Call your favorite RF distributor or MYAT direct at 201-767-5380, or fax 201-767-4147 for our complete catalog and reference guide.



380 Chestnut St

P.O. Box 425

Norwood, NJ

0 7 6 4 8

READER SERVICE NO. 68

OFFBEAT RADIO

Start-up Services Challenge NPR

by Dee McVicker

PHOENIX It is quite possibly the most poignant sign of our times yet: National Public Radio (NPR) is getting competition. That, at least, is what Ed Graham of American Radio Network fame is hoping for as he gets things in place for Public Radio Service (PRS), a NPR-like programming service from Baltimore, that in January will go up against what some people call Congress' Anointed One.

Competition is healthy

He said he started PRS because he believes in competition to bring cost control and better programming to public broadcasting — and because he feels there is a programming void in the public market.

"A lot of major markets have three to four public stations, and only one can take NPR.

"There is no real network for the other ones. We also would like to be a little more full service than NPR, and have a different rate structure so we would be cheaper for stations," said Graham, who claimed the only other programming alternative for public stations is too much like NPR itself.

A nonprofit organization, PRS will actually launch two public programming services, one aimed at the African American public stations and the other for public stations in general. Graham does not plan to run the new channels on funds from the Corporation for Public Broadcasting (CPB), the mainstay of NPR's financing, and instead will be relying on private venture capital to start the services. "We have been applying for federal funding. We went through the Democrats and now the Republicans. Everybody says it's a great idea," he said, stating that even though the government gives money to the CPB to expand and diversify public broadcasting, he has been unable to gain access to federal financing.

Graham suspects the reason why is "they are afraid that if we can do something for less, somebody might look at NPR and say, 'Why are you spending all that money?'"

PRS will be relying on private venture capital to start the services.

PRS's annual operating budget is expected to be one-tenth that of NPR's he said.

For the general channel, PRS is targeting approximately 1,200 noncommercial stations, some of which have no national

programming service and some of which have nominal NPR service. For the small-market stations especially, cost will be a draw.

"We'll charge a flat rate based on market size. A station that might have paid \$200,000 (for NPR) might only pay \$60,000. Smaller stations will pay less." For the African American channel, Graham plans to address the needs of the significant African American markets, which number 39.

"Thirty-nine affiliates many not seem like much, but we are talking about New York, Chicago, Los Angeles, Washington, all the major markets," he said. "We

think we can reach 80 percent of the African American population within the United States with these 39 stations."

Graham is hopeful that eventually, a hundred or so more stations will join these market leaders. Not surprisingly, Graham, who started one of the nation's first 24-hour talk networks, will inject his commercial bent into the public services, in both approach and programming.

His commercial approach to public service is most apparent in PRS programming, particularly its emphasis on the geographically central corridor of America.

"We think NPR doesn't do any of that. I talked to a station in Oklahoma and they said if they had any other choice they'd take it, because they think (those at) NPR are Washington elitists," asserted Graham.

College stations

Graham also cited college stations as a
continued on page 70 ►

Beware of the Experts

► continued from page 19

Yes, he finally agrees that the plugs are wired incorrectly. I will return after another certification fax.

Another phone call and fax certification bring me to the site. This time I decide that I will test all the cables with my cable tester first. Only two cables work, using either tester. Some more charges, a very unhappy owner, and a wait for another certification result.

The phone call and fax certification again bring me to the site. This time, all the cables test with both testers. I install all the LAN NICs and test them using my jumper. When I ask the owner for his jumpers, he cannot find them. He calls the telephone firm. They will bring the computer to wall plate jumpers later in the day. I show the customer how to install the jumpers and how the network functions correctly with my jumper, and he is satisfied. My ear hurts from the loud yelling on the phone.

Yes, I would be over immediately. As soon as I reached the first workstation at the site, I knew the problem. The jumpers between the computer and the wall plate did not meet Level 3 specifications for UTP LANs. The jumpers aren't twisted. Running data tests with my cable tester and the LAN NICs, clearly show the jumpers to be the problem. Replacing the jumper with one of my proper jumpers eliminates the problem.

The customer receives another after hours bill.

Adding stations

The network is running fine. In fact, the customer is so happy that he confides to me that the LAN has already paid for itself in increased productivity. Now he wants to add two more workstations. The first workstation slips easily on the LAN. The second one works, but is very erratic.

At first I believe it is a bad LAN card, but changing the card and machines points to the cabling again. I hook up my cable tester, expecting a marginal cable, but the cable tests fine. Testing again produces marginal results. I try using my second cable tester. It also tests the cable as good. The only difference is the cable and its associated connectors. So, I replace a connector, and test the cable again. It tests good again, but this time there are no erratic results.

I found a bad connector. On a whim, I cut the suspect plastic connector in half and examine the crimp teeth with a magnifying glass, which reveals the mystery. The connectors are for stranded wire cable, so they won't work reliably with the solid wire cable installed.

All the LAN cable connectors must be replaced. The billing clock is running, and the customer is not happy. The cabling costs are now much more than if he had used one of my recommended cabling companies.

A few weeks later, I encounter one the cable installers at a local store and ask him about the cabling. During the course of our conversation, I find that, contrary to their advertising, my customer was the non-expert expert telephone firm's first LAN cabling experience.

The above situation is the norm, rather than the exception. Cabling is the bane of LAN installers. It doesn't matter if you do

the cabling or you use a cable installer, the following information should help you maintain your LAN cabling.

No. 1 problem

The number one LAN cabling problem is using the wrong or substandard parts for the job. Thin Ethernet on 75 ohm rather than 50 ohm coax is a mistake. Using a standard telephone wall jack for a level 5 (Ethernet 100 base T 100 megabits per second UTP cable) LAN will not work. You can use level 5 parts on a level 3 system, but not vice versa. Always use the correct, top quality, cabling parts ... no exceptions!

For any cable problem (coax and UTP), your first step is to physically examine each connector and cable for mechanical soundness. Mechanically loose connectors, sharp cable twists and blends, coiled excess cable, and tightly bound cable groups can cause random network glitches. For UTP, because it involves at least two pairs of wire, correct wiring is part of the physical inspection. Many times physical inspection will resolve nagging LAN problems.

Continuity does not necessarily mean you have a quality or working LAN cable. This is especially true with UTP. You can have continuity with one wire from one pair and one wire from another pair, but moving real data on these single wires can be another story. Good testers check continuity, pairing, pairing reversal and data transfer rates. Marginal transfer rates mean it's time to track down a mechanical or substandard parts problem.

A good cable tester is worth the money. In fact, I no longer maintain any LAN installation, unless a quality cable tester is part of the installation.

Remember, if you use the correct parts, tools and testers for your wiring requirements, your cabling problems will be minimal. Just don't forget to label the cables!

What makes an expert "an expert"? In my opinion, an expert has experience and knowledge in a specific field, stays current in that knowledge, knows where to look and who to ask to find answers and is not afraid to admit lack of knowledge. Am I an expert? I don't think so, but I do know where to look for answers.

□ □ □

W. C. Spenn is a networking and communications consultant for Dove Data Systems in San Antonio, TX. He has over 15 years of computer and communications experience, and can be reached at 210-656-8011.



... because you can't always trust your ears.

The Sentinel is a Station Monitor Receiver with all-mode reception: NRSC AM/AM-Stereo, FM/FMX™-Stereo and SCA. But what's more important, The Sentinel has built-in diagnostics that measure and display 12 separate parameters of the program audio signal.

With 24 station presets and well-defined readouts, even non-technical personnel can instantly compare their audio with anyone else on the dial for Peak Modulation, Relative Loudness, Dynamic Range, Spectral Profile and Stereo Image.

The Sentinel: see what your ears have been missing!

Inovonics Audio Recording, Signal Processing and Instrumentation
1305 Fair Ave., Santa Cruz, CA 95060—CALL (408) 458-0552 FAX 458-0554

Circle (76) On Reader Service Card

Mrs. Braverman's "Back to School" \$1000.00 Off Sale

They should be ashamed.

"Back to School", "Overstock Special",
"End-of-Season Clearance"...

Why can't they just say the truth?

You remember me - Daniel's Mother.
And this month, my son's company
wants to sell more consoles. So, he's
running a sale. A very good sale.

Call your dealer and tell him (or her) that
you want an RS-Series 12, 18, or 24
channel at a minimum of \$1000.00 off list
price.

Then, maybe you can buy some options
so that my son should make a little
money.



RADIO SYSTEMS INC.

Professional
Broadcast
Equipment

601 Heron Drive
P.O. Box 458
Bridgeport, NJ
08014-0458

(609) 467-8000
(609) 467-3044 Fax
(609) 241-0092 Fax-on-Demand
(609) 241-0093 BBS

Circle (124) On Reader Service Card

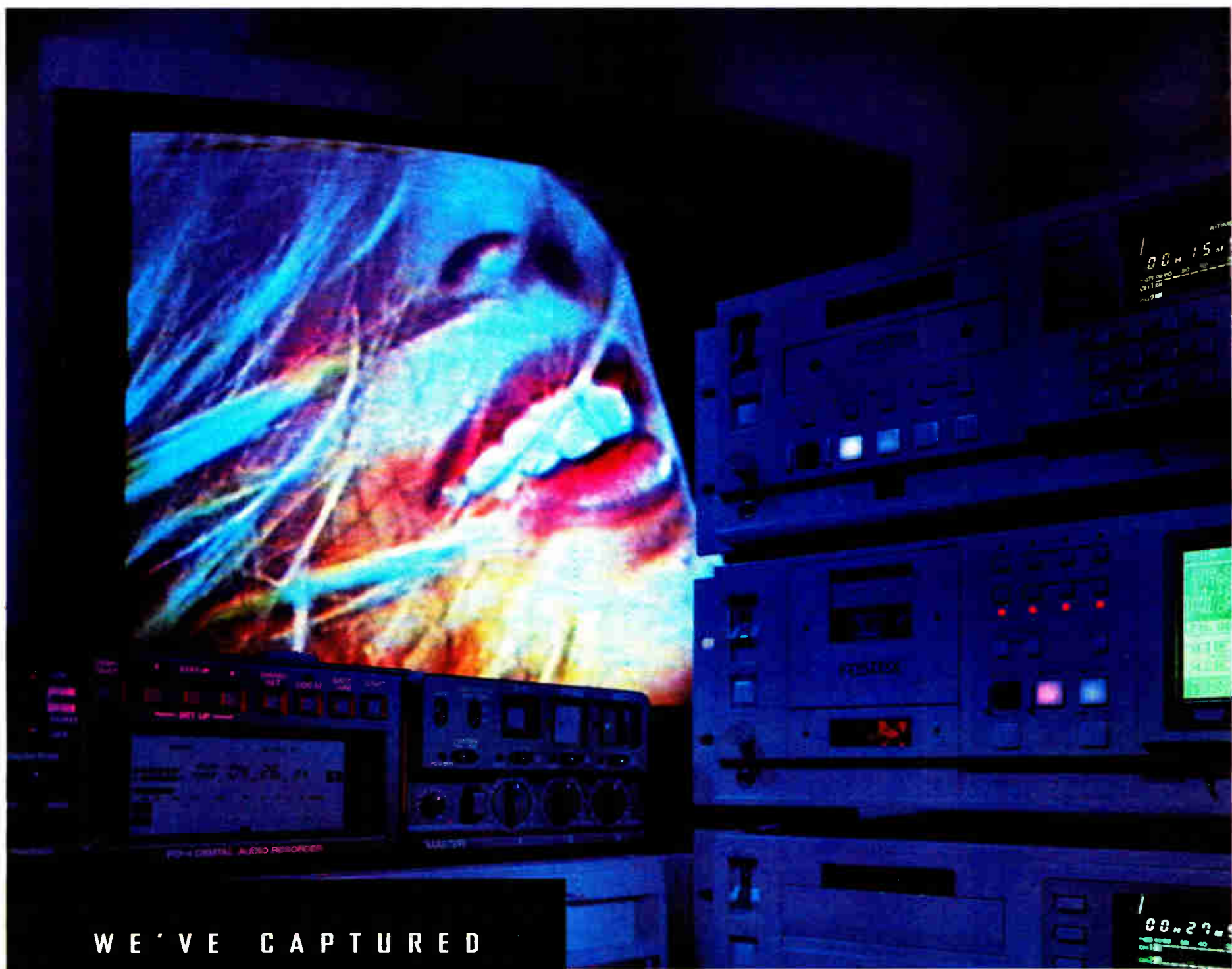

WE'VE CAPTURED
EVERYTHING FROM
CRASH CYMBALS TO
SEX SYMBOLS.

In this business timing is everything. Which explains some of the success behind our industry-leading lineup of SMPTE timecode DAT machines. Of course, mass appeal doesn't hurt either. So if you're looking for outstanding value, you'll find it in our **D-10**, the most affordable timecode DAT recorder on the market. If you need a full-function chase/lock machine, you'll appreciate our **D-25** with RAM scrubbing and Sony P2 protocol for serial editing control. Our **D-30** represents the pinnacle of DAT technology, with its remarkably user friendly nature and renowned intuitive display screen. If multitrack is the issue, our **RD-8** is the machine of choice. And when it comes to portable recording, nothing keeps up with our second generation **PD-4**'s unparalleled ease of operation and 3-channel mixer. Want to know more? Simply call Rick Cannata at **800-9-FOSTEX**. You'll see why— from music tracks to soundtracks—we've developed a following that stretches from Nashville to Hollywood.

Fostex



D-10 Production TC DAT Recorder



D-25 Studio TC DAT Recorder



D-30 Master TC DAT Recorder



RD-8 Digital TC Multitrack Recorder



PD-4 Portable TC DAT Recorder

Fostex Corporation of America 15431 Blackburn Avenue, Norwalk, California 90650, U.S.A. Telephone: (310) 921-1112 Fax: (310) 802-1964

Circle (36) On Reader Service Card
World Radio History

Running Radio

Your Resource for Business, Programming & Sales

Halloween Radio
Causes
National Panic
page 35

PROMO POWER

Exploit Benefits of Local Media

by Mark Lapidus

WASHINGTON "I'm in a unique situation. I don't have much of a promotional budget, but I really believe that marketing and promotions are very important.

"It is not that I don't want to spend the money ... it is just that in my market, you need a lot of cash to make an impact and I have not been able to budget enough to do the job."

Unfortunately, the above situation is not at all unique. I hear this same basic story year after year from general managers all over the country. In fact, the truth is that there are more stations without big promotional budgets than there are flush with marketing moola. So what is a station to do? Once again, creativity is the key.

Before we ponder zero budget promotion

and marketing, it is important that I state loudly and clearly that those stations that do not invest wisely in marketing for the long haul will not generally be the top winners. There are no substitutes for large television, billboard, telemarketing or direct mail campaigns. The ratings system relies heavily on top-of-mind awareness and those with a good product, the correct marketing message and focused advertising campaigns will win.

There is a reason why the top television spenders in any given radio market will typically be among the top five winners in their target demo. Advertising works!

It is ridiculous and hypocritical to say that outside advertising does not have much impact. If this were true, our own radio stations would not work for our clients. Let's face it: If we were able to buy advertising

time on other radio stations to promote our own product, we would do it. Just because other media work differently, they should not be rejected out of hand as some stubborn managers are apt to do.

Rather have money

Now that I've made it clear I would rather have the money to work with, let's move on to reality. Regardless of station ranking or market size, there will be those months when you just don't have the budget. The following techniques may work for you:

Trade: It is the most obvious answer and yet the frequently too easily dismissed solution to obtaining outside advertising. Your radio account executives will probably not like the concept because they may feel it will interfere with future cash orders. Account executives are not to blame. They just have a different (and vital) set of priorities. Have your sales person assist with the initial contact with a television station, newspaper, billboard company, direct mail house or other medium you wish to use. After that, the ball should really be carried by the general manager and the promotion director.

Co-promotes: This is relationship-oriented and does not happen overnight. Smart promotion directors will develop relationships with their counterparts at other media outlets. Find out what they want to promote and offer to assist. Guess what ... their budgets are limited too.

Maybe the local newspaper wants to push

a new column it is running, but cannot afford to place the radio. Put together a joint promotion where you urge listeners to read the column for some reason, and the newspaper urges its listeners to listen to your radio station for some reason. This reason could be feature related or contest related.

For example, the column could run stories about a charity that you are going to profile each day at a given time on your morning show. Or perhaps your listeners have to look for a secret word in the column. Then they call the radio station the next morning at a given time with that secret word to win a prize (that you have traded from a third party for mentions!).

Out in front

Appearances: Any time you can put your station in front of people you have the chance to make friends and influence diary keepers. For the most impact, you have got to do this in great volume. If your station is visible two or three times a week, that is nice. Try harder. Get somebody out every day of the week. Even if this means just driving your station van through big crowds at concerts, it may influence somebody's diary recall. Hey, you would pay big bucks for busbacks, wouldn't you?

If your logo is properly painted on the side of your van, it will generate interest and recall. This is a numbers game. The more folks you touch, the greater your odds of finding somebody who votes for your station.

Stunts: These only work for certain formats. If yours is one of them, try to pull off something newsworthy once a month.

continued on page 31 ►

A Special Commitment

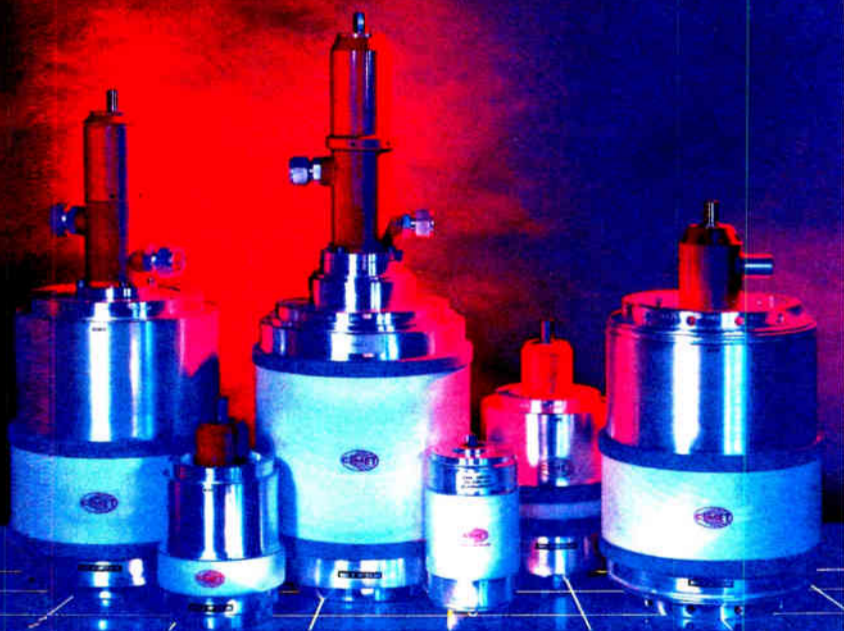

Since 1965, COMET has been committed to one objective — keeping our customers satisfied with the highest quality vacuum capacitors available.

Our experienced technical staff is dedicated to the advancement of capacitor technology, and will meet your custom requests with a design proposal in a matter of days. And, while we do specialize in made-to-order designs, we also stock a number of popular capacitor types for your off-the-shelf needs.

Call COMET when you have a special design request, want expert technical service, or need a replacement capacitor now.



COMET NORTH AMERICA, INC.

89 Taylor Ave. • Norwalk, CT 06854 (203) 852-1231 • FAX (203) 838-3827

Circle (51) On Reader Service Card

SATELLITE SYSTEMS



The Ariel Digital Satellite Receiver, exclusively from Satellite Systems

The Ariel Digital Satellite Receiver:

- 5 card slots for up to 10 audio channels
- adapts easily to current equipment
- 1-year warranty
- fully compatible with Fairchild Dart 384
- next day shipment of keyboards

SATELLITE SYSTEMS



Satellite Equipment for Radio

615 East Brookside
Colorado Springs, CO

80906

Ph: (719) 634-6319

Fx: (719) 635-8151

Circle (177) On Reader Service Card

Touch & Go!

AudioVAULT

AudioVAULT is the world's most successful Digital Studio System, because AudioVAULT provides everything you need from digital technology. Customized to your operation, AudioVAULT gives your program director and on-air talent the freedom to do what they do best. And AudioVAULT is uniquely flexible to support your station's growth for years to come.

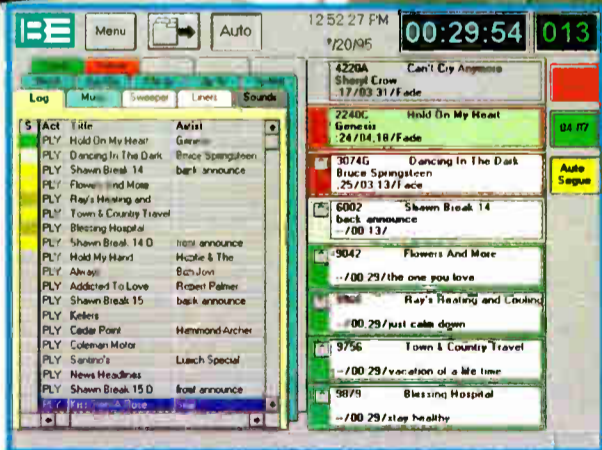

GO AVAIR! This is AudioVAULT AVAIR

...the most powerful, jock friendliest live radio tool in the digital radio world. Designed with maximum input from radio's top pros, for maximum live creativity and spontaneity. Customize and save AVAIR screens for every jock's individual needs. Run the wildest morning show. AVAIR gives your people the power to do everything you want them to do.

GO AWAY!

The other side of AVAIR...running automatically, sounding live. Music-on-hard-drive, net delay and playback...whatever you need to do, AudioVAULT handles it. And BE backs you up with 24-hour support, every day. You work better, sleep better.

GET GOING! AudioVAULT Digital Studio Systems start below \$9000.

Call your BE Digital Representative at 217-224-9600 (or fax 217-224-9607) and get the AudioVAULT 1995 Video and Demo Diskette.

BE BROADCAST ELECTRONICS, INC.

WORLD LEADER IN RADIO BROADCAST TECHNOLOGY

4100 N. 24th Street/P.O. Box 3606/Quincy, IL 62305-3606/(217)224-9600/Fax: (217)224-9607

Dissect Ideas, Techniques behind Great Radio Spots

Reducing Tune-out, Be It Passive or Active Requires Investing Time and Effort into the Creation of Spots

At NAB '95, Ty Ford was commissioned by NAB to present a paper titled "Better Profit And Ratings From Better Copy And Production." The paper was based on the concept that better management of the most dangerous part of a station's air sound — spot breaks — will result in reduced active and passive tune-out.

By reducing tune-out, the station gains quarter hours and cume. With better ratings, the station can charge more for its spots and thereby increase revenues. The first two parts have dealt with the conditions that have placed radio in the predicament in which it now finds itself. Subsequent parts will concentrate on how to identify and fix the problems.

PART III

by Ty Ford

BALTIMORE There are two types of tune-out: passive and active. With passive tune-out the listeners don't change stations or go to tape or CD, they just glaze over and don't pay

attention. They become disengaged. Repetition, however, is only one cause of tune-out. And while it is the most obvious cause, it is only the tip of the iceberg.

People don't hate all commercials, but they do hate bad commercials. And while "bad" may have a thousand definitions, the listener has implicit trust in your radio station. Every time you run a spot that falls outside the boundaries of that trust, a little bit of the listeners' loyalty is eroded. If you put yourself in his or her place you'd feel the same way.

Identify the problem

The problem is, most people in radio have been bombarded by spots for so long that they don't really listen to what is going on. Those who claim to listen, but hear nothing wrong, are in denial.

Let's take a look at the anatomy of a spot. Naming the parts helps to separate things out and makes finding problem areas easier. There are five cate-

gories: Concept, Copy, Performance, Production and Technical, the under-performance in any of which can result in tune-out.

In addition, there is also the acronym AIDA (Attention, Interest, Desire, Action). The best spots get your attention, keep your interest, create the desire for the product or service and require that you take action, usually within a given period of time.

Some consider Concept the spine of a spot, others consider it the skin. What I am talking about here is the setting and duration of the scene. If the listener finds the scene (or how it is set) offensive, dumb or cliched, he or she will not be inclined to remain engaged.

Sure, that opens it up to a wide range of subjectivity, some of which you may or may not agree with, but the clock is ticking on that monthly "It's Final. We're Going Out Of Business" sale concept. Even if it's true, few people believe it.

Relieve the misery

It is also time to put the "Automotive Tent Sale" out of its misery, unless you really have an engaging new twist. Hot dogs and balloons for the kids and a remote by the local radio station are not compelling reasons for anyone to go shopping for a car, much less buy one.

Certificates for a Surf and Turf dinner for two at a nice restaurant nearby for every couple that takes a test drive and fills out a credit application might work, but only if the restaurant has a good reputation.

There are basically five types of copy approach: Direct, Indirect, Testimonial, Narrative, Humor and Off-The-Wall. Direct usually tells you what's for sale, how much it costs and where to get it.

Direct copy can be soft sell, hard sell or anywhere in between. Indirect copy lists the benefits of a product or service without "asking for the order." Testimonial copy uses the words of satisfied users to convince the listener of the benefits. Narrative copy tells a story in which the "problem" is solved by the product or service being sold.

Humorous copy is the most difficult, most dangerous and has the shortest life. Off-the-wall copy consciously goes "in another direction." The idea is that the listener will be yanked in because the copy breaks the rules. This kind of copy works best when the product or service is trying to separate itself from the pack.

Different from the rest

It is also more effective on listeners who see themselves as not particularly susceptible to peer group pressure. Although off-the-wall copy can work very well, you seldom find it in spots for conservative products and services that rely on developing a high level of trust with the customer. Using this sort of delivery with investment firms, banks, hospitals, retirement communities and mortuaries is not for the faint of heart.

So now that you've got this great concept and wonderful approach, the copy too must be equally good. If it isn't, the listeners become disengaged and some sort of tune-out occurs.

In Part IV, I'll get into specific words and phrases that are almost guaranteed to cause tune-out.

□□□

Ty Ford has an attractively priced three-cassette box-set of the almost two-hour long session from NAB '95. He may be reached at (410) 889-6201 or Tford1010@aol.com

If you think the problem is bad now, wait until satellites start squirting digital radio into everyone's home, office and car.

attention. They become disengaged.

Active tune-outs, most often a problem with in-car listeners, are the most destructive. With active tune-outs, the listener turns off the radio, changes stations, goes to tape, CD or reaches for the car phone. And, if you think the problem is bad now, wait until satellites start squirting digital radio into everyone's home, office and car.

Sometimes there is nothing you can do to prevent tune-out. If the first spot in a break is selling snow tires and the listener is not in the market for snow tires, the tune-out light goes from green to yellow. The listener is now in passive tune-out. In passive tune-out mode, the listener is in a state of flux. He or she gets to decide what, if anything, to think about (e.g. a vacation, business problem or some other personal business), or he may be influenced by some external source like a phone call, a billboard, the person in the car next to them. You've lost him. And unless or until some sort of engaging noise comes out of the radio soon, he or she will stay lost.

Boredom sets in

If he or she gets bored or disturbed with his own thoughts, or those initiated by some external source, he will seek a source that engages him or her. If Irv, of Irv's Discount Auto Parts, is now reading a list of all the mufflers he sells, for the third time this hour, the signal goes from yellow to red, and the listener reaches for the radio, actively tunes out.

RADIO spots

THE SECRET'S OUT—DIGITAL FURNITURE

MODULAR FLEXIBILITY WITH A CUSTOM FIT

We Offer Six Elegant Lines of Studio Furniture

4153 BONITA STREET
SPRING VALLEY, CA 91977
PHONE 619/698-4658
FAX 619/698-1268

MURPHY
STUDIO FURNITURE



Circle (215) On Reader Service Card

'Net' News Abounded in New Orleans

by Alan Haber

WASHINGTON I don't like to fly. There, I said it. In fact, I hate to fly. You never take off on time, you land late, the food is awful, and you cannot plug into the World Wide Web!

I started writing this while I was waiting for my connecting flight in Atlanta, en route to the World Media Expo in New Orleans. While I waited, strapped snugly in my seat, I spied a headline on the front page of USA Today that kind of disturbed me, being the Web nut that I am: "Policing the Internet."

Cops on the Net?

Now, I ask you, just what if anything do the police have to do with the Internet? Now, I will admit that I did not read the article, but the headline did get me thinking. These days, you rarely read anything positive about the Net (except here, of course). Instead, you find out there is a lot of bad stuff in Cyberspace — evil stuff, even (witness the recent kiddie porn arrests).

Well, I think that it is just plain silly to focus only on the bad stuff (and there is some of that) and avoid talking about the good stuff (like the myriad of educational sites and the couple of hundred radio station web sites).

I live by the words of a wise (old) guy who said, "If you don't like it, don't seek it out, and if it comes to you and you don't want it, don't open the door." I'll confess — those are my words — ones I've lived by all my life. Sure, there is

some stuff on the Net that might be considered objectionable to some people. But nobody says they have to look at it, right?

The reason for bringing this up is that I was thinking about the "Policing the Internet" headline, and I thought about how radio stations could do their listeners a public service by including links to worthy sites and newsgroups — in other words, playing up the good things on the Net. After all, contributing to the further education and edification of your listeners is always a good thing. And isn't serving your listeners what you are trying to do, anyway?

WME Web wars report

I didn't exactly find myself tripping over Internet-related events at WME, but I was impressed with what I found — for the most part.

There were two Internet sessions held as part of the NAB Radio Show. Certainly the heftiest was the four-hour marathon Internet Boot Camp (boots, however, were not required). Among the presenters was Fred Schumacher from KMPS(AM)-KZOK(AM) in Seattle, who demonstrated his stations' sites and ran through a number of handy pros and cons associated with putting a station site on the Web.

The other Internet session, titled "The Internet: Are You Ready to Cybercast," was informative but hardly covered a lot of new ground, in my opinion. Except, that is, when Peggy Miles from Intervox Communications said that stations could

construct their sites with dayparts in mind.

Hmmm ... the idea of changing a site to match a station's dayparts is intriguing, and could open up new revenue streams and attract new listeners. Interesting.

At the NAB Radio Luncheon, I sat next to Kim Love from KROE-AM-FM in Sheridan, Wyo. Kim told me he is



going to set up a statewide news network so stations in Wyoming can share news and information with each other. A great idea.

I ran into William "Wild Bill" Goldsmith from our old friend KPIG-FM. He told me there are some exciting things afoot for the station's site, a recent Neat Site of the Month in this here space. I won't divulge the new stuff just yet — I'll wait until everything old is new again, so to speak. Wait until you see what's comin', pardners!

The idea of changing a site to match a station's dayparts is intriguing.

My WME Internet experience was capped off by a few additional Internet sightings: CompuServe was handing out access kits at its booth, and I saw a couple of Internet books in the NAB store (I also saw the Internet for Dummies Desk Calendar!).

All in all, lots of Internet stuff in New Orleans. But next year — heck, in the spring, even — how about some more sessions devoted to radio and the Internet, with one overview targeted to stations not already on-line, and the others dealing with more specific issues, such as revenue and site design. What say you, NAB?

Mail ketchup, uh, catch-up

The e-mail's been piling up here, so I thought I would take this opportunity to clear the decks. It is some job doing this and that here at the busy *Haber Space* headquarters, and, I would like to point out, I've already worked my way up from the mail room, thank you very much.

Anyway, I heard from some of you who have put your stations on-line. Thanks for letting me know about them: I'll continue to mention them in this

column. Keep 'em coming.

Scott Bourne, president of 30:60 Productions, wrote to tell me his company has put up Web sites for New Country K102 (<http://www.k102.com>) and KFAN(AM) 1130 (<http://www.kfan.com>), both in Minneapolis. Bourne's company has also put up a site for his program "net.radio," for which he is one of the hosts (<http://www.netradio.net>).

I also heard from Gary Fullhart, whose station WKFS-FM — the 50 kW CHR KISS-FM in Toledo, Ohio (<http://www.toledolink.com/kissfm/>) — has taken up residence in Cyberspace. Also singing the praises of his station's site was Cary Boyce, who bills himself as the Webmeister (now that's a novel approach!) of WFIU-FM's (Indiana University's radio station) web site (<http://www.iub.uca.indiana.edu/~wfiu/wfiuhome.html>).

David E. Knodel, director of engineering at KUHF-FM at the University of Houston, dropped me an e-mail to say his station is on the Web at <http://www.kuhf.uh.edu> and Mark Humphrey wrote to tell me that his station's site — Y100 in Philadelphia is indeed open for Cybersurfers at <http://www.y100.com>

Neat Site of the Month

John Konrad, program director of classical/inspirational WGTS-FM, which serves the metro Washington area, dropped me a cybernote (check out the site at <http://www.cuc.edu/~wgts/>). WGTS, by the way, is at Columbia Union College in Takoma Park, Md.

Because of this site's clean and highly navigational design (and some top-notch backgrounds, particularly the one featuring sheet music on the home page), WGTS's Web site is my Neat Site of the Month! Well done!

By the way, Konrad points out that "The best list of (radio) stations on the Internet is located at MIT." Right you may indeed

be, although I'd add that the other lists are pretty good, too. Check out MIT's list at <http://www.mit.edu:8001/activities/wmbr/otherstations.html>

Bensonmania!

I've been hearing a lot from my California radio friend Joe Benson, operations director at KBAI(AM) in Morro Bay, and KNCR-FM in Paso Robles. (One of these days, Joe, I'm going to find the time to write you an e-mail as long as the ones you've been sending me!) Joe is a real radio fan, and I look forward to his regular missives.

Among other pursuits, Joe's been keeping track of radio stations on the Web — he says he has upwards of 700 sites bookmarked! Which leads me to repeat my earlier request: If your station is on the Web, drop me an e-mail and I'll mention it in this column.

Solid ground

I think I'll stay put for awhile. If I don't take care of business here at the plush *Haber Space* Global Headquarters, who will? Fill my e-mail box with e-mail, why don't you? I'm at, as always, zoogang@ix.netcom.com

FREE STOCK TIP

Invest in your business news. Call Nasdaq's Stockline for free, ready-to-air stock market reports. Get the latest numbers on the markets and the day's economic and consumer news.

Call 1-800-536-0837

It's updated on the hour and it's absolutely free. If you want, sell the report to a local sponsor. So, give it a listen. Then give us a call to let us know what you think.

Contact Brett, Chuck, or Debbie at 1-800-777-6273.

THE NASDAQ STOCK MARKET™
NASDAQ

HARRY S. HEADPHONE

stars as ACE RADIOMAN in

TRIUMPH ON THE AIRWAVES

He flew far above the competition!
Ace RadioMan knew he
had to have the best... *OTARI*



FEATURING

- ★ Random Access Disk Recorders
- ★ DAT Recorders ★ Tape Recorders
- ★ CD Changers ★ Mixing Consoles
- ★ MiniDisc Recorders



team
OTARI

AN
OTARI[®]
PRODUCTION

Otari's ★FULL LINE of audio ★STORAGE,
★MANIPULATION and ★DELIVERY SYSTEMS
gives you the ★TOOLS TO SOLVE your station's
audio problems at reasonable cost. And Otari's legendary
★RELIABILITY means these problems stay solved!
Call your Otari dealer or 415-341-5900 for information.
And don't forget to ask for a large poster of this ad!

Otari Corporation U.S.A.
Phone: (415) 341-5900, Fax: (415) 341-7200
L.A. Sales: (818) 972-3687, S.E. Sales: (615) 255-6080

Otari Inc. Japan
Phone: (81) 4-2481-8526, Fax: (81) 4-2481-8633

Otari Deutschland GmbH Germany
Phone: (49) 2-59-50861 Fax: (49) 2159-1778

Otari Singapore Pte., Ltd.
Phone: (65) 284-7211, Fax: (65) 284-4727



B-10 Broadcast Console



RADAR Disc Recorder



MX-50II Tape Recorder



DTR-8 DAT Recorder



MR-13 Mini-Disc Recorder/Player



CDC-600 CD Changer

STATION SERVICES

News and Services for Business, Programming and Sales

Christmas Programming with Paul Overstreet

COLORADO SPRINGS, Colo.

Briargate Media is presenting "Christmas at the Ranch," a holiday special on CD featuring country artist Paul Overstreet and the Flying W Wranglers. The program is a one-hour Focus on the Family special featuring western favorites, classic Yuletide music and bunkhouse humor courtesy of the Wranglers.

Delivery of "Christmas at the Ranch" will be early enough to allow airing the program several times between Thanksgiving and Christmas.

For information, contact Briargate Media at 719-531-3300 or circle Reader Service 61.

Show Prep Service from United Press International

WASHINGTON United Press International has introduced "PowerPrep 3.0," an expanded offering of show-prep features for broadcasters.

The third year of PowerPrep (hence the "3.0" designation) brings new daily features on music, trivia and astrology.

"Rock News" joins "Today in Music" and other format-specific columns on Country, Jazz and Classical music.

The "Actual Facts" trivia column joins the "Almanac" and "Blast from the Past" items now moving on UPI.

"Horoscopes" is teamed up with existing

entertainment pages as "Entertainment Today," "Of Human Interest" and "Jockstrip."

For additional information, contact the UPI Sales Administration office at 202-898-8000 or circle Reader Service 73.

Documentary on American Southwest

ALBUQUERQUE, N.M. "Writing the Southwest" is a series of half-hour radio documentaries on contemporary life in the American Southwest, produced by the Department of English at the University of New Mexico, Albuquerque, New Mexico.

Each show profiles authors whose lives and work have been influenced by that particular region, including Hispanics along the Mexican-American border and Native Americans between the reservation and the city.

The 13 programs are digitally produced and satellite fed, and are available for rebroadcast four times over three years.

For technical information or an outline of the production, contact the University of New Mexico at 505-345-0185, E-mail at wrtgs@unm.edu or circle Reader Service 60.

JockLine Aircheck Service

WASHINGTON A new interactive aircheck audition service called "JockLine" has been launched by former Washington

air personality Mike Weiner.

JockLine lets air personalities, newscasters and station image voices place a two-minute demo into the system under an appropriate format category. Program directors and general managers can audition prospective talent by calling the JockLine and listening only to the segments that interest them, then contact the performer directly.

Personalities interested in using the service pay a fee for a three-, six- or 12-month placement. Stations needing continuous updates of on-line talent can subscribe for 6 or 12 months.

Talent and managers can receive more information by calling Mike Weiner at 301-924-5700, extension 1, or circle Reader Service 99.

New Programs on USA Network

DALLAS Two new programs join the lineup on the USA Radio Network this fall.

John Rosemond of the Center for Affirmative Parenting hosts "Because I Said So!" weekday afternoons from 3 to 5 p.m. ET. The show supports a conservative, back-to-basics revolution in child rearing and family values.

Saturday morning brings "Your Health Matters" to USA Radio Network. Hosted by nutritional expert Doug Kaufmann, the show concentrates on personal health, medicine and nutrition. The show will be carried on the USA Radio Network from 8 to 10 a.m. ET.

For more information, call Becky Henson at the USA Radio Network Affiliate Services department, 1-800-829-8111, or circle Reader Service 122.

Westwood One Launches Love Phones

NEW YORK "Love Phones," hosted by noted Ph.D. clinical psychologist and sex therapist Dr. Judy Kuriansky is two hours

of sizzling talk about love, life and sex with a blend of wise counsel and entertaining humor.

Originating from WHTZ(FM) "Z100" in New York, "Love Phones" airs Sunday through Thursday from 10 p.m. to 12 a.m., ET. The program is designed to provide a forum to address relationships, love and sex. Guests to date include Steve Tyler of Aerosmith, Sheryl Crow, The Gin Blossoms and President Clinton's brother, Roger Clinton.

For information, contact Renee Casis at 212-641-2052; or circle Reader Service 40.

War of the Worlds Available For Halloween 1995

BEVERLY HILLS, Calif. "The War of the Worlds" hour-long radio special starring Orson Welles is once again being made available on tape to radio stations for Halloween 1995.

Charles Michelson Inc. is the authorized distributor and is reporting sales to 500 radio stations so far.

For information, contact the company at 213-278-4546; or circle Reader Service 125.

BIA Adds Station Contour Mapping

CHANTILLY, Va. BIA, provider of state-of-the-art database software profiling radio and television stations, MasterAccess, unveiled a new add-on feature: station signal coverage maps.

Developed in a joint venture with Communications Data Services of Falls Church, Va., the coverage maps feature single station, multiple station or even multiple market information. The coverage maps will be updated regularly with FCC-approved changes.

For information, contact Debbie Metcalf at 703-818-2425; or circle Reader Service 146.

STATION/STUDIO SERVICES

427 SOUND EFFECTS \$89.00

For a 5-CD set with a 30-day money-back guarantee.

Take an extra \$10 off if you mention this ad!

Send \$79 to Ghostwriters
2412 Unity Ave. N., Dept. RW
Minneapolis, MN 55422

For credit card orders call
(612) 522-6256

READER SERVICE 145

THE BROADCASTER COLLECTION of SOUND EFFECTS!

Over 500 broadcast quality Sound Effects on 8 CDs organized by subject!

Animals - 93 Tracks Backgrounds - 47 Tracks
Transportation 1 - 51 Tracks Military - 92 Tracks
Transportation 2 - 69 Tracks Environment - 50 Tracks
Machinery - 58 Tracks Household - 88 Tracks

All 8 for ONLY \$150.00! ORDER TODAY and receive FREE our 2 Volume VOICES OF HISTORY CD with more than 49 famous speeches from the past!

CREDIT CARD ORDERS - CALL TOLL FREE Satisfaction Guaranteed!

VALENTINO MUSIC
500 Executive Blvd, Elmsford, NY 10523
800-223-6278 FAX 914-347-4764

READER SERVICE 53

Retail Client JINGLES: \$950!

Complete packages with multiple :30 & :60 cuts
Buy Out: NO yearly renewal or leasing required

Automated Station Services

Complete copywriting & production packages
Award winning writers & creative talent on staff

Now radio stations and their clients in the smaller markets can have that major market sound...without the major market price.

Call for your FREE DEMO TAPE today!

EZ SOUND IDEAS!

Call 1-800-IDEAS-83 NOW!

READER SERVICE 75

BUY-OUT MUSIC — \$99

Sixty 60-second music beds for .. \$99
198 :30 & :60 music beds for ... \$198
120 production effects "Zings, Zaps and Zoodads for \$99
122 New Lasers & Sweepers for .. \$99

For FREE DETAILS on production music, sound effects, call

Ghostwriters (612) 522-6256

READER SERVICE 145

ATTENTION PROVIDERS!

Promote your services to **Radio World's** 18,000+ readers. Reach Radio Station and Recording Studio owners/managers and engineers with your message. For information on affordable advertising call **Simone** at **1-800-336-3045**.

ATTENTION P.D.s

Schedule the best in "OLD-TIME RADIO" with

When Radio Was...

Hosted by STAN FREBERG, the man who drained Lake Michigan and filled it with hot chocolate

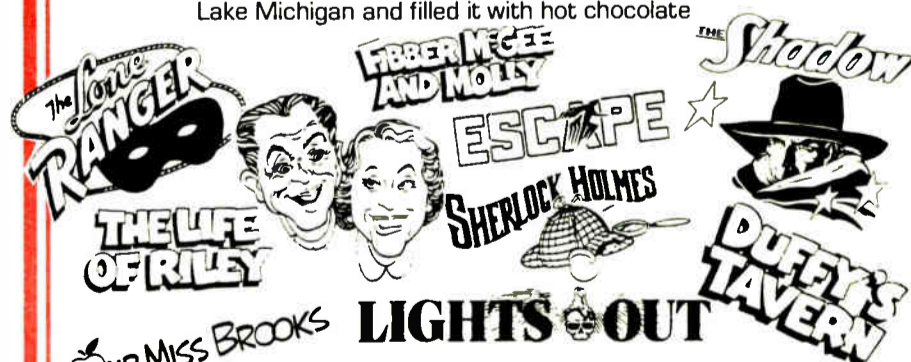

Five shows per week—54 minutes each.
BARTER, NO CASH PAYMENTS!

For a free demo CD contact David West

DICK BRESCIA ASSOCIATES (201) 385-6566

When Radio Was celebrates its 6th year on 300 stations

MANAGERS NOTEBOOK

Job Description Key to Hiring Right Staff

by Sue Jones

BURKE, Va. Over the past three years, several readers of this column have called me in response to an article they particularly liked. During our conversation, I always asked them what other management topics would be of interest for future columns. One recurring theme was hiring and promotion policies.

Common pet peeves

Hiring a person from the outside or promoting someone from within for a supervisory position who lacks some qualifications for the position. Some key responses to this type of policy include staff members feeling they did not even have an opportunity to interview for the position. They feel there is no opportunity for them at the station.

Their morale usually drops to the lowest level and so does the quality and quantity of their work.

A hard working person with experience and good qualifications will begin looking for another position, possibly at your competing station. In some cases, a disgruntled staff member may over estimate his or her abilities and truly does not fully understand the requirements of the supervisory position. As a result, his or her qualifications do not fully meet the job's requirements.

There are some things that can be done to prevent hard feelings, misunderstandings, and morale problems. Before you

hire anyone for a vacant position, use this checklist as a guide.

1. Post job vacancy announcements in a place where all staff members will be likely to see them. The refrigerator door is a good example, so are the soda machine or staff announcement bulletin boards. The vacancy announcement should list the requirements for the position. Include education, job experience, job-related experience, and special skill requirements for the position.

Straight talk

This type of information should come directly from the job description for that

position. If the vacancy announcement says a college degree is required, and one hopeful internal candidate has a good track record with the station but does not possess the college degree, the internal candidate cannot logically expect to be selected for the position. The opposite situation is also true. If the person hired for the position does not possess the required college degree and other staff members do, you need to be ready to defend your decision based on all of the other qualifications of the new employee.

Even if none of the employees are
continued on page 32 ▶

Exploiting The Media

▶ continued from page 25

Coverage will come your way when you hit something topical and you are contacting the right people at the right time. If your stunt is visual, plan it somewhere close to the television stations ... don't do it 40 miles out in the sticks. The timing is also important. Find out when news crews in your market are at their biggest strength.

Prizes: Regardless of market size, you can always find someone to give you prizes for mentions. If you are not having success, you are just not talking to the right people. For small prizes, hit up movie theaters, bowling alleys, video stores and pizza places. Who doesn't want a free pie? For the bigger stuff, call travel agents, car dealerships and appliance stores. The number of prizes you receive is directly proportional to the number of people you try.

Ask for a listen

Telemarketing: Have you ever had your jocks or interns call and ask people to listen? OK ... this is one that may only work in smaller towns ... but it does work. Get out the phone book. Start with the As. Call the Able residence.

"Hi. This is Johnny Doe calling from Z103 ... I hope I'm calling at an OK time. We are doing a survey to find out what you think of Z103 ... do you have any comments? Thanks very much. I'd like to invite you to listen to my show tomorrow at 1:30 p.m. If I announce your name and you call within 10 minutes, you win free dry cleaning for a month. Thanks."

Sound funny to you? Having done it myself years ago as an air talent, I can tell you that it is embarrassing to do at first. After a while, you realize it does have impact.

Radio is show business. This is true with or without a promotion budget. To be great show business, it takes a talented director. Take chances ... make mistakes ... learn ... but don't just sit there waiting for promotion dollars to fall from above. Go get 'em!

□ □ □

Mark Lapidus is director of marketing for Liberty Broadcasting. Liberty owns stations in Washington, Baltimore, Richmond, Va., Long Island and Albany, N.Y., Hartford, Conn., and Providence, R.I.

Sharing programming

doesn't take a **rocket scientist.**

Or does it?

Radio and rocket science. If you never exactly thought the two belonged in the same sentence, consider this: our satellite services help you share programming coast to coast at a **lower cost** than ever before. Genius? Well, you can create your own satellite network, increase programming quality at local levels, utilize **state-of-the-art digital technology**, and keep overhead low. Plus, it's all brought to you by people who understand your needs -- the **radio only experts** at NPR Satellite Services. You don't have to be a rocket scientist to see the benefits. Call us today at (202) 414-2626.

NPR Satellite Services. Link up with us.

635 Massachusetts Ave., NW., Washington, DC 20001-3753 • (202) 414-2626

Hire the Right Staff

► continued from page 31

interested or qualified an employee may know someone who is qualified for the vacancy and is searching for a new position. If the referred candidate meets the position qualifications, this could significantly reduce your recruiting time and associated expense.

2. Interview all staff members who express an interest in the position. Interview him or her even if you do not believe the employee is remotely qualified. Several things are accomplished by interviewing all internal candidates. The station demonstrates its commitment to equal opportunity. Staffers can make their career goals known.

This could be a golden opportunity to groom an internal candidate for that position in the future. For example, if a sales associate is interested in the sales manager's position, has an excellent sales record, but does not have strong interpersonal skills for leading and directing a staff, this could be a growth area to develop.

Invest in training

That could be accomplished by sending the employee to management seminars or courses over a two-year period. At that point you would have a star sales associate with the supervisory skills needed to step into the position. If

you follow this route, it also is a strong statement to other staff members that the station believes in and supports its staff. That is a powerful motivator for the all others.

If your internal candidate does not qualify for the position, explain the successful candidate's strengths. This will

you logically explain to your staff or an EEOC inquiry from the Department of Labor why you selected the new employee? Did you consider promoting an internal candidate? When evaluating the internal candidate's qualifications, were his or her contributions to the bottom line evaluated? Did the internal can-

If your internal candidate does not qualify for the position, explain the successful candidate's strengths.

let your employee know what areas need improving and will significantly reduce the rumor mill speculation.

3. Examine the reasons why the successful candidate was selected. Could

didate provide value to the station by reducing costs or contributing to the improved ratings?

If you did select an internal candidate, was the selection made on how well that person performed the duties of the current position and contributions to the station in terms of revenue, improvements or cost savings? Will the subordinate staff respect the new supervisor because of the accomplishments to the station or whisper that the candidate "brown-nosed" his way into the position.

Was the successful candidate selected on performance and merit and not the race, religion, sex or age of the person?

A related pet peeve: Hiring or promoting an unqualified candidate at a lower salary to save budget money. The incumbent may be paid thousands less than the former employee. However, this penny-wise, pound-foolish type of strategy can backfire in several ways. The first is the high frustration level of the subordinate staff. Staff resentment will soon build high frustration that usually leads to high staff turnover. If the leader is incompetent and incapable of providing guidance and leadership, the result may be several vacancies in a department. Even if the new staff person does not have subordinate staff, someone lacking the job's necessary skills can cost more than the salary dollars saved.

Foolish saving

An inexperienced office manager/accountant may fail to file quarterly payroll taxes. That omission can result in back payments, interest penalties, and possibly an IRS investigation. Unqualified or inexperienced engineers can ruin expensive equipment. Those may not be the only costs from an equipment catastrophe.

Your insurance premiums may increase as a result of a claim. If there is a major transmitter or antenna failure, the station could be off the air for a day or more if no backup equipment is available. New equipment may need to be shipped from the manufacturer or supplier. Shipping large equipment may take time and express freight is very expensive.

Choosing qualified candidates should be the primary focus while recruiting. The staff will be far more supportive of qualified candidates. The new staff member will assimilate much faster. These items will contribute to a smoother running radio station, with better staff motivation and contributions, while controlling costs.

□ □ □

Sue Jones is a senior manager for Computer Data Systems Inc., in Rockville, MD. She can be reached at 703-323-0491.

WHY SETTLE FOR A FEW TOOLS WHEN YOU CAN HAVE THEM ALL?

Most digital audio systems provide the basic tools to accomplish specific functions, but only DAD486x gives you all of the tools you'll ever need to perform virtually any task imaginable: On-Air, Production, Library Management, Interface with Scheduling & Billing - and for any format; Live Assist or Automated - small or major market. It offers the ultimate in flexibility without stifling creativity.

Any digital audio system is expected to provide immediate operating efficiencies and improve the bottom line. But systems are often selected without giving proper credit to the role as a platform for future capabilities and expansion.

Can the system adapt when you decide to change formats or automate overnights via satellite... or accept and delay more external feeds? What if you do your own in-house automation? Can it handle an LMA or duopoly, integrate a new station, maybe even simulcast with the present one? How flexible will it be for the new PD, or that hot morning jock... both of whom will likely have strong opinions on how to best utilize the system? Most digital audio products just don't adapt very easily, and you will most certainly be faced with additional software and/or hardware expenses for any changes... not with DAD.

DAD486x is the ultimate Master Toolchest for broadcast professionals. Your staff may not use all of the tools at first, but as proficiency is achieved, they'll come to apply them in more and better ways to improve your entire product. DAD doesn't dictate an operational structure.

For any given task there are multiple tools and solutions. It runs on standard, non-proprietary computer hardware, easily interfaces with other professional equipment and systems, and can implement various levels of redundancy and fault tolerance. Featuring a completely open architecture, it maximizes future adaptability, is easily maintained, and can readily be configured as anything from a stand-alone workstation to any number of networked workstations, each optimized for specific tasks.

Best of all, DAD486x costs about the same as systems with far less features.

Software upgrades and improvements are free for the first year, plus there are no

hidden monthly fees. Call ENCO and find out why so many stations and groups throughout the world have standardized on

DAD486x, the Ultimate Broadcast Audio Toolchest!

 ENCO
SYSTEMS, INC.



The hybrid you put between these cables is your most important connection for successful talk shows



Listeners and programmers agree.

The quality of your talk shows and call-ins are as critical as who you have talking.
And stations who are most serious about their sound and ratings use Telos.

Telos' digital hybrids have earned their reputation for exceptional performance.
In addition to full-duplex audio, Telos hybrids achieve consistent levels from caller to caller.

Our full range of products includes the top of the line Telos 100 Delta with a digital dynamic equalizer so advanced you won't find it anywhere else. When it comes to complete systems, the ONE-x-Six proves you don't have to spend a lot to get Telos quality and features.

Let Telos connect you to your callers. Isn't it time you experienced great phones?



only from



2101 Superior Avenue • Cleveland, Ohio 44114 USA • Tel: +1.216.241.7225 • Fax: +1. 216.241.4103 • email: info@zephyr.com

Circle (135) On Reader Service Card

World Radio History

TWO Proven Methods To Attract More Listeners.

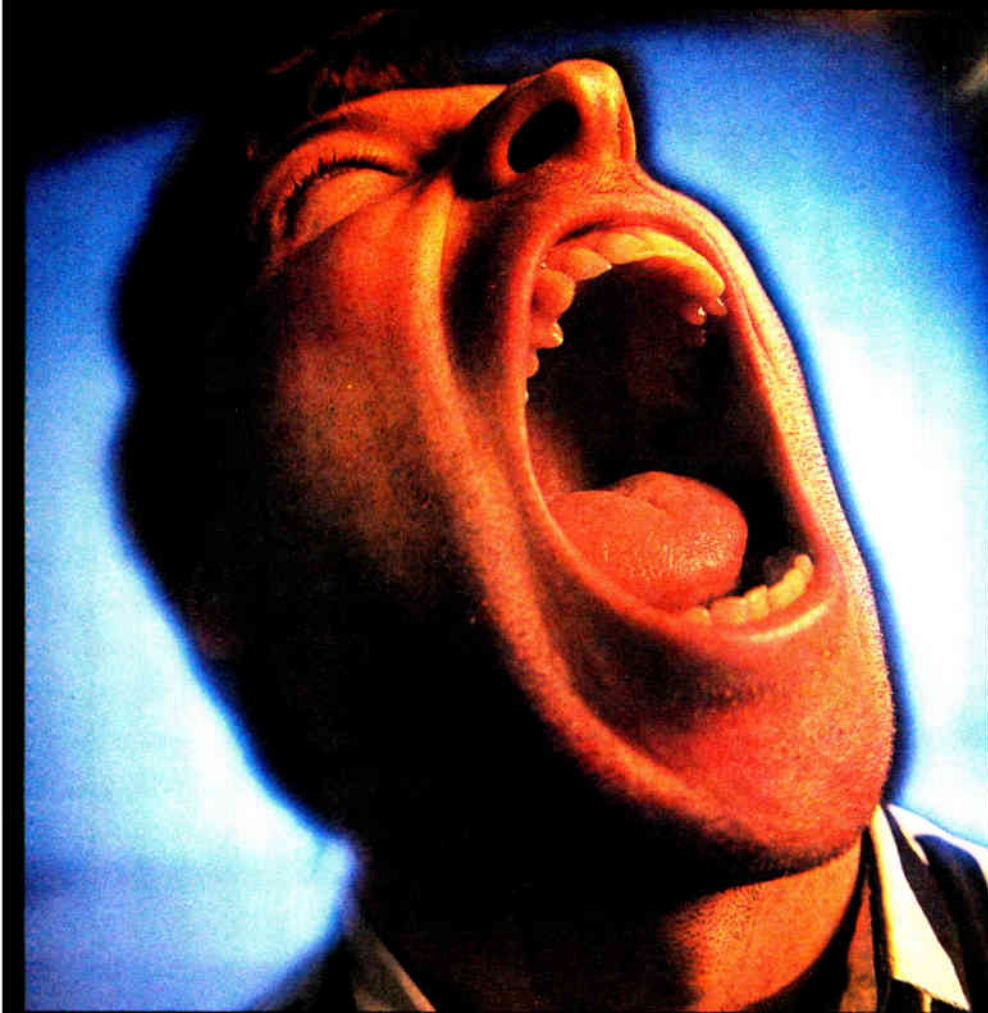

[Shock Jock*: About \$500,000]



[OPTIMOD 9100: About \$5,000]

That's the price of succeeding in AM radio these days: you can buy a big expensive star to reach a larger audience, or put an OPTIMOD-AM at the transmitter. Both give you the strength to be different, even double your audience size. But by "maximizing" your power with the 9100, you also get the closest thing to FM sound with unmatched efficiency.

True, extending your reach while saving on power isn't nearly as much fun as hiring a big, loud star*. But which sounds better to *you*: a bigger mouth, or a bigger bank account?

orban[®]

H A Harman International Company

© 1995 Orban and OPTIMOD are registered trademarks. 1525 Alvarado St., San Leandro, CA 94577 USA
Phone 1-510-351-3500 Fax 1-510-351-0500. E-mail custserv@orban.com

Circle (56) On Reader Service Card
World Radio History

ROOTS OF RADIO

Invaders from Mars! In New Jersey

by Richard W. O'Donnell

PORT RICHEY, Fla. The State of New Jersey, all 7,836 square miles of it, was invaded by a swarm of Martians during Orson Welles' celebrated "War of the Worlds" radio show.

It was simply meant to be a harmless Halloween Eve radio show, but the one-hour drama that went out over the airwaves at 8 p.m., ET, on Sunday, Oct. 30, 1938, to 151 CBS stations coast-to-coast terrified the nation.

And nowhere in the United States was the terror greater than in New Jersey, where the first Martian rockets landed.

What happened that memorable night? And why? We will follow the events that took place that evening — both imaginary and real — in the state.

News flash

The Welles' show opened with a weather report, some dance music, and then a bulletin from "Intercontinental Radio News."

About 8:05, an announcer reported: "Professor Farrell of Mt. Jennings Observatory in Chicago, Ill., has reported several explosions of incandescent gas occurring at regular intervals on the planet Mars. The spectroscope indicates the gas to be hydrogen, and moving toward the earth with enormous velocity."

He also revealed: "Professor Pearson of Princeton Observatory has described the explosions as being like a jet of blue flames shot from a gun."

Some more dance music followed, after which there was an interview by radio reporter Karl Phillips with

Professor Richard Pearson, the famous Princeton astronomer. Pearson was of the opinion the explosions were caused by "atmospheric conditions," and said the odds were 1000 to 1 that there was any type of human intelligence on Mars, which was "about 40 million miles from earth."

About 8:10 p.m., during the Pearson interview, it was revealed a seismograph had recorded a shock "of earthquake intensity within 20 miles of Princeton." The professor believed it to be "a meteorite of unusual size" and said he would "search of it when daylight permits."

Then there was a report from Trenton that stated "a flaming object believed to be a meteorite had fallen in the vicinity of Grovers Mill, located 22 miles from Trenton. The flash in the sky was visible within a radius of several hundred miles, and the impact of the noise could be heard as far north as Elizabeth."

A huge cylinder

Dance music followed, after which there was an announcement. Karl Phillips was en route to Grovers Mill. Phillips was heard again after about 15 seconds of music.

"Ladies and gentleman," he said, "this is Karl Phillips again out at Wilmot's Farm. Professor Pearson and I traveled the 11 miles from Princeton in 10 minutes."

He then painted "a word picture" of what he saw.

"That's the thing directly in front of me," Phillips reported. "It is half buried in a vast pit. It must have struck with terrific force. The ground is covered

with splinters of a tree it must have struck on its way down. What I can see of the object itself doesn't look very much like a meteor. It looks like a huge cylinder."



Orson Welles

Pearson added it was about "30 yards in diameter," and that it was "yellowish white."

Police had trouble keeping "the curious" back at this point, and announcer Phillips had unkind words for some people who were blocking his view of the cylinder. Next came a short interview with George Wilmot, owner of the farm, who was dozing when the thing came down, and who was roused from

his slumber by what he thought was the "hissing of a Fourth of July rocket."

Professor Pearson, who was within 25 feet of the cylinder, heard scraping sounds which he thought were caused by "the unequal cooling of the surface of the casing made of a metal not found on this earth."

The top of the cylinder started rotating, and came off. "Someone is coming out of the top," Phillips reported. "There are green luminous discs like eyes ... another and another of gray snake tentacles ... it is large like a bear with skin of wet leather and a mouth dripping saliva."

There was more dance music, and then Phillips again. "Two police officers carrying white handkerchiefs are approaching the cylinder. There's something like a mirror now at the top of the cylinder giving off a small beam. It is shining on everything — people, cars, every ..."

Phillips went off the air. Piano music was heard. Then a solemn voice announced that, according to a report received on the telephone, "40 people and six state troopers had been burned beyond recognition" by the heat ray at Wilmot's Farm.

Martial law

Brigadier General Montgomery Smith, commander of the New Jersey State Militia, came on next. From Trenton, he announced that "Mercer and Middlesex counties, as far west as Princeton and east to Jamesburg were under martial law." He disclosed four companies of militia were en route to Grovers Mill to aid in the evacuation, and that the "strange creatures" were back in the cylinder.

A short time later, there was a bulletin revealing the charred body of Karl

continued on page 38 ▶

Running Radio Marketplace

A Supermarket of Radio Station Services

For information on the services shown below, circle the Reader Service number on the enclosed card or contact the advertiser directly.

Collectors Radio Network

2 hours of Programming each Saturday Organizing from Dearborn, Michigan. Produced by veteran Detroit Area Broadcasters Talk on:

- Classic Cars
- Collectibles and Antiques
- Classic Entertainment and more

World's First Broadcast Network Dedicated to the Collector

Barter Basis
Info and Demo 1-800-739-7900

Reader Service No. 85



COUNTS DOWN COUNTRY'S TOP 40

THE NASHVILLE RECORD REVIEW, HOSTED BY LORIANNE CROOK AND CHARLIE CHASE OF TNN'S MUSIC CITY TONIGHT, IS ONE OF RADIO'S FASTEST GROWING COUNTRY COUNTDOWN SHOWS.

A FOUR-HOUR WEEKLY SYNDICATED RADIO PROGRAM PRODUCED ON COMPACT DISC.

FOR MORE INFORMATION CONTACT

EAST: FRANK IACONA,
(203) 965-6217
WEST: CRAIG CHAMBERS,
(303) 771-9800

Reader Service No. 178

Good Times - Great Oldies! Celebrity Guests...



- The Beatles
- Bobby Vinton
- The Lovin' Spoonful
- The Supremes
- Herman's Hermits
- James Brown
- The Grassroots
- Lesley Gore
- Johnny Rivers
- Elvis
- ...And Others

Here's Your Chance To "Make The Grade"!

For A Demo Of This Weekly, 4-Hour Show:

1-800-985-2665

Distributed by COPRA Media Productions, Inc.
444 Westgrove Drive, Suite 210, Dallas, TX 75248

Reader Service No. 200

MARKETPLACE

Recently Introduced Products for the Radio Broadcast Professional

RPU Receiver

Marti Electronics offers the SR-10 frequency-agile remote pickup receiver. Built around the technology of the AR and CR Series receivers, the SR-10 features full

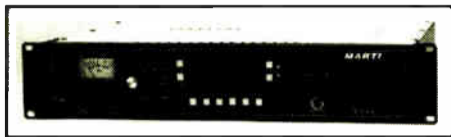

remote control capability and six preset channels that can be scanned.

An LCD shows all 158 channels in the 450 MHz and 455 MHz RPU bands. Other

bands are also available for export frequencies. A matching frequency-agile RPU transmitter is scheduled for release in early 1996.

For information, contact the company in Texas at 817-645-9163; fax: 817-641-3869; or circle Reader Service 103.

Automation Service

DCM Software Solutions introduces Radio Intern, a new service for radio stations that automates the routine transactions of studio lines.

Radio Intern is an interactive voice response system that combines computer

and telecommunications equipment to automate routing transactions with users via telephone. Using synthesized speech, an IVR system can respond to an incoming call, request specific information from the caller and provide the caller with information or other services.

Features offered by Radio Intern include automated contests, automated surveys, automated requests, advertiser support, news and information, and fax service.

No equipment purchase is necessary. Calls to a station's studio are forwarded to equipment owned by DCM and located off site. For

unlimited use of Radio Intern, stations pay a monthly fee ranging from \$500 to \$2,500.

A demonstration of this service may be heard by calling 612-331-2470, ext. 5625. The service is currently being introduced to the Minneapolis/St. Paul market.

For information, contact the company in Minnesota at 612-627-9174; fax: 612-331-3676; or circle Reader Service 119.

Technology Furniture

The Compacta Cart line of technology furniture from Anthro Corp. is targeted to people who use computers at home or in a small office and who want flexibility and mobility at an affordable price.

Compacta Carts are tubular in design and the shelves are easily adjustable in one-inch increments. They are available in eight colors and two widths, 32 inches and 48 inches.

This line of furniture includes a computer



cart, a printer cart, an equipment stand and a kids' cart.

All Compacta products have 45-pound, industrial-grade particle board shelves with scratch-resistant laminate and vinyl T-molded edges. All units ship ready to assemble with the necessary tools included.

For information, contact the company in Oregon at 503-691-2556; fax: 503-691-2409; or circle Reader Service 57.

Corrosion Control for Tower Anchors

The AnchorGuard corrosion control system for tower anchors from AnchorGuard L.L.C. prevents corrosion by using cathodic protection, the technology used to protect underground pipelines and steel tanks. AnchorGuard eliminates the need for expensive engineering studies without sacrificing long-term protection.

AnchorGuard utilizes high-output magnesium anodes to ensure strong protective current. Each system also includes a durable monitoring device with a patented permanent reference cell and a test head for installation at each anchor. The test head is removable to facilitate tower maintenance.



The AnchorGuard system comes in three models to protect a wide range of anchor sizes and dimensions, and can be installed easily on both new and existing towers.

For information, contact the company in South Dakota at 605-331-6426; fax: 605-332-7833; or circle Reader Service 142.



IT'S A GIRL!

On September 1, 1995 at 9:58 a.m.

in Edgewater, Florida

a new life was brought into the world by Radiosoft.



After many months of labor, we are proud to introduce our newest, named AMR. She already knows so many things, too. And if you think that she will be the little stepsister of our popular FMR program, guess again! She's loaded with talent, and can already give her brother a good run for his money in speed and accuracy. She's even more fun to be with than he is, and you don't need a manual to play with her any more than you needed one for her brother. She knows all the standard, theoretical and augmented patterns, and can draw any contour you want, from wildly optimistic to "here's where you can really sell the station". Color pictures are easy for her, and she can make them any size you want. AMR is so smart, she can even draw a full color picture of the conductivity which makes the signal go where it does. She shares lots of her brother's toys, so you don't have to buy many new ones, and she plays the game just like he does, so you can win the first time you try her. And ANYONE can play, even if you have never tried a computer in your life, because she's the best behaved child in radio!

If you want to invite her over to your place to see what she can do, write us (120 North Riverside Drive, Edgewater, FL 32132), email (pmoncure@america.com), or just give us a shout at (904) 426-2521, and you'll like her as much as we do!

Here's one of her drawings (it took about 3 seconds to make):

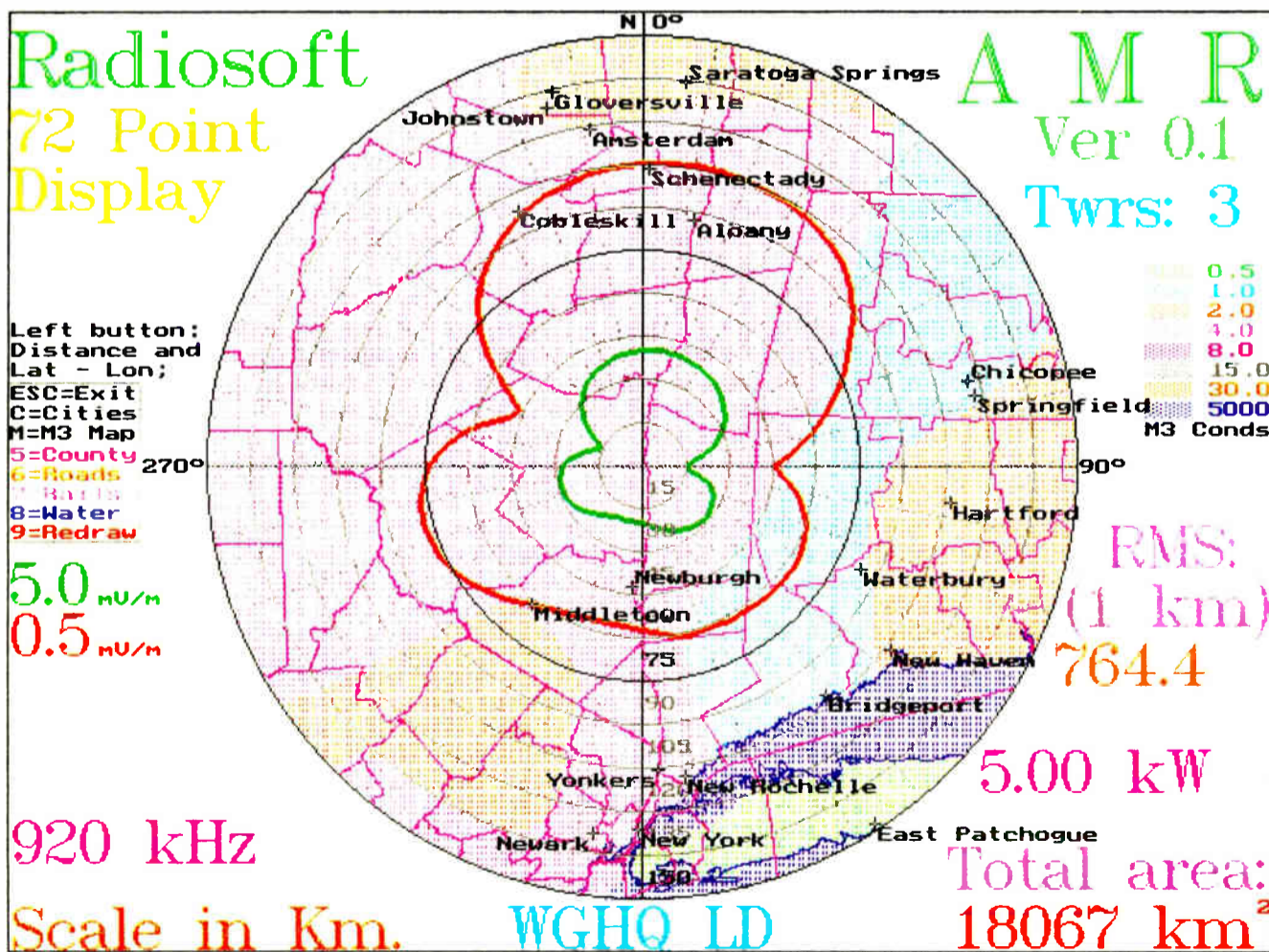

Fine print: any parent knows you have to give a little extra attention to the older brother when the new baby comes, so: if you mention "fine print" and you buy FMR before November 1, 1995, we will give you \$100; if you buy both AMR and FMR, you get \$200 (just so he won't be jealous).

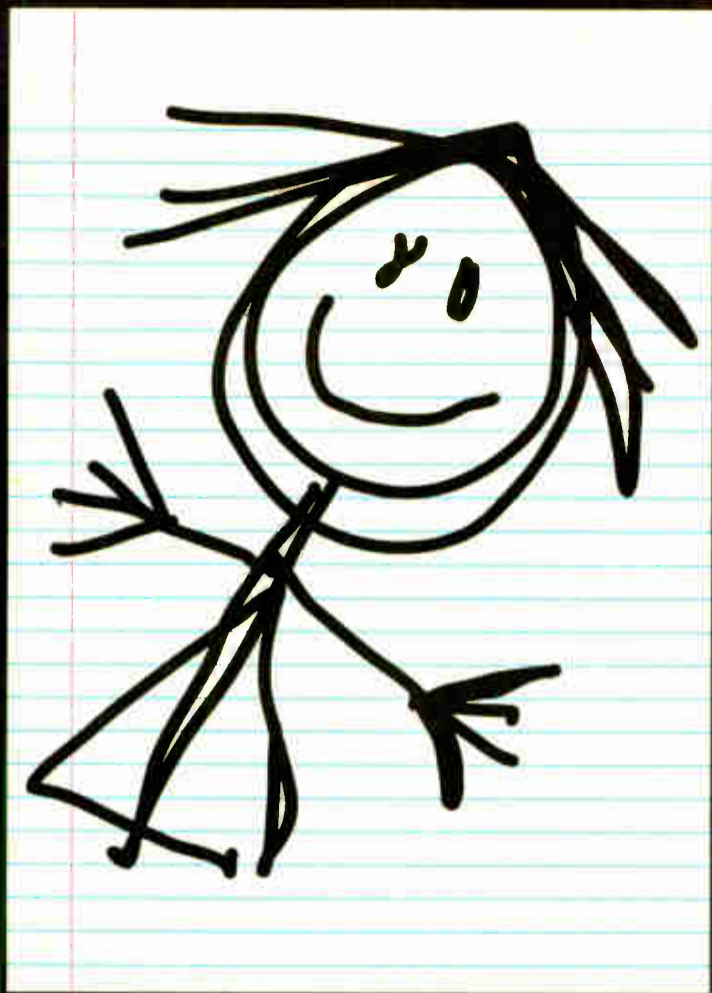

If you could see
how much better
MUSICAM[®] sounds
than Layer II & III



It would look like this.

The first and only quality enhancement to MPEG Layer II is **MUSICAM**[®]. Users around the world have judged it better than Layer II or Layer III and made **MUSICAM**[®] the world standard for digital audio in radio and TV, ISDN, cable, satellites, film sound, music recording and DAB.

Don't rely on primitive technology for your audio masterpieces. For the best sounding digital audio every time, make sure it's **MUSICAM**[®]. Call for the facts.

670 North Beers Street • Building 4
Holmdel, NJ 07733 USA
Tel: (908) 739-5600
Fax: (908) 739-1818



"Because it Sounds the Best"

Radio Describes Martians

▶ continued from page 35

Phillips had been identified at a Trenton hospital.

The Red Cross announced 10 teams of workers had been assigned to the Grovers Mill area to help out.

Captain Lansing of the State Militia then came on the air. He was calm and was convinced the situation was under control.

The cylinder was guarded on all sides by eight battalions of militia, he revealed.

"The troops are without heavy field pieces," he stated, "but adequately armed with rifles and machine guns. There is no cause for alarm, if indeed cause ever existed ... with all their reported resources, these creatures can hardly stand up against heavy machine gun fire. Anyway, it should be an interesting outing for the troops.

"Well, we ought to see some action soon. One of the companies is deployed on the left flank. A quick thrust and it will all be over."

He reported seeing a shadow at the top of the cylinder. Then he declared: "Now the troops are on the edge of the Wilmot Farm. Seven thousand men closing in on a metal tube."

Monster takes control

Then "Wait! That wasn't a shadow! The thing is rearing up on metal legs above the trees. Hold on!"

There was silence! Then the tense voice of a radio announcer was heard. He said: "Ladies and gentlemen, I have a grave announcement to make. Incredible as it may seem, both the observations of science and the evidence of our eyes lead to the inescapable assumption that those strange beings who landed in the Jersey farmlands tonight are vanguard of an invading

army from the planet Mars.

"The battle which took place tonight at Grovers Mill has ended in one of the most startling defeats ever suffered by an army in modern times; 7,000 men armed with rifles and machine guns pitted against a single fighting



H.G. Wells' science fiction story inspired the celebrated radio show.

machine of the invaders from Mars. Only 120 known survivors. The rest strewn over the battle area from Grovers Mill to Plainsboro, crushed and trampled under the metal feet of the monster. The monster is now in control of the middle section of New Jersey!"

Highways were reported clogged with "frantic human traffic." By daybreak, it was expected that Philadelphia, Camden and Trenton would have twice their normal population. Martial law

prevailed in New Jersey and East Pennsylvania.

Martian rockets were reported landing in all parts of the United States and the world. The U.S. Army Air Corps assigned planes from a Virginia air base to blow up the cylinders, which were walking around on their metal legs now. The planes didn't stand a chance against the heat ray. The air battle took place over Bayonne.

A telephone operator in Plainfield reported seeing a rocket land there. The 26th Field Artillery fired off three rounds against an oncoming cylinder, and then was destroyed.

Poison gas deployed

The invaders, as they moved north, started using poison gas. They were headed for New York City.

In Newark, gas masks were used as protection against the Martian poison gas. They didn't work. Newark was reported to be undemolished, but "humbled by some whim of the advancing Martian."

The world as we know it appeared to be doomed.

And then the voice on the radio announced there would be a pause for a station identification while the stations on the Columbia Broadcasting System identified themselves, after which the second half of the radio version of H.G. Wells' "War of the Worlds" would be heard.

Only a half hour had gone by since the Mercury Theatre's radio drama had started, yet a lot had happened in New Jersey during those 30 minutes.

Women fainting ...

Countless motorists had heard the show on their car radios, and headed for the Trenton-Princeton area to get a peek at the cylinder. In scores of New Jersey homes it was reported "women fainted as the horror of the broadcast fell on their ears." In Palmyra, some home owners packed up what belongings they could and headed for Philadelphia.

At the Hillside police station, a white-face man asked where he could get a gas mask. He claimed "some terrible people are spraying liquid gas all over the Jersey meadows." A weeping woman stopped motorcycle officer Lawrence Treger, and asked him where to go to escape the gas attack.

In Stockton, about 50 people staying at a place called Colligan's Inn formed a motor caravan and headed for nearby Groveville to view the damage.

At Princeton, a group of faculty members went to a place called Grovers Corner to see what they could see.

A member of the Princeton Press Club reported seeing a meteor land, and "animals" jumping out of it.

The police switchboards in Trenton, Jersey City and Newark were swamped with calls.

In the Clinton Hills section of Newark, home owners were packing up

and leaving. It took a while for police to convince them they had only heard a radio drama. A dozen people were reportedly treated for shock in Newark hospitals.

A member of the flock rushed into the evening service at the First Baptist

It was simply meant to be a harmless Halloween eve radio show.

Church in Caldwell, and announced North Jersey was going to be bombarded by meteors. The congregation prayed.

Hysteria peaked, and the New Jersey State Police sent out a special bulletin to all barracks instructing troopers on how to best deal with the panic, which had spread to all corners of the nation.

Many would blush later, at what they had done that night. But, at the time, the horror of it all was real.

Traveling commentary

Professor Pearson — remember him? — somehow managed to survive the



Most Americans were listening to Bergen and McCarthy - the top-rated show in the land - that Sunday night.

first half of the radio show; probably because he was played by Orson Welles, and had a meaty part during the second half.

He spent the next 30 minutes roaming around New Jersey and commenting on the destruction he came across. In Newark, he encountered "a former member of the New Jersey National Guard" who planned to live underground in sewers and cellars, and eventually lead a small army of survivors. They would capture a few of the Martian space machines and use them against the invaders.

After his chat with this gentleman, Princeton scholar Pearson strolled through the Holland Tunnel and up Canal Street. He came across "19 of the metal titans" parked in Central Park.

Overhead, vultures circled. And then they swooped down and feasted on the bodies of dead Martians who had been destroyed, as Pearson put it, "by a disease bacteria" their out-of-this-world systems lacked the ability to handle. Simply stated, they caught pneumonia and died.

The invasion was over!

New Jersey was saved! So was the rest of the world!

□□□

Richard O'Donnel is a semi-retired writer living in Florida, who formerly wrote an "off-beat" news column for the Boston Globe. Reach him care of RW.

BELAR STEREO MONITOR

You can measure... with the best monitor and the most accurate test set.

The FMM-2/FMS-2 series monitors provide an even greater degree of precision measurement than ever before... **You can measure S/N below 90 dB, You can measure crosstalk below 85 dB, You can measure separations of better than 70 dB, You can measure frequency response to better than 0.25 dB, You can measure distortions to lower than 0.01%, and much more...** Our uncluttered panels and autoranging voltmeters make these measurements a dream.

BELAR ELECTRONICS LABORATORY, INC.
LANCASTER AVENUE AT DORSET, DEVON, PENNSYLVANIA 19333
Call or write for more information on Belar AM, FM, Stereo, SCA and TV monitors.

(610) 687-5550

ABOUT THE ONLY THING
IT CAN'T DO FOR
YOUR TALK SHOW HOST IS
MAKE EVERY
CALLER SOUND
INTELLIGENT.



Occasionally, every talk show has to deal with an out of touch caller. But that's probably not the worst of your talk show host's problems. Chances are, your host is also trying to screen calls, conference multiple lines and make smooth transitions to commercial breaks — all while trying to come up with a snappy comeback for the space cadet on line 3. That's why we've updated the old talk show phone with the TS612. All the important functions are clearly marked and the phone lines color coded to make on-air decisions hassle free. Want to screen calls? Press **SCRN**. Want to conference up to four lines? Press

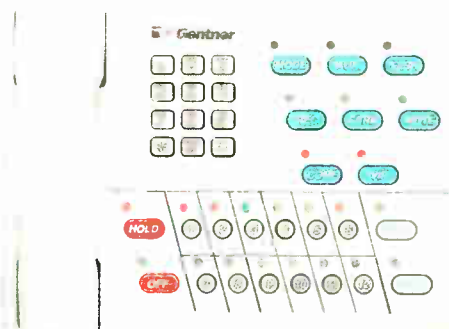

THE TS612 HANDLES
UP TO 12 PHONE LINES.

CONF. Don't want to lose a very important caller? Press **VIP**. Your host can even call for pastrami on rye while on-air some caller explains the finer points of cloud-watching. The point is, the TS612 is simple, versatile and lets your host concentrate on the show rather than the phone system. To find out more, call us.

 **Gentner**

1 - 800 - 945 - 7730

OR 1 - 801 - 975 - 7200

NEW !!!

Trak*Star III-

**4 x the power
& On Sale !!!!**



- **The #1 selling Trak*Star II has a NEW big brother !!!**
- **Trak*Star III has 4 times the power of Trak*Star II with...**
 - **Real time fade**
 - **Effects bus**
 - **New screen design**
 - **Edit & assemble files up to 6 hours long**
 - **many other powerful new features.**
- **Complete backup capability for your On Air Digilink**
- **Trak*Star III now comes with a 1.2GB drive standard**

Trak*Star III is a *NEW* multipurpose digital audio workstation for multitrack mixing and editing. Fully compatible with the #1 selling and industry standard Digilink & Trak*Star II, the Trak*Star III has four times the raw processing power of the Trak*Star II with many new features that utilize this remarkable new power... *real time fade, effects loop, 4 autolocator points, edit files up to 6 hours long, punch in-out, a 1.2GB drive standard, Digilink backup software, & 100's of others.*

Trak*Star, by Arrakis Systems, is the first cost effective multitrack digital audio recorder, mixer, and editor designed specifically for the radio broadcast professional. Also, Trak*Star is the only multitrack editor that is a complete backup to your Digilink on air workstation in every way right down to the audio routing switcher and control logic. More than just a digital editor, a Trak*Star digital workstation is a completely integrated digital solution that interfaces throughout your station to On Air, News, Editing, Traffic, etc. for transfer of digital audio, schedules, text, E-mail, and News wires.

With Trak*Star, creating spots, jingles, and liners has never been easier. Record and store on disk all of your standard music beds and sound effects. Select any combination of up to 4 stereo or mono sound files for editing and mixing. Once selected, you can easily scrub, cut, splice, copy, move, delete, fade, and mix any combination of these files to create your new spot or jingle. Record or overdub new voice tracks into the system while simultaneously playing back your preassembled mix. No matter how much you cut, splice, or throw away pieces of files... non-destructive digital editing leaves your original files unchanged. With Trak*Star you have unprecedented levels of control when you cut and splice by expanding tracks and actually working with the waveform itself. Trak*Star completely revolutionizes multitrack audio production for radio.



*The 22,000 series console can add even more functionality to Trak*Star by providing video & audio monitoring, plus audio input & output feeds*

Trak*Star is literally a complete multitrack studio in a compact box. As a radio specific product by Arrakis Systems, the Trak*Star works the way you do with the features and price that you need.

Call now to find out how this amazing new workstation can be made to work for you.

Sale !!!

TS3-600 **\$5,995**

(a \$7,995 value)

for more information call... (303) 224-2248

in some areas, call (970) 224-2248



arrakis
SYSTEMS INC.

2619 Midpoint Drive, Fort Collins, CO. 80525
Voice- 303-224-2248, Fax- 303-493-1076

*We've taken all we know, all you've asked for,
and the very best of today's technology to
bring you our **FINEST AUDIO CONSOLE***

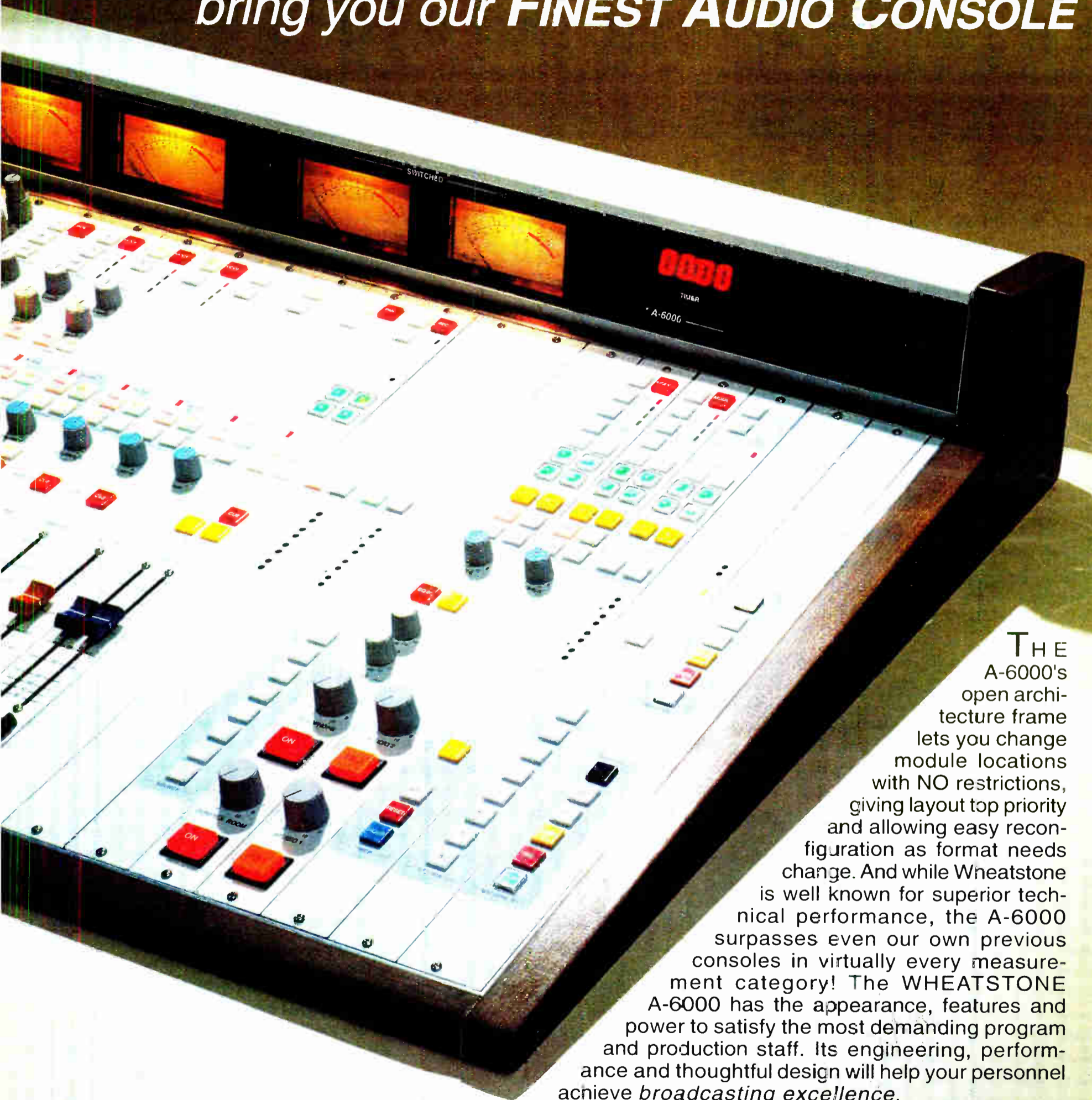

THE A-6000's open architecture frame lets you change module locations with NO restrictions, giving layout top priority and allowing easy reconfiguration as format needs change. And while Wheatstone is well known for superior technical performance, the A-6000 surpasses even our own previous consoles in virtually every measurement category! The WHEATSTONE A-6000 has the appearance, features and power to satisfy the most demanding program and production staff. Its engineering, performance and thoughtful design will help your personnel achieve *broadcasting excellence*.

A - 6 0 0 0 B R O A D C A S T C O N S O L E

7305 Performance Drive, Syracuse, NY. 13212
(te 315-452-5000 / fax 315-452-0160)

 Wheatstone Corporation

Why Auditronics' 210 console remains radio's virtual standard

The contemporary 210 console contains exactly those features and qualities your on-air people tell us they need to do their best work. Nothing more, nothing less.

The Auditronics 210 has the best record for up-time of any radio console. It just plain works, elegantly, all day, every day, all year, every year.

And, most important in this age of cost concern, we've made our production more efficient, so we can deliver today's 210 console at a price less than that of over a decade ago.

It's no wonder the 210 console continues to be the on-air mixer of choice among quality-conscious broadcasters. Choose the Auditronics 210 for your next console replacement or upgrade. Call 901-362-1350 today for complete information.

This Auditronics 210-18 in KPFA-Berkeley's on-air studio is one of four 210s in use at the Pacifica Foundation station.



auditronics, inc.

3750 Old Getwell Road, Memphis, Tennessee 38118 • 901-362-1350 FAX 901-365-8629

Circle (31) On Reader Service Card

TURNABLES...WTB

Collins pre amp (5) phono EQ, \$50/ea; RCA BQ51 TT, cabinet, stereo or mono preamp, \$250. D Lundy, Lundy Recording, Cumberland Gap Pkwy, Heidrick KY 40949. 606-546-6650.

Henry Eng universal TT controller, \$40 + shipping; Technics SP-10MK II (2) with base, Audio Technica tone arms, \$100/ea. C Slayton, 738 Jellison Blvd, Duncanville TX 75116. 214-283-3311.

ADVERTISE! in Radio World, Call 800-336-3045

EMPLOYMENT

To place ads in this section, use the ActionGram form. To respond to box numbers write Radio World, PO Box 1214, Falls Church, VA 22041. Attn: _____

POSITIONS WANTED

Chief engineer, AM &/or FM, former CE Houston, Miami, Boston, Ft Lauderdale, FCC general, ham, non-drinker. M Gottesman, 758 St Michael St #1005, Mobile AL 36602-1326.

Freelance Mix show/club DJ avail for digitally rcded, custom music mixes, 6 yrs club & radio exper, mix show programming, on-air & pro, set your station apart from the rest. Dave, 313-483-5882.

Good PR skills, great motivator, very interested in sales, good team plyr w/lots of talent, eager & ready to work, you be the judge. Rick, 405-386-6524.

Looking for a different voice for your commercials, VO's, liners & open & closes, give me a call, the first one is on me, incl standard ground delivery, will write &/or produce, when you call ask about our royalty-free buyout, customized jingles, rock bottom prices. Paul, 208-324-2593.

My girlfriend found out about my love affair w/radio & left me, bring "The Slug Bodean Show" to your station. Russ, 307-362-7211.

Design/Construction Engineer seeks position in San Diego, 14 yrs exp in major mkt networ/radio and post prod audio studios, avail as staff or freelance. John, 914-477-0117.

Program directors; have you been interested in a very knowledgeable DJ specializing in vintage Soul music w/a great personality that can enhance your bottom line by doing a 4-hour (morning, afternoon, evening) show? Free one hour audio tape to see if I can do something for your radio station, The Greg Foster R&B Radio Show, audio entertainment at it's very best! 800-770-7878.

Help me! Young bdctng grad looking for progressive stn to assist my plans for world domination, will divide Nova Scotia, Mara, 405-631-8484.

Due to VOA downsizing, prof anncr for adult std or news-talk announce shift, brd op and prod. Alex, 513-777-8423.

HELP WANTED

FM BROADCAST ENGINEER Position requires excellent ethics and character, previous and current employment in rated markets, knowledge and experience in contemporary theory and practice. Resume to: Chris Hicks, 900 East Washington St., Suite 315, Colton, CA 92324. No calls EOE/EEO

TM Century, Inc. needs additional "Technical Support" personnel for Ultimate Digital Studio and related products. Knowledge and experience with the UDS System is preferred. Requires relocation to Dallas, TX. Send resumes to: Gary Hollis, TM Century, Inc. 2002 Academy, Dallas, TX 75234 214-406-6855 fax 214-406-6897

ABOUT OUR EMPLOYMENT SECTION

HELP WANTED

Any company or station can run "Help Wanted" ads for \$1.50/word or buy a display box for \$60/column inch. Payment must accompany insert, use your MasterCard or VISA; there will be no invoicing. Blind box numbers will be provided at an extra charge of \$10. Responses will be forwarded to listee, unopened, upon receipt. Call 800-336-3045 for details.

POSITIONS WANTED

Any individual can run a "Position Wanted" ad, FREE of charge (25 words max), and it will appear in the following 2 issues of Radio World. Contact information will be provided, but if a blind box number is required, there is a \$10 fee which must be paid with the listing (there will be no invoicing). Responses will be forwarded to the listee, unopened.

Mail to: BROADCAST EQUIPMENT EXCHANGE, PO Box 1214, Falls Church, VA 22041 Attn: Simone Mullins

SUBSCRIPTION/READER SERVICE FORM



FREE Subscription/Renewal Card I would like to receive or continue receiving Radio World FREE each month. Yes No

Signature _____ Date _____ Please print and include all information: Name _____ Title _____ Company/Station _____ Address _____ City _____ State _____ ZIP _____ Business Telephone () _____

Please check only one entry for each category: I. Type of Firm [] D. Combination AM/FM station [] F. Recording Studio [] A. Commercial AM station [] K. Radio Station Services [] B. Commercial FM station [] G. TV station/teleprod facility [] C. Educational FM station [] H. Consultant/ind engineer [] E. Network/group owner [] I. Mfg, distributor or dealer [] J. Other _____ II. Job Function [] A. Ownership [] G. Sales [] B. General management [] E. News operations [] C. Engineering [] F. Other (specify) [] D. Programming/production _____

Reader Service

October 18, 1995 Use until January 18, 1996 Please first fill out contact information at left. Then check each advertisement for corresponding number and circle below. Purchasing Authority 1. Recommend 2. Specify 3. Approve 001 023 045 067 089 111 133 155 177 199 002 024 046 068 090 112 134 156 178 200 003 025 047 069 091 113 135 157 179 201 004 026 048 070 092 114 136 158 180 202 005 027 049 071 093 115 137 159 181 203 006 028 050 072 094 116 138 180 182 204 007 029 051 073 095 117 139 161 183 205 008 030 052 074 096 118 140 162 184 206 009 031 053 075 097 119 141 163 185 207 010 032 054 076 098 120 142 164 186 208 011 033 055 077 099 121 143 165 187 209 012 034 056 078 100 122 144 166 188 210 013 035 057 079 101 123 145 167 189 211 014 036 058 080 102 124 146 168 190 212 015 037 059 081 103 125 147 169 191 213 016 038 060 082 104 126 148 170 192 214 017 039 061 083 105 127 149 171 193 215 018 040 062 084 106 128 150 172 194 216 019 041 063 085 107 129 151 173 195 217 020 042 064 086 108 130 152 174 196 218 021 043 065 087 109 131 153 175 197 219 022 044 066 088 110 132 154 176 198 220

Copy & Mail to: Radio World, PO Box 1214, Falls Church, VA 22041, or FAX to: 703-998-2966

ADVERTISER INDEX

This listing is provided for the convenience of our readers. Radio World assumes no liability for inaccuracy.

Table with 5 columns: Page No., Advertiser, Reader Service No., Page No., Advertiser, Reader Service No. Lists various advertisers and their corresponding page numbers and reader service numbers.

Table listing staff members and their roles: Publisher (Stevan B. Dana), Associate Publisher (Carmel King), Marketing Consultant (Al Leon), Marketing Assistant (Eva Marie Krell), Production Director (Lisa Stafford), Publication/Desktop Systems Mgr (Julianne Shannon Stone), Classified/Showcase Production Coordinator (Vicky Baron), Ad Traffic Coordinator (Kathy Jackson), Ad Production Coordinator (Lisa Lyons), Production Assistants (Trina Masters, James Cornett), Ad Coordination Manager (Simone Mullins), Circulation Director (Eleya Finch), Circulation Manager (Steven Bowman), Accounts Receivable (Steve Berto).

Advertising Sales Representatives

Table listing advertising sales representatives and their contact information: U.S. East: Skip Tash (703-998-7600 Fax: 703-998-2966), U.S. West: Dale Tucker (916-721-3410 Fax: 916-729-0810), International: Stevan B. Dana (+1-703-998-7600 Fax: +1-998-2966), Europe: Dario Calabrese (+39-2-7030-0310 Fax: +39-2-7030-0211), Japan: Eiji Yoshikawa (+81-3-3327-2688 Fax: +81-3-3327-3010). Includes note: Free subscriptions are available upon request to professional broadcasting and audiovisual equipment users. For address changes, send current and new address to RW a month in advance at P.O. Box 1214, Falls Church, VA 22041. Unsolicited manuscripts are welcomed for review: send to the attention of the appropriate editor.



Broadcast Equipment Exchange

Is read by over 18,000 Broadcast

Equipment Users Every Month! Sell

Your Used Equipment Here. Call or

Telephone 1-800-336-3045 FAX 703-998-2966

FAX Simone Mullins for Information on Affordable Advertising Rates.

STATIONS...WTB

Bdctr, not broker wants station(s), AM or FM, in S AL, W FL, E GA areas, prefer high pwr, but will consider all. Bdctr, 906 Northwood Cir, Nacogdoches TX 75961.

Cash for CP or distressed FM in CA or NV, must have potential to be viable, principals or brokers OK. Phone or FAX, 818-831-6787.

Small radio station in NE Mid-Atlantic region, CP considered, \$60K or less. C Davis, 6802 Fox Meadow Rd, Baltimore MD 21207. 410-298-5958.

STEREO GENERATORS

Want To Sell

Optimod 8000A FM stereo gen & processor, re-chipped, BO; TM Century auto segue unit, handles up to 3 CD plyrs, contains faders that respond to TM Century cue tones. BO. T Stafford, 501-933-0403 FAX.

TAPES/CARTS/REELS & CD's

A&D
Cart Rebuilding
Do Bad Carts Have Your Temperature Rising?
Let A&D clean, load & pack your carts. They'll be serviced within 10 working days! *Guaranteed!*
3706 Vold Ct. 715-835-7347
Eau Claire WI 54701 Fax: 715-835-1151

Want To Sell

418 carts, Scotch carts, mostly music length, good to very good cond w/AC music, \$500/all. Randy, 815-942-2839.

Aristocart A W 20 (110) cart racks, holds 20 carts ea, \$550; Dynamax ESD 10 eraser splice finder, good cond, \$400. D Kelly, 402-372-5423.

Black Scotchcart IIs, 300 3.5 min, almost new cond, \$1.90/ea+shpg. B Lord, 206-932-4839.

1-800-TAPE WORLD or 1-800-245-6000
We'll beat any price! 5.95 SHIPPING • FREE CAT.

SONY	MAXELL	TDK	FUJI
DAT-120 7.49	XL11-90 1.69	DAT-120 6.49	SA-95 1.21-1.49
DAT-124 9.99	KL115-90 2.29	SA-90 7.99	SA-124 1.09-1.99
T-120V 2.09	ST-120 6.99	SA-90 1.59	H18 120 5.99
LT-750HS 3.99	DAT-124 7.99	SA-90 1.33	DENON
JVC T120 1.79	3M CDR 74 7.99	1120 EHG 2.49	DAT-120 5.99
JVC ST-120 5.99	30 30 99	CDR-74 8.99	DAT-60 4.99

TAPE WORLD 220 SPRING ST., BUTLER, PA 16003, FAX 412-263-8296
OVER 500 DIFFERENT, SAME DAY SHIPPING, M-F, 8-5

Compl formats on 10 1/2" reels, w/ques, AC Gold, Big Band, Country, also Beautiful Music background instrumental, many on metal reels, \$15/reel, sets only. Rt 2 Box 399, Harpers Ferry WV 25425. 304-725-9425.

BASF/Scotch (20) grey & white plastic library boxes for 7" reels, incl Scotch 3M empty 7" metal reels (20), \$50. D Green, Moonlight Rec, 3433 Winifred, Ft Worth TX 76133. 817-346-6228.

C-90 duplication overrun, new, 1st qual, \$.20/ea in 1000 qty/\$.25 in 500 qty. L Wagner, Ardnigva Radio Network, POB 1788, Orlando FL 32802. 407-299-1299.

Carts (300), various length, fair/good cond, \$200. J Pittmann, 12104 Old Hwy 169, Hibbing MN 55746. 218-263-3000.

Gold Mastercarts (500), music length, some shorter lengths avail, exc cond, \$50/100 + shp. E Moody, KJEM, 216 N Main St, Bentonville AR 72712. 501-273-9039.

Music libraries, MOR (1), Soft Contemporary/MOR (1), Rock and Roll (1), on Ampex 456 10.5 metal reels; 1100+ LP's, Big Band/MOR, Contemporary, Rock and Roll. J Gelo, 941-642-6899.

Scotchcart II, 3.5 min (300), vgc, \$1.90/ea + shpg. B Lord, 3824 SW Myrtle St, Seattle WA 98126. 206-932-4839.

AC Music Library: approximately 1,000 carts of 70's, early 80's, \$950/BO. Call Jim 703-250-9529 & leave message.

TAX DEDUCTIBLE

Non-commercial stn seeks donation of stereo control board in gd cond, five chnl or more, prefer complete w/all manuals, would like ADM board or similar, tax deductible receipt for value, will pay shipping. J Cutroni, 508-753-1012.

Non-profit org seeks donation of Orban 9100A AM mono or stereo multiband processor, will provide letter. K Hutcheson, KBIB, RT1 Box 95-C, Marion TX 78124. 210-914-2083.

TEST EQUIPMENT

Want To Sell

Heath AG-8 audio oscillator, \$20/BO; Running time meter, 1 hr divisions, 115V, \$20+UPS. E Davison, 217-793-0400.

Potomac Instruments FIM-21 & Nems Clark 120E field strength meters, trade only-both for 1 FIM-41; Bird 8745-677 20 kW port dummy load, requires external water sply, \$750. Gary, 919-790-6315.

Tektronix 7613 storage mainframe, 7L12 spectrum analyzer, 7L5 spectrum analyzer w/option 25, 7K11 CATV preamp & carrying case for extra plug in units, \$7500/BO. S Lockwood, 206-783-9151.

Anritsu MW98A fiber optic analyzer w/MH925A plug in for 1300 nanometer single mode, \$1000; Halcyon 802A, porcol analyzer and data link monitor, \$500. Joe, JCF Labs, POB 184, Lincoln city, 97367, 503-994-9023.

Carron STE-100, stereo phase enhancer, \$150 + shp. C Slayton, 738 Jellison Blvd, Duncanville TX 75116. 214-283-3311.

JDR 2000 Oscilloscope, \$150. L Houck, Rolling Rcdng, 208 River Ranch Rd, Boerne TX 78006. 210-537-5494.

TRANSMITTERS

Want To Sell

BE-FM30 30 kW FM xmtr+FX30 exciter, only 40K hrs, in storage. BO. Gates FM-5C 5 kW FM xmtr, needs rebuild, PCB capacitors removed, no exciter, \$2000, you haul. Gary, 919-790-6315.

FM-Transmitters

Translators & Amplifiers
Solid State 15 watt to 6 Kw.
Jimmie Joynt
Factory Direct Sales
800/279-3326

Cetec-Sparta 602A 2.5 kW FM xmtr, tuned to 100.9 MHz w/exciter manuals, new, \$6500. R Mason, 703-962-1133.

Collins 831 D-1 FM xmtr, operated @ 1700 W on 104.9 MHz from 1971 to 1994, good cond, BO; Collins 310Z-1B FM exciter, operated on 104.9 MHz from 1971 to 1989, after 1989 used as backup, BO. T Stafford, 501-933-0403 FAX.

CONTACTORS

BY
» GELECO «
Ph: (416) 421-5631
Fax: (416) 421-3880

Continental 315A-1 1984 5 kW on 1430 kHz, very good cond, \$17,500. T Love, WOBW/WMGR, 912-439-9704.

Harris 1987 FM 3.5K xmtr, type accepted TPO 4.0 kW @ 92.1 MHz w/MX-15 exciter, currently on air, avail 9/15/95, \$16,500. M Harris, KDOK, Tyler TX, 903-593-2519.

RCA BTA-10U 10 kW AM xmtr, needs repairs, \$3500. B Barry, WAMB, 615-889-1960.

Wilkinson AM-1K 1 kW AM @ 840 kHz, 23 yrs old, \$1500; Harris FM 3.5 k 107.9 MHz 9-bay antenna & 300' of xmsn line, \$17,000. D Kelly, 402-372-5423.

Xformers, chokes & other parts for Gates BC1-J & later series xmtrs, incl new, Peter Dahl mod reactor, all tested, BO. Mike, 615-741-2277.

RCA BTA 5 F 5 kW AM, excellent cond, all manuals, fir layouts, \$7500 + s&h. G Heidenfeldt, WRGH, 2880 W Lake Rd, Wilson NY 14172. 716-751-6187.

Visual Electronics DFM-5KB, 5000 W single phase, \$4750. P Lopeman, 4359 S Howell Ave, Milwaukee WI 53207. 414-482-2638.

QEI amplifiers, exciters and stereo generators. All are reconditioned and are tuned and tested on your frequency. 6 month warranty is included. If you want quality used equipment, call or fax 609-232-1625 and ask for Bob Brown.

Used equipment for sale: Belar SCM-1, Belar RFA-1, Belar FMS-1, Belar FMM-1, Moseley MRC 1600 system, TFT EBS rcvr/generator, Gentner patch panel, and Harris racks. Call Transcom Corp, 800-441-8454 or 215-884-0888.

Want To Buy

Harris SX-1A 2.5 kW, gd shape & reasonable. T Yarbrough, 615-967-2201.

RCA 5 kW AM, type BTA-5U & 10 kW AM, BTA-10U, any condition for parts. B Barry, WAMB, 615-889-1960.

10 - 25 kW FM in lower portion of FM band, E Moody, KJEM, 216 N Main St, Bentonville AR 72712. 501-273-9039.

20 kW FM w/exciter, prefer Harris, BE or Continental, clean, will consider PU in NE or midwest. D Payne, WZPL, 317-879-9999.

FM 15-20 kW w/exciter, spare parts, manuals, must be in working order. Andy, 520-855-9000.

Harris, Continental, CCA, or QEI. 5 kW, prefer 1975/newer, working or not. P Lopeman, 4359 S Howell Ave, Milwaukee WI 53207. 414-482-2638.

McMartin AM/FM transmitter, any model, exciter or stereo modules. Goodrich Enterprises, 11435 Mander-son, Omaha NE 68164. 402-493-1886.

TUBES

Want To Sell

4X150A, 4CX250B, 4-400, 4-1000, 807, 833, 8874, 8877, RCA, Amperex, EIMAC, etc. Westgate 800-213-4563.

D and C Electronics Co.
Lowest Price on Tubes including:
4-1000A/3-1000Z/
8877/4CX250B/833A
4-500/5-500/4-400/
4CX 3500/5CX1500
and much more!
Factory Warranty!
1-800-881-2374
(904) 688-2374
Se habla Español
FAX: (904) 683-9595

REBUILT ELECTRON TUBES
Partial List: 6623, 23791, TH150, 6425F, 5604, 6696, 6697, 5681, 5682, 5671, 7804, 3CX10,000H3, 3CX20,000H3, 4CX5000A, 4CX35,000C
Worn out power tubes purchased
Vacuum Tube Industries, Inc.
1-800-528-5014
508-584-4500 X75

ECONCO
Quality Rebuilt Tubes
Approximately 1/2 the Cost of New
Call for Our Price List
800-532-6626
916-662-7553
FAX 916-666-7760
Circle (197) On Reader Service Card

Svetlana
ELECTRON DEVICES
Quality* Power Tubes

3CX15,000A7	4CX400A
3CX15,000A3	4CX350AC
3CX15,000H3	4CX350A/8321
3CX10,000H3	4CX250R/7580W
3CX10,000A7	4CX250BT
3CX3000F7/8162	4CX250BT
3CX3000A7	4CX250BC/8957
3CX2500H3	4CX250B/7203
3CX2500F3/8251	4X150A/7034
3CX2500A3/8161	5CX1500B
4CX15,000A/8281	5CX1500A
4CX10,000D/8171	YC130/9019
4CX5000A/8170	8560AS
4CX3500A	811A
4CX1600B	833A
4CX1500A	833C

- Watch this list grow.
- Shipment from USA stock.
- Manufactured in Russia's largest power tube factory.
- Generous* warranty based on high quality.
- Honest prices based on quality at low cost.

Broadcasters
Phone: 800-239-6900
205-882-1344
FAX: 205-880-8077
OEMs, Distributors
Phone US: 800-578-3852
Int'l & US: 415-233-0429
FAX: 415-233-0439

Circle (105) On Reader Service Card

Want To Buy
3CX30000A7 and 5CX1500B. P Lopeman, 4359 S Howell Ave, Milwaukee WI 53207. 414-482-2638.

TURNTABLES
Want To Sell
Sparta 2-spnd (2) TTs w/"bag" of spare parts, tired but operational, BO. C Tracy, WKNE, 603-352-9230.

TRANSCOM CORP.
Serving the Broadcast Industry Since 1978

Fine Used AM & FM Transmitters and Also New Equipment
For the best deals on Celwave products, Andrew cable and Shively antennas.

1 kW FM 1978	Collins 831C-2	1 kW AM 1966	Gates BC1G
2.5 kW FM 1978	Harris FM2.5K	5 kW AM 1979	Continental 315-F
2.5 kW FM 1983	Harris FM2.5K	5 kW AM 1978	Harris MW5A/B
4 kW FM 1978	CCA 40E	5 kW AM 1977	RCA BTA 5L
5 kW FM 196?	Gates FM5B	10 kW AM 1974	CSI T-10-A
10 kW FM 1968	RCA BTF 10D		
10 kW FM 1971	Collins 830F-1B		
20 kW FM 1974	Collins 831G-2/ Cont 816R-2		
20 kW FM 1968	RCA BTF 20E		

1077 Rydal Road #101
Rydal PA 19046
800-441-8454 • 215-884-0888 • FAX No. 215-884-0738

Circle (13) On Reader Service Card

"HEY!"
"Have you heard?"
"The **STL-1** and **STL-2** are the hottest selling Composite STL's around!"

- Excellent Specs
- Excellent Quality
- Excellent Price

Complete STL-1 10 watt System \$4,495

FOR DETAILS, CONTACT YOUR ENERGY-ONIX DEALER TODAY!

"The Transmitter People"
Energy-Onix
518-828-1690
FAX: 518-828-8476
752 Warren Street, Hudson NY 12534

Circle (82) On Reader Service Card

REMOTE/MICRO EQUIP...WTS

Moseley MRC 1600 16-channel, \$1000; TFT 7601 10-channel, \$500. B Spitzer, KKLS/KMK, 605-343-6161.

Moseley DRS-1 30-channel digital/analog remote control, 2 compl systems with status & limit alarms, \$650/ea. Gary, 919-790-6315.

MCI 10 W, transmitter/receiver, type appvd, \$3250. P Lopeman, 4359 S Howell Ave, Milwaukee WI 53207. 414-482-2638.

Moseley PCL 600C STL on 94.6 mHz. Joe, JCF Labs, POB 184, Lincoln city, 97367. 503-994-9023.

NEW EASY WAY TO DO REMOTES!
With Attention Winning L.A.B. SERIES PODIUMS

NEW PODIUM/19" RACK COMBO rolls on wheels and slides quickly into vans!

PREMOUNT YOUR REMOTE GEAR RPU's, mixers, amps, tuners just once and you're ready to go in a snap

SPACEWISE BROADCAST FURNITURE AC prewired/XLRs/mic stand
"Using Your Space Wisely" Built-in speaker options

For Free Info, Call 800-775-3660

SATELLITE EQUIPMENT

Want To Sell

SATELLITE SYSTEMS

Satellite Equipment for Radio

Satellite Systems **repairs** all major brands of satellite equipment, including the Fairchild Dart 384 and Scientific Atlanta 7300. Our **turn-around time averages 24-hours**. Plus, we provide pre-and post-service technical support along with a **90-day warranty** (with exception of shipping charges).

Satellite Systems **sells Zephyrus** SCPC, Jones Satellite Networks, the **Ariel** and other available models. **Just call and ask!**

Satellite Systems, Inc.
615 East Brookside
Colorado Springs, CO 80906
(719)634-6319 Fx: (719)635-8151

UNIVERSAL SCPC XE-1000

NEW!

SCPC BROADCAST AUDIO RECEIVER

New, affordable, frequency-agile receiver, direct channel entry by keyboard, selectable companding 1:1, 2:1, 3:1, wide/narrow bandwidth, de-emphasis selectable, 950-1450 MHz, line output 600 ohms, muting, transponder agile, 1.1NB power supply, 50-channel memory, full baseband output, high-quality audio. Every needed feature at a sensible price (lowest in the industry). Write or call for full information on this quality receiver—the answer for your station. Networks call for prices.

Phone: (614) 866-4605 Fax: (614) 866-1201

UNIVERSAL ELECTRONICS, INC. 4555 Groves Road, Suite 12 Columbus, OH 43222
Communications Specialist Phone: (614) 866-4605 Fax: (614) 866-1201

Affordable TRAFFIC & BILLING

PC SOFTWARE for DIGILINK & other popular digital systems. Excellent for non-automated stations, too. Try it for 60 days. No obligation. For demo, call ABA Software (813) 643-3689

Circle (21) On Reader Service Card

RENT IT HERE! Call Steve Kirsch for Details

COMREX 1, 2, & 3-Line Extenders Switched 56/ISDN Systems

TELOS Zephyrus Digital Phone Hybrids

CCS "PRIMA" CODECS PP-410 Automatic Mixers

SHURE REMOTE AUDIO PACKAGES

SILVER LAKE AUDIO • 516-623-6114 • FAX: 516-377-4423

Marti RMC2 transmitter remote control, S400 + shipping. C Slayton, 738 Jellison Blvd, Duncannonville TX 75116. 214-283-3311.

WE RENT

TELOS ZEPHYR

CCS "Prima" Codecs Stereo RPU, NO License

COMREX 3 line extender

Frank Grundstein Audio/Video Consultants 610-642-0978

Want To Buy

Symetrix SX 203 telephone interface, any condition. Jim, 800-365-2268 ext 240.

REPAIR SERVICES

DENON CD CART PLAYER REPAIR

• Same Day Service
• Reasonable Rates
• We honor Denon Warranty

AUDIO VIDEO SERVICE LABS, INC.
800-765-4434
Quality Denon Service Since 1991
"The Best Kept Secret in Broadcasting"

Want To Buy

Mod Assoc 10 W solid-state HPA/Upcon, dual thread, no mods, for SCPC uplinking, \$7500/BO; Wegener 1806-24 satellite rcvr for FM squared format, \$500; Zephyrus Model 304/392 satellite rcvr, Moody, Jones, SMN formats, \$400. Gary, 919-790-6315.

SOFTWARE/DATABASES

Want To Sell

RADIR: THE RADIO STATION DATABASE
Obtain info & print mailing labels on 11,950+ stations. Many searches, gives phone/faxes/web site addresses! MS DOS or MAC (as tab delimited ASCII) SINGLE COPY PRICE SPECIAL: \$59.95 ppd.
1-800-277-8224
Internet: http://www.aenlo.com/4bbt/info

Prodelin 10' diameter 8 section fiber-glass dish & equip, high quality dish, gd cond, \$950/BO. C Rich, 317-268-2251.

Scientific Atlanta set w/SEDAT card, \$2500. P Lopeman, 4359 S Howell Ave, Milwaukee WI 53207. 414-482-2638.

Comstream ABR-200 receiver, like new, bargain. 615-457-2697.

STATIONS

Want To Sell

5 kW AM, 1410 kHz/200+ W night. 2 twr DA, perfect owner/operator, serious inquiries only, \$135,000. K Kuenzie, KFYE, 511 W 5th St, Washington MO 63090. 314-239-6800.

Southeast Class-A FM w/C3 construction permit to reach half million. Owner retiring. Send inquiries to: Radio World, POB 1214, Falls Church VA 22041. Attn: Box #95-10-18-1RW.

Springfield/Branson Market. Class C FM, and Class A FM - Daytime AM combo. Cash or terms. 417-326-6445.

Want To Buy

FM operating, dark or CP, exper bdctr, will consider joint venture, prefer purchase or lease. J Powley, 910-342-1843.

SERVICES

REMOTE EQUIPMENT RENTALS

COMREX and GENTNER
1, 2 & 3-Line Extender Systems
Now With The New TELOS ZEPHYR
MARTI VHF/UHF RPU Systems
ISDN & Switched-56 Systems
Call or FAX Dwight Weller

WELLER AUDIO-VISUAL ENGINEERING
Baltimore, Maryland
Phone: (410 or 800) 252-8351 FAX: (410) 252-4261

► **Propagation Services**
► **FM Studies**
► **Population Studies**
► **FCC/FAA Databases**
► **PC Software**

PC - SOFTWARE

AM FM TV Search Programs
Contour Mapping-STL Paths
RF HAZ-1990 POP Count
FAA Tower-Draw Tower

Doug Vernier
Broadcast Consultant
1600 Picturesque Dr
Cedar Falls, IA 50613

800-743-DOUG

GRAHAM BROCK, INC.
BROADCAST TECHNICAL CONSULTANTS

Full Service From Allocation to Operation
AM/FM/TV/AUX Services:
Field Work: Antenna and Facilities Design

Over 35 years engineering and consulting experience

912-638-8028
202-393-5133

North America RF & Audio

Mirkwood Engineering Services
Broadcast and Telecommunications Consultants

Multidiscipline Engineering and Planning Firm including: Application & Allocation Services
• Project, Engineering & Construction Management • Site Acquisition
• Rural & Remote Site Installations
• Field Service • Studio Design & Installation

50 Park Ave. Claremont, NH 03743
(603) 542-6784

HARRIS ALLIED
PARTS AND TECHNICAL SUPPORT

Now we can be reached online via e-mail, TSUPPORT@HARRIS.COM

For your parts needs or with any technical problems you're having.

Tower Sales & Erection

Quality Sales • Installation • Maintenance
AM-FM Broadcast TV
Antenna • STL • APL

TOWERCOMM
Communications Specialists

Ben Wall President
1777 S. 30th St
Raleigh, NC 27613
Tel: (919) 878-1614

Communications Data Services, Inc.

800-441-0034
703-534-0034
fax 703-534-7884
6105-E Arlington Blvd,
Falls Church, VA 22044

MLJ
Moffet, Larson & Johnson, Inc.
Consulting Telecommunications Engineers

1110 North Glebe Rd. #800
Arlington, VA 22201
(703) 741-3500
FAX: (703) 741-0312

Member AFCC

W. LEE SIMMONS & ASSOC., INC.
BROADCAST TELECOMMUNICATIONS CONSULTANTS

5 Gracefield Road
Hilton Head Is., SC 29928

1-800-277-5417
803-785-4445
FAX: 803-842-3371

MULLANEY ENGINEERING, INC.

• Design & Optimization of AM Directional Arrays
• Analysis for New Allocation, Site Relocation, and Upgrades
AM-FM-TV-LPTV
Wireless Cable (MDS/MMDS/ITFS-OFS)
• Environmental Radiation Analysis
• Field Work
• Expert Testimony

9049 Shady Grove Court
Gaithersburg, MD 20877
Phone: (301) 921-0115
Fax: (301) 590-9757

FM TRANSMITTER HELPLINE

24 Hour Emergency Phone Consultation

Specializing in:

- CCA/CSI
- Arcing Problems
- AEL FM Transmitters

MBE Enterprises
Phone: 818-772-8017
Pager 818-604-7925

REMOTE BROADCASTS IN THE U.K. AND EUROPE

Planning remotes from the U.K. or Europe? we offer a one-stop service

- we organize venues for your shows
- we provide temporary equipment
- live links via ISDN/Switched 56
- experienced radio engineers
- we help you line up guests

Contact London (44) 181 442 8900
Wired for Sound Ltd., London U.K.

Where In The World Are You?

Reach radio professionals worldwide by advertising in **Radio World's** international edition.

Call Simone for information.
1-800-336-3045

E. HAROLD MUNN, JR. & ASSOCIATES, INC.

Broadcast Engineering Consultants

AM - FM - TV

WAYNE S. REESE
PRESIDENT

Box 220, 100 Airport Rd.
Coldwater, MI 49036

517-278-7339

T. Z. Sawyer Technical Consultants
AM-FM-TV-LPTV

- FCC Applications & Exhibits
- Experimental Authorizations
- AM Directional Antennas
- High Power Antenna Arrays
- Frequency Studies
- Class Upgrades
- STL Applications
- Station Inspections

☎ 1-800-255-2632

Contact Radio World Newspaper for availabilities
P.O. Box 1214 Falls Church VA 22041
1-800-336-3045

FINANCIAL SERVICES...CONT'D

FINANCING

LOANS BY PHONE (800) 699-FLEX

- ☐ We finance all types of Broadcasting Equipment
- ☐ Flexible Credit Criteria
- ☐ Flexible Payment Plans
- ☐ No Down Payment, No Payments For 90-Days Available

To apply or request additional information call Jeff Wetter.

FLEX LEASE, Inc.

LIMITERS

Want To Sell

Orban Optimod FM 8100A, xint cond, incl spare Aphex #4 & #5 cards, orig box & manual, \$3500. G Barnett, 619-328-1104.

Orban Optimod 8100, \$2900. Gary, 919-790-6315.

Audimax 4440-A, Volumax 4400-A. T Coffman, Rolltop Music, POB 17203, San Diego CA 92177. 619-571-5031.

CVS Volumax 4110, compressor/limiter, gd cond, \$500. J Pittmann, 12104 Old Hwy 169, Hibbing MN 55746. 218-263-3000.

dbx 165A (2), compressor/limiter, \$250/ea + shp; Urei dual LA-3A limiters, rk mt, \$450 + shp; dbx 160 limiter, older type, rk mt, \$200 + shp. C Slayton, 738 Jellison Blvd, Duncanville TX 75116. 214-283-3311.

Gates 994-6543-001 (2) clean, work well, \$50/each + shipping. Ed, 8 Knot St, E Patchogue NY 11772. 516-654-8306.

Orban Optimod 8000 A, gd cond. P Lopeman, 4359 S Howell Ave, Milwaukee WI 53207. 414-482-2638.

Urei 1176LN pk limiter, \$250 + shp; Eventide (2) omnipressor limiters, \$100/both. C Slayton, 738 Jellison Blvd, Duncanville TX 75116. 214-283-3311.

Want To Buy

Gates, Inovonics, Fairchild, RCA, Urei, Teletronics, solid state, tube. T Coffman, Rolltop Music, POB 17203, San Diego CA 92177. 619-571-5031.

MICROPHONES

Want To Sell

EV 6x9 B lavolier, \$20; EV RE-50, \$30; EV DS-35, \$60; Realistic hand held UNI (3), \$20/ea; Atlas (6), desk mic stands, \$5/ea; Canare mic cables, 25', \$10 ea. L Houck, Rolling Rcdng, 208 River Ranch Rd, Boerne TX 78006. 210-537-5494.

Shure SM5B, make offer. P Lopeman, 4359 S Howell Ave, Milwaukee WI 53207. 414-482-2638.

EV PL20 (RE20) mics, good condition, \$325; RCA 77DX mics, re-conditioned with new ribbons; Neumann KM84 pair. W Gunn, 619-320-0728.

Want To Buy

Neumann U87 working or not. P Lopeman, 4359 S Howell Ave, Milwaukee WI 53207. 414-482-2638.

77-DX's, 44-BX's, WE KU-3A's On-Air lights, recording lights & audition lights. Top price paid. Fast response. Bill Bryant Mgmt, 2601 Hillsboro Rd, G12, Nashville TN 37212. 615-269-6131, FAX: 615-292-3434.

MISCELLANEOUS

Want To Sell

Muffin fans 6" & 9", mint condition, \$5/ea+UPS; Western Elect 111C repeat coil, 23A EQ, \$20/ea; 52 type headset with 153 amp, \$25+UPS. E Davison, 217-793-0400.

Paradyne 4951-03 equip rack, black, has full set of blank covers, \$175; Soundolier equip rack, \$120+shpg. B Lord, 206-932-4839.

ADC TRS patch bays (16) top row punches on rear and bottom row is wired to campe approx 20 ft, \$125/ea + shp; ADC Pro-patch bays (2), \$125 ea + shp; ADC TT pro-patch bay, \$175; ADC I-WS QCP wall mt panels, \$100/ea; Tellabs 248 RF (3), RF tight case for 4008 amp cards, \$35/ea + shp. C Slayton, 738 Jellison Blvd, Duncanville TX 75116. 214-283-3311.

AUDIO TRANSFORMER MAGIC



9K-600-6

audisar
P.O. Box 1561, Bellevue, WA 98009
206-454-2040

Circle (186) On Reader Service Card

ADC/TRIMN TRS audio patch cables, 6' (6); 4' (84); 3' (52); 2' (74); 1' (17); 6" (4); \$2.50/ea or \$400/all. C Slayton, 738 Jellison Blvd, Duncanville TX 75116. 214-283-3311.

Columbia C6046 27 pr audio cable, 2 line shield, \$5/ft; McMartin EBX-2 monitor, \$85; Gates automatic tape contrl, 19" rk mt, \$75. D Lundy, Lundy Rcdng, Cumberland Gap Pkwy, Heidrick KY 40949. 606-546-6650.

Gentner SPH-3A analog hybrid, w/manual & remote connector, \$500. S Schwiager, WXLO, 250 Commercial St, Worcester MA 01608. 508-752-1045.

HP 7550A graphics plotter, \$150 + shp. C Slayton, 738 Jellison Blvd, Duncanville TX 75116. 214-283-3311.

Magnavox antique, fir standing w/built in amp, \$150. L Wagner, Ardnigva Radio Network, POB 1788, Orlando FL 32802. 407-299-1299.

Maxitel Sports remote telephone mixer, \$150; NEC 616 telephone systems incl KS and 6 multiline telephones, \$375. E Moody, KJEM, 216 N Main St, Bentonville AR 72712. 501-273-9039.

FM & TV FIELD MEASUREMENT TRAILER

50' Tiltover, free-standing, rotatable Pneumatic Mast w/trailer - \$1100
Evans Associates
414-242-6000

Paradyne 4951-03 equip rack, black, full set blank covers, \$175. B Lord, 3824 SW Myrtle St, Seattle WA 98126. 206-932-4839.

Realistic PRS 100 UHF-fm transceivers (3), \$95/ea; NiCad battery chargers (10), 9v, \$5 ea; Dynamic MC-101 (5), \$15 ea. L Houck, Rolling Rcdng, 208 River Ranch Rd, Boerne TX 78006. 210-537-5494.

SAE 3200 digital FM tuner, rotary tuning, 5 1/4" high rk mt, \$150 + shpg. S Lawson, KAK Productions, 928 Hyland Dr, Santa Rosa CA 95401. 707-528-4055.

Motorola AM stereo system, #1400 exciter, #1410 monitor, gd cond, BO, M Lamb, Cypress Communications, 415-331-4867.

15 kW ex-military 30 120-220-416 60 Hz diesel gen set, 800 hrs on unit, \$3800 with out trailer, \$4200 with trailer. S Bartkowski, 708-863-3090.

Sennheiser HMD 25-1 headsets (6), \$375 each. Used Sennheiser 451EB mic, \$275. Otari 5050 BII, \$1000. Drawmer 1960, \$1695. Need cables or connectors? We hook you up. Redco Audio, 800-572-7280.

Want To Buy

10 kW gen & xfer switch. J Hansen, 612-632-2992.

Eventide time delay cards for BD-955. P Lopeman, 4359 S Howell Ave, Milwaukee WI 53207. 414-482-2638.

Phonograph records from 1950 to 1970, all types of music, 45s, 33s, 78s & xcriptions, top prices paid, will travel. B Berry, 800-321-2920.

Jazz record collections, 10" LP/12" LP be-bop, swing, dixie, highest prices paid. B Rose, Program Recdgs, 228 East 10th, NNYN 10003. 212-674-3060.

MONITORS

Want To Sell

Custom built 3 way spkrs, \$300. Fitzmusic, 37-75 63rd, Woodside NY 11377. 718-446-3857.

Simpson 3.5" audio VU meters (50), \$15/ea + shp. C Slayton, 738 Jellison Blvd, Duncanville TX 75116. 214-283-3311.

RECEIVERS & TRANSCEIVERS

Want To Sell

Johnson Ultracom 513 UHF 2-way radio base unit, snl chnl, \$50. E Lightman, 412-266-2802.

SCA RECEIVERS—ALL TYPES

Reading Service / Ethnic / Data Professional / Table Will work to meet your receiver needs

DAYTON INDUSTRIAL CORP. (Manufacturer)
2237 Industrial Boulevard
Sarasa, FL 34234
Tel: 813 351 44545 FAX: 6081

McMartin TR-E7 SCA receiver, working w/rechargeable batts, \$50; TR55 & 66B, \$20/ea+UPS. E Davison, 217-793-0400.

Want To Buy

Any EBS encoder/decoder in good cond. JP Ambrutis, 207-443-6671.

RECORDERS

Want To Sell

Astocom-Marlux 407 RR rcdr 7" 1/4-trk, works, 3 3/4-7.5, 3 motor, 4 head, \$30. E Lightman, 412-266-2802.

Otari ARS-1000 R-R PBs (4) w/tone sensors, good cond, \$300/ea. Randy, 815-942-2839.

Otari ARS-1000 (4) R-R decks w/25 Hz detectors, xint cond, \$595 or \$2000/all. J Hansen, 612-632-2992.

Scully 4-trk 1/2" 280B in roll-around console, \$600; ITC 750 PB decks (3), \$500/all. Gary, 919-790-6315.

REVOX PARTS/SERVICE

Cassette-CD-Open reel NOS PR99 repros. Capstan resurfacing, ALL BRANDS.

JM TECHNICAL ARTS
30 Music Sq. W. #156
Nashville, TN 37203 (615) 244-6892

Tascam 388 8-trk R-R w/console, 7.5 ips/dbx-NR, xint cond, \$850. G Parmelee, 802-247-4208.

Ampex 440 R-R, \$250; Ampex 440, \$150; Ampex 440 elec, \$100; Scully 280 R-R, \$250; MCI JH 110B 2 trk console, \$1400; Magne-corder PT 6 R-R tube collectable, exc, \$350; Magne-corder PT 6 tube elec, \$125. D Lundy, Lundy Rcdng, Cumberland Gap Pkwy, Heidrick KY 40949. 606-546-6650.

CLEAN PATCH BAYS NO DOWN TIME



VERTIGO BURNISHERS AND INJECTORS RESTORE ORIGINAL PERFORMANCE TO YOUR PATCH BAYS

\$34.95 Ea.
VERTIGO RECORDING SERVICES
12115 Magnolia Blvd. #116 818-907-5161
North Hollywood, CA 91607 fax 818-784-3783

Audio Technica RMX64, 4 trk R/P, 6 chnl mixer, 6 in, 4 out, 2 cue sends, parametric EQ, \$450. Fitzmusic, 37-75 63rd, Woodside NY 11377. 718-446-3857.

ITC R/P, stereo, gd cond, \$550. J Pittmann, 12104 Old Hwy 169, Hibbing MN 55746. 218-263-3000.

ITC SP Stereo R/P cart deck (3 cue) nds new play head, \$250 + shp; Ampex 440B, \$50 + shp; Ampex 440C stereo, in floor case, \$350 + shp; Multisync spd contrl for 440 B, \$350 + shp. C Slayton, 738 Jellison Blvd, Duncanville TX 75116. 214-283-3311.

Magacord 10-22 1/4" R-R, 2 trk/4 trk, 7.5-15 ips w/sync, gd cond, spare chassis, \$300; Tascam 22-2, 1/4" R-R, 2 trk, 2 chnl, 7.5-15 ips, VGC, \$400. Joe, JCF Labs, POB 184, Lincoln city, 97367. 503-994-9023.

MCI JH-110B in console w/extra electronics, manual, \$1000/BO; Ampex AG-440C, 4 trk, 1/2" w/extras, mint, \$750/BO; Scully 280 4 trk, 1/2", \$500/BO, all + shipping. Ed, 8 Knot St, E Patchogue NY 11772. 516-654-8306.

MIC JH 110B, 2 trk, roll around cabinet, gd cond. J Gelo, 941-642-6899.

Otari 7308 8 trk 1" rcdtr, low hrs, exc heads, w/remote, \$1500; Scully 280, 1" 8 trk, \$800; Ampex 1100 tape deck, \$500; Ampex 440 (several), 1/4", \$250-\$500. L Wagner, Ardnigva Radio Network, POB 1788, Orlando FL 32802. 407-299-1299.

Sony MCI JH24 24 trk analog, 80 hrs use, \$14,500/bo. CZ, 212-265-6060.

Studer A810, 2 trk, mint cond, \$1750/BO. P Lopeman, 4359 S Howell Ave, Milwaukee WI 53207. 414-482-2638.

DO YOU NEED Long Life MEC Tape Heads?

call
SEQUOIA ELECTRONICS
1-(408) 363-1646
FAX 1-(408) 363-0957

Teac Tascam 25 stereo R/P reel deck (2); Teac/Tascam A 6010 stereo R/P reel deck, needs work or for parts, BO any/all + shipping. L Frasier, WDCG, 4436 Main St, Downers Grove IL 60515. 708-271-6495 ext 318.

Telex Copyette 1 & 3, cassette duplicator, \$450. L Houck, Rollin Rcdg, 208 River Ranch Rd, Boerne TX 78006. 210-537-5494.

Ampex ATR100 taperecorders for parts. Circuit cards, heads, motors, machine parts, or electronic parts. Call 818-907-5161.

Nagra 4-S stereo sync machine, \$4500. W Gunn, 619-320-0728.

Otari 5050-SHD 8 trk 1/2" newly rebuilt, heads have full, life left, \$1800. W Gunn 619-320-0728.

Otari MK III-B w/8-channel dbx ProI NR, excellent condition, \$2000/BO. 615-360-8826 (before 8PM CT).

Scully '100' recorders, record/play amplifiers, 8, 16, 24 track heads. Sequoia Electronics, 4646 Houndshaven Way, San Jose CA 95111. 408-363-1646.

REMOTE & MICROWAVE EQUIPMENT

Want To Sell

2-line encoder, perfect cond, less than 1 yr old, works 200%, \$2500/BO. S Swartz, 407-686-2133.

Harris System 90 brains & audio switching equip, BO; McMartin TBM 1000A FM relay receiver, BO. T Stafford, 501-933-0403 FAX.

Gates Twinsister M-5168, 2 chnl, solide state, battery pwr w/VU meter, line out w/spec sheet schematics & operations info, \$125. G Gibbs, KMNS, 901 Steuben St, Sioux City IA 51102. 712-258-0628.

DISTRIBUTOR DIRECTORY

The following distributors serving the broadcast industry would be glad to help you with any of your requirements.

CORNELL-DUBILIER MICA CAPACITORS

FROM STOCK

JENNINGS VACUUM CAPACITORS

FROM STOCK

JENNINGS VACUUM RELAYS

SURCOM ASSOCIATES

2215 Faraday Ave., Suite A
Carlsbad, California 92008
(619) 438-4420 Fax: (619) 438-4759

...country, top 40, news, urban, talk, jazz, the classics, mixed bag...

RADIO! The beat goes on!

CROUSE-KIMZEY OF ANNAPOLIS

tops in broadcast equipment
1-800-955-6800
ask for Kathleen

PHONE: 703-998-7600 FAX: 703-998-2966

Call Simone Mullins, Classified Ad Manager, to reserve space in the next issue. Use your credit card to pay, we now accept VISA and MASTERCARD.

RadioWorld

5827 Columbia Pike, 3rd Floor • Falls Church, VA 22041

Select from these categories for best ad positioning:

Acoustics	Leasing	Stations
Amplifiers	Limiters	Stereo Generators
Antennas & Towers & Cables	Microphones	Tapes, Carts & Reels
Audio Production (Other)	Miscellaneous	Tax Deductible Equipment
Brokers	Monitors	Test Equipment
Business Opportunities	Receivers & Transceivers	Transmitter/Exciters
Cart Machines	Recorders	Training Services
CD Players	Remote & Microwave Equip.	Tubes
Computers	Repair Services	Turntables
Consoles	Satellite Equipment	Positions Wanted
Disco-Pro Sound Equip.	Software	Help Wanted
Financial Services		

Classified Advertising Rates Effective January 1, 1995

	1x	3x	6x	12x
1-9 col inch (per inch)	\$60	58	54	49
10-19 col inch (per inch)	55	52	49	44
Distributor Directory	100	95	90	85
Professional Card	65	60	55	50
Classified Line Ad		\$1.50 per word		
Blind Box Ad		\$10 additional		

To compute ad costs: Multiply the number of ad inches (columns x inches) by the desired rate schedule for your per unit cost. Example: a 3" ad at the 1x rate is \$180, at the 3x rate \$174, at the 6x rate \$162, at the 12x rate \$147, etc.

Broadcast Equipment Exchange

"Broadcast Equipment Exchange" accepts no responsibility for the condition of the equipment listed or for the specifics of transactions made between buyers and sellers.

AMPLIFIERS

Want To Sell

Newcomb HLP-14 tube amp w/phono variable EQ, \$25+UPS. E Davison, 217-793-0400.

RTS-405 stereo TT preamp, 6 mos use, \$140+shpg. B Lord, 206-932-4839.

Crown DC 150A pwr amp, \$250; Southwest Tech 215A, stereo pwr amp, \$95; Altec 1568A, 50 W tube pwr amp, \$150. D Lundy, Lundy Rcdng, Cumberland Gap Pkwy, Heidrick KY 40949. 606-546-6650.

McCurdy 504 audio DA frames (4), \$350/ea + shp; Hedco dual audio DA in rk mt frame, \$200 + shp; Dukane #60 W PA amp, \$75 + shp; dbx 157 declinear NR units (5), \$100/all; Crown (3) pwr amps, \$275 ea. C Slayton, 738 Jellison Blvd, Duncanville TX 75116. 214-283-3311.

RTS-405 stereo TT preamp (2), \$140/ea + shpg. B Lord, 3824 SW Myrtle St, Seattle WA 98126. 206-932-4839.

Symetrics headphone amp, \$180. L Houck, Rollin Rcdg, 208 River Ranch Rd, Boerne TX 78006. 210-537-5494.

Want To Buy

QEI 675T300 or 500, wking or not. P Lopeman, 4359 S Howell Ave, Milwaukee WI 53207. 414-482-2638.

Tube Hi-Fi, speakers, tubes. Altec, Marantz, McIntosh, Western Electric, coax/triax and corner speakers, tubes-VT-4C, 845's, etc. 405-737-3312 FAX: 405-737-3355.

ANTENNAS/TOWERS/CABLES

Want To Sell

Andrews HJ7-50A 1 5/8" Helix coaxial, 100', new, on shpg reel w/connectors & hanging accessories, \$1300. S Hill, 503-857-1063.

ERI 8-bay roto-tiller FM antenna, in storage, on 104.3, some missing parts, BO. Gary, 919-790-6315.

3" HELIX STANDARD COAXIAL CABLE

50-Ohm, unused, cut to length. Priced below market. Shipped instantly. Call Basic Wire & Cable (NANCY) 800-227-4292 FAX: 312-539-3500

ERI stainless steel face mount brackets (3) for 24" tower, \$100/ea. M Murphy, 406-542-1025.

ERI 2-bay FM antenna tuned to 100.1 MHz, used since 1987, BO; 450' 1 5/8" coax in 2 sections, approx 200' & approx 250' sections separated by ERI isocoupler, BO; Collins LPC-4 4-bay FM antenna, tuned to 104.9 MHz, operated from 1971 to 1994, has de-icers, BO; approx 280' 1 5/8" coax, BO. T Stafford, 501-933-0403 FAX.



ICE KRACKERS, INC.

Inexpensive permanent protection of guy wire anchor hardware from guy wire ice slides. Average cost \$400 for 400-foot tower. ICE KRACKERS sized by guy wire diameter. All sizes available. 273 Circle Drive, Springfield, IL 62703 (800) 747-8921 or (217) 529-8921 Ask for Jim Newbanks

Circle (25) On Reader Service Card

Jampro 3-bay antenna, 100.9 MHz w/radomes, \$1800. R Mason, 703-962-1133.

ADC doube TRS patch cords, 3 ft, \$5/ea. C Slayton, 738 Jellison Blvd, Duncanville TX 75116. 214-283-3311.

FM-Antennas

Brand New, as low as 695.00 per bay
Jimmie Joynt
Factory Direct Sales
800/279-3326

200', UTC-280 flanged, tube leg triangular, 18" face, galvanized inside and out, nds repainting, no hardware or insulator, exc cond, down and ready for pu, \$2500; 10' sections (6), rigid 1 5/8" interbay line w/sqar flanges, no bullets, \$200 + shp; stainless steel brackets (8) for face mting antenna/interbay line to 24" twr, \$50/ea, \$350/all + shp. C Glasgow, KROP, 120 S Plaza, Brawley CA 92227. 619-344-1300.

Want To Buy

1 kW class mod reactor choke. Bill, 914-356-6553.

200' Helix xmsn line, 1 5/8" or 3". J Powley, 910-342-1843.

6-bay on or near 92.1. J Hansen, 612-632-2992.

6-bay medium pwr CP on or tunable to 100.1 MHz. D Michaels, 916-926-1332.

10-12 bay high pwr FM on or near 93.3 MHz; Arrakis Digilink, prefer recent mdl. E Moody, KJEM, 216 N Main St, Bentonville AR 72712. 501-273-9039.

200' Helix line, 1 5/8" or 3". J Powley, 1512 Sherwood Dr, Reidsville NC 27320. 910-342-1843.

Multi bay antenna suitable for FM w/C-2 upgrade appl, must be tunable to 99.3. Andy, 520-855-9000.

AUDIO PRODUCTION

Want To Sell

Pro Announcer 500 mic processor, as new w/manual, \$600. G Barnett, 619-328-1104.

Tascam ES-50 & 51 combo sync, 2 slaves, \$2500. D Michaels, 916-926-1332.

AKG BX-10 stereo revb unit, \$100 + shp; Urei 530 dual graphic EQ, \$100 + shp; CBS 4110 FM stereo Volumax, \$50 + shp; ADC Icon audio block (12), \$20/ea + shp; ADC (12) older type icon audio blocks, \$20/ea; Pultec EQH-2, prgm EQ, tube type, \$575; Urei 565 filter set, little dipper, \$300 + shp. C Slayton, 738 Jellison Blvd, Duncanville TX 75116. 214-283-3311.

Altec 9069 B variable hi/pass filter, 600 ohms; Altec 9068-B variable lo/pass filter 600 ohms, rack mt pr, \$200; dbx 222 type II NR system, \$475. D Lundy, Lundy Rcdng, Cumberland Gap Pkwy, Heidrick KY 40949. 606-546-6650.

dbx 3bx dynamic range expdr, 3 bands, perf cond w/manuals, \$150; Tascam PE-40, 4 band, 4 chnl parametric EQ. rk mt, perf cond, w/manual, \$200. D Green, Moonlight Rec, 3433 Winifred, Ft Worth TX 76133. 817-346-6228.

Inovonics 231 MAP II multiband processor, mono, rk mt, gd cond, \$300; Gates Solid Statesman, \$150; Harris/UPI satellite rcvr and digital prgm decoder, \$200 + shp. C Glasgow, KROP, 120 S Plaza, Brawley CA 92227. 619-344-1300.

QEI stereo generator, exc cond, \$400. J Pittmann, 12104 Old Hwy 169, Hibbing MN 55746. 218-263-3000.

Roland 2450/2453 event cntrlr and prgmable clock, \$50. Joe, JCF Labs, POB 184, Lincoln city, 97367, 503-994-9023.

Roland D110 synth module, \$250; Opcode Studio 3 Midi interface, \$150; Onkyo TX15 and Harman Kardon 330C, tuner/amp, \$75. Fitzmusic, 37-75 63rd, Woodside NY 11377. 718-446-3857.

CASSETTES • CARTRIDGES • REELS

J & I AUDIO/VIDEO

A wholesaler in the Radio and Television market. Now running SPECIALS on audio and video: **BASF CASSETTES-AMPEX R-Rs AUDIOPAK, FIDELIPAC & ITC CARTRIDGES DAT & THE NEW R-CD** For more information call Kris Elliot at 1-800-942-1711 or write to: J&I Audio/Video 20899 Kelvin Pl. Woodland Hills, CA 91367

Circle (163) On Reader Service Card

Shure M67 mixers (2), excellent condition, \$100/ea; Shure M-68 mixer, excellent condition, \$75; Koss headphones (4), \$100/all; Furman RV-1 reverb, \$100. L Wagner, Ardnigva Radio Network, POB 1788, Orlando FL 32802. 407-299-1299.

Teletronics LA-2A vintage tube compressor, good condition, \$2500; Pultec MEQ-5, mid range EQ, tubes good condition, \$1000. Joe, JCF Labs, POB 184, Lincoln city, 97367, 503-994-9023.

Valley People 400 mic processor, \$295. GMI Media Grp, 206-839-9414.

dbx 166 stereo compressor, \$350. W Gunn, 619-320-0728.

Want To Buy

MXR Neve API, EQ, mic-pres, delays. T Coffman, Rolltop Music, POB 17203, San Diego CA 92177. 619-571-5031.

AUTOMATION EQUIPMENT

Want To Sell

SMC Carousels (2), various mem cards, expansion card, audio & sensor cards, terminal, etc, BO; Extel printer for automation syst, BO. C Tracy, WKNE, 603-352-9230.

Broadcast Electronics Core 2000, 3 yrs old, inc NSM 3101 (2), 100 disk CD player, Pioneer TM-2, 18 disk player, source cards (7), serial card, exc cond, \$12,000 + shipping. P Reilly, KGRC Radio, 314-221-2221.

Cetec 700 automation system all or parts, level 2, 5046 event memory, terminal, numerous source cards, 250 Carosel parts, spar IC's, more. E Moody, KJEM, 216 N Main St, Bentonville AR 72712. 501-273-9039.

Sony CD Jukebox (2), w/SMC cntrlr, 1 exc cond, 1 nds repair, \$850/bo. G Johnson, WLDY, POB 351, Ladysmith WI 54848. 715-532-5588.

CART MACHINES

Want To Sell

BE 3000A stereo R/P w/tones, very good cond, \$850; BE 3000A mono PB/delay rcdr, rack mount, new, \$500; BE 3000 mono R/PB w/tones, good cond, \$650; BE 3000 (3) mono PB w/ tones, \$450/ea. D Kelly, 402-372-5423.

Mono Tapecaster 700RP & 700P (1 ea), good for parts or refurb, work, BO. C Tracy, WKNE, 603-352-9230.

BE stereo cart machine (3), exc cond, \$1200. J Pittmann, 12104 Old Hwy 169, Hibbing MN 55746. 218-263-3000.

Great Prices on original equipment tape heads for ITC, BE, Fidelipac, Otari, Tascam & others!
(804) 984-4255
HE HALL Electronics

CRL APP-300 (2), exc cond, \$500. J Pittmann, 12104 Old Hwy 169, Hibbing MN 55746. 218-263-3000.

ITC S/P, gd cond, P Lopeman, 4359 S Howell Ave, Milwaukee WI 53207. 414-482-2638.

ITC stereo cart machines - 99B Rec/Play, \$1100; Delta Rec/Play, \$900; (5) Delta playbacks, \$600 each. Page J.B. @ 213-961-0100.

ITC 3D 3 deck stereo P/B unit, fair cond, \$250 + shp; BE mono daul cart unit, one R/P, one play only, \$100 + shp. C Slayton, 738 Jellison Blvd, Duncanville TX 75116. 214-283-3311.

ITC record amps, 3 tone, stereo \$350 or mono \$250. W Gunn, 619-320-0728.

Want To Buy

ITC, BE, Fidelipac cart machines: single, triple, mono, stereo, play & record/play. Call M O'Drobinak @ 619-758-0888.

COMPUTERS

Want To Sell

Olympia dot matrix printer, \$75. Fitzmusic, 37-75 63rd, Woodside NY 11377. 718-446-3857.

Want To Buy

Tandy 6000 HD with at least one floppy drive. Mel Crosby, 408-363-1646.

CONSOLES

Want To Sell

McMartin B502 stereo console, \$300. Gary, 919-790-6315.

UREI Mod One stereo consoles (2), BO. R Stafford, 501-933-0403 FAX.

Cetec 5 chnl mono console mounted in portable cab w/cue spkr, prgm spkr, \$350. E Moody, KJEM, 216 N Main St, Bentonville AR 72712. 501-273-9039.

Harris Gates Duafux II AM & FM, 8 chnl stereo, \$800. D Lundy, Lundy Rcdng, Cumberland Gap Pkwy, Heidrick KY 40949. 606-546-6650.

Ramco DC-8M 8 chnl/32 input mixer w/aud & pqm outputs, adv features, spme spare parts, manual, \$650 + shp. C Glasgow, KROP, 120 S Plaza, Brawley CA 92227. 619-344-1300.

Soundcraft 400B rcdng mixer, 16x4x2m 4 band British EQ, VGC, w/manual, \$950/BO + shipping, Ed, 8 Knot St, E Patchogue NY 11772. 516-654-8306.

Tangent 1202-A 12 chnl input, stereo output, mono output, slide pots, pre & post efx, reverb, EQ on each input, exc cond, \$800 + shipping, S Lawson, KAK Productions, 928 Hyland Dr, Santa Rosa CA 95401. 707-528-4055.

Shure 200M prologue mic mixers (4), as new, \$85/ea. L Houck, Rolling Rcdng, 208 River Ranch Rd, Boerne TX 78006. 210-537-5494.

Harris 5 channel stereo console, \$300 + shipping. C Slayton, 738 Jellison Blvd, Duncanville TX 75116. 214-283-3311.

Gates Yard board, new tubes, \$395. W Gunn, 619-320-0728.

Want To Buy

API/Neve whole or parts, working or not. T Coffman, Rolltop Music, POB 17203, San Diego CA 92177. 619-571-5031.

Arrakis slide pot, any model. P Lopeman, 4359 S Howell Ave, Milwaukee WI 53207. 414-482-2638.

DISCO-PRO SOUND EQUIPMENT

Want To Sell

White 4002 1/3 octave EQ, perf condition with box and manuals, \$200. D Green, Moonlight Recording, 3433 Winifred, Ft Worth TX 76133. 817-346-6228.

FINANCIAL SERVICES

\$\$\$ \$ \$ \$ \$

DO YOU NEED CASH

to fund new or used equipment? Call 1-800-549-8539 for FREE RECORDED MESSAGE, 24 hours, to hear about our quick-approval, fixed-rate, long and short-term lease-to-own programs. Then you can apply by FAX, 24 hours a day.

EQUIPMENT FINANCING

ON ALL RADIO EQUIPMENT

- Easy to qualify
- Fixed-rate, long-term leases
- Any new or used equipment
- 100% financing, no down payment
- No financials required under \$50,000
- Refinancing existing equipment



Call Mark Wilson (800) 275-0185

HE HALL Electronics
706 Rose Hill Drive Charlottesville VA 22901

The ECO Series of FM transmitters is an economical repackaging of our "World Standard" MK Series. Offering excellent quality and the highest level of reliability, the ECO Series is designed for budget minded broadcasters who need between 1KW and 11KW of transmitter power to meet their ERP requirements.

Also Available from Energy Onix :

- Frequency Agile Composite STL's
- AM Transmitters
- Exciters

(804) 984-HALL (4255) Fax: (804) 984-FAXX (3299)

Features:

- Attractively priced
- Inexpensive, Long Life, Triode Tube In PA
- Never Requires Neutralization
- 80% PA Efficiency
- Independent Solid State IPA Doubles As Emergency Transmitter
- Simple Reliable Controller
- Field Proven Standard Parts
- VSWR Foldback and Protection
- Automatic Power Output Control
- Designed For Local & Remote Control
- Built-in Line Surge Protection

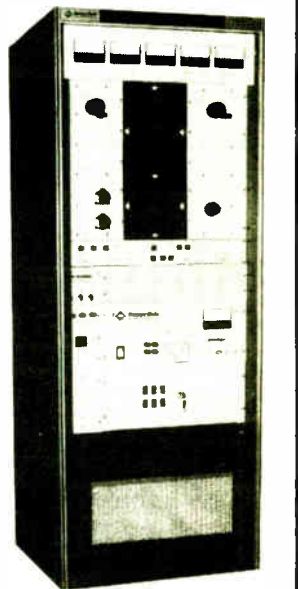

Circle (2) On Reader Service Card

Jumping into Windows

► continued from page 71

Daytimers or one of the copy-cat products, the Day Runner. These noncomputerized storehouses of information are super if used properly. To use them properly, you must "live" with them, entering all relevant information in the proper areas.

The first electronic versions of these paper-based devices came in the form of pocket organizers like the Casio Boss or the Psion organizers.

There are also computer programs call PIMs (Personal Information Managers) that organize your personal information on your computer in much the same manner as the Daytimers or Boss did.

Several months ago, I purchased ECCO Simplicity, which is a scaled-down version of ECCO Professional, a full featured PIM. Simplicity has the usual calendar, phone book, and to-do lists all neatly arranged in outlines.

ECCO Simplicity operates under Windows, making it easy to pop in and out of programs. ECCO has an ingenious device they call a "Shooter." This is a small arrow in the upper left hand corner of the screen that sits next to the Close icon. Click your mouse key on the Shooter under any program and the ECCO menu pops up and permits you to enter the PIM.

I have tried using this program for about a month and have found setting up a project and to-do outline difficult. The key strokes are unusual. For example, to delete an item in an outline you must hold down the Ctrl key while pressing the letter D instead of simply hitting the Delete key. Perhaps this was set up this way to prevent accidental deletions of items.

It took me some time to learn how to organize outlines. The outline column titles are fixed. The professional version permits more flexibility and allows the outline column titles to be changed. I did like the layout of the hardcopy printouts. These I found helpful.

To sum up, ECCO Simplicity took some getting used to. I think that such productivity tools should be more intuitive and easier to use, much like the original Daytimers.

If you want to test-drive Ecco Professional, a demo version is available on CompuServe.

P.S. Daytimers has their own PIM based on their tried-and-true paper organizer concept. And, yes, I bought a copy. Let's see ... Insert disk 1 in drive A ... More on this in the near future.

□□□

Richard Mertz bio is a principal at Suffa & Cavell in Fairfax, Va. Reach him at 703-591-0110; on CompuServe at 730,3026; or via Internet at rmertz@dgs.dgsys.com

61 Years Ago

Reprinted from Radio World October 27, 1934.
Editor's note: The RW of old, printed for a time in the 1920s and 1930s and today's RW are unrelated except in name.

Pro or Con—Which Shall It Be?

SHALL WE HAVE GOVERNMENT RADIO CENSORSHIP? You can't make up your mind on the subject by reading the speeches made during the annual assembly of the National Advisory Council on Radio in Education held recently in Chicago. A number of men whose convictions are interesting even if not conclusive and still more prominent educators and microphone declaimers disagree quite thoroughly over the pros and cons of the case. Many of them missed a most important angle of the subject—for no matter why or when or by what administration radio censorship is established there al-

ways remains the positive danger that a big percentage of our population will claim that a synonym for censorship is propaganda.

Again, and for the seventh time, let us proclaim to the whole world that radio can save the expense, resentment and unpleasant features of censorship only by keeping its skirts clean and sending out nothing over the air-waves that calls for censorship. Who shall decide? Why, the same duo that decides most things at home and in national life—good, old Dr. Decency and his partner, Dr. Commonsense.

They make a strong team.



**IN SPACE, THEY CAN'T HEAR YOU SCREAM.
MAYBE THAT'S WHY YOUR SATELLITE EQUIPMENT
COMPANY ISN'T RETURNING YOUR CALLS.**

*To provide one-way data broadcast
and digital audio satellite solutions, you have to
have both feet on the ground.*

Satellite technology has provided business with an efficient, economical information medium; most satellite equipment suppliers can provide the hardware to get the job done. However, once in place, networks undergo constant change. And change of that scale requires inspired solutions few companies can offer.

International Datacasting uses technology to solve your communication problems today – and tomorrow.

We have installed turn-key, QPSK/BPSK SCPC one-way data broadcast and digital audio satellite systems for clients all over the world; Australian Broadcasting Corporation, Canadian Broadcasting, Learfield Communications, Capitol Radio Networks and United Press International, to name a few. International Datacasting systems are fully addressable using unique network management software. Our systems and equipment are designed for maximum flexibility ideal for the growing network. And from the lab to the field, our people have consistently provided the most innovative solutions in the industry.

So, give us a call. We just might have the solution you've been looking for.

**INTERNATIONAL
DATACASTING**

Corporate Headquarters: 2680 Queensview Drive, Ottawa, Ontario, Canada K2B 8H6 Tel.: (613) 596 4120 Fax: (613) 596 4863
US Sales: 3850 Holcomb Bridge Road, Suite 420, Norcross, Georgia, USA 30092 Tel.: (770) 446 9684 Fax: (770) 448 6396

Circle (128) On Reader Service Card

World Radio History

MOVING?...

Don't leave us behind!

Mail or fax
your current label
and new address
(with effective date) to:
Circulation, RW,
PO Box 1214
Falls Church, VA
22041
or
FAX 703-998-2966.

Address changes
will be processed
within four weeks of receipt.

Thanks!



Compatibility, Confidence, and Cost Savings



- Designed by Telos specifically for radio applications on ISDN and Switched 56.
- Clean, uncluttered front panel for simple operation. Full metering, call duration timer, headphone jack, and mic/line inputs.
- Built-in input protection limiter. When your talent screams, your audio does not distort.
- RS-232 bidirectional data at 9600 baud for communications and control. Windows-based software included free.
- Four end-to-end "contact closures" for remote machine control.
- Optional AES/EBU input/output module.
- The ideal solution for remote broadcasts, ad hoc networks, voiceovers, distribution of commercials, backup to satellite and microwave links, and many other applications.

Sports, news, voiceovers, and most other remote broadcast applications are mono. Before Zephyr, the choice was between sacrificing fidelity or using multiple ISDN channels. Not so for Zephyr users who spent the last two years enjoying better sound and lower transmission costs.

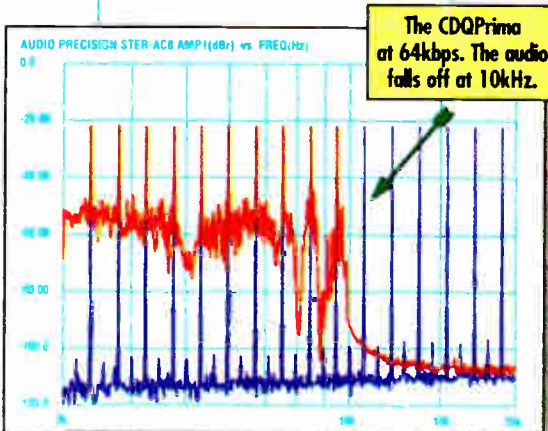
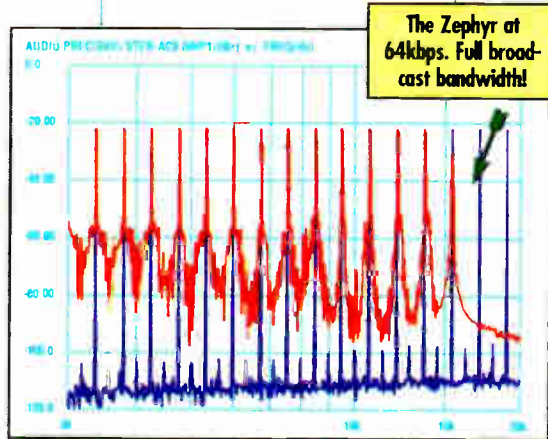

On just one of the two digital channels of an ISDN circuit, Zephyr's Layer III delivers 15kHz mono audio. And it yields the same results with a Switched 56 circuit. Other schemes offer a meager 7kHz to 10kHz audio.

Zephyr reliably provides more than just the superior mono and stereo quality of Layer III. With Layer II and G.722 no product lets you easily connect to more sites than Zephyr.



only from



2101 Superior Avenue
Cleveland, Ohio 44114
+1.216.241.7225
FAX: +1.216.241.4103
email: info@zephyr.com

Only Zephyr Has...

- Full compatibility with Zephyrs used by broadcasters worldwide, as well as backward compatibility with all Layer II implementations, such as MUSICAM.
- An integrated terminal adapter designed for the non-technical operator. Setting up a remote is as easy as sending a fax.
- A split channel mode that allows you to transmit two different mono programs to two separate locations using just one ISDN circuit and one Zephyr.
- Telos quality and value resulting from over a decade exclusively dedicated to products for the broadcast-to-telephone interface.



The Best Way to Hear from There™

Telos Zephyr DIGITAL NETWORK AUDIO TRANSMITTER

Telos Systems, the Telos logo, Zephyr, and The Best Way To Hear From There are trademarks of TLS Corporation. All other trademarks are property of their respective holders. Graphs are produced using the protocol Audio Precision Tech Note #14. Complete test results available upon request.

Circle (112) On Reader Service Card
World Radio History

How Ready Are You for Windows 95?

Separate Some of the Hype from the True Performance Features of Microsoft's Windows 95

by Richard Mertz

FAIRFAX, Va. By the time you read this article, Microsoft will have already released Windows 95. Lately, broadcast and print media have bombarded the public with advertising announcing the impending release of the "new and improved" operating system.

All the articles I have read lately tell how well the new Windows operates, how easy it is to start programs, and what a big improvement the new system is over Windows 3.11. No, I did not run out and buy the Windows 95 on Aug. 24, and I don't intend to. Well, not just yet.

I did visit the local computer software store where a system was up and running. The look is interesting, simple, and easy on the eyes. You do not have to "double click" the mouse button to start programs or open groups. I am interested, however.

Exterminate first

With all the hype accompanying Windows 95's release, I am skeptical about even trying the new Windows on

my own computer until many of the known bugs have been corrected. (I understand that Microsoft will be releasing fixes for some of the known bugs in November).

Compatibility with older programs will, initially, be a problem as well. Not all Windows-based programs currently on the market today will work properly under Windows 95. For example, WordPerfect 6.1 or Quattro Pro will require some work and fiddling with the setup to get it to work properly.

I understand that this is due to Microsoft's postponing the release of the new operating system details (code) to other software providers until the Aug. 24, release date. The other software providers did not have any time to prepare instructions and fixes that would permit their products to operate under this new version of Windows.

You could, however, purchase Microsoft's own products that are designed to work under Windows 95 (There are stories all over the Internet that tell of a bug in the new Microsoft Word. Try to save a file to a non-existent directory and you get a box with the

number 1 and an OK button. Press the button and the unlockable Windows 95 locks, or so it has been e-mailed.)

The other day I was returning a piece of gear that was mislabeled to the local computer emporium. There were two guys in line waiting to return Windows 95. The first guy said his machine (a Gateway 486 computer) locked in the middle of the setup routine. The other guy had problems running the software he already had.

I am not trying to bash Microsoft's new stable of products. I am only suggesting that it might be best to let the new products "mature" before you plunk down your hard-earned cash. (Many people are

superstitious about buying the first of any new product.) I intend to try the new operating system some time in the future, but for now I will wait and see.

Chyron! Clear Commentary

Moving on ... I started this article with my thoughts about an operating system that is intended to improve (duck! here it comes) *productivity*.

In my work, I have to juggle many tasks and projects. Keeping track of these items is no small task. I need quick access to information such as telephone numbers, fax numbers, addresses, project details, project numbers, and my schedule.

Many years ago, a very wise chief engineer introduced his assistant to Pocket Daytimers. Many may be familiar with

continued on page 73 ▶

NEW

7.5 kHz audio over plain telephone lines

Call for free demo tape.



every time!

Introducing the Scoop Reporter from AETA:
a revolutionary CODEC that gives you low delay (30ms) broadcast quality audio from any telephone jack. With its built-in V.34 modem and the robust CELP* algorithm, the Scoop Reporter will operate at bit rates as low as 24 Kbit/s (the highest rate consistently achievable by 28.8K V.34 modems) or even 21.6 Kbit/s.

Look too for these other features:
- Compact and portable design (4kg)
- Input mixer for Mic and AUX
- Headset and line outputs
- Mains or battery operated
- Up to 3 hours of autonomy
- Regular field telephone mode
Call AETA today and find out about the Scoop Reporter and our full line of ISDN CODECs.

USA 2055 E. Calle Maderas, Mesa, AZ 85210. Tel: (602) 464-0085 Fax: (602) 964-0804

EUROPE 361 Av. du Général de Gaulle, 92140 Clamart, France. Tel: +33 1 41 36 12 12 Fax: +33 1 41 36 12 13



Performance

Reliability

Circle (59) On Reader Service Card

Quantum FM

Solid State

Solid Reliability

from **QEI**



- Proven reliability
- Maintenance-free FET technology
- Self-contained modules with own power supply regulator
- Compact size reduces shipping costs, allows affordable air shipment
- Power levels between 300 Watts and 6 kW
- Modular design offers buy-only-what-you-need affordability and convenience

For the same price you pay for a tube transmitter, you can now have a superior solid state FM transmitter with high-power, advanced technology exciter and cableless combiner. The modular design of QEI's QUANTUM-Series FM transmitters offers the advantage of buying only the amount of power you need...and means that you can upgrade to higher power levels whenever you're ready.

QUANTUM from QEI-the people who have been designing and building solid state transmitters longer than anyone else in the industry.

You need to know more! Call Jeff Detweiler today toll free (800) 334-9154.

QEI Corporation
One Airport Drive • P.O. Box 805
Williamstown, NJ 08094

Tel (800) 334-9154
Fax (609) 629-1751

24-Hour Service Hotline
(609) 728-2020

Circle (194) On Reader Service Card

PIONEER PROFILES

Who Was First in Radio Still Debated

by Barry Mishkind

TUCSON, Ariz. This fall marks the 75th anniversary of the beginning of broadcasting.

Or does it?

Whenever broadcasters get together to discuss the beginning of the industry, it

KCBS, originally "San Jose Calling," FN, 6XE, 6FX, SJN, then KQW, was built in 1909 in San Jose, Calif., by Charles David Herrold. Broadcasts of music from Herrold's School of Radio could be heard every Wednesday evening. Lee de Forest proclaimed Herrold's station as "the oldest broad-

manufactured by Westinghouse.

This fall, you are sure to read many articles about KDKA in all sorts of publications. What is not in debate is that the Department of Commerce (DOC) started issuing licenses in 1920 for what would become the broadcast band as we know it. Experimental station 8XK in Pittsburgh, which was to become KDKA, was granted the first "Limited Commercial" license. During a delay in reception of the license, the station proceeded to broadcast the election returns on 330 meters (909 kHz) on Nov. 2, 1920, under Special Amateur license 8ZZ.

The broadcast itself was hardly unique. After all, a number of other stations did election returns that very same night, even before that. However, the fledgling KDKA was different in that it inaugurated a regular daily schedule of transmissions. The parent company, Westinghouse, even had plans to start more stations if KDKA proved successful. Unfortunately, the full story of what happened in those days is less than crystal-clear.

Categories

It is evident that few — including the government — really had any clue as to the future of the new "wireless" medium. An assortment of stations in seven categories (Public Service, Limited Commercial, Experimental, Technical and Training School, General Amateur, Special Amateur, and Restricted) had already transmitted everything from earlier election returns to music to dramatic readings.

And a whole range there were! Early stations included Experimentals such as DeForest's "High Bridge" station, 2XG in New York City; and the "California Theater" station, 6XC in San Francisco. There was American Radio and Research Corporation's 1XE in Medford Hillside, Mass.; Technical and Training School station 9YY at the University of Nebraska and General Amateur 8MK from the Detroit News.

The term "broadcasting" found its way into government publications in 1921. On Dec. 1, 1921, two wavelengths were formally set aside for a special service category within the "Limited Commercial" class of stations. The regulations read: "Licenses of this class are required for all transmitting stations used for broadcasting news, concerts, lectures, and like matter."

Less formal matter

Getting a license in those early days was much less formal than it was after 1927 when the Federal Radio Commission was put into place. Basically, anyone filing a request with any of the nine regional Radio Inspectors of the DOC's Bureau of Navigation was given a license, as a matter of registration. In fact, some of these early "grants" were never even built.

In 1927 a familiar phrase was introduced, licensing stations to serve the public "convenience, interest, or necessity," and more concrete requirements were set out for new stations.

"Who's on first?" It doesn't really

matter. Broadcasting started. And, as we will see, there is plenty of interesting broadcast history to go around. From one licensed station in 1920 to more than 11,000 today, broadcasting has truly become a major factor in the development of society in this century.

Over the coming months, *Pioneer Profiles'* goal is to shine some light on the trailblazing people and stations that broadcast back before anyone worried about much more than keeping a cranky transmitter on the air.

If you or your station has a written history or any information on the roots of broadcasting, please share them with me. I would appreciate anything that would illuminate the pioneer stations and those who built them. Books, newspaper clippings, old licenses, ratecards, EKKO stamps, radio guides, even photocopies are of benefit. Send them to Barry Mishkind, 2033 S. Augusta Place, Tucson, AZ 85710. The information will be added to the OLDRADIO infobase, and eventually donated to an archive open to all.

□ □ □

Barry Mishkind can be reached at 520-296-3797, or barry@azstarnet.com via the Internet. You can find his home page at <http://www.azstarnet.com/~barry/>

New Service

► continued from page 22

prime example of a program segment underserved, if served at all, by NPR. Many college stations are faced with the "decision to turn off the station if the nighttime guy doesn't show up," he said. PRS will begin nighttime coverage from its inception to make available nighttime programming to those stations who need it. Graham also noted that PRS will not restrict affiliates to size of operation. Moreover, PRS will be targeting the elderly, who statistically arise early, and to no real public programming specific to their interests, according to Graham. PRS will broadcast early-morning weekend programming for the elderly ranging from polkas to talk programs specifically aimed at the interests of this demographic.

Much of the talent PRS will draw from are others who have wanted to diversify public broadcasting, but were unable to get federal funding for their programs. Graham cited one jazz host who had applied for federal funding for his program in the past but was consistently turned down.

"He's been turned down five years in a row, and we're going to put him on because he's really good," he commented. PRS is expected to launch in late January, with plans to beam its programming from the NPR satellite so stations will not have to change or acquire new satellite dishes. PRS's new studios, including two on-air facilities for each network and a backup redundant studio, are being built now to accommodate the new channels, and will be completed later this year.

"I'm out to make money, of course," summed up Graham. "But I really do believe there are a lot of things wrong with this country, and one of the things wrong is communication just isn't good enough."

□ □ □

Dee McVicker is regular contributor to *Radio World*. She can be reached at 602-545-7363, or by email at roots@primenet.com

Under one definition, broadcasting might have started in the 1880s via telephone, in Budapest.

soon turns into the famous Abbott and Costello routine. Trying to figure out "Who's on first?" often turns into a frustrating, even maddening attempt to put a label on a moving target.

Was KDKA's appearance in November 1920 that of the first broadcast station? The question really is difficult to answer, even as one tries to define *broadcast*. Was it operation on a regular schedule? A daily schedule? Was it continuous operation from some early date? Designed to be heard by the general public? Licensed by the U.S. government?

Strong claims

Depending upon the criteria, many stations have strong claims for being first. And like Lou Costello, you may find a straight answer is somewhat elusive. Some of the contenders go way back.

Under one definition, broadcasting might have started in the 1880s, when the Budapest Cable Company began sending out scheduled entertainment programs via telephone lines. They hired people with "specially loud voices" to read out the news. RF was not involved, but it was considered "broadcasting" in the sense of being programming distributed to a variety of locations.

casting station in the whole world."

KCBS calls itself "the longest continuously broadcasting station in the world." by a factor of at least a decade. There were, however, transmissions of music via radio by the Belgian Post Office beginning in the same time period.

WHA, originally 9XM, Madison, Wis., was constructed by Earle Terry. The University of Wisconsin claims WHA "the Oldest Station in the Nation ... in existence longer than any other." It certainly rivals KCBS.

WWJ, originally 8MK, began operation on Aug. 20, 1920. The next night it broadcast the results of an election. The station was owned and operated by the Detroit News. It promoted itself as "WWJ Radio One, Where it All Began, Aug. 20, 1920."

Grand daddy

And then there is KDKA, originally 8XK. Built by Dr. Frank Conrad of Westinghouse in 1916, it began playing music after the wartime ban on entertainment was lifted.

Actually, non-governmental stations were ordered off the air until the end of World War I. 8XK was one of the few stations transmitting from time to time to test military radio equipment

How The Americans Make Commercial Radio Pay!

▼ A fun, practical, Programming Manual and Idea Book for Program Directors and Operations Managers

▲

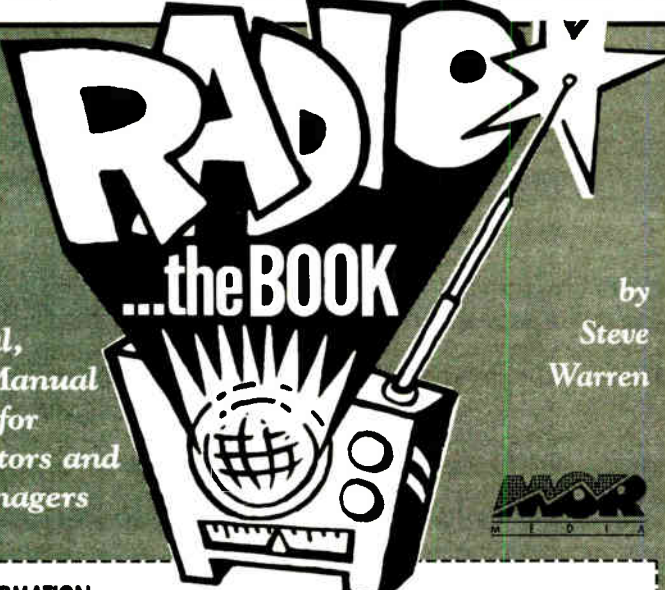

by Steve Warren

MOR MEDIA

PLEASE PRINT ALL INFORMATION

I would like to order _____ copies of Radio...the book @ \$35.00 ea = \$ _____ * total. (*price includes shipping)

Mastercard Visa American Express

Card Number: _____ Name: _____

Expiration Date: _____ Shipping Address: _____

Name on Card: _____

Signature: _____

Phone: _____ Fax: _____

TO ORDER BY FAX
1-800-827-9055

TO ORDER BY PHONE
1-800-827-1722

MAKE CHECKS PAYABLE TO: MOR MEDIA



OR MAIL TO:
Radio World
Tools of the Trade
P.O. Box 1214
Falls Church, VA 22041 USA

Products & Services Showcase

For more information on the products shown below, circle the appropriate Reader Service No. (s) on the enclosed Subscription/Reader Service card or contact the advertiser directly.



Pristine SYSTEMS INCORPORATED **DIGITAL ON-AIR SOLUTIONS**

- Feature Rich Live Assist and Walk Away
- On-Line Redundancy...No Black Box
- The Best Integrated Play List Scheduler (Music & Breaks) & On-Air Playback
- Dolby AC2 Overlapping Hard Disk Audio
- Music on Hard Disk and/or CD Jukeboxes
- Provide Computers/Players & Save \$\$\$ or Buy/Lease From Us

WEST/INT'L **310/670-7500**
FAX 310/670-0133

EAST **803/370-2400**
FAX 803/370-2314

READER SERVICE NO. 90



HURRY UP
TELESCOPING MAST
for fast and easy deployment of lightweight antennas

- Manually deployed with quick lock/release collars in one minute or less
- 25' extended height
- 6' retracted height
- 20 lb. top load capacity
- Rigid azimuth locking
- Over 50 mph wind speed capacity
- Free standing
- Universal vehicle mounting stand included
- Portable - 20 lbs.
- High strength anodized aluminum construction
- Ideal for lightweight antennas
- Designed and built by the leading manufacturer of pneumatic telescoping masts.

W3 WILL BURT
P.O. Box 900
Orville, Ohio 44667-0900
Phone 216-682-7015
FAX 216-684-1190

READER SERVICE NO. 180



- CUSTOM ANTENNA PHASING SYSTEMS
- ANTENNA CONTROL SYSTEMS
- AM/MF ANTENNA TUNING UNITS
- DIPLEXERS & MULTIPLEXERS
- TRANSMITTER COMBINERS
- DUMMY LOADS (WITH MATCHING NETWORK)
- ASSOCIATED RF COMPONENTS
- CALL OR FAX FOR MORE INFORMATION

PHASETEK INC.

550 CALIFORNIA RD. UNIT 11
QUAKERTOWN, PA 18951
PHONE: 215-536-6648
FAX: 215-536-7180

READER SERVICE NO. 109

**THE WORLD'S BEST TELEPHONE COUPLER!
AT THE LOWEST COST AND FEATURE LOADED!**

INTRODUCING...
THE TAC AND TAC+
(shown)



- A must for radio reporters
- Tuck in field bag for remotes

TAC \$89.50
TAC+ \$99.95

Call your distributor or order direct
1-800-688-8208

Tac & Tac+: Mix voice with external feed (cassette, etc., 8-32 ohm input xfmr) • Monitor continuously • Output signal for recording • Modular plugs connect between handset & phone base • Two year full warranty
TAC+ features: 6 step, 10db/step attenuator in addition to coupler! • 8-32 or 600 ohm input xfmrs • Cough button

Shock padded vinyl carrying case available \$9.95

By **SOUND AMERICA CORPORATION** • manufacturer of the venerable Voice-Act

READER SERVICE NO. 69

Quality* Power Tubes

3CX15000H3	4CX5000A/81704	4X350A/8321
3CX15,000A7	CX3500A	4CX250R/7580W
3CX15,000A3	4CX1600B	4CX250BT
3CX15,000H3	4CX1500A	4CX250BC/8957
3CX10,000H3	4CX800A	4CX250E/7203
3CX10,000A7	4CX400A	4X150A/7034
	4CX350AC	5CX1500B
3CX3000F7/8162		5CX1500A
3CX3000A7		YC130/9019
3CX2500H3		8560AS
3CX2500F3/8251		811A
3CX2500A3/8161		833A
4CX15,000A/8281		833C
4CX10,000D/8171		SK30CA



Svetlana
ELECTRON DEVICES

- Watch this list grow.
- Manufactured in Russia's largest power tube factory.
- Shipment from USA stock.
- Generous* warranty based on high quality.
- Honest prices based on quality at low cost.

Broadcasters	OEMs, Distributors
Phone: 205-882-1344 FAX: 205-880-8077 800-239-6900	Phone US: 800-578-3852 Int'l & US: 415-233-0429 FAX: 415-233-0439

READER SERVICE NO. 47



SWR FM Antennas
Leading the Way in High Performance Antennas

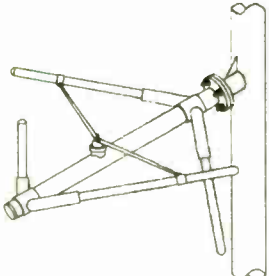

Contact **Jimmie Joynt**
Factory Direct Sales
Ph 800/279-3326
Fax 800/644-5958



17194 Preston RD #123-297 Dallas, TX 75248

READER SERVICE NO. 88

MATCHBOX II IS BEST FOR DIGITAL
with its HI-GAIN mode for Power-Mac* and other digital editor sound cards

NEW!!



Get MATCHBOX II to convert your Power-Mac* audio to *balanced* professional levels!

Only MATCHBOX II has *programmable gain* that's optimized for digital editor sound cards.

15,000 units in use worldwide!

- ◆ HI-GAIN mode for digital editors
- ◆ All four outputs adjustable
- ◆ Pro-grade gold-plated RCA jacks
- ◆ Over 110 dB dynamic range
- ◆ Self-contained power supply



HENRY ENGINEERING

TEL (818) 355-3656
FAX (818) 355-0077
FAX-on-Demand Doc #120 (818) 355-4210

Power-Mac is a trademark of Apple Computer

READER SERVICE NO. 8

Developments Fast and Furious in RF

NEW ORLEANS Manufacturers of RF gear were making connections at World Media Expo '95. From transmitters to STLs, antennas to vehicles for driving radio into the future, companies were offering up their wares to steady streams of people on the exhibit floor.

During the show, **SEIKO Communications** announced the formation of the company FM Superhighway Inc., created to develop the FM Superhighway, a worldwide wireless communications network that uses SEIKO Communications Group's ACTIVE subcarrier technology for datacasting, group and personal messaging, and information services.

The ACTIVE system multiplexes information such as traffic reports, financial updates, emergency notification and paging into the subcarrier spectrum of FM radio stations. This technology has generated interest among manufacturers who are looking toward incorporating it into car stereos, radios, information receivers, cellular phones and computers.

At EIA's RDS booth, attendees got a look at **CouponRadio**, a system that utilizes RBDS to transmit data via an FM radio station's non-audio subcarrier. When a listener with a CouponRadio hears something of particular interest (a song, for instance), he or she can read an LCD for more information and, if he chooses, store the information on an electronic credit card-sized "smart card."

Networking

Telect presented its new SuperMIX DSX, designed specifically for E-1 networks. This multiple interface cross-connect system allows technicians to patch, monitor and cross-connect E-1 circuits. Configurable backplanes accommodate any type

of switch and MUX equipment. The chassis modular design installs easily, enhances cable management architecture and permits personnel to add modules as needed.

TFT showcased its EAS 911 combined Emergency Alert System encoder and decoder and its EAS 930 modular receiver system. The EAS 911 enables broadcasters, cablecasters and government

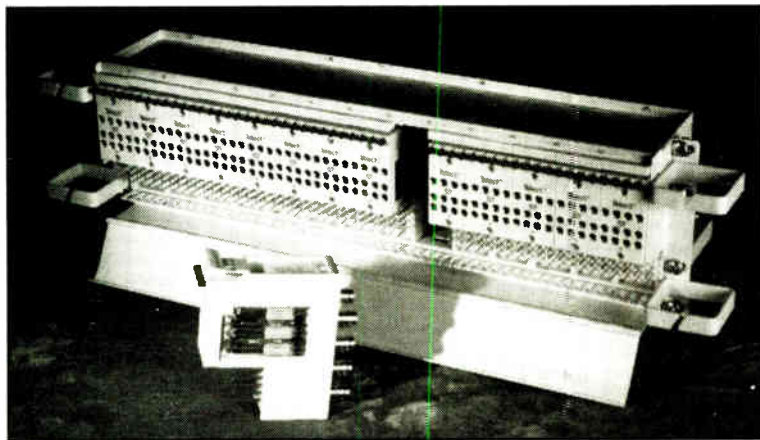

Telect's SuperMIX DSX

emergency managers to receive, store, forward and originate Emergency Alert Messages prescribed by the FCC's new EAS rules.

Loral Microwave-Narda introduced its latest model personal monitor that covers the AM band. The model 8844C-0.5 covers 150 kHz to 30 MHz.

Sending signals

Nautel introduced its XL12 12 kW AM stereo transmitter, which is capable of 13.5 kW. Also on display was the FM4 4 kW FM transmitter with the NE50 digital FM exciter, which utilizes state-of-the-art Direct Digital Synthesis (DDS) technology to digitally create the FM signal.

The FM-4C 4 kW solid state FM transmitter made its debut in the **Broadcast Electronics** booth. Other FM transmitters on display included the FM-30b, the FM-3C and the FM-1C1. All these transmitters

contain BE's FX-50 Exciter technology.

Harris Allied showcased its DX 1000 digital solid state 1 MW AM transmitter. Harris also featured its Digit digital FM exciter, which, the company announced, now comes with a three-year warranty. The Quest 1 FM transmitter, the DX 50 50 kW digital solid-state MW transmitters and the Gates 5 MW transmitter were on display as well.

Larcan-TTC exhibited its FMS-500, a 500 W solid state FM transmitter. The FMS-500 features a digital panel meter, automatic power control and a broadband design for frequency agility. This transmitter is backed by a two-year warranty.

Crown International showed an assortment of FM products, including the FM250 250 W and FM500 500 W solid state FM transmitters. Both

feature a built-in stereo generator, audio processing, and digital metering and diagnostics. Also on display at the Crown booth were FM translators an FM receiver module and FSK module.

CCA Electronics unveiled the FM100GS, its 100 W high-performance FM exciter. The modular construction of the FM100GS allows for field repair with a minimum of manpower and time. The exciter delivers high-quality audio and meets the requirements of demanding digital audio sources. The company featured its G-Line 2.5 to 45 kW tube FM transmitters and GS-Line 2.5 to 12 kW single-tube FM transmitters as well.

Continental Electronics displayed an array of AM and FM transmission products, including transmitters from 50 W to 70 kW. The Eco and MK Series of grounded grid triode transmitters were in the spotlight at the **Energy-Onix** booth. The Eco Series of transmitters is an economical repackaging of the MK Series for broadcasters who must meet budget and ERP requirements. The company also displayed its Legend Series high-power and SST Series low-power FM transmitters.

Energy-Onix also featured the STL1 and STL2 digitally controlled composite systems.

Starlink

Moseley unveiled the Starlink 9000 in T-1 and RF configurations. Starlink is an all-digital modular system for CD-quality audio transmission, facility remote control and stereo/SCA/RDA generation. The company also offered its frequency-agile PCL 6020 and PCL 6030 STLs, which withstand harsh RF environments and are available in frequencies from 145 MHz to 1.9 GHz.

Sine Systems made a showing with its RFC-1/B dial-up remote control. This unit speaks to the user with a natural human voice. It reports out-of-tolerance conditions and can automate transmitter power/pattern changes.

SWR offered its FME Series low-power FM antennas, including the FMEC for stations requiring circular polarization, the FMEV for stations needing vertical polarization and FMEH for stations requiring horizontal polarization.

Stainless Inc., which designs and ser-

VICES broadcast towers, introduced its Master Tower Leasing program and Station Guard Insurance, both of which enable broadcasters to cut costs.

Jampro Antennas brought to the show its complete line of rigid coaxial transmission line and related components, along with waveguide transmission line and accessories, FM bandpass filters and combiners, coaxial hybrid couplers and harmonic filters for FM applications. The company also served up its Penetrator Series FM side-mount antennas, low-power translator antenna and FM panel antenna.

Belden Wire and Cable tied it all together with its AES/EBU digital audio cables, line level audio cables and 50 ohm transmission cables and power cords.

Services On Display

► continued from page 66

Custom Business Systems Inc. (CBSI) creates software for traffic and billing. Among the products in its line: The Premier, the Classic and Elite systems. CBSI utilizes High-performance Object Technology (HOT) allowing logical and intelligent linking of tasks within the systems. Features include copy rotation schemes, user-defined configurations and a built-in backup utility.

The Omnia Group is a personnel consulting firm that has created a line of management tools including the Profile selection tool to ascertain a candidate's compatibility with specific demands, the MX3 system to build better managers and the ProManager assessment analyzer to identify and solve workplace problems.

Media Marketing Technologies performs analysis and provides plans for all station operations: including marketing, promotions, sales, engineering and programming. It does so through RadioPOLL, MediaMAPS and RadioPHONE products. The latter is a phone system to track caller volume and origination, as well as provide a listener line for audience call-ins.

The Griffin Reports is a research company providing up-to-date information about local radio markets. These reports include specific stores in a particular market (not just national data), key information about listeners such as residence, type of vehicle and dining habits. Reports issued by Griffin can be imported into TapScan and Strata software, and the company also provides in-house sales training for station staff.

Marketron's popular and long-standing Act II traffic and accounting software accommodates any sort of format (clients range from Easy Listening stations to Album Rock). Act II is configurable for a particular station through a 300-question file that customizes the program. At least two enhancements to the system are available annually at no cost to subscribers, and system support is provided by phone or modem from Marketron programmers and consultants.

Strata Marketing Inc. has developed the AXIS Windows-based station sales automation system. AXIS manages account information, traffic, ratings analysis and direct marketing. Strata software packages also include Q-View and Strata View Radio. Strata's View accesses Arbitron, Accuratings and Wilhight audience estimates.

PUMP UP THE VOLUME!

Now You Can Be Dominant and Sound Great at the Same Time

We have re-written the book on FM composite processing. Move up to the *crystal-clear* sound of the FM FlexiMod and control your market with a **dominant, dynamic** new sound.

The FM FlexiMod is the culmination of ten years of research into aggressive composite processing. Its new approach to loudness control without distortion, will revolutionize the sound of your station.

The FlexiMod will add sparkle and body to over processed, multi-generation audio, and enhance all program material for a consistent, dominant on-air sound.

The secret behind the breakthrough performance of the FM FlexiMod is our proprietary c-limiter circuit. This hybrid limiter-clipper will give you *brick wall* modulation control with extremely low second-harmonic distortion products.

Loudness without grunge!



The FM FlexiMod is the only processor you will need to guarantee your *dynamic presence* on the dial. It will clean up your sound and increase your loudness by **3db** or more!

We guarantee it!

FlexiMod: Already *over-achieving* in major markets nationwide
Only \$1395.

Available direct from MicroCon Systems or from selected dealers.
30 day no risk on-air trial

For further information contact:

Jim Somich at MicroCon Systems Ltd. • (216) 546-0967

Circle (130) On Reader Service Card

Consoles Heart of Studio

NEW ORLEANS Compact or massive, digital or analog, consoles for every application and individual taste were available on the WME exhibit floor.

Arrakis rolled out its 1200-15 15-channel console, which the company claims has been an instant bestseller. Alongside the 1200-15 were the 1200-10 and the compact 1200-5 consoles. The digital-ready 12,000-12 console, which features a built-in 8-bit digital control bus, was on display, as well as the Gemini-9 console, also designed for digital radio stations. The GEM-6 99-pushbutton control surface for Arrakis 12,000 and 22,000 Series consoles were also featured.

On display at the Wheatstone booth were the new D-500 digital audio console and the A-6000 master console, which offers flexible architecture and built-in logic and audio programming.

In the spotlight at Audioarts Engineering's booth was the R-60 on-air console, featuring a six-source line selector, module extenders, gold contact switches, Penny & Giles faders, Sifam

Alongside the Pacemaker was the Mini-Mix 12-A, a compact console with 25 stereo inputs, two stereo output buses, mono output and 12 plug-in slide pots. AEQ promised the right solu-

Consoles for every application and individual taste were available on the WME exhibit floor.

meters, better than 16-bit digital audio performance and simple phone module.

Autogram was keeping the pace at WME with its Pacemaker 1032 console, built, as the company says, with "intensive care." This model features machine control for all inputs, 10 pots (eight dual, two with eight inputs each), VCA level control, electronic switching and Penny & Giles linear conductive plastic pots.

tion for local broadcasters with the BC-500 mixing console. The BC-500 is designed to meet the needs of small stations, offering the features and advantages of professional equipment at an affordable price. The BC-500 is the standard configuration, which can be enhanced by adding new input modules or rearranging the modules within the chassis.

AEQ also displayed its BC-2000 mixing console, featuring interchangeable modules and

automatic circuit reset for pre-listening.

On display at the Ward-Beck booth were the Renaissance family of radio production consoles, in 8-, 16- and 24-input module configurations (Mark I, Mark II and Mark III, respectively). All models feature illuminated electronic switching, Penny & Giles faders that control channel VCAs, fully modular design and programmable functions on individual modules.

ATI appeared on the exhibit floor with its familiar Vanguard Series consoles.

Fidelipac served up its Dynamax MX Series of modular consoles.

Each input module of these consoles includes all the active circuitry necessary for its operation. The precision motherboard of the series has no active electronic components, so the user never has to disassemble the entire console to replace a single component.

Keep Audio in Line

NEW ORLEANS Check your audio? Makers of test and monitoring gear delivered the goods to attendees at this year's WME.

Potomac Instruments offered owners of its AA-51 audio analyzer the opportunity to upgrade the hardware of their instruments to include the features of the current "A" model production units for less than half the price of a new AA-51A. The company also exhibited a host of test and monitoring equipment, including the AG-51 audio generator, 1710TF and 1710TC temperature sensors, AT-51 Series of audio test accessories, QA-100 QuantAural audio program analyzer, 1900 Series digital antenna monitors and SMR-11 AM monitor/receiver.

ATI's setup included its Nanoamp Series BGD200 and BGD400 dual and quad bargraph meters. These meters display up to 12 critical audio lines in a single rack space. Available in two-channel horizontal and four-channel vertical configurations with either VU or PPM ballistics, multiple-color, 10-segment displays are visible even in bright sunlight. External 24 VDC wall-mount power modules can drive several Nanoamps simultaneously.

AEQ-America featured its AM-03 self-amplified stereo audio monitor. The AM-03's three-way audio system (monoaural for low frequencies, stereo for mid and high frequencies) gives the sound technician a good stereo image at a working distance of 12 to 40 feet.

Sine Systems offered an assortment of monitoring devices, including the ACM-1 AC Current Monitor, the AFS-1 Audio Fail-Safe and the Thermal Sentry transmitter monitor.

Belar highlighted its new RDS-1 RDS monitor/analyzer, along with its complete line of AM and FM modulation monitors.

DK-Audio, a Danish manufacturer, exhibited various versions of its Master Stereo Display, including the standard MSD550, which features overload indication and five international scales; the MSD550SA, featuring an FFT spectrum analyzer; and the MSD550E, equipped with a powerful "brain" that enhances its capacity and computation power.

New Program Choices

NEW ORLEANS There is no shortage of program material available to the radio station of the '90s, based on the amount of syndicators and services present at the World Media Expo.

USA Talk Network of Boulder, Colo., airs "After the Rush" with Aaron Harber, a show deliberately designed and promoted to go after Rush Limbaugh's syndicated talk program. The show is available by barter arrangement and minimum agreement to air "After the Rush" is 26 weeks.

Moody Broadcasting Network brings a host of religious and inspirational talk and music programming to subscribing stations. Special programming, strong personalities, a 24-hour news service and drama productions supplement the lineup of program material available.

Metro Networks is best known for traffic reporting. The network is also a source for weather reporting and news and sports coverage. In addition to local helicopter coverage of traffic in subscriber cities, Metro's Road Watch America tracks overnight road conditions for truckers and overnight travelers using reporters in over 50 U.S. cities.

Services provided by the Associated Press (AP) include the AP NewsDesk newsroom management software package; allowing custom assembly of radio newscasts, uses a built-in editor and on-line pronouncer, an Atlas of over 40,000 U.S. cities and counties and is LAN-configurable so several machines can function in one newsroom.

The Sports Network (TSN) provides text-only sports information of scores, major events, statistics and injury reports, and bonus coverage of Minor League Baseball and racing events. Transmission of TSN is done by FM sideband and KU-band satellite on G4.

Accu-Weather provides exclusive weather forecasts via fiber-optic phone lines, Comrex encoding or Switched 56 transmission for studio quality sound. Reports are jargon-free, personality-based and can interact with live on-air talent. Accu-Weather is available to only one station per market. No additional charge is made for additional reports during severe or unusual weather.

Country music and entertainment is provided

by the Branson Music Network, broadcast direct from Branson, Mo. Programming features interviews with stars, country classics and new songs, and "Branson Coast to Coast": a five-hour broadcast Monday through Friday evening featuring Rick Player.

Comedy services are abundant for the creative morning show, including the Premiere Radio Network. The company provides song parodies, interactive comedy bits and drop-ins and sound bites from movies and television. Also available from Premiere is "Cheap Advice with Calvert DeForest" (formerly known as Larry "Bud" Melman from the David Letterman show).

Radio Netherlands provides global audiences with award winning radio programming. Music broadcasts include "Live at the Concertgebouw" and "Worldwide Jazz". Talk shows consist of "Media Network," "Bats, Balls and Baselines" and various documentary programs. Radio Netherlands broadcasts in five languages over shortwave, mediumwave and satellite.

CUE and the Computer Radio Network (CRN) transmits data via FM subcarrier and is used on 500 radio stations to date. CRN information is received by the radio "Rock-It" card for personal computers and can consist of e-mail text messages, paging information, traffic reports and Differential GPS data for accurate global positioning down to one meter.

Several broadcast companies are adding to their services by establishing locations on the Internet.

While the CBS Radio Networks broadcast NFL football games, it will be providing links via the Internet to football fans. The address is <http://www.cbsradio.com> and the site supports schedules, highlights via Real Audio and game day weather forecasts.

Taylor Subscription Talk (TST) provides 24 hour talk programming that bypasses broadcast stations entirely. All TST shows are transmitted via direct-to-home satellite services (mini-dish receivers) and now via the Internet by Real Audio. The address is <http://www.tst.com> and listeners are charged per hour for receiving programming.



AMERICAN MEDIA SERVICES
1836 Barnett
Weatherford, TX. 76087

1-800-345-1953

For all your audio & video needs!

LOWEST PRICES IN THE COUNTRY

We have 3M, AMPEX, & BASF, Audio, video and digital tapes and any equipment you need.

Call and ask for a catalog

ITS FREE AND SO IS THE CALL

Give us a try before you buy.

You have nothing to lose.

We understand a tight budget

That is why our information is

FREE

and our products virtually are.

WME Featured Wealth of Services

by Alan R. Peterson

NEW ORLEANS Station services, music and promotional companies represented a sizable number of exhibitors at the World Media Expo.

Broadcast Programming (BP) has on-air music libraries available on TrueSource CDs. The libraries are formatted for AC, Country and CHR stations. Constant updates of weekly hits are available through BP.

TM Century is cooperating with Computer Concepts in providing "GoldDrive" digital storage; TM's GoldDisc Music Library is preloaded into the DCS Hard Drive system, saving

stations the time and expense of loading music on premises. TM also provides new programming packages on CD, including Roger Clinton Morning Show jingles (actually sung by the president's sibling), Twisted Tunes by Bob Rivers and a series of gospel-style and house band jingles for any format.

Toby Arnold and Associates (TA&A) is packaging sweepers, stagers and promo workparts for numerous formats. New collections include Generation X1 and X2; appropriate for CHR, Hot AC, Urban and New Rock stations. AC Plus is a package suitable for Adult Contemporary and the Young Guns/Rockin' Country package contains sweepers and

beds for Country formatted stations. TA&A has entire music and effect collections for most formats.

Sound Ideas' new buyout collection is the Mix III music library, with over 1,000 production elements on four CDs. This collection complements the existing Mix II compilation of 10 CDs. Sound Ideas also sells sound effect collections created by Warner Brothers, Hanna-Barbera, 20th Century Fox and others.

The production library from **Promusic Inc.** is nearly 1,400 discs strong and contain tracks suitable for radio, TV, motion picture and multimedia production. A number of licensing options are available, including needledrop, blanket or

annual license. Promusic averages ten new releases per month.

Non-Stop Productions is one of the newest players in the production music industry. The company licenses market-exclusive music for news programming and commercial production, and is available on DAT, CD or quarter-inch analog tape.

Killer Tracks represents and licenses the Production Music libraries from BMG and NJJ as well as its Killer Classics collection. The Killer Tracks library comes in CD format and is accompanied by a full catalog and PC/MAC software for cross-reference.

Companies specializing in station promotional aids included **Jackpot Promotions**, marketing the Jackpot Machine; a Las Vegas style "one-armed-bandit" that prints customized tickets good for prizes, station merchandise and special offers. Jackpot Promotions supplies the machine and custom Eprom chip to assure programmability of prize frequency.

KD Kanopy has the StarShade and StarStage outdoor specialty tents made of water and fire resistant polyester oxford cloth. The canopies are transported in three bags compact enough to fit in a car, yet can be assembled by two people to cover up to 800 square feet. KD also has the BannerPole, available in a variety of colors with heights up to 18 feet.

Broadcast Products, makers of the Remote Booth exhibited the ProSet portable display; an interior display product. The ProSet features clear polycarbonate graphics protection, an ABS carrying case and over 20 square feet of live graphic area for a station logo.

Measured Marketing improved on its Radio Diner concept by making it a powered driveable vehicle. The Radio Diner is configurable with a retro-50s luncheonette motif, Country or Rock interiors; can seat 16 guests and staff and has a built-in generator and dual shore lines for powering broadcast equipment.

Peregrine Press Ltd. prints and distributes the Essential Radio Travelers Guide of AM and FM radio stations. This publication organizes stations by state, format, frequency and city, and includes signal strength information and maps of cities where listed stations are located. Customized corporate premium editions are available for publication by Peregrine Press.

Communication Graphics of Broken Arrow, Okla., create stickers, decals and event patches for radio station promotions. Its creative team and graphic artists use computer aided design to produce logos and images, and offers removable "Statik Stik" decals as an alternative to adhesive-based stickers. Screen-printed graphics are bold and bright and are highly fade-resistant in exterior use.

Engineering support is provided by **AccuWatch** from the **Moody Broadcasting Network**. AccuWatch is a fully automatic FCC-approved transmitter monitoring service, allowing unattended operation of a station during overnight satellite or automation time. AccuWatch monitors station operations, maintains transmitter control via the Spacenet IIIIR satellite, and covers national EBS requirements. Moody also markets the Sine Systems line of walkaway devices, including audio failsafe sensors, temperature alarms and tower light current monitors.

Marketing and management companies that provide software and services keep radio stations running efficiently behind the scenes.

Since 1991, BE has introduced more new AM and FM transmitters, with more advanced ideas and useful technology, than any other company in the world. At the same time we were bringing prices down. No other company can touch Broadcast Electronics for value.

BROADCAST ELECTRONICS IS THE ONLY MAJOR MANUFACTURER DEVOTED EXCLUSIVELY TO ENGINEERING BETTER RADIO. CALL 217-224-9600 NOW.

GET MORE THAN YOU PAY FOR.

MORE

- Exciters that deliver CD-quality sound for under \$5400. Broadcast Electronics FX-50 exciter technology is unsurpassed.
- Transmitters with redundant PAs and power supplies that plug in from the front panel.
- AM transmitters with switching power supplies; they sound great at .1% or 100% output power.
- Transmitters with no plate blocking capacitors or sliding contacts to fail.
- Transmitters you can buy for under \$6000.
- All with 24-hour support.

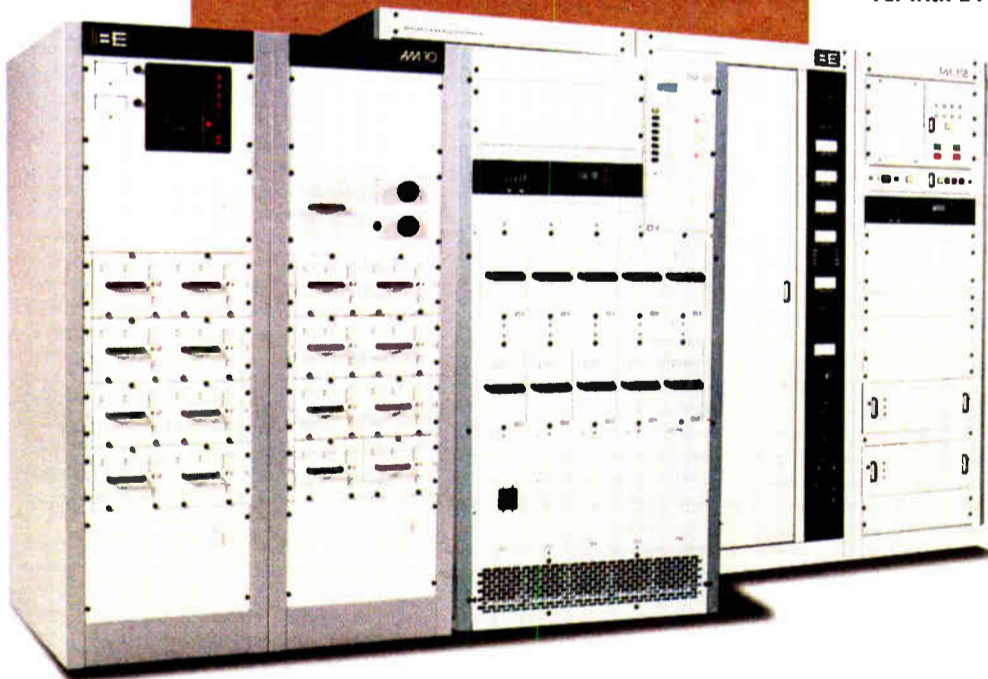

BE BROADCAST ELECTRONICS, INC.

WORLD LEADER IN RADIO BROADCAST TECHNOLOGY

4100 N. 24th Street/P.O. Box 3606/Quincy, IL 62305-3606/(217)224-9600/Fax: (217)224-9607

©1995 BROADCAST ELECTRONICS, INC.

Circle (41) On Reader Service Card

World Radio History

continued on page 68 ►

Editing, Production Equipment

► continued from page 63

editor and is offering it as the EDITOR as part of the DigiCenter package. This multitrack recorder/editor accommodates 50 stereo segments without bouncing and supports 2,900 segments inside a project.

Arrakis announced software upgrades for the Trak*Star eight-track editor; an option available for the Arrakis Digilink audio system line for radio station storage and playback. The original Trak*Star editor has been improved in the new version — Trak*Star III — with faster processing, an effects send bus, the ability for realtime fade, and editing and assembly of long-form audio up to 6 hours. Owners of the Digilink II system

have the option of adding Trak*Star II, providing basic scrub, edit, splice and fade features on eight tracks (four stereo groups).

Scott Studios of Dallas has included a production bank inside its digital audio playback system. This bank includes a graphic waveform multitrack editor for creative spots and promos, and a simpler digital "cart" recorder for voice tracks and less-elaborate spot work. The Scott System can also import finished production from most popular DAW editors; including Orban, SAW, SADiE, Card-D and most Windows-based PC programs.

Dalet Digital Media Systems is also

packaging multitrack editing capability with its Dalet radio station audio control system. A drag-and-drop Windows-based screen allows four or eight tracks of digital audio to be waveform-displayed for editing. Edits are non-destructive with unlimited undos, a Windows Clipboard feature for cutting and pasting and the ability for multiple project windows to run simultaneously. Mixing is internal from an eight-track project down to a single audio file.

Computer Concepts Corporation included StudioFrame into its totally integrated digital station system. StudioFrame is a Windows-based workstation allowing eight to 24 tracks of dig-

ital audio with drag-and-drop capabilities, editing and scrubbing features. StudioFrame allows waveform editing, time compression and expansion, EQ and provides an auxiliary send for effects. When work inside StudioFrame is complete, audio is sent directly to the hard disk for playback.

Media Touch Systems provides a three-level digital editor for its MediaDISK digital storage system. On the basic level, a simple cut-and-paste editor is specifically designed for rapid newsroom use. A rudimentary four-track production editor is also included, and the Pro version is capable of layering up to 24 internal tracks. Editing can be done with compressed files without file format conversion or real time transfers, and MediaDISK is capable of waveform editing.

RF Primer At SBE

► continued from page 61

Check all the operating parameters closely, especially monitor points. If they have shifted, look for environmental changes, such as new structures which could be re-radiators.

"Check all system components for any signs of heating and for proper operation. Clean and repair if necessary all variable controls, especially roller inductors and moving parts such as contactors before the consultant arrives and his meter starts running.

For FM stations, get a TDR (time domain reflectometer) for transmission line checking, and if possible have a tower company pre-check the antenna and line for any obvious physical problems. Have lots of coffee ready and try to get adequate sleep before the consultant's visit.

Keep it on ice

"Save the beer for the end of the project when you can all celebrate a job well done. If you don't already have one, get an updated copy of the FCC Rules and Regulations found in CFR 47, parts 70-79. They sell for only \$25 in paperback at any government printing office."

Battison told the tale of his most memorable "horror story" where an old AM directional's monitor points were all over maximum limits but the coverage in the major lobe was significantly reduced. The license information available at the station showed the array to be operating on completely different parameters. After checking with the FCC, it was learned the operating parameters were correct, but information on the last proof filed, including parameter changes was not made available to the new owner or his engineer.

To add to the fun, two new communications towers had been constructed in the major lobe within a half mile of the array and were verified to be significant re-radiators. And of course, most of the controls on the phasor were frozen and could not be adjusted.

A full non-directional and DA proof were required, which showed that urban build-up had reduced the apparent conductivity around the area significantly. Twenty thousand dollars and many months later, the system was restored to legal operation.

ONCE YOU'VE
SET THE STANDARD,
THERE'S ONLY
ONE THING TO DO

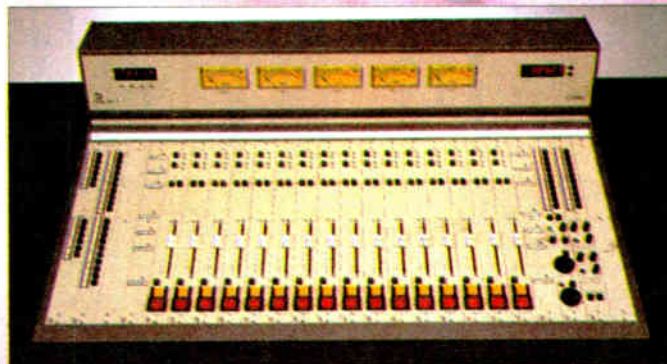

RAISE IT.

RENAISSANCE

Ward-Beck Renaissance Series consoles once again set the standard for today's desktop radio environment. • They offer easy integration with automation systems; modular units to make expansion and service easier; 4 telco send outlets; 8 to 24 input channels; live, live assist and walk-away operating modes, and more. • Once you've seen the quality of Ward-Beck, you'll understand why Renaissance is the first choice of discerning radio engineers the world over. • Call toll-free 1-800-771-2556 or write, Ward-Beck Systems Ltd., 841 Progress Avenue, Scarborough, Ontario, Canada M1H 2X4. In Toronto call (416) 438-6550 or fax us at (416) 438-3865.

W A R D — B E C K S Y S T E M S L T D .

Two portables & two pairs of cans



The new SADiE Portable.
The first portable digital
audio workstation.

SADiE customized
Pentium Portable PC
Digital, analogue and
time-code cards
SADiE software V.2.2
Four Gigabyte
removable SCSI drive
Headphone amp
Switchable power supply
Lightweight flight-case



Price \$13,995.00



Studio Audio Digital Equipment Inc.
1808 West End Avenue
Suite 1119
Nashville
TN 37203
Tel: 615 327 1140
Fax: 615 327 1699

Circle 1133 On Reader Service Card
World Radio History

Editing, Production Gear Proliferates

by Alan R. Peterson

NEW ORLEANS The combination of cost, simplicity and power of digital workstations and editing systems have now made the decision of "going digital" a matter of *when* — not *if*. The floor of the World Media Expo exhibition area was filled with gear for every budget and station configuration.

The classic **Orban DSE-7000** digital audio workstation is now available with version 5.11 software. The enhanced software allows the DSE-7000 to recall 24 Locate points and instantly move to any Time location in a project. The system also supports hardware-based MPEG sound file export to numerous on-air systems. This allows MPEG-compressed audio to be exported from the DSE-7000 to the BE AudioVault and Enco DAD486x storage/playback systems; a feat demonstrated throughout the convention. Orban also has demonstration CDs and videos available on request.

Much of **Roland Corporation's** floor space was devoted to the portable DM-800 digital audio workstation. The DM-800 is an eight-track digital recorder/editor/mixer in a 12-pound package, features time compression, a video port to connect to external monitors and connections for S/P DIF digital I/O, Alesis ADAT and Tascam DA-88 recorders. Roland ships the device with or without internal 500 MB SCSI drives, and has a line of accessories to support the DM-800, including roll-around floor stands and shipping cases.

Studio Audio and Video of Cambridge — makers of the SADiE Disk Editor — exhibited the Octavia modular digital editing system, said to have six times the processing power of the original SADiE. The Octavia comes with a full transport/edit controller, and a fader panel with eight assignable motorized faders. Up to 10 Octavia units can be combined for 80 channels of digital and analog I/O and 1.3 GFlops of processing power. Cambridge-based CEDAR Audio has created custom noise reduction software called "De-Noise" which will be shipped with SADiE3 software later this year.

Studio Audio also exhibited the SADiE Portable audio editor; based around a Pentium PC and capable of editing up to 6.5 hours of stereo audio, and the Mobile Field Recorder: a portable stereo hard disk recorder with balanced XLR connectors, three sample rates, optional digital I/O and more than four hours of recording time.

The **Fostex 2000RE** workstation was on display. The 2000RE is a two-piece system consisting of a rackmount unit for the drives and computer, and the Fostex Edit Controller for the operator position. The controller includes familiar transport and record-ready buttons, and a weighted jog/shuttle wheel to locate and scrub audio. A touch screen complements the dedicated controls to give the Fostex a high degree of power. The main unit handles balanced and unbalanced analog audio at +4 or -10 dB, supports digital I/O and several timecode formats, has connections for

additional SCSI2 drives and interfaces with Alesis, Tascam and Fostex digital multitrack tape recorders. The main unit also supports the proprietary Fostex RPE file format for removable recording media, allowing shared information with other Foundation units.

Multitrack digital editors are also being included as part of complete hard disk systems, as stations seek to unify their audio needs into one single package.

ITC licensed the MicroSound digital
continued on page 65 ▶



Studio Audio and Video's Octavia Editing System

More Powerful. More Efficient.

Nautel Solid State Modular AM & FM Transmitters

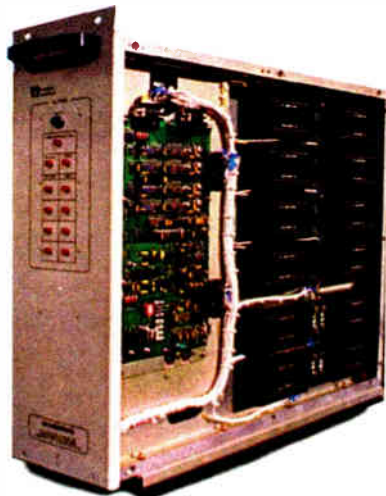

AM Power Module

12 kW & 60 kW AM

New Design **Nautel** 12 kW and 60 kW AM transmitters deliver power and modulation capability to spare.

Energy costs are lower than ever with overall efficiency typically 85-88%.

Only **Nautel** offers complete duplication of exciters and on-air serviceability of modules to keep you broadcasting.

Nautel — Continuing 25 Years of Solid State Leadership.

10 kW & 20 kW FM

The **Nautel** FM10 offers 11 kW solid state FM power capability in a single cabinet. A 20 kW combined system is also available.

The highest AC to RF efficiency of any solid state FM transmitter means less waste energy and cool reliable operation.

The **Nautel** design keeps you on the air even with a module removed for service.

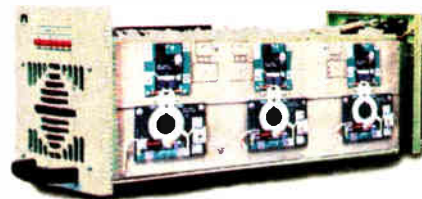

FM Power Module



Contact us for more information about our full range of AM and FM transmitters.

Nautical Electronic Laboratories Limited Hacketts Cove RR #1 Tantallon, Nova Scotia, Canada B0J 3J0 Phone: (902) 823-2233 Fax: (902) 823-3183
Nautel Maine Inc. 201 Target Industrial Circle Bangor, Maine 04401 U.S.A. Phone: (207) 947-8200 Fax: (207) 947-3693

Source Gear Gravitates to Hard Disk

by Alan R. Peterson

NEW ORLEANS Studio source equipment was decidedly digital at the World Media Expo, but there still was room to accommodate some analog favorites.

Hard disk cart replacement and music storage systems were big news on the exhibit floor, with most major companies providing their versions of the technology.

360 Systems announced new software for the Instant Replay hard disk audio recorder allowing sequential playback of cuts chosen for a playlist, remote control and the ability to backup selected banks

of audio to DAT or other Instant Replay systems.

The Arrakis Digilink III was shown in a number of configurations, including stand-alone and air-and-production studio with one unit. The Digilink III has dual stereo outputs, triple play and record capability and four times the power of the Digilink II. Configurations included the Gemini live on-air controller surface and the Gem I live workstation.

Media Touch Systems originally created the touchscreen environment for WBZ(AM), Boston, and at the WME were exhibiting the new version of the MediaDISK audio storage system for cart replacement and music library applications. MediaDISK supports several compression formats including Dolby AC-2 and MUSICAM, with compression ratios up to 8:1.

Enco America demonstrated the versatility of the DAD486x digital delivery system by connecting it to the DSE-7000 digital editor in the Orban exhibit and the Telos Zephyr ISDN transceiver in the Telos booth. Enco also announced the availability of DADSAT, where satellite uplinkers can address and encode material for local capture by designated DAD subscribers.

AEQ America's MAR audio storage system allows on-screen language selection, automatic news recording from field reporters, and standalone or network configurations. MAR supports MUSICAM compression and can even run on a 386-DX platform.

Dalet Digital Media Systems total station network runs in the Windows environment, making it easy to use. The self-contained system allows for automation and live operation, automated recording,

newsroom editing (via the Surfer cut-and-paste editor) and traffic management. Dalet's "In Flight Mix Editor"

Studio source equipment was decidedly digital, but there still was room to accommodate analog.

allows the preview of music segues and the drop-in addition of talent voice-overs.

Scott Studios audio storage system includes a "paperless" studio window for live copy, weather and promos; a

The Audio Wizard from Prophet Systems Inc. runs under Windows and links Pentium-based workstations together through a Novell network. Features include the ability to automatically backtime events to fill each hour, global or individual song crossfades and expansion of up to fifty workstations. The Windows environment allows multi-user, multitasking realtime operations.

ITC is touting universal connectivity with its DigiCenter audio management system. Remote control I/O logic allows digital control over existing analog cart machines (as well as digital cart emulation), satellite and program automation and easy interfacing to traffic, accounting and billing are all features of the DigiCenter system. DigiCenter also combines integrated text and audio in its NEWS newsroom management system, and 256 hot buttons for instant playback in the Quick Access window.

Electric Works Corp. is shipping the



LMA/DUOPOLY CONTOUR MAPS

The **DATAWORLD** LMA/DUOPOLY Market Survey Contour maps present a precise electronic verification of overlapping and intersecting contours.

AM 5 mV/m and FM 3.16 mV/m City Grade contours are shown in full color, including transmitter site indicator. The map is supported with a printout showing all of the stations which appear on the map.

Daily updating of **DATAWORLD'S** AM and FM databases protects against errors and omissions.

OTHER MAP OPTIONS

- SHADOWING (TERRAIN SHIELDING)
- CONTOUR COVERAGE
- POPULATION DENSITY
- ZIP CODE BOUNDARIES
- RECEIVED SIGNAL LEVEL
- SPECIAL REQUIREMENTS

1990 CENSUS

WHO ARE YOUR LISTENERS?

1990 BUREAU OF CENSUS POPULATION COUNTING

- Comprehensive Ethnic and Demographic Data
- Ethnic/Demographic Data Available for Each Zip Code Within Coverage Area
- Age Analysis Reflected in Ethnic Breakout
- Resolution Increased to Block Level
- Percent of County Coverage Shown

ETHNIC PIE-CHART DISPLAY

- Projects Ethnic Population in Multi-Color Pie Chart Form

dataworld®

800-368-5754 FAX: 301-656-5341

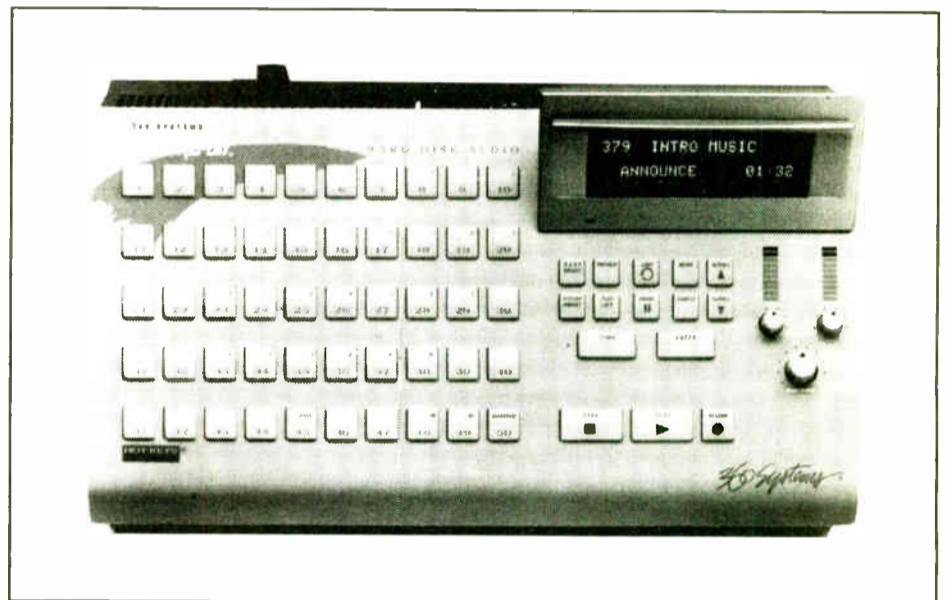

360 Systems showcased its Instant Replay.

phone recorder/editor for caller playback and a "cart wall" for instant playback of music or retrieval of commercials.

modular AXS system in several configurations, from single studio playback machine to extended automation control operating CD players or satellite receivers. Systems with up to 65 hours of hard disk storage time are available. Electric Works also has the Digital Cart Machine (DCM) for live playback and paperless studio operations, and the Digital Longform Recorder (DLR), capable of recording up to four stereo channels of audio programming simultaneously.

Recording technology was well represented by the Fostex line of DAT machines; including the D-10 two-head DAT recorder with RAM buffer for audio scrubbing, digital/optical/analog inputs and the ability to number up to 799 program numbers; the D-25 four-head DAT recorder with sync-to-video capability and the D-30 with a large high-resolution backlit LCD display of all machine functions. The Fostex PD-4 portable DAT was also shown, with integrated 3-channel mixer, timecode recording and no copy-guard.

The Nagra company displayed the ARES-C portable recorder for field recording and news gathering. The tapeless recorder writes digital audio information to PCMCIA memory cards and allows full editing features in the field right from the recorder. An optional ISDN interface — in addition to a standard telex connection — is offered for calling in reports from the field.

With or Without?

Two new digital-synthesis FM Stereo Generators. One includes Audio Processing, the other does not. Both offer greater than 60dB separation and response beyond the usual 15kHz!



"DAVID-II," Model 716 — Our popular *DAVID* now has feedforward-PWM audio processing and an adjustable Composite Processor. Competitive loudness *plus* long-term listenability! **\$1985**



Model 708 — This new "basic" Stereo-Gen features accurate front-panel metering, our patented overshoot compensation, and a built-in adjustable Composite Processor. A fantastic performer! **\$1530**

Inovonics, Inc.

1305 FAIR AVE., SANTA CRUZ, CA 95060 U.S.A.
TEL: (408) 458-0552 — FAX: (408) 458-0554
E-MAIL: inovonics@aol.com



Engineer Primer on Art of Dealing with RF

by Thomas R. McGinley

NEW ORLEANS The ability to deal with RF problems, especially antenna systems in a broadcast plant is rapidly becoming a lost art. Four very knowledgeable experts working in this field shared their considerable experience and know-how at the SBE Engineering Conference session at World Media Expo titled "RF for Radio."

Timothy Cutforth, PE, with Vir James Consultants of Denver lead off with an examination of "RF Phase Response vs. Sound Quality in AM Broadcasting." Cutforth cited the classic paper on this topic by W.H. Dougherty, published in 1947 and likened the poor performance of some transmission systems to a misaligned playback head on a tape machine.

The degradation occurs because of excessive phase shifts across the pass-band response.

"Group delay has been shooting AM in the foot here when we always thought it was only an amplitude problem. It seems only FM and TV have ever worried about group delay," he said.

Important for DAB

Good phase response is not only a factor in achieving loudness and penetration today, but will be very important for AM DAB. Cutforth examined various field test examples whereby merely changing the phase delay in a transmission path and/or reducing the number of low-pass lagging T networks in a system dramatically improved on-air quality and loudness.

"Each lagging network slightly rolls off high end response and can add 5 degrees of phase shift between the upper and lower sidebands. If a system has 10 such networks, 50 degrees of shift across the pass-band would result, causing noticeable degradation," said Cutforth. He also noted that the Kahn ISB "Powerside" can help reduce the effect of such phase errors by half because only one sideband is used.

J.L. Smith, a retired PE formerly with the Collins Radio Company for many years presented a paper titled "Post Processing Yields Improved Parameters for Directional Antennas." Post Processing refers to the manipulation of computer output data derived from MININEC, which is the compact version of NEC (Numerical Electromagnetics Code), a computer program that models antenna properties and performance. Smith acknowledged that while antenna design engineers would find the paper useful, his target audience was primarily those engaged in the operation and maintenance of AM directional antennas.

He gave a brief technical overview of MININEC, its use on a personal computer, as well as the theory of induced current moments. The program computes current distribution along any vertical radiator by breaking it into a series of segments. The total radiated field is the integrated sum of each segment's current moment.

Because of the mutual coupling of other nearby radiators in a directional array, current distribution along each element does not always form a perfect sinusoidal pattern. The resulting distortion modifies actual driving point impedances and sampling parameters to values different from

Battison stressed the value of keeping good records and paying attention to the rules.

theoretical expectations derived from traditional sinusoidal analysis. MININEC thus allows the field engineer to more accurately establish and maintain tower base network matching and system performance.

The presentation showed how MININEC derives antenna driving point parameters and field values, optimum sampling loop positions, synthesized pattern parameters, as well as how to evaluate pattern distortion resulting from parasitic radiators. Smith noted that MININEC is public domain software in its purest form, however modified versions available for a price from various consultants are much easier to use for AM broadcast applications.

Jerry Westberg of Broadcast Electronics offers one such version. For more information about MININEC, call him at 601-872-2009.

Optimizing

"Optimization of Broadcast Antenna Systems" has long been a favorite topic of presenter Thomas G. Osenkowsky, an independent consultant based in Connecticut. Osenkowsky has renovated and optimized numerous AM and FM antenna systems and described various methods a station engineer can use to determine if his antenna system is operating in optimum condition.

The first step toward improving an existing AM antenna system is to conduct a thorough measuring and data collection effort of all actual operating parameters, tower base impedances, network in/out impedances, system input impedance response, and transmission and sample

line length measurements to establish a base-line of as-built performance.

Step two involves evaluating the existing system design, perhaps with the help of a qualified consultant and then implementing appropriate modifications and hardware updates if needed. The last step is fine tuning the renovated system and optimizing system performance by field measurements.

The presentation focused on how to perform these measurements, rather than mathematical analysis of the measurements or data collected. Osenkowsky described an easy method to evaluate system bandwidth performance whereby the transmitter is modulated to 50 percent with a 10 kHz tone and a field meter placed in the major lobe is then tuned to the +/- 10 kHz sideband frequencies to

measure the recovered fields.

A reading of 25 percent field for each sideband referenced to 100 percent at carrier would represent perfectly flat bandwidth performance.

Pattern bandwidth performance can be easily evaluated by replacing the transmitter's crystal oscillator with a VFO and sweeping the entire RF chain including the antenna system at very low power during the experimental period. Antenna monitor parameters at each 10 kHz sideband frequency can then be used to derive and plot each sideband pattern and compare them with the carrier pattern.

Keep the basics

Osenkowsky stressed the importance of observing the basics in order to assure stable optimized performance from any antenna system. Good grounding and solid bonding of all copper straps, radial wires, and tower section joints should be

periodically checked.

All sampling elements, especially outside loops and their cables and connectors need to be inspected, cleaned, and tightened. He recounted the challenge of rebuilding an old three tower array which had been grossly misadjusted upon initial installation and had then deteriorated over the years.

A common problem encountered with such systems is lost array power in negative towers because of poorly designed and adjusted phasing networks. After the system was cleaned up and retuned with a computer-optimized phasing design, the array was significantly more stable with improved audio performance.

John Battison, one of the founders of SBE, shared many valuable insights gained over 50 years of active experience as a consultant and author in his presentation called, "What To Do Until the Consulting Engineer Arrives."

Being prepared

Battison's best advice centered around the old Boy Scout motto, "Be Prepared." He stressed the value of keeping good records and paying attention to the rules, which are still enforced by Federal Communications Commission (FCC) field inspectors.

"Whenever I am asked to evaluate a station, I look for the basic requirements: copies of station licenses and operator permits, maintenance logs, proof of performance and partial proof reports, and monitor point logs. It's surprising how many stations can't produce any of these!"

Battison offered suggestions on how get the most out of any visit by a consultant. There are many important tasks which the station engineer should perform before the consultant arrives.

"Get all the paperwork organized and ready, including licenses, proofs, maintenance and monitor point logs, and maps.

continued on page 65 ▶

New
\$245.00

CONEX ELECTRO-SYSTEMS
CellJack™

SEND LEVEL B'CAST MIC / LIN HANDSET
RCV LEVEL PWR HEADSET

Cellular Telephone Interface

Microphone, tape and tuner inputs • Headphone Jack • Send and receive level controls

Works with most Motorola bag phones

CONEX ELECTRO SYSTEMS
1-800-645-1061 (360) 734-4323 FAX (360) 676-4822

Circle (37) On Reader Service Card

LET YOUR TOWER PAY YOU

Signal One can locate tenants, execute lease agreements, and manage your tower site to produce revenue that you never realized was available.

Signal One manages and owns communication sites throughout the USA and has a large customer base that includes BellSouth, PageNet, PageMart, Federal Express, motorcarriers, and other financially-sound users that can help you enhance your operations.

Call Signal One today and let us demonstrate how we can fill your tower site with tenants.

Fax us your tower site information to (423) 954-3222 that we may include this data in our nationwide tower database for our many customers to utilize and possibly lease on.

SIGNAL ONE
"One Call and Your Signal Is On™"
(423) 954-1111

5700 Brainerd Road
Uptown Building Suite 407
Chattanooga, TN 37411

Circle (108) On Reader Service Card

Products & Services Showcase

For more information on the products shown below, circle the appropriate Reader Service No.(s) on the enclosed Subscription/Reader Service card or contact the advertiser directly.

THE FINEST STUDIO SYSTEMS IN THE BROADCAST BUSINESS

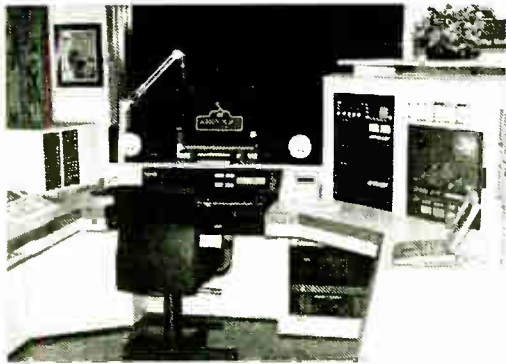

Audio Broadcast Group Inc.
Studio Furniture & Prewired Systems

Your studio environment specialists
for the last 35 years.

We Are The Industry Standard.

For additional information on how we can serve you, please call today.

SOUTHEASTERN SALES OFFICE
200 Fareway Drive, Suite 2
Smithfield, North Carolina 27577
Phone: 800-369-7623
Fax: 919-934-6120

MAIN SALES OFFICE
2342 S. Division Avenue
Grand Rapids, Michigan 49507
Phone: 800-999-9281
Fax: 616-452-1652

WESTERN SALES OFFICE
P.O. Box 1638
Palmdale, California 93550
Phone: 800-858-9008
Fax: 805-273-3321

For 35 years

YOU MAY ALSO REACH US ANYTIME VIA ELECTRONIC MAIL

cServe: 75371,144
internet: support@abg.com



READER SERVICE NO. 9



Econco REBUILT POWER TUBES



Approximately One Half
the Cost of New

3,000 Hour Unconditional Guarantee

Call for Our Price List

Econco 1318 Commerce Ave. Woodland, CA 95695
Phone: 916-662-7553 Fax: 916-666-7760 Telex: 176756
Toll Free: 800-532-6626 From Canada: 800-848-8841

READER SERVICE NO. 136

VACUUM & GAS CAPACITORS



Over 800 Capacitor Models

Voltage Ratings to 100 kV
Variable & Fixed
Vacuum & Gas
Unlimited Capabilities

Applications: Communica-
tions, Power, Electronic, Semi-
conductor Fab, Dielectric
Heating Equipment, & Medi-
cal MRI & Heart Defibrillators.
Ask about our vacuum & gas
relays & other components.

JOSLYN JENNINGS CORP.

Phone: (408) 292-4025 Fax: (408) 286-1789

Request a FREE catalog

READER SERVICE NO. 87

DON'T BUY A DIGITAL AUDIO SYSTEM UNTIL YOU TALK TO US!

The Digital Juke Box

Digital Broadcast Automation

More Features
+ Less Money
= A much better deal



Listen-Up Software
One Eleven Sandy Ave
Moundsville, WV 26041

(304) 845-4767 Phone
(304) 845-0038 Fax

READER SERVICE NO. 214

Superior Broadcast Products

Designed and built to be the best
150 and 300 watt FM Transmitters

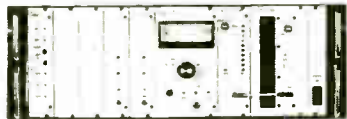

Standard Features:

- Frequency Agile lets you change frequency in minutes
- Overload Protection for Ref. Power, Current, Temp
- Remote Control Interface Built In
- Overload Led's for Ref. Power, Current, Temp
- LED Read out for modulation and deviation
- Front panel power adjustment
- Full Metering of Forward Power, Ref. Power, Current, and B+
- MPX and Mono inputs on rear panel
- One year limited warranty
- 115/230 volts - 50/60 CPS
- Excellent signal quality and reliability
- Ease of Installation
- Meets or exceeds FCC specifications
- Rugged construction for durability
- All modules plug in from front

Optional Plug in Modules:
Compressor/Limiter...Stereo Generator...
Automatic Station ID

Superior Broadcast Products

3941 Legacy Dr. Suite 204-208B Plano, TX 75023
Ph: 800/695-7919 Fax: 300/644-5958

READER SERVICE NO. 176

The CircuitWerkes AC-12 Telephone Autocoupler Bay

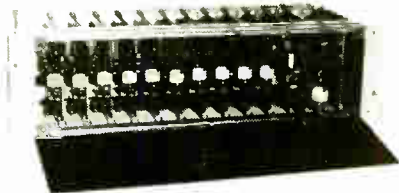

Get up to 12 couplers in a neat, compact chassis

- Auto-answer & disconnect.
 - 2 audio busses for mass feeds.
 - Individually card selectable buss or auxiliary audio I/O.
 - LED indicators for ring, clipping, power & online.
 - Ring counter answers on user seatable ring number.
 - Momentary or latching dry contact outputs at pickup.
 - Remove & install cards without affecting the rest.
 - A special, non-bussed, balanced audio card for IFB feeds, etc., is available.
- The AC-12 rack-mounted coupler bay is the best way to eliminate a wall or cabinet full of yesterday's couplers. Our unique dual audio busses eliminate the tedious and messy wiring associated with networks and other mass feeds. Each card can also individually either send or receive telco audio. Best of all, a fully loaded AC-12 lists for under \$185 per coupler.

CircuitWerkes

6212 SW 8th Place
Gainesville, Florida 32607
(904) 331-5999 / fax 331-6999

READER SERVICE NO. 16

A Broadcast Industry

BEST BUY

Cartridge Recorder / Reproducer
Mono R/P Stereo R/P

\$1550 \$1800

(F.O.B. Factory - U.S. \$)

RELIABLE / RUGGED
PROFESSIONAL DESIGN

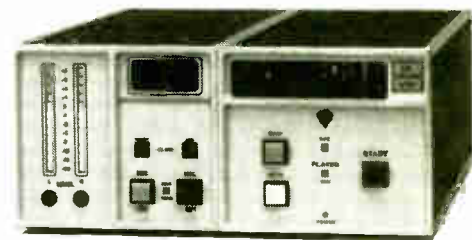

DL Series

AUDI-CORD CORPORATION

1845 West Hovey Avenue
Normal, Illinois 61761 USA
Phone 309-452-9461
Fax 309-452-0893

Available Through Your Regular Distributor

READER SERVICE NO. 182

Management, Technology Focus of Ennes

by Thomas R. McGinley

NEW ORLEANS The Society of Broadcast Engineers Engineering Conference again offered a day-long workshop at the WME for engineers to learn about new technologies as well as an opportunity to sharpen their management skills. The morning session topics included digital video and computer systems, solid state power amplifier troubleshooting and repair, and solid state FM transmitter theory and design.

After a lunch break, a comprehensive session on the new EAS (Emergency Alert System) as well as a forum on Broadcast Engineering Management was presented. Attendance at this event was open via pre-registration only.

Leaving analog age

Video generation, editing, and transmission is rapidly leaving its analog roots behind and becoming a largely all digital affair. With an eye on what is involved in designing all-digital television facilities, Bob Paulson, consultant and founder of OmniMedia Communications brought together an impressive group of hardware, software, and transmission services vendors working in the digital video arena.

The session integrated presentations of the products and services of Aiden Electronics, Intelligent Resources Integrated Systems, AT&T Network Systems, Belden Wire & Cable, Force Inc., Kings Electronics, Panasonic Broadcast, and Telecast Fiber Systems.

In his overview, Paulson examined the computer bus, coax, unshielded twisted pair (UTP) and fiber infrastructure needed for television production, post production, distribution and/or broadcasting in an all-digital plant. Presently most facilities use a mixture of analog and digital interconnecting, distribution, and routing methods which are incompatible and unconnectable.

Existing analog, coax, and shielded twisted pair (STP) cabled routing systems are useless to handle digital video and audio traffic.

Digital signals are currently being transmitted as fixed bit rate uninterrupted data streams traveling over loss-limited lengths of point-to-point coaxial cable. Digital data bit rates range from 38 kbaud from some graphics workstations to 1.5 gigabits per second for playback of wide screen uncompressed video and eight AES/EBU audio signals from an HDTV VCR.

The session detailed the design of a UTP/fiber infrastructure and transportation protocol which can accommodate switched, packetized transport of all these signals throughout an all-digital plant at dramatically lower installation and operating costs.

Hands-on session

"Solidstate Power Amplifier Troubleshooting and Repair" was a hands-on session lead by Karl Black of Harris Allied's broadcast division. Black spent many years at the station level as a working engineer before joining Harris. The session focused on methods of minimizing down-time and cost of fault detection and repair of solid state power amplifiers used in both radio and TV transmitters.

Actual hardware from selected Harris transmitters was shown with demonstrations of proper replacement techniques of

both active and passive components including field-effect devices as well as sub-assemblies. Emphasis was placed on how these techniques differ from servicing older tube amplifiers, including the proper handling of devices sensitive to damage by static electricity and the use of appropriate desoldering techniques and tools.

The demonstration featured the showing of a video tape produced by the Harris Broadcast Technology Training Center detailing the finer points of troubleshooting and repair techniques.

QEI Corporation Director of Marketing, Jeff Detweiler presented a comprehensive workshop on solid state FM transmitter technology. The session featured discussion of solid state amplifier design theory, RF combining techniques, lightning protection, multi-user site concerns, bandwidth and return loss, environmental considerations, and maintenance requirements.

Comparative advantages

Detweiler first described the comparative advantages and disadvantages of bipolar devices versus FET (field-effect transistors) used in solid-state amplifiers. FETs exhibit high gain, need lower drive levels, are thermally stable and easier to combine, and operate at higher voltages but are more static sensitive. Bipolar devices operate at higher efficiencies and are generally cheaper, but are more critical to drive level and are more difficult to combine, using lower operating voltage and higher currents.

Proper bonding and grounding techniques at transmitter plants were discussed at length. The "star" system was cited as perhaps the most effective with all equipment and racks tied together to the tower base, outside ground system, and power company ground with four-inch copper strap.

"Getting all potential differences between the various components minimized as much as possible is the key," according to Detweiler.

New cooling techniques for high power solid state was considered. QEI has spent some effort exploring the challenge of making a liquid-cooled amplifier which could be removeable as a module under power and still keep the cooling lines from leaking. Other manufacturers believe that getting beyond 10 kW FM in a single box with solid state will require some form of liquid cooling.

Westinghouse has done some developmental work with silicon carbide devices which can run at 200 degrees F with air cooling. Some kind of technological breakthrough will be needed to get beyond the 10 kW barrier for FM at realistic costs.

The session ended with a sneak preview of QEI's all digital exciter which is slated for introduction next year. The design is based on the use of new linear devices which can achieve RF and modulation generation "on-carrier," thus eliminating the disadvantages of heterodyning. The unit will be offered with power amplifier outputs of 75 up to 600 watts.

New EAS

The recent FCC reordering of the present EBS into the new EAS will bring a wave of changes in how broadcasters deal with public emergencies.

Leonard Charles, chairman of the

National SBE EAS Committee lead the EAS Ennes Workshop through a detailed understanding of what the revised FCC EAS rules will provide and require. The proposed changes will make the mandated national emergency alerting capabilities more foolproof, wherein a Web structure of emergency message relaying will replace the present EBS serial relay system.

The session offered a step-by-step outline of how an effective Local Area EAS using the Web concept can be built from the ground up.

History has proven that most public emergencies occur at the local level. The FCC leaves the local plan completely up to the local broadcasters and local government emergency officials. It is here where the greatest potential for EAS will be realized.

Modern management

The future for the broadcast engineer is very much dependent on what the engineer does today. Engineers must recognize that the role they play at their respective stations as well as the profession itself is ever-changing.

David Carr, director of engineering of KHOU-TV Houston, and Troy Pennington, chief engineer of WZZK-AM-FM Birmingham teamed up to present an in-depth look at modern broadcast engineering management. The session focused on methods of day-to-day engineering management practices for both radio and TV stations.

The discussion tackled the following issues and concerns facing all broadcast engineers:

- Maintaining a close relationship with station department heads
- Being an information resource for the station manager
- Staying visible and accessible
- Getting along with others
- Obtaining continuing education
- How is engineering being perceived by others in the station
- The engineer's self analysis ... how productive am I?
- Participating and offering input for management decisions
- Keeping up with the new wave of technology
- Being protective of your turf in an amiable manner
- Constructing and following a budget
- Communicating technicalities to non-technical personnel

Today's engineer must set reachable goals and continue to hone technical, management, and people skills. He must play smart, must be cooperative, cannot offer excuses for explanations, and cannot procrastinate. The engineer must realize that if the station loses, he loses as well.

This workshop was ripe with food for thought for the engineer who really wants to succeed and be more effective, whether it be at the staff technician or the management level.

MODULATION WAR?

If you're getting your face pushed in the dirt by the guy across the street, it doesn't have to be that way. In these major markets, where competition is fierce and the rewards are large, broadcaster after broadcaster has picked the COBALT BLUE™ Neural Network power booster for the Optimod 8100* in A/B comparisons.

Atlanta
Charlotte
Cincinnati
Indianapolis

New York
Orlando
Providence
Washington, D.C.

COBALT BLUE™ is the world's first Neural Network audio processor. It's a whole new technology. If you need more power and you need it now... if you have an existing Optimod 8100 preceded by a Compellor** or a pair of Audio Prisms***, call (814) 235-1410. We'll do the rest.

CLARK
COMMUNICATIONS

208 West Hamilton Avenue - P.O. Box 20
State College, PA 16804-0020
Phone: (814) 235-1410 Fax: (814) 235-1462

* Optimod is a trademark of AKG Acoustics, San Leandro, California
** Compellor is a trademark of Aphex Systems, Ltd., Sun Valley, California
*** Audio Prism is a trademark of Gentner Electronics, Salt Lake City, Utah

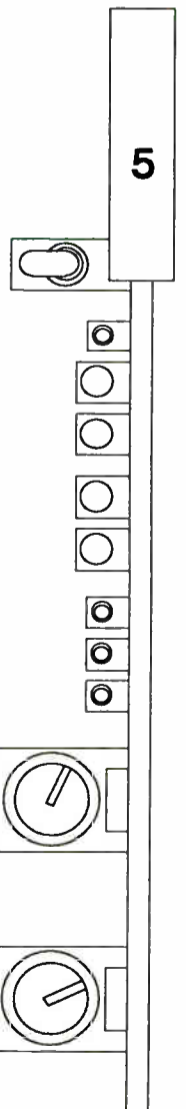

Personality Radio Not Just for Mornings

by Alan Haber

NEW ORLEANS Is personality radio a force to be reckoned with on the airwaves? Does the radio industry nurture personality? It certainly does in morning drive — witness the successes of Don Imus and Howard Stern.

But what about during other dayparts? How does personality radio fare at other times of the day?

"Personality Radio Outside Morning Drive," an informative session at the 1995 NAB Radio Show, tackled these and other questions. Panelists included Doug Banks, afternoon personality at WGCI-FM in Chicago; Carolyn Fox, afternoon

drive personality at WHJY-FM in Providence, R.I., and two-time Marconi Personality of the Year award winner Gary Burbank, WLW(AM) Cincinnati.

Life after morning

Moderator Jay Clark, program director at WTKS-FM in Orlando, Fla., asked the panel why owners should hire premium dollar talents instead of simply playing music.

Burbank said that owners have to realize there is life after morning drive.

"Most of the time," he said, "PDs seem to think you can't be funny, you can't perform outside of morning drive." He noted that "the concept of not being wall-to-wall music or confrontational talk, or

something like that, can actually work in afternoon drive."

Banks said that, after doing mornings in Chicago for a number of years, he was burned out. He told station management he wanted to move to afternoons, where he has been number one for the last two years. Music is still a part of his show, but people are going to hear some personality when they listen.

Owners should invest money in afternoon talent, said Fox.

"It has always been my belief, as far as business goes ... you've got to spend to win," she noted.

Fox said she loved the notoriety and attention that went along with doing

mornings, but she said she was "half asleep my whole life, and I was very resentful, cranky, bitter. I wasn't able to do half the stuff that I can talk about now in afternoon drive."

Opening up afternoon drive to "more than music gives an opportunity for ratings growth, because you've got another way to market the show," she said.

"You have got another reason for people to listen."

Skills

Asked whether it was important to be a morning drive personality before moving to afternoons, Fox said "I think you learn some incredible ... invaluable skills that you can take with you, and if you don't learn them, then you never make it to afternoon drive or you lose your job in morning drive."

Banks and Burbank addressed the factors that have contributed to their successes in radio. Banks said he tries to come across as accessible, "because if you are not a real person, then you are a disk jockey, and disk jockeys are a dime a dozen. Personalities are rare."

Burbank noted that "The tendency of your listener is to reach for the button. Supposedly, they are going for the song they want. But if you have a real personality, somebody in afternoon drive that they don't want to miss ... you might hold them for an extra couple of songs, and even another quarter hour. That's where the personality in afternoon drive comes in."

Handle with care

How do you handle personalities? The secret (shhh ... don't tell anyone!) seems to be to leave them alone to do their thing, although Burbank said that with "any personality, you have to have some reins ... it's like a good racehorse, a good thoroughbred."

"You don't want to keep pulling on those reins, 'cause he's got to keep coming back up again. You've got to let him go and just guide him in the right direction. Like a thoroughbred, this personality is going to be sensitive, and it's going to be tough to deal with him sometimes, but in the end by letting him go and dealing with him from a sensitive viewpoint, he'll win the race for you. You just gotta know when to use the crop."

Dues

Asked whether it is a prerequisite in radio to have a lot of jobs, Banks said it was. Nobody knows what it is like to pay dues these days, he noted.

"I used to do a bit in the morning," he remembered, "where I'd have people call up and all they would have to do is give me an area code, and I could tell them what city they were in, because nine times out of 10, I had worked in that town."

Fox said she has been offered jobs all around the country, but noted that she's "kind of a rootsy chick. I don't like to be a radio vagabond. I don't want to move around the country before I get to where I want to go."

Advice

Banks said that people coming up in personality radio should pay their dues — do whatever it takes.

Fox said she never thought she was paying dues when she was paying dues, because she was having so much fun. Knowing the English language helps, she said; being well-read is "unbelievably important ... just getting as much information stuffed in that head as possible, whether you call on it or not."

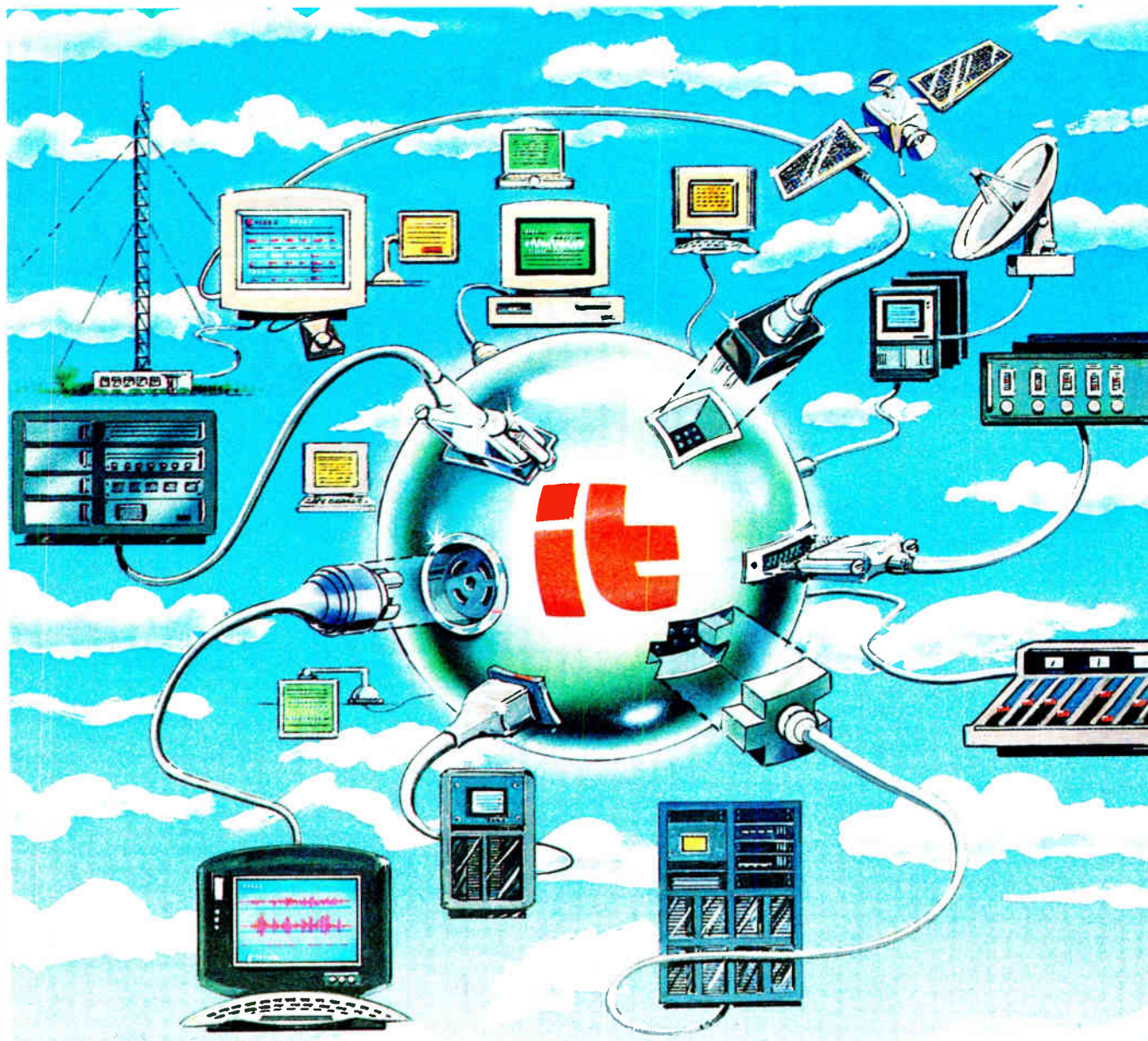

UNIVERSAL CONNECTIVITY in audio management systems

- **Custom Systems** — Designed, configured for *YOUR* operation.
- **Intelligent Interfaces** — Traffic, Music, Accounting, Production, Scheduling, Editors, etc.
- **Choices** — *ITC's Partners Program* brings you the best in quality supporting products.
- **Your total audio management system supplier** — consulting, engineering, manufacturing, installation and service.
- **Call ITC today** — Discover the benefits of a system tailored to *YOUR* needs.

(309) 828 - 1381

International Tapetronics Corporation

2425 S. Main Street, Bloomington, IL 61702

Circle (10) On Reader Service Card



World Radio History

You asked us to build our high

Whether you're a small station looking for peace of mind, or a huge broadcasting operation looking for an economical and efficient way to run four or more stations, we have your system. With Audio Wizard™ XPS for Windows, you get the quality of our world class Audio Wizard CFS for Windows at a price you'll love. Start out with one control room, and we'll expand with you. From one workstation to fifty—we can handle it. You can't buy a better system at any price. Now they can't even claim they cost less. Why buy any other system, when you can buy the best system on earth!

quality system to compete with

- ◆ Pentiums on every workstation!
- ◆ New, high quality computers with three year factory warranty!
- ◆ Live, satellite, and automated modes!
- ◆ Backtime system, fills out each hour!



those low end systems.

- ◆ Automatically record and play network feeds!
- ◆ The leading hard drive music automation system in the industry!
- ◆ Unsurpassed flexibility, runs any program or music log!
- ◆ On-line copy system, integrate your stations!

So we did! The new Audio

- ◆ Exclusive time and temperature announce!
- ◆ Novell, the number one network!
- ◆ Replaces carts, reels, CD players!
- ◆ Uses Windows for the ultimate in multi-user, multi-tasking, realtime operating systems!

Wizard™ XPS for Windows.

- ◆ Dolby stereo-standard!
- ◆ Button bar with quick record capabilities!
- ◆ Uses non-proprietary equipment!
- ◆ Global and/or individual song and spot crossfades!

Fear no competition!

Find out why Audio Wizard™ for Windows is the fastest growing digital audio automation system in the world. Call for information or a free demonstration. **Let us help you slay your dragon.**

Prophet Systems, Inc.
1-800-658-4403

Southwest: 800-914-9273
South: 214-771-1008
Northwest: 503-773-5731
In Australia, New Zealand, and Pacific Rim, contact
Broadcast Solutions Pty Ltd. at (02) 439-6662.



Prophet Systems Inc. announces

**Yes, you can
afford to own
the best system
on earth.**

Now you don't have to settle for that cheap system, because you think you can't afford an Audio Wizard™. Our superb quality Pentium based digital systems are now available in all price ranges!!

WE NOW OFFER A FULL
LINE OF PEER TO PEER
AND CENTRAL FILE
SERVER SYSTEMS.

**SINGLE STATION SYSTEMS START AT
\$7950 !**

(Includes modem, remote control software, networking, cut and paste editing, Dolby audio. Standard features the other systems call "options.")



Audio Wizard™ for Windows™

The *Flexible* Digital Automation System featuring Windows and Novell Technology

Windows is a Registered Trademark of Microsoft Corporation. Novell is a Registered Trademark of Novell, Inc. Intel is a Registered Trademark of Intel Corporation.

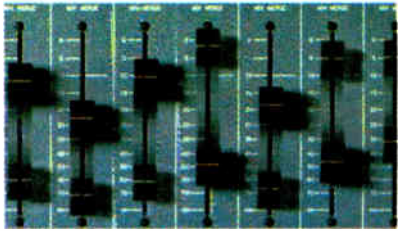

YOU'VE GOT TO HAVE THE RIGHT TOOLS



THE ADX

ENSEMBLE.

REAL MOVING

FADERS.

REAL

PUSHBUTTONS.

REAL

INTUITIVE

SOFTWARE.

THE DIGITAL

WORKSTATION

FOR

REAL

SERIOUS

PRODUCTION.

YOU DID IT.

YOUR STATION MANAGED TO HIRE THE **HOTTEST** PRODUCTION GUY IN THE MARKET FROM YOUR CROSS-TOWN COMPETITOR. HE'S GOT THE CHOPS. HE'S GOT THE PIPES. YOU CAN'T WAIT 'TIL YOUR CLIENTS HEAR THE HOT NEW IMAGE LINERS AND SPOTS HE'S GONNA CUT.

OF COURSE, YOU HAD TO PROMISE HIM **ANYTHING** HE WANTED IN HIS NEW STUDIO. IT TURNS OUT THAT WHAT HE WANTS IS A REAL WORKSTATION BECAUSE HE OUTGREW THE TOYS AT HIS LAST GIG. HE NEEDS ONE THAT MAKES HIS COMPLEX PRODUCTION WORK EFFORTLESS. YOU COULDN'T AGREE MORE. AFTER ALL, THE **HOTTEST** TALENT SHOULD HAVE THE **HOTTEST** TOOLS, **RIGHT?**

YOU BOTH DECIDE ON AN ADX. THE ADX WORKSTATION WAS SPECIFICALLY DESIGNED FOR POWERHOUSE ARTISTS WHO CAN'T AFFORD TO WASTE VALUABLE PRODUCTION TIME WITH CREATIVITY-LIMITING TOOLS.

GIVE US A CALL AND WE'LL SHOW YOU HOW THE ADX WORKSTATION MAKES ANYTHING ELSE SEEM LIKE A TOY.



DESIGNS THAT MAKE THE DIFFERENCE

PACIFIC RECORDERS & ENGINEERING
2070 LAS PALMAS DRIVE
CARLSBAD, CA 92009 USA
619-438-3911
FAX: 619-438-9277
E-MAIL: SALES@PRE.COM
GSA CONTRACT: GS-03F-4064B

New Digital World

► continued from page 45

error rate). And remember that ISDN will introduce delay up to 3/4 seconds, so you will need a mix-minus feed back to the talent.

With the advent of duopolies and L.M.A.'s, more stations find the need to transmit a number of program quality mono and stereo signals as well as internal phone calls from one location to another. Leasing the telephone companies' T1 circuits can be an expensive dedicated solution. Enter "18 GHz Wideband Digital Microwave, a Path to Radio's Future."

Kevin McNamara, chief engineer of Washington's WWRC(AM)-WGAY-FM described the use of this technology which can convey multiple T1 circuits, including entire PBX dial phone systems from one site to another for distances up to 15 or 20 miles, depending on terrain.

"Bi-directional forty channel capacity achieves better quality than standard 950 MHz for STL/TSL use because the audio is noncompressed," according to McNamara. This service does require an unobstructed path and the hardware is a more expensive. Antennas need to be high gain, highly directional solid parabolic reflectors fed by waveguide, not hard coax. Several companies offer the necessary hardware to implement these systems, including Intraplex and Laurus Microwave.

Latest on DAB

With complete bi-directionality, additional services and flexibility can be realized with an 18 GHz STL. Satellite dishes can be installed at the transmitter and channeled back to the studio. Computer data, PBX phone lines, and voice mail systems can all be distributed via this system. A typical complete 950 STL system may cost \$20,000 to install, while the 18 GHz digital may cost more than \$70,000.

However the cost per channel via bi-directional digital will be more efficient.

Tom Keller, a well known industry consultant, reported on the latest DAB systems lab test results which had recently been released to the public. The EIA/CEG and NAB's NRSC conducted these tests over almost two years under very rigid protocols and tight security at NASA's Lewis Research Center in Cleveland. Over 1200 pages of data were compiled with the initial results presented at a two day conference in Monterey, Calif., in late August.

All nine of the current competing systems were tested, including USA Digital FM1 and FM2, USADR AM, AT&T/Amati (two modes of in-band, on-channel IBOC), AT&T in-band-adjacent-channel IBAC, Eureka 147 (two modes), and the VOA/JPL direct satellite system.

Keller outlined the strict protocol adhered to for all systems testing, including daily equipment calibration. Each system was evaluated for signal failure characterization, including noise, co-channel interference, multipath, and the combined analog and DAB signal. The Rayleigh Fading Model was also employed to evaluate impairment compatibility for DAB to DAB, DAB to analog, and analog to DAB using four conditions: rural, urban, slow, and fast.

Twenty-one listeners performed a subjective evaluation of the audio quality of each system. Curiously no women were part of this test. Eureka-147 (at 224 kbps) scored the best here, slightly ahead of USADR FM1. Eureka at 192 kbps scored much lower, with the USADR AM system scoring last.

Performance tests

Other performance tests conducted included resistance to Gaussian noise, multipath (both Rayleigh and Doppler), airplane flutter, and impulse noise. Acquisition time was also tested and rat-

ed, with Eureka-147 being the shortest and USADR the longest.

The trade press has reported some controversy over the application of the Rayleigh model in the multipath tests which may have caused the USADR FM systems to score poorly, according to USADR officials. Keller was careful to avoid any comments or interpretation of the results regarding that issue.

Interference performance evaluations were performed on all FM systems using five representative types of consumer receivers, including Ford and Delco car radios, a Panasonic boom box, a Denon table top radio, and a Pioneer hi-fi receiver. For co-channel interference, all receivers performed essentially the same. Large variations occurred with the first and second adjacent channel tests, with first adjacent being the worst case. For signal to noise tests, both car radios performed far better than any of the other receivers.

Realworld EIA/NRSC Digital Audio Broadcasting testing over actual stations in the terrain-demanding San Francisco market are about to begin. Bob Culver of Lohnes & Culver, reported on the most recently updated plan for implementing the field testing at Shamrock Broadcasting's KBGG-FM and KNEW-AM. These are the stations "where the bits hit the road."

Experimental authority

The group also holds FCC temporary experimental authority to test Eureka 147 on L-band and S-band as well as the AT&T systems on FM. AT&T's IBAC and IBRC systems will be placed on a second adjacent channel to two existing class B high power stations. All IBOC systems will use a high power RF combiner to accommodate the DAB and analog transmitter outputs. The USADR AM system will be tested on KNEW-AM for both ND and DA-N modes after all other systems are evaluated.

Culver stated the objectives of the testing as simply "to find out if any of the systems are clearly better than the existing AM and FM services." All measurements will be done in a moving van which will traverse six long path "loop routes" which are located in different areas around the San Francisco metro where existing FMs are known to have significant reception problems. Short paths of 50 meters long, a short path inside a building, and a "point" path around a parking lot will also be tested.

RF signal levels will be measured and stored to computer in real time with distances measured and marked by a "fifth wheel" synchronized pulse. Other special "flags" will also be recorded. The RF spectrum throughout each test run as well as features and landmarks along the routes will be recorded on video tape.

The audio will be recorded to DAT and will be continuously monitored by the crew, headed up by Hammet and Edison's Stan Salek. Ancillary data performance will also be measured and recorded.

The tests were to have started on Aug. 15, but the schedule has slipped considerably due to delays in acquiring and properly equipping the van. Culver now hopes to get started by the end of the year. Once the process begins, data collection should take from six to eight weeks, with a report on the results available four weeks thereafter.

Audio Tools on Display

by Alan R. Peterson

NEW ORLEANS Studio processing was decidedly digital at the World Media Expo, but there still was room to accommodate some analog favorites.

Fidelipac Broadcast Tape Products was present with the Dynamax CTR100 series of cartridge recorders and players as well as accessories. The CTR100 features Cartscan, which optically senses barcode information on the side of the cart, automatically switching between mono, stereo and matrix playback. The Dynamax line also includes the ESD10 eraser/splice detector, the DCR1000 digital cart machine that records on 3.5 inch floppy disks and an array of tape maintenance devices and studio furnishings.

Audio Technologies Inc. (ATI) exhibited its line of analog DAs, stereo turntable amplifiers, IHF to Pro interface amps and the Emph-a-Sizer mic processor.

Speaking of amplifiers, **Aphex Systems** new Model 107 Tube Mic Preamp was on display, which uses a 12AT7 dual triode tube for preamplification. The line of Aural Exciters, Compellers and Dominators were all included in the Aphex display.

Studer Professional Audio blended analog and digital technology to create the D19 combination mic/line preamp and D/A converter. The D19 is a self-contained preamplifier with eight line and eight mic inputs and 20-bit converter for excellent audio quality. Four standard AES/EBU outputs on XLR connectors plus Alesis ADAT-compatible outputs are included.

Creative processing from **Eventide** was shown, in the form of the DSP4000 Ultra-Harmonizer effects processor, with up to 4 MB of static RAM and an optional internal sampler card. The Eventide BD500 stereo delay was also shown; a new generation of obscenity delay for talk radio. Total delay time is 8.5 seconds and is divisible into segments so only a portion of the total delay time can be dumped.

Equipment from **Solid Electronics Labs** aids in processing the FM signal, with the DCP-1 Dynamic Composite Processor. Frequency response is 10 Hz — 55 KHz and the unit performs instantaneous limiting and composite low pass filtering. The filter structure is configured in four separate sections, each with its own overshoot compensation circuit.

The **Cutting Edge** Unity 2000i audio processors for AM and FM now have an AES/EBU factory upgrade option, allowing connection to digital equipment. The Unity digital interface accepts sample rates of 32, 44.1 and 48 kHz, and sends 32 or 48 kHz. Analog and digital ports are simultaneously active at all times.

RBDS

**EASILY
INSTANTLY
INEXPENSIVELY**

... with these two, brand-new products, **INOVONICS** has you covered, *coming and going!*

710 ENCODER: Just \$995 and **no computer required!** The non-volatile memory holds 16 separate frames of program and format identifiers, alternate frequencies, radiotext messages and traffic or emergency flags. A built-in data interface lets you upgrade later to full dynamic operation for revenue-generating paging, GPS, coupons, contests, etc.

510 DECODER: Connects to your existing FM Mod-Monitor. The front-panel LCD display shows RBDS injection level and allows you to scroll through and read all the data groups. An RS-232 port gives unlimited access to raw RBDS data for telemetry and other in-house functions.

Inovonics, Inc.

1305 FAIR AVE., SANTA CRUZ, CA 95060 U.S.A.
TEL: (408) 458-0552 — FAX: (408) 458-0554



Circle (65) On Reader Service Card

EAS Provides Significant Edge over EBS

by Thomas R. McGinley

NEW ORLEANS Just over two months ago, all U.S. radio and TV stations converted their EBS equipment to handle a shortened eight second two-tone alert signal. That was only the beginning of a wholesale overhaul of the EBS system.

On Dec. 9, 1994, the FCC released a Report and Order replacing EBS with the new EAS, Emergency Alert System. The next deadline to install new digital EAS equipment and start complying with the revised procedures and use of new digitally transmitted event codes is July 1, 1996, less than 10 months away.

Try to enlighten

SBE convened a special EAS panel during its engineering conference to enlighten station managers and engineers with the new world of the Emergency Alert System. Beverly Baker and Frank Lucia of the Federal Communications Commission (FCC) lead things off with an introductory overview of how EAS evolved and what the new requirements of the proposed rules will be.

The new system incorporates the use of addressable coded warning information including regular tests, sent as digital data packets in very short data bursts. This allows weekly tests to be unobtrusive to programming.

Coded events and warnings take the form of three-letter abbreviations. The old two-tone alert signal will be retained for monthly tests and for actual emergency alerts because so many existing NOAA and other receivers still in use respond to this tone.

New EAS monitors will continuously monitor at least two independent sources, including another broadcast station, and a local, county, or state emergency operations center (primary source). A state EAS Plan will determine which two sources each broadcast station will be required to monitor. Alerts come via a web architecture rather than the old series string method used in EBS, making it dramatically more reliable.

Vote still pending

Issues of Reconsideration are still pending before the FCC which will have to be addressed and voted on by the full commission before equipment manufacturers can start making the new EAS monitoring and signaling equipment and then sell it to stations in time to meet the July 1996 deadline.

Because of delays during this recon process, many industry observers feel an extension of the deadline should be granted. Baker has hinted that she is recommending such an extension to the commission. The final vote and acceptance was expected in late September.

Stanley Johnson of the National Weather Service addressed the session to discuss his organization's interface with EAS regarding the dissemination of weather information and alerts. The NWS will be an important additional source to be monitored by broadcasters under the proposed EAS scheme.

Presently NOAA stations in about 80 markets use a digital alerting system with a 1050 Hz alert tone for regional emergencies known as SAME (Specific Area Message Encoder). The SAME system is an "all hazards warning network" formed

under the tri-partnership of FEMA, the FCC, and the NWS and will be incorporated into EAS to simplify and standardize the alerting protocol nationwide.

Patent pending

Unfortunately there is a patent infringement suit involving individuals claiming to have invented the SAME system which has slowed the reconsideration and adoption process. Johnson reports that the NWS is confident it can demonstrate "prior art" use of SAME and expects to win the suit.

Decoders for this system will be available in consumer receivers from several major manufacturers for \$50 to \$100 by year end.

Gary Timm of WTMJ Radio in Milwaukee, and a member of the SBE

The new system allows weekly tests to be unobtrusive to programming.

National EAS Committee discussed the impact of the new EAS on state and local emergency coordination groups. Under the new FCC EAS rules, the state committees are still responsible for drawing up and implementing the state plans, which are crucial to successful operation of EAS.

Timm drew from the Wisconsin experience in setting up good coordination and communications with all local and state emergency operations centers and broadcast stations.

Because most emergencies are weather-related and affect primarily a local area, the success of EAS will depend heavily on the building and effective operation of the local EAS WEB. Those broadcasters participating in this effort may benefit from the following suggestions in getting started:

- ✓ Determine the boundaries of your local area.
- ✓ Determine Broadcasters and Cable Operators in your area.
- ✓ Identify Government Sources of Emergency Declarations.
- ✓ Identify a path from each source to the Broadcasters.
- ✓ Identify existing Broadcasters background channels (EBS RPU channel, Broadcasters 2-way and paging channels, FM SCA, TV SAP.)
- ✓ Identify other background channels in your local area.
- ✓ Determine which EAS Event Codes are relevant to your local area. (Localize the list for the most likely wx events or emergencies.)
- ✓ Determine Broadcasters additional monitoring assignments.
- ✓ Write the Plan. (All key stations & agencies involved to help.)
- ✓ Sign It.
- ✓ Build It!

Questions remain

Most engineers are wondering what the new EAS hardware will need to do and what it will likely cost. Harold Hallikainen, a longtime EBS and Remote Control mentor and industry expert was on the panel to describe the logistics of how the EAS equipment will function.

He described the new digital coding and packet scheme, along with how the new EAS data bursts and the testing and moni-

toring requirements will work with the new EAS gear every station will have to acquire. Although the equipment specifications have not yet been finalized, the proposed protocol is expected to be accepted and adopted by the commission very shortly.

Every station will need a new EAS decoder/ encoder, capable of monitoring at least two and preferably more input sources. For groups of stations in one location, a common unit can be used as long as each control position can monitor all sources and activate tests. A separate receiver should probably be used for separate AM and FM studios.

Data bursts

The required weekly EAS test originated by stations will only consume 10.5 seconds and consists of only the data burst containing EAS header codes and EOM code. The required monthly test will be originated from local or state primary sources and will consist of the EAS header, attention signal (new), test script, and EOM code.

All monitoring stations will then be required to retransmit the random monthly test within 15 minutes, which is something very new broadcasters will have to get used to.

Harold also discussed the impact of the

proposed Unattended Operation Rules. With the improving reliability of transmitting hardware and on-going FCC deregulation, the time has come when computers can do the meter reading and logging and merely alert humans via the telephone when things stray out of tolerance. If humans don't respond in a timely fashion, the station is simply shut down. While the NPRM and reply comments phase has closed in this proceeding, Harold suggests the issue appears to be stuck within the FCC and deserves another round of comments.

William Ramsey, director of engineering for the Nebraska Educational Telecommunications Commission (NET) wrapped up this session describing a novel solution for unattended remote control of a large state-wide broadcast system. NET is a nine station public radio and TV operation with 18 transmitter sites spread out across the state.

Bill described how the transmitter remote control, monitoring, and maintenance chores were reduced from 13 to eight people, using Moseley MRC-2 remote control systems at each site, linked back to the Lincoln operations center via Hughes Network V-SAT Ku-band satellite facilities and Sprint 56 kilobit data circuits. Nine downlink locations are equipped with 1.8 meter PES (personal earth stations) at only \$10K per installation.

AA-51A AUDIO ANALYZER NEW \$3770; UPGRADE \$1560

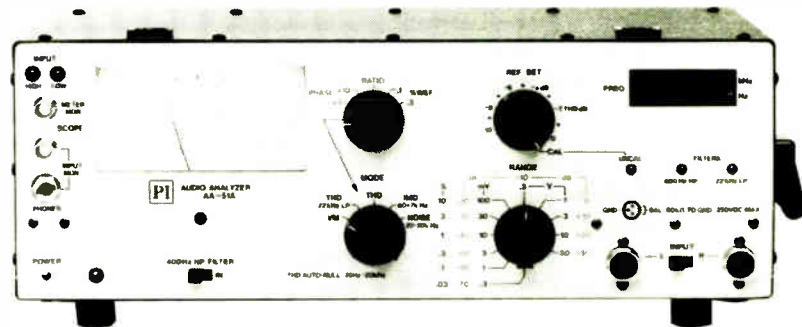

MEASURES:

- ✓ HARMONIC DISTORTION
- ✓ VOLTS
- ✓ dB; dBm (600 ohms)
- ✓ FREQUENCY
- ✓ WOW & FLUTTER
- ✓ STEREO PHASING
- ✓ SIGNAL + NOISE NOISE
- ✓ INTERMODULATION DISTORTION
- ✓ DIFFERENTIAL GAIN OF STEREO CHANNELS

FEATURES:

- ✓ AUTO-NULL THD+N
- ✓ SHIELDED & BALANCED STEREO INPUTS
- ✓ COMPATIBLE WITH NAB TEST DISKS
- ✓ FREQUENCY READOUT
- ✓ SWITCHABLE HIGH-PASS AND LOW-PASS FILTERS
- ✓ VERNIER SET-LEVEL CONTROL
- ✓ HEADPHONE INPUT MONITOR PORT

PLEASE CONTACT US FOR COMPLETE DETAILS



Potomac Instruments, inc.

932 Philadelphia Ave., Silver Spring, MD 20910
Phone 1-301-589-2662 • Fax 1-301-589-2665

Products & Services Showcase

For more information on the products shown below, circle the appropriate Reader Service No.(s) on the enclosed Subscription/Reader Service card or contact the advertiser directly.



REMEMBER THE *CORTANA* FOLDED *UNIPOLE* ANTENNA? WE STILL MAKE IT WITH THE SAME HIGH QUALITY MATERIALS AND WORKMANSHIP. IT FEATURES...

- BROAD BANDWIDTH
- GROUNDED ANTENNA
- ELIMINATES ISOCOUPLEDERS
- BEST ANTENNA FOR DIRECTIONAL ARRAYS.

Also

nott ltd.

1000 N. 1st St.
Lombard, IL 60148
Tel: 630-941-1100

READER SERVICE NO. 204

B-SERIES FM BROADCAST POWER AMPLIFIERS

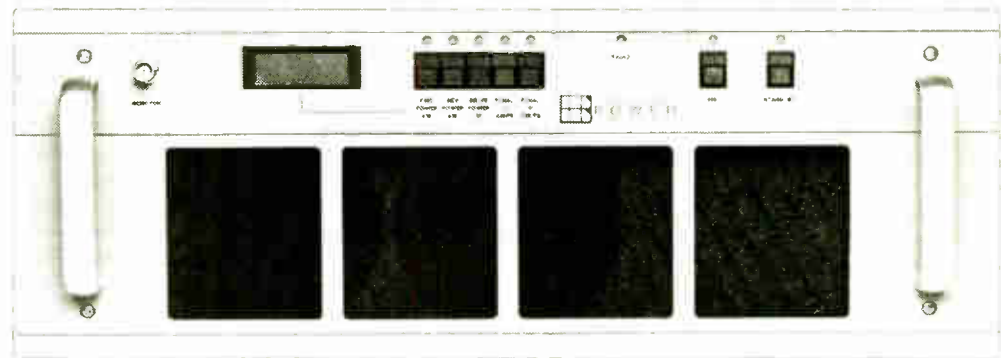

Reliability through design is the key to the B-series power amplifiers

Silicon Valley POWER AMPLIFIERS
The RF People

Silicon Valley Power Amplifiers, a quality supplier of OEM modules is now producing a range of compact power amplifiers. All units are complete with rack slide ready to install in a 19" rack system. Power outputs 150W to 1250W

For prices and delivery CALL 1-800-986-9700

READER SERVICE NO. 89

WIRELESS IFB SYSTEM

Used by hundreds of TV stations for van-to-field cueing in ENG & SNG applications. Transmitter provides mix of program and instructions to rugged, pocket receivers.

- 100% duty cycle
- Wideband audio
- Excellent operating range



COMREX®

Comrex Corp., 65 Nonset Path, Acton, MA 01720
Tel: 1-800-237-1776 Fax: 508 635-0401

READER SERVICE NO. 131

FREE*

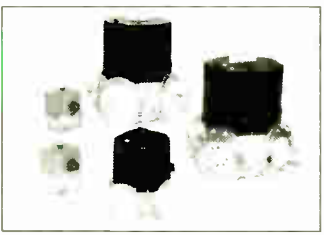

WHY NOT SWITCH TO MCI?

• QUALITY	• PRICE - 7/8"	- \$2.450
• DELIVERY	- 1 5/8"	- \$2.800
• RELIABILITY	- 3 1/8"	- \$3.600
• PERFORMANCE	- 4 1/16"	- \$5.000
• BROADBAND	- 6 1/8"	- \$6.200
• COMPACT SIZE		

Control Panel also available upon request.
*Shipping in Continental USA Regular ground service - Switches only

For More Information Call:
MCI MICRO COMMUNICATIONS, INC.
P.O. Box 4365 • Manchester, NH 03108-4365
Toll Free: 1-800-545-0608 • Fax: 603-624-4822

READER SERVICE NO. 202

ARE YOU LOOKING FOR A COST EFFECTIVE ALTERNATIVE TO MANUFACTURER SERVICE?

SERVICE, REPAIR & CALIBRATION

- STL's • RPU's • TSL's
- Exciters • AM/FM Broadcast Monitors • Remote Control Systems

SPECIALIZING IN EQUIPMENT BY

- Belar • Marti • Moseley • McMartin • TFT • And others...

An authorized TFT service center

IN CASE OF EMERGENCY

We can help get you back on the air with our STL Loaner Program. We have STL's available that will be set to your frequency prior to shipping. We also provide over-the-phone technical assistance.



2198 Hubbard Lane, Grants Pass, OR 97527

(503) 471-2262

READER SERVICE NO. 134

The best way to to pull off a lot of tricks with one small box...

DC metering amp
AC or DC Gain
Stereo 30 DB
Balanced to Unbalanced
Line Amplifier
Mono Gain 60+ DB
Distribution amplifier
Unbalanced to Balanced
Microphone pre-amplifier
AM NRSC de-emphasis filtering
Consumer audio to console level
Telephone line to audio console level



rack mount or surface mount

The Zercom 'Gain Box'

For only \$179.00

Available through all major dealers

P.O. Box 84, Zercom Drive
Merrifield, Minnesota 56465-0084
218/765-3151-Fax 218/765-3900

READER SERVICE NO. 196

ATI Audio DA's. The HEIGHT of performance.



CALL OR WRITE NOW FOR FREE DETAILED BROCHURE.

ATI AUDIO TECHNOLOGIES INCORPORATED

328 W. Maple Ave.
Horsham, PA 19044, USA
(215) 443-0330
FAX: (215) 443-0394
(800) 959-0307

READER SERVICE NO. 4

Sales Rates Mirror Station Worth

by Bob Rusk

NEW ORLEANS "Raising rates is one of those areas that sales managers don't like to talk about," said Wayne Cornils, RAB executive vice president and coordinator for the NAB session, "How to Sell Your Sales Staff on Raising Rates."

"I am firmly convinced that the reason more stations don't raise rates is because the sales staff talks the sales manager out of it."

The RAB's Roann Hale moderated the session. Panelists included the RAB's Mike Mahone; Cos Cappellino, KXYX(FM)/KMKX, San Diego, Calif.; and Bob Freeman, general sales manager, KKCS-AM-FM, Colorado Springs, Colo.

Freeman said that raising rates was the best thing that his station, KKCS, ever did.

"It separated us from everybody else," Freeman said. "It gave an incredible value to the station. We're convinced that advertisers don't like to buy the cheapest package."

"We crossed over the bridge a number of years ago at KKCS and decided that maybe we're not the radio station for every single business out there. Maybe we're the radio station for businesses that are doing well and want to continue to do well, as well as some new businesses that understand value in proportion to the size of the audience," he said.

"All we're trying to do is to give our clients access to the buying power of the audience," Freeman added. Clients that see a return on their investment understand what an investment (in advertising) is all about."

Freeman said he believes that radio stations too often take what they can get, and should instead walk away from advertisers who do not bring enough dollars to the station.

"Very few stations are willing to cross the line and walk away from business," Freeman said. "They are just happy to get a buy — regardless of the rate, regardless if it's really going to be effective for the client. They haven't defined what the client wants to do."

"Sales people must sell proper schedules and do proper diagnostics for their clients," he stressed. "Then when rates are raised, it's easier for them to deal with because they'll understand how to handle the client's objection to a higher rate — especially if the client has seen results before."

Many stations wonder what the best time of year is to raise rates. Many sales managers have a feel for when rates should not be raised.

"First quarter is certainly not the most desirable time to be putting rate increases in," Freeman acknowledged. "Unfortunately, some stations reduce rates to try and stimulate business in the first quarter. I think they might be surprised if they kept their rates steady and saw how good business could be in the first quarter. I think there's a perception in a client's mind that if the rate is being dropped, something must be wrong."

"It's kind of like buying a car," Freeman said. "If you go to buy a car and you see it for sale one day at \$7,000 and the next day it's \$5,000, there's a perception that something must be wrong with the car."

"I think that can sometimes be the situation with radio. We have as many listeners on Jan. 5 as we do on Dec. 22. They don't all go away after the Christmas holiday."

Freeman added, "When managers feel

like they need to lower rates to stimulate first quarter sales, they should actually try to pre-sell the first quarter in October and November. At the same time, they should work at convincing clients that the value of the radio station is going to be the same."

While KKCS has a mix of local, regional and national spots, Freeman stressed that ratings are not a selling point when the station's sales staff calls on local accounts.

"We try not to be numbers-oriented on the local level," he explained. "Sure, good numbers help everybody in radio. But what's unfortunate about numbers is that there are plenty of stations that garner good numbers, but they don't raise rates where they should."

"It's distressing to us when a radio sta-

tion in the market sees a nice increase in ratings over a number of books, but they don't raise their rates proportionately. We've been the rate leader in the market for a number of years. We're trying to be fair to the client, but we're also trying to make money. We're a for-profit business, just like most radio stations."

"We base our rates on supply and demand," Freeman said. "We're in a fortunate situation, because our market is growing. There's an influx of people, and a lot of businesses are coming to town. With that, the demand on the station's inventory (of ad time) has been greater. We're not alone in that; the whole radio market has been up significantly in Colorado Springs."

Freeman is seeing changes in the way sales staffs are conducting business throughout the industry, but he thinks it's only the beginning of the trend to higher rate cards.

"The radio industry is starting to price its product more and more based on supply and demand of the available inventory. A lot of that has to do with programming. There are a lot of news/talk stations, for instance, that are selling their stations based on an individual show, not necessarily on a 5:00 a.m. to 8:00 p.m. total audience," Freeman said.

"I've always embraced rate increases as a great opportunity for me to increase dollars for myself and the radio station."

"The cost per spot isn't the most important thing," Freeman concluded. "A \$100 ad that returns \$200 is much better than a hundred ads that cost a dollar each and return nothing."

The FM Transmitter of Choice

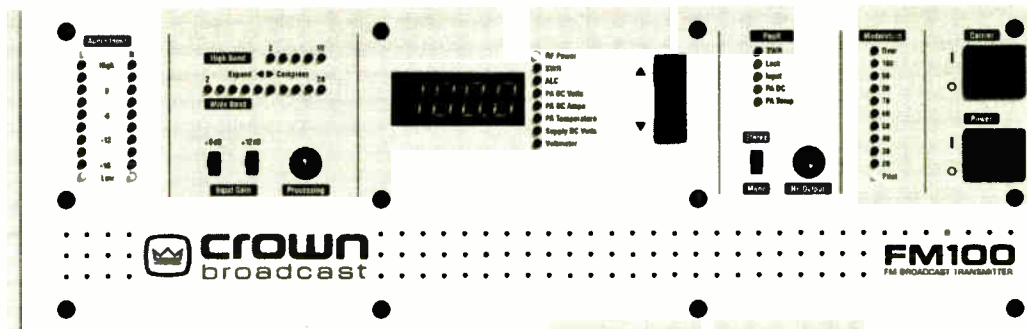

Integrated Transmitter Systems by CROWN®

Applications

- Suited for FM translator service
- Ideal for satellite or terrestrial-fed systems
- Use it as a stand-alone transmitter
- Use it as a stand-alone exciter with composite input
- Use it as an FM exciter with built-in IPA
- Great for community and campus radio
- A perfect backup transmitter system

Models

- FM30, adjustable from 3 to 33 watts output
- FM100, adjustable from 20 to 110 watts output
- FM250, adjustable from 20 to 250 watts output
- FM500, 50 to 500 watts (available third quarter '95)

Integrated System Components

- FM exciter (digitally tunable, frequency-agile)
- Audio processor (with compressor/limiter)
- Stereo Generator
- RF Amplifier
- Lowpass Filter
- New, optional FM Receiver Module
- New, optional FSK IDer

Features

- Excellent signal quality and reliable performance
- Lightweight, compact, easily shipped worldwide
- 110/120 VAC, 220/240 VAC or DC powered
- Built-in digital metering and diagnostics
- User tunable from 88 to 108 MHz
- Optional tuning for 65-73 MHz in 10 kHz steps
- Modular, flexible design
- Fully illustrated and detailed user information
- Type notified for FCC part 73 & 74; meets FCC, DOC, and CCIR requirements
- Quick setup; designed for easy installation even by non-technical people

For more information, contact Crown Broadcast Sales at (219) 294-8050 or fax (219) 294-8302.

Crown
broadcast

A Division of Crown International, Inc.
1718 West Mishawaka Road
Elkhart, Indiana 46515-1000
Phone: (219) 294-8050; FAX: (219) 294-8302

Rack Up Savings!

BSW combines high quality, great sounding consumer machines from Technics with painted steel rack mount hardware to offer you tremendous value for your station!

Technics SLPG450/RK1 CD player



- Auto cue to music
- Peak level search
- Instant track select
- Wireless remote
- RK1 rack kit

\$169.00

Technics RSTR575/RK4 double auto reverse cassette deck



- 3-hour series record, 24-hour series playback
- High speed program search
- Dolby B, C & HX Pro
- Simultaneous parallel recording
- RK4 rack kit

\$269.00

Technics STK550R rack mounted AM/FM tuner



- Excellent audio quality
- 30 presets for AM and FM
- Stores presets when power is off
- Supplied rack mount kit

\$159.95

Call or Fax us with your order today to Rack Up Savings!

Equipment Solutions To Keep You Number One

BSW[®]

BROADCAST SUPPLY WORLDWIDE

7012 27th Street West Tacoma, Washington 98466

Phone: 800 . 426 . 8434

Fax: 800 . 231 . 7055

Circle (168) On Reader Service Card

World Radio History

Can Improve Business

◆ "The audience loves it when stations start screaming at each other. They enjoy station versus station attacks, competition, etc."

"I think there is a kind of thug mentality out there at times that you can sort of exploit," said Douglas, citing Howard Stern's on-air funerals for his competitors as examples.

"There is a thing called fair

competitive commentary," he noted, "which a lot of people put into a contract now with talent." Talent isn't supposed to "engage in, I guess, unfair competitive commentary," he added, "saying bad things about the former station they worked for."

◆ "Concentrate your promotional efforts on Thursdays."

Patchen said that "It is certainly true that Thursday listening levels are somewhat higher than they are for other weekdays. It's probably because the survey starts on Thursday, to some extent, and it may also be because there's a lot of contests and promotions on Thursdays."

If stations are "enticing people to listen more on

Thursday, should we be surprised if more are listening?" he asked.

"From a research standpoint, do I expect the first day of the survey to have higher levels?" That is "pretty consistent with other types of research that go over a long period," he noted.

"If you miss an opportunity because of the small difference in Thursday listening levels to position yourself on a Monday morning or some other day that might offer you certain tradeoffs, the question I would

raise is 'Why not go for that?'"

◆ "What you don't play won't hurt you."

Dunphy said he thought this was defensive programming. "It is saying like 'If I don't do something, I can't get hurt.' Well, what you're really supposed to be doing is entertaining people — giving them something that they are going to want."

He added that "over time, if you don't give it to them, someone else will, and ultimately, it can hurt you."

The music, said Torcasso, "is only a stage for you to entertain with. I don't believe in radio stations that focus on the music. I think that they're in for a lot of trouble in the future." He added that he thinks stations should incorporate "some sort of profile," which he thinks has to come from the personalities.

◆ "Start your promotion or marketing 15 days before the start of the book to gear it up and get it rolling."

The reality for radio stations, said Torcasso, is "if you're entertaining people, it doesn't matter when you start your marketing or promotion campaigns. The goal is really to induce enough interest that Arbitron picks up the listening of your radio station." To do that, he added, "it really is 90 percent what you are doing on the radio station and probably 10 percent marketing."



Work smarter.

Go. Roland®

Call for FREE Video.

Roland Corporation U.S., 7200 Dominion Circle, Los Angeles, CA 90040 (213) 685-5141 Ext. 756
 Roland Canada Music Ltd., 5480 Parkwood Way, Richmond, B.C. V6V 2M4 (604) 270-6626

Circle (104) On Reader Service Card

MOVING?

Don't leave us behind!

Mail or fax your current label and new address (with effective date) to: Circulation, RW, PO Box 1214 Falls Church, VA 22041

or

FAX 703-998-2966.

Address changes will be processed within four weeks of receipt.

Thanks!



Debunking Some of Radio's Oldest Myths

by Alan Haber

NEW ORLEANS What do sacred cows have to do with radio? And what makes a cow sacred?

There is no good answer to the second question, but as to the first ... the airwaves cannot help but be populated by a potpourri of sacred cows, or myths, after being around 75 years.

It seems that every sacred cow has its backers as well as its detractors. Sometimes, for example, just when you think you have successfully debunked a particular sacred cow, such as "Stations should start and finish every break with their call letters," along comes someone to tell you it works for him or her.

A selection of radio's sacred cows were put in the spotlight at the 1995 NAB Radio Show by Larry Rosin, President of Edison Media Research. Rosin presided over the thought-provoking, food-for-thought session, "Exploring and Exploding Radio's Myths."

Panelists, well-versed in a variety of radio myths and sacred cows, were Dwight Douglas, chief operating officer, Burkhardt/Douglas Associates; Bob Dunphy, president, Dunphy Strategic Media; Bob Patchen, manager of methods research, Arbitron; and Rick Torcasso, senior vice president of operations, Alliance Broadcasting.

Among the myths and sacred cows presented, and either defended or debunked, were:

◆ "Always start the hour with a power."

Dunphy said that stations should put their best feet forward. "Why wouldn't you start your music sweeps with a solid song?" he asked.

Torcasso retorted by saying, "To think that all of your listeners are tuning in at the top of the hour is ridiculous. I think that the way that radio is, you just never know when somebody is tuning in ... Whether you are starting with a power at the top of the hour — hell, that doesn't matter. Probably what matters more is that your music be strong."

Interestingly, Patchen noted that a 1980s Arbitron study found that 75 percent of diary entries started at some point other than the top of the hour.

◆ "My station got killed because there was a low in-tab in my target demo."

"It is certainly one of the most common myths," said Patchen. "The simplest reason why it is not true is that if you think about how diaries get averaged in terms of the number of

quarter hours reported, it doesn't really matter whether you have 50 or 100 or 200 or 1000 listeners who mention your station."

The question, he noted, is "what is the average number of quarter hours once you've divided the total by that sample size. If you look at the relationship between the in-tab for your target demo and station

performance, there is literally no relationship between those two."

What you will find, he said, "is that a larger sample size will give you more reliable, more stable estimates over time, but there is no directional effect at all."

"It is not as though you pile up quarter hours as each new diary from one of your listeners

comes in. It's true that you pile them up, but then you have to divide by the total, so you can just as easily get a five share from 20 diaries as you could from 100 diaries."

◆ "Start and finish every break with your call letters."

Torcasso said it drives him crazy when he hears radio stations do this.

"Our job, especially in terms of our personalities and talent," he said, "is to induce interest and be compelling. To me, the most important thing for you to do is to do that the moment the talent goes on the air. I don't think saying the call letters first does that."

If a radio station is compelling, he added, "(listeners) are going to know who you are."

\$6295*
Powerful.
 100 layers per track.
 Bar/Beat Editing.
 Time compression.
 Pitch Correction.
 Full Automation.
 Interface for
 DA-88/ADAT/RS-422.
 Trigger Mode.
Portability.
 No computer needed.
 SMPTE/MMC/MTC/SPP Sync.
 Video Output.
 Scrub Preview.
 Backup to SCSI/Audio DAT.
 Non Destructive Editing.
 Punch In/Out.
Reliability.
 Portable/Stand Alone.
 "No Crash" performance.
Fast.
 Easy to learn.
 Confidence.

**DM-800
Digital Audio
Workstation!**

*MSRP 4-1-95. Price subject to change.

WorldRadioHistory.com

Digital Impacts Radio

► continued from page 43

due to impedance mismatches, and acoustic echoes which occur when incoming audio appears on monitor speakers and is picked up by room mics and retransmitted to the originating source.

Jones presented the theory and practical applications of the digitally controlled solution perfected by Gentner in its work with hybrids and teleconferencing products.

Unwanted contamination

A sample of the internal or acoustic echo signal is built by the DSP, and is then inverted and added back in out of phase to cancel the unwanted contamination. Acoustic echo cancellors must be able to deal with echo time spans longer than the reverberation time within a room.

Jones also described various physical acoustic treatments and electronic remedies available to cut down on echo degradation. Appropriate application of sound proofing materials, as well as the use of automatic or gated mic mixers, directional mics, and active equalizers which cancel specific resonant frequencies can provide significant improvement.

Maintaining quality control with new digital equipment requires a whole new breed of test and measuring equipment. Jeff Noah, of Tektronix Corporation, a longtime manufacturer of state-of-the-art test equipment, presented an overview of the tasks and challenges this new hardware must handle. Most digital equipment is new, and except for that which includes moving parts and spinning motors, most of it hasn't failed yet. It either works or it doesn't.

Content level monitoring is more critical in the digital domain because clipping distortion is much more immediate and destructive.

Full-scale digital samples may not indicate real clipping because actual audio peaks do occur between samples, especially at lower sampling rates.

Interpolation and oversampling must therefore be used in any digital level monitor. Phase monitoring of digital audio signals must compare the two stereo channel's time base as in analog. However phase information is harder to monitor in the expanded dynamic range of digital, so a DSP-based correlation meter must be used.

New set of problems

Interfacing the digital signal presents a new set of problems for digital test gear. Channel status data bits may be different within an AES/EBU frame causing incompatibility. Reprogramming may be needed before meaningful analysis can occur. The signal may have to be converted to analog first and then reconverted. Analyzing transport problems of digital signals requires looking at timing, coding, CRC errors, and validity bit settings.

Cable lengths which are too long are a common problem which cause excessive jitter. Any cable run of less than 100 meters should be able to transport digital audio without errors. The digital analyzer looks at the "eye pattern" which reveals the integrity of 0 to 1 and 1 to 0 transitions. Anything which closes the eye pattern is bad and will cause errors.

The Tektronix model 764 digital audio analyzer is a modern digital test instrument which can provide unattended QC

of a digital signal with automated logging and time stamps while compiling all session statistics.

National Public Radio has been carefully researching how digital technology will enhance and streamline the audio recording, editing, and storage functions in its operations many of which are still performed by analog equipment.

Mike Starling, NPR's Director of Technical Operations, offered a valuable update on how NPR is getting along in its new Washington facilities and what NPR has discovered about the various digital systems studied.

Starling identified four breakthrough technologies converging in radio which

are enabling digital to be the industry workhorse of the future: imaging, data storage, networking, and artificial intelligence. For the moment, NPR may be the "last great analog facility," producing its renowned and impeccable audio quality, not so much via digital technology but by sticking to the basics of good production and maintenance practices executed by highly trained technicians.

AES/EBU signal router

NPR is using an AES/EBU signal router and some digital audio production workstations, along with DATS recorders. Starling noted that since moving into its impressive new headquarters last year that "digital equipment comprises only 8.5 percent of installed hardware, but is responsible for over 65 percent of all on-air equipment failures."

Feeding your automated workstation unconditioned power is like driving without a seatbelt.

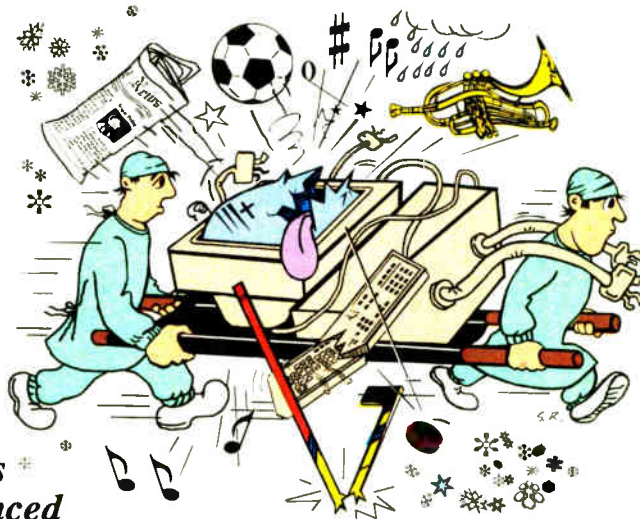

If you crash, it's all over.

Superior Electric's family of advanced STABILINE® Voltage Conditioning Products offers a full range of power protection options to prevent such a disaster.

Did you know that the seemingly harmless fluctuations in electricity that cause momentary flickers in your studio lights can literally fry the internal mechanisms of digital and analog broadcast equipment? It's true.

The AC power line feeding your entire station is filled with voltage irregularities: surges, sags, spikes and noise, among others. And if this "dirty" power reaches the sensitive circuitry that controls your commercial and music inventory or traffic computer, for example, the results can be devastating. Lost or corrupted data, satellite delivery interruptions, mechanical failure – whatever the outcome, it's always bad news. Which means it's bad for business.

That's why you need STABILINE® Power Protection Products. Whether you're looking for voltage regulation, power conditioning, battery backup power or a combination thereof, we've got you covered.

Why take unnecessary risks? Invest in STABILINE® power protection. **We're your best insurance against a crash!**



Transient Voltage Suppressors/RFI Filters
Wall mount, desktop, 19-inch rack mount, NEMA 12, industrial hard-wired. Ratings to 20 amperes.

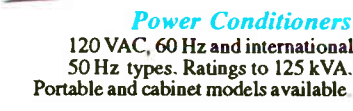

Power Conditioners
120 VAC, 60 Hz and international 50 Hz types. Ratings to 125 kVA. Portable and cabinet models available.



Voltage Regulators
Power ratings from 2 to 1680 kVA. Cabinet or 19-inch rack mount models.



Uninterruptible Power Supplies
Domestic 110, 120 or 127 VAC, 60 Hz or international 220, 230 or 240 VAC, 50/60 Hz types to 2200 VA. Wide range of desktop, cabinet and rack mount types.



3-phase, 500 kVA WHR Series model.

To learn how STABILINE® Power Protection Products can solve your power problems, write, fax or telephone Ted Gladis. Ask for individual product catalogs or complete STABILINE® literature file.



SUPERIOR ELECTRIC
WARNER ELECTRIC

383 Middle Street
Bristol, CT 06010 USA
Tel: 860-585-4500
Fax: 860-582-3784

1-800-787-3532 in USA & Canada

Products & Services Showcase

For more information on the products shown below, circle the appropriate Reader Service No.(s) on the enclosed Subscription/Reader Service card or contact the advertiser directly.

TWO NEW ADDITIONS TO THE COAXIAL DYNAMICS WATTCHMAN® TRANSMITTER PROTECTION SYSTEMS

Models 81081 and 81082 with 15/30/60 kw Meter Scales

NEW!
4-1/16 and 6-1/8 series line sections and elements to add to our exciting line-up



WATTCHMAN—protects your transmitter and transmission line system. A permanent 19 inch rack installation used with any dual socket line section 7/8", 1-5/8", 3-1/8" and elements (additional) to monitor CW, TV, and FM power. Model 81070 features two easily read meters to monitor both forward and reflected power. The reflected meter provides a front panel adjustable set point which controls the trip level for fast transmitter shut down and alarm. Abnormal load conditions quickly cause transmitter shut down in less than 15 milliseconds including control relay. Both visual and audible alarms indicate system malfunction. Contacts provided for remote alarm and reset switching. Contact us for your nearest authorized Coaxial Dynamics Representative or Distributor in our World Wide Sales Network.



COAXIAL DYNAMICS, INC.

15210 Industrial Parkway • Cleveland, Ohio 44135
(216) 267-2233 or 1-800-COAXIAL • Fax: (216) 267-3142
Service and Dependability... A Part of Every Product

READER SERVICE NO. 39

Excalibur Electronics HC-1 Handi-Coupler

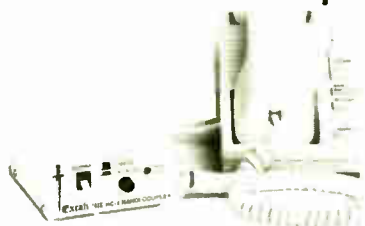

Here is the simplest, quickest, most convenient way to connect audio to a telephone. The HC-1 connects in series with the handset of any phone using modular connectors. No connection to the phone line is needed. Press the front panel button and external audio is available on separate send and receive 1/4" TRS jacks on the rear panel. Release the button and the handset is once more connected for normal use of the phone. Nothing could be simpler!

You can find many uses for the HC-1 around your station: on-air studio, production room, newsroom, sales office, field news kits, sports remotes, etc.

EXCALIBUR ELECTRONICS, INC., CHANTILLY, VIRGINIA

Please circle our bingo number for a data sheet and a dealer list

READER SERVICE NO. 23

PROGRAM • ABILITY

Programmable Digital Remote Control. What others promise, Hallikainen & Friends delivers to your exact specs with the DRC 190. With its extended BASIC language, the DRC 190 can control, alarm, display and log measured and calculated system parameters. Typical installations also generate a daily report showing the minimum, maximum and average of each parameter, simplifying oversight of the system. For true flexibility of user control over evolving equipment demands, get with the program, get the DRC 190.

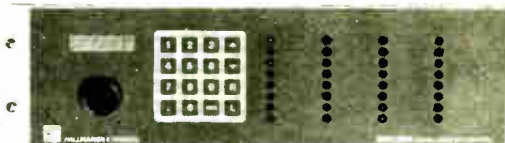

PROGRAMMABLE EXPANDABLE AFFORDABLE DRC 190

HALLIKAINEN & FRIENDS

141 Suburban E4, San Luis Obispo, CA 93401-7590 USA
805-541-0200

READER SERVICE NO. 5



MADE IN U.S.A.
MANUAL TRANSMITTER CONTROL WENT OUT WITH RABBIT EARS!

For over 15 years Monroe Electronics has supplied the broadcast industry with DTMF remote control systems. Monroe's affordable 6000 Series Remote Control Systems provide reliable control and monitoring of remote sites via DTMF commands over telephone, microwave, two-way radio or other audio paths. Monroe has a remote control system to meet your needs.

For more information, call us today at (800) 821-6001

Distributor and Representative inquiries invited.

ME MONROE ELECTRONICS
LYNDONVILLE, NY 14098

800 821 6001
716 765 2254
FAX 716 765 9330

READER SERVICE NO. 6

The MicMan™ Jr. - A 2 Channel Preamp



The MicMan™ Jr. Portable Mic Preamp

- 1 dB noise figure
- Gain range +26 to +82 dB
- 0.001% THD @ 1 kHz, @ A=40 dB

- 160 kHz bandwidth for transparent sound
- Fixed, (external PS-1), or portable use
- Uses standard alkaline batteries
- +12 or +48 V phantom microphone power
- Great value-\$425 with external power supply!

Benchmark
...the measure of excellence!

BENCHMARK MEDIA SYSTEMS, INC.
Phone 800-262-4675, FAX 315-437-8119

READER SERVICE NO. 78

CREATE A MASTER CLOCK SYSTEM

ECONOMY MASTER CLOCK CAPABLE OF DRIVING 100 SLAVES FOR \$260.00
5 DIGITAL SLAVES FOR UNDER \$1000.00

MASTER CLOCK

- ESE TIME CODE OUTPUT
- EXTERNAL SYNC INPUT
- 1PPS OUTPUT
- 3 TYPES OF ENCLOSURES
- DRIVE 100 DIGITAL SLAVES
- NEW "LX" ENCLOSURE
- SYSTEMS UPGRADABLE TO CRYSTAL, WWW, MODEM AND GPS



ES-192A



ES-192AP



NEW! LX-192A

DIGITAL SLAVES

- 5 TYPES OF ENCLOSURES
- 4 SIZES OF L.E.D.'s
- DISPLAY TIME OR DATE
- OPTIONAL TIME ZONE OFFSET
- VIDEO INSERTER
- COMPUTER INTERFACE
- MANY OPTIONS AVAILABLE

3 YEAR WARRANTY
PRACTICAL SOLUTIONS SINCE 1971

142 Sierra St., El Segundo, CA 90245 • (310) 322-2136 / FAX: (310) 322-8127



READER SERVICE NO. 14

DIGITAL ANTENNA MONITORS

In-Stock-Available for Immediate Delivery



Price US\$2400.00 2 Towers
Will operate with any remote control equipment.



Price US\$1780.00 2 Towers

For AM directional with studio located at transmitter site.

These monitors are state-of-the-art instruments of unequalled accuracy (.5% or better on ratio and .5° or better on phase) and stability. With typical modulation the true ratio readout of these monitors is a factor of 10 more stable than instruments that measure normalized amplitude, and their phase readouts are rock solid. Phase sign is automatic, no extra operation. In addition to the analog DC outputs for remote control the Model CMR has a multiplexed BCD digital output which can be used to drive the Remote Indicator Model CMR-1. RF inputs have dual protection. Gas discharge tubes across the sample line terminations plus relay protection.

GORMAN REDLICH MFG. CO.
257 W. Union St. Athens, Ohio 45701
Phone 614-593-3150 • FAX 614-592-3898

READER SERVICE NO. 43

'New World' Possible with Digital

by Thomas R. McGinley

NEW ORLEANS The second half of a two-part series covering digital technology issues facing today's engineer continued Saturday morning at the SBE Engineering Conference of World Media Expo 95.

Bill Cordell, President of Spectrum Engineering in Houston presented an enlightening overview of fiber optic telecommunications and the various new services now available to broadcasters.

"We are gradually converting this industry from copper-based signal conveyance to glass-based," Cordell said. Fiber is appearing almost everywhere and supports dramatically increased channel capacities and bandwidth for digital audio via T1, DS1, and DS3 systems at affordable prices. Cordell provided a primer on these technologies as well as a review of the pitfalls broadcasters will encounter when attempting to order and use such services.

Fiber is growing

The growth and use of fiber is mushrooming almost as fast as the Internet.

"Glass hose is getting very cheap, with prices of \$10 per foot and \$1 per weld," said Cordell. Conveying multiple channels of dial tone and broadcast quality circuits over distance no longer requires leasing only Bell facilities over their system at very high prices. For permanent installations, considerable savings over time can be realized by investing in carrier and fiber transmission gear and leasing the interconnect from the lowest cost provider.

One of the big problems confronting broadcasters is that the Bell companies and the "Bell bypass guys" are not telling the whole story and do not offer consistent rate and tariff information. Bell-bypass companies include Metropolitan Fiber, Teleport (New York), MCI Metro, and others.

"Never take what they first tell you about available services and cost at face value. You can get it cheaper, faster, and better by doing your own homework."

With prices of optic driving devices dropping steadily in recent years, it will soon be feasible to carry the RF signal via fiber, allowing the exciter to be placed at the studio. Cordell has compiled a list of suppliers and common tariffs used in a dozen states he will supply to interested engineers. Call Bill at Spectrum Engineering in Houston at 713-984-8885.

Whole new world

A whole new world of possibilities for FM subcarrier uses was explored by Dave Maxson, chief engineer of Boston's classical station WCRB, and David Murotake of the Sanders Corporation, a Lockheed-Martin Company working in advanced digital modulation schemes used in military applications.

The "Dave and David Show" featured a fast-paced question and answer format which examined the theoretical possibilities of what could be done with FM SCA, or SCS as the Federal Communications Commission (FCC) prefers to call it.

"The SCS region from 59 to 99 kHz turns out to be very fertile in terms of bits

per second per hertz efficiency and can support SSTV, digital audio, as well as many high speed data applications." The result is "multimode" radio technology which can be delivered by inexpensive but very smart DSP receivers capable of demodulating virtually any ancillary digital bitstream.

Presently FM SCS's only produce marginal revenue enhancement for most stations with ancillary services. Michael Bloomberg has called radio people "tree people." We don't look beyond the tree we live in at the rest of the forest and all its potential. In terms of data, the 200 kHz FM channel can support over 200 kilobits of capacity.

At a typical 19.2 kilobits per second (kbps) rate, the channel efficiency is 7.1 bits per second per hertz. That would easily handle digital audio at 128 kbps which needs only 3.2 b/s/hz. Why not a data compressed stereo DAB signal? The question suggests intriguing possibilities.

DAB SCS?

Could we fold "CD quality" digital audio into the SCS region? It certainly appears feasible. Call it "duopoly in a box."

This scheme differs from the other DAB systems which all use spread spectrum technology to mitigate multipath. But it does not generate additional noise and potential interference to the analog signal and does not require any regulatory changes to begin using it.

Receivers for this technology can be adaptive, hence we could have "software radio" with the ability to select the data stream and service desired. Maxson indicated that this system will be tested over the air starting later this year.

ISDN, aka the "high fidelity dial-up network" is growing by leaps and bounds all over the country. As with any new technology, there are sometimes strange and quirky things that happen when using it. "Real World Experiences with ISDN and the New Breed of Codecs" was WPEN/WMGK Chief Engineer Larry Paulausky's presentation based on his station's two years hands-on run with ISDN. Paulausky offered a detailed tutorial on ISDN basics and codec hardware, as well as advice on how to order ISDN service and use it for best results.

At most of the Baby Bell companies, ISDN now costs \$100 to \$200 to install plus a monthly charge of \$35 to \$50, and per minute usage charges. Installation is very similar to a basic POTS line and typically requires three to five days advance notice. Because there are so many different options and configurations available, Paulausky advises placing any ISDN order in writing on a standardized form with all specific options desired clearly identified.

Before heading out to do the remote, allow plenty of time and expect that you may have trouble. Determine the repair request procedures needed (usually an 800 number), and carry a backup system if you can, whether it be Marti, POTS dialup, or whatever. ISDN is still a rather fussy new technology for many in the phone company too, so both sides are really learning by doing.

"The very first thing to do on site is precheck the ISDN circuit to be sure it will dial and connect with your studio", warns Paulausky. This is especially important for long distance remotes because you will likely be crossing latas, state lines, and operating companies.

If it doesn't work, first check the TA (terminal adaptor) setup and the SPID numbers (service profile identifying designator). Try a local loopback test to verify the codec is OK. Try dialing another known working ISDN number, perhaps at a different local station. Ask the phone company for a BER test (bit

continued on page 54 ▶

Think of Them as Reference Monitors You Can Wear

When you need to hear exactly what you've recorded... nothing more, nothing less... then only Sennheiser's HD 25 SP will do. Excellent isolation, with clear, accurate reproduction are the trademarks of these reference-quality headphones. Plus, they're MUCH more comfortable than wearing speakers.

Your project studio is incomplete without the HD 25 SP. Check them out today at your local Sennheiser dealer.





HD 25 SP



6 VISTA DRIVE, P.O. BOX 987, OLD LYME, CT 06371
TEL: 203.434.5190 • FAX: 203.434.1759
IN CALIFORNIA: 4116 WEST MAGHOLIA BLVD, SUITE 100, BURBANK, CA 91505 • TEL: 818.845.7366 • FAX: 818.845.7140
IN CANADA: 221 LABROSSE AVE., PTE-CLAIRE, PQ H9R 1A3
TEL: 514.426.3013 FAX: 514.426.3953

COME TO THE CHOICE OF RF ENGINEERS FROM COAST TO COAST FOR YOUR AM ANTENNA SYSTEMS OR COMPONENTS

KINTRONIC



LABS, INC.

WE NOW ACCEPT VISA, MASTER CARD

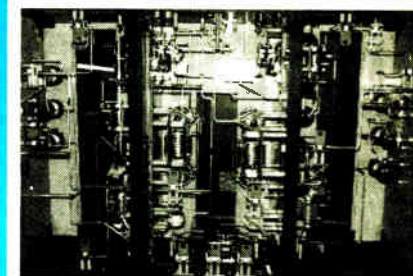
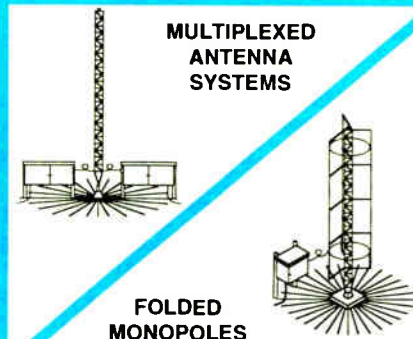

**DIRECTIONAL ANTENNA PHASING SYSTEM
WMAL-AM RADIO
CAP CITIES/ABC
WASHINGTON, DC**

KINTRONICS PRODUCTS INCLUDE:

- BROADBAND ANTENNA TUNING UNITS
- DIRECTIONAL ANTENNA PHASING AND MATCHING SYSTEMS
- MULTIPLEXED ANTENNA SYSTEMS
- FOLDED MONOPOLE KITS
- TRANSMITTER COMBINERS
- DUMMY LOADS (CONVECTION COOLED UP TO 20 KW + MOD.)
- FIXED AND VARIABLE INDUCTORS
- RF CONTACTORS (SPDT & DPDT)
- CUSTOM SWITCHING SYSTEMS & CONTROLLERS

**KINTRONIC LABORATORIES INC.
P.O. BOX 845
BRISTOL, TENNESSEE 37621-0845
PHONE: 615-878-3141/FAX: 615-878-4224
INTERNET: KINTRONICS@DELPHI.COM**

NEW Math for Going DIGITAL

 +
 
 +
 
 = **Cart Replacement**
 MSRP \$1299 MSRP \$795

 +
 
 +
 
 = **AUTOMATION**
 MSRP \$1495 MSRP \$399

 +
 
 = **satellite switching**
 MSRP \$299 MSRP \$299
 SCC-8 XP-3
 Satellite Channel Controller Satellite Transponder Controller

 or
 
 = **AUDIOSwitching**
 MSRP \$399 MSRP \$629
 6X1A 8X2
 Passive Stereo Switcher / Router Active Dual Stereo Switcher

Go **completely** DIGITAL the *easy* way
 with software from **WireReady[®] NSI!**

Off-the shelf **HARDWARE** works *with* your **own** computers!

Novell *and* Lantastic **LAN** compatible Backed *with* 24-hour 800 support & **FREE** Upgrades

GROUP Software Licenses **Available**

Call for package pricing and a complete catalog.

Southeastern Sales Office

200 Fairway Drive, Suite 2
 Smithfield, North Carolina 27577
 Phone: 800-369-7623
 Fax: 919-934-8120

Main Sales Office

2342 S. Division Ave.
 Grand Rapids, Michigan 49507
 Phone: 800-999-9281
 Fax: 616-452-1652

Western Sales Office

P.O. Box 1638
 Palmdale, California 93550
 Phone: 800-858-9008
 Fax: 805-273-3321

Please visit us
 on the
 World Wide Web:
www.abg.com

for **35** years



You may also reach us anytime via electronic mail
 cServe: **75371,144** internet: **support@abg.com**

World Media Expo

Digital Redefines Workplace

by Thomas R. McGinley

NEW ORLEANS A two-part series covering numerous topics in the digital domain was one of the highlights of the SBE Engineering Conference at World Media Expo 1995. Skip Pizzi, a well-known industry watcher of digital developments, lead off Friday morning's session with predictably articulate advice on "How to Survive Your Digital Future."

The digital age has filled today's broadcast facility with a myriad of new technologies and challenges which according to Pizzi, "should not be viewed as threatening but rather as beneficial to those who use and maintain them." Greater creativity, reduced costs, and expanding programming and production opportunities are a few such benefits.

The modern integrated radio facility is relying more and more on computer based systems, requiring many engineers to become literally fulltime computer systems administrators (CSA) or managers of information services (MIS). Every radio station is having to make the decision on how and who will be responsible for the computer systems now literally taking over their operations.

Computer geeks

At many stations, the only person with sufficient computer literacy in a position to help is the staff or contract engineer. Keeping up with the onslaught of changes and advances in computer and digital technologies is almost a full-time job by itself. Most engineers tend to be naturally inquisitive and readily assimilate new information, but they need to be very efficient with their time and learning capacities in order to remain effective as a primary systems resource center and still get the rest of their traditional functions handled.

Learning by doing is often the primary means of acquiring the new skills needed and usually means spending additional time on the home computer. Reading, attending trade shows, networking with other engineers and taking continuing education courses at local schools are all information avenues which will help today's radio engineer stay updated and on course.

At busier and larger stations, outside help for software training and systems maintenance support will likely be necessary. For computer based automation and digital audio workstations, taking advantage of manufacturer's training and support programs should be part of the purchase.

Pizzi emphasized the reality that these systems are here to stay and will form the basis of most of the broadcast infrastructure for many years to come.



The World Media Expo exhibit floor tied together the separate conferences being held concurrently by the SBE, RTNDA, SMPTE and NAB.

Learning digital audio, computers, and networking will help insure job security in an industry wherein fewer people are doing more of the work. Especially in medium and larger markets, Pizzi implored that as engineers, "we cannot afford not to do this, and that surely the Geeks Shall Inherit the Earth."

James Hauptsteck, manager of digital products for Harris Allied, observed that "keeping up with the digital revolution is like trying to read a billboard traveling in a car going 200 miles per hour." Hauptsteck conducted an in-depth overview of the many digital-based recording and storage options available today in his presentation of "Digital Storage Options."

Player of choice

Much of the early digital gear led many in this industry down blind or dead-end alleys, mainly because it offered no integration into newer more efficient technologies as they became available.

Today, hard disk drives have emerged as the player of choice for digital storage, both for automation and live assist type systems. SCSI chains can now support up to seven drives, with compact half-height drives of 9GB capacity readily available at affordable prices. Such drives are very durable, with many now carrying five year warranties, but of course they will

eventually fail. Redundancy is an obvious requirement.

Hauptsteck described the various schemes which have been developed to provide such backup, each with its own set of advantages. The cheapest is the peer to peer LAN (local area network) wherein each studio or workstation stores everything. Audio file transfers must occur behind the scenes before use.

The more bulletproof approach is using duplex redundant servers on a Novell based SFT network.

Two separate network servers and drive chains are continuously running and mirroring each other and are accessible by any workstation. The network can be built with either RG-58 or UTP (twisted pair) interconnect, with an IDE drive running the system and SCSI drive chains storing and playing the audio. Errors are always logged.

Disadvantages of using a Novell net are cost and the problems associated with power glitches and outages. Workstations usually have to be powered back on line in sequence after an outage.

Raid array

The "raid array" drive configuration is cheaper than Novell and provides for the rebuilding of lost data, but must be done with the drives off-line. Other methods used for data backup include VHS tape, DAT (digital audio tape), dual drives, and hot removeable drives.

The use of digital compression, using the more popular algorithms such as Mpeg layer 2, Dolby AC-2, and Aptex can reduce storage capacity requirements by four or even eight times. However, as harddrives become larger and cheaper, the use of compression is not the requirement it once was. Hauptsteck emphasized the need for thorough employee training when converting to such systems and to include the installation of surge suppressors, UPS systems, and emergency generators for power backup.

Glynn Walden, director of engineering for Group W Radio, conducted an insightful real-world tour through the various pitfalls encountered when choosing, installing, and using hard drive-based digital audio network/server and storage systems. Group W has evaluated and installed at most of its stations a

number of the popular systems available and in use in all size markets.

These systems are rapidly replacing the venerable cartridge tape infrastructure throughout the industry because they can provide a more invisible and easily used interface to the talent. get the product to air faster with fewer errors, and save on production and maintenance time as well as other personnel costs.

Need champions

The most important requirement in the conversion process is identifying a resident "champion" of the specific system selected who will act as a full-time administrator until all of the initial bugs are worked out.

"Whether this champion is a staff engineer or programming person, no system will succeed and do the job station management requires without it being fully embraced and supported," Walden said.

Walden stressed the absolute need for careful planning and coordination with the designer and vendor of any system selected. Systems are sold two ways: either WYSIWYG (what you see is what you get) or custom. Smaller less expensive systems are not easily customized.

"Know exactly what your specific source to source transition requirements will be and have the vendor promise in writing they can deliver what you want," said Walden. "Custom features are often vaporware."

According to Walden, DOS and Novell Networks provide stable platforms for controlling the air product, but Windows does not.

For a digital platform to work

well, you need a champion to work with the talent and the vendor who is willing to tough it out; a commitment from everyone, including management to make it work; a shake-down period of full rehearsal off-line testing by all operators and talent — you don't want to be experimenting on the air — and plenty of training for everyone involved. Spend money to have the vendor train everyone on staff, not just the champion.

Intuitively uncluttered

When choosing a system, pick one which is simple to learn and use and which can be easily interfaced with source equipment. You want an intuitive uncluttered video screen with big fonts. Provide larger monitors (17- to 25-inch) for easier copy reading. Be sure the system offers security against accidental data erasure, virus contamination, and vandalism. And be sure to include backup and redundancy.

Archive all spots to DAT and never depend on only one server or one hard drive chain. Group W uses two independent Novell file servers, mirrored drive chains and spare hard drives on every shelf ready to go.

"Telephone and Acoustic Echo Cancellation for Broadcasting and Teleconferencing" is a tough problem now easily conquered by digital technology. Elaine Jones, marketing manager of Gentner Communications discussed the two sources of troublesome echoes encountered when using telephone systems: Internal echoes, which are generated within the phone network

continued on page 47 ▶

More Reasons to Choose Gepco



Cost-effective. Quality Crafted. Your choice of cable type, length and color from our extensive selection. Delivered to you on time. Gepco manufactures custom cable assemblies, audio and video snakes, breakout boxes, panels, patch bay wiring harnesses, direct boxes and prepackaged cable assemblies for point-of-sale display. All Gepco cable and custom products are made in the U.S.A.

We are authorized distributors for ADC, Kings, Neutrik, Switchcraft, EDAC and many more. Gepco stocks audio and video cable in bulk and will custom-cut to any length requirement for no extra charge.

1-800-966-0069

Ask your Gepco sales representative for a free catalog
Cable, Connectors and Custom Products

GEPco

GEPco INTERNATIONAL, INC. 2225 W. Hubbard, Chicago IL 60612
312-733-9555 Fax: 312-733-6416 TOLL-FREE: 1-800-966-0069

BRACE YOURSELF

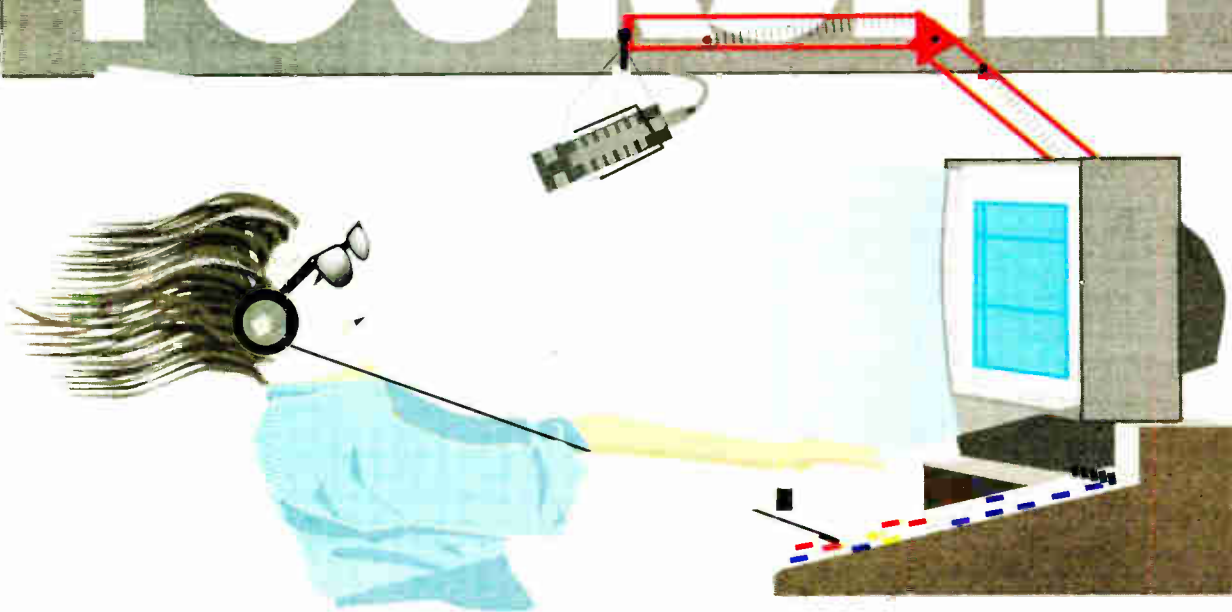

FOR TOTAL DIGITAL POWER

Total digital integration by Computer Concepts dramatically improves every area of your station—sound, programming, production and scheduling. The efficiency gains reported by users—talent, managers, producers and engineers—are remarkable.

Computer Concepts puts you in charge of the station of your dreams. You knew that someday

everyone in the station could be in constant communication. You knew that someday the burden of producing your program would be reduced to less than half. And you knew that it was only a matter of time until all your station's audio could be *instantly* previewed and monitored by all with ease. The wait is over.

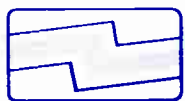

Computer Concepts
CORPORATION

Isn't It Time To See What Digital Performance Will Do For Your Station?

Like other digital systems, Computer Concepts clears up cart-clutter and improves sound quality. But that's where the similarity ceases.

Computer Concepts is also the easiest to use of any digital system anywhere. Networked for peak efficiency, each area of your station will operate better than ever before.

From the very first day our practical features will win rave reviews from your staff. Ask the station managers across America and around the world who use it . . . Computer Concepts changes everything.

Whether you are ready for one or two components, a complete system, or even if you are just starting to shop digital, we are eager to help turn your good station into a great one. Please call today and ask for a free demonstration.

**World
Leaders In
Digital
Performance**

Audio Consoles

The standout #1 leader in reliable, high performance, digital ready consoles for radio, Arrakis has several console lines to meet your every application. The 1200 series is ideal for compact installations. The modular 12,000 series is available in 8, 18, & 28 channel mainframes. The 22000 Gemini series features optional video monitors and switchers for digital workstation control.

1200 Series Consoles

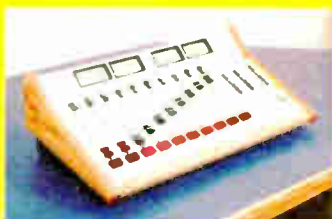

1200-5	Five ch	\$1,795
1200-10	Ten ch	\$3,495
1200-15	Fifteen ch	\$4,995

12000 Series Consoles from \$3,995



22000 Series Consoles from \$6,995



Digital Workstations

#1 in digital workstation sales, Arrakis has over 1,600 workstations in use around the world.

As a multipurpose digital audio record-play workstation for radio, it replaces cart machines, reel machines, cassette recorders, & often even consoles. Digilink has proven to be ideal for live on air, production, news, and automation applications. Place a workstation in each studio and then interconnect them with a digital network for transferring audio, text, & schedules between studios. Arrakis is the #1 choice of broadcasters.

Satellite Automation



CD Automation



Use for Live On Air, Automation, Production, News & Scheduling



Digilink & Trak*Star Workstations

Studio Furniture

With over 1,000 studios in the field, Arrakis is #1 in studio furniture sales for radio.

Using only the finest materials, balanced laminated panels, and solid oak trim, Arrakis furniture systems are rugged and attractive for years of hard use.

Available in two basic product families with literally thousands of variations, an Arrakis studio furniture package can easily be configured to meet your specific requirement, whether it is simply off the shelf or fully custom.

Call Arrakis to find out how easy it is to design and build your next studio.

Desk*Star studio furniture systems



Modulux studio furniture systems

Complete systems...

As illustrated in the Sony Worldwide Networks master control studio on the right (one of seven Arrakis studios in the Manhattan, New York complex), Arrakis can provide complete major market studios with Arrakis consoles, digital workstations, video-audio switchers, furniture, and system prewiring.

With a choice of several console lines; digital workstations for live air, production, news, and automation; and two major studio furniture product lines, Arrakis can meet broadcasters needs from the compact news studio to the major market network origination center. Complete Arrakis equipped studios can be found around the world from Tokyo, to Moscow, to Japan, to Tahiti. Call Arrakis today for your equipment or studio needs,

Sony Worldwide Networks
Manhattan, New York

