

*****3-DIGIT 857
 C1C1 000296705 9424 BUK
 TOM MILLER
 ASST. CE
 K17R
 2033 S AUGUSTA PL
 TUCSON AZ 85710

Radio World



Studio Sessions

See pp. 15-24

Vol 18, No 24

Radio's Best Read Newspaper

November 30, 1994

RBOCs Ready to Roll Out ISDN

by Thomas Pear

MORRISTOWN, N.J. Bellcore, the research center for the regional Bell operating companies (RBOCs), reports that many regional Bell and other phone companies are now offering Integrated Service Digital Network (ISDN) hookups from anywhere within their territories, creating enhanced audio remote opportunities throughout the radio industry.

Pacific Bell, Ameritech, Bell South, Bell Atlantic are among the companies promising 100 percent ISDN access, said Bill Sohl, a technical staff member of Bellcore. Southwestern Bell reports that it is developing a similar plan to make ISDN available everywhere in its territory.

"That is our strategy," said Jim Brooks, a

Southwestern Bell area manager.

In addition to the Bell companies, several regional GTE companies are also offering



WXTR's Jack Alix (l), Bob Rich, Peggy Castle and Bobby Bennet (r) on remote from the Watergate Hotel

100 percent ISDN access, including certain cities in Florida, North Carolina, Indiana,

Ohio, Illinois, Kentucky, Pennsylvania and Michigan.

ISDN will even be available if a customer's nearest local phone company office does not have an ISDN-compatible phone switch. The companies would run the customer an ISDN line to the nearest office within their territories that does have a ISDN-compatible switch, sometime giving customers an out-of-town ISDN phone number.

In the not-too-distant future, though, running additional ISDN lines to different regional offices will become a thing of the past. Many regional phone companies are increasing the number of ISDN available phone lines.

Bellcore is soon to release a set of projections that will show the number of available ISDN lines offered by local and regional phone companies by the end of 1996 (see chart, page 24).

GTE said that about 50 percent of its lines will be ISDN available by the end of next year.

At press time, Bellcore would not release the new projections, but a company official

AT PRESS TIME

FCC Finally Rules on EBS

WASHINGTON In a unanimous decision, FCC commissioners voted earlier this month to replace the current Emergency Broadcast System (EBS) with the new Emergency Alert System that will work with both new and established technologies.

EAS features a digital system architecture designed to allow broadcast, cable, satellite and other services to send and receive alerting information; have multiple source monitoring for emergency alerts; reduce the alerting tones down to a minimum of eight seconds; create "unobtrusive" weekly and monthly tests; feature automated and remote control options; have the ability to issue

continued on page 2 ▶

did acknowledge there will be a significant increase in the number of available ISDN lines in 1996 from 1995, although GTE independently reported that 54 percent of its lines will be ISDN available by the end of 1996.

"They are definitely going up," said Royce Hazard-Leonard who is packaging the new Bellcore figures for public release.

About 76 percent of Southwestern Bell's customer will be able to get an ISDN hookup by the end of 1996, according to the company.

Besides becoming geographically available, ISDN is quickly becoming economically available. Many regional phone companies offer ISDN rates that are reasonable when compared to other types of enhanced voice carrying technology.

In the case of Bell Atlantic, ISDN cost \$131 to install. The system is then treated as business line hookup. A monthly ISDN fee of about \$20 is added to the standard business line monthly cost. ISDN users then pay about five cents per minute per bearer channel, which adds up to 10 cents a minute because broadcasters normally use two channels known as B channels.

To further reduce ISDN costs, Bell Atlantic offers bulk rates, which in some cases can lower the usage fee to four cents per minute for both bearer channels.

In Michigan, customers using two channels pay a \$147 one-time fee and a monthly fee of \$27.21. Ameritech, the Bell company servicing Michigan, then charges 8.2 cents per call for local calls and 8.4 cents per call for regional calls to places outside the caller's locality but within the regional telephone company's territory. In comparison per minute for both bearer channels.

In Michigan, customers using two

continued on page 24 ▶

Antenna Farm Exceeds ANSI RFR Standards

by Alan Haber

WASHINGTON It goes without saying that exposure to too much RF radiation at antenna sites is a hazard well worth guarding against. One would think that, as a matter of course, the necessary precautions are automatically taken to insure that RF levels are kept within the limits outlined in the 1982 ANSI standard titled "American National Standard Safety Levels with Respect to Human Exposure to Radio Frequency Electromagnetic Fields, 300 kHz to 100 GHz."

This has not been the case at the Black Mountain antenna farm, located about 11 miles southeast of downtown Las Vegas in Henderson, Nev., according to the FCC. There are 11 radio stations at the site: KCEP, KILA, KUNV, KXTZ, KWNR, KKLZ, KLUC, KMZQ, KFMS, KEDG, KRLV. In addition, KEYV-FM has an auxiliary antenna there.

Television stations, and a variety of other users, including digital paging and cellular telephone companies, are also resident at the site. The FCC has been aware of problems with RF levels on Black Mountain since 1991. Steps are currently being undertaken to bring RF radiation levels down to comply with the ANSI standard.

On Dec. 5, 1991, Advanced Mobile-Comm of Nevada Inc. (AMI), the owner of four broadcast towers at the Black Mountain site, notified the FCC that high RF radiation levels were in evidence there, and there was the potential for physical harm to personnel authorized to access the site due to exposure.

In the letter to the commission, AMI referenced a report issued by the engineering firm Richard Tell Associates Inc. which said that KXTZ-FM "is the largest source

continued on page 8 ▶

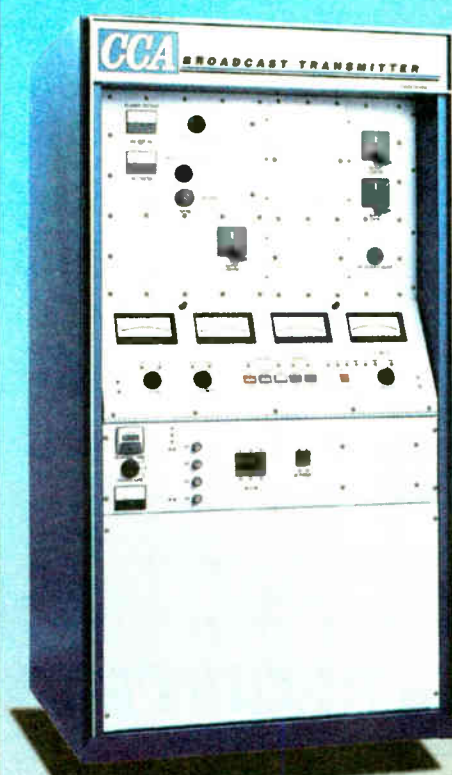

CCA Broadcast Transmitters...

Built First to Last.



30 YEARS

CCA

360 Bohannon Road • Fairburn, Georgia, USA 30213
 (404) 964-3530 • FAX: (404) 964-2222
24-HOUR SERVICE, 365 DAYS-A-YEAR

NEWSWATCH

► continued from page 1

alerts in other languages and make provisions for the hearing impaired; prohibit the false use of the codes and the alert signal and mandate a standard protocol for sending messages.

Broadcasting radio stations and television stations will be required to replace EBS equipment with EAS equipment by July 1, 1996. Cable systems, which are being included for the first time in EBS—soon to be EAS, will have until July 1, 1997 to replace their equipment.

Also, existing EBS equipment must be capable of decoding the shortened eight second version of the two-toned alerting

signal by July 1, 1995. At that time stations will be allowed to transmit the attention signals for not less than eight seconds and not more than 25 seconds. Then, after July 1, 1997, stations will only be allowed to broadcast the new eight-second signal when announcing the monthly test or an actual emergency.

In an effort to encourage rapid manufacturing and deployment of the new EAS equipment, broadcasters are allowed to purchase and install the new equipment in advance of the timetable deadlines.

The FCC will approve early replacement of current technical and operating procedures on a state or local basis,

allowing the use of the shortened signal and allowing stations to replace their EBS equipment.

The FCC will also grant authorization for early deployment of EAS in a given area as long as all the stations in that area have installed the necessary equipment, demonstrated the inclusion of cable in their local areas and have complied with other EBS/EAS rules.

Varian Selling Electron Devices Branch

PALO ALTO, Calif. Varian Associates Inc. recently announced it is selling its Electron Devices operations. The investment banking firm of Morgan Stanley and Co. has been retained to identify potential buyers and assist with the sale.

The business up for sale has assets of \$150 million, posted sales of \$275 million in fiscal '94 and made pretax earnings of \$18 million, noted Varian Chairman and Chief Executive J. Tracy O'Rourke.

Although the bulk of the sale proceeds would be earmarked for the repurchase of additional Varian shares, some of the funds could also be used for selected acquisitions to expand three core Varian businesses that will remain after the sale, O'Rourke said.

Varian's Electron Devices business produces vacuum tubes power supplies, amplifiers and other products mostly for communications, medical, and defense markets.

NAB to Move, Temporarily

WASHINGTON The National Association of Broadcasters (NAB) will be moving to temporary quarters in February, located at 2001 Pennsylvania Ave.

The move allows the powerful lobbying organization to rid NAB headquarters, located at 1771 N Street N.W., of asbestos, plus make a few renovations on the side.

Despite the move, broadcasters should realize little change because the NAB's phone number and mailing address will remain the same. ☺

When looking for a digital audio system for automation of satellite programming or live assist, there would appear to be many choices. But if you're looking for a system which is flexible enough to give you total control without sacrificing your sanity, there is only one choice. The Phantom by RDS.

You will see the difference as soon as you see the Phantom in action. The display provides you with all of the information you need to see in a clean, concise manner, without the crowded look that you'll find in other systems. If you are familiar with the most popular software on the PC, then you may already know how to use the Phantom. The Phantom's pull-down menus guide you through all of the steps involved in setup and daily operation, from creating and scheduling clocks to creating and editing logs.

The PHANTOM Digital Audio Automation

The Phantom ends the confusion of automation by keeping everything organized. The Phantom simplifies your daily operations by keeping information such as input changes, voice changes, and clock changes in their own individual schedules rather than in the log. You can leave those liners and other voice drops out of the log because the Phantom will do them for you. The Phantom allows you to date new schedules to begin weeks, months, or even years in advance. When your satellite network informs you that there will be a voice substitution on Thursday, two weeks from today, you can prepare for it *today*.

The Phantom can retime spots to fit them cleanly into a satellite break without inserting silence, overlapping, or running late. The Phantom



can create reports to keep you informed on a number of topics, from a list of expired spots to an analysis of potential mistakes in your log. The Phantom also maintains a history of system activity.

The Phantom has the features that others would want you to believe are theirs exclusively. The Phantom remains *completely* functional during recording, sensing relay closures and starting breaks as easily as it does when it is not recording. The Phantom can fill incomplete breaks with spots from a list you specify without ruining product separation.

While other systems tie your hands and limit your flexibility by only offering 3 or 4 inputs, the Phantom gives you 6 stereo inputs, using its AMX-84 solid state switcher, with the option of increasing the number of inputs to 14 or more. If your station is News/Talk, you know how important this can be.

The Phantom allows you to change the sampling rate, digital format, and stereo/mono settings at will to meet your needs for an individual spot. The Phantom offers a number of digital formats, including the new Dolby AC-2 format, as an option.

Call us today to find out how your station can benefit from the advanced technology of the Phantom and the experience of RDS.

1-800-521-5222
912-987-2501 • FAX: 912-987-7595
P. O. Box 980, Perry, GA 30169



**REGISTER
DATA
SYSTEMS**

Index

STUDIO SESSIONS

- Desk-size Digital Mixer from Yamaha**
by Ty Ford **15**
- New Crop of PDAs Useful Audio Tools**
by Frank Beacham **16**
- 'Best Buy' Mackie Excels On Remote and in Studio**
by Frank Beacham **18**
- Setting Up for Live Recording**
by Mike Joseph **23**
- Aphex Combines 'Tube' Sound, Low Cost**
by John Diamantis **24**

FEATURES

- Interface Box a Simple But Important Item**
by Jim Murphy **30**
- Workbench**
by John Bisset **31**
- Testing Some New Network Software**
by Richard Mertz **32**

BUYERS GUIDE

- DN-650F Offers Professional Features**
by John Bisset **34**
- USER REPORTS**
- Pioneer 300-Disc Changer Boosts Efficiency at KWJJ**
by Michael Kelly **34**
- Show Banks on Sony MiniDisc**
by Craig Crossman **36**
- WACO Enters Digital Era with Scott Studios**
by John Elliot **38**

TECHNOLOGY UPDATES

- Tascam **41**
- Fidelipac **41**
- Harris Allied **41**
- NSM **41**
- Panasonic **43**
- Broadcast Electronics **43**
- HHB **43**
- ITC **43**
- Fostex **43**
- Otari **44**
- Radio Systems **44**
- Technics **44**

FM Pioneer T. Mitchell Hastings Dies

by Lynn Christian

LOS ANGELES The year was 1962. There was excitement in radio. Rock 'n' roll had saved AM radio when long-form network programming died in the 1950s. Now it was a technological breakthrough: FM multiplex stereo—and nearly 1,000 FM stations were gearing up or

into building and marketing FM or FM/AM receivers for the home or auto, and promote the "second coming of FM" after its disastrous start in the 1940s.

On Sept. 27, 1994, at the age of 84, Mitch Hastings passed on, following a serious bout with cancer. An infinitesimal percentage of today's FM broadcasters have ever heard his name. Mitch sold

duced a vest-pocket FM receiver.

His group of FM stations in New York, Boston, Hartford, Conn. and Providence, R.I., the Concert Network, were ground breakers in providing listeners classical music, in stereo, in the early '60s.

Some of the names of early members in the NAFMB who worked with Mitch in FM's infancy include John Lawrence in Cincinnati, Bill Buckley in Santa Barbara, William Boeing in south Florida and Hank Slavick in Memphis. There was even a NAFMB board member representing Canada, a young fellow from Toronto named Ted Rogers. We all remember him as a person with ideas and energy, an entrepreneur. If you have kept up with Canadian cable growth in the past 25 years, you know that the Ted Rogers' story rivals the Ted Turner story in the U.S.

Working with a group of Harvard graduate students, Mitch delivered a keynote address to the annual NAFMB convention on March 30, 1963—a speech titled "The Future Is FM." This was the beginning of the end for AM radio dominance in the U.S. In his talk, Mitch revealed, step by step, a new Harvard Business School FM study. For those of us who knew Mitch, we were aware that his study would be challenged and questioned by the advertising community and

broadcasters.

These forecasts were described as "pie in the sky" and "outrageous." They included major growth in set sales, new FM stations and advertising revenues. There were rumors that this was not an official Harvard-sanctioned study, and we will never know for sure. However, its 10-year projections, 1964-1974, eventually proved accurate to within a few percentage points. For those of us who planned our personal future on FM radio's growth, we are forever grateful.

Mitch Hastings was one of a kind. His dedication to Major Armstrong's discovery, his work in preserving the Armstrong name and heritage through the Columbia University Foundation, were mostly done without financial rewards. He was the right man for the job, from the beginning until his final hours as he planned the next Armstrong Awards mailings. He never lost his vision, his sense of humor or his respect for other people's ideas.

Thanks, Mitch, from all of your friends in radio. You made FM a lot more rewarding, and fun, for all of us.

□ □ □

Editor's Note: Lynn Christian was himself a founding member of the National Association of FM Broadcasters and a board member of the Armstrong Foundation. In addition, Christian received that foundation's first individual award for the development of FM radio.

Founders of NAFMB Get Gavel of Honor



(L to R)—T. Mitchell Hastings, Jr., WBCN, current president NAFMB; William D. Caskey, WPEN; William Tomberlin, KMLA, retiring treasurer NAFMB; Laurence Gordon, WBUF; Fred Rabell, KITT, retiring president NAFMB; Pose with gavels presented to them as founders of National Association of FM Broadcasters.

The front page of Volume 1, No. 1, of the NAFMB's Report

going on the air to transmit a signal quality which would far surpass AM at the time.

There was a band of entrepreneurial people pushing FM and FM stereo in the early 1960s, and the quiet man at the forefront was a Harvard communications engineering graduate named T. Mitchell Hastings Jr. As president of the renegade National Association of FM Broadcasters, Mitch Hastings manipulated an enthusiastic but disorganized group of engineering, programming and marketing people into believing FM radio would be the dominant radio medium by the mid-1970s.

With more than 100 stations donating spots to sell to one advertiser (Magnavox) in 1962, Mitch raised \$150,000, a cache that was carefully used to develop new FM research, press manufacturers

his Concert Network holdings more than 15 years ago.

Since that time, from his homes in the northeast, Mitch served as president of the Major Armstrong Memorial Research Foundation at Columbia University. As most devoted students of radio remember, Major Armstrong invented FM and led a tragic life, brilliantly portrayed in prose by Tom Lewis and in video by Ken Burns in his 1992 PBS special, "Empire of the Air."

In 1919, while in the fifth grade, Mitch and a group of neighborhood boys in Santa Barbara, Calif. put together a radio transmitter from a kit they bought in San Francisco. The radio bug had bitten, and he never recovered. In the early '50s with Edgar Brooks of Raytheon, he developed, manufactured and marketed the Hastings FM car radio tuner. He also pro-

A Broadcast Industry
BEST BUY

Mono Play **\$1000** Stereo Play **\$1100**

F.O.B. Factory
Reliable / Rugged / Professional Design



DL Series

AUDI-CORD CORPORATION

1845 West Hovey Avenue, Normal, Illinois 61761 USA
Phone 309-452-9461 - Fax 309-452-0893

Available Through Your Regular Distributor

Circle (14) On Reader Service Card

Compact FM Powerhouses



Continental 814J 3.8 kW FM Transmitter

- 100% solid state; modular component redundancy
- Patented "Soft-Start"™ for primary voltage
- Automatic power output control
- Automatic power interrupt recycle
- VSWR protection and self-protecting amplifier modules

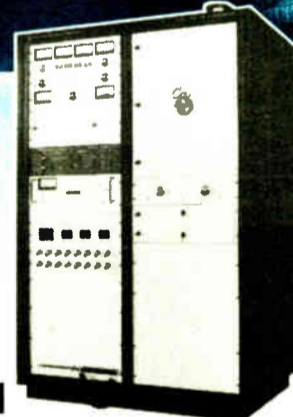

Continental 816B 11 kW FM Transmitter

- Solid state IPA; requires no tuning
- Patented "Soft-Start"™ for primary voltage
- Automatic power output control
- Automatic power interrupt recycle
- Dual independent VSWR protection circuits

10.94-102

For nearly 50 years, Continental Electronics has provided excellence in broadcast transmission products worldwide. Refuse to compromise.....call Continental first!



Continental Electronics Corporation

P.O. BOX 270879 • DALLAS, TEXAS 75227-0879
214/381-7161 • FAX: 214/381-4949

Circle (115) On Reader Service Card

Give the Locals a Chance

WASHINGTON Letters to the editor on the subject of the recently transacted sale of WOWO(AM) Fort Wayne, Ind., prove that passion still runs high in radio, especially when it comes to the glory days.

(Once upon a time, the land was dotted with full-service clear-channel stations, the jewels in the crown of many old-line broadcast companies...)



And as harsh as this may sound, I feel compelled to say that nostalgia is fine for a hobby, but business is business.

Back when the industry was still nascent, the original charter of the clear channels encompassed the notion that not only should urban areas be served by radio, so too should the rural ones. Thus clear-channel stations broadcast their full-service format across the nation, and in many cases, across the oceans.

Fast-forward to 1994. There are roughly 10,000 radio signals across the U.S. Not only are rural areas not underserved, but many stations have complained (on *RW*'s own opinion page) about the oversaturation of radio markets, FM Docket 80-90. Interference on the AM band—which led to the expanded band. Incentives for turning in your AM license rather than trying to sell an unprofitable signal.

All of these things are happening

around us as I write this. Yet *RW* is being lambasted for favoring the "prostitution of the band for a buck."

I say forget passion for history and think about the present and the future. Clear channels, like most stations, make the bulk of their revenue during the day. So it's not like they'll be losing money if they have to power down or alter their signal a bit at night.

Clear channels cannot serve rural or distant areas better than the local stations that are now powering down to make way for them. Yet the big guys get to blast their signal into that region, make no money at it, and deny the local station a chance to serve its community and make money doing so.

If serving the rural areas remains an important part of radio's charter, then it can best be served by letting the local stations—not the distant clear channels—operate in their own communities.

I don't think I'm calling for the prostitution of the band for a buck. I'm calling for a more equitable distribution of scarce spectrum to better serve a larger number of people. Isn't localism what radio is about?

(...And the day came when the land was bedecked with thousands of stations, each one the prize possession of its community, the only jewel in a locally-owned and operated enterprise...and, hopefully, they lived happily ever after.)

★ ★ ★

A couple of issues ago, I mentioned that BSW had been involved with the production of NBC's TV sitcom "Frasier." Eagle-eyed viewers of the show probably know that the console used by Boston's favorite expatriate is a Pacific Recorders & Engineering board, and the studio was inspired by the stunning KABC Los Angeles studios, redone last year (also featuring a PR&E console).

Jack Williams said the process began as far back as April of 1993. And if you can

Budding Radio Careers



The talkative team of Spencer Gross and Katy Cockrell made its national radio debut on Friday, October 14, during the last minutes of CBS Radio's *The Gil Gross Show*. The youngsters tagged along as their dads worked a full week of live broadcasts from CBS owned KNX(AM) and Los Angeles' *Westin Bonaventure*, during the recent NAB Radio Show.

Pictured l to r: Host Gil Gross, Katy Cockrell, Spencer Gross and producer Gregg Cockrell.

catch the original episode in reruns next summer, be sure to notice that the setup in the pilot episode gave way to the much more elegant, KABC-inspired one they use now. In fact, the setup used now is wired to work, and, said Jack, feeds the audio to the booth when tape is rolling.

★ ★ ★

And lastly, when I wrote about the Bayliss Media Roast, I mentioned it was at the Plaza Hotel. It had been for eight years, but the foundation chose the Waldorf-Astoria Hotel (a reason to visit Manhattan in and of itself) for Roast No. 9. Sorry about that.

One last item. The RAB reports that the combined national spot and local radio revenue was up 11 percent through the third quarter of this year compared to the same nine-month period in 1993. Growth was strong and consistent, said the RAB, with gains of 12 percent in national spot and 11 percent on the local front compared to 1993.



Westinghouse Electric Corp. named Bill Korn chairman and chief executive officer of Westinghouse Broadcasting (Group W). Korn succeeds Burt Stanier, who will continue as chairman and chief executive officer of The Knoll Group, a subsidiary of Westinghouse.



Lisa L. Hakim has been named director of finance, radio, Capital Cities/ABC Inc. Hakim had been associate director, administrative services business office.

Radio Advertising Bureau President Gary Fries announced Reed Bunzel will be joining the RAB as vice president of communications. Laura Morandin, who previously held the position of vice president communications becomes vice president of public affairs.

Bunzel's experience in radio includes stints at industry trade magazines, as well as the National Association of Broadcasters.

Now, Burk pushes the right buttons for clean, clear audio switching.



Get ready for unattended operation that doesn't hiccup when a source drops out. The Burk LX-1 Stereo Audio Selector offers 6 audio channels in a 1 rack unit switcher that's ideal for remote studio control and EBS operations. With individual channel control signals, main and loop outputs, plus line mixing, the LX-1 is the versatile choice for new studio designs.



The LX-1 will run loops around traditional alternatives like patch panels and relay switchers. With configurable line levels, 100 dB isolation, and common mode rejection that exceeds 110 dB, the LX-1 can actually improve your air chain quality. And the LX-1 is especially easy to interface with existing studios and a variety of remote control configurations, including those from Burk.



Place the Burk LX-1 in your audio chain and you're getting the best mix of features, reliability, and performance. All at a price that truly pushes the right buttons for the 90s. Stow the old patch cords away. And take the first step toward putting the LX-1 to work for you. Call Burk Technology at 1-800-255-8090

BURK
TECHNOLOGY

READERS FORUM

If you have comments for Radio World, call us at 800-336-3045 or send a letter to Readers Forum (Radio World, Box 1214, Falls Church, VA 22041 or MCI Mailbox #302-7776). All letters received become the property of Radio World, to be used at our discretion and as space permits.

Mic Update

Dear RW,

Your excellent article in the Aug. 10 issue of RW: "Coles Lip Mic Filters Out Noise" gives the impression that Wes Dooley's Audio Application is the sole importer to the US of Coles broadcast microphones.

Nothing could be further from the truth. I have been importing them for some time, offering both the 4104 lip mic and the 4038 studio ribbon from stock. I can personally vouch for the 4038—I have been using it on my sessions since 1960: from my Abbey Road days to the present!

To give equal time, you may publish my phone number: 212-865-3108.

Malcolm Addey
Radio/Computer marriage

Dear RW,

Judith Gross' comments on the marriage of radio and computers touch the tip of the iceberg. The ultimate realization of that integration will be far more dramatic than "aural radio reception" at your PC work station.

Through an internal "electronic umbilical cord," the computer can easily be made to function as a video display terminal for information provided by radio stations. Just that easily, we will provide radio with "visual" attributes, without having to wait out development of application-specific display devices attendant to services such as RBDS. This computer-display approach will allow broadcasters to disseminate fast-decay information to complement or supplement what is being said on the air.

Listeners for example, will be able to glance at a screen displaying road or weather conditions instead of waiting for a DJ to repeat information they missed.

The PC modem will interact with an online service operated by the radio station as a separate profit center and as a means to build direct relationships with listeners.

The integration of radio and computers is

Radio World

Vol. 18, No. 24

November 30, 1994

Editor-in-Chief.....Lucia Cobo
Managing Editor.....John Gatski
Associate Editor (News).....Thomas Pear
Associate Editor.....Whitney Pinion
Contributors.....Frank Beacham/N.Y.
Bruce Ingram, Pamela Watkins
Nancy Reist, Alan Haber
Technical Editor.....John Bisset
Technical Advisor.....Tom McGinley
Editor (International).....Alan Carter
Editor (Radio World Magazine).....Charles Taylor

Radio World (ISSN: 0274-8541) is published bi-weekly by Industrial Marketing Advisory Services, Inc., 5827 Columbia Pike, Suite 310, Falls Church, VA 22041. Phone: 703-998-7600. Fax: 703-998-2966. Second-class postage rates are paid at Falls Church VA 22046 and additional mailing offices. POSTMASTER: Send 3579 forms and address changes to Radio World, P.O. Box 1214, Falls Church VA 22041. REPRINTS: Reprints of all articles in this issue are available. Call or write Regan Deatherage, P.O. Box 1214, Falls Church, VA 22041; (703) 998-7600; Fax: (703) 998-2966. Copyright 1994 by Industrial Marketing Advisory Services, Inc. All rights reserved.

—PRINTED IN THE USA—

**Next Issue of
Radio World
December 14, 1994**

an idea whose time is long overdue, and the National Association of Broadcasters futures committee will spend its time wisely exploring the impact of such an obvious marriage.

Mark Dureneberger
CBS-Teleport
Eden Prairie, Minn.

A Fan of WOWO

Dear RW,

I have been following, with interest, the articles about the possible sale and downgrade of WOWO(AM)'s signal. As a former broadcaster and long-time DXer, I think it is criminal that the signals of so many of the "clears" have been rendered ineffective by the stacking of other nighttime signals on top of the once-dominant station.

In 1962, while on my first assignment with the Armed Forces Radio Nouasseur Air Base near Casablanca, Morocco, I could pick up WOWO on a small inexpensive radio. The signal was weak, but exceptionally clean without interference of any type. Other clears then heard by me were: WWL New Orleans, WLW Cincinnati, WSB Atlanta, one or two New York City stations whose calls I don't remember, WGY Schenectady, N.Y., and a Canadian station from Sackville, New Brunswick.

As an Iowan who cut his radio "teeth" working at local stations there during the mid-1950s, I often listened to WOWO, using its programming and air staff as examples to live up to. Listening to that station while working thousands of miles from home in North Africa was an absolute thrill. I wonder if any of the mentioned radio signals can be heard in Morocco today. I doubt it. And soon, you will not receive WOWO's nighttime signal in Iowa or most of Indiana if some persons have their way.

Norman D. Medland
Media Relations Officer
Oakland Army Base, Calif.

Stop the nonsense

Dear RW,

Your article, in the Oct. 5 issue, about KKLA-FM's trials at the hands of a Los Angeles electrical inspector brought to mind my visit to the L.A. Testing Lab back in the late 1970s, as a representative of my previous employer.

My employer at the time manufactured a certain product that required the L.A. Testing Lab's certification in order for it to be sold and used in the city (and county). I paid the lab a visit to provide them with certain information needed for the testing process. While being given a tour, I was quite surprised to see a brand new Ampex VTR (a VPR-2, if I correctly recall) on the floor, awaiting inspection. In answer to my question, I was told that the lab needed to make sure that the machine complied with its electrical safety codes. Perhaps one of your readers from the Los Angeles engineering community can corroborate this bit of ancient history, from their personal experience.

Most city/county electrical inspection departments are chartered with the author-

EASing Out of EBS

The FCC commission's unanimous decision to replace the current Emergency Broadcast System (EBS) with the Emergency Alert System is good news, if somewhat overdue.

After lingering in regulatory limbo for the better part of this year, the decision reflects the commission's desire to allow broadcasters to work within their budgets yet adhere to a better standard.

RW supports the intent of the decision to allow each individual marketplace to decide. The decision allows stations until 1996 to fully implement the new EAS (although sooner is allowed and encouraged).

And though some industry executives are calling the FCC's decision a "non-decision," RW disagrees. After spending many months in a concerted effort with industry to deal with complex economic, technological and even sociological issues (remember the field tests in Colorado and Baltimore? See RW, Aug. 11, 1993), the agency has written the rules broadly enough that stations can set up a relatively low-cost system that is still much more reliable than the current EBS.

Stations can spend as little as \$750 to upgrade to the new system. Those willing to spend more, especially FM stations gearing up for radio broadcast data service anyway, can buy a system that does things like turn on an RDS clock radio in the middle of the night.

EAS will feature a digital system architecture designed to allow broadcast, cable, satellite and other services to send and receive alerting information, as well as myriad other functions. Herein lie the possible trouble spots. Because the EAS allows for different systems to be used within a digital technology, the likelihood of compatibility problems increases.

As of this writing, the commission had not yet released the full text on the technical specs of its decision. The NAB has adopted a "wait-and-see" approach and will comment on the decision once the full text is released. Be that as it may, the NAB and the SBE should stand ready to help stations work through this transition.

A new emergency alerting system has been a long time coming. The FCC's decision should make for a quick and painless leap forward to a more efficient and important role for broadcasters during crisis situations.

—RW

ity to see to it that a building's electrical wiring and systems comply with local, state and national codes. If L.A. County's electrical inspection authority truly ends at the AC power receptacle, then it has been overstepping its bounds for some time. Perhaps your article will trigger some discussion at the L.A. SBE chapter meetings, and further actions by the stations to stop this nonsense.

Russell Murphy
The Family Channel

More on WOWO

Dear RW,

I wish to thank RW for the fine article you presented Nov. 2 "Group Opposes WOWO Downgrading." However, it failed to mention our mailing address which is:

The WOWO Listeners' Guild
P.O. Box 1183

Randolph, MA. 02368-1183

E-mail: pgeorge@lucy.wellesley.edu

I must also take exception to the Editorial in the same RW edition: "A Fighting Chance For AM." If the FCC does allow WLIB to go fulltime on 1190 kHz at the expense of WOWO's super signal, most likely there will be a literal "Fighting Chance." As WLIB gets a fulltime status and WOWO goes "local," many other "daytimers" east of the Mississippi will vie for nighttime authorization.

With all of those signals going fulltime you will have a real fight on your hands with 10, maybe even 15 stations causing a "noise level" which will rival any good regional channel.

Instead of hearing one solid signal every night, you will be treated to a dogfight of heterodynes, rendering the 1190 frequency useless. To paraphrase, once everything is said and done, there will be no turning back. So much for AM Improvement.

Sure, New York would get another nighttime signal, but anyone outside the "Big Apple" will have to scratch yet

another clean frequency off the list.

Once WOWO goes, the future of the 1190 frequency, and for that matter, the entire AM band will be etched in stone. Chances are other stations in major metropolitan areas will upstage radio operations with the misfortune of not existing in a big city.

Call it a domino effect, call it what you will, but the result will be the same: nobody will listen to a station in his or her own backyard that is laced with heterodynes in the program material. Don't say I didn't warn you.

Peter Q. George
The WOWO Listeners' Guild

Dear RW,

Your editorial in the Nov. 2 issue of RW could not be more thoughtless.

Should one assume that you have no problem with the full prostitution of the band for a buck? I do. WOWO and all other outlets of its type should be left as they are. I agree fully with Peter George of Randolph, Mass., that WOWO should be preserved.

Your position: "A Fighting Chance for AM" is hogwash.

I worked for Atlantic States Industries 30 years ago. A.S.I. was a group owner in New York City—part of McGovern/Guild, so I know New York radio.

WLIB is a niche player with a sister FM, which is also a niche player. So where is the need to compete?

Remember, AM daytimers were the ultra cash cows of the radio once upon a time. WLIB has its loyal following just as it is.

For this you condone destroying WOWO, an institution?

When AM broadcasters realize it is the software that matters, not the hardware, success will follow. For example, Rush Limbaugh is on AM and has done more to save the skin of AM people than any NAB committee.

Mike Graves
Newburyport, Mass.

Rackmountable Technics CD Players

SLPG340/RK1 PKG



*Cues to music / Peak program search
Fast access time / BSW custom rack kit*

Only \$159.95

SLPG440/RK1 PKG



*Cues to music / Peak program search
Headphone jack / Keypad select / Wireless remote
BSW custom rack kit*

Only \$174.95

Need We Say More?

*Order yours today! By calling 800-426-8434 or
FAX 800-231-7055*

Equipment Solutions To Keep You Number One

BSW[®]

BROADCAST SUPPLY WORLDWIDE

World Radio History
Circle (26) On Reader Service Card

Tape Prices Rise as Materials' Cost Soars

by Dee McVicker

NEW YORK Audio tape manufacturers are reeling from recent price increases of raw materials, which could lead to price increases of tape products across the board for radio stations.

At least one tape manufacturer, 3M, has already raised its prices 2.5 to 3.5 percent on nearly all its audio and video tape products because of new market demands for the petroleum-based materials used in tape manufacturing.

Price increases by manufacturers could affect all tape products, but open reel and

used in making tape. Cobalt, which is the material used in tape magnetic coating for cassette and open-reel tape, went up 67 percent; resins, which are used in the plastic cassette components, have risen 28 percent; aluminum, used for flanges on open-reel products, is up 21 percent; and polyester film, the substrate for magnetic tape, is up 7 percent.

Increased demand

The sharp rise in costs of raw materials is primarily due to a bust-and-boom economy. The materials used in tape manufacturing are also used to package and make

that time, but there have been tremendous manufacturing productivity improvements over that time." Running tape coaters at faster speeds and implementing control programs have increased tape yields over the past decade.

But given the maturity of tape manufacturing today, some tape manufacturers are forced to consider other cost-cutting alternatives. Peter Brinkman, national marketing manager for Maxell, said "All of a sudden it is clearly a seller's market (for resins), and so the prices are reflecting that."

Although Maxell is experiencing "significant strain" as a result of increased material costs, it has no plans yet to increase prices to the consumer. Maxell's strategy is to stabilize its pricing with tactical, sometimes bulk, purchases of raw materials.

"If conditions continue to change in the marketplace, pricing is something we (will) study very carefully," Brinkman said. "But at the moment, we are not making any adjustments in our pricing."

Other manufacturers, however, are having to consider increasing prices. "We're looking very closely at it," said Terry O'Kelly, director of sales and marketing for BASF, which could increase prices on many of its tape products "anywhere from 3 to 6 percent."

Ongoing concern

Kevin Kennedy of DIC Digital expressed concern that rising raw material costs could push prices up for his company's digital tape products, as did Fred Layn, product manager for Ampex's professional audio group.

"We have not raised our prices in five years. However, we are having to examine it very closely now," Layn said. Sony's Joe Tibensky, voiced the same concerns. "We have had similar pressures (to raise prices)," he said.

The end-users most likely to be affected by the price increase are the radio stations

that rely on tape almost exclusively for programming and production. "I suspect they will be hit the hardest and have the most complaints about it," said John Marino, who is with the National Association of Broadcasters (NAB).

Intensive tape

Jerry Jacob of KALW-FM, a predominantly tape-based public station in San Francisco, said he wouldn't be happy with a 2 to 5 percent hit on his annual budget for tape products. But, he said, "It's no different than the annual inflation clause in a union contract or any other price increase that you have to go through."

Jacob estimated his station spends less than \$10,000 a year on tape products for cassette, open reel and DAT in order to tape some 120 events off of satellite every week.

The price increase will not affect large station groups and program suppliers that utilize satellite and compact discs to supply programming.

According to Chris Washington of Infinity Broadcasting, a 2-5 percent increase of tape products across the board would barely affect his organization, given that Infinity delivers most of its programming by satellite and uses tape only as an archival medium.

TM Century's Tom Cusac, studio manager with the program supplier, said "We've gone more away from tape, so it affects us internally. For every single CD project we do there is an archive which exists in digital tape form as a backup. It would have affected us worse in previous years when our product was tape-based."

Although the predicted price increase isn't likely to change how most radio stations or syndicators produce and replay audio, it could encourage some to re-evaluate alternative media. The NAB's Marino said, "It will certainly provide incentive for broadcasters to look at the tapeless studios and digital workstations." 

Price increases by manufacturers could affect all tape products, but open reel and cassette are most likely to be hit the hardest.

cassette are most likely to be hit the hardest because of their reliance on the upward cost of cobalt.

On the rise

"The costs of raw materials that go into making audio and video tape products have been escalating for some time. Regrettably, we will have to pass some on to our customers," said Don Rushin, marketing director of 3M professional audio and video markets.

Prices did not increase for 3M's Digital Audio Tape (DAT) line, but price increases for its cobalt-dependent cassette tape and quarter-inch to two-inch open reel tapes went into effect Nov. 15, leading off what could be price increases by other tape manufacturers who are feeling similar pressures from high-cost commodities.

According to 3M, costs have increased markedly this year for virtually all materials

other industry goods. Recently, producers from a variety of industries have beefed up manufacturing after a sluggish economy, upping the demand for petroleum-based materials and depleting existing supplies, according to Jim Mooney of O.M. Group, a consumer and refiner of cobalt.

"The year-end supply of cobalt to the marketplace used to be 12,000 metric tons. And now it stands, in 1994, at approximately 3,500 metric tons," he said.

Audio tape manufacturers Maxell, DIC Digital, BASF, Sony and Ampex are feeling the impact of these new market demands to varying degrees. Previously, when confronted by a volatile commodities market, tape manufacturers have been able to offset increased material costs with increased manufacturing efficiencies.

"(3M) tape hasn't gone up for almost 14 years," Rushin said. "There have been raw material price increases obviously during

This is what you get.

You asked BEXT to build the best high-performance FM exciter, put it in a no-frills package, and bring it to you at the most competitive possible price. To guarantee that you get everything you deserve, we bring you the new LEX 25, backed by our two year warranty and 24-hour engineering hotline.

LEX 25
25 Watt FM Exciter
S/N: >80dB
THD: <0.03%
\$1,995

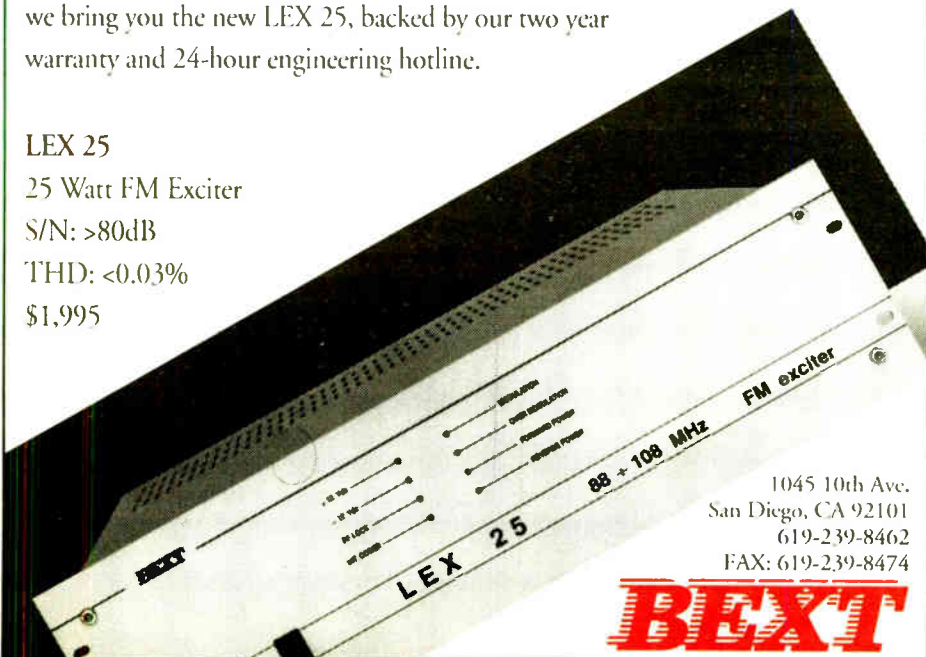

1045 10th Ave.
San Diego, CA 92101
619-239-8462
FAX: 619-239-8474

BEXT

Circle (50) On Reader Service Card

Your Problem Solvers

from **ATI**

- Matching • Monitoring
- Processing • Distribution
- Mike • Line • Phono • Mixing • Metering • Rack Mounting

AUDIO TECHNOLOGIES, INC.
328 Maple Avenue, Horsham, PA, 19044 • (215) 443-0330
FAX (215) 443-0394 • 800-959-0307



Circle (73) On Reader Service Card

Antenna Farm Exceeds ANSI Limits

► continued from page 1

of RF radiation and is, in and of itself, creating RF fields that exceed ANSI standards."

The letter, which also said that "certain of the FM broadcasters" on Black Mountain "when aggregated" also "emit RF radiation in excess of ANSI guidelines," noted that "if station KXTZ-FM is brought into compliance, the combined fields of those stations may not exceed ANSI standards."

Further, the letter informed the FCC that KXTZ-FM "has refused to bring its radiation pattern into compliance unless AMI bears the cost of purchasing and

installing a new antenna, an obligation that AMI is neither willing nor required by law or contract to undertake."

Sands, contract engineer for KXTZ-FM and other stations, KXTZ-FM has recently entered into an agreement with AMI

The commission has been aware of problems with RF levels on Black Mountain since 1991.

The admission in the letter that "AMI has attempted to work with KXTZ-FM to rectify this grave problem" turns out to have been prophetic. According to Joe

which will see replacement of the station's transmitter and antenna, probably by the end of the year (the new half wave spaced antenna, which produces less radi-

ation straight up and down, is the best way to solve the RF problem, according to Sands). Sands said that AMI is financing the project.

On April 28, 1992, a 30-day letter was sent by the Audio Services Division of the FCC's Mass Media Bureau requesting a statement of agreement between licensees and permittees on the Black Mountain site to comply with the FCC Office of Science and Technology (OST) Bulletin 65, "with regard to radio frequency radiation hazards affecting workers."

On the tower

(On March 8, 1993, San Francisco consulting engineering firm Hammett & Edison Inc. submitted a report to the commission that calculated on-tower power levels. On April 8, 1993, the FCC sent out a letter to licensees and permittees saying there was compliance with OST Bulletin 65 as far as on-tower levels were concerned.)

Next, the commission decided a ground level report was also needed. On May 12, 1993, a letter was sent to licensees and permittees requesting them "to further study the radio frequency radiation at ground level or any other accessible area at the Black Mountain site and submit a report detailing the procedures for ground level worker access in coordination with the on-tower procedures in order to confirm that the requirements specified in our letter dated April 8, 1993 are adequate to protect all persons having access to the site."

In the time that passed between the distribution of the April 28, 1992 letter and the March 8, 1993 Hammett & Edison report, Bob Greenberg, assistant chief of the FCC's FM Branch, said he "knew that conversations and meetings were taking place with all of the users (of the Black Mountain site), and also I knew that consulting engineers had been working together. So action was occurring. It's not like the commission didn't do anything—it was trying to give the broadcasters a chance to work this very difficult situation out."

Greenberg said that the FCC felt there was a breakdown in communication between the Black Mountain site users, which prompted a letter to them that was issued on Sept. 21 of this year. The letter gave licensees and permittees who had not satisfied the requirements of the FCC's May 12, 1993 letter 20 days "to submit a report detailing the procedures for ground level worker access in coordination with the on-tower procedures, in order to confirm that the requirements specified in our letter dated April 8, 1993, are adequate to protect all persons having access to the site."

The letter further stated that "No individual license or renewal authorizations will be granted until compliance with requirements of the letter has been reached."

According to Greenberg, Advanced MobileComm responded to the FCC on Oct. 10 of this year, on behalf of the licensees at the site, with a Hammett & Edison report (dated Oct. 4, 1993) that addressed the ground level radiation. Greenberg said that the commission is currently studying this report and added he hopes to arrive at a conclusion "shortly."

The Oct. 4, 1993, report, a copy of which was obtained by RW, concluded that "portions" of the Black Mountain site "exceed 1 mW/cm² when all of the stations at the site are operating at full power. In order to limit human exposure conditions at the site

continued on page 29 ►

The Dolby DSTL[®] has always been known for great specs.

Here's another.



If you shop for equipment by the numbers, there's one more you can't ignore: the new, competitive price of the Dolby Digital Studio Transmitter Link. You already know the DSTL can't be beat when it comes to performance. But the latest developments in its RF design let us lower prices without compromising its robust, interference-free operation and high quality audio.

Call us today to find out more at **800-DOLBY-RF** (365-2973). Our numbers will make both you and your bottom line happy.

*Suggested list price of the two channel system. Suggested list price of the four channel system including the optional digital stereo generator is \$14,900. Contact your local distributor for actual prices. For those of you who read the fine print, you'll be glad to know that you can order the two channel DSTL with our new AES/EBU digital input at no additional charge. It's also available to retrofit to existing 2-channel DSTL systems. We're doing our part to make the all-digital signal path a reality!

Dolby Laboratories Inc. • 100 Potrero Avenue, San Francisco, CA 94103-4813 • Telephone 415-558-0200 • Facsimile 415-863-1373
Dolby Laboratories Inc. • Wootton Bassett • Wiltshire SN4 8QJ • England • Telephone 0793-842100 • Facsimile 0793-842101 • Telex 44849
Dolby, DSTL and the double-D symbol are trademarks of Dolby Laboratories Licensing Corporation ©1994 Dolby Laboratories Inc. 594/10339



Circle (56) On Reader Service Card

World Radio History

LET'S TALK ABOUT
REDUCING THE PROBABILITY
OF HUMAN ERROR.

Perhaps the only thing simpler than operating a Pioneer 300 CD Autochanger is breathing. That's because the Autochanger stores 300 CDs, which can then be played remotely with the push of a button. And when people can't touch discs, they can't miscue, scratch, smudge, steal, doodle on or misfile them, either. Call 800-421-6450 for literature and a list of our systems integrators. However, you may feel that your employees are flawless and impervious to error. In which case, we recommend, not our Autochanger, but a shrink.





SYSTEM 12



SYSTEM 16



SYSTEM 20

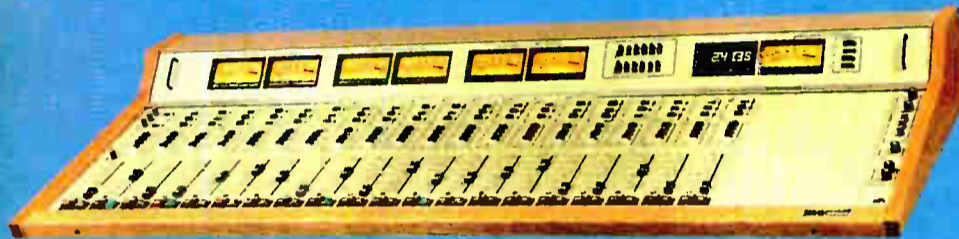

SYSTEM 24



SYSTEM 8

Broadcast Audio Series VI Dependable, Affordable, Practical

Broadcast Audio consoles sound great, are easy to use and employ proven reliable electronics for absolute dependability. What's more, they offer blue chip value at new economical list prices with an extended warranty.

Top quality construction is a hard and fast rule. Double-sided ground plane motherboards assure minimum noise and cross-talk as well as superior RFI immunity. Premium Penny & Giles faders are standard. VCA's are not used. Ribbon cables aren't used for audio signal paths. The no-nonsense design doesn't cut corners.

All mixer modules can be interchanged freely

because console logic is not programmed on the module and each module is switchable between mic and line levels. Mixers and output amplifiers can be removed or inserted with power on. Additional flexibility is provided by three stereo busses and a mono mix-minus bus which are standard in all units. In short, high-grade construction and audio performance are uncompromising.

Broadcast Audio consoles are installed in every one of the 50 states in the USA. During the past 13 years, over 1,400 consoles have been delivered and virtually every one remains in use today. A 5-year warranty is provided on all new units.

Call Fidelipac for the name of your authorized Broadcast Audio dealer.



Fidelipac Corporation □ P.O. Box 808 □ Moorestown, NJ 08057 U.S.A. □ TEL 609-235-3900 □ FAX 609-235-7779

Circle (103) On Reader Service Card
World Radio History

RFR Key Factor in Renewal Process

by Thomas Pear

WASHINGTON As the next wave of license renewals begins, stations may want to take RFR (radio frequency radiation) or RF regulations into close account.

Although the FCC says it only saw a couple of RF protests from the outside—the bulk of outside protests coming from EEO violations, programming concerns and other types of violations—about 10 to 15 percent of applications were deferred by the commission internally because of insufficient RF data, said Stuart Bedell, the assistant chief of the FCC's audio services division.

"For stations that haven't demonstrated compliance, the commission has held off all authorization grants including transfers of ownership," FCC FM Branch Assistant Chief Robert Greenberg said.

A lot of stations are not sure what the FCC is looking for when it comes to RF requirements, Bedell said, and noted that most of the deferrals came to stations that provided an insufficient amount of RF data to allow the FCC to determine whether or not the stations complied with RF rules.

In other words, Bedell said, the stations were not thorough enough in their RF descriptions, so the commission put their renewals on hold until sufficient data was supplied.

"For example," Bedell said, "someone with an AM station will say 'I am in compliance with the RF requirement because I have a fence.'"

But just having a fence does not put a station in compliance with RF regulations. "Depending on the power of the station and the height of the tower that fence has to be a certain distance from the base of the tower," Bedell said, adding that failure to provide that information would result in a license renewal deferment.

New RF regulations

Making matters worse for broadcasters, the FCC is developing a new set of RF regulations, now out for public discussion as a formal rulemaking proposal, based on the ANSI/IEEE C.95.1-1992 standard that could involve two separate sets of RF rules: one for the general public and another for industry workers.

Currently, the FCC standard is set at 1,000 mW/cm² for FM and for AM it is 614 volts per meter in term of electric fields and 1.58 amps per meter in terms of magnetic fields, noted FCC senior scientist Dr. Robert Cleveland.

Under the ANSI/IEEE proposal, for FM 1,000 mW/cm² would remain as the standard for a controlled environment, while the radiation level of 200 mW/cm² would become the new standard for an uncontrolled public environment, Cleveland said.

A controlled environment is defined as an environment that has restricted access. In many cases these environments are created by placing a fence around a radiating tower. Uncontrolled environments are environments open to the general public.

For AM, the standard for a controlled environment would be 614 volts per meter in terms of electric fields and 16.3 divided by the frequency in terms of magnetic

fields, according to Cleveland. For the uncontrolled environment, in terms of electric fields, the standard would be 614 volts per meter up to 1.34 MHz and above 1.34 MHz the standard would be 823.8 divided by the frequency. In terms of magnetic fields the standard would be 16.3 divided by the frequency, he said.

Even more troublesome to broadcasters is that if the ANSI/IEEE rules are adopted, for the first time RF regulations would include induced body currents and contact currents. They would regulate them up to 100 MHz, limiting a controlled area to 100 milliamps and an uncontrolled area to 45 milliamps.

"They (the proposed rules) can have a devastating effect," said Dane Ericksen, a senior engineer at the San Francisco engineering firm of Hammett and Edison. "I feel sorry for the stations that come up for renewal right after the effective date."

The first problem is that there are no devices for measuring contact currents above 30 MHz, Ericksen noted, and there are only prototypes for measuring body currents from 30 MHz and above.

"Hopefully they would not enforce induced body currents and contact currents until there are readily available measuring instruments," Ericksen said.

Then there is a question of fairness: why should stations 100 MHz and below be held to more stringent regulations than stations above 100 MHz?

The bottom line, however, is that the regulatory burden of having to prove compliance could severely impact the industry, and already, Cleveland has been inundated with about 4,000 pages of comments, many protesting ANSI/IEEE.

Also, as of yet, the FCC has not preempted any RF rules to prevent state and local governments from adding additional regulations of their own.

Throwing another monkey wrench into the FCC adopting the ANSI/IEEE proposals is that another set of RF guidelines is being worked out by the Environmental Protection Agency (EPA). Sources say the two large federal agencies do not want to appear to contradict each other.

Previous predictions that RF rule changes will come in the middle of next year, then, may still be a little premature.

"We don't know when and if these standards will be adopted," Cleveland said.

One thing, though, is for certain. The FCC will enforce whatever standards it adopts. In cases where you have multiple towers sitting in the same geographical locations like Mount Wilson near Los Angeles or Black Mountain near Las Vegas, the entire area would have to be in compliance with RF regulations for controlled environments, Greenberg noted.

Bedell and Greenberg recommend that stations consult an engineer before filing a license renewal.

"People who are at sites like that are strongly encouraged to use a consulting engineer," Bedell said.

Despite the fact that RF regulations are getting tougher and more complicated, there is a bright spot. Bedell noted that the FCC is creating user friendly license renewal applications (See RW Nov. 16),

and as part of the "user friendly" applications a special RF checkoff sheet is being developed to help station managers and engineers determine if they have provided all of the necessary RF information.

Just trying to help

"We are in the process of putting that together now," Bedell said.

"What we are trying to do with this worksheet is basically help general management and station engineers determine whether they have a problem at their station," Greenberg said. "In the past we did not get the information we needed to do an accurate, timely and rapid turnaround

on the renewals."

As new RF standards are adopted, the worksheet, which is still subject to commission approval, would be made relevant to the new regulations, hopefully, simplifying compliance.

Also, Bedell said that if the RF rules are changed in the middle of the renewal process, creating the two-tier approach to radiation levels, the new rules would not be enforced retroactively. Stations with FCC approval for an overall radiation level of 1,000 mW/cm² would not immediately have to protect the radiation level outside the immediate area of their tower to 200 mW/cm².

However, stations would have to be in compliance with the new RF rules in order to be granted FCC permission for amending their facilities, Bedell said.

Failure to provide the necessary RF information will result in a license renewal deferment.

WELCOME TO THE DIGITAL WORLD OF DIGILINK

- Replace cart machines live On Air while adding walkaway CD, Satellite, or Tape automation
- On Air Base Price starts under \$8,000
- 8 Track Editor base price starts under \$5,500
- Smallest systems start at 10 hours stereo audio storage (20 hours mono)
- Network more than 15 Digilink workstations

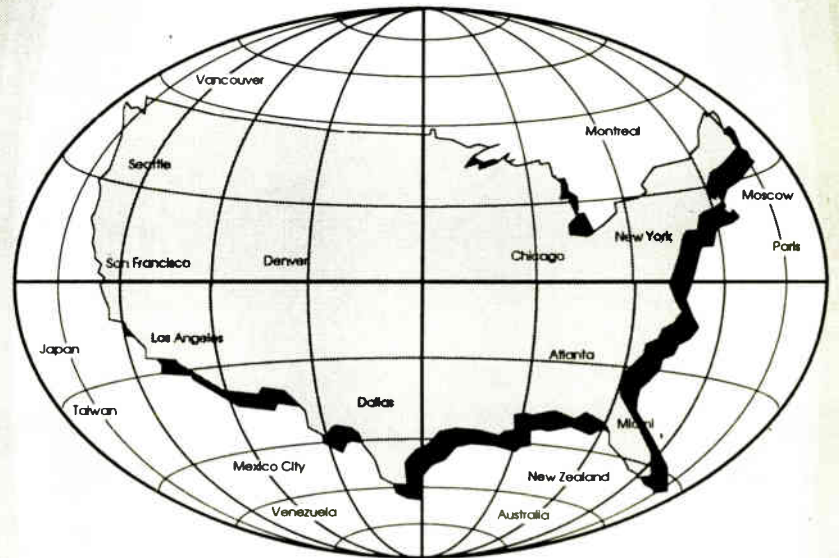

With over 500 workstations sold worldwide in the last 18 months and more than 400 of those workstations sold in the U.S.A, it is little wonder that Digilink is the #1 choice for a digital audio hard disk workstation for professional radio broadcasting. Whether for On Air, Production, News, or Automation... Digilink does it ALL.

For more information about the #1 selling digital audio workstation for Radio, call or write...

303-224-2248

ARRAKIS

© 1993 Arrakis Systems inc. 2619 Midpoint Drive, Fort Collins, CO. 80525

Circle (146) On Reader Service Card

RBDS ROLL CALL

The following is **Radio World's** quarterly listing of RBDS stations, equipment and receiver manufacturers, and service providers. If you would like to be included in the next listing, contact John Gatski at 703-998-7600.

RBDS Equipment Manufacturers/Distributors

AEV (Encoder)

Via Saviolo I/E
40017 Le Budrie
Di S. G. Perisceto
Bologna, Italy
+39-51-95-02-49

Bradley Broadcast (Encoder)

8101 Cessna Avenue
Gaithersburg, Maryland 20979
Contact: Art Reed
800-732-7665

Broadcast Electronics (Encoder)

4100 North 24th St.
P.O. Box 3606
Quincy, Illinois 62305
Contact: David White
217-224-9600

Broadcast Supply Worldwide (Encoder)

7012 27th St. West
Tacoma, Washington 98406
Contact: Tim Schweigert
800-838-0110

Circuit Research Labs (Encoder)

2522 W. Geneva
Tempe, Arizona 85282
Contact: William Ammons
800-535-7648
Reader Service 87



Harris Allied (Encoder)

3712 National Road West
Richmond, Indiana 47374
Contact: Scott Beeler
800-622-0022

Modulation Sciences (Encoder/Monitor)

12A World's Fair Drive
Somerset, New Jersey 08873
Contact: Art Constantine
908-302-3090
Reader Service 116

**modulation
sciences**

RDS Diagnostix (Test/Decoder)

74 Hanover Road
Mountain Lakes, New Jersey 07046
Contact: Boyd Baker
201-334-7858

RE America, Inc. (Encoder)

31029 Center Ridge Road
Westlake, Ohio 44145
Contact: John Casey
216-871-7617
Reader Service 94



Rohde and Schwarz (Encoder)

4425 Nicole Drive
Lanham, Maryland 20706
Contact: David Stephenson
301-459-8800

SCA Data Systems (Encoder)

Suite 350, 225 Arizona Avenue
Santa Monica, California 90401
Contact: Corinne Weber
310-576-0655

Teli AB (Encoder)

14980 Nunashamn
Sweden
Contact: Marc Roman
+46-8749-6600

Tectan (Encoder)

Box 27157
Concord, California 94527
Contact: Judy Pendleton
800-TECTAN-1

Reader Service 155



VG Electronics (Encoder)

Theaklen Drive Hastings
East Sussex TN34 1YQ
England
Contact: Bev Marks
+44-424-446888

RBDS Receiver Manufacturers (with current U.S. models)

Advanced Digital Systems (PC RDS Receiver)

13909 Bettencourt Street
Cerritos, CA 90701
Contact: Mike McCoy
800-888-5244
Reader Service 109



Axxess (Paging)

6620 Riverside Drive
Suite 200
Metairie, Louisiana 70003
Contact: Bobby Adams
504-887-9800

Delco (Car)

1 Corporate Center
Mail Station CT-16A
Kokomo, Indiana 46904
Contact: Gil Porter
317-451-0658

Denon (Car/Home)

222 New Road
Parsippany, New Jersey 07054
Contact: Stephen Baker
201-575-7810
Reader Service 57

DENON

Grundig (Portable)

3520 Haven Ave., Unit L
Redwood City, California 94063
Contact: Dan Johnson
415-361-1611

Modulation Sciences (Data)

12A World's Fair Drive
Somerset, New Jersey 08873
Contact: Art Constantine
908-302-3090

Onkyo (Home)

200 Williams Drive
Ramsey, New Jersey 07446
Contact: Fred Maxik
201-825-7950

Philips Car Stereo (Car)

9600 54th Avenue N.
Minneapolis, Minnesota 55442
Contact: Bob Trench
800-524-6638

Pioneer (Car)

2265 East 220th St.
Long Beach, California 90810
Contact: Ed Sachs
800-PIONEER

RBDS Service Providers

Axxess/Spartan (Paging)

6620 Riverside Drive, Suite 200
Metairie, Louisiana 70003
Contact: Bobby Adams
504-889-9800

DCI (Global Positioning)

20045 Stevens Creek Boulevard, Suite 2A
Cupertino, California 95014
Contact: Ron Haley
408-446-8350
Reader Service 202



Coupon Radio (Information Services)

10 Rockefeller Plaza
New York, New York 10020
Contact: David Alwadish
212-595-1313
Reader Service 164



Sage Alerting (EBS)

700 Canal Street
Stamford, Connecticut
Contact: Gerry Lebow
203-357-1464

SATX (Data Broadcast Software)

Milestone Technologies
2221 Mariner Circle, Raleigh, North Carolina 27603
Contact: Miles Beam
919-856-0700

Specialized Communications (Music Information)

1638 153rd St. SE
Bellevue, Washington 98007
Contact: Allen Hartle
206-641-9043
Reader Service 180



Terrapin (IVHS Services/Diff-GPS)

11958 Monarch Street
Garden Grove, California 92641
Contact: David Kelley
714-898-8200

If you would like to feature your company's logo and information on the RBDS Roll Call page, contact your Radio World sales rep.

RBDS Stations

Station	Frequency	City	WBHF-FM	94.5	Triumphant	WGLT-FM	91.1	Delaware	WTTN-FM	93.7	Triumphant
ALABAMA			WZYP-FM	104.3	Athens	WZLX-FM	93.7	Atlanta			
ARIZONA			KRR-FM	92.3	Phoenix	KSLX-FM	100.7	Scottsdale			
CALIFORNIA			KSIO-FM	96.1	Brawley	KLON-FM	88.1	Long Beach			
COLORADO			KMJJ-FM	100.3	Denver	KCFR-FM	90.1	Denver			
CONNECTICUT			WVHF-FM	91.1	Hartford	WVKT-FM	91.5	Hartford			
DISTRICT OF COLUMBIA			WAMJ-FM	88.5	Washington	WETA-FM	90.2	Washington			
FLORIDA			WQUN-FM	91.5	Dunedin	WFLZ-FM	93.3	Orlando			
GEORGIA			WATL-FM	93.1	Atlanta	WABL-FM	90.1	Atlanta			
ILLINOIS			WCIL-FM	101.5	Carbondale	WDRW-FM	94.5	Chicago			
INDIANA			WTVW-FM	99.7	Frankfort	WKEK-FM	103.9	Fort Wayne			
IOWA			KVIR-FM	100.5	Des Moines	KFAG-FM	104.3	Des Moines			
LOUISIANA			WGGZ-FM	98.1	Baton Rouge	KFXV-FM	96.7	Monroe			
MASSACHUSETTS			WBUR-FM	90.9	Boston	WGBH-FM	89.7	Boston			
MARYLAND			WVHF-FM	99.3	Annapolis	WFAA-FM	88.9	Baltimore			
MICHIGAN			WIOG-FM	102.5	Bay City	WLLZ-FM	98.7	Detroit			
MINNESOTA			KHEM-FM	88.5	Minneapolis	KNOW-FM	91.1	St. Paul			
MISSOURI			KYYS-FM	102.3	Kansas City						
NEBRASKA			KESY-FM	104.5	Omaha						
NEVADA			KKLZ-FM	96.3	Las Vegas	KNPR-FM	89.5	Las Vegas			
NEW JERSEY			WJCL-FM	96.9	Atlantic City						

A cast of performers.

For more than 20 years, Inovonics has met the everyday needs of broadcasters the world over with sensible, top-quality broadcast products at down-to-earth prices.



222 Asymmetrical AM Low-pass Processor

Guarantees U.S. NRSC compliance, or is available in several versions for international shortwave service.

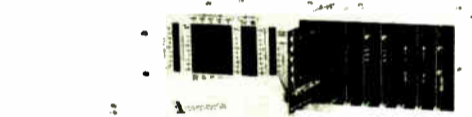

250 Programmable 5-band Stereo Processor

Gated AGC, 5-band Compression and EQ, split-spectrum Limiting—all with colorless PWM gain control. Manually pre-program 4 processing presets, or place entirely under computer/modem control via RS-232 bus.

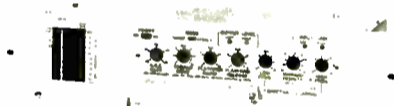

255 "Spectral Loading" FM Processor

Triband-PWM Stereo Processor for contemporary music formats. Gated AGC, 3-band Compression and Limiting; unique "Spectral Loading" feature for a very aggressive sound.



260 Multifunction FM/TV Processor

Stereo AGC - Compressor - Limiter ideal for TV-aural and budget FMs. Split-spectrum dynamic control.

715 "DAVID" FM Processor / Stereo-Gen.

AGC - Compressor - Limiter, plus clean Digital Synthesis of the multiplex baseband signal. Internal RBDS/SCA combining; amazing performance at low cost!

705 & 706 Digital Synthesis Stereo Generators

Choice of a no-frills, basic Stereo-Gen., or a full-featured unit with metering and remote control. Both have patented overshoot compensation and a clean sound.

530 Off-Air FM Modulation Monitor

Tunable Mod-Monitor gives accurate measurement of total mod., pilot injection, stereo separation, etc. The peak flasher, metering and alarms may be removed.

550 The "Sentinel" Monitor Receiver

All-mode radio tunes AMAX-spec C-QUAM® Stereo, FM/FMX® Stereo and all analog and digital RBDS/SCA sub-carriers. Comprehensive audio diagnostics permit off-air evaluation, comparison and analysis.



Coming soon: An easy-to-use RBDS Encoder, and a Monitor/Decoder for use with any FM Mod-Monitor.

Inovonics, Inc.

1305 Fair Ave., Santa Cruz, CA 95060 • TEL: (408)458-0552 • FAX: (408)458-0554



Circle (80) On Reader Service Card



Where can you get a feel for digital audio production?

Now's the time to get your hands on SoundLink —the first Random Access Digital Audio Multi-Track system with all the critical functions you need at a price you can live with.

An all-in-one system, SoundLink provides hard disk recording, mixing, non-destructive editing, signal processing and MIDI recording in one comprehensive and affordable package.

If you want a whole new feeling about digital audio production, please call Korg Professional Audio at 800-645-3188 Ext: 280.
In NY, call 516-333-9100.

SoundLink™
KORG
Professional Audio

Studio Sessions

Equipment and Applications for Radio Production and Recording

Mackie's 1202

Rates a
'Best Buy'
See p. 18

PRODUCT EVALUATION

Desk-size Digital Mixer from Yamaha

by Ty Ford

BALTIMORE Three days after delivering the Yamaha ProMix 01, my UPS guy (who also produces some very nice music for a living) knocked on my door. I noticed he had nothing for me and because I didn't have anything for him I said, "What's Up?" He said, "So how's the Yamaha mixer?" Eight years of deliveries several times a week and he has never shown up empty-handed at my door with questions about a piece of gear—except for the Yamaha ProMix. Now that's street buzz.

For a list price of \$2,000, Yamaha has loaded an impressive amount of technology into the ProMix 01. The list includes 20-bit A/D converters for the inputs, 24-bit internal processing, 36-bit internal EQ processing, 20-bit 8x stereo outputs and 18-bit 8x monitor outputs. The internal sample rate is fixed at 48 kHz, there are no digital inputs and only one digital output, a SP/DIF from the main outs. Throughput delay from input to stereo output is 3.5 milliseconds.

The ProMix 01 includes global +48VDC phantom power on balanced XLR inputs 1 through 8. Inputs 9 through 16 are balanced TRS. All 16 inputs have a 20 dB

pad and a -16 dB to -60 dB input trim control. The mic preamps sound good and are reasonably quiet.

There are two other analog auxiliary inputs on the console's backplate: a pair of stereo RCA-style, unbalanced -10 dB called "2TR IN" and a 1/4" unbalanced +4 dB pair called Stereo IN. They are connected so that when no plugs are inserted in the ST IN jacks, the 2TR IN signals are fed through the Stereo Input Channel with

dedicated input fader. The phase and pan of all 16 inputs and the ST IN are individually adjustable, with the exception that phase adjustments to the ST IN apply to both channels.

The headphone circuit is powerful enough to push a pair of AKG K-240s to above-average

levels in a studio. More efficient phones may be needed for live mixing.

The ProMix 01 doesn't have direct outs from channel inputs. If you're used to using them for laying up tracks more than two at a time, you'll have to send two pre-fader through Send 3 and Send 4 and two more through the main or monitor outs. This configuration means it's tough to build a real mix while you're laying up tracks.

Wisely, Yamaha chose to include a bank

of 20 dedicated function buttons to the left of the large LCD display. Four of these buttons help you store, recall and navigate the Scene Memory directory in which you can store 50 snapshots of all mix settings. The other 16 take you directly to metering, pan, phase, dynamics, cue, effects, send and EQ screens.

Metering is viewed by hitting the dedicated metering button. The LCD display becomes a multitrack metering panel with channels 1-16 on one page and ST IN, sends and returns on the other. There is also a stereo 12-segment LED output meter visible at all times. Peak hold is available for all meters. Because input metering is pre-EQ, special attention must be given to any EQ settings that boost any frequencies, should they push the channel into distortion.

The ProMix also has two separate stereo-

return, SPX-like digital effects devices, each with 30 preset programs with adjustable parameters and room for 19 of your own programs. There are 24 three-band parametric EQ sections counting 16 inputs, both of the first two effect sends, before the analog stereo out and before the analog stereo in. The EQ section has 30 presets and 19 user-savable settings.

All 24 EQ modules are the same, offering three band +/-15 dB digital parametric EQ with selectable "Q" at 1/6, 1/4, 1/3, 1/2, 3/4, 1, 1.5, 2 and 3 octave width, as well as shelving for the top and bottom bands. Frequency ranges of the three bands (LF: 32 Hz-1 kHz, MF: 32 Hz-18 kHz, HF: 1 kHz-18 kHz) are well chosen.

You also get a graphic representation of your EQ adjustments in the LCD window as you adjust the EQ, and you can save and name 19 of your most frequently used curves along with 30 presets. The only downside of the parametric EQ is that, unlike analog parametric EQ which sweeps continuously across the frequencies, the

continued on page 19 ▶



Yamaha ProMix 01

HERE'S WHAT A DIGITAL AUDIO DELIVERY SYSTEM CAN DO FOR YOU!

CHECK ALL THE FEATURES REQUIRED THEN CALL YOUR DAD486x DEALER

- | YES | NO | | YES | NO | |
|--------------------------|--------------------------|---|--------------------------|--------------------------|---|
| <input type="checkbox"/> | <input type="checkbox"/> | Powerful Live Assist Touchscreen flexibility, unlimited Automation capabilities, as well as interface to any Satellite Programming service, and the ability to seamlessly switch between them at any time. | <input type="checkbox"/> | <input type="checkbox"/> | Multiple Inputs & Outputs, both Analog & Digital . |
| <input type="checkbox"/> | <input type="checkbox"/> | "Racks Full" of Recorders and Reproducers , as well as huge "Cart Walls" with immediate random access to any Cut . | <input type="checkbox"/> | <input type="checkbox"/> | Intersperse Mono & Stereo Cuts without operator intervention. Simulcast with independent Spot & ID loads. |
| <input type="checkbox"/> | <input type="checkbox"/> | Sound "Live" in any mode, with layers of programmable Fades , Segues , and Voice Overs . | <input type="checkbox"/> | <input type="checkbox"/> | Interface with other common studio equipment such as Consoles, Switchers, CD Players, DAT's, Tape Machines, etc. |
| <input type="checkbox"/> | <input type="checkbox"/> | Display Script , Copy , or News Text for paperless operations. | <input type="checkbox"/> | <input type="checkbox"/> | A comprehensive Security System , limiting access to sensitive operations on a per User basis. |
| <input type="checkbox"/> | <input type="checkbox"/> | Automatically control multiple Network Joins and Breaks, as well as Time Shift any elements. | <input type="checkbox"/> | <input type="checkbox"/> | Operate on common Off The Shelf Hardware that can be purchased and maintained via local sources, requires no special training, and can easily be upgraded as computer technology continues to advance. |
| <input type="checkbox"/> | <input type="checkbox"/> | Advanced Production features such as Cut & Paste Editing , and Montage Assembly . Interchange digital files with many Multitrack Editing systems. | <input type="checkbox"/> | <input type="checkbox"/> | Configurable with Backup and Redundancy features for fail safe operation and data protection. |
| <input type="checkbox"/> | <input type="checkbox"/> | Interface with all common Scheduling and Billing systems, or be able to roll your own. | <input type="checkbox"/> | <input type="checkbox"/> | Offer the same Power and Flexibility whether configured as a small stand alone Workstation or expanded to a large multi-user networked system. |
| <input type="checkbox"/> | <input type="checkbox"/> | Each User can optimize, store, and immediately recall their own preferred layout and functionality. | <input type="checkbox"/> | <input type="checkbox"/> | So Simple and Intuitive to use that the Learning Curve for most operators is measured in Minutes . |

ONLY THE ENCO DAD486x DOES IT ALL
COST EFFECTIVELY - NO LICENSING FEES

For more information call 800-ENCO-SYS or 810-476-5711

Fax: 810-476-5712

ENCO
SYSTEMS, INC.

ENCO Systems, Inc.
24403 Halsted Road
Farmington Hills, MI 48335 USA

Do You Want A Better Sounding Station?

CRL CAN HELP YOU. No matter the size of your station or the size of your budget, we have an engineered solution for you.

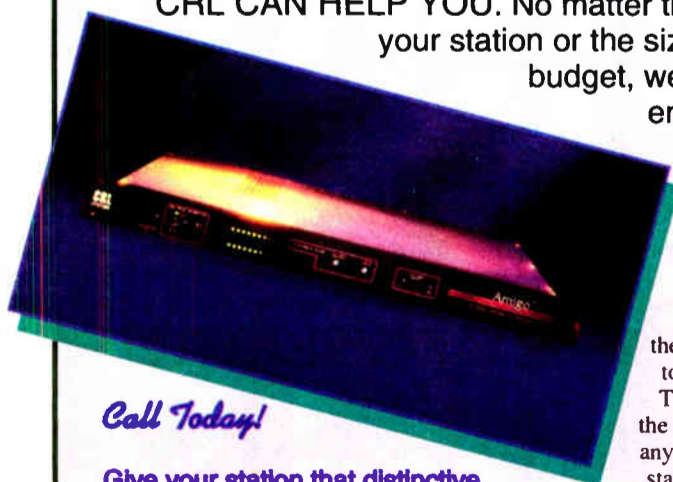

Amigo FM. Feature by feature the Amigo offers the best value in today's market. The Amigo has the ability to give any station a "big station" sound at half the cost of typical FM processors.

Call Today!

Give your station that distinctive sound you need to build bigger audiences.



Circuit Research Labs, Inc.
(602) 438-0888
FAX (602) 438-8227

SIGNAL-TO-NOISE

New Crop of PDAs Useful Audio Tools

by Frank Beacham

NEW YORK Forget what you've heard in the past about personal digital assistants, or PDAs, as this category of hand-held computing devices is called. In my opinion, Apple's Newton, Tandy's Zoomer and AT&T's now defunct EO failed because they represented technology for technology's sake, rather than technology to serve a human need.

Sony's just-released 1.2-pound Magic Link Personal Intelligent Communicator and Motorola's about-to-be-released Envoy Personal Wireless Communicator represent the next generation in portable

computing. This time, the machines have a purpose and should be of major interest to audio professionals, broadcasters and news reporters who work in the field.

Both machines are based on General Magic's intuitive Magic Cap platform and Telescript communications language. They both offer a combination of intelligent messaging capabilities that integrate electronic mail, fax, telephone, on-line services and nationwide paging.

The Sony specializes in wireline communications while the more expensive Motorola incorporates two-way wireless messaging capabilities.

Both connect to AT&T's new PersonalLink

Services network, the first commercial service that enables subscribers to perform many routine communications activities with the help of electronic "intelligent assistants." These assistants, or agents, are mobile programs that go to places in the network to carry out their owners' instructions. Software for America Online, the computer service, is also built into ROM on both machines.

By plugging in a phone line to the modular jack and touching an icon on the screen of Sony's Magic Link, a user can easily access electronic mail from either PersonaLink or America Online. PersonaLink users have the option of sending

and receiving messages that include text, animation, brief voice recordings, music and electronic handwriting.

Reporters who want to file a script from the field can use the optional keyboard or built-in, on-screen touch keyboard for text entry or they can write a story by hand in "electronic ink." The document can then be faxed or e-mailed within seconds to one or more locations anywhere in the world.

Though these devices forgo the troubled handwriting recognition programs of the early PDAs, a new optional software application called Graffiti is available that will translate handwritten documents.

The Sony Magic Link, available now at a base price of \$995, includes an integrated 9600 bps fax and 2400 bps data modem. It can also accept an optional pager card that can receive wireless messages via the SkyTel network. The Motorola Envoy, due by year's end at a price of approximately \$1500, includes a two-way wireless packet data modem as well as a wireline fax modem. The Envoy's wireless



Sony's Magic Link

Owning a Real Neumann Just Got a Lot Easier

You've put a lot of money into your studio... expensive consoles, recorders, processing, etc. But your recordings just don't measure up to your expectations. Chances are, the problem is with the most important (and most often overlooked) part of your signal chain... the microphones.

Virtually every major recording produced during the last 50 years has utilized Neumann microphones on vocals and critical tracks. And with good reason. Neumann microphones sound better. The warmth. The texture. The velvety smooth richness that cannot be duplicated. It's called the "Neumann Sound."

The TLM 193 is a large diaphragm cardioid condenser microphone with state-of-the-art specifications. Frequency response of 20Hz to 20kHz, dynamic range of 130dB, self noise of 10dB-A, and maximum SPL of 140dB.

Mics like the U 47, U 67, U 87, and the TLM 170 are legends in the industry. Now, with the TLM 193, you can have Neumann performance in the classic tradition for less than \$1300 us!

Make your next recording a classic. Use Neumann... the choice of those who can hear the difference.

Introducing the TLM 193
Large-Diaphragm Condenser Microphone



Neumann USA

6 Vista Drive, PO Box 987 • Old Lyme, CT 06371

Tel: 203.434.5220 • FAX: 203.434.3148

West Coast Tel: 818.845.8815 • FAX: 818.845.7140

Neumann Canada

221 LaBrosse Ave., Pointe-Claire, Quebec H9R 1A3

Tel: 514.426.3013 • FAX: 514.426.2979



communication is through RadioMail, a message routing service that is connected via the ARDIS nationwide data network. ARDIS serves more than 400 metropolitan areas of the U.S.

The user interface for both machines is extraordinarily easy to master. The Magic Cap software employs a familiar desktop metaphor, using icons such as card files, date books, telephones, notepad, file cabinets and in/out boxes. Once loaded with personal information, these devices pack a lot of communications power and convenience for those who are traveling or working on location.

In coming months the new breed of communicators will even offer field research capabilities. Mead Data Central has two new LEXIS/NEXIS products on PersonaLink. One is a daily news summary now delivered free to subscribers each morning. By year end a service called Immediate Answers will be offered that delivers information from more than 2,300 full-text news and business information sources.

The debut of Magic Cap and Telescript is, for now, limited to Sony and Motorola's new portable PDAs. Soon, however, both of these software innovations will be available for desktop PC and Macintosh computers as well as a broader line of personal devices. In the near future, don't be surprised to see Magic Cap as the controlling software of "smart" television sets that use personal agents to search hundreds of channels of program choices. And, with additional memory, devices such as the Sony and Motorola PDA could deliver high-quality audio feeds along with text from the field to the studio, said Kevin Lynch, manager of the Magic Cap Core Technology Group.

□ □ □

Frank Beacham is a writer, director and producer. His address is 163 Amsterdam Ave. #361, New York, NY 10023. E-Mail: beacham@radiomail.net.

Now at more than 90% of the leading major market stations... thank you.



PR&E consoles... for broadcasters who place a high priority on reliability, features, performance and ease of use.



Pacific Recorders & Engineering Corporation
2070 Las Palmas Drive, Carlsbad, CA 92009
Tel: 619-438-3911 Fax: 619-438-9277 GSA: GS-03F-4064B

DESIGNS THAT MAKE THE DIFFERENCE

Circle (120) On Reader Service Card
World Radio History

PRODUCT EVALUATION

Best Buy Mackie Excels On Remote and in Studio

by Frank Beacham

NEW YORK Having used a Mackie MicroSeries (MS) 1202 mixer over the past year, I can say without equivocation that it has become a valued and trusted friend, a sort of audio Swiss Army knife that continues to surprise me with its utility.

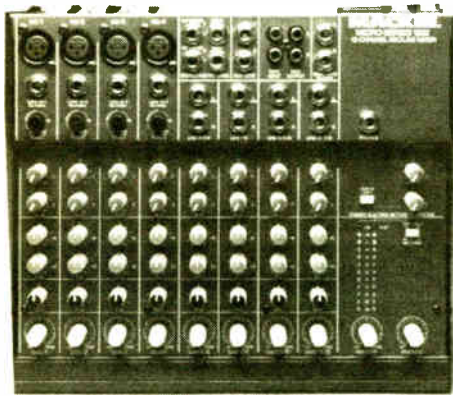

Mackie 1202

At a list price of \$399 and a street price usually more than 25 percent less, one's first impression of this little 12x2 mixer is usually amazement. It's as solid as a rock and far more rugged than expected

in its all-steel case. The pots and connectors have that silken feel of quality components. And the thing's got bulk, weighing a hefty seven pounds.

Almost everyone asks the question: How can it cost so little when everything else in pro audio is so expensive? The best part comes, however, in discovering just how versatile this compact mixer really is. In a footprint that is less than one square foot, the MS 1202 offers 20 inputs, any of which can work with any level ranging from musical instrument to semi-pro -10, to professional +4. It has four mono channels with each featuring +48 volt phantom mic power through balanced Neutrik XLR input connectors, four stereo channels (each with separate left and right line inputs) and main and aux outputs for stage monitoring, effects and recording.

Features

The 1202 has two aux sends per channel with a center detent for unity gain. There are stereo aux returns with separate left and right inputs and 20 dB gain for effects, tape recorder, extra line inputs, etc. Tape recorder input and output is available through RCA phono connectors. Channel inserts on the rear panel

allow both uninterrupted and interrupted direct outputs as well as pre-fader and post-fader effect loop channel patching for outboard devices such as limiters or compressors. There's EQ at 80 Hz and 12.5 kHz, three-way, 12 LED VU meters and a very clean headphone amp with plenty of gain. Power is supplied via a heavy duty three-conductor, detachable cable. No wall-wart here.

Even with all its features the 1202's biggest strength may be its excellent

think of it, that goes for about any product I can think of.) Not only does the booklet tell what you need to know in plain, simple language with helpful illustrations, but it's written with style and humor. The manual really gives you a warm and fuzzy feeling about the people at Mackie.

Numerous uses

Because of its quality and utility, the 1202 is a highly personal mixer that can provide dozens of uses for its owner. More commercial recordings have been made with it than you can count. Radio stations use it on and off the air, especially for remotes, and Mackie's client list for the 1202 includes names ranging from corporate giants like CBS, AT&T, Sony, Philips, IBM to entertainers like the Gatlin Brothers and "Click & Clack," the Car Talk brothers on National Public Radio.

In a recent ad, Mackie even recommends a commercial recording that demonstrates the sound of the MS 1202's mic preamps. It is a CD by acoustic guitarist Edward Gerhard titled "Luna," on the Virtue label (VRD 1921). According to Mackie, it was recorded direct to DAT via a MS 1202 and a stereo pair of Neumann KM 140 microphones.

Some pro audio folks may think the unit could not be that good for the price. The price defies logic and past experience. How can a \$399 mixer be good enough for digital recording? I don't know. It's just one of life's mysteries. But get past

continued on page 33 ►

Product Capsule: Mackie Micro Series 1202



Thumbs Up

- ✓ outstanding audio
- ✓ sturdy construction
- ✓ versatile features



Thumbs Down

- ✓ only runs on AC

For more information, circle **Reader Service 92** or contact Mackie at 800-898-3211.

sonic quality. For such a low price, one does not expect top level performance. But this mixer delivers it. The 1202 has a working signal-to-noise ratio of 90 dB, distortion below 0.009 percent across the entire audio spectrum and 116 dB internal dynamic range. The mic preamps are top notch: -129 dBm @ 150 ohms, and a virtually flat 20 Hz-20 kHz frequency response.

Learning the mixer's functions is a piece of cake, thanks to an outstanding owner's manual. Hands down it is the best written and illustrated manual I've ever read for an audio product. (Come to

Wouldn't it be great if all of your microphones were wireless?



Now they can be!



LECTROSONICS, INC.

581 Laser Rd., Rio Rancho, NM 87124 USA
FAX: (505) 892-6243

Call for more information:
(800) 821-1121

Ask for a free copy of the Wireless Guide

Desk-Size Digital Mixer from Yamaha

► continued from page 15

ProMix 01 doesn't sweep, it steps. If you can't get the center frequency you need, you have to work around it.

There are three stereo dynamics processors that can be used as compressors/limiters, gates or duckers, but only one at a time per dynamics processor. You cannot split the stereo channels and operate them as two independent channels. They can be assigned, one to a channel (or pair of channels), to any of the inputs after the EQ, pre- or post-fader for send 3 and send 4, or the stereo outputs. Specs for the three dynamics modules are identical and are as follows: compressor/limiter threshold: -40 dB to +18 dB, ratio: 1:1 to infinity, in nine selectable increments, attack: 0 to 120 milliseconds, release: 0.1 seconds to 6 seconds and output gain: +/-18 dB.

The gate and ducker work extremely well. Specs are: threshold -50 dB to +10 dB, attack: up to

120 milliseconds, hold: 3 milliseconds to 341 milliseconds, decay: 85 milliseconds to 10.9 seconds and range: -80 dB to 0 dB.

However, don't toss out your existing compressors or limiters. I was never happy with the compressor and limiter settings. Even modest settings of 9 ms attack, 1.0 second release, a 2:1 ratio with a +12 dB threshold produced pumping and stair-step volume changes.

Yamaha gets points for graphically representing EQ curves and for X/Y graphs of these dynamics functions. These are great learning tools for the entry-level person and allow the more experienced person to know at a glance what's going on, without having to refer to the numeric values.

Users with MIDI sequencers will have fun with the ProMix because there are 531 controllable mix parameters and 1536 control changes. This means, in addition to ON/OFF and mix levels, you also can record dynamic changes in pans, EQ changes and effects parameters. Editing the recorded MIDI stream was possible with Opcode's Vision 1.4 MIDI software, even without specific data to plug into the MIDI setup document.

According to Yamaha, the major MIDI software companies are already working on software to better accommodate the ProMix 01. If you're already running a beefy MIDI rig and pushing lots of data, you may have to expand your system capacity if you plan to rely heavily on mix automation.

During automated mixing, I was bothered at first by the sound the motorized faders made as they moved and the jerky motion when they moved slowly. I turned up the monitors to mask the noise and, finding that the jerky motion did not cause jerky volume changes, ignored them.

The utility menu contains assignments and adjustment for the 100 Hz, 1 kHz, 10 kHz, pink noise generator, send 3 and 4 configuration, output compressor patch point, memory protect and RAM battery

checking.

The group menu allows the input channels and the ST IN fader to be grouped in up to four groups. The pair menu is used to link adjacent channels in pairs for stereo operation. When a link is made, phase, EQ, compressor patch, ON/OFF, cue, send 1-4 data is combined. When channels using a dynamics processor are paired, a message appears on the LCD screen and the compressor patch is cancelled. When grouped channels are paired, they are removed from the group. To reassign them to a group, you have to go back to the Group Menu.

The two-page meter menu shows inputs 1-16 on the first page and ST IN, return 1 and 2, sends 3 and 4. Peak hold reset is available on both pages. There are a number of built-in shortcuts for traversing the menus. Hitting any of the 1-16 input "SEL" (select) buttons while in the meter menu brings the 1-16 page to view.

Pressing the ST IN, RTN/SND or ST OUT SEL buttons changes the meter menu to the second page where those readings may be seen.

The pan and phase menu is configured like the meter menu. The first page provides pan adjustments for 1-16, showing a two-pot concentric control for linked channels. The second page shows the ST IN, RTN1, RTN2, sends 3-4 and ST OUT adjustments. There are 16 steps from center to hard panned. On the third page, the phase of each channel can be set to normal or reverse. Paired channels will both be changed as will the unbalanced ST IN channels.

Good news for broadcasters and anyone who needs cueing. The extensive cueing system and separate monitor output bus will allow the ProMix 01 to easily cover the cueing chores normally required in a production studio. You will, however, have to build a speaker mute relay for open mic/combo operations. Mix cue routes all inputs to the monitor out, last cue selects individual or paired inputs only and routes them to the monitor out. In ST FIX, the cue follows the main stereo out.

When the group mode is selected, and mix or last cue are selected, you can listen to a post-fader mix of all channels in the selected group via cue, thus balancing the individual faders in the group. The cue mode also brings a lot of channel, routing, send, and effects status information to the LCD display.

In conclusion, Yamaha has made a nice sounding digital box with lots of features that should make anyone looking to upgrade from a 16-track analog setup or less to break out the checkbook. The more than 150 pages of documentation get a "B+."

In my view, the early adopters will buy it just to say they own a ProMix. The more cautious will likely wait to see how well the third-party developers respond with ProMix 01-oriented products, and how committed Yamaha is to continuing development based on user input.

Product Capsule: Yamaha ProMix 01 Digital Mixer

Thumbs Up	Thumbs Down
<ul style="list-style-type: none"> ✓ price ✓ digital effects ✓ moving fader automation 	<ul style="list-style-type: none"> ✓ no digital input ✓ only one SP/DIF digital output ✓ single sample rate (48 kHz)

For more information, circle **Reader Service 138**, or contact Yamaha of America at 714-522-9011.

PRODUCT GUIDE

Companies with new product announcements for Studio Sessions Product Guide should send them to Radio World, c/o Studio Sessions Editor, 5827 Columbia Pike, 3rd floor, Falls Church, Va. 22041

Peavey VMP 2 Microphone Preamp

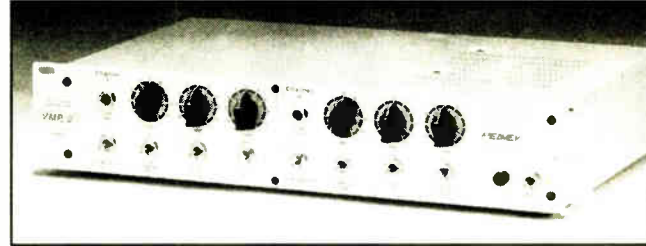

Peavey has introduced a tube-based, dual-channel mic preamp, the VMP 2, with no solid stage stages in the audio path.

The preamp uses three 12AX7s in the input and a 12AT7 in the output stage. Frequency response is rated from 10 Hz to 40 kHz plus 0, minus 3 dB. Other features include phantom power, EQ, -20 dB input pad and low fre-

quency cutoff.

For more information, contact Peavey at 601-483-5365; or circle **Reader Service 185**.

Pacific Recorders ADX Ensemble

Pacific Recorders ADX Ensemble is a digital audio work station combined with on-board, automated mixing surface.

The ADX workstation include 8-track recorder editor, 2.4GB hard drive (standard), moving fader automated control surface and transport/editor control panel. The most frequently used functions are accomplished by push buttons and control knobs.

For more information, contact Pacific Recorders at 619-438-3911; or circle **Reader Service 176**.



Mackie LM-3204 Line Mixer

For those who have audio tasks that are input intensive, the LM-3204 may have been designed for you. The 16-stereo input mixer (32 in mono) has electronically balanced inputs, two stereo aux sends per channel, three-band EQ, which is identical to the acclaimed CR-1604 console's EQ section, a control room monitor section, tape inputs and rugged construction.

For more information, contact Mackie at 800-898-3211; or circle **Reader Service 144**.

STATION/STUDIO SERVICES

427 SOUND EFFECTS \$89.00

For a 5-CD set with a 30-day money-back guarantee.

Take an extra \$10 off if you mention this ad!

Send \$79 to Ghostwriters
2412 Unity Ave. N., Dept. RW
Minneapolis, MN 55422

For credit card orders call
(612) 522-6256

READER SERVICE 128

BUY-OUT MUSIC — \$99

Sixty 60-second music beds for .. \$99
198 :30 & :60 music beds for ... \$198
2200 Hanna-Barbera (C)

Sound Effects for \$495
110 Lasers & Sweepers for \$99

For FREE DETAILS on
production music, sound
effects, call

.....
Ghostwriters (612) 522-6256

READER SERVICE 128

ATTENTION PROVIDERS!

Promote your services to **Radio World's** 22,000+ readers. Reach Radio Station and Recording Studio owners/managers and engineers with your message. For information on affordable advertising call **Simone at 1-800-336-3045**.

DEMO

OVERSTOCK

NEW

YEAR INVENTORY

Audio Processing



HR11C



787A

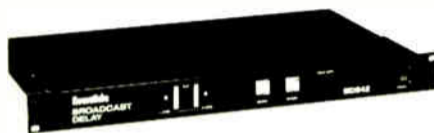

BD942

CRL	PMC400A	Demo, AM Limiter, no NRSC	\$ 995.00
CRL	SMP950	New, Tri-Band Stereo AM Limiter	\$2,355.00
DBX	263X	New, De-Esser Great Value	\$ 119.00
DBX	563X	New, Noise Reduction Unit	\$ 145.00
Eventide	BD942	Demo, Scratched top panels (2 avail)	\$1,100.00
Orban	787A	Demo, Mic Processor, like new	\$1,255.00
Orban	787A	New, Mic Processor, sale priced (3 avail)	\$1,147.00
Roland	SN550	New, Digital Noise Reduction units (2 avail)	\$1,895.00
Roland	SRC2	New, Digital Sample Rate Converter	\$2,195.00
Rolls	HR11C	Demo, Mic processor with EQ.	\$ 132.00
Sony	DPSR7	New, Stereo Reverb effects unit (2 avail)	\$995.00
Valley	NOISEGATE	New, Single channel Noise gate	\$ 78.00
Valley	460V	New, Professional, stereo Noise gate	\$ 525.00
Valley	LEVELLER	New, AGC unit.	\$ 400.00

CD Players



DN961FA

Denon	DN2700	Dual CD transport Demo unit, like new	\$1480.00
Denon	DN961FA	Demo unit, new condition	\$1088.00
Denon	DN970FA	Demo unit, new condition	\$1750.00
Sony	CDP3100	Demo unit, new condition	\$2350.00
Sony	CDS3100	Demo unit, new condition	\$1250.00
Tascam	CD601	Demo unit, new condition	\$1345.00
Tascam	CD701	Demo unit, new condition	\$1550.00
Tascam	CD701	Brand New, (3 avail)	\$1650.00

Speakers



PBM6.5II

Tannoy	PBM8	New, pair Studio Monitors	\$399.00
Tannoy	PBM5II	New, pair Studio Monitors	\$249.00
Tannoy	PBM8II	New, pair Studio Monitors	\$555.00
Tannoy	PBM65II	New, pair Studio Monitors	\$312.00
Tannoy	SYSTEM6NFM	New, pair Studio Monitors	\$555.00
Tannoy	SYSTEM12DMTII	Demo, pair Studio Monitors	\$1799.00
Yamaha	S115H11	New, PA Speakers priced ea	\$245.00
Yamaha	SW215	New, Subwoofer for the above	\$279.00



ATR60

Hold Everything!!!!!!!
Tascam ATR60, Brand new, 1/2" Reel to Reel 2 track. Blowout Priced at \$1998.00
(4 units only) (Hurry!!!)

Equipment Solutions To Keep You Number One



7012 27TH STREET WEST TACOMA WA 98466

Phone : 800-426-8434 Fax: 800-231-7055

Prices Limited to stock on hand.

World Radio History

END CLEARANCE

Telephone Interface

CCS	CDQ2001	New Digital Audio Codec	\$6577.00
Comrex	TCB2A	Demo, Auto-answer coupler	\$260.00
Comrex	TCB1A	Demo, Telephone coupler, great value	\$90.00
Comrex	PLXMICRO	Demo, Portable frequency extender	\$1250.00
Comrex	LXTPLUS	Demo, Frequency extender encoder	\$630.00
Comrex	DXP	Demo, Digital codec, like new	\$1890.00
Comrex	RLXII	New, Frequency extender decoder re-boxed	\$500.00
Comrex	PLXII	New, Frequency extender encoder re-boxed	\$500.00
Gentner	EFT100	Demo, Frequency extender, like new	\$550.00
Gentner	DHIA	Demo, Digital Hybrid, used once	\$850.00
Henry	MIXMINUSPLUS	Demo unit, new condition	\$135.00
Symetrix	111	Demo unit, used once, new condition	\$750.00
Symetrix	TI101	Demo unit, customer return	\$329.00



TCB2A



DXP



PLXMICRO

Consoles/Mixers

AEQ	MP10	New, Remote sport console (7 at this price)	\$1278.00
Audioarts	MR40	Demo, 4 Track production console, never used	\$8200.00
Tascam	M06ST	Demo, ok condition, 6 channel stereo console	\$369.00
Tascam	M06ST	New, overstock, priced to move! (5 at this price)	\$399.00



MP10

Cassette Decks

Marantz	PMD500	Demo unit Dual Transport, Rack mount, quality	\$428.00
Sony	CCP110	Demo unit High speed Duplicator Incredible buy!	\$300.00
Teac	112MKII	Demo unit, new condition Very popular	\$585.00



112MKII

Miscellaneous Items

ATI	HD100	Demo, Headphone amplifier	\$169.00
Audio Dyn.	AD302	New, Audio board for ITC Delta	\$177.00
Audiometrics	51900	Demo, Black mic boom (5 avail.)	\$89.00
Cylink	AirLink 64	New, Wireless modems	\$2,150.00
Mod. Sciences	RDS1	New, RBDS generation system	\$999.00
Radix	ST500	New, Up/down timers	\$159.00
Rolls	RA2100	Demo, power amplifier	\$138.00
Technics	SL1200MKII	Demo, turntable - great shape	\$357.00



ST500



AIRLINK64

Check this Out!!!

Otari DTR7 Brand new, Professional Dat Recorder Cleared Priced at \$1998.00



DTR7

Equipment Solutions To Keep You Number One

BSW
BROADCAST SUPPLY WORLDWIDE

7012 27TH STREET WEST TACOMA WA 98466

Phone : 800-426-8434

Fax: 800-231-7055

Sale Prices Expire December 30th, 1994

World Radio History

Circle (86) On Reader Service Card

NEW

DISSED

OVERSTOCK

DEMO

Products & Services Showcase

For more information on the products shown below, circle the appropriate Reader Service No. (s) on the enclosed Subscription/Reader Service card or contact the advertiser directly.

Uh-Oh...  **...We Should Have Called CORTANA**

STATI-CAT for **Affordable Lightning Prevention.**

Let Us Design a System for You

Stati-Cat provides a continuous, low-resistance discharge path for the static electric charge on tall structures. Dissipation points are 1/8", type 304 stainless steel rods ground to needle sharpness. They won't bend, not even from ice and severe weather.



Write to us today for a **FREE** brochure!
P.O. Box 2548, Farmington, N.M. 87499
Call (505) 325-5336 FAX (505) 326-2337

READER SERVICE NO. 45

Unique!

Shively FM Antennas offer standard features often unique in the industry: **Our unique fine-matching transformer**, included as standard equipment on Shively commercial antennas, can correct VSWR mismatches of up to 1.5:1 to compensate for tower effects. Unlike most others, it is tunable both under power and pressure, so it requires *no* disassembly of the system, and *no* adjusting of taped slugs for tuning. This means a better match, with less rigging time and costs. *Watch future issues of Radio World for other unique Shively features.*

Shively Labs
A Division of Howell Laboratories, Inc.
19 Harrison Road, Bridgton, ME 04009
207-647-3327 FAX 207-647-8273

READER SERVICE NO. 12



- CUSTOM ANTENNA PHASING SYSTEMS
- ANTENNA CONTROL SYSTEMS
- AM/MF ANTENNA TUNING UNITS
- DIPLEXERS & MULTIPLEXERS
- TRANSMITTER COMBINERS
- DUMMYLOADS (WITH MATCHING NETWORK)
- ASSOCIATED RF COMPONENTS
- CALL OR FAX FOR MORE INFORMATION

PHASETEK INC.

550 CALIFORNIA RD. UNIT 11
QUAKERTOWN, PA 18951
PHONE: 215-536-6648
FAX: 215-536-7180

READER SERVICE NO. 177

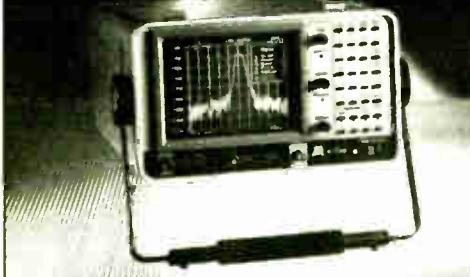

A-7550... 10 kHz to 1 GHz PORTABLE SPECTRUM ANALYZER

Synthesized tuning and phase locked frequency stabilization enable accurate swept frequency measurements over calibrated span widths from as wide as 100 MHz/div to as narrow as 1 kHz/div. A standard 300 Hz resolution bandwidth filter and peak hold mode provide NRSC measurement capability. Other A-7550 features include:

- +30 to -120 dBm measurement range
- DC operation from 12 to 30 volts (Built-in battery optional)
- Optional built-in tracking generator
- Optional built-in AM/FM/SSB receiver
- Optional IEEE-488 or RS-232 interfaces

For more information or a demonstration of the A-7550 contact:

IFR SYSTEMS, INC.
10200 West York St., Wichita, Kansas 67215
Phone (316) 522-4981 Ext. 207 FAX (316) 524-2623
DIRECT FACTORY RENTAL PLAN AVAILABLE

READER SERVICE NO. 114

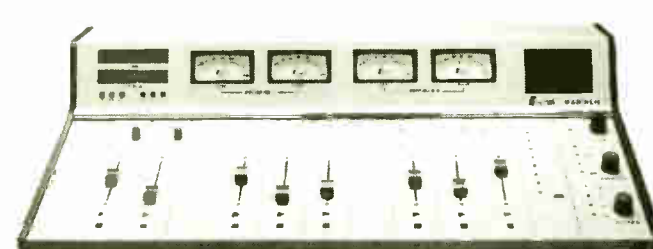

Why Compromise?

Get affordable features for any format!

Do you faint at the cost of a full featured console but find that budget consoles can't support the complexity of your station's tight format?

And our digitally controlled analog signal path has a full, clean sound that is second to none while ensuring trouble free service for years to come.

The Mariner console's software based channel mixers can easily supply a simple machine control to the most complex automatic sequencing and gain control scheme, all at a modest price.

Starting at \$3900, the Mariner series consoles give you today's technology at yesterday's prices.

Logitek Call: 800-231-5870 or 713-782-4592 for your nearest Logitek dealer

READER SERVICE NO. 37

B-SERIES FM BROADCAST POWER AMPLIFIERS

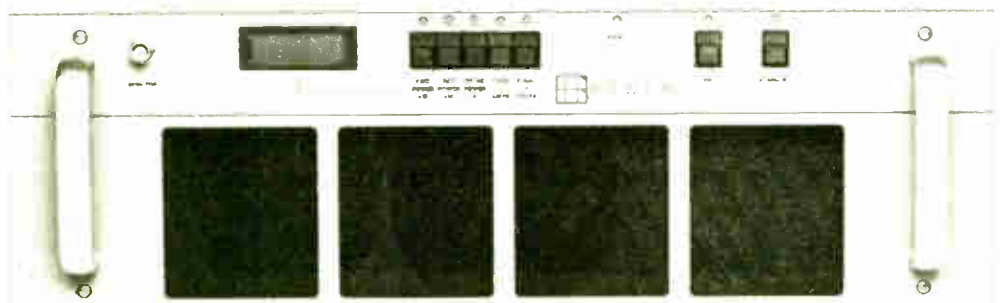

Reliability through design is the key to the B-series power amplifiers

Silicon Valley POWER AMPLIFIERS
The RF People

Silicon Valley Power Amplifiers, a quality supplier of OEM modules is now producing a range of compact power amplifiers. All units are complete with rack slide ready to install in a 19" rack system.
Power outputs 150W, 300W, 600W, & 1250W

For prices and delivery CALL 1-800-986-9700

READER SERVICE NO. 78

Get the best MUSIC, the best QUALITY, the best PRICE!

ALL ready to make your format sizzle this year!

Oldies SEVENTIES **WE'VE GOT IT ALL ON CD**

AC
Hot AC
CHR
Country

ALL in stock...ALL at terrific prices!

To get it ALL just call our name!

1-800-HALLAND
1-800-(425-5263)

HBS
HALLAND BROADCAST SERVICES, INC.

tel: (818) 963-6300
fax: (818) 963-2070
1289 E. Alhambra Ave., Glendora, CA 91740

READER SERVICE NO. 105

Setting Up for Live Recording

Part II of III

by Mike Joseph

LEXENA, Kan. I previously discussed the general issues surrounding the presentation and capture of live music events for broadcast. This time, I'll concentrate on the meat of the matter: loading a truck full of gear and going on-site to grab it live for later broadcast.

I'll assume the scenario to be your capturing a musical group with singers, drums, electric and acoustic instruments. They are playing in a medium-sized semi-enclosed shed at an outdoor regional festival. The promoter has hired a professional sound company to provide sound reinforcement for the expected 3,000 audience members.

Several of the station's sponsors have underwritten your production costs, and the sales and marketing department has had the production director up until mid-

is on stage, making big noise in the room. How well can you hear what you are doing inside a tiny, tinny RV, six feet away from a ferris wheel's diesel genera-

possible to capture something on tape. You can try one of the following options below.

I'll assume an eight-track tape deck of

The first order of business should be the group decision of whether the music goes out live or is captured to tape.

tor, right behind the left PA stack, where there's more bass inside the van than in the bass player's lap?

- Catch it live to stereo on tape (DAT), for easy sequence editing later, allowing the removal of dead air, bad jokes and musician's expletives.

- Do an FOH console output split to the input channels of a multitrack tape deck or Alesis ADAT/Tascam DA-88/Fostex RD-8 digital stack, and worry about mix-

your choice for all these following examples. If you've got more tracks, congratulations. Ignore the first section. I'll also assume that you are the one calling the shots on the mixing consoles, whether it is the sound reinforcement console's bus routing (option 1), or your own mixing console on its own feed off an active or transformer coupled mic splitter (option 2).

Option 1 is cheap and dirty. First, lay out the eight-track signal feeds on paper. Decide whether you want to compromise toward discrete control of individual instruments (even if the outcome will be more mono-like), or whether you'd be happier with stereo spreads. This will depend greatly on your monitoring situation: can you hear what you are doing?

The band has two guitars, stereo keys, bass, drum (percussion) machine, real drums and two vocals. You could assign individual tracks to the guitars, bass, mono keyboard, each vocal, percussion box and mono drums. Not good? How about a stereo mix of guitars and keys, and then bass and percussion box on a third track (they may be separable later), each vocal to a track, and kick, snare and toms/overheads to three tracks. Or maybe put the percussion on its own track and do all the drums on two in stereo.

Good luck

This exercise will be as much a function of your confidence in the mix balance and quality as a straight logistics problem. And remember, once you've combined, "there ain't no goin' back."

On a four-bus board, route the instruments you want grouped in stereo to the respective two pairs of busses. Feed the remaining four tape tracks from the console's direct or insert outputs on the individual channels, such as the vocals or bass. If you have access to good compressor/limiters, use them. They should go in line before the tape deck, or in the group insert loops if you want them to be grouped pre-fader. Use the board's controls to combine the groups to the stereo bus and your house mix, if it's the FOH console.

On an eight-bus board, just go ahead and assign the instruments in stereo pairs (or not) to your groups as you normally would. Run the bus and/or direct outputs to the tape inputs (maybe by way of the compressors) and away you go. Again, combine the groups to the stereo bus and your house mix, if it's the FOH console. Get your hands on a Tascam, Roland or Fostex 8x2 stereo mixer with built-in headphone amp, and you'll even be able to monitor tape feeds on cans, sort of.

Remember, if you are taking your feeds from the sound reinforcement system while "mixing" out front, your recording monitors are really the house mains, and what you are hearing at FOH is PA plus stage, so what you have on tape is, uh...

play it back later and find out. By then, of course, it is too late to do anything but gate, expand, compress and EQ the individual tape tracks, salvaging the sticky parts. Good luck.

In Part 3, I'll discuss the technically ultimate approach to capturing live music for broadcast, the financially dreaded Option 2.

□ □ □

Mike Joseph is the owner of Rabbit Run Productions, Kansas City, specializing in live music capture. He is the former director of sales and marketing at Valley Audio Products and marketing manager for Electro-Voice professional products, past editor of R•E•P (Recording Engineer/Producer) and Live Sound magazines, and a long-time West Coast record producer/recording engineer.

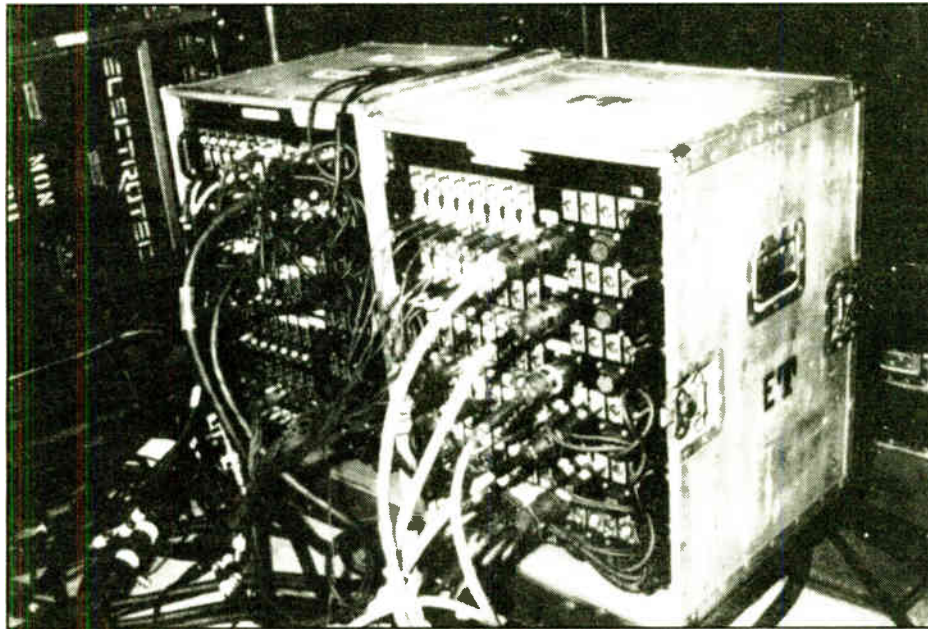

Recording for broadcast has to take into account the live setup.

night all week creating inserts and pre-production segments for the projected two-hour show.

The first order of business should be the group decision of whether the music goes out live (a "hot mix" fed to phone lines or a microwave studio link), or is captured to multitrack or stereo tape for later editing and broadcast.

Of course, the sales department wants it concurrent with the live show so that the advertisers can capitalize on event excitement and promotional tie-ins. The show producer wants it recorded to multitrack tape, so that a "quality" program, properly edited, mixed and assembled, can be created later representing the highest standard of production capabilities.

Spread the word

As the expert, you cover the options for everybody:

- Go live to air, whether mixed by you in a truck or some back room, or picked up as a feed off the sound reinforcement system. Of course this will leave you at the mercy of the gods. Will the guitarist break a string? There are five minutes of dead air and dumb stage banter. Is the band late getting to the stage? Some announcer has to fill in. The pressure is on the emcee and the show producer to cover all the unexpected possibilities.

And then there are the vagaries of monitoring your separate mix while the band

ing it later when you can hear what you're doing.

- Bring a recording studio to the field, mixing to multitrack tape in a controlled and well-processed environment. Again, the music can be mixed and edited later, then combined with other segments and inserts for later broadcast.

Making the decisions

The choice will be philosophical as well as financial: for broadcast live or later. Taking the PA mix output in stereo to DAT is cheap, if not free. Well-balanced phone lines are more. Properly creating your own mix on site, whether live-to-stereo or spun to multitrack is more again, and multitrack has posting costs.

There are also a number of pure technical considerations: If you throw a Left/Right FOH PA console program split at a DAT machine and roll some 120s, or feed that signal directly to air via a matched stereo pair of phone lines, you will probably end up with the inverse of what you would hear out in the audience, such as reduced guitar, distorted vocal blend, bass not even close to the stage/room sound, in fidelity or level; and more leakage than you know what to do with.

If you've decided to record multitrack, and the chances of doing it really right aren't even a glimmer on the fuzzy horizon, don't despair or just say no. It is



LMA/DUOPOLY CONTOUR MAPS

The **DATAWORLD** LMA/DUOPOLY Market Survey Contour maps present a precise electronic verification of overlapping and intersecting contours.

AM 5 mV/m and FM 3.16 mV/m City Grade contours are shown in full color, including transmitter site indicator. The map is supported with a printout showing all of the stations which appear on the map.

Daily updating of **DATAWORLD'S** AM and FM databases protects against errors and omissions.

OTHER MAP OPTIONS

- SHADOWING (TERRAIN SHIELDING)
- CONTOUR COVERAGE
- POPULATION DENSITY
- ZIP CODE BOUNDARIES
- RECEIVED SIGNAL LEVEL
- SPECIAL REQUIREMENTS

1990 CENSUS

WHO ARE YOUR LISTENERS?

1990 BUREAU OF CENSUS POPULATION COUNTING

- Comprehensive Ethnic and Demographic Data
- Ethnic/Demographic Data Available for Each Zip Code Within Coverage Area
- Age Analysis Reflected in Ethnic Breakout
- Resolution Increased to Block Level
- Percent of County Coverage Shown

ETHNIC PIE-CHART DISPLAY

- Projects Ethnic Population in Multi-Color Pie Chart Form

dataworld

800-368-5754 FAX: 301-656-5341

Circle (165) On Reader Service Card

PRODUCT EVALUATION

Aphex Combines 'Tube' Sound, Low Cost

by John Diamantis

WASHINGTON One day, a few weeks ago, I thought I had it made. I finally got caught up on that mountain of paperwork on my desk. I was making a sizable dent in my to-do lists. I was finished with this month's *Tube Talk* a week early. Man, it looked like "Miller Time."

Then, the calls started coming. First, by voice mail. They were from John Gatski, **RW's** managing editor. That was on a Monday in late October. I decided to stay home that day and nurse a cold. I ignored

all calls.

By Thursday morning, I finally felt well



Aphex Model 107 Mic Preamp

enough to go back to work, and before I could set foot out the door, the phone rang. "John? This is John Gatski! Where have you been? I've got this hot, brand new inexpensive tube microphone preamp from Aphex and if you can test it, listen to it,

and write the column and have it by Monday we'll scoop everyone and... So much for taking it easy.

I unpacked the Aphex Model 107 Dual Channel Thermionic Microphone Preamp (whew!) with "Tubessence" (more on that later), and went to work. Besides the tube design, the Model 107 packs a lot of features for \$599. It has two completely discrete solid state, vacuum tube preamp channels in a single rack space chassis. The input jacks are located on the front panel, and are XLR type, while the outputs are on the rear and are 1/4-inch TRS phone jacks.

Front panel controls include a switchable 20 dB pad, a gain control, low cut filter, 48 volt phantom supply on/off, and a signal polarity switch. Front panel indicators include an "OK" green LED for normal signal level, and an "OVERLOAD" LED to warn of impending clipping.

The Aphex Model 107 is transformerless at both input and output. The input is balanced, the output is not. The unit is powered via a detachable wall mount transformer which not only helps keep costs down, but keeps AC induced noise down as well. The rear panel, in addition to the output jacks, has a switch selectable output range: either +4 dB or -10 dB. Also included is an input for a footswitch.

Inside the unit, parts quality is good, with a liberal amount of 1 percent metal film resistors, OK caps, average, though socketed ICs, this unit was a pre-production prototype, and a single, 12AT7 dual-triode vacuum tube.

So what is this "Tubessence?" "The combining of new and old technologies for state of the art performance," as the manual states." According to Aphex, "[T]he Model 107's innovative preamp circuitry (patent pending) delivers the best characteristics typically associated with vacuum

continued on page 25 ►

JOIN THE HUNDREDS WHO HAVE USED DIGILINK TO ACHIEVE ECONOMIC RECOVERY

- ☐ 10 hours of stereo digital audio storage for \$7,995* complete
- ☐ Satellite, CD, Tape, and Hard Disk Automation
- ☐ Simultaneous Play, Record, & Network transfer
- ☐ Digital Editor with Waveform Editing for tight production
- ☐ Crossfade CD's, sources, and hard disk audio
- ☐ Music Scheduling system built in for basic CD automation
- ☐ Digital Networking for transfer of audio and schedules

Digilink is the #1 selling digital audio hard disk system in radio today. You can replace your cart machines for live On Air and have an automation system for walk away at the same time! Link over 15 workstations & scheduling computers on our digital network and transfer audio and schedules between your studios.

For more information, call or write
ARRAKIS,

(303) 224-2248

the premier broadcast manufacturer of
consoles, furniture, Digilink and Trak*Star digital audio products.

Consoles
Modulux
Trak*Star
Digilink
Modulink

ARRAKIS

* Suggested retail price. Complete system

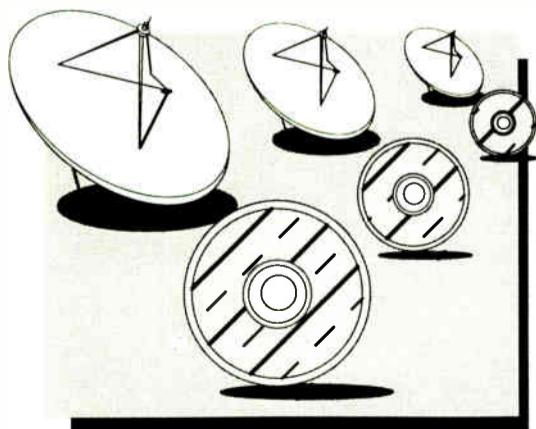

ISDN: Accessible All Over RBOC Territory

► continued from page 1

channels pay a \$147 one-time fee and a monthly fee of \$27.21. Ameritech, the Bell company servicing Michigan, then charges 8.2 cents per call for local calls.

In comparison, analog or equalized radio loops do offer a flat rate monthly usage fee, but some consideration must be given to the high installation cost which can reach \$2,000 per line. Also, the quality of analog is not nearly as good as digital when considering higher frequencies.

In Indiana, the ISDN usage fee is also billed at a flat rate, which is \$84.21 a month for both voice channels. But the ISDN start-up cost in the state that nationally broadcasts Notre Dame football and Indiana University basketball is a mere \$139.

ISDN lines use a higher bandwidth than normal phone lines to rapidly transfer vast amounts of information. In some cases data, video, photos and graphics can be transferred 53 time faster through ISDN lines than ordinary lines. The main difference between ISDN lines and analog lines is that ISDN lines are carrying digital information instead of analog signals.

"We use the same piece of copper, put electronics on each end of it and send 0's

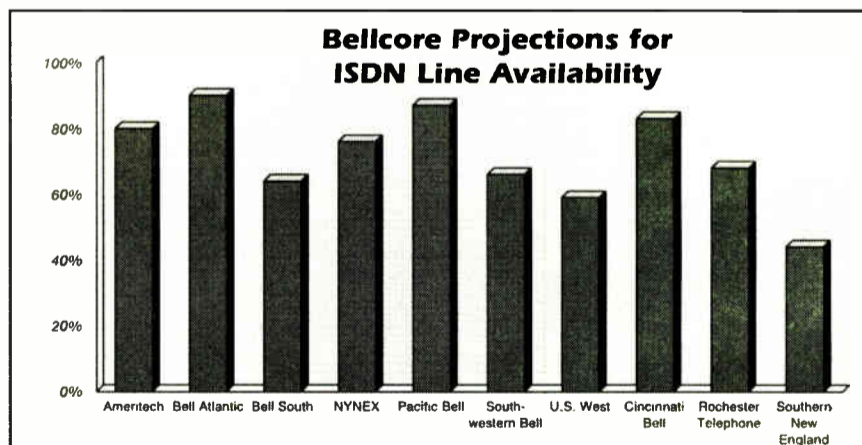

and 1's instead of analog signals," said Pat D'Innocenzo, who is Bell Atlantic's ISDN product and applications manager.

Three channels are incorporated in an ISDN line: the two 64 kbps B channels and a data D channel, which is a 16 kbps channel used for inter-device communication.

For radio, the biggest benefit of ISDN is its 15 kHz or more audio bandwidth, and the ensuing enhanced audio quality provided by the B channels.

Washington, D.C.-based oldies station WXTR, for example, harnesses ISDN for a live morning show from the infamous Watergate Hotel.

"This is a better system from a state-of-the-art point of view," WXTR Station Manager Bob Rich said. "And cheaper."

With two Telos \$4,000 Zephyr ISDN codecs, WXTR broadcasts a remote that sounds as though it is coming directly from its studio, eliminating hollow, phone-receiver type of analog sound effect sometimes found in phone remotes.

Aphex 107 Goes for 'Tube' Sound

► continued from page 24

tube signal processing, while retaining the transient "quickness" and low distortion that solid state circuits are known for.

Let me say right up front that fine folks at Aphex have come up with some ground breaking products in the last 10 years. But, shoving a vacuum tube in between a couple of op-amps does not a tube preamp make, at least, not from a purist's point of view. Although a schematic wasn't supplied, it was easy to determine that the folks at Aphex are trying to produce a preamp that sounds "tubey." To some folks, that's the sound of vintage tube gear: Warm bass. Rolled-off highs. The smo-o-o-th sound.

While the Model 107's characteristics aren't that exaggerated, they do exist to some degree. I guess you could say they captured the "tube's essence."

The single triode stage per preamp is run

Product Capsule: Aphex Model 107 Tube Microphone Preamp

Thumbs Up	Thumbs Down
<ul style="list-style-type: none"> ✓ good sound ✓ features ✓ great price 	<ul style="list-style-type: none"> ✓ not really a true tube design

For more information, circle **Reader Service 131**; or contact Aphex at 818-767-2929.

at a plate voltage of 48 volts. At this voltage, it appears that the tube would be current-starved, and distort with minimum input level. Additionally, the tube seems to be set up as a follower, or buffer, seemingly supplying no gain, but loaded with a very low impedance, again, to initiate distortion prematurely. (*Editor's Note: According to Aphex, however, there is actually 20 dB of gain inside the tube stage. This patent-pending circuit is said to be achieved through elimination of plate resistance.*)

Because I did not have a schematic, I did not spend much more time tracing the rest of the circuit, in operation, the characteristics of this box substantiated my findings. Distortion was higher than typical, even for tube-based circuitry, but was mostly low order in nature. When driven into clipping, the waveform, as viewed on an oscilloscope appeared somewhat like a tube circuit, in that it wasn't an abrupt clip, but a gradual flattening of the negative part of the waveform first, then the positive. A soft clip, if you please.

Interestingly enough, after all of my assumptions about its design, I auditioned the Model 107, and you know, it's a pretty good sounding preamp. I don't know if it's because of the single tube stage, or in spite of it, but it lacks the typical bleached out solid-state sound that passes for hi-fi these days.

The resultant sound utilizing Neuman U-87 and TLM 193 microphones was quite natural. What really drew my attention to this was listening to our production director at WBIG talk off-mic while I was setting up the preamp. It was uncanny how real he sounded through the electronics. Talk about your A/B comparison. Headphones on. Headphones off. Is it live, or Aphex? I quickly switched back to the internal preamps in our production room console, and the magic was gone.

I then let the production director try it. First the console preamps. Then the Aphex 107. It was no contest. "Put those preamps

back, please." were the last sounds I heard from him as I dashed out the door. I returned later to test, compare, and record my results on DAT. No matter who or what other preamp I tried, the Aphex 107 bested the console preamps.

Those of you who have been following *Tube Talk* since its beginning might wonder the inevitable, "How does the Aphex Model 107 compare to the highly-acclaimed D. W. Fearn VT-1, an all-tube microphone preamp you reviewed in *Tube Talk* No. 2?"

In going over my notes, the VT-1 was a more refined overall, and cleaner in the highs than the Aphex, but this is like comparing apples and oranges, as the VT-1

costs five times what the 107 costs, and was built as a no-holds barred, state-of-the-art preamp. The Aphex 107 was designed for the everyman, so he too may enjoy the benefits of "vacuum tube" technology.

Test results were interesting. The THD readings were constant throughout the audio bandpass, averaging around 0.15 percent for 60 dB worth of gain, and +10 dBm output. The THD increased to 0.4 percent at about +18 dBm out. Clipping occurred at +22 dBm, and was asymmetrical, typical for current-starved tube operation. SMPTE IMD was a bit high at 0.4 percent at +10 dBm, and a little lower at lower outputs. Noise was -68 dB down for 60 dB of gain, meeting spec for -128 dBu

worst case equivalent noise. A 10 kHz squarewave at +10 dBm out showed no overshoot and was ever so slightly rounded at the corners; quite respectable performance. Frequency response was reasonably flat to 60 kHz.

So, is the Aphex Model 107 a product truly worthy of the status we've afforded to other products utilizing vacuum tubes? Or, is it an attempt to capitalize on the vacuum tube "craze," with trick circuitry and catchy nomenclature? Yes to the first question, maybe just a little to the second.

In summary, I say go try it. The price is right, and the performance is certainly better than your typical console preamp. And it sounds good, too.

□ □ □

John Diamantis is director of engineering for WGMS-FM, WBIG-FM and WTEM (AM) in Washington, D.C.

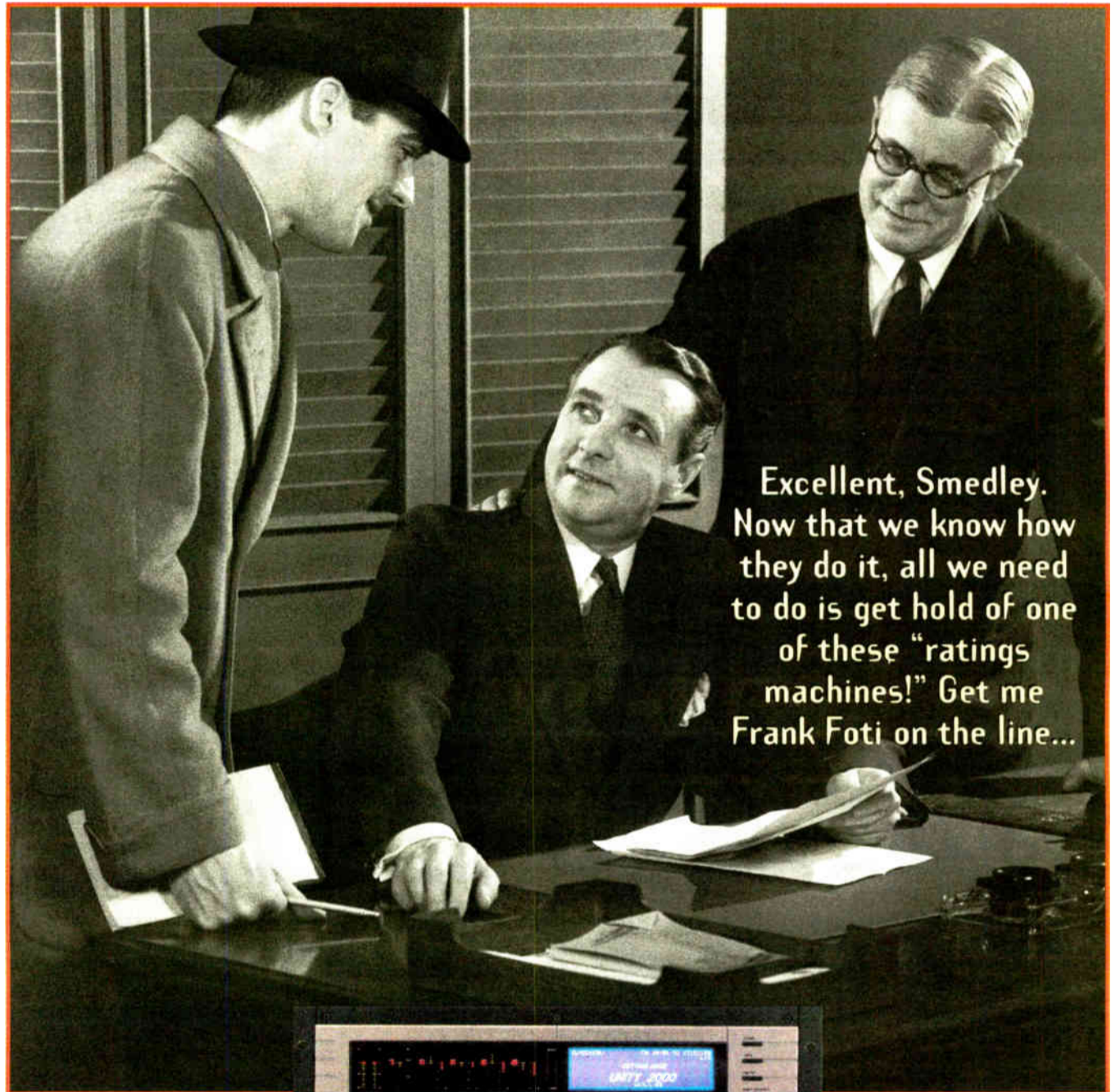

Excellent, Smedley. Now that we know how they do it, all we need to do is get hold of one of these "ratings machines!" Get me Frank Foti on the line...



the unity 2000! the world's best sounding FM processor.
Better sound, more listeners, bigger profits. That's what it's all about.



CUTTINGEDGE

2101 SUPERIOR AVENUE, CLEVELAND, OHIO 44114 • TEL: (216) 241-3343 • FAX: (216) 241-4103

World Radio History

Circle (25) On Reader Service Card

TM CENTURY[®] INC.

PRESENTS OUR NEWEST
fully INTEGRATED SYSTEM
FOR FULL AUTOMATION OR LIVE-ASSIST

Ultimate Digital Studio II



- ⊕ New COUNTDOWN clock shows EXACT TIME before VOCAL STARTS and WARNS that END of EVENT is NEAR.
- ⊕ Full WALK AWAY OR LIVE CONTROL with JUST ONE KEYSTROKE.
- ⊕ TOTAL EVENT TIME, INTRO LENGTH, ELAPSED TIME, and ALL IMPORTANT INFORMATION is ALWAYS CLEARLY SHOWN.

For more information call your personal sales representative:

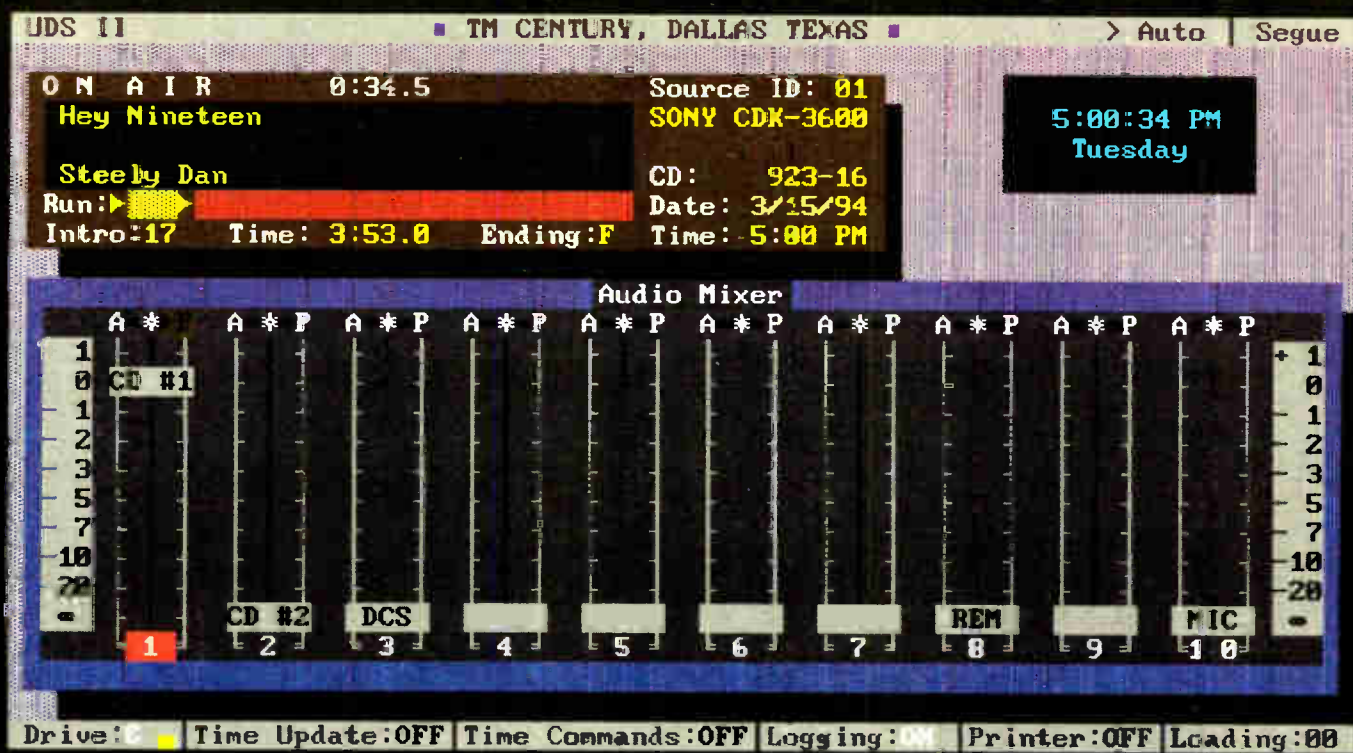

- ➊ NEW AUDIO CONTROLLER USES DIGITAL TECHNOLOGY FOR SOFTWARE CONTROL OF AUDIO LEVELS AND CROSS FADES
- ➋ NEW BARGRAPH DISPLAY SHOWS AT A GLANCE HOW MUCH TIME IS LEFT IN YOUR SONG, COMMERCIAL, JINGLE, ETC.

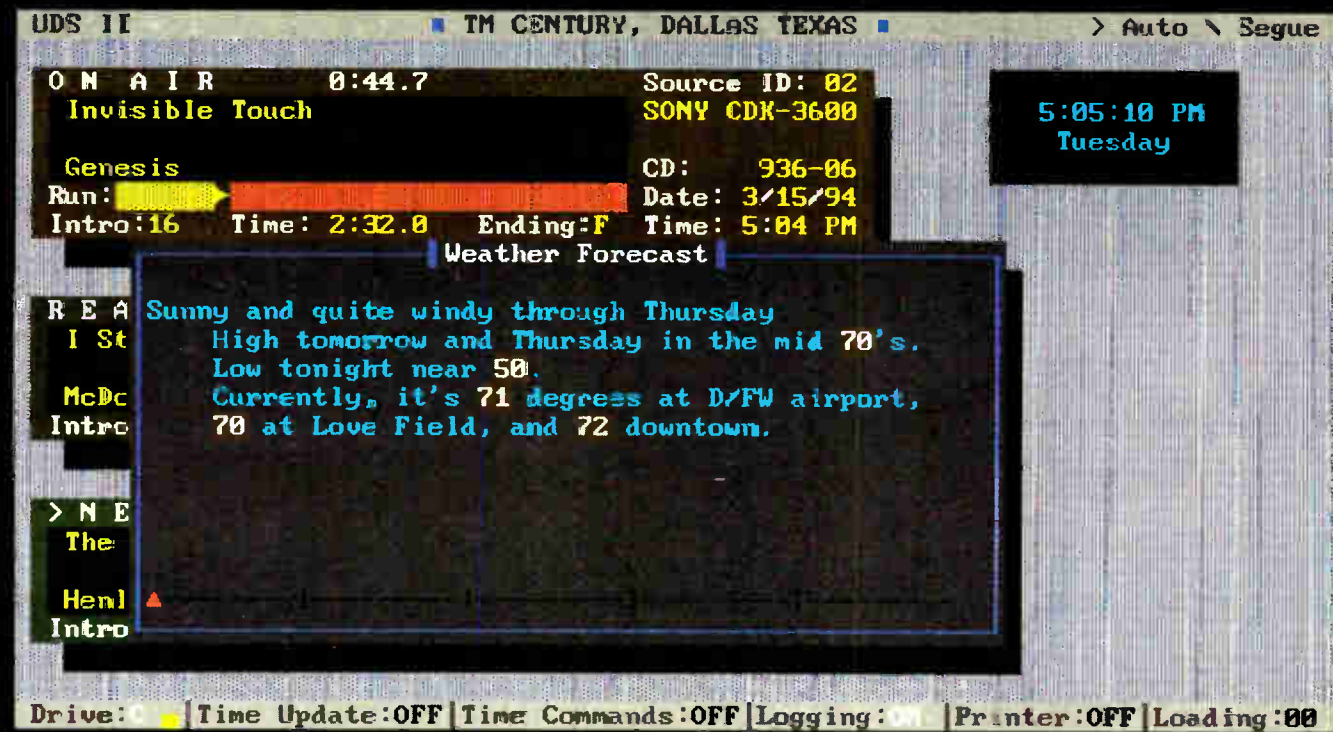

- ➌ POP-UP WEATHER, CALENDAR, PSA, AND LINER WINDOWS
- ➍ ENHANCED REAL-TIME FUNCTIONS, INCLUDING REAL-TIME NETWORK JOINS
- ➎ ENHANCED SUPPORT FOR LOCAL-AREA NETWORKS
- ➏ INCLUDES ALL THE FEATURES THAT MADE THE ORIGINAL UDS FAMOUS INCLUDING SUPPORT FOR ALL INDUSTRY-STANDARD MUSIC SCHEDULING AND TRAFFIC SYSTEMS

(214) 406-6800 — (800) TM Century — FAX (214) 406-6890

**Complete System
Starting at \$17,950
NOW fully compatible with ENCO DAD486X**



Orban DSE 7000

We Took The *Work* Out Of Workstation.

The Orban DSE 7000 is the fastest digital workstation for radio production. Of course it's friendly. There's no setup. No confusion. No trouble. In fact, you can literally plug it in and play in thirty minutes or less. No training. No computer wizards needed.

The DSE is everything you need. Ask anyone who has a DSE and they'll

tell you there's no comparison. We invite you to call or fax us for a complete user's list.

With the DSE you'll produce the best sounding spots in one-third the time. It's the easiest way to increase your production and your profits. Plus, boost your creativity to a whole new level.

Harris Allied makes it easy to get your DSE 7000. Simply make one free call.

After all, nobody wants to work harder than they have to.

1-800-622-0022

Fax 317-966-0623

Southern CA 1-800-690-2828

 **HARRIS
ALLIED**

ANSI RFR Standard Exceeded

► continued from page 8

to levels complying with the ANSI standard, it is therefore necessary 1) to reduce the magnitude of the power densities in those areas, 2) to restrict human access to those areas, or 3) to implement some combination of these two factors."

The report recommended that KXTZ-FM's transmitting antenna be moved away from Tower 2 "to reduce the fields in that area to levels below the ANSI Standard. Because KXTZ-FM alone is calculated to contribute about 99 percent of the ANSI guideline, it is believed that its relocation should, by itself, reduce RF power densities to levels meeting the guidelines.

Moving the antenna

"If, however, subsequent measurements show that power densities in that area still exceed ANSI, then we recommend that the transmitting antenna for KMZQ-FM also be relocated."

Additionally, the report outlined steps to be taken in an effort to restrict access to the "areas exceeding ANSI," including installation of two raised "speed bumps," the painting of "the road area between the bumps" with 4" international orange diagonal stripes, "about 36 posts 3-4 feet tall made of dielectric material," and two warning signs to be placed next to the speed bumps.

According to a Las Vegas radio engineer, who wished to remain anonymous, AMI took such steps about a year ago. He also said that the radio and television stations on Black Mountain have been working together to insure that, if stations need tower or antenna work done, "nobody is affected for a great length or period at any one time."

The report also noted that "restricting access to the areas exceeding ANSI is difficult, since part of the access road to the site is covered by the high fields and it is practical neither to fence off the road nor to reroute it."

Mark Nolte, chief engineer of KFMS-FM, one of the stations on the Black Mountain site, doesn't think that signs and ground markings are enough. "If they're going to have a hot area on the ground," he said, "it should be totally restricted in any way, and the only way you can get access to that area is to...go through the proper channels."

Is the RF problem encountered at the Black Mountain antenna farm a problem at other multiple sites in the U.S.? "(At) the majority of multiple use sites, the permittees and licensees normally work together," the FCC's Greenberg said. "We have had a few instances at these very large multiple use sites where that always isn't the case, and this is a prime example."

Greenberg said the problem arises "[W]hen leases are signed, not enough information is in the lease for requirements on complying with RF. In other words, there should be a plan at every multiple use site on who should reduce power when access is given to the site, whether...(it's) in compliance with OST Bulletin 65...this is what will happen when people are authorized access to the site, this is what we do to protect the public, this is

what we do when people climb the tower, this is what we have to do when there's an emergency. Everybody should get a copy of that. That is not happening."

What's true?

Radio engineers are sometimes skeptical about the effects of RF. Sands said that he's been working "around this stuff" all his life, "and until a few years ago, nobody ever had any concern whether or not the level was too

high... So I don't know, and I guess only time's gonna tell... whether or not there's really a problem...But the issue is...that there's a standard, and that the broadcasters have to abide by the standard, whether or not they believe it's a hazard or not."

RFR is a problem that is not likely to go away. Bob Weller, a consulting engineer for Hammett & Edison, said the 1992 version of the ANSI standard is five times more restrictive than the 1982 version under certain conditions, such as where the public congregates. That provision would not apply to the Black

Mountain site, which is located away from the general population. Weller also said that the 1992 version of the standard has a broader range than the 1982 rule.

With the efforts being undertaken by AMI, and the company's response to the FCC, it looks as though the RF problem on Black Mountain is on the mend. The anonymous Las Vegas radio engineer said that the steps being taken by AMI to mark the hot spots at the site show are positive. He said that "within the year... the problem will be 99 percent gone."

Miles Above Your Competition!



As authorized distributors for multiple lines of satellite communications products, we'll make sure you have the right system for your needs. Then we'll handle the implementation details: from licensing & lease financing; satellite selection & space segment; to turnkey installation & training. But we don't stop there—NSN maintains a 24-hour Technical Support Center because your network doesn't stand still after five.

Experience and service is why NSN Network Services is the nation's leading distributor of SCPC digital VSAT audio and data networks.

Look to us for:

- ✧ Audio & Data VSAT Network Equipment
- ✧ VSAT Network Design
- ✧ Domestic & International Spacetime
- ✧ Integrated Operations Networks
- ✧ 24-Hour Technical Support
- ✧ Installation & Training
- ✧ Disaster Recovery
- ✧ Lease Financing

Put yourself above the rest with a satellite system from NSN Network Services. NSN's digital VSAT audio and data distribution systems have enabled broadcasters around the world to reach new heights in program and spot distribution, while keeping costs grounded.

If you want to program distant stations, centralize commercial production and billing, start your own programming network, or expand your existing operation, call us. NSN has established and supports over 60 digital satellite audio systems, with over 1,000 receive sites worldwide.

303 ♦ 949 ♦ 7774

800 ♦ 345 ♦ VSAT
8 7 2 8

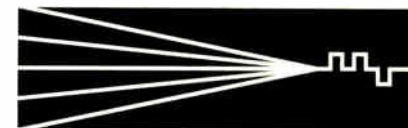

**NSN NETWORK
SERVICES**
SM

Avon, Colorado USA

Fax 303 ♦ 949 ♦ 9620

NSN is an authorized distributor of ComStream, Gilat, Audisk, Crown, and other fine satellite and broadcast communications products.

Circle (91) On Reader Service Card

World Radio History

BOTTOMLINE BROADCASTER

Interface Box a Simple but Important Item

by Jim Murphy

MORGANTOWN, W.Va. This month's project is an interface box, a project whose simplicity is exceeded only by its importance in a well-run, efficient broadcast station workshop.

Baltimore, it is actually not that well organized. In reality, the setup takes a form more closely resembling a bird's nest, with test clips hanging to screws, piggy-backed by alligator clips, and of course the old technique of solder folded and rammed into the ends of an XLR connector.

permits you to plug all your test gear into a central location, switch in your test gear and your loading, and read and listen to the test

connectors your equipment uses.

I used Cinch-Jones six-pin connectors at the box, and I made up cables to fit all my

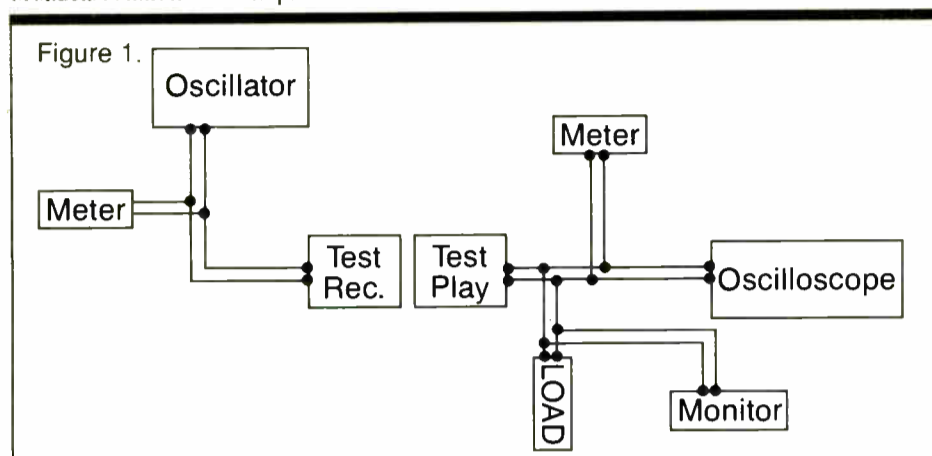

It is a common piece of equipment on many benches of two-way service shops and in FAA repair stations. Here, elaborate navigation and communications set-ups are reduced to one or two plugs which supply all voltages and signals to the unit under test. In fact, whenever time and money are a prime factor, you'll probably find some type of interface box to expedite setup and repair.

Time-saving as it may be, the interface box has not found its way into the broadcast engineer's workbench, perhaps because it is felt that the time needed to build such a unit is not warranted and that usage would not be that extensive.

Figure 1 shows a typical set-up for checking and aligning a stereo cart machine. Although the block diagram bears a close resemblance to the sewer system of

I also have images of trying to press a headphone jack tightly against alligator clips while trying to identify a tone. Sometimes even two people are needed just to keep the connections solid, and even then, with this type of setup, about the time you are ready to adjust azimuth or equalization just a hair, something goes "bing" and you then begin troubleshooting your hook-up.

This is all a terrible waste of time, not to mention the frustration that comes after you set up a system out of phase or try to adjust the left channel while monitoring the right. Start over, do it all over again, right?

The interface box shown in Figure 2 will help solve these problems and will let you concentrate on the alignment instead of the rig, which will help you do your job in a more efficient manner. The interface simply

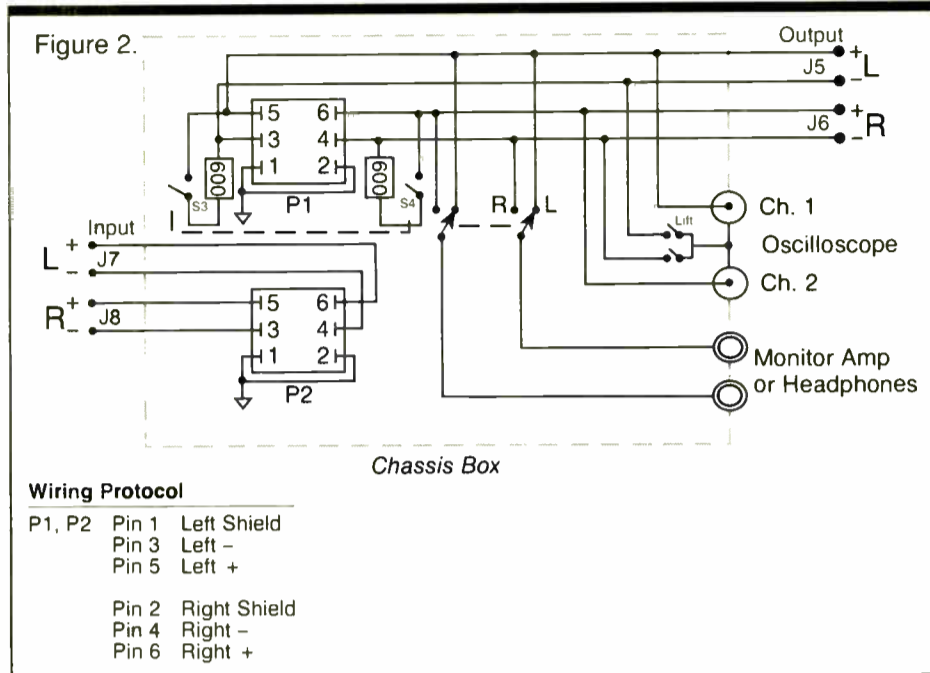

data, all without clips and clothespins. And since the system provides good, solid connections, it is only logical that your measurements will be more accurate.

cart and tape machines, labeling and tagging them where necessary. This makes connections fast and easy, with the least margin of error.

This is a very easy project to build, and most parts can be found around the shop. Use at least a 4 x 4 minibox, or equivalent, and bring out your oscilloscope, VM and oscillator cables on one end through grommets. Mount your I/O chassis plugs on the other, and set your switches and banana plugs on the top.

Custom-cut the cables to your oscilloscope, analyzer or VM, and dress them in a neat and orderly fashion. Install the appropriate connectors, and you're almost ready.

Incidentally, if you are using proof equipment from Potomac Instruments, you can omit the loading switches on the L and R outputs. This equipment has the proper terminations at

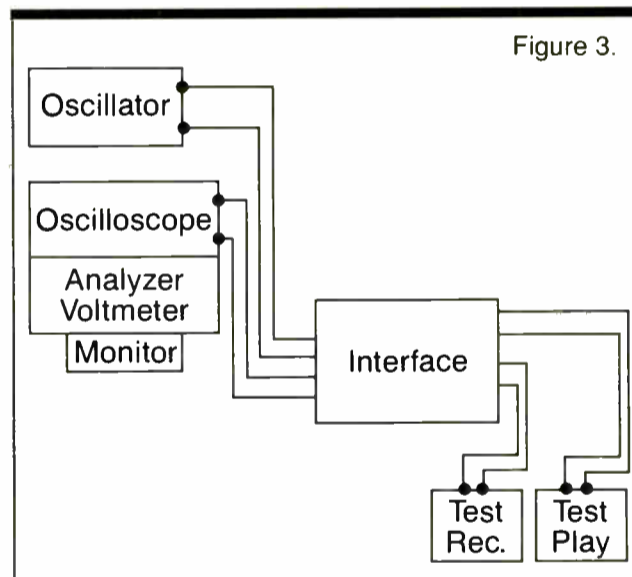

Figure 3 illustrates the setup. Your test equipment plugs directly into the interface. Coaxial cable jumpers are used for oscilloscope connections, and binding posts pro-

vide a convenient place to connect a monitor or headphone.

Figure 4. Special Parts for Interface Box

Symbol	Part	Number
J1, J2	BNC Chassis Mount	*
J3, J4	Binding Posts	*
J5, J6	3-Pin DIN 180 Cable	**Switchcraft 05CL3
P1	Cinch-Jones Plug	P306AB
P2	Cinch-Jones Socket	S306AB
	Cable Plug	P306CCT
	Cable Socket	S306CCT
R1, R2	620 OHMS, 1/4 W Resistors	
S1	DPDT Toggle	
S2	DPST Toggle	
S3, S4, S5, S6	SPST Toggle	
	Minibox & Assorted Hardware	

* Depends on manufacturer
** For Potomac Instruments equipment

vide a convenient place to connect a monitor or headphone.

Outputs to your AC meter or analyzer and the path to your oscilloscope should be cable and terminated into whatever type of

the oscillator and, providing you have the transformers, on the analyzer/VM.

Your cart machine interface cables should be three or four feet long and six or seven continued on next page ▶



BELAR
STEREO MONITOR

You can measure...

with the best monitor and the most accurate test set.

The FMM-2/FMS-2 series monitors provide an even greater degree of precision measurement than ever before... You can measure S/N below 90 dB, You can measure crosstalk below 85 dB, You can measure separations of better than 70 dB, You can measure frequency response to better than 0.25 dB, You can measure distortions to lower than 0.01%, and much more... Our uncluttered panels and autoranging voltmeters make these measurements a dream.

BELAR (610) 687-5550
ELECTRONICS LABORATORY, INC.
LANCASTER AVENUE AT DORSET, DEVON, PENNSYLVANIA 19333
Call or write for more information on Belar AM, FM, Stereo, SCA and TV monitors.

WORKBENCH

Do Not Neglect the Transmitter Site

by John Bisset

SPRINGFIELD, Va. This time out I'll concentrate on that building we find ourselves visiting less and less, thanks to duopoly—the transmitter site.

As you find yourself running between several stations now, your visits to the transmitter get spread out further and further. If you have the luxury to set aside a day for maintenance, here are a few things to keep in mind.

Owners of BE FM-30B and FM-35B transmitters should have received by now an engineering change bulletin regarding the RFCs used in the screen and grid of the PA. If you haven't received the instruction sheet, at your earliest convenience, contact BE to get the proper part. The RFCs have each been changed to a 1.5-ohm 10 W resistor. The previous RFCs have been found to be marginal, can open up, and interrupt your grid or screen feed. (See figure 1).

If you're running a solo engineering shop, talk to your promotions people and see if you can borrow an intern a few hours a week. One of the first things you can teach the intern is how to solder.

It goes without saying that you should

Interface Box a Must

► continued from previous page

feet for your floor model tape recorders.

Terminate them with the proper connectors, and if you use terminals, as the ITC Omega requires, label and fan them out to match the barrier strips. Be very careful to get your phasing and channels correct when you make these cables.

Once you have everything wired properly, your worries about phasing error and channel reversal are over.

When your equipment is connected, all you need do is connect one interface cable to the playback unit, and the other one to the record unit.

Make sure the oscilloscope lift switch is open (off) until you begin using your scope. The oscilloscope input is unbalanced, which ties both lows together, so lifting this ground removes the chance of introducing error in your distortion or level readings.

You can switch your monitor to listen to either left or right channel. And be sure your loading switches are on if you are using a high impedance AC voltmeter, especially when you are setting output levels.

So set a couple of hours aside to build this box and cables, and you'll be rewarded many times over. Checking and aligning machines will be completed in the length of time you normally spent searching for cables, clipping jumpers onto terminals and scrounging around for wire and connectors.

□ □ □

Jim Murphy is director of engineering for the West Virginia Radio Network. Write to him care of RW.

check the integrity of each cable, and have the intern re-do it till it's right. Making up a test cable for checking cart machines

If you decide to switch to these filters, drop by a home improvement center or hardware store and get a filter whistle.

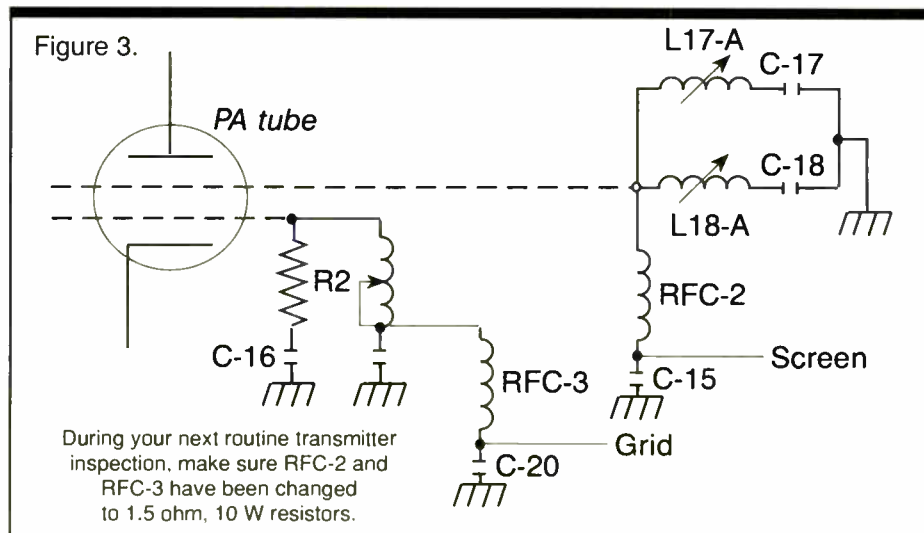

means you can leave the machine in the turret and quickly swap cables to check azimuth, levels or response.

While he's soldering, if you own an RF transfer switch, have the intern solder up a dummy plug. We had a station that recently lost its switch due to lightning. After the switch was removed, the transmitter wouldn't come up. An intricate interlock ladder was wired through the switch's contacts. Until each interlock was jumpered, the rig stayed off the air.

The short-term solution was to simply plug the transfer switch connector back into the switch, even though the RF portion was no longer connected. That got the rig back up. The next step was to figure out the interlocks and wire up a dummy plug that could be used while the switch was being repaired.

Speaking of transfer switches, if you have the opportunity to plan a new transmitter site, plan the plumbing run so that there is adequate play in the rigid line run to permit swiveling the switch input and output elbows so if the switch is removed, you can join the input and output together without adding additional line sections. If you can't make the runs work in this manner, pick up a short length of line and a couple of elbows (if needed) to form an RF patch. The RF patch takes the place of the transfer switch, should it ever need to be removed.

Contrary to popular belief, the spacing between the ports on some transfer switches does not equal the spacing of two elbows joined together.

While we're at the transmitter site, what are you using for air filters? If your filters are common furnace-type filters, save yourself some time cleaning your transmitter by investing in the "micropore" or extended surface area filters. One popular size, used by several transmitter manufacturers, is the 16x20x1. Dayton, the blower people, have these made for them under part number 5W509. You can always get them from Dayton, but a less costly alternative would be to look under air filters in the Yellow Pages. These filters are also called "computer grade" because they are woven with a very tight cloth-type mesh that traps a lot more dust and contaminants than the standard furnace filter.

is not enough to make any noise.

As the filter gets clogged with dust, though, air flow through the filter is blocked and enough air volume is pulled through the whistle to start making a racket. If your transmitter site is air conditioned, place a couple of these whistles on the air handler filters as well.

Owners of Harris MW series transmitters with the "Modulation Enhancer" assembly may want to look here first if you lose audio. It was recently brought to our attention that the pushbutton "in/out" switch can get dirty, and as the contacts oxidize, transmitter audio can be lost. In this particular case, the enhancer was "out," but the dirty switch still took the audio away. Exercising the switch, and liberal application of contact cleaner, took care of the problem. We should add our apologies to the phone company for blaming the "apparent" line loss on them.

□ □ □

John Bisset is a principal with Multiphase, a contract engineering and special projects company based in Washington, DC. He can be reached at 703-323-7180. Fax submissions for the Workbench column to 703-764-0751. Printed submissions qualify for SBE Certification credit.

TRANSMISSION SOLUTIONS

Nearly 500 Broadcasters
Have Found That Harris DX Transmitters
Practically Pay for Themselves.



With typical AC to RF efficiency of 85% or better and the lowest life cycle operating cost of any AM transmitters. From 10 kW through 2 MW. To learn how a Harris DX transmitter can increase your profits, please contact our radio sales department by fax (217-224-1439) or by phone:

217-222-8200

**HARRIS
ALLIED**

P.O. BOX 4290 • QUINCY, IL 62305-4290

©Harris Corporation 1994

Circle (209) On Reader Service Card

Testing Some New Network Software

by Richard Mertz

FAIRFAX, Va. Some months ago, I wrote about Peer-to-Peer LANS (Local Area Networks). Just to recap, local area networks are computers that are interconnected in such a way as to permit sending of e-mail (electronic mail), sharing of files and programs using a dedicated central computer called a server.

Users on the network use workstations to access the data and programs on the server. Many times, workstations are standalone PCs. Peer-to-Peer LANS are similar except each user (PC) on the network can act as both server and workstation. With Peer-to-Peer LANS, users can share files and printers.

I have discussed the interconnection of

the computers in previous articles. The software used then was Novell's NetWare Lite. NetWare Lite is an offshoot of Novell's NetWare that some regard as the top LAN operating system.

NetWare Lite worked just as advertised and functioned well. Soon after the article appeared, Novell began releasing Personal NetWare. This updated version of NetWare Lite was not only supposed to perform as well as the original software but be able to easily interface with full-blown NetWare.

Armed with two nodes of Personal NetWare software, off I went to update my Peer-to-Peer LAN. I loaded the software on the first machine. All appeared to go as planned. Next, I loaded the second

node in computer number two. The install program asked for "disk 2." When I inserted disk 2, the install program com-

pletely ignored it. Once I am able to get things up and running, I will write about all the gory details.

Well, there I was, expecting to write about a software enhancement but was left with nothing. So off I went to my local computer supermarket to see what they had that was

new and exciting. I picked up Microsoft's upgrade for Windows 3.1. Windows for Workgroups not only is an upgrade for windows but the platform for a Peer-to-Peer LAN. Sounds like a winner to me.

After opening the plastic wrap and tearing open the software package with its plethora

Windows for Workgroups not only is an upgrade for Windows but the platform for a Peer-to-Peer LAN.

of warnings, I found the setup program to be as simple as the original Windows installation. The install software checks your hardware and DOS operating system. The setup software runs under DOS so Windows doesn't need to be already installed.

continued on next page ►

Products & Services Showcase

For more information on the products shown below, circle the appropriate Reader Service No.(s) on the enclosed Subscription/Reader Service card or contact the advertiser directly.

EVEN THE BEST CAN BE MADE BETTER

Introducing the new

MINI-MIX 12A

THE COMPACT MIXER WITH A COMPACT PRICE FROM THE QUALITY LEADER

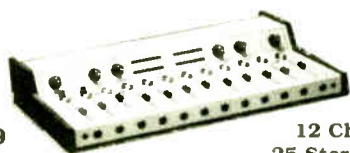

\$3499

12 Channels
25 Stereo Inputs

Service & Affordable Quality for Over 23 Years

AUTOGRAM CORPORATION

1500 Capital Avenue (214) 424-8585
Plano Texas 75074-8118 1-800-327-6901

FAX (214) 423-6334

READER SERVICE NO. 99

ARE YOU LOOKING FOR A COST EFFECTIVE ALTERNATIVE TO MANUFACTURER SERVICE?

SERVICE, REPAIR & CALIBRATION

- STL's • RPU's • TSL's
- Exciters • AM/FM
- Broadcast Monitors •
- Remote Control Systems

SPECIALIZING IN EQUIPMENT BY

- Belar • Marti •
- Moseley • McMartin
- TFT • And others...

An authorized
TFT service center

IN CASE OF EMERGENCY

We can help get you back on the air with our STL Loaner Program. We have STL's available that will be set to your frequency prior to shipping. We also provide over-the-phone technical assistance.



2198 Hubbard Lane, Grants Pass, OR 97527

(503) 471-2262

READER SERVICE NO. 106

Wizard For Windows™

by Prophet Systems, Inc.

The Flexible Digital Automation System

Designed by Broadcasters

- Windows & Novell Network
- Hard Drive Automation
- Digital Real-Time Editor
- Integrated Copy System
- Block Stretch/Squeeze
- Runs Multiple Stations
- Simultaneous Record & Play
- Voice Tracking Module
- Expand up to 20 Terminals
- Digital Reel to Reel with Program Length Recording

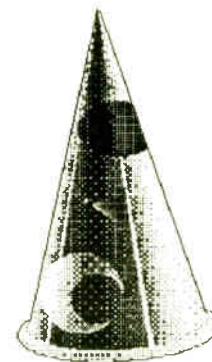

Prophet Systems

1-800-658-4403

READER SERVICE NO. 3

Attention Advertisers!

Reach 22,000+ broadcast professionals! RADIO WORLD's Product Showcase provides a perfect medium for test marketing your products and services. It's

an efficient, effective and affordable advertising option. For more information, including rates and deadlines, fax your sales representative at

1-703-998-2966

or call

1-800-336-3045

Introducing (ta-da) The Jr. Audio Director Plus™!

It's an 8 input to 2 output ON LINE or monitoring device.

\$550



The new Benchmark Jr. Audio Director Plus™ brings more to the party! It brings more control and selection features, and a stereo headphone amplifier, along with the performance and value that are traditionally a Benchmark for the industry.

In a half wide, 1RU high chassis, the Jr. Plus has two input switch banks which allow left and right outputs to select between eight sources. Additional switches provide a Mono Mix, with adjustable gain reduction of 3 to 6 dB, and a Right Channel Polarity reversal. LEDs indicate switch action. Inputs may be passively mixed ahead of the input amp by depressing two or more buttons.

Installation is "instant" with a No-Mod™ Rack Mount adapter and plugable Euro-Style barrier strips.

Available now.

Benchmark
...the measure of excellence™

BENCHMARK MEDIA SYSTEMS, INC.

Phone 800-262-4675, or 315-437-6300, FAX 315-437-8119

READER SERVICE NO. 153

While the install program is loading the Windows programs, it's a good idea to look through the book. It contains one of the best and simplest descriptions of a Peer-to-Peer LAN I've seen in a long time. Because I already had the network interface cards and cables installed in my computers, I skipped this part. Towards the end of the installation procedure, you are asked if you want your computer to share files and printers. I set my system up to share the printer and files. More on this later.

Just like Windows

Windows 3.1 was already installed on my machine. The upgrade appeared to function just like Windows always did except the opening message indicated the presence of the upgraded software. Except for a new program group labeled "Network," and print manager automatically loading, Windows worked just like it always did down to the screen saver.

I next installed the Windows upgrade on a second machine on my Peer-to-Peer network. Just like the first machine, the software install proceeded uneventfully. Once the Windows for Workgroups was installed on two machines, I attempted to access files through the network. No dice. It appeared that nothing worked. I knew something must be working.

The network card on the second machine has activity LEDs which would periodically flash. Something must be working. I tried everything but nothing worked. Reaching back to that old engineering adage, "When all else fails, read the directions," I put on my glasses and read the book.

Tell it what you want

Now we were getting somewhere. It is necessary to indicate to the Windows network which files you want to share. To do this you need to use the File Cabinet utility. Simply click on the folder for the files or directories you want to share and then click on the share icon. This icon looks like a hand holding folders. For those of you who are not familiar with Windows, a picture of a file folder indicates a directory. After setting up the file sharing on both computers, I was ready to give it a try.

Starting WordPerfect, I attempted to load a file from the other computer. Bingo! It worked like a charm.

Next came the printer test. I tried to print the file from WordPerfect; however, all I got was a message that the printer was not accepting characters. A quick detour through Print Manager fixed the problem. It seems I selected my fax card through the print manager. This one was my fault.

Resetting the print manager for the correct printer cleared up the situation.

There are some other features associated with Windows for Workgroups. Some of the features are electronic mail, fax sharing, if you have a fax modem, and a scheduler. More on these goodies in future articles.

After my experience with Personal NetWare, I found it a pleasure to install and use Workgroups. It is fairly easy to use as well. Some familiarity with Windows is helpful but not really necessary.

More on Peer-to-Peer LANs in future articles.

□ □ □

Richard Mertz is a principal at the consulting engineering firm of Suffa and Cavell, Fairfax, Va. He can be reached at 703-591-0110; through Compuserve, 73020,3026, or on the Internet at rmertz@dgs.dgsys.com.

'Best Buy' Mackie a Workhorse

► continued from page 18

it. This mixer is so clean and quiet that I don't hesitate to use it for my live DAT recordings. In fact, I'd bet that the MS 1202 is quieter than some very expensive radio station consoles on the air today. It's that good.

The Mackie MS 1202 also is extraordinarily useful. I use it for tape dubbing (the EQ is very effective) and to bridge professional components with consumer audio devices. You can jury-rig about anything through it. And I've even used it as a preamp in a home music system and enjoyed listening to CDs through its excellent headphone amp.

The only thing Mackie has not included in the MS 1202 is a provision for battery power. Though Mackie thoughtfully

provided a design that adds no additional "wall warts" in my vast collection, it has not given us a way to work with the MS 1202 away from AC power outlets. Hopefully, in a future version, a battery powering feature will be included.

Summary

I can't say enough good things about the workhorse Mackie MicroSeries 1202. It is an absolutely essential audio tool in my daily work. I would be at a loss without it. The more I think about it, the MS 1202 may just be one of the best audio bargains of all time.

□ □ □

Mackie Designs is located at 20205 144th Ave. NE, Woodinville, WA. Phone: 800-898-3211

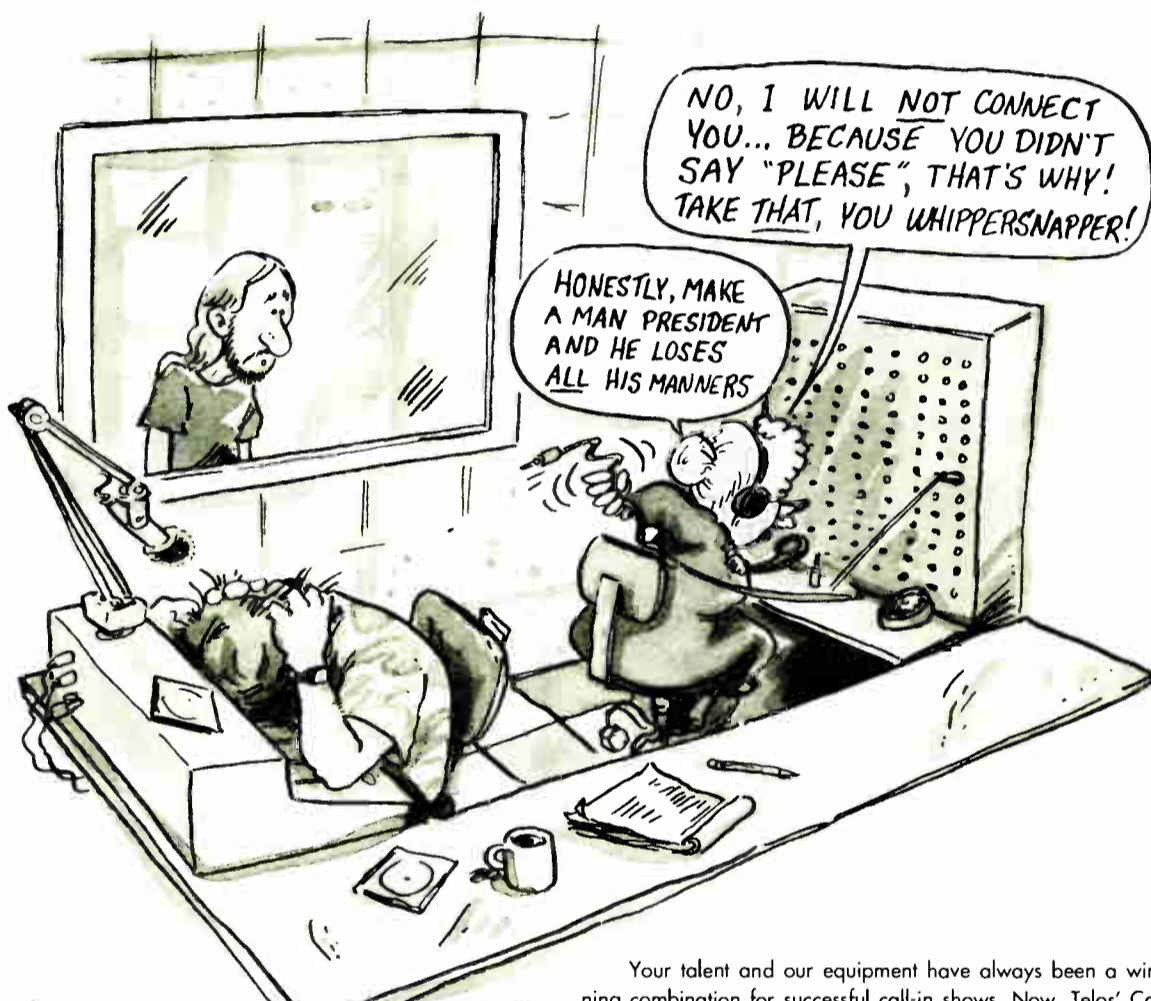

Current Users:
Call or fax for your **FREE** upgrade!!

Call Screen Manager

Talk Show Management Software



Your talent and our equipment have always been a winning combination for successful call-in shows. Now, Telos' Call Screen Manager software compliments our advanced multiline talk show systems by helping your screener/director provide your talent with information on each caller.

Call Screen Manager uses inexpensive IBM-compatible PCs and peripherals and you can choose two different screen views, so information is always displayed in the most useful, easy-to-interpret format. Features include real-time display of line status; full page and quick messages that may be stored and sent with simple keystroke combinations; a caller information database module with modifiable data fields and report and export capabilities; and the ability to accomplish most critical screener functions from the computer keyboard.

Two versions of Call Screen Manager are available. Host Software provides for a director position and any number of talent positions using a single PC. Remote Software allows communications between the studio and talent located at a remote site via modem.

So hire the best and give them the tools they need. Isn't it time you experienced the pleasure of great phones?



2101 Superior Avenue • Cleveland, Ohio 44114
216.241.7225 • FAX: 216.241.4103

Circle (124) On Reader Service Card

PRODUCT EVALUATION

DN-650F Offers Professional Features

by John Bisset

SPRINGFIELD, Va. It is always encouraging when manufacturers listen to customer feedback, which appears to be the case with the Denon DN-650F. This lower-cost CD player incorporates

several production features of more expensive players and adds pitch control, all for a discounted price in the low \$600s. The list price is \$750.00.

Unlike Denon CD cart machines, the DN-650F uses a sliding drawer, similar to consumer machines. And while Denon

included another consumer feature on the DN-650F—a front panel headphone jack

pushbuttons. A separate portion of the panel is used for pitch control. A vertical-fader-type knob permits adjustment of pitch +/-8 percent. This can help create some very interesting production effects, as well as matching tempo or beat when mixing sources. Add an AKG digital editor (or equivalent), as we did, and you really

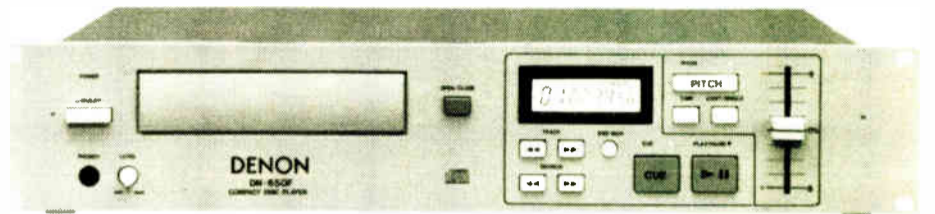

Denon DN-650F CD player

I COULD HAVE BOUGHT A DIGILINK!

Are you thinking about replacing your old cart machines with 'Digital Carts' such as floppies, flopticals, Bernoullis, or Opticals??? Well, think about it a little more! Add up the list price for a digital cartridge recorder, just a single player, AND the floppy disks--- and you will find that you could have bought a Digilink workstation for \$7,995 that gave you 'Live' -AND- 'Automation' capabilities!!!

A Digilink workstation stores audio on an internal hard disk and comes out of the box with a capacity of 547 one minute, stereo carts for only \$7,995. Even better, the Digilink hard disk has an average 15 year life. Imagine how many floppies you will break, wear out, lose, and replace over 15 years. That doesn't count all of the floppy disk mechanisms that will jam, break, and simply fail...

Also with a Digilink, you get much more! You can stack up hundreds of 'carts' in the play list and just walk away. You get satellite automation in the Digilink workstation and can optionally add CD players. A digital audio cut and splice editor even comes standard with Digilink. Because Digilink will play and record at the same time, you can play a spot to air while it starts a scheduled network autorecord. You can even network delay with Digilink.

With all of these features, it is easy to see why there are more than 500 Digilink workstations around the world from Paris to Moscow to Taiwan to Jamaica and in your own backyard. Don't suddenly come to the realization that you could have bought a Digilink! Call Arrakis now...

(303) 224-2248

ARRAKIS

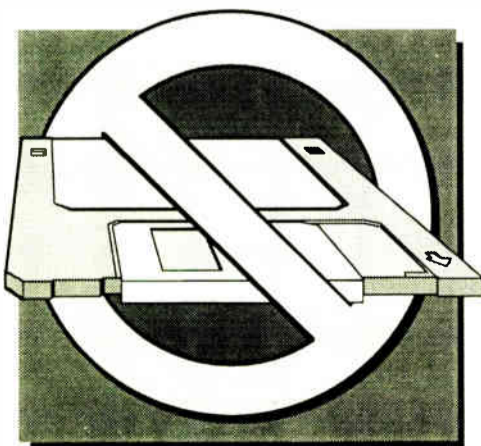

© 1993 Arrakis Systems Inc. 2619 Midpoint Drive, Fort Collins, CO. 80525

Circle (60) On Reader Service Card

with volume control—it is hardly consumer-grade equipment.

Full array

The CD player offers a full array of separate XLR-balanced and RCA-unbalanced outputs, as well as a digital out and a full-function remote connector. The front panel is clean and uncluttered, making it ideal for a fast-paced on-air or production environment.

All the pushbuttons are soft-touch-type switches. The Play and Cue buttons are color coded and large. There is no excuse for hitting the wrong button.

Seldom-used buttons are smaller and located away from the Play and Cue

have some powerful production tools.

Pitch control is selected quickly and easily by simply pushing a button. It can provide a fixed pitch, a preset speed or, by using the fader, variable pitch. Between the addition of pitch control and the lower cost, the DN-650F is well within the reach of clubs and station road shows. The jocks at a local urban station are salivating at the mixing possibilities this new model poses.

Denon applied its typical foresight in designing the DN-650F. LEDs instead of bulbs that burn out are used. With the LEDs, you can program the selection of features, allowing customers to customize

continued on page 38 ▶

USER REPORT

Pioneer 300-Disc Changer Boosts Efficiency at KWJJ

by Michael Kelly
General Manager
KWJJ-FM

SALT LAKE CITY At KWJJ-FM, we operate live 24 hours a day, seven days a week. Running this type of country music radio station requires a large staff as well as an extensive CD library. For these reasons, we sought out a cost-effective and efficient system that completely automated cueing, auditioning and playback of a large volume of CDs in our live-assist programs.

Until this time we had used a manual single-play CD deck. It was extremely reliable, but our DJs had to constantly handle the CDs. Every disc was manually placed into the machine for cueing and playback. This causes nicks and scratches on CDs, which in turn leads to continuous replacement of the discs and on-air problems, compromising the reliability of our machines.

Automatically alternates

Initially, we considered buying Pioneer semi-automated six- or eight-packs, but the combined cost of these units made it more cost-effective to consider the Pioneer CAC-V3000, a 300-disc-capacity autochanger that automatically alternates discs between two built-in play heads.

At first, we were skeptical because the station had never relied on a single automated system. However, knowing firsthand about Pioneer's performance and reliability, we forged ahead and purchased the unit.

The CAC-V3000 addressed our needs and solved our existing problems. The autochanger automatically searches and delivers the correct disc quietly, precisely and gently, without leaving fingerprints, dropping discs or mixing up titles. Not only do the DJs have more time to focus on other facets of the show, the CDs last longer too.

The cueing capability was astounding. Using a PC with Mountain Horizons software, a DJ simply selects a song to play on the computer and the Pioneer system cues it up automatically. In fact, the operator can even audition or cue audio beforehand. Unlike some other systems, the CAC-V3000 cues up to the beginning of audio, not to the actual track, so there is no dead air.

The system is extremely smooth. With two disc players alternating playback, the second player begins playing immediately when the first one is finished. There is no

continued on page 39 ▶

The RDS-1 keeps getting better, because it's the industry's first and only software controlled RDS Coder. That means that changes to the RDS Standard, and our own ongoing upgrades, are as simple as loading a new disk in your RDS PC.

The RDS-1 gives you flexibility and control you can't get anywhere else, like 255 Radiotext messages of unlimited length, full automation of RDS functions, and easy setup right out of the box. Animate your station on your listener's radios *while you transmit profit-making Transparent Data*. Only the RDS-1 does it all!

Now the wait is over!

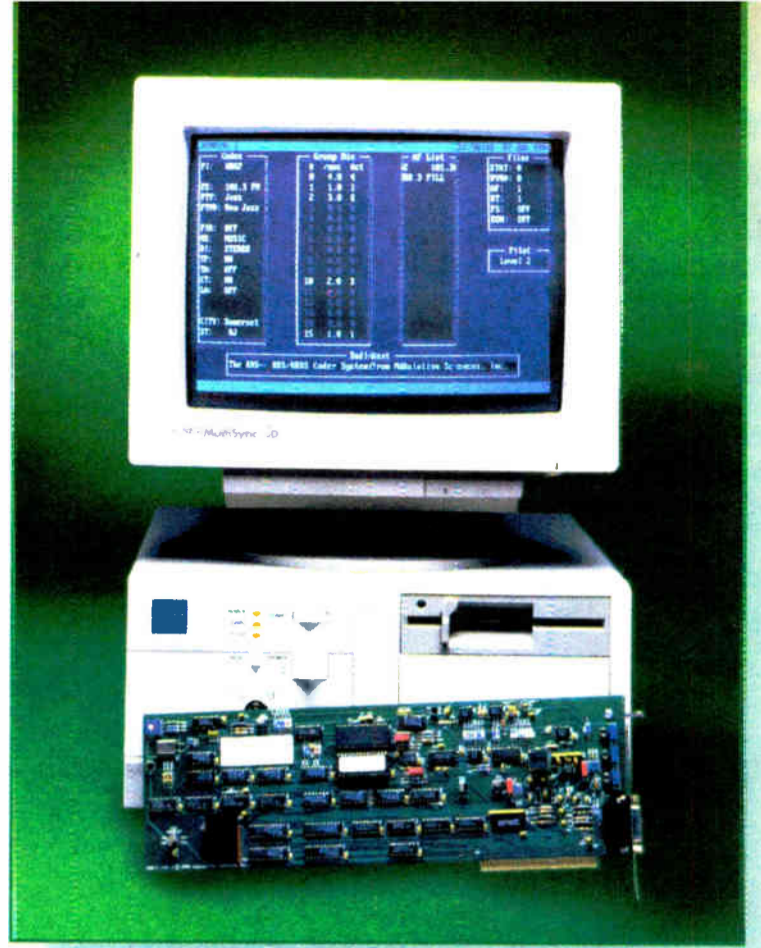

Model RDS-1 RDS System Generator & Software

Modulation Sciences gives you everything you need to put  to work today



Our new RDS Data Receivers give you profit-making access to the *full* RDS data stream. Now you can lease the RDS data channels that conventional RDS receivers ignore. Use the RDS-X2 to feed billboard displays, provide stock market updates, and actuate remote control.

Individually addressable, the RDS-X2 gives you and your data transmission customers robust, error-corrected reception of any and all RDS data, plus audio and composite outputs. And innovative features like onboard data filtering, Antenna Diversity and Beacon Tuning™ make RDS datacasting simple and reliable.



Model RDS-X2 RDS Data Receiver

Whether you're already on the air with RDS, or only thinking about it, you need our new RDS Monitor. The PRD-3000 decodes, displays, analyzes and stores the complete RDS data stream, and it measures RDS injection level to 1/10 of 1 percent.

Data is displayed on any desk or laptop DOS or Windows® PC. Plugged into our optional tuner, the PRD-3000 lets you examine the most minute details of your RDS signal, *and everyone else's*. Like all MSI products, the PRD-3000 is supported by a bold three year warranty.

There's no longer a reason to wait for RDS to happen. All the tools you need are here today – courtesy of the RDS Authority . . .

modulation sciences, inc.

12A World's Fair Drive • Somerset, NJ 08873 USA
Voice (908) 302-3090 • Fax (908) 302-0206
Toll Free in USA (800) 826-2603

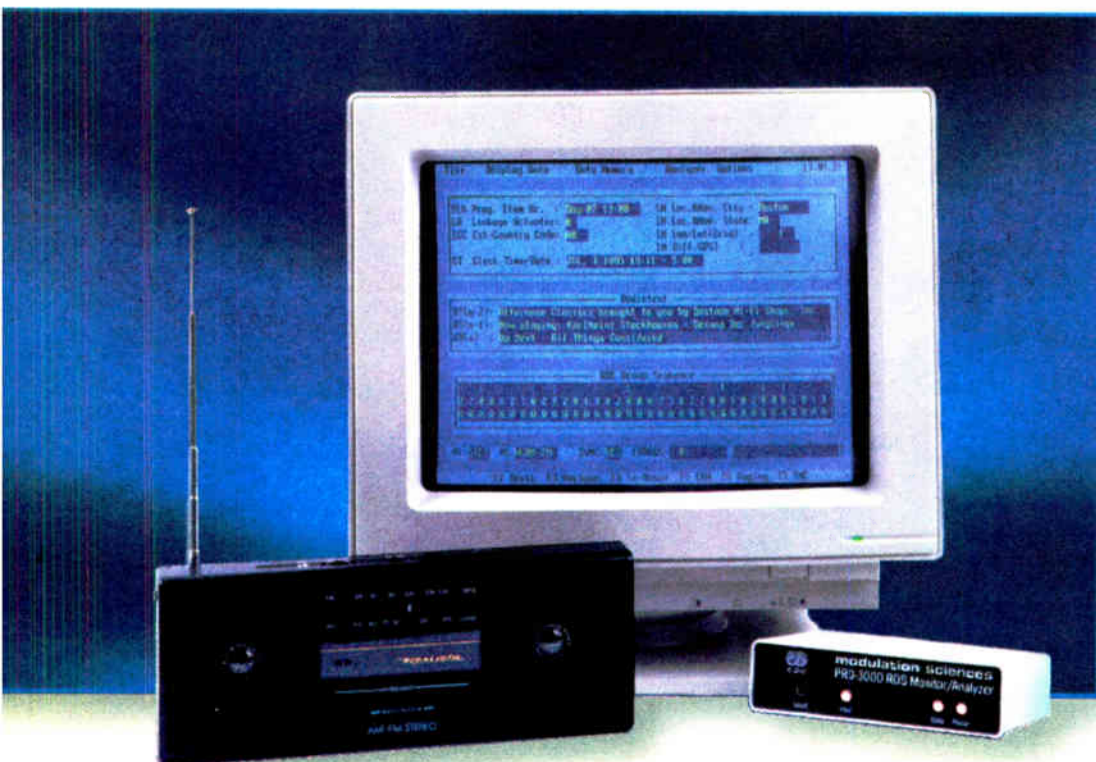

Model PRD-3000™ Precision RDS Decoder/Monitor/Analyzer

USER REPORT

Show Banks on Sony MiniDisc

by Craig Crossman
Host
Computer America

WEST PALM BEACH, Fla. One of the first things I wanted for my "Computer America" show was to broadcast in front of a live studio audience. As most radio studios are about the size of a small closet, I convinced the local college to loan me one of its lecture halls, complete with theater-style seats and a stage area. It is a good thing I secured the hall, because the show is now attended by several hundred people each week.

The college insisted on one condition: When the show was over, all the equipment had to be removed for normal class activities. Via the technical talents of my chief engineer, a "studio in a box" was created.

Wonder box

This four-foot-high wonder box contains microphones, headsets, mixers, a Switched 56 digital system, anti-feedback hardware and much more. I also needed a way to generate lots of sound effects and comedy bits, which are sprinkled throughout the broadcast.

Because the network is in Colorado

Springs, Colo., and I have no eye-to-eye contact with the board director, I realized that trying to cue my producer verbally over the phone would be too slow. They say that timing is everything for comedy: That goes double for a radio talkshow. This meant I had to trigger the necessary sounds.

What were my alternatives? Program carts? Those eight-track tape throwbacks?



Sony's MiniDisc essentials

I could just see myself fumbling through dozens of carts in front of hundreds of people and inserting them into a 30-pound cart machine, all the while worrying that one might not be cued up correctly. No thank you. I needed another option.

And I found it. The Sony MiniDisc (MD) platform was perfect. Using a palm-sized MZ-1 solves the weight problem of the bulky cart machine, and a single 74-minute disk holds nearly 200 sound effects and bits. It has random access to any track; it instantly cues up and the display offers peace of mind by confirming the bit that is about to be played. What a godsend.

Easy to operate

And although I am technically oriented, it is really easy to operate. Even my producer can use it (sorry Bill...). If I had one wish for this product, I would insist that the optical cable could transfer both the sound and the track titles. Currently, making a backup copy of a 175-track MD requires a lot of retyping. Hopefully, Sony and other MD manufacturers will see the light and remove this limitation.

I have since purchased the Sony MDS 501 home unit to edit my MDs at the office. One of my talkshow colleagues, Randi Rhodes, visited Computer America to see how I use the MiniDisc. She fell in love with it and has since demanded that a local affiliate station, WJNO(AM), buy her two of the professional MDS B1 models. She uses one at home and the other in the studio.

Because I host a regional version of Computer America called "Sound Bytes" on WJNO as well, I now can use my sound effects MDs on Sound Bytes too. The station's chief engineer plans to buy two more professional MDS B1 models to replace the control room's bulky 10-inch reel tape recorders. As the reel decks tape at 15 ips, each reel holds only an hour. The tiny PRMD-74 holds 74 minutes and sounds a lot better too.

Bottom line is that I can and do use three different, yet totally compatible, Sony MD models. As each model offers unique capabilities, the MD platform provides a total solution to my recording and playback broadcasting needs.

□ □ □

For information on MiniDisc, contact Sony in New Jersey at 1-800-635-SONY; or circle Reader Service 58.

Craig Crossman is a nationally syndicated newspaper computer columnist whose weekly column appears in hundreds of papers including The Miami Herald and The Washington Post. He also hosts "Computer America," which airs live from 3 to 6 p.m. Sunday afternoons on the Business Radio Network. He can be contacted at 407-640-4228.

"We Need It in the Office ... He Needs It in the Booth..."

With **PC-Companion Plus™**, the same computer can be in either place!

- **Easier Information Distribution**
Now, you can have remote access to your wires and other important data.
- **Better Physical Security**
Locate your computer in a secure area and still have round the clock access to your information.
- **User Friendly**
No complicated software to install. Just plug it in and go.

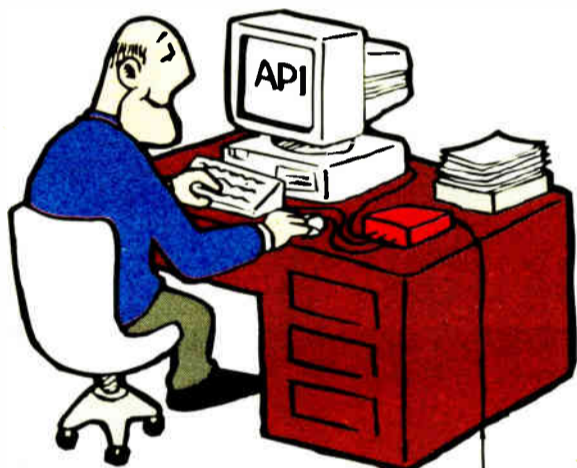

Distribute your important information without a costly and complicated network. Instead, experience the advantage of having a second keyboard, monitor and mouse up to 250 feet away from your computer. Privacy options let you control the flow of information. Whether you're in the office or the booth, your computer is still close at hand.

Options include: Audio channel, remote serial printer line, PS/2 or serial mouse, Macintosh or Sun workstation support.

CYBEX™

4912 Research Drive
Huntsville, AL 35805 U.S.A.
(205) 430-4000 • Fax (205) 430-4030

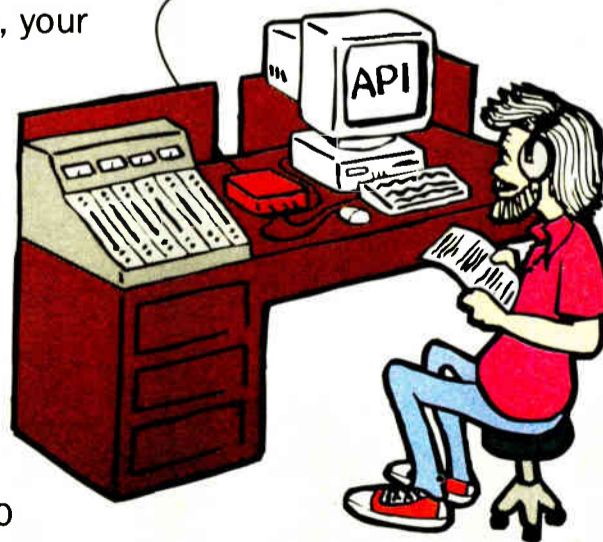

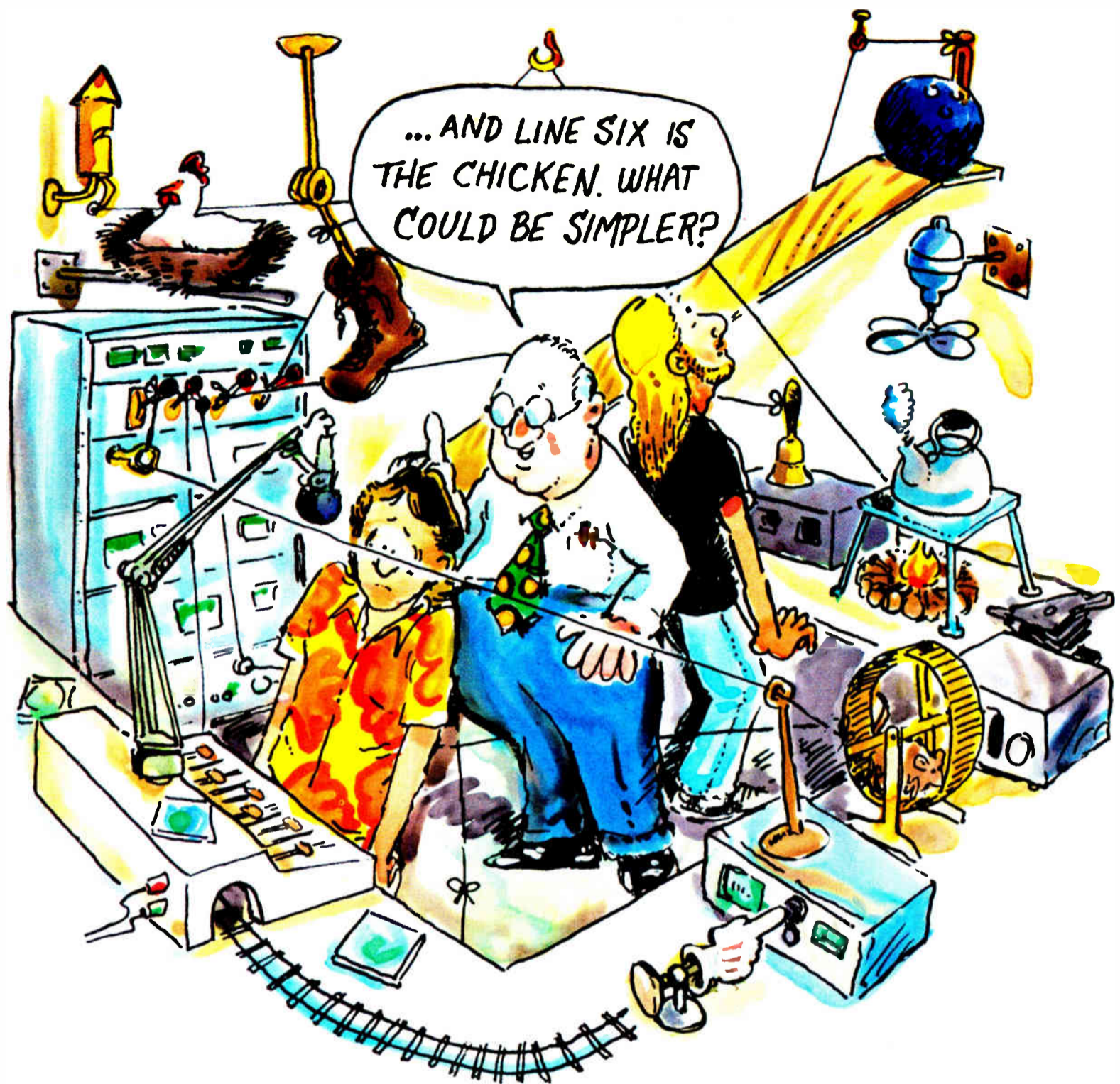

Telos is famous for making it easy to produce great sounding talk shows. With our new ONE-x-Six, you have all the equipment you need for for only \$2180. Never before has such a complete and versatile talk show system been available at such a low price!

The ONE-x-Six has it all: a Telos ONE digital hybrid, a six-line broadcast phone system, and a desktop Switch Console for system control. The ONE-x-Six lets you effortlessly screen callers, place them on-air or on-hold, and set up conferences.

Telos, the world leader in telephone interface technology, now makes it both easy and affordable for you to deliver the call-in segments and talk show programs your callers want to hear. Isn't it time you experienced the pleasure of great phones?



2101 Superior Avenue • Cleveland, Ohio 44114
216.241.7225 • FAX: 216.241.4103

USER REPORT

WACO Enters Digital Era with Scott Studios

by John Elliott
Production Manager
WACO-AM-FM

WACO, Texas Since switching from analog to digital production some eight months ago, the CompuCart Production Bank System from Scott Studios has been the real workhorse for airing and storing our commercials, promos, PSAs, sweepers and IDs.

Selecting a digital on-air playback system was very difficult and at times frustrating—all these technical terms that only engineers can understand. Then there was the question of overlapping.

Clear choice

Would the system overlap the commercials or would there be a slight pause between spots? Last but not least, there was the cost. After months of research, meetings and demos, the CompuCarts Production Bank System from Scott Studios stood out as the clear choice.

After years of working with carts and cart machines, the CompuCart system was a welcome sight. Not only did it bring our production into the digital age, it did so with simplicity. The system is functionally the same as a cart machine, but with CD-quality audio and the ability to provide audio to multiple studios simultaneously.

There are at least two computers in the system: the Production Bank, a digital audio recorder/player in the production room, and the CompuCart, a dedicated computer in the on-air studio.

All commercials, PSAs, promos, sweepers and IDs originate from the Production Bank hard disk and can be played instantly from either studio computer without interfering with the other. This lets you record into the production room computer while the on-air computer accesses recorded material from the same hard disk at a 44.1 MHz sampling rate (faster or slower, if you prefer).

Many features

The Scott Studios system includes a number of valuable features. For example, if an advertiser wants to rotate more than one commercial, it is no problem. When one commercial is played, the next immediately becomes ready, and you have the ability to rotate up to 26 spots. The best part is, if the advertiser wants to pull a spot from rotation, it can be done without redubbing the other spots again.

In the on-air studio, the CompuCart computer displays six virtual cart players on a touchscreen. Once a spot is loaded, all of the information about the commercial is displayed on the front of the virtual machine into which it is loaded.

When you are ready, you can start the first commercial by touching the screen or by using the keyboard. You also have the option of manual or automatic playback from ten "Hot Buttons" for unscheduled jingles, sounders and voiceovers.

Finally, the CompuCart computer interfaces with our commercial log scheduler via local area network (LAN) cards and wires from the on-air studio to the traffic office. It seamlessly imports traffic logs to the on-air studio.

Minor problems

We have encountered some minor problems. The computers sometimes do funny things at the most unfunny times. If you choose to link the CompuCarts system with a traffic computer via LAN and the computer in the traffic office crashes, you have no access to all the commercials, PSAs, promos, jingles and whatever else you put into the computer.

Also, all the on-air material is accessed from the Production Bank Computer in the production studio. Therefore, the production room computer can never be turned off.

There is a weather factor too. Lightning and computers simply do not mix. We have taken every known precaution to protect our equipment from this villain. We have

installed surge and spike protectors, along with other protective devices, but hopefully we will not need them.

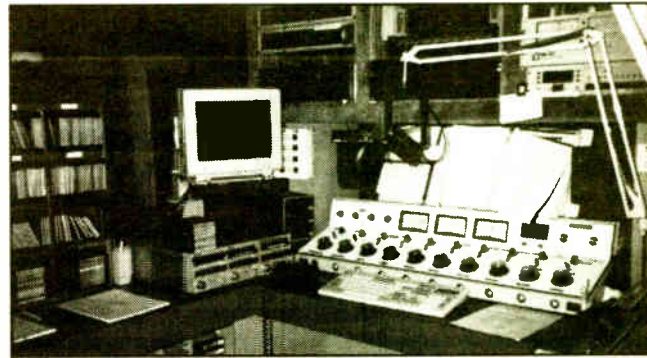

Scott Studios' CompuCart sits unobtrusively in the corner.

For information from Scott Studios, contact David Gerety, director of sales, in Texas at 800-330-3004; fax: 214-620-2707; or circle Reader Service 108.

Denon DN-650F Packed with Features

► continued from page 34

the player to their unique requirements.

There is even an "END MON" pushbutton, which plays the last few seconds of a selected track. Using the customized programming feature, END MON can be set to play from five to 35 seconds of the end of each cut, programmable in five-second increments.

Standard features

The DN-650F also incorporates the standard professional CD player features, including automatic cueing, instant or delayed start, end-of-message (EOM) indication, and single-cut or continuous playback.

The DN-650F is the ideal next step up from consumer models, and its added features make the player a good investment for either on-air or production use. Given its discounted price, particularly when you compare this model's cost to that of a consumer player and a line level matching device, you will be hard pressed not to buy it.

It is hard to think of what else Denon could offer in this model, because they seem to have thought of everything. I did come up with one idea that I hope will set their engineers thinking. At both of our test stations, DN-950/951 series CD cart machines are in use. These machines use a plastic cartridge or jacket

to hold the CD—helping to keep fingers off the disc and to reduce scratches and breakage.

We tested the DN-650F in each station's production room. The most frustrating thing was removing the CD from the plastic jacket in order to play it in the DN-650F. Although most production effects were played back on an old Studer and did not use the sleeves, any current music that we want to dub into a spot or promo had to be removed from its cart shell.

If Denon can develop a CD slot or tray that accepts both naked CDs and CDs already in the plastic cart shell, versatility would be greatly improved. The higher-priced and more versatile CD cart machines could stay in the control room, and a more production-oriented DN-650F could be used in the production room. If such development were incorporated in a model priced comparably to the DN-650F, I think Denon would quickly sew up the market.

Until such a feature becomes available, if you do not use jacketed CDs, consider the DN-650F as a quality, lower-cost CD player with a number of features not found elsewhere.

□ □ □

For information from Denon, contact Mike Stelts in New Jersey at 201-575-7810; fax: 201-808-1608; or circle Reader Service 101.

John Bisset is a principal of Multiphase Consulting, based in Springfield, Va.

First class quality

First class performance

Incredible price! — \$995*

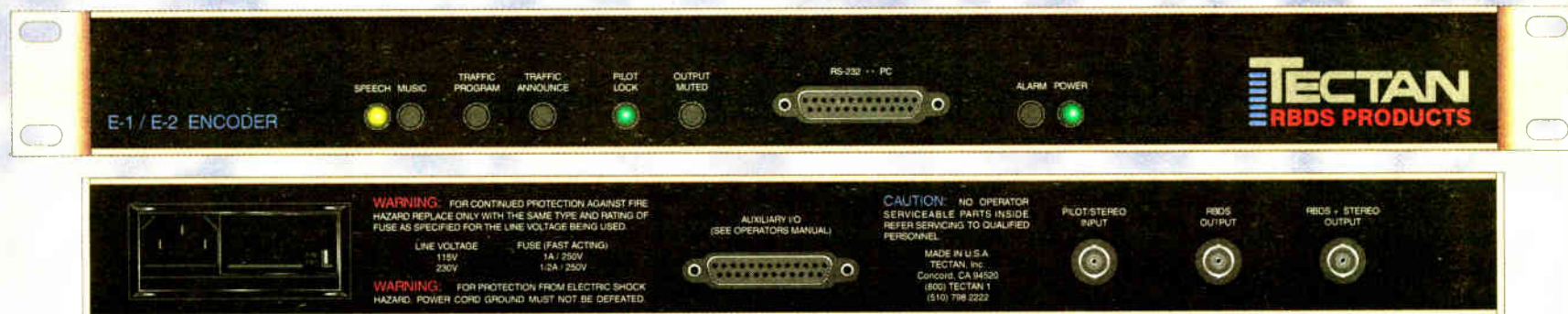

No-compromise RBDS just became affordable!
Phone 1-800-TECTAN-1 for details.

* Limited time introductory price for E-1 Encoder. Introductory price for the E-2 Encoder is \$1195. Shipping & handling \$25 additional for 2-day air shipment anywhere in the U.S.A.

INDUSTRY ROUNDUP

Cart Replacement Debate Continues

by Whitney Pinion

WASHINGTON The replacement of cart machines with digital alternatives is not a new topic. In fact, each year for the past four or five years, industry players are asked the same questions: How much life is left in the NAB cart machine, and what are broadcasters actually doing with the digital technology available to them?

"In terms of measurable numbers, someone will probably always have a cart machine and cartridges," says Charlie Bates, vice president of marketing, ITC. "We've got over 120,000 machines out there." He says that with an estimate based on the total number of cart machines in use, ITC delivered \$6 billion worth of commercials last year.

However, Bates says, the company's sales of new cart machines are declining each year at a measurable, predictable rate. In fact, a large share of ITC's business comes from refurbishing its existing

machines rather than constructing brand new ones.

Radio Systems realized too late that analog cart machines would not be fast-moving, money-making products. The company entered the analog realm four years ago with the creation of the RS2000. "We thought there was plenty of market and plenty of time left for analog cart machines," says Dan Braverman, president. "We were wrong."

Braverman says that he still considers cart machines to be a very appropriate, dependable medium, but "we obviously believe strongly that digital is now."

Declining cart machine sales are no surprise to Dave Scott, president of Scott Studios. "I don't hear people saying, 'Ok, we're building a new radio station, so I need 15 cart machines,'" he says. Stations do not abandon existing equipment just because there's something new, he says, but if a station moves to a new facility or if stations combine, as in the case of a duopoly, then

converting to digital equipment makes sense.

Scott favors upgrading to a hard disk digital audio system, explaining that both acquisition and maintenance costs are considerably lower than those of cart machines. Other benefits of a hard disk system include improved audio quality, automation and the ability to pre-record tracks and log advertising spots.

Another argument for a hard disk system is increased efficiency. "With hard drive, everything is available at every desk," Scott says.

And therein lies the problem, according to Barry Klane, national sales manager for Denon. With any PC-based system, broadcasters face the risk of the system crashing at some critical moment. This is not the case, he says, with a removable medium like minidisc. "With removable media, you pull it out of one machine, put it into another and, boom, you're back on-line," he adds.

"Of all the systems I've seen in the past 18 years, minidisc shows the greatest promise because of its editing capability, its alpha-numeric storage and its standardization," Klane says.

Scott calls the minidisc "a nostalgic effort that really doesn't have any sense in a radio station."

"There's no question that it is nostalgic," Klane says, but, at the same time, minidisc perhaps encourages those broadcasters who are a little more resistant to new technology to venture into the digital domain.

And there is still hesitation. "We've had people come to us with their fingers burned really badly from buying digital systems that just didn't work," Bates says.

These bad experiences, Braverman says, are most likely the result of using digital systems that were not sophisticated enough to meet stations' needs. Today's digital systems began as automation systems that were not originally intended to replace cart machines, he says, although that's how they were being promoted and used.

But you don't regress after an experience like that; you try a better system. "In the second round," Braverman adds, "maybe people will start realizing they can't buy toys to do this difficult job."

Pioneer Gives KWJJ a Boost

► continued from page 34

lag time between songs, assuring full system productivity. With our old system, the operator had to shuffle through stacks of discs, as well as be concerned about accidental coffee stains, scratches or fingerprints on tracks.

Saves time

The Pioneer CAC-V3000 also gives our staff time to concentrate on producing a live show rather than handling the mechanics. In smaller radio markets, the CAC-V3000 also might be used to run all night unattended. During the day DJs can pre-record the news and announcements using the computer's hard drive and CAC-V3000.

Measuring only a little over 23 inches high and fitting in a 14-inch-square footprint, the CAC-V3000 takes up very little space. It fits easily into our control room. Connected to a 486DX66 IBM PC-compatible computer running Mountain Horizons software, everything is contained in one box.

As far as maintenance goes, the unit has operated flawlessly 24 hours a day, for more than eight months. It is smooth and fast, which in itself is a testament to the machine's reliability.

The autochanger has become the heart of our radio station. The technology incorporated into the Pioneer CAC-V3000 even lets us automate certain dayparts.

Finally, technology has caught up with the radio industry.

□□□

For information from Pioneer, contact Lynn Regino in New Jersey at 201-236-4152; fax: 201-327-9379; or circle Reader Service 211.

People, Promotions and Appointments

USA Radio Network appointed **David F. Reeder** vice president and general manager of network operations.

James R. Cote joined **UNR-Rohn** as vice president of marketing and sales.

Brad Lunde joined **Aphex Systems** as director of sales and marketing.

ASC Audio Video Corp. expanded its sales staff for the Virtual Recorder digital random access storage and retrieval system with the addition

of **Sharon Bell** as district sales manager for Southern California.

Primestar Partners, the direct broadcast satellite service, named **Donald Herr** senior vice president and **Marcus Evans** senior vice president and general counsel.

Radio Design Labs Inc. (RDL) appointed **Hugh Wilcox** vice president and general manager of the company. Wilcox oversees all aspects of RDL day-to-day operations.

Bill Reich was promoted to the manager of sales administration for **Narda**.

Andrew Corp. named **Floyd English** chairman of its board of directors. He also serves as president and chief executive officer.

Company News

E-mu Systems Inc. announced a joint sponsorship of the **Bay Area Audio Manufacturers (BAAM)** and **AES** party to have been held at San Francisco's Exploratorium on Nov. 10. It will coincide with the 1994 San

Francisco AES Convention.

For information and tickets, contact **Donna Vivero** at AES at 212-682-0477.

A number of software manufacturers have agreed to create software to help enhance the functions of **Yamaha's** new **ProMix 01** programmable digital mixer. Among the companies already on board are **Mark of the Unicorn**, **Opcode Systems**, **Lone Wolf**, **Emagic**, **Steinberg** and **Voyager Sound**.

QMI continues to expand the range of products it distributes with the addition of the French company **Nexo's** sound reinforcement loudspeakers.

To better serve its customers in Latin America, **Crouse-Kimzey Co.** of Fort Worth, Texas, supplier of professional audio and broadcast equipment, opened a satellite office in Laredo, Texas.

The office is headed by **Eloy Guajardo** of Monterrey, Mexico, and is located at 215 West Mayberry Street, Laredo, Texas 78041; telephone: 210-727-7434.

Tittle & Associates of Anchorage, Alaska, were appointed exclusive sales representative for **Panduit** products in Alaska.

Jampro Antennas Inc. opened a new East Coast sales office in Fort Lauderdale, Fla. This office provides direct sales and customer service to Jampro customers east of the Mississippi River. The phone number for the new office is 305-771-7180.

Italian transmitter manufacturer **Iteco** recently reorganized its forces to better serve customers. For information on Iteco products in the U.S., contact **Alberto Giorgini** in Iteco's Miami office at 305-715-9410; or fax: 305-715-9494.

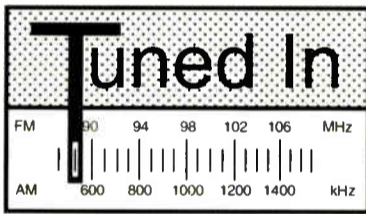

TXL-110, TXL-210

Transmission Limiters

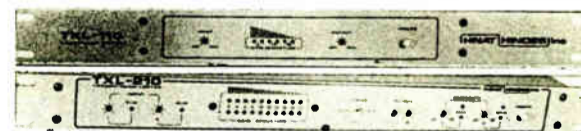

ENVIRONMENTALLY SAFE... NO EAR POLLUTION...
Just CLEAR, BIG DIMENSION SOUND.

Today's digital audio imposes a new requirement on broadcast transmission systems, particularly audio processors.

The TXL series Transmission Limiters are designed to preserve your program resource and deliver it intact to the transmission system, without the familiar processing residue that cost rating points.

The TXL series limiters are also safe to your FINANCIAL ENVIRONMENT... (No slick, multicolor full page ads to pay for).

CALL TODAY... For more on the TXL-110 & TXL-210 capabilities.

HINAT HINDES Inc

42 ELAINE ST., THOMPSON, CT 06277
203-935-9066 / 9242 FAX 203-935-9919

Products & Services Showcase

For more information on the products shown below, circle the appropriate Reader Service No. (s) on the enclosed Subscription/Reader Service card or contact the advertiser directly.



THE CELLULAR DIFFERENCE

- Easy to Use
- Reliable
- Cost Efficient
- Portable
- Flexible



Technology & convenience combine to bring you on-the-spot remote broadcast capabilities with excellent sound quality. Cellular transceiver, frequency extender, and mixer all in one! Powered by Ni-cad rechargeable batteries or AC power supply — utilizes cellular technology or land lines.

For more information call

1-800-852-1333

READER SERVICE NO. 112

AUTO-ANSWER TELEPHONE COUPLER

Ideal for unattended situations such as listen lines, IFB feeds, dial-up networks, remote transmitter sites & satellite links.

- Clean connection to phone line
- Easy to install
- Send or receive program
- F.C.C. registered



COMREX

Comrex Corp., 65 Nonset Path, Acton, MA 01720
Tel: 1-800-237-1776 Fax: 508 635-0401

READER SERVICE NO. 72



Econco REBUILT POWER TUBES



Approximately One Half
the Cost of New

3,000 Hour Unconditional Guarantee

Call for Our Price List

Econco 1318 Commerce Ave. Woodland, CA 95695
Phone: 916-662-7553 Fax: 916-666-7760 Telex: 176756
Toll Free: 800-532-6626 From Canada: 800-848-8841

READER SERVICE NO. 13

Excalibur Electronics CDA-1

Composite Distribution Amplifier



This 1 in, 3 out distribution amplifier allows you to distribute stereo composite and/or subcarrier signals as easily as audio.

- ♦ DC-100 kHz frequency response
- ♦ 90 dB signal/noise ratio
- ♦ +6 dB to -20 dB gain range
- ♦ Individual 20-turn output trimmers
- ♦ 1 1/4" rack mount enclosure

EXCALIBUR ELECTRONICS, INC., CHANTILLY, VIRGINIA
Please circle our bingo number for a data sheet and a dealer list.

READER SERVICE NO. 158

Crown's Winning FM Transmitters

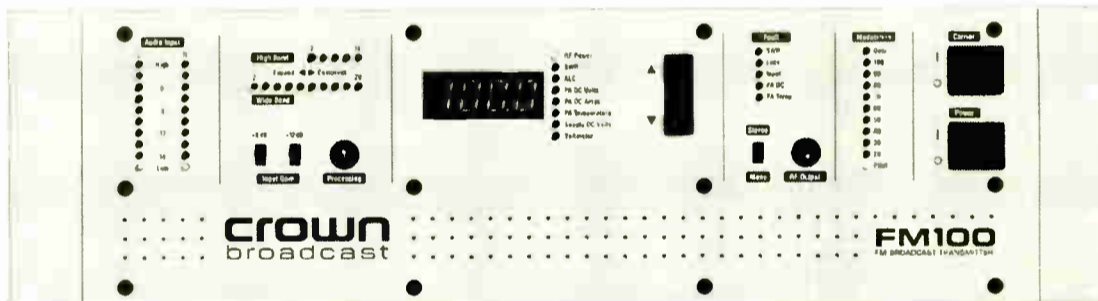

Crown's Complete Solutions For:

- Stand alone transmitter package
- Community and campus radio
- FM translator service
- Back up transmitters
- FM exciters



A Division of Crown International, Inc.
219-294-8000 Fax: 219-294-8329

Broadcast Sales: 219-294-8050

Call for other solutions

READER SERVICE NO. 17

AUDIO BROADCAST GROUP, INC. introduces the dramatically redesigned for 1994/95 Data Stream Series of our exclusive "Digital Ready" Studio Furniture. Created specifically for the efficient housing and operation of today's digital hard drive storage/studio automation systems and workstations. Our designers have combined the ultimate in functional work space and eye pleasing appearance.



AUDIO BROADCAST GROUP, INC. Supplying broadcast equipment and studio systems with integrity to the broadcasting community for over 33 years.

AUDIO BROADCAST GROUP, INC. Your single source supplier of AM/FM studio packages, AM/FM transmitter installations, as well as all major lines of on air and production studio equipment.

For additional information on how we can serve you, please call today

MAIN SALES OFFICE

2342 S. Division Avenue
Grand Rapids, Michigan 49507
Phone: 800-999-9281
Fax: 616-452-1652

SOUTHEASTERN SALES OFFICE

200 Fareway Drive, Suite 2
Smithfield, North Carolina 27577
Phone: 800-369-7623
Fax: 919-934-8120

WESTERN SALES OFFICE

P.O. Box 1638
Palmdale, California 93550
Phone: 800-858-9008
Fax: 800-273-3321

For over 33 years



**AUDIO
BROADCAST
GROUP**

READER SERVICE NO. 75

Attention Advertisers

Reach **22,000+** radio station owners, managers, engineers & consultants!

Products & Services Showcase appears bi-monthly in the pages of **Radio World**.

For more information, contact **Simone Mullins** at

Radio World

P.O. Box 1214
Falls Church, Va
22041

Phone:

800-336-3045

FAX:

703-998-2966



TECHNOLOGY UPDATES

TASCAM

Tascam CD-601 Loaded with Features in Half-Rack Case Unit Fully Programmable

MONTEBELLO, Calif. Housed in a half-rack casing, the Tascam CD-601 CD player incorporates frame-accurate search capability, auto-cueing, "preview" monitoring, single and continuous play modes and instant start capability with the optional BU-2 RAM buffer.

The auto cue function includes four user-selectable sensitivity levels and also offers two means of locating program material.

The CD-601 can be programmed to play continuously or stop at the end of a selected track. Additionally, the unit can display elapsed or remaining time, show the track number, index number and the pitch control value, which can range +/- 9.9 percent in 0.1 percent increments.

The rear panel of the CD-601 provides balanced +4dBm XLR connectors as well as unbalanced -10 dB RCA jacks for analog outputs. There is also an XLR con-

FIDELIPAC

Fidelipac's Dynamax DCR-1000 Series Offers MO Disk Drive Option

MOORESTOWN, N.J. The Dynamax DCR1000 series digital recorder/reproducer from Fidelipac is now available with an optional 230MB magneto-optical (MO) disk drive. Each removable 3.5-inch diskette stores two hours of stereo audio at 15 kHz bandwidth, or nearly six hours of mono at 10 kHz.

A remote-control device provides immediate random access to any of the 99 separate cuts that may be recorded to a single diskette. Header information is displayed simultaneously on the LCD screen of the unit during operation.

A satellite automation mode for unattended operation is possible with the extended storage times available with the MO disk. The DCR1000/MO can operate in a live-assist mode during the day and then operate unattended at nights with a satellite feed under RS-232 control.

For information, contact Bob McNeill in New Jersey at 609-235-3900; fax: 609-235-7779; or circle Reader Service 170.

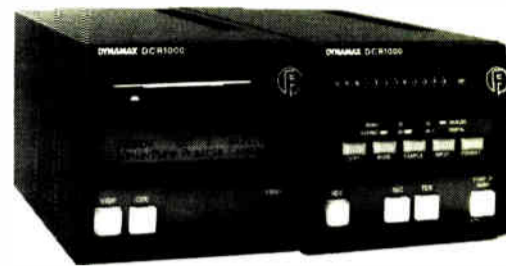

nect for digital output to feed external D-to-A converters (optional IF-601 for AES/EBU digital output) and a 9-pin serial control port for fader start or cascading multiple CD-601s via Link Play. For connecting the RC-601 remote control, a 15-pin D-sub connector is also provided.

For information, contact Tascam in California at 213-726-0303; fax: 213-727-7656; or circle Reader Service 95.

HARRIS ALLIED



Harris Allied's Audio-Metrics CD-10 Controls Designed to Resemble NAB Cart

RICHMOND, Ind. The Audio-Metrics CD 10 cartridge machine from Harris Allied is sized so that three units can be mounted side by side in a rack. CD titles are clearly visible from the front of the unit, and an autolock feature makes it virtually impossible for a jock to accidentally

eject a cartridge during playback.

CD 10 controls are designed to resemble those on NAB cart machines. A jog/shuttle wheel on the front panel performs search-and-locate functions and permits a user to search forward into the next track or reverse into the last track.

A large flashing indicator on the front panel displays end-of-message (EOM) data; the front display also shows remaining or elapsed time.

The CD 10 features Sony three-beam optics, a one-bit A/D converter with eight-times oversampling and an FDNR analog filter.

A heavy aluminum deck panel provides shock isolation from the chassis, and low-heat generation and ventilation provide for a cool-running machine. Vertically-slotted plug-in cards afford easy access and service.

With the CD 10's IEC II output, direct digital dubbing is as easy as running a cable with appropriate connectors from the CD 10 to a DAT machine.

For information, contact Harris Allied in Indiana at 800-622-0022; fax: 317-962-8961; or circle Reader Service 63.

NSM

NSM CD Autochanger Features 50-Disc Magazine System, Two-Year Warranty, Modular Construction

BRENTWOOD, N.Y. Manufactured by NSM A/S of Germany, the 3101AC 100-disc CD autochanger features an interchangeable 50-disc magazine system and individual disc carrier trays that ensure wear-free disc handling. Average disc change time is under 5 seconds. Employing the Philips CDM-4 drive with an industrial laser and Philips bitstream decoders, the system delivers a high-quality audio signal.

The 3101AC offers an average mean time between failures (MTBF) of 40,000 hours and a fully modular construction. The jukebox is backed by a two-year parts-and-labor warranty.

Automation systems from Broadcast Electronics, Sentry Systems, The Management, TM Century, ITC, Scott Studios and other manufacturers provide control interfaces to the 3101AC. Arrakis Systems is currently developing an interface that should be available shortly.

Software to facilitate operation of up to 16 NSM autochangers is now available. The software packages provide for complete cataloging of the disc library and compilation of custom playlists. Some programs offer enhanced features such as automatic time scheduling of playlists and automatic random list generation. Software is available for Windows, DOS and Macintosh platforms.

For information, contact Jon Taylor at Euroson America in New York state at 516-273-4200; fax: 516-273-4240; or circle Reader Service 203.

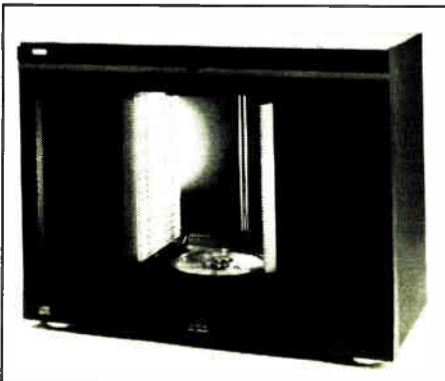

8 TRACK DIGITAL EDITING BREAKS PRICE BARRIER \$5,495*

- A digital audio editor designed for Radio production
- Learn to use in minutes, much faster than tape
- Cut, splice, move, and fade up to 4 stereo tracks
- Use Scrubbing to edit with your ears
- Use visual waveform editing to edit with your eyes
- An UNDO button enables you to go back and fix mistakes
- Digital Networking to transfer audio to your On Air machine
- Add Trak*Star-8 software to a Digilink for only \$2,000

Trak*Star-8 is the first cost effective multitrack digital audio editor designed for the radio broadcast professional. Fast and easy to use, produce your commercials on Trak*Star and then transfer them in digital straight to the Digilink in your On Air studio. Dramatically reduce production time and save money !!!

For more information, call or write
ARRAKIS,

(303) 224-2248

Consoles
Modulux
Trak*Star
Digilink
Modulink

the premier broadcast manufacturer of consoles, furniture, Digilink and Trak*Star digital audio products.

ARRAKIS

* Suggested retail price. Complete system

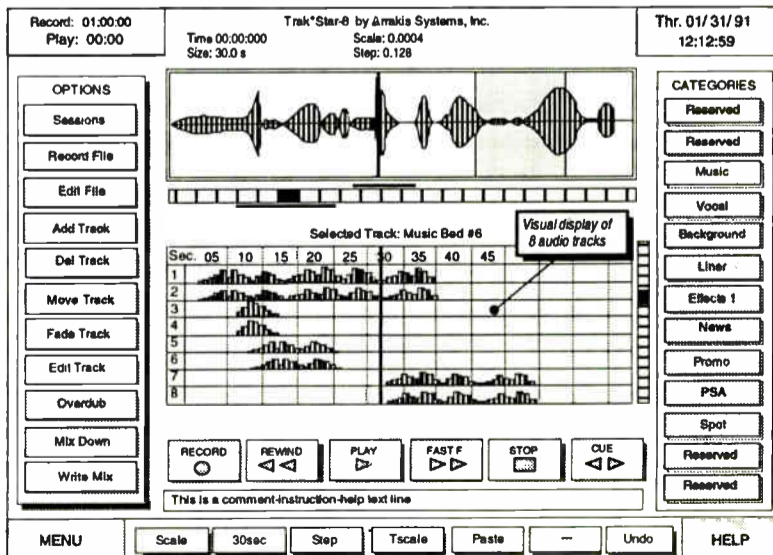

© 1993 Arrakis Systems inc. 2619 Midpoint Drive, Fort Collins, CO. 80525

Circle (149) On Reader Service Card

Products & Services Showcase

For more information on the products shown below, circle the appropriate Reader Service No.(s) on the enclosed Subscription/Reader Service card or contact the advertiser directly.

WEATHER RADIO Model CRW



Price \$540.00

Sensitivity .28 microvolts for 12 dB quieting. All 3 frequencies. Alert tone demutes receiver, closes relay and gates audio to 600 ohm rear terminals. Another set of rear terminals has continuous 600 ohm audio output. Double conversion crystal controlled, crystal filter in first I.F., ceramic filter in second I.F. Dual gate MOS FET front end. 50 ohm coaxial input. Adjacent channel (j25 kHz) down to 70 dB. 19" rack mount, 3 1/2" H, all metal enclosure. In stock—available for immediate delivery.

GORMAN REDLICH MFG. CO

257 W. Union St. • Athens, Ohio 45701
Phone 614-593-3150 • FAX 614-592-3898

READER SERVICE NO. 201

Composite Audio DA and Switcher!



The CDS 200 Composite DA/Switcher

APPLICATIONS

- Switching Between Composite STL's
- Main/Alternate Processing Switching
- Feed Two Transmitters and an RDBS Encoder
- Feed one SCA Generator to Two Transmitters
- Distribute Composite with the Ease of Audio

FEATURES

- 2 Input Switcher
- 3 Isolated Outputs
- Individual Level Control for Each Output
- Front Panel and Remote Control with Full Status
- Power Fail Memory with Bypass Mode
- Inputs Selectable for Balanced or Unbalanced Operation
- Front Panel Test Jack



Broadcast Devices, Inc.
5 Crestview Avenue
Peekskill, NY 10566

Tel: (914) 737-5032 Fax: (914) 736-6916

READER SERVICE NO. 62

The world's most capable, expandable digital satellite receiver

More and more networks are moving to Satcom C-5 digital. Why take a chance on a less expandable receiver?

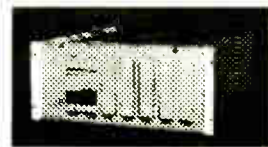

Ariel

Used Equipment for All Satellite Formats LNA/LNB/Splitters

Zephyrus for JSA
Zephyrus 700 SPCP

Visa/MC/Discover
Leasing W.A.C.

Satellite Systems
(719) 634-6319

We Repair & Rebuild all Popular Receivers Quick Service! 24 Hour Tech Support

READER SERVICE NO. 59

DIGITAL AUTOMATION SYSTEM

- The Best Integrated Play List Scheduler (Music & Breaks) & On-Air Playback Combination Available Today
- Music on Hard Disk and/or CD Jukeboxes
- Dolby AC2 Overlapping Hard Disk Audio



- Feature Rich Digital Automation at an Affordable Price & Updated Quarterly
- Complete On-Line Redundancy
- Provide Your Own Computers/Players and Save \$\$\$, or Buy/Lease From Us
- Pays For Itself By Increased Productivity

WEST/INT'L
310/670-7500
FAX 310/670-0133

EAST
803/370-2400
FAX 803/370-2314

READER SERVICE 19

AXS (Ax'-sess)... Jocks Love It!

AXS is an entirely new approach to digital audio controllers. It starts with superb audio using the premium quality apt-X™ system. AXS is easy to learn, easy to use, and powerful beyond words.

AXS is a modular design that begins as a simple cart replacement and grows to any combination of CD, hard disk, satellite or specialty programming with ease.

AXS has all the sophisticated feature options including device independent multi-channel background audio record and replay. Macro programming makes tough to run event sequences easy. Software drives a powerful programmable real time IOMAP.

Jocks love AXS: A fast 99 page, 28 button Jock F/X panel that can be time linked and remote wired is standard.

Use a software driven four-channel stereo audio switcher with on-screen control or the powerful eight-channel dual-buss routing switcher. or include both if you wish. AXS is controlled through a trackball, touchscreen, keyboard, buttonbox, telco or remote modem.

AXS Systems...

From \$6000.00 using your 486 computers and hard disks.

READER SERVICE NO. 150



AXS

The Management

800-334-7823 • 817-625-9761
FAX 817-624-9741

P.O. Box 1-36457 Fort Worth, TX 76136
1700+ Stations • Our 14th Year

Call MYAT For Rigid Line & Components

Facing a "right now" emergency? Planning a new installation? Upgrading your facility? Whatever the need, MYAT is the solution. MYAT products are quality-built for maximum performance and long life. And we take delivery commitments seriously.

Call your favorite RF distributor or MYAT direct at 201-767-5380, or fax 201-767-4147 for our complete catalog and reference guide.



380 Chestnut St

P.O. Box 425

Norwood, NJ

0 7 6 4 8

READER SERVICE NO. 216

Attention Advertisers

Reach 22,000+ broadcast equipment buying prospects at AM, FM and AM/FM radio stations, networks and groups, recording studios, engineering and consulting firms every month.

Products & Services Showcase appears in every issue of Radio World. To advertise your product or service, contact Simone Mullins at

RADIO WORLD

P.O. Box 1214

Falls Church, Va 22041 USA

Tel: 1-800-336-3045

FAX: 703-998-2966

PANASONIC

Panasonic Pro-DAT Offers Instant Start, External Sync

CYPRESS, Calif. The SV-4100, a new Pro-DAT machine from Panasonic, offers instant start and external sync capability. The SV-4100 features a software-enhanced digital interface, accurate PNO/cue assignment and programmable output level control.

A remote controller, which plugs into the unit's parallel control port, enables the operator to select a target PNO; the SV-4100 then automatically cues to that location.

Various sync modes can be selected from the front panel of the SV-4100, including internal sync clock, external 25 Hz PAL video, external 30.0 Hz NTSC video/film and external digital I/O, either AES/EBU-type or consumer format.

Analog and digital output levels can be continuously adjusted between 0 dB and -14 dB or selected between four preset values, 0 dB, -2 dB, -4 dB and -6 dB.

For information, contact Lynn Thompson in California at 714-373-7277; fax: 714-373-7903; or circle Reader Service 76.

BE

AVAir Increases Flexibility, Creativity of BE Digital System

QUINCY, Ill. Broadcast Electronics added a new live radio screen and control interface to its AudioVAULT Digital Studio System. Called AVAir, the new system advances the functionality of digital hard-disk audio in the live control room.

Using the AudioVAULT system's Windows interface, AVAir allows on-screen access to the entire digital audio inventory of a station, including commercials and hard-drive-based music. All lists of stored audio cuts can be brought up with a single action of touch-screen, mouse, trackball or keyboard.

The operator can "drag-and-drop" selected audio "cuts" into on-screen "decks" to build a sequence of events. The AudioVAULT system allows the announcer to start up to 16 events simultaneously—manually or automated—sending them through separate console faders or ganging them on one or two.

In addition to the increased flexibility and creativity provided by AVAir, the system fully integrates AudioVAULT with other control room equipment, allowing the station to control audio processors, routing switchers, phone systems or consoles, using the same drag-and-drop technology.

For example, starting a network recording or switching to a news studio for a newscast can be dragged from an AudioVAULT log and dropped into an on-screen deck. It then can be executed with a touch-screen command. AudioVAULT and AVAir make complex broadcast operations simple and invisible to the operator.

For information, contact Dave Newton in Illinois at 217-224-9600; fax: 217-224-9607; or circle Reader Service 53.

ITC

ITC Turns Out, Refurbishes Time-tested Cart Machines

BLOOMINGTON, Ill. For more than 25 years, International Tapetronics Corp. (ITC) has manufactured cart machines. In 1969, ITC created the Premium Line cart machine. More recently, ITC produced the Series 99B cart machine. The Series 99B features a bullet-proof design and contains ELSA, ITC's cartridge eraser/splice locator/auto azimuth feature.

The Delta Series, the company's mid-priced mono or stereo cart machine, comes in single- and triple-deck versions. Products in the ITC Series I and II use advanced technology in servo-control and microprocessor-based diagnostics.

In addition to producing new cart machines, ITC refurbishes used cart machines and accepts trade-ins of its equipment toward the purchase of its digital system, the ITC DigiCenter.

For information, contact Charlie Bates in Illinois at 309-828-1381; fax: 309-828-1386; or circle Reader Service 143.

MOVING?...

Don't leave us behind!

Mail or fax
your current label
and new address

(with effective date) to:

Circulation, RW,
PO Box 1214
Falls Church, VA
22041

or

FAX 703-998-2966.

Address change
will be processed within four
weeks of receipt.

HHB

HHB Offers Compact, Rugged, Portable DAT Recorder

PORTLAND, Maine The PDR1000 professional portable DAT recorder from HHB Communications Ltd. is based around a rugged, direct drive transport derived from DDS technology with four heads for confidence monitoring. Weighing less than 4.5 pounds, the PDR1000 can go anywhere the news is.

High-quality A-to-D/D-to-A converters ensure the PortaDAT's sonic superiority, and a comprehensive list of facilities includes phantom powering, balanced XLR analog inputs, selectable 32/44.1/48 kHz sample rates, SPDIF and AES/EBU digital I/O, a built-in limiter, internal monitor speaker and a full range of indexing facilities.

A nickel metal hydride rechargeable battery is included standard with the PDR1000. It can power the unit for up to two hours and totally recharges in the same amount of time.

A time-code-equipped model, the PDR1000TC, is also available from HHB. The PDR1000TC includes all the features of the PDR1000 and is capable of recording, generating and referencing to time code in all existing international standards.

For information, contact Fraizer Jones in Maine at 207-773-2424; fax: 207-773-2422; or circle Reader Service 159.

Quantum FM

Solid
State

Solid
Reliability

from

QEI

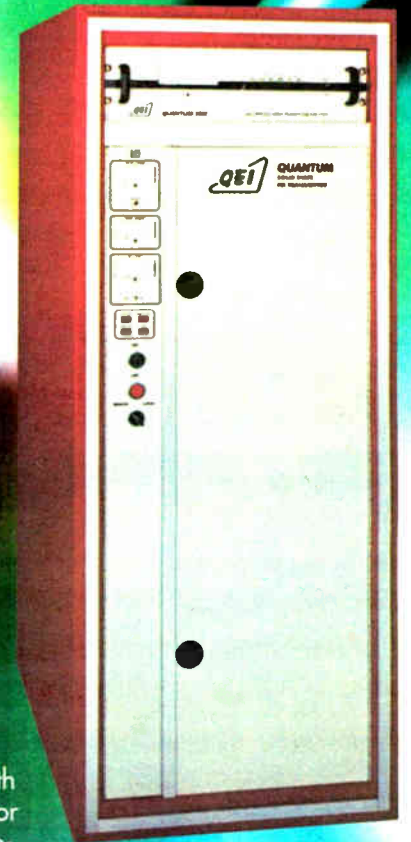

- Proven reliability
- Maintenance-free FET technology
- Self-contained modules with own power supply regulator
- Compact size reduces shipping costs, allows affordable air shipment
- Power levels between 300 Watts and 6 kW
- Modular design offers buy-only-what-you-need affordability and convenience

For the same price you pay for a tube transmitter, you can now have a superior solid state FM transmitter with high-power, advanced technology exciter and cableless combiner. The modular design of QEI's QUANTUM-Series FM transmitters offers the advantage of buying only the amount of power you need...and means that you can upgrade to higher power levels whenever you're ready.

QUANTUM from QEI—the people who have been designing and building solid state transmitters longer than anyone else in the industry.

You need to know more! Call Jeff Detweiler today toll free (800) 334-9154.

QEI Corporation
One Airport Drive • P.O. Box 805
Williamstown, NJ 08094

Tel (800) 334-9154
Fax (609) 629-1751

24-Hour Service Hotline
(609) 728-2020

FOSTEX

Fostex Integrates the D-10 Recorder into Its Line of Professional Studio DAT Recorders

NORWALK, Calif. The D-10 is the latest addition to Fostex's line of professional DAT recorders. With 8MB of RAM, the D-10 offers instant start, as well as high-quality stereo scrubbing with an easily accessible jog/shuttle wheel.

An infra-red remote controller comes standard. The D-10 also has an expansion slot for an optional 8333 board, which adds time code capabilities and an RS-424 port to the unit. Other features include program numbers, start ID, skip programming and 100 memory locations.

Transport time on the D-10 is quick. A user can search a DAT tape at 0.5, 1, 2, 3, 5, 9, 11, 15 or 250 times normal speed. Fast wind time for a 120-minute tape is approximately 50 seconds.

The Auto Cue function provides automatic locating to the start of audio modulation during ID search and tape loading. One hundred cue points can be stored and recalled with the D-10 ten-key pad.

The D-10 features both XLR/RCA selectable analog I/O and AES/EBU digital I/O. A universal GPI I/O enables rapid assembly editing based on A-time with a pair of D-10s.

For information, contact Bud Johnson in California at 310-921-1112; fax: 310-802-1964; or circle Reader Service 10.

OTARI

MR-10 Recorder/Player from Otari Fully Compatible With Any MiniDisc-Format System

FOSTER CITY, Calif. The MR-10 MiniDisc recorder/player from Otari is ideal for the radio market. It provides rapid access, as well as reliable storage and playback.



The MiniDisc (MD) format allows up to 74 minutes of randomly accessible audio to be stored in up to 99 tracks per disc. Other professional features include table-of-contents (TOC) editing; memory start, stop/standby and single/repeat play

function modes; a selectable EOM detector; front-panel headphone output with level control; and audible cue mode.

The lighted front panel includes enhanced MD information readout capabilities, including a minute-second-frame timer, track number indication, title read-out and mode indication.

The MR-10 is fully compatible with any MD-format system. It features +4 dBu active balanced I/O with XL-style connectors that can select between 600-ohm and 10,000-ohm input impedance. An IEC Type-2 (S/PDIF) digital I/O is standard on the receiver.

Each machine is equipped with a wired remote controller and an Otari standard 37-pin parallel remote connector. Options include I/O transformers and an RS-

422 or RS-232C serial remote control interface.

For information, contact James Goodman in California at 415-341-5900; fax: 415-341-7200; or circle Reader Service 217.

RADIO SYSTEMS

DDS from Radio Systems Looks Like Cart Machine, Acts Like a Digital System

BRIDGEPORT, N.J. The main interface of the Radio Systems DDS (Digital Delivery System) looks like, operates like and fits in the space of a traditional cart machine. When a DDS is integrated into a traditional studio, the learning curve is virtually non-existent and resistance to this new technology minimal.

DDS performs simultaneously in multiple studios because it is built on a UNIX-style, multi-user, multitasking, real-time operating system. Unlike systems that use DOS and rely on multiple CPUs and networks to grow, each DDS server can support multiple users, multiple studios and up to 16 simultaneous audio channels.

The system provides complete automation and live assist, as well as support for other user interfaces, such as the company's Sound-Slate instant access controller. Peripherals can be added at any time using long-distance RS-485 serial lines. Because DDS is a universal control system, it also can control CD jukeboxes, audio switchers and satellite decoders.

For information, contact Dan Braverman in New Jersey at 609-467-8000; fax: 609-467-3044; or circle Reader Service 71.

MARKETPLACE

Recently Introduced Products for the Radio Broadcast Professional

Vanguard Console Line

The Vanguard Series of consoles from Audio Technologies Inc. (ATI) is available in six-mixer/10-input, eight-mixer/12-input and 12-mixer/24-input models. All models feature dual stereo and dual mono-sum program outputs with four line input selectors for both headphone muted monitor outputs.

Available options include bright LED bar graph output displays with simultaneous VU and PPM peak readout, a two channel mix-minus telephone adapter, start-stop switches, additional microphone preamps and a dual, five-line, stereo input expander.

ATI's approach to console design allows it to produce full-function on-air boards in the \$3,000 to \$5000 range. It also yields many benefits in terms of ease of installation, longevity and performance.

For information, contact Ed Mullin at 800-959-0307; fax: 215-443-0394; or circle Reader Service 6.

beyerdynamic))))

SPL Signal Processor

beyerdynamic distributes the Optimizer, a signal processor by SPL that offers four high-quality parametric equalizers, each individually assignable to ranges from 10 Hz to 23 Hz. The unit also uses a "proportional-Q" equalization technique for precise equalization.

The variable "roll-off" response feature of the Optimizer varies the slope characteristics around the center frequency from "gentle" to "steep." Each band has an output control with a range of -60 dB to +5 dB.

For information, contact the company in New York state at 516-293-3200; fax: 516-293-3288; or circle Reader Service 118.

Custom-designed Knobs

Selco/Sifam offers custom-designed knobs for consoles, panels and control boards in an assortment of colors. The company can work with a product

designer from the initial consulting phase to the finished knobs.

Selco also offers a line of collet knobs with caps, nut covers and pointers. All are manufactured in nylon for a finely textured finish. Collets, housing and nuts fitted into the knobs are made of brass and can accommodate a wide range of shaft and bush lengths. Again, custom colors are available.

For information, contact Andrea Armenta in California at 800-229-2332; fax: 714-739-1507; or circle Reader Service 38.

FURMAN

Power Conditioner/Monitor

Furman offers the PM-8 power conditioner/monitor, which provides the power conditioning protection of the company's PL-PLUS for applications where PL-PLUS pull-out lights are not needed.

The PM-8 assists in monitoring AC line status by including an AC voltmeter (90-135V) and an RMS-reading AC ammeter (0-20A). Eight widely spaced rear outlets can accommodate bulky plug-mounted power supplies. These outlets are controlled by a lighted front panel master switch; there is one front-panel unswitched outlet as well. A 10-foot power cord is supplied.

For information, contact Joe Desmond in California at 415-927-1225; fax: 415-927-4548; or circle Reader Service 134.

Fiber-free Acoustical Panels

illbruck Inc. offers Fabrix, acoustical panels for applications that require maximum noise control. Fabrix is made of a non-woven, fire-resistant fabric backed by a porous melamine foam designed to absorb and dissipate extraneous noise. All materials are fiber-free and meet Class 1 building codes.

Fabrix panels come in a variety of colors and can be used in offices, hallways, meeting areas, etc.

For information, contact Russ Leighton in Minnesota at 612-521-3555; fax: 612-521-1010; or circle Reader Service 163.

TECHNICS



Technics Improves Its SL-1200 Turntable With Introduction Of the SL-1200MK2

CYPRESS, Calif. The SL-1200MK2 direct-drive turntable from Technics, the successor of the SL-1200, incorporates numerous improvements over the original. In addition to being

quartz-locked direct drive, it permits continuous speed adjustment under quartz control. Its starting torque is 1.5 kg/cm, with the platter reaching rated speed within 0.7 seconds from standstill.

The SL-1200MK2 is housed in an aluminum diecast cabinet with heavy rubber base material for acoustic isolation. It also features a stylus illuminator for low light conditions and a high sensitivity, low-mass gimbal-suspension tone arm.

For information, contact Technics Consumer Information in New Jersey at 201-348-9090; or circle Reader Service 126.

SINE SYSTEMS

Walkaway Specialist: Innovative Solutions

- EBS Compliance Tools
- Remote Transmitter Control & Monitoring
- Dial-up Remote Broadcast
- Program Automation Accessories & Studio Aids



(615) 228-3500
FAX 227-2367

1020 Maxwell Avenue, Nashville, TN 37206-3554

24 Hour FAX
ON-DEMAND
(615) 227-2393

Broadcast Equipment Exchange

"Broadcast Equipment Exchange" accepts no responsibility for the condition of the equipment listed or for the specifics of transactions made between buyers and sellers.

ACOUSTICS

Want To Sell

STUDIOFOAM
SOUND ABSORBENT WEDGES
TESTS UP TO 40% BETTER THAN SONEX
COSTS LESS • BETTER COLORS • BETTER CUT
1"-\$8.99 • 2"-\$11.99 • 4"-\$22.99
20/box • 12/box • 8/box (all 2"x4")
Clients: Ford Motor Co., Kodak-US Gov't
Dennis DeYoung (Styx), Rockwell Int'l-MTX
Manley Audio Labs-Warner Bros.-Editel
Bell Tel. Korch, Labs-Opryland USA-Hitachi
Baldwin Pianos-Martin Marietta-Music Bakery
Min. 1 Box • MC Visa Discover AmEx
Call For Free Samples & Brochure!
USAFOAM • Box 20394 • Hickory, NC 28220 • (704) 251-2922
1-800-95-WEDGE

Circle (7) On Reader Service Card

ROTTED WOOFERS? DON'T BUY NEW SPEAKERS. MILLERSOUND IS FAMOUS FOR OUR D.I.Y. SURROUND FOAM. ONLY \$2.95 TO 7.95. ALSO, PROFESSIONAL REFOAMING AND RECONING FOR THE PERFECTIONIST.
MILLERSOUND 201-993-5718

AMPLIFIERS

Want To Sell

Denon tuner/amp, as new, \$25. R Schweppe, WTMJ, 7155 Clark Rd, Sarasota FL 34241. 813-923-8239.

LPB DA-116, never used. J Gelo, J&H Music, POB 1697, Marco Isl FL 33937. 813-642-6899.

TEPCO RF amp J-319-10 3 outputs, tuned to 99.3 MHz, \$1750. Call 602-234-6355.

Want To Buy

McIntosh Mc60 pwr amps; KT88 or 6550 tubes, US or British only. R Glenn, WJGR, 1718 Shenandoah Dr, Wimauma FL 33598. 813-634-1940.

McIntosh MI-200 rackmount tube amp. 212-343-0265.

Record Cutting Lathes, amplifiers, records, related. 612-869-4963.

ANTENNAS/TOWERS/CABLES

Want To Sell

Andrew A10R 50507 1 5/8" coax with connectors, 275' rolls (6), \$1100/roll. S Ross, Quinn Broadcasting, 733 N Green St, Brownsburg IN 46112. 317-852-9119.

TOWER LIGHTING CONTROLS

For Aviation Obstruction Lights, Beacons, and Strobe Light Systems.

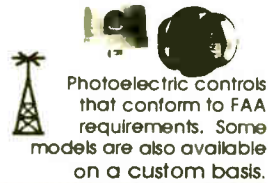

PRECISION

PRECISION MULTIPLE CONTROLS, INC.
33 Greenwood Ave • Midland Pl. NJ 07432
Tel (201) 444-0000 • Fax (201) 445-0575

Scientific Atlanta polar mounts for the 3.2 meter antenna. New in box. The S/A 3.2 az-el can be retro-fitted with a polar mount, \$450 each. Call Satellite Reception Services at 608-836-5727.

ANDREW (NEW!)

LDF#2-50, 3/8", .75/ft., LDF#7-50A, 1-5/8", 5.00/ft. HJ7-50A, 1-5/8", 7.25/ft. 87N, 1-5/8" to N, 100- Jim Mussell, 1421 Bay Ave. Santa Maria, Ca. 93454
805-922-7775 fax 925-6663

Want To Buy

FM on 104.3; also FM broadband that will operate on 95.7 and 99.7. B Lacy, KFMA, 2025 N Hwy A1A, Indialantic FL 32903. 407-773-1962.

FM on 104.3 and wide band on 97.7. B Lacy, WAVQ, 2025 N Hwy A1A, Indialantic, FL 32402. 407-773-1962.

AUDIO PRODUCTION

Want To Sell

Eventide H949 Harmonizer; Eventide FL 201 (2) instant flangers. R Schuh, KSMG, 210-646-0105.

UREI 530 graphic EQ, 9 band stereo, barrier strip input/output, exc cond, \$200. W Feinberg, Totaltape Pub, 9417 Princess Down, Tampa FL 33619. 813-621-6200.

ADC 1/4" patchbays & cords, new, under half price; ADC TT patchbays \$149 up, new cords \$9.95. W Gunn, POB 2902, Palm Springs CA 92263. 619-320-0728.



SAVE \$300 ON TT 96 & 144 POINT PATCH BAYS
brokers of fine and coarse used equipment
audio village 619/320-0728

Bulk erasers for 1/2" \$79, Stewart direct boxes mono & 4 ch \$50 up, Cue command decoder \$125, ABC Network decoder \$125, Audiotechnica ATP-12T tone arms new in box (2) \$95 ea, Eventide H949 harmonizer \$495, new Tascam midlizer MTS1000 \$750, AB 200w power amp \$249, Dyna stereo 120 rack mount amp \$229, Gates tube Sta-Level pair, both \$400, Sherwood FM tuner, new tubes \$79, Altec 250 SU classic 10x2 tube recording console, rebuilt \$2500, Infonics 7" reel copier 3 copies \$300 ea, Shure M67 remote mixers \$125, Crown & Furman elec crossovers \$95. W Gunn, POB 2902, Palm Springs CA 92263. 619-320-0728.

Good used studio tape 1/2" \$15, 1" \$30, 2" \$55. W Gunn, POB 2902, Palm Springs CA 92263. 619-320-0728.

RECORDING STUDIO EQUIPMENT: 16x8x2 CONSOLE, ANALOG RECORDERS, OUTBOARD GEAR, MONITORS, MIC'S. CALL STEVE AT 309-579-2142.

Want To Buy

Ampex tube mixers, recorders, especially MX10, MX35, 602-1 or 602-2. W Gunn, POB 2902, Palm Springs CA 92263. 619-320-0728.

MERCENARY AUDIO

WANTS TO BUY YOUR:

NEVE-SSL-TRIDENT-AMEK
UREI-TELETRONIX-FAIRCHILD
PULTEC-LANG-LEXICON
UNIVERSAL AUDIO-NEUMANN
AKG-TELEFUNKEN-AMS

ANYTHING THAT IS OF EXCEPTIONAL AUDIO QUALITY!

TOP DOLLAR PAID

"this is not a problem"
(508)543-0069 TEL
(508)543-9670 FAX

UREI 811 or 813; Tascam DA88 & remote; Mackie 24/8 or 1604; Technics SLP-1200 or 1300s; Aiwa ADF770 or 990; Shure SM57 or 58s; Sennheiser 421; EV RE20; Crown PSA2; Tascam PB64; Numark CD9000; Ashly SC77. Will buy but prefer to trade acoustic foam or acoustic foam & partial cash. Call Eric at 1-800-95-WEDGE.

AUTOMATION EQUIPMENT

Want To Sell

BE Control 16, complete or separately, IGM Go-Carts (6), Otari ARS-1000 (2), BE 2100 cart deck, more, priced to sell. M Young, WJON, Box 220, St Cloud MN 56302. 612-251-4422.

Cetec 7000 system with terminal encoder & cables, ITC PB reels (3) with racks, IGM 42 tray Go-Carts with racks, 3" disk drive, case of paper, printer, all, cables, switchers and more, all machines factory rebuilt, will deliver with in reasonable distance, BO. T Yarbrough, WCDT, 1201 College St, Winchester TN 37398. 615-967-2201.

Harris 9000, mono with power sup with new capacitors, TI Omni 800 model 840 printer, TEC 70X video screen with keyboard, Micropolis disk storage, dual drive, \$1000. Larry, WXLP, 1229 Brady St, Davenport IA 52803. 319-326-2541.

Printed circuit boards for SMC DS-20 switcher and 452 bi-directional Carousels. R Statham, WSTU/WHLG, 100 Alice Ave, Stuart FL 34994. 407-692-1000.

SMC Automation System with SSP 3060 stepper, AS-10 switcher, time clock, 700 series single play cart decks (2), Carousels with RAC-50 random access controllers, Scully 270 with outboard tone sensors (4) and one for parts, \$1000/BO. B Williams, KQLL, 5314 S Yale, Tulsa OK 74135. 918-455-9522.

SMC DX-20 switcher, brain, RAC31 remote control, power supply, PDC clock, encoder with video terminal, sell as package or by piece. R Statham, WSTU/WHLG, 100 Alice Ave, Stuart FL 34994. 407-692-1000.

SMC Carousels 250 series and 350 series with 50 step RAC controller, good condition, \$200/Best Offer. B Williams, KQLL, 5314 S Yale, Tulsa OK 74135. 918-455-9522.

SMC TS-25 tone sensors (2), each cntrl 2 tape devices, \$100/ea or BO. B Williams, KQLL, 5314 S Yale, Tulsa OK 74135. 918-455-9522.

SMC automation racks (4) 6' high, \$100/ea or BO. B Williams, KQLL, 5314 S Yale, Tulsa OK 74135. 918-455-9522.

SMC 25 Hz tone generator and 25 Hz decoder, \$200 ea/\$375 both. R Statham, WSTU/WHLG, 100 Alice Ave, Stuart FL 34994. 407-692-1000.

Sono-Mag 350 Carousel (3), 24 tray, stereo, \$1000. Larry, WXLP, 1229 Brady St, Davenport IA 52803. 319-326-2541.

SSP 3060 stepper with AS-10 switcher, controls 10 inputs with up to 60 events/hr, \$150/BO. B Williams, KQLL, 5314 S Yale, Tulsa OK 74135. 918-455-9522.

Introducing: NEW! The AUTOMATE Digital Hard-Drive Automation self-contained automation or live playback. Uses IBM(tm) 286+ compatible PC's, with SoundBlaster(tm) audio card. **Software introductory price: \$149.95!** For free information and demo disk: CALL: 503-769-2886.

Sentry FS-12C, good/excellent condition, \$2900; TS-1 also available. Call 806-372-5130.

CART MACHINES

Want To Sell

BE 3400R mono recdr, \$500; Telex rcdr, BO. B Salazar, 532 Oppenhiemer, Uvalde TX 78801. 210-278-3535.

HE HALL Electronics

706 Rose Hill Drive Charlottesville VA 22901

Here are just some of the bargains we have in stock:

Orban 8100 A/I FM Stereo Optimod -	Rebuilt	\$ 3,695
LPB 'Signature II' S-15A 8 Pot Mono Console -	Rebuilt	\$ 1,595
Tascam 22-2 Stereo Reel to Reel -	Rebuilt	\$ 695
ESE 160 Master Clock w/3 ESE 112LS Slave Units -	Rebuilt	\$ 795
CCA FM40E 40 Watt FM Exciter - Tuned to Freq.	Rebuilt	\$ 995
Marti R-450 450 MHz 2 Freq. RPU Receiver -	Rebuilt	\$ 495
Technics SP-25 w/ Base, Arm, Cartridge, Pre-Amp -	Rebuilt	\$ 359
West Penn 274 15 Conductor Control Cable 1000ft - New		\$ 149

TASCAM DA-30MKII



The DA-30MKII has all the features that made the DA-30 a best seller. In addition, it offers an improved transport and a jog wheel for much improved/faster editing capabilities. Rack mountable and comes with a remote control.

List (still just) \$ 1,499 Call for your HE Price!

Call us for the Best Digital, New & Completely Rebuilt Equipment! (804) 984-HALL (4255) (804) 984-FAXX (3199)

marantz

Portable News Package \$ 409.00

Mic, Cable, Marantz Cassette



Audix CD-11 PMD222

The Marantz PMD222 is a portable 3-Head 2-Speed Cassette Recorder with the following features:

- XLR balanced mic input
- True tape/source monitoring
- Switchable Limiter

Econo Portable News Package \$ 349.00

Same as above but with a Marantz PMD201

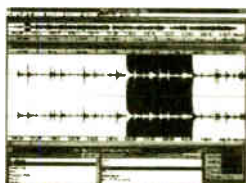

Software Audio Workshop (SAW) is a professional production tool for manipulating and crafting audio on your PC computer under the Windows Operating System. Digital Audio Lab's CardD Plus is the perfect companion sound card with sonic performance unmatched by any 'multimedia' card.

Innovative Quality Software's SAW	\$ 519.00
Digital Audio Labs Card-D Plus	\$ 649.00
SAW + Card-D Plus	\$ 1099.00

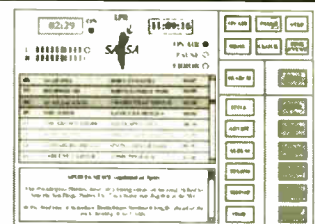

LPB SALSA - \$ 8995 LIST

386DX33 PC System with 1 Gigabyte Hard Drive
Open-ended architecture, always upgradeable
Simultaneous Record and Play of audio
Stereo and Mono audio

User-controlled variable audio overlap for live-sounding segues
Accepts downloads from all traffic and music scheduling systems
Provides a 31-Day historical log of everything that aired and when
System support available 24 hours a day, 365 days a year



CART MACHINES...WTS

Dynamax CTR10 stereo, 100 slot wall mount racks (2), 255 slot floor rack; 300-400 Scotchcart II NAB Type AA. Jerry, WGER, 6165 Bay Road, Saginaw MI 48604. 517-792-1063.

ITC mono R-P, gd cond, \$450; Spotmaster 405 mono, \$100. R Statham, WSTU/WHLG, 100 Alice Ave, Stuart FL 34994. 407-692-1000.

Great Prices on original equipment tape heads for ITC, BE, Fidelipac, Otari, Tascam & others!
(804) 984-4255



H.E. HALL Electronics

SMC 700 (2) PB machines, sec and tert tones, gd cond, \$150/ea or BO. B Williams, KQLL, 5314 S Yale, Tulsa OK 74135. 918-455-9522.

Telex (2) stereo R/P; Telex mono R/P; Telex mono play only. M Young, WJON, Box 220, St Cloud MN 56302. 612-251-4422.

AudiCord mono cart machine, mint condition, \$650.00. Call 806-372-5130.

No matter how you stack it...



Nobody reconditions tape heads like JRF.

- Heads restored to new performance spec at a fraction of new cost
- Cart machines and all open reel formats
- Full line of replacement heads for all manufacturers

Experience the difference experience makes. Ask around. Nobody treats you or your heads better than JRF.



249 Kennedy Rd., Greendell, NJ 07839
(201) 579-5773 Fax (201) 579-6021

BE 5300C tripledeck, stereo, PB, mint less than 50 hrs, BO. R Kaufman, Pams Prods, POB 462247, Garland TX 75046. 214-271-7625, after 3PM CDT.

TURN YOUR COMPUTER INTO DIGITAL CART MACHINE. SEE AUTO-MATE AD UNDER AUTOMATION EQUIPMENT.

Want To Buy

ITC, BE, Fidelipac cart machines: single, triple, mono, stereo, play & record/play. Call M O'Drobinak @ 619-758-0888.

CASSETTE & REEL-TO-REEL RECORDERS

STUDER SERVICE SPECIALIST

Thousands Serviced • Unbeatable Rates
Precision Capstan Resurfacing
Audio Advantage
Tel (615) 742-3834
PRICE-QUALITY-SERVICE
Let Us Prove It

Want To Sell

Nakamichi BX-125, cam drive w/3 motors, \$250; Teac X-1000R, computer controlled, bi-directional R-P. \$780. R Schweppe, WTMY, 7155 Clark Rd, Sarasota FL 34241. 813-923-8239.

ITC 750 R-R, R-P, gd cond, \$450. R Statham, WSTU/WHLG, 100 Alice Ave, Stuart FL 34994. 407-692-1000.

Ampex 350 mono with Inovonics electronics, solid state, rack mount, \$300; Ampex AG 350, mono, solid state, rack mount, \$500. A Baker, Broadcast Productions, 804 E 38th St, Indianapolis IN 46205. 317-925-7371.

MCI JH110B 2 track, roll around, good condition. J Gelo, J&H Music, POB 1697, Marco Isl FL 33937. 813-642-6899.

Ampex 350, 3 motors, 2 spd, all cables, \$495, with new Inovonics electronics, elect never used, \$1495. WBXK, POB 398, York SC 29745.

MCI JH-100 (2). M Young, WJON, Box 220, St Cloud MN 56302. 612-251-4422.

Otari MX-70 with CB-117 remote control and CV-119 autolocator, dbx-180A NR system, UREI 535 EQ, Eventide H949 Harmonizer, Crown D-75 speaker amp, JBL 4408 spkrs (2). J Book, WOC, 3505 E Kimberly Rd, Davenport IA 52807. 319-344-7000.

REVOX PARTS/SERVICE

Cassette-CD-Open reel
Rebuilt A77s, \$850.⁰⁰
Capstan resurfacing, ALL BRANDS.
JM TECHNICAL ARTS
30 Music Sq. W. #156
Nashville, TN 37203 (615) 244-6892

Otari ARS 1000 R-R, PB only (3); \$350 ea/\$900 all. R Statham, WSTU/WHLG, 100 Alice Ave, Stuart FL 34994. 407-692-1000.

Otari MX5050, 2 channel R-R. Jerry, WGER, 6165 Bay Road, Saginaw MI 48604. 517-792-1063.

Pentagon CP-4010 sequential 4 deck player, new; Pentagon CP-4010 (4) sequential 4 deck player; Teac X300R stereo reversing rcdrs. R Schuh, KSMG, 210-646-0105.

Recordex CS-2500 1 master, 5 slave, recorder cassette duplicator, 15:1 dup speed, \$1000 + freight. W Feinberg, Totaltape Pub, 9417 Princess Down, Tampa FL 33619. 813-621-6200.

Revox PR99 (4) rolling cases with wired remote, excellent condition, 2 track with 7 1/2 and 15 ips, \$2000 + shipping. W Feinberg, Totaltape Pub, 9417 Princess Down, Tampa FL 33619. 813-621-6200.

Teac A-3300-SX 3.75 and 7.5 ips, 7" & 10 1/2" reel modes, 1/4 track stereo, excellent condition, \$450. KAK Productions, 928 Hyland Dr, Santa Rosa, CA 95404.

Otari Mark II-IV 1/2" 4-track, multi-track, mint, less than 50 hours, Best Offer. R Kaufman, Pams Productions, POB 462247, Garland TX 75046. 214-271-7625, after 3PM CDT.

NORTRONICS
REPLACEMENT TAPE HEADS
Test Tapes, Degaussers, Gauges, Cleaners, Swabs, Lapping Films, Splice Bars/Tabs, and Demagnetizers
SEQUOIA ELECTRONICS
(408) 363-1646
FAX (408) 363-0957

Scully '100' recorders, record/play amplifiers, 8, 16, 24 track heads. Sequoia Electronics, 4646 Houndshaven Way, San Jose CA 95111. 408-363-1646.

Scully 270 (4) need some adjustments, also one for parts, \$150. B Williams, KQLL, 5314 S Yale, Tulsa OK 74135. 918-455-9522.

Studer B67 with manual, \$1650; Studer A67 in wood case, \$600. India Navigation, 177 Franklin St, NY NY 10013. 212-219-3670.

Tascam 34 R/P 10.5 reels, 1/4 4 trk w/all new heads. Larry, WXL P, 1229 Brady St, Davenport IA 52803. 319-326-2541.

HEAD RELAPPING/REPLACEMENT
All tape and film formats
30 years experience
iem
350 N. Eric Drive
Palatine, IL 60067
708-358-4622

Ampex ATR800 mono, Tascam 25-2, Tascam 7300, Ampex ATR700, \$695 ea, Scully 16 track 2" \$3450, Tascam 52 top of line, \$1150, Ampex AG350 electronics \$75, 3M M56 16 track \$5500, M79-24 fully rebuilt \$11500, Tascam locator for 85-16 \$495. Sony TCD-5 & Marantz stereo 3 head portable cassettes both \$475, Fostex E22 1/2" center track time-code deck \$1800, Fostex A80 8 track & 450 mixer \$1950, Tascam 80-8 & M5 \$1950, Nagra 10" reel adaptor \$1400, Nagra 4.2 sync mono, Haliburton case, Tote, AC ps \$2500, Tascam 38 8 track with dbx \$1650. W Gunn, POB 2902, Palm Springs CA 92263. 619-320-0728.

Otari 5050-SHD 8 track 1/2" newly rebuilt, heads have full, life left, \$1800. W Gunn 619-320-0728.

Telex CD1 duplicator, 1:3, \$750 + shipping. W. Feinberg, Totaltape Pub, 9417 Princess Down, Tampa FL 33619. 813-621-6200.

Ampex 601 portable tape recorders (3) & Ampex 620 portable speaker/amps (3). Working when retired, BO + shipping. Mel Crosby, 408-363-1646.

Ampex ATR 100 (2) 4 track \$3500 ea, 2 trk 1/2" \$4000, (2) 2 track 1/4" \$2500 ea. 212-343-0265.

UHER 4400 report monitor, \$650; UHER 4400IC stereo, \$125. S&G Electronic, 215-474-7663.

Want To Buy

Ampex ATR100 taperecorders for parts. Circuit cards, heads, motors, machine parts, or electronic parts. Call 818-907-5161.

Nagra 4S, crystal sync not necessary. Reasonable price. Noel 215-474-7663.

COMMUNICATION SITES

Want To Sell

COMMUNICATION SITE

DIXON, CALIFORNIA—2 noncontiguous parcels. 631 acres improved with buildings, antennas, security fence and parking area. 156 acres unimproved. Off Interstate 80, 20 miles southwest of Sacramento, 65 miles northeast of San Francisco. Inspection date Dec. 1 10am to 2 pm. 7514 Radio Station Road. Auction by mail begins January 18, 1995. Call 1-800-421-7848 for more information.

COMPUTERS

Want To Sell

Compuadd AM/FM stereo, new computer card (3), 8 bit, Windows only software, graphical tuner, \$50 each. Brian, CDJ, 1861 Brown Blvd, Arlington TX 76006. 214-364-4523.

Many computer items. Call for info or to be faxed a current list. Some store demos from closed computer store, some gently used. Call Eric at 1-800-95-WEDGE.

EMPLOYMENT

To place ads in this section, use the ActionGram form. To respond to box numbers write Radio World, PO Box 1214, Falls Church, VA 22041. Attn: _____

HELP WANTED

TECHNICIAN SENIOR: Argonne National Laboratory, one of the nation's premier energy research and development organizations, is currently seeking a Technician Senior for the Advanced Photon Source (APS)—the nation's largest synchrotron radiation facility. You will assist engineers and physicists in the development, improvement, and construction of RF electronics and amplifiers. This will involve assembly, testing and debugging, installation, operation, and maintenance of high power RF amplifiers. This position requires an Associate's degree or equivalent along with 5+ years of experience building, testing, and maintaining high power RF amplifiers and related power equipment. We also require extensive knowledge of RF construction and testing techniques, and familiarity with low-level equipment. At Argonne, you'll find an environment that encourages both personal and professional career growth, as well as excellent compensation and benefits. We welcome applications from candidates who can contribute to our EEO/Affirmative Action goals. For confidential consideration, please send a resume and salary history to: Sheila R. Heath, Employment and Placement, Box APS-114665-B5, Argonne National Laboratory, 9700 S Cass Ave, Argonne IL 60493. Telecommunication Device for the Deaf - (708) 252-7722. An equal opportunity/ affirmative action employer.

Chief Engineer. Northeast market seeks qualified broadcast engineer for 1 AM/FM high power combos. Applicant must possess experience with transmitter and studio equipment. A working knowledge of computers is also helpful. Please send resume and salary requirements to Radio World, POB 1214, Falls Church VA 22041. Attn: Box # 94-11-30-1RW.

POSITIONS WANTED

20 yrs exp, bdct school grad, AM/FM, any format, FCC 1st class/ Gen/Radar, Marine, rest, ham, SBE cert. C Hamlin, 509 W 4th St, Corbin KY 40701. 606-528-5460.

7 year radio pro interested in doing voice overs for any format, reasonable rates. John, 302-475-0814.

Bright, friendly, ambitious and creative, seeks position using writing, vocal and prod skills. Lynn, 405-628-3707.

Genuine warmth, up & bright, talk or music, 25 yrs exp, in Seattle, but wants to move east. Tom, 206-217-9241.

Graduate, loves country/easy listening, sharp on-air, production, OK or Tulsa pref, also relocate to Nashville or Colorado. Andrew, 918-425-2120.

Ohio air-talent seeks FT hot AC or classic rock midday gig. Rick, 216-773-1549.

Positive attitude, just out of school seeks on-air, production, sales, ready for broadcasting. Brian, 405-372-2364.

Someone gave you a chance, now take that chance on Airl Foxx, on-air, prod, news. 405-677-1698.

HELP WANTED

RF ENGINEER (Maine)

THE POSITION: Engineer for the company's Shively Labs division, a leading manufacturer of FM and TV broadcast antenna systems and related equipment. Principal responsibility will be R & D of new products. Significant opportunity for relations with the marketplace.

THE COMPANY: A small company participating in growth markets by using its creativity and technical excellence in competition with major corporations. Competitive salary and broad company benefits. Initiative and ideas are recognized in our participatory environment. Company located in a four-season resort area in the mountains of western Maine and convenient to Portland.

REQUIREMENTS: A BSEE and significant design and test experience in antennas and RF components. MSEE a plus. Solid grounding in both theory and practice. Commitment to high quality product and engineering excellence.

Interviews will be scheduled with selected applicants. No phone calls please.

Send application letter, salary history and resume to:

Howell Laboratories, Inc.
Personnel Department
P.O. Box 389
Bridgton, ME 04009

ABOUT OUR EMPLOYMENT SECTION

HELP WANTED

Any company or station can run "Help Wanted" ads for \$1.50/word or buy a display box for \$60/column inch. Payment must accompany insert, use your MasterCard or VISA; there will be no invoicing. Blind box numbers will be provided at an extra charge of \$10. Responses will be forwarded to listee, unopened, upon receipt. Call 800-336-3045 for details.

POSITIONS WANTED

Any individual can run a "Position Wanted" ad, FREE of charge (25 words max), and it will appear in the following 2 issues of Radio World. Contact information will be provided, but if a blind box number is required, there is a \$10 fee which must be paid with the listing (there will be no invoicing). Responses will be forwarded to the listee, unopened.

Mail to: **BROADCAST EQUIPMENT EXCHANGE**
PO Box 1214, Falls Church, VA 22041 Attn: Simone Mullins

CONSOLES

Want To Sell

Auditronics 310, 8 track with cabinets, furniture, Yamaha DX-7 keyboard, Yamaha RX-21 drum box, pre-wired Gentner patch panels (9), much more. BO. J Book, WOC, 3505 E Kimberly Rd, Davenport IA 52807. 319-344-7000.

Autogram IC-10 10 chnl stereo, gd cond, \$2300. S Cilurzo, San Diego Digital, 9853 Pacific Heights Blvd, San Diego CA 92121. 619-452-9000.

Collins 808A-1 portable, w/dual TT, mono, \$400. Larry, WXP, 1229 Brady St, Davenport IA 52803. 319-326-2541.

Gately 16 x 8 with EQ 4 effects buss quad monitoring, Cannon connectors for line & mic inputs and Cannon connectors for outputs, \$850. A Baker, Broadcast Productions, 804 E 38th St, Indianapolis IN 46205. 317-925-7371.

Harris Stereo 80, \$500 + shipping; Collins production board, \$150/BO. B Pitts, WJBV, POB 930, Gadsden AL 35902. 205-442-1222.

Ramsa 8615 never used, in org factory cartons, 7 mono, 4 stereo modules, BO. R Baur, KUTT, 414 4th St, Fairbury NE 68352. 402-729-3382.

Ramsa 8616, never used, 7 mono & 4 stereo modules, BO. R Baur, KUTT, 414 4th St, Fairbury NE 68352. 402-729-3382.

RCA BC308S 8 input stereo, never used, spare cards, timer, manual, transformer in out, step attenuators, \$1000. D. Brassell, Aldon Video, 424-S Commerce Ln, Berlin NJ 08009. 609-768-2439

Ramko DC5AR 5 channel mixers, vgc, \$175 each. 916-725-2434.

Ramko Model D-C 5RA mixer, good working condition, \$150. R.G. Stair. 803-538-3892.

RCA BC-14 rack mount console, good condition, \$100 + shipping; Monsanto 105-A frequency counter, mint condition, \$200 + shpg; Audio patch bay, \$35 + shpg. W Tinsley, AirChecks USA, 1123 Holcomb St, Water-town NY 13601. 315-788-0914.

MCI 528 was \$82,000 new, excellent condition \$16500, Quantum 32x16x24 as used by LA Philharmonic \$4950, Auditronics 501 \$3500. W Gunn, POB 2902, Palm Springs CA 92263. 619-320-0728.

Want To Buy

Neve consoles: any condition or parts Also: UA, UREI, Teletronics, Fairchild, RCA, Puhtec, API, any TUBE GEAR or COMPRESSORS Call 201-798-2745 or fax 201-963-4764

Neve console, any type and parts. 212-343-0265.

DISCO-PRO SOUND EQUIPMENT

Want To Sell

Community CB 594 fiberglass bass horns, uses 15 or 18" driver, with EV 15DLX drivers \$225; without drivers \$100. D Brassell, Aldon Video, 424-S Commerce Ln, Berlin NJ 08009. 609-768-2439

dbx 118 compressor/expander, exc cond w/box, \$125. R Glenn, WJGR, 1718 Shenandoah Dr, Wimauma FL 33598. 813-634-1940.

Lights Fantastic 10 x 1200 16 chnl light chaser, \$200. W Feinberg, Totaltape Pub, 9417 Princess Down, Tampa FL 33619. 813-621-6200.

LinnDrum classic drum machine with MIDI update, \$250. Mark, Production Block Studios, 906 E 5th St, Austin TX 78702. 512-472-8975.

Sequential Circuits Tom 9 keyboard style programmable, MIDI compatible, 2 removable carts w/sound effects, \$200. W Feinberg, Totaltape Pub, 9417 Princess Down, Tampa FL 33619. 813-621-6200.

Want To Buy

JBL 4343 studio monitors, any cond. R Glenn, WJGR, 1718 Shenandoah Dr, Wimauma FL 33598. 813-634-1940.

FINANCIAL SERVICES

EQUIPMENT FINANCING

ON ALL RADIO EQUIPMENT

- Easy to qualify
- Fixed-rate, long-term leases
- Any new or used equipment
- 100% financing, no down payment
- No financials required under \$50,000
- Refinancing existing equipment

ENF EXCHANGE NATIONAL FUNDING

Call Mark Wilson (800) 275-0185

LIMITERS

Want To Sell

CBS Volumax stereo FM, slimline version. B Caihmer, WMBI, 820 N LaSalle Drive, Chicago IL 60619. 312-329-4304.

dbx 140A new, dbx type III w/r input video mixer, \$200. W Feinberg, Totaltape Pub, 9417 Princess Down, Tampa FL 33619. 813-621-6200.

Want To Buy

903 (4) and 905 (2), want modules only. R Streicher, Pacific Audio-Visual, 545 Cloverleaf Way, Monrovia CA 91016. 818-359-8012.

Orban Optimod 8000 and 8100, in good out of service or non working condition. Emie, CBP Productions, Box 411, Alexandria KY 41076. 800-526-5450 ext 308.

Orban 424 or equiv, must be in gd cond. J Moser, J & N Rec, 520 Roebing Ave, Trenton NJ 08611. 609-695-3418.

Fairchild 670 or 660 tube compressor/limiter, Teletronics LA-2A tube compressor/limiter or UREI LA-3A solid state compressor/limiter, call after 3PM CST. 214-271-7625.

MICROPHONES

Want To Sell

AKG C422EB, large diaphragm stereo, phantom power, remote pattern selector, 20-meter cable, windscreens and shockmount, excellent condition, \$1850; AKG D-140 cardioid, \$225/pr. R Streicher, Pacific Audio-Visual, 545 Cloverleaf Way, Monrovia CA 91016. 818-359-8012.

Altec coke bottle tube mic, original power supply, case, \$350. Bob, Clockwork Sound, 606 Mamaroneck Ave, Mamaroneck NY 10543. 914-381-0661.

Ampex PR 10 2 channel tube mic pers, vintage 1950s, with mic transformers, \$425. Bob, Clockwork Sound, 606 Mamaroneck Ave, Mamaroneck NY 10543. 914-381-0661.

API 512B mic pre/direct box, 48V, phantom power, 20 dB pad, mint cond, \$375; API HPR horizontal 500 rack, holds 2 units, self powered, excellent condition, \$375. Bob, Clockwork Sound, 606 Mamaroneck Ave, Mamaroneck NY 10543. 914-381-0661.

Sony ECM377 large dia cond mics (2) \$495 ea, RCA 77DX \$950, 44BX matched set of 3 \$3950, Shure SM5 \$325, SM7 \$295, AKG D12 \$195, Crown GLM200 lavalier like new \$125. W Gunn, POB 2902, Palm Springs CA 92263. 619-320-0728.

Telex Sports Caster mic/headsets (2), almost new, \$100 for both. R.G. Stair, 803-538-3892.

Want To Buy

Electro-Voice 309 Gray, shock mts in gd cond, for RE-20. H Cotterill, WZAD, POB 978137, Wurtsboro NY 12790. 914-888-0077.

RCA 77DXs/44BXs ribbon, chrome/TV grey, gd cond, BO. R Kaufman, Pams Prods, POB 462247, Garland TX 75046. 214-271-7625, after 3PM CDT.

RCA ribbons, AKG 451's, Neumann KM84's, EV 635A. W Gunn, POB 2902, Palm Springs CA 92263. 619-320-0728.

77-DX's, 44-BX's, WE KU-3A's On-Air lights, recording lights & audition lights. Top price paid. Fast response. Bill Bryant Mgmt, 2601 Hillsboro Rd, G12, Nashville TN 37212. 615-269-6131, FAX: 615-292-3434.

MISCELLANEOUS

Want To Sell

26 Foot Boom Box, new aircon speakers, both sides new audio equip, \$20,000. D Bryan, POB 485, Carthage IL 62321. 217-357-6610.

ABC radio network printed matter from 50's - 80's, cue sheets, promo kits, program schedules, affiiate lists, also airchecks. H Cotterill, WZAD, POB 978137, Wurtsboro NY 12790. 914-888-0077.

Comdial Executech 8 line phone system w/13 phone, \$700. Larry, WXP, 1229 Brady St, Davenport IA 52803. 319-326-2541.

Switchcraft patch panels wired to punch blocks. M Young, WJON, Box 220, St Cloud MN 56302. 612-251-4422.

Retron Blowers for Elcom, Harris, CCA, CSI, McMartin, rebuilt & new. Goodrich Enterprises Inc. 11435 Manderson St, Omaha, NE 68164. 402 493 1886 FAX 402 493 6821

Teletypewriter receive/send, stored for years, cond unk, on stand, \$165. WBXK, POB 398, York SC 29745.

XLR connectors, male & female, 1/4", \$2/ea or \$3/set. W Feinberg, Totaltape Pub, 9417 Princess Down, Tampa FL 33619. 813-621-6200.

Power Packs: 6V, 14AH Nicad battery in compact carrying case, \$40; Lithium: 12V, 15AH light weight! Great Power! Only \$12.50 pack. S&G Electronic, 215-474-7663.

Want To Buy

Jazz record collections, 10" LP/12" LP be-bop, swing, dixie, highest prices paid. B Rose, Program Recdgs, 228 East 10th, NYNY 10003. 212-674-3060.

Radio Transcriptions. Any year. Send description. Andy Lanset, 328 West 101 St, NYC, 10025. 212-662-6540.

MONITORS

Want To Sell

TFT 730A SCA monitor. Very little use. Excellent condition, \$850. Wayne L. 615-251-3003.

Repco SCA port radio, \$20. E Mitchell, KSNM, 214-495-8122.

Want To Buy

McCurdy tube consoles wanted, AU-300 line modules power supply, monitor amps, card cages etc. Also interested in RCA, Collins, Langevin tube modules. Wayne L. 615-251-3003

RECEIVERS & TRANSCEIVERS

Want To Sell

AM STEREO RECEIVERS
Portable - Home/Studio, Auto
RRADCO GROUP
708-513-1386

Sony ST555ES stereo FM tuner, 8 presets, 2 antenna inputs, \$125. R Streicher, Pacific Audio-Visual, 545 Cloverleaf Way, Monrovia CA 91016. 818-359-8012.

GE Superadio III, custom modified w/noise free SCA w/improved selectivity & sensitivity, \$95. Other modifications avail. Performance guaranteed. **800-944-0630**.

Standard GX 3000 mobile 800 MHz 2 way radios (2) and Astron SL-11A pwr supplies for base; Standard HX-400 (2) handheld 800 MHz 2-way (2); Standard CSA-400 (2) rapid chargers for handhelds. R Schuh, KSMG, 210-646-0105.

SCA RECEIVERS—ALL TYPES

Reading Service / Ethnic / Data
Professional / Table
Will work to meet your receiver needs

DAYTON INDUSTRIAL CORP.
(Manufacturer)
2237 Industrial Boulevard
Sarasota, FL 34234
Tel: 813 351 4454 FAX: 6081

Want To Buy

Sony SRF A100 multi mode AM stereo rcvr. Also AM stereo boom box, portable, table top, tuner and/or rcvr. Looking for all types of AM stereo receivers, no automoblie units. Ken, 215-536-5921.

PHONE: 703-998-7600 FAX: 703-998-2966



Call Simone Mullins, Classified Ad Manager, to reserve space in the next issue. Use your credit card to pay, we now accept VISA and MASTERCARD.

Radio World

5827 Columbia Pike, 3rd Floor
Falls Church, VA 22041

Select from these categories for best ad positioning:

- | | | |
|----------------------------|---------------------------|--------------------------|
| Acoustics | Consoles | Software |
| Amplifiers | Disco-Pro Sound Equip. | Stations |
| Antennas & Towers & Cables | Financial Services | Stereo Generators |
| Audio Production (Other) | Leasing | Tapes, Carts & Reels |
| Brokers | Limiters | Tax Deductable Equipment |
| Business Opportunities | Microphones | Test Equipment |
| Cart Machines | Miscellaneous | Transmitter/Exciters |
| Cassette & R-R Recorders | Monitors | Tubes |
| CD Players | Receivers & Transceivers | Turntables |
| Computers | Remote & Microwave Equip. | Positions Wanted |
| | Satellite Equipment | Help Wanted |

Classified Advertising Rates Effective January 1, 1994

	1x	3x	6x	12x
1-9 col inch (per inch)	\$60	58	54	49
10-19 col inch (per inch)	55	52	49	44
Distributor Directory	100	95	90	85
Professional Card	65	60	55	50
Classified Line Ad		\$1.50 per word		
Blind Box Ad		\$10 additional		

To compute ad costs: Multiply the number of ad inches (columns x inches) by the desired rate schedule for your per unit cost. Example: a 3" ad at the 1x rate is \$180, at the 3x rate \$174, at the 6x rate \$162, at the 12x rate \$147, etc.

ADVERTISE!
CALL
1-800-336-3045

in Radio World's
**BROADCAST
EQUIPMENT
EXCHANGE**

DISTRIBUTOR DIRECTORY

The following distributors serving the broadcast industry would be glad to help you with any of your requirements.

...country, top 40, news, urban, talk, jazz, the classics, mixed bag...

CROUSE-KIMZEY OF ANNAPOLIS

tops in broadcast equipment
1-800-955-6800
ask for Kathleen

CORNELL-DUBILIER MICA CAPACITORS

FROM STOCK

JENNINGS VACUUM CAPACITORS

FROM STOCK

JENNINGS VACUUM RELAYS

SURCOM ASSOCIATES, INC.
2215 Faraday Ave., Suite A
Carlsbad, California 92008
(619) 438-4420 Fax: (619) 438-4759

REMOTE & MICROWAVE EQUIPMENT

Want To Sell

Marti RMC2-AXT(A), RMC2-AXT(10) needs repair, will supply new stepper, \$325. WBXK, POB 398, York SC 29745.

SATELLITE EQUIPMENT

Want To Sell

Zephyrus SCPC-700, 2 Channels, 2:1 and 3:1 companding, 950-1450 L Band. Cost \$1900, Sell \$1150 plus S/H. Other SCPC receivers for sale. Call for list Universal Electronics, Inc. 614-866-4605.

SOFTWARE/ DATABASES

Want To Sell

PC SOFTWARE for Broadcasters. Traffic, Billing, & Accounting. Powerful, inexpensive. Works with automated, satellite or live operations. INTERFACES with popular DIGITAL AUTOMATION SYSTEMS. Try it for 90 days, no obligation. **Absolute Broadcast Automation** Naples, Florida (813) 643-3689

Profitable small market AM daytimer in SW Virginia. Excellent owner operator opportunity. Market at two times billing, with or without, \$160,000.00 in real estate. Currently family operation with principals planning retirement. Contact: JCS, POB 354, Wytheville, Virginia 24382.

Want To Buy

Lease manage AM or FM in NE, Boston/Providence pref. new format needs home. B Alley, RLM, 272 Union St, New Bedford MA 02740. 508-991-2007.

Small AM & FM combo, cash. J Latino, 718-893-4328.

100's of reels of 1/4" .5 mil tape on 10.5" plastic reels, \$1/reel or Best Offer. B Williams, KQLL, 5314 S Yale, Tulsa OK 74135. 918-455-9522.

7 1/2" & 10 1/2" reels, thousands in boxes, 7" 50c/ea + shipping; 10 1/2" \$1/ea + shipping. W Feinberg, Totaltape Pub, 9417 Princess Down, Tampa FL 33619. 813-621-6200.

Scotch/3M carts, various lengths, some Audiomax and Dynamax over 100, buyer takes all, \$100 + shipping. C Rogers, KXAX, Hwy 4, St James MN 56001. 507-375-3386.

Scotchcart (184), loaded with oldies, \$200 including shipping. T Devine, WVLC, 300 W Vine St, Lexington KY 40507. 606-253-5900.

RENT IT HERE! Call Steve Kirsch for Details

SILVER LAKE AUDIO • 516-623-6114 • FAX: 516-377-4423

Moseley TRC-15 \$900 + shipping. R Petersen, KDMO, 221 E 4th, Carthage MO 64836. 417-358-6054.

Moseley TRC-15 15 channel remote control systems, good condition, \$500. S Cilurzo, San Diego Digital, 9853 Pacific Heights Blvd, San Diego CA 92121. 619-452-9000.

WE RENT

TELOS ZEPHYR
QEI QUICK-LINK
Stereo RPU, NO license

COMREX
3 line extender

Frank Grundstein
Audio/Video
Consultants
610-642-0978

Moseley MRC-2 remote cntrl sys, loaded; Moseley TRL-1 TSL sys, 1 W. R Schuh, KSMG, 210-646-0105.

TRC-15 16 channel remote control switch; Gates FT-80 modulation monitor and stereo monitor. Jerry, WGER, 6165 Bay Rd, Saginaw MI 48604. 517-792-1063.

360 System Bernoulli Drive with 11 - 44 MB disks, all for \$300, little use. R.G. Stair, 803-538-3892.

Ariel

Proven in more than 150 Installations!

The world's most capable Digital Satellite receiver at an affordable price!

Compare before you buy!

All Westwood One Formats!

Zephyrus for JSA

Zephyrus 700 SCPC

We Repair & Rebuild all Popular Receivers Quick Service!

Satellite Systems (719) 634-6319

Ron Balonis' Broadcast Engineer's Computer Toolbox makes a computer a technical assistant for an engineer. For details, write **Computer Toolboxes**, 118 Rice St., Trucksville, PA 18708 or call 1-717-696-1490 300/1200/8N/1.

STATIONS

FT 1 kW AM w/real estate, for listing of equipment: R Hobbs, WMLR, 2009 Cromwell Dr, Nashville TN 37215. 615-373-2351.

Historic East TN town with retirement village, only station in town, 1 kW, excellent equipment and offices, low overhead, with or without real estate, will consider some financing. Mr Lowe, 615-458-9563 after 3 pm EDT.

LPTV permit, ready to build, Chnl 26, Santa Barbara/Goleta CA. G Erway, 3450 SE Martinique, Stuart FL 34997. 407-283-6871.

2.5 kW AM in S.E. Georgia, \$150,000. CMM, POB 1951, Waycross GA 31502.

MUST SELL: FM radio station in Marshall, Illinois. 2-story building with 17 acres property. Studio and all transmitting equipment. \$55,000 cash. 1-800-231-5171 ext 102.

PROFITABLE HI POWERED LOW DIAL AM AND UPGRADABLE FM. 501-470-1525.

MARATHON PRODUCTS COMPANY

Audio Cartridge Rebuilding Division

Rebuilding/reloading, like new, all brands, any length up to & including 3.5 minutes, \$1.95 ea. FOB out plant, 48 hrs delivery. (New rate effective 9/1/93)

New NAB Marathon cartridges prices on request.

35 Years professional experience! Lifetime member AES R.D. MYERS Sr. Manufacturers of Audio Devices, Continuous Tape Mag.

69 Sandersdale Rd. Charlton, MA 01507
1-508-248-3157 or 1-508-853-0988

Circle (30) On Reader Service Card

CONSULTANTS

EVANS ASSOCIATES
Consulting Communications Engineers

TV • FM • AM • ITFS • Satellite
FCC Applications, Design and Field Engineering

Video/Data/Voice • Light Fiber & Microwave • Wide-Area Networks & STL's

210 S. Main Street
Thiensville, WI 53092
(414) 242-6000 • FAX (414) 242-6045
Member AFCCCE

PC - SOFTWARE

AM FM TV Search Programs
Contour Mapping-STL Paths
RF HAZ-1990 POP Count
FAA Tower-Draw Tower

Doug Vernier
Broadcast Consultant
1600 Pictouresque Dr
Cedar Falls, IA 50613

800-743-DOUG

North America *RF & Audio*

Mirkwood Engineering Services
Broadcast and Telecommunications Consultants

Multidiscipline Engineering and Planning Firm including • Application & Allocation Services

- Project, Engineering & Construction Management • Site Acquisition
- Rural & Remote Site Installations
- Field Service • Studio Design & Installation

50 Park Ave. Claremont, NH 03743
(603) 542-6784

MLJ
Moffet, Larson & Johnson, Inc.
Consulting Telecommunications Engineers

Two Skyline Place, Suite 800
5203 Leesburg Pike
Falls Church VA 22041

(703) 824-5660
FAX: 703-824-5672

Member AFCCCE

MULLANEY ENGINEERING, INC.
Consulting Engineers

- Design & Optimization of AM Directional Arrays
- Analysis for New Allocation, Site Relocation, And Upgrades AM FM TV LPTV
- Wireless Cable (MDS/MDS-ITFS/OFS)
- Environmental Radiation Analysis
- Field Work
- Expert Testimony

9049 Shady Grove Court
Gaithersburg, MD 20877
Phone: (301) 921-0115
Fax: (301) 590-9757

Consulting Communications Engineers

- FCC Data Bases
- FCC Applications and Field Engineering
- Frequency Searches and Coordination
- AM-FM-CAIV-ITFS-LPTV

OWL ENGINEERING, INC.

1306 W. County Road. F,
St. Paul, MN 55112
(612)631-1338 *Member AFCCCE*

- **Propagation Services**
- **FM Studies**
- **Population Studies**
- **FCC/FAA Databases**
- **PC Software**

Communications Data Services, Inc.

800-441-0034
703-534-0034
fax 703-534-7884
6105-E Arlington Blvd.
Falls Church, VA 22044

LOCATION SERVICES IN THE UNITED KINGDOM

Planning remotes from the U.K.? we provide a comprehensive service

- we organize venues for your shows
- we provide temporary equipment
- live links via ISDN/Switched 56
- experienced radio engineers
- we help you line-up guests

Contact London (44) 81 442 8900
Good Morning from Great Britain
Wired for Sound Ltd., London N15

Tower Sales & Erection

Tummy Site Development
Installation & Maintenance
AM/FM Broadcast, TV
Microwave Systems,
Antennas & Towers

TOWERCOMM
Communications Specialists

Ben Wall
President

6017 Triangle Dr.
Raleigh, NC 27613
(919) 781-3496
Gen. Contractor #25491 Fax (919) 781-6134

REMOTE EQUIPMENT RENTALS

COMREX and GENTNER
1, 2 & 3-Line Extender Systems
Now With The New GENTNER EFT-3100
MARTI VHF/UHF RPU Systems
Switched-56 Systems
Call or FAX Dwight Weller
WELLER AUDIO-VISUAL ENGINEERING
Baltimore, MD
Phone: (410) or (800) 252-8351
FAX: (410) 252-4261

Where In The World Are You?

Reach radio professionals worldwide by advertising in **Radio World's** international edition.

Call Simone for more information.
1-800-336-3045

W. LEE SIMMONS & ASSOC., INC.
BROADCAST TELECOMMUNICATIONS CONSULTANTS

5 Gracefield Road
Hilton Head Is., SC 29928

1-800-277-5417
803-785-4445
FAX: 803-842-3371

Teletech, Inc.

BROADCAST CONSULTANTS AND ENGINEERS

- FCC Applications & Field Engineering
- Frequency Searches & Coordination
- Tower Erection & Maintenance
- Facility Design & Construction

CONTACT:
Kenneth W. Hoehn
23400 Michigan Ave
Dearborn, MI 48124
(313) 562-6873

T. Z. Sawyer
Technical Consultants
1-800-255-2632

- FCC Applications & Exhibits
- Frequency Studies - Class Upgrades
- Directional Antennas - AM/FM/TV
- High Power Antenna Arrays

Telefax: (301) 913-5799
6204 Highland Dr., Chevy Chase, MD 20815

Contact Radio World Newspaper for availabilities

P.O. Box 1214 Falls Church VA 22041

1-800-336-3045



TAPES/CARTS/REELS/CDs...WTS

Audiopak A2, hundreds in various lengths and condition, \$1/each. M Young, WJON, Box 220, St Cloud, MN 56302. 612-251-4422.

1-800-TAPE WORLD or 1-800-245-6000
We'll beat any price! 5.95 SHIPPING • FREE CAT.

SONY	MAXELL	TDK	FUJI
DAT-120 7.49	XL11-90 1.79	T-120HS 1.89	TI20H0 1.99
DAT-120 9.99	XL11-590 2.29	T-120HSG 2.49	SVHS-1120 6.99
T-120V 2.39	XL11-5100 2.69	SA-90 1.69	BMM-120 3.49
SVHS-1120 7.99	DAT-120 7.99	SAX-90 2.19	HI-8-120 5.99
6-750HG 3.99	TI20HGX 2.79	DAT-120 6.99	mem rec74 10.99
mem rec 74 11.99	JXC-1120 1.79	DAT-180 8.99	DR-190 7.99

TAPE WORLD 220 SPRING ST. BUTLER PA 16003 FAX 412-283-8298
COVER 400 DIFFERENT SAME DAY SHIPPING M-F 8-5

Thousands of LP's, big band, MOR, Rock & Roll, contemporary. J Gelo, J&H Music, POB 1697, Marco Isl, FL 33937. 813-642-6899.

Voice grade whiteshell, 30 min, 20¢/ea in lots of 500 only; 60 min, 25¢/ea in lots of 500 only, 90 min, 30¢/ea in lots of 500 only; chrome tape (200) 90 min, \$140 + shipping or 70¢/ea. W. Feinberg, Totallape Pub, 9417 Princess Down, Tampa, FL 33619. 813-621-6200.

Pams Jingles ref tapes, 1951-1976, BO. R. Kaufman, Pams Prods, POB 462247, Garland, TX 75046. 214-271-7625.

Want To Buy

Fidelipac/Audiopak Mastercart II gold or AA-4 light blue in 2:30 through 4:00 lengths, must be in very good condition, call after 3PM CST. 214-271-7625.

TAX DEDUCTIBLE

Want To Sell

501(c)3 org seeks old analog equip, will ship, forward tax documents. B Thompson, 5831 N 60th St, Omaha, NE 68104. 402-573-6550.

Ampro Scully 280B-FT R-R recorders (22), 10" reel capacity w/NAB adaptor, 7.5 & 15 ips, to non-profit or educ station, for gift letter, you pack and ship from Chicago. E Wilk, 1112 N Grove Ave, Oak Park, IL 60302. 708-524-8515.

TEST EQUIPMENT

Want To Sell

Hickok 800A tube tester with 600A factory wiring, good condition, \$115; 400 misc audio and rectifier tubes, mostly new. WBXK, POB 398, York, SC 29745.

Leader LFM-30 wow and flutter meter. M Young, WJON, Box 220, St Cloud, MN 56302. 612-251-4422.

Tone generator 25 Hz, Downlink Systems TG 440. J Gelo, J&H Music, POB 1697, Marco Isl FL 33937. 813-642-6899.

MF NOTCH FILTER

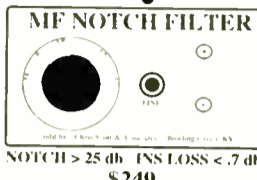

NOTCH > 25 db INS LOSS < .7 db
\$249

AM-FM FILTERS & LOOPS
Chris Scott & Associates
P.O. Box 52
Bowling Green, KY 42101
FAX us at: (502) 781-1232
or call (502) 747-3242

Leader LSG-231 FM sig gen, never used, in box, \$200. J Moser, J & N Rec, 520 Roebing Ave, Trenton, NJ 08611. 609-695-3418.

TRANSMITTERS

Want To Buy

CSI T-1-F FM, 1 kW, excel cond, spare parts kit, \$6100. WBXK, POB 398, York, SC 29745.

Want To Sell

Tepeco/Jones J-318 FM booster system, 10.7 MHz down converter, all documentation, \$2000. J Stanley 612-373-0104 or 612-431-2855.

BESCO World Leader in AM - FM Transmitters Internacional
"Now in our 30th year"

91 AM & FM Pre-Owned Units in Stock

- ✓ ALL - Powers
- ✓ ALL - Manufacturers
- ✓ ALL - Instruction Books
- ✓ ALL - Complete
- ✓ ALL - Spares

Call and take advantage of our liberal trade-in plan. Tune and test on your frequency, available on site. Complete inventory on request.

Phone: 214-630-3600

Fax: 214-226-9416

Harris MW1-A tuned to 1320, \$6000/BO. B Covey, WWLS, 4000 W Indian Hill Rd, Norman, OK 73072. 405-360-7000.

FOR SALE RE-CONDITIONED TRANSMITTERS

AM Transmitters	
50 kW 1978 MARCONI B6034	\$58,000
10 kW 1970 MARCONI B6029	\$18,000
10 kW 1980 PYE/TVT LDM 1235/02/01	\$24,000
1 kW MARCONI, Various units	\$6,000
FM Transmitters	
10 kW 1986 PYE/TVT 1233/50/02	\$18,000
1 kW 1970 MARCONI	\$6,000
1 kW CTE, NEW	\$9,000
Shortwave Transmitters	
50 kW 1970 MARCONI HF	\$52,000

east anglian productions

CONTACT:
Ray Anderson
East Anglian Productions
Studio House, 21-23 Walton Road, Frinton-On-Sea, Essex. CO13 0AA. UK
Tel: Country Code 44 (0)255 676252
FAX: Country Code 44 (0)255 850528

- PART EXCHANGE WELCOME
- TRANSMITTER HIRE AVAILABLE
- MAJOR CREDIT CARDS ACCEPTED
- ALL PRICES QUOTED IN US DOLLARS

Transmitters supplied re-conditioned and tuned to your frequency. 3 month warranty for parts and labour, excluding tubes.

BEXT Great new or demoed FM transmitters, exciters, amps and STL's, some at discount prices
USA 619-239-8462
FAX: 619-239-8474

RCA 20Kw FM without exciter, good condition, from metro market, \$16,000.00. Call 806-372-5130.

QEI Model 675 FM exciters, \$1750 per unit; QEI Model 772 stereo generator, \$650; 150 Watt "true" broadband amplifiers, \$2200 per unit. All units listed above are re-conditioned and guaranteed to work. Call for details. Bob Brown (609) 232-1625.

Spare parts for CCA AM50,000D, including, HV transformer, mod. transformer, mod. reactor, HV filter choke, tube sockets and more. Call Transcom Corporation 800-441-8454 or 215-884-0888.

Solid State RF amplifiers from 100W to 500W prices start at \$999. Call Bill Hoffman for details. 518-743-1601.

New McMartin 20 W, BIM-8000 FM exciters. New McMartin HBM1005D FM relay/rebroadcast cvr; also some used McMartin B910 exciters 15W. Goodrich Inter., 11435 Manderson St, Omaha, NE 68164. 402-493-1886 fax 402-493-6821

TRANSMITTERS - TV/FM/AM, new and used. Tubes, xmtr parts. 305-757-9207.

Bauer 707 1 kW AM, no PCB's all new plastic caps, high performance modulator kit and power supply, all documentation, \$3200 you pay shpg. J Stanley 612-373-0104 or 612-431-2855.

Want To Buy

FM4 - 6000 W, must be in gd working order. B Lacy, WAVQ, 2025 N Hwy A1A, Indialantic, FL 32402. 407-773-1962.

McMartin AM/FM transmitter, any model, exciter or stereo modules. Goodrich Ent., 11435 Manderson, Omaha, NE 68164. 402-493-1886.

TUBES

Want To Sell

Mercury vapor rectifier tubes, \$40. WBXK, POB 398, York, SC 29745.

ECONCO
Quality Rebuilt Tubes
Approximately 1/2 the Cost of New
Call for Our Price List
800-532-6626
916-662-7553
FAX 916-666-7760

Circle (22) On Reader Service Card

Buy Factory Fresh New Tubes

- ✓ EIMAC, BURLE, SIEMENS, AMPEREX, NATIONAL, and more
 - ✓ Off-the-shelf delivery
 - ✓ 24-hour emergency service
- Richardson Electronics, Ltd.**
1-800-348-5580
FAX: (708) 208-2550

FOR THE BEST PRICE
& 24 Hr service on transmitting tubes
call Goodrich Ent Inc at 402-493-1886
day or night, FAX 402-493-6821.

New RCA 892-R; RCA 5671; ITT Jennings CVHP-650-555; 4CX1500A; many more. Carl, WTJR, POB 3112, Quincy IL 62305. 217-228-1616.

Svetlana ELECTRON DEVICES
Quality* Power Tubes

3CX15,000A7	4CX800A
3CX10,000A7	4CX350A
3CX3000A7	4CX350AC
3CX3000F7	4CX250B
3CX2500F3	4CX250BC
3CX2500A3	4CX250R
3CX2500H3	4X150A
YC130	5CX1500A
4CX15,000A	5CX1500B
4CX15,000J	6550B
4CX10,000D	811A
4CX5000A	811A
4CX5000R	813
4CX3500A	833A
4CX1500A	8560AS

- Watch this list grow.
- Manufactured in Russia's largest power tube factory.
- Generous* warranty based on high quality.
- Honest prices based on quality at low cost.
- Shipment from USA stock.

Broadcasters
Call: 205-882-1344
FAX: 205-880-8077
OEMs, Distributors, Volume Purchasers
Call: 415-233-0429
FAX: 415-233-0439

Circle (195) On Reader Service Card

TRANSCOM CORP.
Serving the Broadcast Industry Since 1978

Fine Used AM & FM Transmitters and Also New Equipment
For the best deals on Celwave products, Andrew cable and Shively antennas.

1 kW FM 1978 Collins 831C-2	1 kW AM 1980 Continental 314R-1
1 kW FM 1975 RCA BTF 1E2	5 kW AM 1977 Harris MW5A
2.5 kW FM 1983 Harris FM2.5K	5 kW AM 1977 RCA BTA 5L
3 kW FM 1980 CSI 3000E	
3 kW FM 1974 Harris FM3H	
5 kW FM 1967 Gates FM5B	
5 kW FM 1983 Harris FM5K	
10 kW FM 1968 RCA BTF 10D	
20 kW FM 1976 Harris FM20H/K	

10kW AM 1986 Nautel Ampfet 10 (LOTS OF SPARE PARTS)

1077 Rydal Road #101
Rydal PA 19046
800-441-8454 • 215-884-0888 • FAX No. 215-884-0738

Circle (218) On Reader Service Card

You Need It... WE MAKE IT!

Your one call for Quality, Reliability and Economy in FM transmitters



The ECO - 10

- **SST Series** — Low Power Solid State FM from 30 to 500 watts.
- **Legend Series** — Medium Power Solid State FM 1 to 11KW
- **ECO Series** — Medium Power Grounded Grid Triode, Single Tube FM from 4 to 11 KW.
- **MK Series** — Medium and High Power Grounded Grid Triode, FM from 1.5 to 50 KW

The Transmitter People
Energy-Onix
518-828-1690
FAX: 518-828-8476
752 Warren Street, Hudson NY 12534

Circle (74) On Reader Service Card

TUBES...WTS

4CX250B, 4-400, 833, 813, 5CX1500, 4-1000, all types, full warranty EIMAC, Ampere, RCA. Westgate 800-213-4563.

Want To Buy

WANTED! Transmitting Tubes

We BUY & SELL all types of transmitting/receiving tubes.

C&N Electronics Harold Bramstedt 6104 Egg Lake Road Hugo, MN 55038

(612) 429-9397 ext.23 (800) 421-9397 ext. 23 FAX (612) 429-0292

Circle (147) On Reader Service Card

TURNABLES

Want To Sell

Technic SP10 (2), 2 spd, Fidelity Pro preamps, \$300/both. R Statham, WSTU/WHLG, 100 Alice Ave, Stuart FL 34994. 407-692-1000.

Technics SP-15 (2), TT, new. R Schuh, KSMG, 210-646-0105.

Technics SL1500MKII digital read out, direct drive, excellent condition, \$250. W Feinberg, Totaltape Pub, 9417 Princess Down, Tampa FL 33619. 813-621-6200.

ADVERTISER INDEX

This listing is provided for the convenience of our readers. Radio World assumes no liability for inaccuracy.

Table with columns: Page No., Advertiser, Reader Service No., Page No., Advertiser, Reader Service No. Lists various advertisers and their corresponding page numbers.

Table listing Publisher, Associate Publisher, Marketing Consultant, Marketing Assistant, Production Director, Publication/Desktop Sys. Mgr, Publications Manager, Classified/Showcase Production Coordinator, Ad Production Coordinator, Production Assistant, Production Assistant, Ad Coordination Manager, Circulation Director, Accounts Receivable.

Table listing Advertising Sales Representatives for U.S. East, U.S. West, International, Europe, and Japan.

Advertisement for Radio World Broadcast Equipment Exchange with contact information for Simone Mullins.

ACTION-GRAM

EQUIPMENT LISTINGS

Radio World's Broadcast Equipment Exchange provides a FREE listing service for radio stations and recording studios only. All other end users will be charged. Simply send your listings to us, following the example below. Please indicate in which category you would like your listing to appear. Mail your listings to the address below. Thank you.

Form for equipment listings including fields for Contact Name, Title, Company/Station, Address, City/State, Zip Code, Telephone, and various checkboxes for firm type and job function.

Form for equipment listings including fields for WTS/WTB Category, Make, Model, Brief Description, and Price.

Form for equipment listings including fields for WTS/WTB Category, Make, Model, Brief Description, and Price.

Form for equipment listings including fields for WTS/WTB Category, Make, Model, Brief Description, and Price.

Form for equipment listings including fields for WTS/WTB Category, Make, Model, Brief Description, and Price.

Form for equipment listings including fields for WTS/WTB Category, Make, Model, Brief Description, and Price.

*Closing for listings is every other Friday. Please be aware that it does take approximately 1 month for your listings to appear. They will then appear for only 2 issues. If more time is needed, please re-submit your listings. Broadcast Equipment Exchange Phone: 703-998-7600 PO Box 1214, Falls Church, VA USA 22041 FAX: 703-998-2966

SUBSCRIPTION/READER SERVICE FORM including Radio World logo, FREE Subscription/Renewal Card, and Reader Service information.

Why Auditronics' 210 console remains radio's virtual standard

The contemporary 210 console contains exactly those features and qualities your on-air people tell us they need to do their best work. Nothing more, nothing less.

The Auditronics 210 has the best record for up-time of any radio console. It just plain works, elegantly, all day, every day, all year, every year.

And, most important in this age of cost concern, we've made our production more efficient, so we can deliver today's 210 console at a price less than that of over a decade ago.

It's no wonder the 210 console continues to be the on-air mixer of choice among quality-conscious broadcasters. Choose the Auditronics 210 for your next console replacement or upgrade. Call 901-362-1350 today for complete information.

This Auditronics 210-18 in KPFA-Berkeley's on-air studio is one of four 210s in use at the Pacifica Foundation station.



Every City Has One.



A Number One Station.

The A-6000 On-Air Console is for you.

 **Wheatstone[®] Corporation**

7305 Performance Drive, Syracuse, NY. 13212
(tel 315-452-5000 / fax 315-452-0160)