

*****3-DIGIT 857
 J750737 D11 9007 51208 1338
 BARRY MISHKIND
 2033 S AUGUSTA PL
 TUCSON AZ 85716

Radio World



Vol 18, No 9

Radio's Best Read Newspaper

May 4, 1994

Broadcasters Rely On News Providers

by Alan Haber

WASHINGTON For radio stations eager to keep pace with the growing amount of news and information available to them, hard copy delivery services are increasingly essential stops along the information highway.

able amount of money."

With their hard copy services, news service providers can satisfy virtually any station's need for timely information.

News to sports

- AP's four radio news wires, delivered by satellite to a news department's computer system or printer, include AP DriveTime, a morning drive service; AP Headlines, targeted to stations with a 24 hour-a-day need for basic coverage; AP NewsPower, which adds to the coverage offered by AP DriveTime and AP Headlines, more information on interna-

continued on page 12 ►

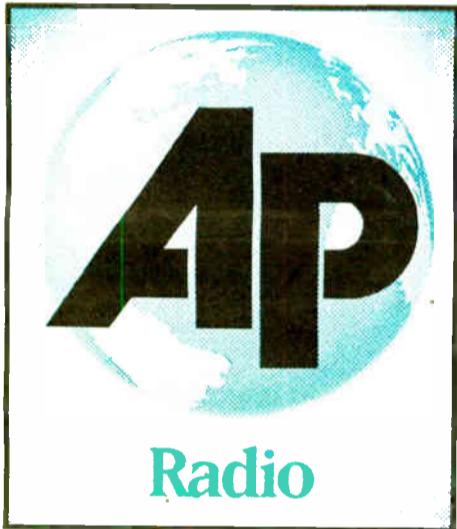

Today, news service providers such as AP, UPI, ABC, CBS, StandardNews and Reuters are delivering a variety of news, sports, and entertainment features as hard copy to small, medium and large market radio stations nationwide. Depending on the providers, copy can be delivered by satellite and fed into computers or dedicated printers, sent over telephone lines or fed directly to fax machines. Copy is updated regularly to help stations keep ahead of their competition with information they might not get otherwise.

"We would not be able to financially afford reporters in the various world capitals, or send reporters to various international and national stories," said Hal Brown, news director of Washington, D.C.'s all-news WTOP(AM). "We wouldn't even have the idea that they were occurring."

Customized services

Of course, not every station has the need to receive everything being offered; for example, an all-sports station would want the latest sports news, but probably not the latest business information. So, providers have constructed their hard copy services so that stations can customize them and receive only the information they really need. By customizing, said David Fox, managing editor of ZapNews, StandardNews's wire service division, stations "can save a consider-

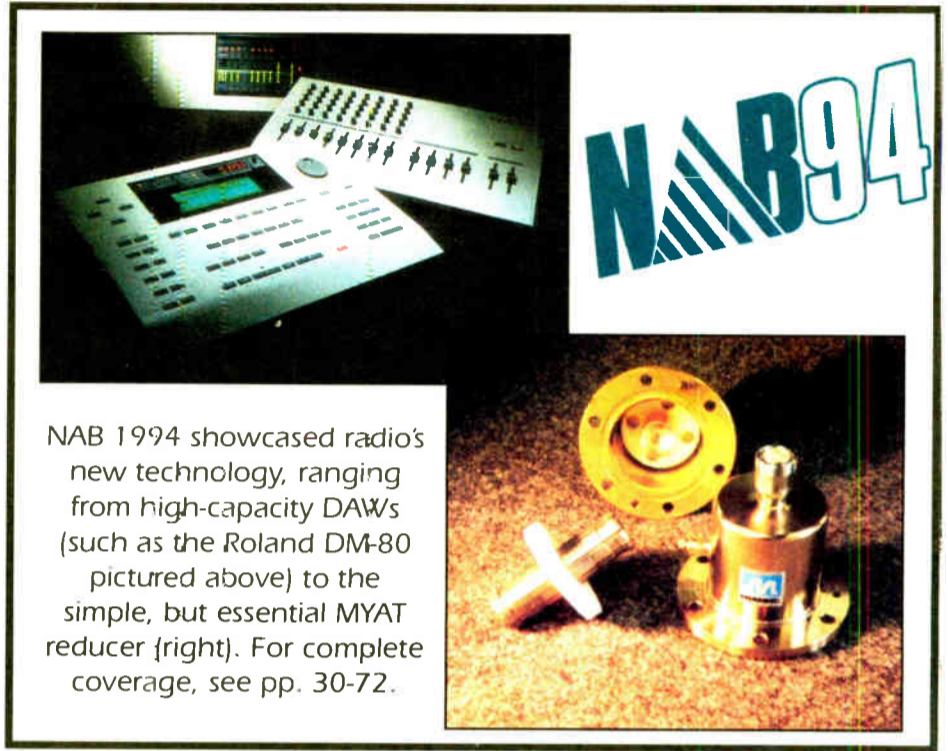

Few Slots for Expanded Band

by John Gatski

LAS VEGAS The original expectation of being able to put 250 AM stations on the new expanded AM band (1605-1705 kHz) has been whittled down to less than 100 allotments, according to FCC officials commenting during a panel at NAB.

FCC Audio Services Division Chief Larry Eads said the fewer than 100 allotments are

the result of a computer program calculation based on the FCC's interference protection criteria, and agreements with Mexico and Canada designed to protect border stations.

The expanded band is part of the FCC Docket 87-267, known as the AM improvement docket, and is one of the methods implemented to help relieve congestion and interference on the lower band.

At press time, the FCC said the actual station list was to be released as early as this month. However, the FCC is trying to address several petitions of reconsideration against the interference calculation criteria, which possibly could hold up the release of the list.

FCC officials also said that a few more stations eventually may be added to the expanded band following the initial allotment, but they do not want to pack it like the lower band.

NAB Manager of Regulatory Technical Affairs John Marino, said the lower-than-expected number of predicted allotments was a "surprise" considering that almost 1,000 stations applied. However, he said, "We understand that that this is a difficult process."

Jim Burtle, the FCC's AM Branch chief, said he is confident that some expanded stations will be broadcasting before year's end.

All stations approved for the expanded band will be allowed to simulcast on their old frequency for five years except stations located on 1590 and 1600 kHz who want 1610 or 1620 kHz. "Those stations are self-precluded from simulcasting" because of their current frequency, Burtle said.

Another factor in the approval of stations to the expanded band application is AM stereo. The FCC gave notice that it would give preference to stations that were stereo or intend to convert to AM stereo.

Approved stations will not only be stereo, but also transmit at 10 kW during the day and 1 kW at night. During the initial application process, some 50 kW daytimers applied for a slot just to get the nighttime coverage.

Protection parameters are different from stations on the lower band—including an 800 kilometer co-channel and 200-kilometer adjacent channel protection ratio (except for the stations on the high side of the existing band.)



NEWSWATCH

Harman 'Realigns'

WASHINGTON Harman International has announced plans for a realignment of its professional audio product companies in the U.S.

Slated for change will be the dbx division of AKG, which will move its manufacturing and marketing operations to Salt Lake City, and will report to the president of DoD Electronics. AKG microphones and headphones distribution, however, will be managed by JBL in

Northridge, Calif. These products and BSS gear were previously distributed by AKG-USA in San Leandro, Calif.

Lexicon will assume management oversight for the activities of Orban broadcast products in San Leandro and Studer Editech in Menlo Park, Calif. Lexicon will also distribute all Studer products in the U.S.

Kahn Suit To Proceed in Fall

WASHINGTON Oral argu-

ments in Leonard R. Kahn's appeal of the FCC's October 1993 decision to set Motorola's C-QUAM system as the national AM stereo transmission standard are not expected until this fall at the earliest, according to Kahn's lawyer, William Malone of Miller & Holbrooke.

Kahn, president of Kahn Communications Inc., Westbury, N.Y., and developer of the rival Kahn ISB AM stereo system, filed suit in the U.S. Court of Appeals in Washington earlier this year. Kahn alleged that in its selection of C-QUAM as the AM stereo standard, the FCC failed to consider evidence of antitrust violation by Motorola, currently

being considered by the Southern District of New York.

Kahn's filing also charges the commission with "abuse of discretion" for failing to consider comments submitted by broadcasters and engineers that claimed "technical defects inherent in the Motorola system."

Coupon Radio Joins With Rohde and Schwarz

NEW YORK European RBDS encoder manufacturer Rohde and Schwarz and Coupon Radio have entered into an agreement, which will help promote the Coupon Radio service in the U.S. and

Europe, as well as help familiarize U.S. broadcasters with Rohde and Schwarz products.

According to Coupon Radio President David Alwadish, Rohde and Schwarz has donated encoders to several U.S. broadcasters, including WQXR-FM in New York.

Coupon Radio is a technology that can use the RBDS data stream transmitted by broadcasters to send data to specially equipped receivers, such as "electronic" coupons and other promotional information.

Alwadish said he is now negotiating with consumer electronics companies to get products that will contain Coupon Radio capability.

Index

RUNNING RADIO

Broadcasters Rely On News Providers by Alan Haber	1, 12
The First Ladies of Country Radio by Charles Taylor	9
Stations Are Sold Better Separately by Bob Harris	11
Execute Flawless Performance Evaluations by Sue Jones	13
Premiere Radio Airs Seamless Sound by Pamela Watkins	16
Setting an Effective Promotional Agenda by Mark Lapidus	17
Localize Your Networked Station's News by Karl Baehr	21
DXers Club Develops Audio Magazine on Tape by Dee McVicker	22

FEATURES

More Power Is Allowed on Some Stormy Nights by Harold Hallikainen	24
Diodes Help Subdue Damaging DC Pulses by Ed Montgomery	27
Skywave Q and A Covers the Details by W.C. Alexander	28

NAB COVERAGE

New Technology for Test Gear by T. Carter Ross	30
Integration Is the Key to Source Gear by Dennis J. Martin	32
DAWs Handle the Tasks of Audio Management by Ty Ford	35
Variety of Wireless and Studio Mics by John Diamantis	42
RF Gear Provides Users With Economy and Value by T. Carter Ross	45
Processing Boxes Unveiled at NAB by Ed Bukont	46
Console Packed with Wide Range of Options by Nancy Reist	51
STL Technology Is Leading-Edge New by Nancy Reist	53
Creative Control with Automation by Dee McVicker	60
Innovation in RF Cable, Antennas, Towers by John Bisset	62

Only AUDIOARTS Has It...

WHEATSTONE'S STRENGTH! With Wheatstone's professional experience, engineering know-how, support capability and corporate stability behind it, this AUDIOARTS console design is the right choice.

The A-50 is cost effective through clever engineering and the latest advances in CAD design and electronic assembly procedures. It was developed by the same design team that creates Wheatstone's high end equipment. This console's performance is light years beyond the competition.

Naturally, it has all of the most important features: machine control functions, programmable channel logic, and three busses (Program, Audition, and Telephone). It also has the monitors you need: control room, studio and headphone—each with its own level control. It's designed so you can expand or add accessory modules as your needs grow.

You can benefit from our major market experience. Take advantage of Wheatstone's expertise and reputation; call us today for immediate action.



AUDIOARTS ENGINEERING
7305 Parkway
452-5000 / fax 315-452-0160

Wal-Mart Concerns Small Town Radio

by Nancy Reist

LAS VEGAS The session title says it all. "Wal-Mart Wars—What to Do When the Major Discounters Come to Town." A crowd of nervous radio personnel attended this presentation by RAB executives, George Hyde, Mike Mahone, and Gary Fries. Many of them raised their hands when they were asked whether a Wal-Mart had entered, or planned to enter, their market.

No. 1 retailer

Wal-Mart, America's number one retailer, has been a growing force in local economies. Hyde said their revenue has increased fifteen times in the last ten years, including a 56 percent increase in revenue in the last two years. They are present in every state but Vermont, and they have just received permission to buy out more than 100 stores in Canada. Hyde added that Wal-Mart Supercenters, which combine retailing with grocery, also are spreading. He said it is possible that Wal-Mart will be the nation's largest grocer in three years.

Small business operators tend to get nervous when a Wal-Mart comes to town, because the huge corporation can sell merchandise at prices that would bankrupt a small business. Mahone said Wal-Mart's policy is "always the lowest price, absolutely always."

Local radio stations also feel the pressure, since local businesses frequently cut expenses (i.e. advertising) in order to weather the storm. Mahone emphasized that Wal-Mart uses very little radio advertising, limiting it primarily to special events and the occasional Paul Harvey show.

The session presented two major approaches to this problem: First, radio broadcasters should learn about the Wal-Mart culture and consider ways to encourage Wal-Mart to invest in more radio advertising. Second, radio stations should develop ways to help local businesses cope.

A thrifty operation

Fries described the journey to Wal-Mart headquarters in Bentonville—a small, remote town in Arkansas. He described the headquarters as spartan and consistent with Wal-Mart's thrifty values.

Fries explained that Wal-Mart is stock driven and that many of the stock holders are right there in Bentonville. "They live so close to their stockholders that they feel them. They go to church together. They play bridge together. Their kids play on little league baseball teams together. This relationship is such that they have these philosophies that are like religions in their mind." Furthermore, over half of Wal-Mart's employees are stockholders, which gives them an interest in cutting expenses. This fosters a feeling that it is absolutely unacceptable to waste money.

Few radio ads

As a result, Fries said Wal-Mart spends one percent of its budget on advertising and has a goal of reducing that to zero.

Mahone said that media buying decisions are driven by price and that the biggest

share of their budget goes to circulars in mail and newspapers, spot TV and cable, and network TV for image management.

According to an RAB National Marketing Update, in 1992, Wal-Mart spent \$93,506,600 on the media, but only \$17,900 on radio.

Last July, Fries and a group of radio representatives met with Paul Higham, vice president of marketing and sales promotion; and Jacki Kelley, broadcast marketing manager. Ironically, Higham used to be a radio announcer.

Fries said that Higham understands and likes radio, but told him he does not have the money to spend. Higham also told Fries that radio advertising presents some logistic difficulties.

Despite obstacles, Fries expressed some hope for the future. He sees potential in Wal-Mart's interest in targeting the Hispanic and urban markets. He also said that Higham, who invited him to come back in a year, does appreciate radio.

Going for it

"We're going back. We see a crack in the door," Fries said. "We think we're going to get in there. Everything we do has to be global. We fight it out on the local front; we're going to get some money."

"But the real key is that we've got to change the thinking at the corporate headquarters and it's not going to be done by one radio station or a group of stations. We've got to sell radio to them. It's a difficult challenge, but we're talking about maybe doing something in database,

because we think our database in radio stations could be used to their advantage tremendously."

In the meantime, Mahone suggested radio sales staff should examine

their relationships with local business people. "We've got to stop selling and we've got to start marketing," he said.

"Selling is trying to convince someone that they ought to buy something. Marketing is so uniquely positioning what you have to sell, in this case your radio station, that the advertiser, that local retailer wants to buy your radio station."

Mahone suggested that sales personnel should learn about their clients' industries. They should recognize their clients' perspectives about unique problems facing the marketplace. They can then position their radio station as the solution to that problem.

He explained that the RAB can help with this process with Instant Backgrounds and Client Files which provide details about current trends in a variety of industries. They also have a large consumer database which is available to RAB members.

Business strategies

In addition, Hyde suggested a number of strategies which can help local retailers survive and even prosper when Wal-Mart arrives:

- Scout out the competition. Spend lots of time in Wal-Mart and figure out what they do well, where they are weak, and how you adapt to that. Start this process before Wal-Mart arrives so that you are prepared.
- Get out of health and beauty aids. Hyde

explained that this is one of Wal-Mart's strengths. "They are as close to a category killer as you are going to get in health and beauty aids. It's a big item for them. It's an important price area for them. It's an area that frankly a lot of people who are doing business in your markets might do well to avoid if they're looking for an opportunity to gain market share against a Wal-Mart."

•Consider upgrading areas where Wal-Mart is not as strong such as apparel, housewares, tools, automotive, apparel, local service, repair and rentals. Particularly within the area of apparel, target specific customers and their

customers and Sundays can generate a lot of revenue.

- Extend liberal return policies and cash refunds.
- Form customer panels to find out what people really want.
- Don't cut advertising. Focus your campaign on the things that you do and Wal-Mart doesn't, such as service, quality, or trade-ins.
- Be different. Stock unusual items and use creative displays.
- Stress customer relations. Remember that people hate to be ignored, so treat your customers well.

Hyde added that sales personnel should stress radio's advantages in targeting, image building, selling a product immediately, creating a receptive environment and expertise in promotion. He said that they should draw on the similarity of radio's competitive environment to help their clients.

"All of us have gone through this. What did we do? We developed expertise in a niche." We carved ourselves out a definable approach, strategy and chose to execute it with competence.

"That's why we've survived. That's why we've prospered. That's why we continue to grow. And that's exactly the same expertise we should be sharing with our clients if they're going to survive, if they're going to prosper, if they're going to grow."

Small business operators tend to get nervous when a Wal-Mart comes to town.

unique needs. Stress quality and competence.

•Be smart on pricing. Don't try to beat Wal-Mart in a price competition on the same product. Try alternative brands and products.

•Consider extending your hours. Convenient hours are very appealing to

NAB 94
SESSION COVERAGE

Speak Easy

with the
Comrex
Talk
Console™

Radio just took a big step forward with this Talk Radio Package. Easy to set up and easy to use anywhere, it includes everything needed to put callers on the air.

It conferences one or two phone lines with two microphone channels for host and guest. The second mic channel will also accept inputs like CDs or tape decks.

"CUE" lets you talk with the caller off air.

"HOLD" puts callers on hold and feeds program back to them. Integral mix-minus circuitry insures that callers won't hear their own echo when on air.

The Comrex Talk Console for:

- Syndicated Talk Programs
- Radio Features Production
- Remote Talk Show Broadcasts
- Newsroom Interviews



A sophisticated solution in a simple package.

COMREX

Comrex Corporation
65 Nonset Path, Acton, MA 01720
800-237-1776 In MA 508-263-1800
Fax 508-635-0401

Comrex (UK) Ltd.
75 The Grove, Ealing
London W5 5LL, UK
081-579-9143 Fax 081-840-0018

Business Is Brisk at the End of NAB

WASHINGTON As promised in the April 20 issue of RW, displayed throughout this issue's NAB Product Coverage section, you can find more detailed information on our NAB 1994 Cool Stuff Award winners.

Look for each one—they are featured in individual boxes with pictures and product information. My favorite part is knowing already that the Cool Stuff Awards winners are as popular with the industry as our panel of experts thought they would be. Before leaving the show floor, Gentner, for example, sold 55 systems of its award-winning Direct Connect Technology product line.

★ ★ ★

Other Cool Stuff honorees, such as Denon's MiniDisc recorder and player (that earned an honorable mention from our panel of experts) debuted at the show with a bang. The Denon MiniDisc boxes

were previewed at a terrific party at Caesar's Palace in The Augustus Room. Denon provided live entertainment with a wonderful performance from Marano &



Monteiro and a terrific setup for ongoing demos of the two boxes.

The party helped generate interest in the MiniDisc technology in general, and if you

stopped by the Sony, Otari or Denon booths during the show you could see for yourself that the companies were handing out tons of literature on the machines, and it was almost impossible to approach the products themselves from the crowds they were drawing. Congratulations Denon and Michael Stelts for a terrific launch of a new product.

★ ★ ★

Word from the manufacturers to date has been positive about the show. Business was brisk and a positive outlook is reported everywhere. Fidelipac's Roger Thanhouser, for instance, reports that the U.K.'s Royal Shakespeare Theatre is purchasing a series of DCR-1000s for its U.S. tour. The company will bring the media from the U.K. and pick up the DCR-1000s here.

It seems the DCR-1000, in its British incarnation, is quite popular with the more high-brow tastes there. Audio Systems Components, the U.K. company that licenses the DCR-1000's technology and distributes it as the D.A.R.T. (Digital Audio Recording Technology) just received an order for 60 players and 30 recorders from the BBC. This will bring the number installed at the Big Broadcasting Co.'s world headquarters to roughly 150 machines.

★ ★ ★

I have not quite finished recovering from the NAB spring show but I'm already thinking about the fall radio show (or should I say World Media Expo?). The NAB really needs to serve radio well at this Expo, or risk disenfranchising a large part of its membership.

I think radio and audio companies stand to gain much by the increased exposure to potential new clients and increased traffic by their booths, but having said that, I also think they stand a good chance of being overrun, if not overlooked, by the much-larger crowds attending the show for SMPTE.

In any event, time will tell which scenario will come to pass, but NAB already geared up the press machine and is cranking out releases about the coming gathering. Radio: Paul Harvey, long-time ABC Radio Network commentator,

delivers the keynote address on Friday, Oct. 14.

Harvey also will receive the "Spirit of Broadcasting" award from the NAB at the same radio luncheon. (Harvey is to receive a Peabody award for lifetime achievement in radio news on May 14.)

★ ★ ★

And speaking of positive press machines, the Radio Advertising Bureau (RAB) keeps cranking out the double digit revenue growth figures at a dizzying pace. According to the RAB's Radio Revenue Index of more than 100 markets, radio revenue climbed by 12 percent in the month of February 1994 (versus February 1993).

Local radio revenue was up by 10 percent in February, with every region of the country posting double-digit increases except for the Midwest, which grew at 8 percent.

The biggest growth was by national spot, up 20 percent over last year's February numbers, with increases as high as 37 percent in the Southeast and 23 percent in the Midwest.

The RAB reports that year-to-date revenue is up 12 percent overall versus the same period in 1993, with local ad growth up 11 percent and national spot up 15 percent.

Gold Rush in New York

Whether you love Rush Limbaugh, or just love to hate him, you have to admit the man can draw a crowd. As the host of the highest-rated syndicated radio show, Limbaugh owns one of America's golden voices.

To state the obvious, however, he would be nobody without the proper technology to broadcast his own brand of conservatism and "words of wisdom."

Those of you who are fans of his might have heard him talk about his Electro-Voice RE20 "golden microphone" during broadcasts on the Excellence in Broadcasting network. Electro-Voice (EV) decided to give Limbaugh a real "golden" microphone.

Mark IV Audio (the parent company of EV) President Bob Pabst (pictured standing) recently stopped by the New York studios of ABC/Capital Cities to present Limbaugh (pictured sitting) with the first and only gold-plated Electro-Voice RE20 mic.

"It is stunning," said Limbaugh, on the air. "There is simply not another microphone like this one."

EV is a 60-year manufacturer of speakers, microphones and electronics for professional audio markets.



The Board of Directors of MLJ Inc. (Moffet, Larson & Johnson Inc.) appointed A. Richard Burke as president of MLJ. Burke moves up from his position as executive vice president effective immediately.

Odessa Drayton-Iton was named regional radio executive in New England for the broadcast division of The Associated Press. Drayton-Iton will handle AP's radio membership and marketing activities in Maine, Massachusetts, New Hampshire, Rhode Island and Vermont.



Get on the right track...

Unattended operation helps you operate your station profitably. All it takes is a satellite or automation program source, a good transmitter control system, and a way to handle EBS.

You take care of the program source... We'll help with the rest.

A transmitter control system from Burk Technology relieves you of the need to keep someone at the station just to take transmitter readings. Add our exclusive Studio I/O and we'll run EBS for you, too.

Burk gives you the flexibility to run your station the way you want, and in full compliance with FCC rules.

Call us now. We'll show you a new way to run a railroad.

TOLL FREE 1-800 255-8090

BURK
TECHNOLOGY

7 Lomar Drive, Pepperell, MA, 01463 (508) 433-8877

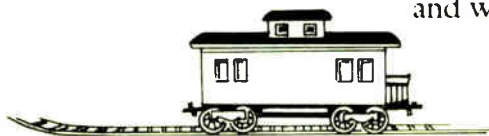

READERS FORUM

If you have comments for Radio World, call us at 800-336-3045 or send a letter to Readers Forum (Radio World, Box 1214, Falls Church, VA 22041 or MCI Mailbox #302-7776). All letters received become the property of Radio World, to be used at our discretion and as space permits.

Missed one

Dear RW,

A recent issue listed and described almost every available digital audio workstation suitable for broadcast production, from Roland to AKG (RW, Feb. 23). I say almost because the most popular DAW, Pro Tools by Digidesign, was omitted.

I can't imagine why PT was left out, since it is the de facto standard of the recording industry, offering high-quality audio, friendly software and the best price/performance ratio out there.

After much research, I installed a four-track Pro Tools in a Mac Quadra 950 at my home studio. A few weeks later the production and engineering departments at my station bought the eight-track version. Our Otari eight-track reel-to-reel is now in storage.

Paul Christy
KHM(X)FM Houston

Penny-wise NAB foolish

Dear RW,

Last week I watched the pictures of tornado devastation in Georgia. No matter what new Emergency Broadcast System replacement the FCC selects, it certainly would have reduced the death toll of this typical disaster had it been in place earlier.

Yesterday I read in the RW cover story (April 6) that the National Association of Broadcasters has decided to make a last-minute attempt to scuttle the EBS upgrade because of cost.

Never mind that, as you point out, it was the NAB that started the FCC process to upgrade the EBS. Never mind the issues of life and death and public service. The fact is that a new EBS should save both lives and money.

From the very beginning, every serious EBS design I am aware of sought to reduce cost and save lives. (Personally, and arguably because of my involvement with the Denver SBE chapter's experimental system and its later evolution, I believe some approaches accomplish these

dual goals better than others.)

The cost of the current EBS is high in manpower. Any new EBS would not require 24-hour monitoring by an operator and all are self-logging, which really reduces exposure to fine. The current system consumes air time that adds up to millions industry-wide.

It also drives audiences away. When was the last time you listened to the whole EBS test since the invention of the push-button radio or the TV remote control?

I suspect that this delay is the result of an information flow glitch inside the NAB, and I hope that even as I write this, information is flowing and damage control is taking place. Still, I can't avoid taking a good-natured jab at the NAB.

What the NAB membership wanted is lower operating costs. Somehow that translated into opposition to a new EBS. Then again, there are stations that generate logs with three employees and a typewriter, all to avoid the cost of a computer.

Frederick M. Baumgartner
Engineering Manager
KDVR(TV) Denver

Editor's note: Mr. Baumgartner was formerly an engineer with TFT Inc., and was one of the developers of TFT's EIS 911 EBS system.

Sony/AMAX a hit

Dear RW,

After all the fighting and litigation and FCC decision making, I was excited to read about the new Sony SRF-42 Walkman AM stereo/FM receiver that was profiled in RW (March 9). That profile proved amazingly true.

I was able to track down where it was for sale in Denver and bought one. I was absolutely thrilled and excited when I heard it for myself. And, the price was not prohibitive.

I even hooked it up to a large stereo via an auxiliary input and several from our air staff were as amazed as I was. Everybody wanted one.

One of our advertisers bought 10 SRF-42s wholesale from the local establishment that carries them and resold them to our listeners. Not only has this generated new business for our advertiser, but it has increased the pace of sales at the original store.

Hopefully, Sony will take notice and put the system into more models. I believe that this technology could really help those of us who love AM and want to see it succeed with our listeners.

AMs should get on the bandwagon, and find out how to make AMAX AM stereo available to listeners. We are running AMAX promos on both our stations, which is generating several calls per day from those looking for places to purchase them.

All the AMs in our radio group (Crawford Broadcasting Co.) are stereo stations, and our listeners already appreciate the quality of our signals. AMAX can only make things better.

I used to work in audio retail. I remember the Sony representatives saying, "If you want a new feature in a system, the first thing Tokyo asks is, 'How many more will you sell?'"

A Search For New Ideas

The National Association of Broadcasters' Radio Futures Committee, under the leadership of Dick Ferguson, president and CEO of NewCity Communications, is searching for ideas to integrate radio into the "information super-highway."

It is a timely search, well worth the energies of as many radio broadcasters as possible.

The committee is scheduled to meet on May 12 to discuss the business opportunities presented by new wireless digital technologies. Ferguson sent out a call (unfortunately, after the deadline for RW's April 20 issue) to send ideas to the committee by April 30.

This issue will be in wide circulation before May 12, so RW offers here a few thoughts to consider at the meeting.

At this stage, the politics of U.S. telecommunications are at least as important as the technology. The technology will not seem very impressive unless radio stations have access to more spectrum.

NAB is currently working to achieve "spectrum flexibility" to help TV broadcasters establish themselves as major wireless information providers over their future HDTV allotments. Radio must push for additional spectrum of its own, either through increased duopoly and LMA limits (as suggested in this space before), or by bidding on other available frequencies.

This will be a tough political fight, contradicting the prevailing Washington interpretation of broadcasters' public interest responsibilities. Broadcasters can win the fight if the list of services they can deliver over full AM and FM channels awes policymakers.

The services that are already planned via RBDS at 1.2 kilobits per second (kbps) or FM subcarrier systems at 20 kbps—paging, global positioning, transmission of a few characters or graphic logos—are creative and useful. Imagine what is possible if radio broadcasters are able to work with hundreds of kilobits per second.

Hopefully, the futures committee will consider this as it makes up its list of wireless data business opportunities. Hopefully, some of the ideas submitted to the group deal with data rates above 20 kbps.

Contact the committee (care of Ferguson) at NAB headquarters, 1771 N. St., NW, Washington DC 20036; fax 202-429-5406—or send suggestions to RW. There is no deadline on good ideas.

—RW

I hope other AMs will take advantage of the opportunity before us and promote a change in the public perception. It can happen with work and dedication.

K.C. O'Brien, chief operator
& afternoon announcer
KLZ(AM)-KLTT(FM) Denver

Language will change

Dear RW,

Bill Bish is right and wrong ("Guest Editorial," RW, April 6).

He's right to ask for avoidance of sloppiness. I also wince when I hear nuclear, ass-ess-ery, ar-deek or artic. Broadcasters have a great responsibility and are caretakers of our language.

He's right about paying attention to details. We should pronounce foreign words properly. It's not Tenamen, Tienmen or Tienamen, but Tien-an-men, heavenly peace gate.

The matter is difficult and fascinating. Language will change, regardless of our preferences. It's appropriate to shorten and simplify, but when?

Bish wants us to say Wed-nes-day on the air, but I don't fear anyone say anything but Wensday. It's an improvement to say veg-tab-ble and not veg-e-ta-ble. He says a logical contraction of zero should start with z, and not be simply oh. But oh is easy to say and there is an advantage to getting much communication into less time.

Chinese, a much older language than English, no longer has conjugated verbs and has been simplified in other ways. It is much easier to learn than English or French.

How far back would Bill Bish go to locate "correct" English? Matthew 5:25 reads: "Agree with thine adversary quickly whiles thou art in the way with him."

We Quakers like the "thee/thou" forms because they are singular, while in England and the U.S., people adopted the plural and not-intimate form, "you." We think "thee" shows more respect for the individual, but that is a long lost cause.

There is a "two-thirty at night." Bish wants us to say "...in the morning," but it's natural to think of morning as when the dawn comes, not the minute after midnight.

I will show my respect for Mr. Bish's concern by adding to his editorial. I'm sure he would agree that we in the broadcast media should use the rich language with the largest vocabulary in the world, instead of repeating clichés.

We all know it is poverty of speech that causes many in the military to use one or two taboo words as all purpose adjectives. In the electronic media, can't we get away from "Please welcome..." and other too-often repeated phrases.

Y'r humble & ob't servant,
William L. Hanson
Attorney, Seattle

Editor's note: Military men with limited vocabularies do have the virtue of concise, simple and unambiguous expression, and the taboo adjectives tend to insure their messages are received and well understood.

Language does change. Perhaps broadcasters' chief responsibility is to help it change for the better.

Correction

Milestone Technologies Inc., listed in the April 20 "RBDS Roll Call," can be reached at 919-856-0700.

Radio World

Vol. 18, No. 9

May 4, 1994

Editor.....Lucia Cobo
Managing Editor.....Randy Sukow
News/Studio Sessions Editor.....John Gatski
Associate Editor.....T. Carter Ross
Contributors.....Frank Beacham/N.Y.
Bruce Ingram, Pamela Watkins, Nancy Reist
Technical Editor.....John Bisset
Technical Advisor.....Tom McGinley
Editor (International).....Alan Carter
Managing Editor (International).....Charles Taylor



Radio World (ISSN: 0274-8541) is published bi-weekly by Industrial Marketing Advisory Services, Inc., 5827 Columbia Pike, Suite 310, Falls Church, VA 22041. Phone: 703-998-7600. Fax: 703-998-2966. Second-class postage rates are paid at Falls Church VA 22046 and additional mailing offices. POSTMASTER: Send 3579 forms and address changes to Radio World, P.O. Box 1214, Falls Church VA 22041. Copyright 1994 by Industrial Marketing Advisory Services, Inc. All rights reserved.

—PRINTED IN THE USA—

Next Issue of
Radio World
May 24, 1994

Access a Key Issue for Management

by Tom McGinley

LAS VEGAS A sparsely attended, but valuable Monday morning session, entitled "Managing in Broadcasting Engineering," targeted three specialized areas of concern facing all broadcast engineers and plant managers: Environmental Auditing, Compliance with ADA (Americans with Disabilities Act), and Continuing Education.

The low attendance was no doubt affected by the concurrently scheduled session on Digital Audio Processing.

Daniel Boone, an environmental consultant with Camp, Dresser, & McKee, presented a comprehensive overview of how to conduct an environmental audit of your facilities.

Broadcast stations are not likely to be inspected by the EPA (FCC style), he said, unless a formal complaint has been filed by an ex-employee or a neighbor. As with FCC inspections, fines for environmental non-compliance can be very expensive, running as high as \$25,000 per day.

Beware of the audit

A plant audit will reveal what you are up against, in terms of issues of liability, and should reveal cost saving alternatives.

The main areas of environmental compliance concern are UST's (underground storage tanks, commonly used for emergency generator fuel storage), PCB's (polychloro-biphenyl liquid coolant used in transformers and capacitors, as well as fluorescent light ballasts), and the handling and

storage of toxic chemicals used as cleaning agents and in weed control.

Conducting an audit first requires pre-audit planning. First, contact any relevant state or federal agency which regulates environmental impact in those areas which you think your station may have some exposure or liability i.e., EPA and state environmental affairs agencies.

Know your regulations

Gather all the input you can regarding regulations which may affect you. Then decide what you hope to accomplish by conducting an audit, choose a team of pertinent individuals, and develop a questionnaire with which to gather relevant information. The actual audit would consist of a kick-off meeting (useful if an outside agent is involved), a review of all records, including permits and MSDS (material safety data sheets), a facility walk-through including personnel interviews, and completion of the questionnaire.

After the audit, a final report will need to be written. This report will summarize any non-compliance areas, and should be made available in draft form to all interested parties for further comment and input. The final report should provide a mechanism for an annual update in order to pick up any new regulations and insure that any permits are renewed.

Broadcast facilities managers should view environmental compliance just like FCC

compliance. They are real requirements, carrying steep fines and penalties for serious infractions. If you ignore any of them, they may very well come back to haunt you later.

Access compliance

Frank Reese, president of Reese & Associates, an architectural design firm specializing in broadcast facilities discussed the real-world impact of the ADA of 1974 on radio-TV physical plant design. This is the landmark civil rights legislation which has laid the legal framework for requiring

Gather all the input you can regarding regulations that may affect you.

that all buildings be accessible and useable by disabled individuals. No longer do we refer to the disabled as being "handi-

capped." If your facility was constructed within the past 15 years, it probably does comply with the ADA.

Basically, you must provide any disabled person who may want to come to your station "reasonable accommodations" to park their car near the entrance, get into the building unaided, access the public areas to view or participate, or any other areas where they would work if they were employed there, and to be able to easily access the public rest room facilities.

Effort to comply

The law requires that you make a good faith effort to comply, but that you do not have to undergo "undue hardship" or spend unreasonable amounts of money, but rather provide accessibility that is readily achievable.

The ADA is not an affirmative action statute. You do not have to seek out disabled individuals for employment opportunities.

It is relatively easy to design all necessary access accommodations into a brand new facility at virtually the same overall costs as a facility without such accommodations.

Reese described some of the provisions his firm has incorporated into the design of the new home for Georgia

Public Television. At no additional premium, ramps instead of steps are provided for all elevated areas and five feet wide doorways are built for all public bathrooms and public entry ways. If you choose to renovate an existing building, which may need some modifications to comply with ADA, here are the basic guidelines:

Know what you need

You do not have to make everything accessible. For parking spaces, only 4 percent of any total up to 25 spaces and only 2 percent from 25 to 500 spaces must be marked for disabled-use only.

Half of all elevators must be accessible, and half of all public access doorways must be five feet wide. Only half of the public rest rooms must be accessible. Ramp inclines may not exceed five degrees. You do not have to provide special access for the disabled to be able to carry out a job which he would not normally be able to carry out, such as tower climbing.

Reese stressed that as public trustees, all

broadcasters need to meet the "spirit of the law" when dealing with the ADA. If in doubt about any of its provisions, consult an expert. The following telephone numbers may be helpful: For equal employment issues regarding the disabled, call 1-800-USA-EEOC. For public accommodations questions, call 1-202-514-0301. And for architectural questions, call 1-800-USA-ABLE.

"Back to School" was the title of Dr. Cory Carbonarra's rousing tutorial on the vital importance for all broadcast engineers to avail themselves of the many sources of Continuing Education.

Dr. Carbonarra, presently an assistant professor of communications at Baylor University, has worked in the industry as well, including Sony's HDTV program.

"Continuing Education," he said, "positions engineers to handle tomorrow's technologies today."

Stay current

With change being inevitable, Carbonarra cited the tremendous convergence of broadcast, video, cable, telephone, and computers taking place almost overnight. "Managing that change is a strategic decision. Using Continuing Education is a tactic."

Carbonarra traced the evolution of the engines which drove the industrial revolution, starting with the steam engine and the railroads through the 1800's. Then came electricity and the internal combustion engine. By the 1970's, microelectronics and the computer were starting to push industrial advancement into a whole new realm. The old electro-mechanical structure is rapidly being replaced by computational structures (digital computers).

All engineers need to develop a knowledge base of the converging technologies, Carbonarra said. Some of the newly created media resources which did not even exist a few years ago include computer access of CompuServe and Internet, Satellite delivered courses, and CD ROM courses.

Carbonarra then highlighted the various professional societies and trade organizations which devote a significant part of their resources and efforts to continuing education, including: SBE, SMPTE, IEEE, AES, AFI (American Film Institute), and of course the NAB.

SBE has reaffirmed its number one priority as training for the working engineer.

The SBE Certification Program continues to grow and stimulate educational advancement and skill enhancement.

All of the aforementioned groups have their own technical conventions or symposia, plus published proceedings of seminars and papers, which serve as great resources for engineers eager to learn.

Seminars

Manufacturers' training seminars are becoming more available to provide specific instruction on operations and maintenance of new technology broadcast gear. Harris, Broadcast Electronics, Continental, CCA, Grass Valley, and Sony are just a few such companies.

Dell Computer has established its own internal training resource, known as "Dell University."

Of course, the traditional learning centers such as colleges, universities, and technical trade schools continue to offer the working engineer opportunities during evening hours and weekends to advance their skills and knowledge.

We maintain a Double Standard

Audio Precision offers two different standard-setting product lines.

The automated System One – the industry standard for bench and factory.

- Graphic results on PC screen with hard copy to printers
- Automated proof procedures & limits testing
- State-of-the-art performance and speed

The self-contained Portable One Plus & Portable One – for service bench and field.

- Compact and affordable stereo test sets for applications not requiring automation
- Both offer comprehensive capability & high performance in a rugged package
- Portable One Plus adds sweeps, graphs and printer port

The System One and Portable One... two families of test sets designed for different jobs, each with the quality and performance that you have come to expect from Audio Precision.



Audio precision

RD. Box 2209, Beaverton, OR 97075
503/627-0832 1-800/231-7350
FAX: 503/641-8906, TELEX: 283957 AUDIO UR

Firing without Just Cause Not Always Legal

by Dee McVicker

SAN FRANCISCO It might be standard practice for station personnel to be fired without justifiable cause in the radio industry, but it is not always legal—at least not in California, according to a recent ruling in a California Superior Court.

On March 10, a unanimous 12-person jury vote awarded more than \$1 million to Diana Kimbrell, who claimed she was unjustly terminated by a station combo in San Francisco. Kimbrell was the national sales manager at KNEW(AM)-KSAN-FM, then owned by Malrite Communications, until her termination in 1992.

"I was there for seven years. There was nothing in my personnel file. There was nothing verbal, no warning," said Kimbrell, who said that Malrite argued that it is standard industry practice to fire people without cause.

A sympathetic jury

Under California's wrongful discharge law, however, businesses—including radio stations—must show justifiable cause for employee termination, according to Kimbrell's attorney, Roderick P. Bushnell of Bushnell, Caplan & Fielding.

"They weren't able to justify the termination in court and the jurors felt that, to the extent that they relied on the defense (contention) that this was the way the radio industry does business, it was a violation of the law," Bushnell said.

John Schohl, general counsel for Malrite Communications, said his company is planning to appeal the court decision. "We obviously believe the jurors made the wrong decision and didn't follow the law," he said.

"California law has indicated you can take into account industry practice," he said. (But) "We don't fire people just because the industry thinks people can be fired. We fire them because we believe their performance is not up to the standards we expect."

Schohl said the group fired Kimbrell due to 11 months of poor sales performance, and that was the primary defense in the case.

Bushnell's attorneys, however, countered the poor performance claim by calling eight former station employees, whose testimonies at the 13-day trial helped bolster Kimbrell's claim that she was a competent sales manager.

Bushnell tried a similar case in 1991 in

which a general manager was terminated from a television station. This case also resulted in a favorable verdict for the plaintiff.

Had this case been tried in another state, however, it is likely the verdict would not have been in the plaintiff's favor. According to Steve Bookshester, associate general counsel with the National Association of Broadcasters, "most jurisdictions have the old common law of employment at will."

"Employment at will is the basic rule of employment law; you can fire anybody at any time for no reason," he explained. "And most jurisdictions are employment at will jurisdictions."

A moral victory

Nonetheless, Kimbrell, who is now working in the publications division for a non-commercial station, believes the verdict is as much a moral victory for her as it is for the radio industry. "I think it (the verdict) really is enlightening people. I have heard a lot of managers that are very pro the verdict, because they have also been in that position at one time or another. I even had general managers call me and tell me they were forced to fire people that they didn't believe (should be fired). I think everybody has seen an unfairness at some level," she said.

Questionable firings are very prevalent among radio announcers and news personnel, according to Brian Denny of Broadcast Employment Weekly, an industry job bank available on computer bulletin board services such as computerServe and Internet.

In many cases, the reason is poor ratings, Denny explained. "More often than not, I deal with jocks who get fired or laid off because the ratings aren't what they should be, or what the station feels they should be. And that is a very subjective point of view."

A tough career

Adding to the industry's fickle job market is the nature of the business, Denny said. "In radio, the nature of things is you start out, you get out of high school and you get a bug for radio. You may or may not go to college to get some sort of degree in broadcasting. You go to work for a small-market station in the middle of nowhere and you're really not that talented—it takes time to develop talent."

"If you want to grow and start to make a good living, and quite frankly radio has got to be one of the worst paying career groups you could get yourself into...so what you have to do is uproot the family, move to a larger market," he said.

Denny said he's also observed a similar trend in the station manager job market, in which an employee has worked him or herself up from air talent to program director

to perhaps even general manager.... "if you want to move up into the next salary bracket, you're going to have to pick up and move to a larger market."

When it comes to employment in the radio industry, "There is not one stitch of loyalty in this business," Denny said.

Kimbrell hopes her recent victory will help change radio industry approach to its employees. "It's something that we have accepted in a way, where people think it's a fast-paced business with owner changes and format changes (and therefore justified)," she said. "But because it's done doesn't mean it's right."



The Associated Press is set to debut an all-news radio network designed to provide news and information programming live, 24 hours a day.

AP All News Radio, set to launch June 1, is commercial free, allowing stations complete control of commercial inventory. Affiliates can preempt network programming in favor of local programming at any time because there are no commercial clearance requirements.

Pictured above in AP's Washington, D.C., Broadcast Center are AP All News Radio Anchors Camille Bohannon, Mike Moss, Steve Porter and Chuck Rice.

For information, contact Associated Press Broadcast Services at 202-736-1152; or circle **Reader Service 199**.

FM ANTENNAS

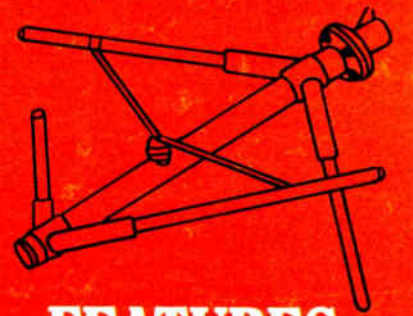

FEATURES

- Multi-Element Arrays
- Input Powers from 100W to 240 kW
- Circular, Vertical, or Horizontal Polarization
- Custom Directional Antennas
- Quality Construction Built to Last



Systems With Reliability

1-800-762-7743

Systems With Reliability

Transmission Lines & Antennas
Celebrating Our 25th Year

Cambria County Industrial Park
Ebensburg, Pa. 15931-0856
Fax: 814-472-5552



Encore Series™ DISTRIBUTION AMPLIFIERS

Isolate, balance and set levels precisely

A small price to pay (for real protection)

AUDIO TECHNOLOGIES, INC. 328 Maple Avenue, Horsham, PA, 19044 • (215) 443-0330
Call or write for free detailed brochure. FAX (215) 443-0394 • 800-959-0307



Circle (49) On Reader Service Card

World Radio History

Circle (94) On Reader Service Card

San Francisco

Wilkes-Barre/Scranton

Nashville

Greenville-New Bern

St. Louis

Mobile-Pensacola

Lansing

Panama City

Buffalo

Utica-Rome

Denver

And

Tulsa

More!

GERRY

HOUSE

AND THE HOUSE FOUNDATION



**AMERICA'S #1
SYNDICATED COUNTRY
MORNING SHOW!**

**PREMIERE
RADIO NETWORKS**

Circle (101) On Reader Service Card

Contact your Premiere Radio Networks representative at (818) 377-5300

World Radio History

Running Radio

Your Resource for Business, Programming & Sales

Satellite stations can localize their news. See **Uplink** page 21.

USAIRPLAY

The First Ladies of Country Radio

by Charles Taylor

WASHINGTON Country music's newfound ability to captivate the mainstream certainly has roped in its share of exposure over the past couple years.

Record companies are successfully marketing albums that showcase country talent on soundtracks and tributes—such as the wildly successful "Common Threads" CD of Eagles renames. Television networks, meanwhile, are reaping ratings with country music specials loosely wrap-ped around most any holiday.

Even movies, like "Pure Country" with singer George Strait, or "8 Seconds," in which Hollywood idol-light Luke Perry plods through the biography of rodeo rider Lane Frost, are demonstrating the most commercial faith in the genre since the "Urban Cowboy" heyday of the early 1980s.

On the USAirwaves, country music is heard on a total of 2,601 radio stations,

according to The M Street Journal. That's 75 more than a year before, and 1,003 more than the No. 2 format in the U.S., adult contemporary.

In line with the format's popularity, a new generation of radio artists has taken root, from the late 1980's introduction of Clint Black, Garth Brooks and Alan

Jackson to more recent sensations like John Michael Montgomery and Clay Walker. While the format's proliferation marks a new maturity for the genre, still, a disproportionate number of these new stars either sport cowboy hats or sideburns.

In other words, where are the women?

Country music, with few exceptions—perhaps Tammy Wynette,

Loretta Lynn and Dolly Parton—traditionally embraced male singers for its superstar class. Over the past several years, however, a class of female vocalists has finally begun to work its way out, determined to contend with its deep-

er-voiced counterparts on all levels. This group is adding a vitality that country music needs to secure the emotional range heard on other formats.

Top 40 held a similar status in the early 1980s. With the exception of Diana Ross and Olivia Newton-John, the charts were inundated with male-dominated acts like Styx, Hall & Oats and Michael Jackson. Then came Madonna and Cyndi Lauper.

Today, the format's biggest stars share the stage with women. Not only are there Eric Clapton, Phil Collins and Michael Bolton, but Whitney, Mariah and Janet.

Country music is on its way to attaining similar harmony, thanks to radio's recognition of the power of the female voice. I tip my hat to the following 10 voices that make country radio more vibrant today than ever:

Wynonna - A quintessential artist for all

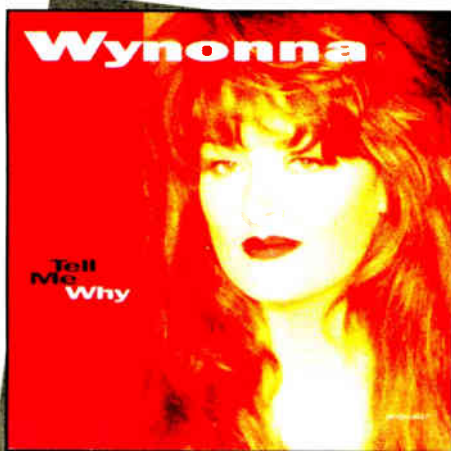

Quintessential artist Wynonna Judd

We've always done news. Now we're making news!

United Press International's new product line changes the way the media uses information!

UPI has always meant accurate news and information. Our recent investment in worldwide satellite telecommunications makes us the fastest, easiest and most affordable way to get required information. And now more than ever, UPI means business with a new line-up of products and services that will put you ahead of the competition.

Talk to us now!

**(800)
503-9993**

Worldwide
Headquarters
1400 Eye Street NW
Washington, DC
20005



MONEY IN THE BANK!



"No Place Like Home"

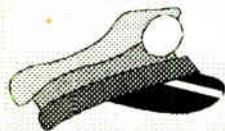

voiced by Mayberry's own

DON KNOTTS

Laugh all the way to the bank with this whimsical and entertaining shop local campaign!

Call 1-800-950-5787

Radio Concepts, Inc.



Photo by John Loizides

Piecing it all together, right before your eyes...

Standard News

Radio network...wire service...all in one!
Customize your local newscast with world and national news from The Washington NewsDesk.

Call 800-283-4147.

Circle (91) On Reader Service Card

World Radio History

Stations Are Sold Better Separately

by Bob Harris

DALLAS As result of an earlier **RW** column, Larry England, general manager of WGAU(AM) and WNGC-FM, Athens, Ga., called with a column challenge. How would I suggest his combo sales staff apportion their sales times between AM and FM? Larry wanted a "time management" formula to use.

Here's his scenario: An old-line AM, now mostly talk (Rush, Gordon, Larry—you get the picture), and his killer country FM, the first FM station in the state of Georgia. He has eight combo salespeople and wants to motivate them to spend more time, or the right amount of time, selling the AM.

My response, "Sorry, Charlie." I don't think there is any magic formula or motivational tool to get a radio salesperson to sell a station, a format or a personality he or she does not like or does not want to sell.

Jury still out

I don't think the jury is in yet on the sales success of all these newly combined (reduced) sales staffs for all the LMAs and duopoly situations out there. What I see is expense reduction, not sales increase. I don't believe you can increase sales when you cut salespeople.

But, back to Larry and beautiful Athens, the home of the University of Georgia Bulldogs, whose games are carried by WGAU. I told Larry of my personal experience in a situation almost identical to his.

In 1986, I was hired as the first, and only, KLIF(AM) salesperson. The station had just switched to a talk format, and its sister station, KPLX-FM, was and is a killer country station here in Dallas.

The FM station had nine salespeople who could all sell the FM by itself, the AM and FM in combo, or even the AM by itself. I could only sell the AM, and I could not call on any account or agency that any of the

other FM salespeople had on their list.

Obviously I had to get new business on the air to survive, and I did. No agency would buy the station alone at that point, so everything I sold was direct business. It worked, and my business grew. KLIF carried a lot of specialty programs on the weekend, and I soon became the Green Thumb Guru.

A green thumb

The lawn and garden category became the backbone of my personal business for a few years. I guess it was my first experience in radio with vendor programs, co-op advertising and distributor-funded programs. It was a niche I was willing to work because I enjoyed the category (you

Most AM/FM combos don't appeal to the same demographic

should see my vegetable garden today), and I was able to earn a living.

Gradually, KLIF added additional people to the AM-only sales staff. The second hire, actually a transfer from the FM side, Sabrina Bunks, is now local sales manager for KLIF.

I suggested to Larry that he call Sabrina and get her input, since the format situation, although not market size, was identical to his situation.

Today, some eight years later, KLIF has a full complement of nine AM only salespeople who all earn a good living. None of the FM people sell the AM and none of the AM people sell the FM. Everybody seems happy and business is extremely good for both stations, particularly the AM talk station that once could barely support one salesperson; me.

I think the moral of the story is specialization and concentration on one property

will bring greater sales success than a salesperson (particularly with LMAs and duopolies) trying to be all things to all buyers.

Most AM/FM combos don't appeal to the same demographic (this appears to be true in Larry's case in Athens), and when most direct clients have to rifle shoot to reach their customer base, you don't have a logical sales effort.

But the biggest drawback, according to Bunks, is that the salespeople, and, for that matter, even sales management, cannot focus on two stations successfully. It's too hard to concentrate on so many different things for each station: format, personalities, demographics, rates, and make effective and believable sales presentations.

As Bunks put it: "One plus one does not equal two when one person is selling two stations. It's more like one and a half. KLIF did not experience the quantum growth it has had in revenue until a separate sales staff was put in place."

Certainly there are situations where combo selling is cost effective and makes sense economically. However, in my humble opinion, the only way to maximize revenue for a radio station is with its own separate sales staff.

□ □ □
Bob Harris is a sales and marketing consultant to the food manufacturer, food broker and broadcasting industries, based in Dallas, Texas. Do you agree or disagree with his premise that to maximize sales revenue for a station you must have a separate sales staff? Does the philosophy change if there is an LMA or duopoly situation? How has your station handled this sales staffing issue?

Bob would love to hear from you with your views on this topic, or if you want equal time for an opposing view.

He can be reached at PSM, 900 East Park Blvd., Suite 130, Plano, TX 75074; phone 214-424-9660; or fax: 214-578-7084.

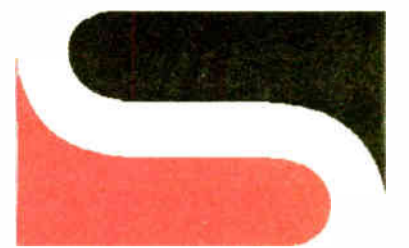

Svetlana
ELECTRON DEVICES

Quality* Power Tubes

- 3CX15,000A7
- 3CX10,000A7
- 3CX3000A7
- 3CX3000F7
- 3CX2500F3
- 3CX2500A3
- 3CX2500H3
- YC130
- 4CX15,000A
- 4CX10,000D
- 4CX5000A
- 4CX5000R
- 4CX3500A
- 4CX1500A
- 4CX350A
- 4CX350AC
- 4CX250B
- 4CX250BC
- 4CX250R
- 4X150A
- 5CX1500A
- 5CX1500B
- 811A
- 813
- 833A
- 8560AS



- Watch this list grow.
- Manufactured in Russia's largest power tube factory.
- Generous* warranty based on high quality.
- Honest prices based on quality at low cost.
- Shipment from USA stock.



Svetlana
ELECTRON DEVICES

Broadcasters
Call: 800-239-6900
FAX: 205-880-8077

OEMs, Distributors,
Volume Purchasers
Call: 415-233-0429
FAX: 415-233-0439

THE SECRET'S OUT—DIGITAL FURNITURE

MODULAR
FLEXIBILITY
WITH A
CUSTOM FIT

We Offer Six Elegant
Lines of Studio Furniture

4153 BONITA STREET
SPRING VALLEY, CA 91977
PHONE 619/698-4658
FAX 619/698-1268

MURPHY
STUDIO FURNITURE

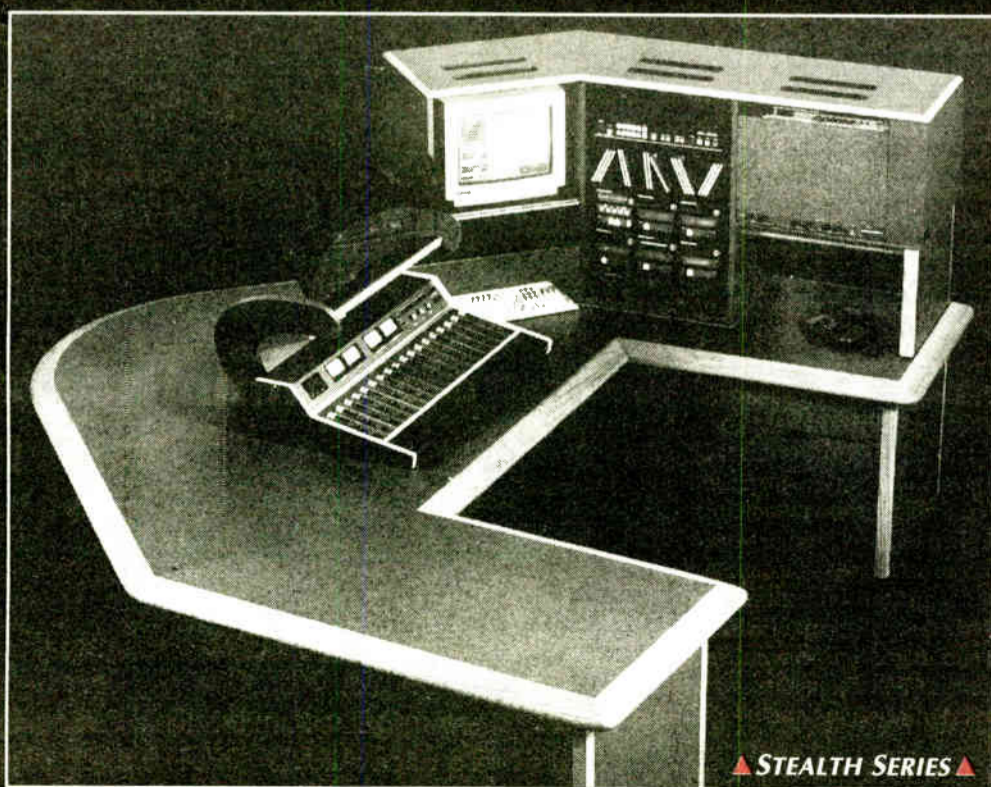

▲ STEALTH SERIES ▲

Menu of Wire Services Is Available

► continued from page 1

offered by AP DriveTime and AP Headlines, more information on international, national and state news; and AP NewsTalk, a premium level of service for information-intensive stations which adds detailed newspaper-length stories from the AP newspaper wire.

AP's NewsDesk software, like the software offered by other providers, is easy to operate, and runs on virtually any personal computer.

• UPI's expanded broadcast wire offerings, which can be delivered by satellite or fax, include more world headlines, business news, sports packages and features. UPI's Global News Network (RW, March 9, 1994) utilizes six satellites to move news rapidly to points all over the world. "A given piece of data can be received just as fast in Los Angeles, London, Tokyo or wherever," said



Howard Dicus, UPI's general manager for broadcast services.

• ABC NewsWire, a joint venture with Reuters and Gannett, offers stations a variety of information including 24-hour bulletins and breaking news, hourly national and international news summaries, sports and other features. According to Jim Farley, general manager of news programming for ABC News, ABC NewsWire is for a variety of station types, such as those that do not do a lot of news, like music stations, stations that

WESTWOOD ONE COMPANIES

only provide news in the morning, and news-intensive stations.

ABC NewsWire is a component of ABC Data, a satellite-delivered hard-copy communications system, which offers a variety of services, including the USA Today Radio morning show prep service, sent before the newspaper hits the streets and including up to 40 stories from the upcoming day's paper, the previous day's sports scores and more.

• Ready-to-read national and international newscasts, weather, business news, sports scores and features are among the bill of fare at StandardNews's ZapNews (Standard didn't have a wire operation before it bought ZapNews last fall.) Information is delivered either by high-speed satellite, via Reuters' Gateway distribution system, or by fax.

• As part of its two-year-old, 24-hour broadcast wire service, Reuters provides radio stations with news headlines and a summary package each hour during the day, along with business news, sports and entertainment information. Steve Ginsburg, editor in charge of Reuters' broadcast desk, says that, although the service does offer full stories, it concentrates on capsulized stories because "stations get reams and reams of copy that sometimes cannot all be used."

• CBS's radio division and Westwood One offer different types of hard copy services. CBS's radio division offers affiliates CBS InfoLink, which includes summaries of 19 hourly newsfeeds each day, headline advisories, changes in network programming and exclusive advance previews of interviews and stories from Time Inc. publications, among other components.

Westwood One offers NETWRITER, a 24-hour-a-day service which sends stations billboards of scheduled feeds, information about bulletins and special reports, and other operational informa-

tion. NETWRITER "facilitates (stations') use of the network," said Bart Tessler, vice president of news for Westwood One.

Cost varies

The cost of subscribing to a hard copy service depends on a station's market size and the number of components of each service and type of delivery chosen. The cost could run from a couple of hun-

dred to a couple of thousand dollars a month.

For example, a station in an unranked market, subscribing to AP Drive-Time, could spend as little as \$250 a month. Conversely, a major market station, such as one in New York City, could spend as much as \$1,200-\$1,300 a month for the same service. Stations could lease AP's software package for about \$70 a month for the basic level of service, or use another software package, such as those from BASYS or NewStar. For stations unable to accept satellite delivery, AP service could be delivered over telephone lines at varying costs.

In the case of AP, the cost of the necessary satellite dish and receiver is factored into the charges a station would incur. In the case of UPI, setup of a satellite dish and receiver in the top nine markets would run anywhere from \$3,000-\$3,500, depending on zoning ordinances and skyscraper interference. In other markets, the cost would be around \$2,500.

Stations subscribing to ZapNews's fax service might spend about \$40 per item faxed, or as little as \$150 a month for a package. In the case of hard copy services like CBS's InfoLink and Westwood One's NETWRITER, affiliate stations would pay a nominal charge (in the low hundreds of dollars) for a necessary "black box," but would not incur any additional costs for using the services.

Another cost for stations to consider is a newsroom automation system, such as BASYS or Dynatech NewStar. Stations could use their existing PCs and purchase only the necessary software for between \$10,000 and \$20,000, or they could purchase an integrated system, consisting of three-to-five workstations, servers and software, for between \$15,000 and \$30,000.

Whatever the cost, hard copy services are key components of a radio station's news service. For Chris Berry, news director of Chicago's all-news WBBM(AM), "wire services are vital. They're critical to the operation of an all-news station in particular, and probably any news operation."

Trends

In addition to fashioning timely information that helps keep news departments visible and competitive, providers are keeping a close eye on trends that affect both them and their customers.

For example, Larry Cooper, vice president of CBS News, looks toward the delivery to PCs of both audio and text information. CBS's PACE, or Personal Audio Computer Editor (designed and manufactured by Corporate Computer Systems in conjunction with CBS), currently undergoing beta testing at CBS News's Washington, D.C., bureau, will eventually offer both text and audio versions of stories, in addition to the cues, IDs and other text notes it offers now.

Stations are also keeping a watchful eye on hard copy service trends. WTOP's Brown believes the trend is toward technical advances, "especially as the world (and our industry) becomes more computer oriented." And WBBM's Berry

suggests that "as more information becomes available, it's going to become more difficult to sift through the reams of data that are available to determine what actually gets on the air. It's going to require the editors to have a more critical eye."



Radio's Country Stars

► continued from page 9

the airwaves, though her well-tread histrionics at times border on gimmickry.

Trisha Yearwood - Loaded with poise and one of the most regal vocal styles within the field, though the 1993 publication of a biography that recorded a year in the life of a star was a curious, self-indulgent career twist for an artist who is hardly at the head of the class yet.

Faith Hill - Country's brightest new female presence. With a video-friendly persona; peppy, hook-laden songs; and a voice that critics freely compare to Reba, there's little reason not to have Faith.

Lorrie Morgan - Even though she has been a member of the Grand Ole Opry for more than two decades, it wasn't until the late 1980s that Morgan became a fixture on country radio. Confident, mature and a husky voice that stands apart from her female counterparts.

Kathy Mattea - With 18 hits under her belt, including "18 Wheels and a Dozen Roses" and "Where've You Been," Mattea is the voice behind some of country's classic modern songs. One of country's premiere storytellers.

Deborah Allen - Ever since she recorded an ill-fated pop album with Prince's help in 1986, country radio has been reluctant to embrace this singer/songwriter (OK, the album was awful). Her 1993 comeback, "Delta Dreamland," demonstrated in perfect form Allen's soaring soprano and instinct as a songwriter. It should have been a staple on the country airwaves.

Patsy Cline - Her death more than 30 years ago seems irrelevant to the continuing popularity of one of the most vulnerable and intense voices to ever pull up to the mic. Cline packs more hurt in one song than Susan Lucci has in 15 years on "All My Children." Her "Greatest Hits" has spent 127 weeks at No. 1 on Billboard's Country Catalog chart. As essential a part of country music as George Jones.

Runners Up: Tanya Tucker, Pam Tillis, Carlene Carter, Suzy Bogguss, Shelby Lynn.

Every FIFTEEN SECONDS
WE'RE HEARD
AROUND THE WORLD!
ID'S, SWEEPERS & PROMOS
J.R. Nelson PRODUCTIONS
PHONE/FAX for DEMO & RATES
(803) 268-6521

MANAGER'S NOTEBOOK

Execute Flawless Performance Evaluations

by Sue Jones

BURKE, Va. Performance evaluations can be the most dreaded task in the working environment. The problem lies in that they have often been poorly done or misused to manipulate people. Used correctly, they are one of management's best tools for assessing achievements and rewarding those responsible for your station's success.

Evaluations offer a way to systematically and fairly measure above average performance or extra effort. Exceptional service and contributions should be recognized and rewarded.

Assuming procedures are in place to support the evaluation process, let's take a look at the mechanics of completing the performance evaluation meeting.

DOs

Remember to evaluate for the full evaluation period. (A fair period is usually one year.) It is easy to remember the last few weeks. To avoid short-term vision, maintain a personnel file during the evaluation period. During the year, take examples of good work (a memo, note about a special project, favorable comments from a listener or client, etc.), date them, and put them in the folder.

Follow the same procedure with below average work. At the end of the evaluation period, you will have several examples of work and will not have to rely on recent memory. This file will provide invaluable support for your ratings.

Evaluate accurately and fairly. Use the same evaluation criteria for all staff members as much as possible. Eliminate personal feelings or friendships from the evaluation process. You may like the personality of one staff member compared with another. However, evaluation of his or her ability to perform the job compared with accountabilities should be the key focus.

Substandard and poor performance must be addressed. Poor performance will not be improved if it is ignored.

Be prepared to justify every rating, high or low. Have examples in mind or available at the time of the evaluation discussion.

Don'ts

Emotions must not be allowed to undermine the review process. Make sure accurate ratings are given even though the employee will not like it. If low ratings can be substantiated with examples of poor work, do not give a higher rating just to avoid uncomfortable feelings.

Time constraints should not be a factor in the process. Rushing through the process may help get through it faster, but an opportunity will be lost to give positive feedback that could motivate the staff member to grow professionally and make more significant contributions.

Plan the evaluation well in advance of the annual review date and/or merit increase due date. No one likes getting an annual pay increase three months after the due date, especially because of procrastination or poor time management.

Steps

Employee Self Evaluation. Give the employee a copy of his or her job description and a self evaluation form at

least one week prior to the evaluation meeting. Ask the staff member to complete a self evaluation using the form and ask him or her to bring it to the meeting.

Set a mutually agreeable date and time for the evaluation meeting. Plan to spend one hour for the meeting. If that seems too long, consider that you are providing feedback on a year's work and planning for the year to come for professional growth. You only have a meeting like this once a year with each subordinate staff member. If you were the one receiving the evaluation, you would appreciate

your boss taking time to consider your contributions to the station by spending an hour on the subject once a year.

Complete the management version of the evaluation form. Objectivity is critical. Include as many examples of the person's work to help assess the contributions and growth areas.

Meet in a private place that is enclosed so the conversation cannot be overheard. Ask other staff members not to disturb you during the meeting. Attach a note on the door. Ask your secretary or staff to take telephone messages or put your

phone on voice mail.

Exchange completed evaluation forms and allow time to read each other's comments and ratings. If you choose not to have staff members complete self evaluation forms, give him or her a copy of your completed form and allow a few minutes for the staff member to review it.

Go over each item and explain how the rating was derived. Cite as many examples of the staff member's work as possible. Have specific examples of work for each accountable item to justify

continued on page 19 ►

EVOLUTION OF DESIGN

"The Best Is Now Even Better"

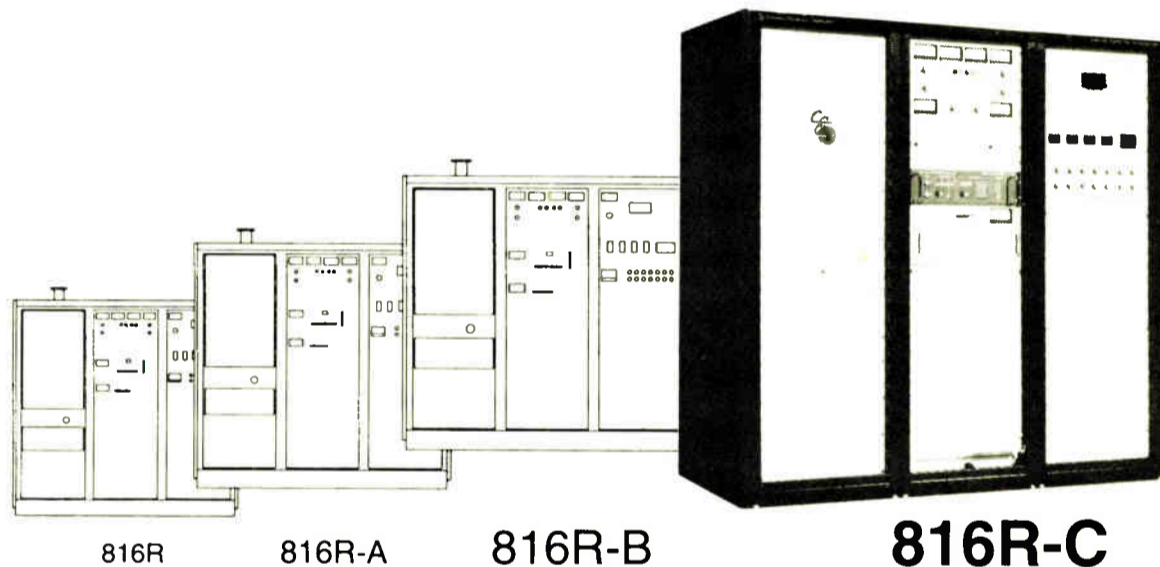

New Continental 816R-C Series FM Transmitters 21.5kW 25kW 27.5kW 30kW 35kW

They may look alike . . .but each generation 816R is a landmark design enhancement. We keep those qualities that make this the World's most reliable, high performance transmitter. We make changes only where new technology improves the performance and dependability of the 816R.

WHAT'S THE SAME:

- Self Neutralized 1/4 Wave Cavity
- Exclusive Solid-State Softstart™
- Self-Contained* in Single Cabinet
- Built-in Filament Voltage Regulator
- No External Harmonic Filter
- Positive Air Pressure Cabinet
- Continental's Two Year Warranty

*Separate HV Power Supply in 35kW

WHAT'S NEW:

- New Digital Synthesized 802B Exciter
- Solid State IPA In Roll Out Drawer
- All PC Cards Now in Front Panel
- Complete Power Supply Access
- Improved Metering Positions
- Designed for Ease of Maintenance
- New Continental Colors



Continental Electronics Corporation

P. O. BOX 270879 DALLAS, TEXAS 75227-0879 214-381-7161 TELEX: 73-398 FAX: 214-381-4949

STATION SERVICES

News and Services for Business, Programming and Sales

Radio Concepts Generates Cash Flow

ST. CLOUD, Minn. Radio Concepts offers retail clients jingles with a "major market" sound, but a "small market" price tag (\$799-\$1500). It also offers monthly event and holiday-driven packages geared to add 3K-50K in billing (\$99-\$299).

Radio Concepts is introducing a shop local campaign featuring Mayberry's own Don Knotts in "No Place Like Home." This campaign is designed to increase monthly billing from now until Dec. 31.

The company also offers the In-Market Retail Jingle program.

For information, contact John Day at 800-950-5787; or circle **Reader Service 26**.

A New Look at TV Marketing

PEARL RIVER, N.Y. Effective Media Services has developed techniques and planning tools designed to determine a radio station's optimal target audience as it relates to hard core listeners.

By combining lifestyle cluster targeting with the principles of effective frequency, the company can produce TV schedules that reach your listeners and prospective listeners with heavy frequency schedules designed to create top-of-mind awareness necessary to convert phantom come into diary respondents.

For information, contact Ed Marshak at

Effective Media Services at 914-735-3200; or circle **Reader Service 195**.

Independent Broadcasters Network Celebrates Third Year

CLEARWATER, Fla. The Independent Broadcasters Network (IBN) is a 24-hour, interactive talk radio network. Launched in August 1991, IBN began as a cooperative venture designed to bring broadcasters together in a group effort.

IBN currently has 35 program hosts on the air, with most having more than 10 years broadcasting experience. IBN is available on Satcom C-5, Satcom C-1 and Galaxy 2.

IBN offers fully automated, hassle-free program services with full audio content.

For information contact IBN at 813-573-4402; or circle **Reader Service 133**.

New Jason Jennings Sales Program

SAN FRANCISCO There is a new sales training program available, created and hosted by Jason Jennings, renowned sales instructor. The program, Series 2000, consists of 15 video modules with workbooks for account executives and management. The series is a successor to Jennings' system of seven years ago which was used by more than 2500 stations in the U.S. and

Canada and several foreign countries.

Series 2000 offerings range from the basics for entry-level sales people to sophisticated instructions on non-traditional sources of revenue for experienced account executives.

A free highlight videotape and contents information is available from Media Directives Inc.

For information, contact Harvey Borlaug at 800-209-0003; or circle **Reader Service 123**.

Prime Sports Radio to Launch in Summer

DALLAS Prime Sports Radio, a 24-hour radio network devoted to national sports information, via satellite, set to premiere later this year. The program line-up will include continuous updates, in-depth analyses, play-by-play actualities, and interviews with famous personalities. An established network of stringers will provide live, on-the-spot coverage of major sporting events.

Prime Sports Radio is available on a barter basis.

The parent company, Liberty Sports, provides extensive developed resources Prime Network interest, a national sports cable television network which distributes programming of special interest to regional sports networks throughout the U.S.

For information, contact Christal Aycock at 214-401-0099; or circle **Reader Service 79**.

Woodstock Reunion

NEWBURGH, N.Y. The biggest 25th reunion of them all, Woodstock II and Bethel '94 Concert Festivals on August 13 and 14, respectively, will take place in the New York towns of Saugerties and Bethel.

Fine Art Productions can provide you with on-the-spot, on-the-site news data,

fax, surface mail information, interviews, traffic and weather reports, satellite feeds, etc.

For information, contact Richie Suraci at 914-561-5866; or circle **Reader Service 75**.

Low-Cost Jingles for Good Times/Oldies Stations

TOLEDO, Ohio Ken R. Inc. has just completed a new jingle package designed for stations running the satellite fed "Good Times/Great Oldies" format.

These musical IDs fit the available windows perfectly and offer a means of station identification with more impact than announcer liners.

All jingles are completely customized for your station and are available at a special low price if purchased before June 30, 1994.

For a free demo tape or information, contact Heather at 800-451-KENR (5367); or circle **Reader Service 60**.

Music Bakery Releases Sixteenth CD

DALLAS The Music Bakery just released its sixteenth standard audio CD (also playable on CD-ROM). The Music Bakery serves up music of the highest professional quality, and features live instruments, real musicians and award-winning compositions for video productions and A/V multimedia presentations. Subscribers receive a new CD every month for the one-time buy-out price of \$48 each.

Each CD contains a wide variety of musical styles in full-lengths (approximately four minutes per), 60-second versions, 30-second versions and tags. Sixteen CDs are currently available.

For information, contact Jack Waldenmaier at 800-229-0313; or circle **Reader Service 114**.

STATION SERVICES

Buy - Out Music

22 Compact Discs of Great Music & Sound Effects For Unlimited Use:

\$995.⁰⁰

1,183 Diverse Cuts!
Over 20 Hours of Music & F/X!

Energetic Music Free Catalog

1-800-323-2972

READER SERVICE 134

427 SOUND EFFECTS \$89.00

For a 5-CD set with a 30-day money-back guarantee.

Take an extra \$10 off if you mention this ad!

Send \$79 to Ghostwriters
2412 Unity Ave. N., Dept. RW
Minneapolis, MN 55422

For credit card orders call
(612) 522-6256

READER SERVICE 11

CUSTOMIZED AIRCHECKS ARE HERE!

Broadcast Historian Ed Brouder offers customized airchecks of Top 40 legends • Over 2,700 airchecks available • Use our catalogue to build your own collection • Perfect for Oldies Programmers, Collectors, Jocks. We have them all!

Send \$10 for our catalogue, \$5 for cassette.

MAN FROM MARS PRODUCTIONS
159 Orange Street
Manchester, New Hampshire 03104

READER SERVICE 28

Station Services is a great, economical way to get your company's message to Radio Station and Recording Studio owners/managers and engineers. Call Simone now and your ad could be in the next issue of Radio World.

ATTENTION PROVIDERS!

Promote your services to **Radio World's** 22,000+ readers. Reach Radio Station and Recording Studio owners/managers and engineers with your message. For information on affordable advertising call **Simone** at **1-800-336-3045**.

ATTENTION P.D.s

Schedule the best in "OLD-TIME RADIO" with

When Radio Was...

Hosted by ART FLEMING, original star of "JEOPARDY"

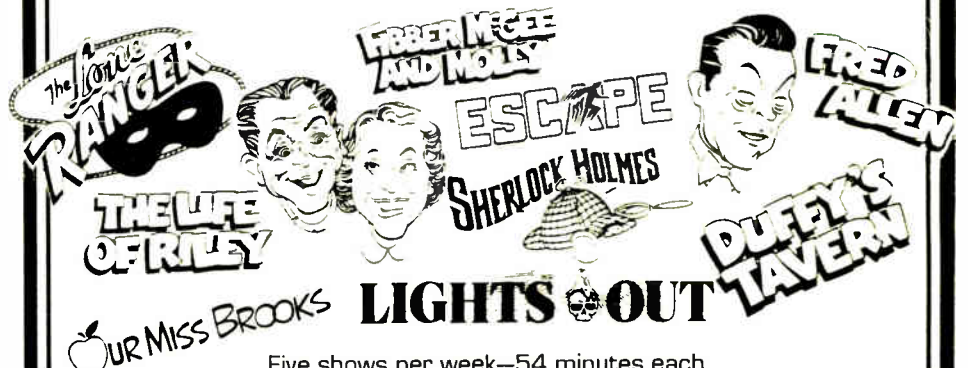

Five shows per week—54 minutes each.

BARTER, NO CASH PAYMENTS!

Delivered via Satellite (SATCOM).

For more information contact David West at

DICK BRESCIA ASSOCIATES (201) 385-6566

When Radio Was celebrates its 4th year on 100 stations.

THE CART MACHINE GOES DIGITAL! INTRODUCING THE DENON MD CART.

As the company that first employed digital technology to record music, it's not surprising that Denon has become the broadcast standard for on-air CD playback with its CD Cart™ Players. Now, Denon is about to repeat its ground-breaking tradition with the introduction of Denon MD Cart™ Recorders and Players.

Based upon digitally recorded, removeable MD technology, Denon has created the DN-990R MD Cart Recorder and DN-980F MD Cart Player... and in the process has effectively replaced the 25 year-old NAB Cart.

Erase and re-record for commercial/spot production and playback using widely available blank MDs. Record and re-record with CD-like sound quality, durability and reliability.

Audition Denon MD Cart machines today. And remember, whenever digital broadcast equipment is made better, it will be made by Denon.



DENON
The First Name in Digital Audio

Premiere Radio Airs Seamless Sound

by Pamela Watkins

LOS ANGELES. The sound is CD pure. The daX unit computer is DOS-based—an IBM PC. The program is delivered through the Ku-band satellite dish via SatCom K-1 Transponder No. 1, using the MUSICAM digital audio compression algorithm at 128 kilobits per second (kbps).

The transmission is digital. No distortions, no rain fades, no analog satellite problems and no stepping on the network—it is seamless radio.

Something new in radio

Two years ago, Premiere Radio Networks' Tim Kelly shepherded a unique network radio system which promises to make the annals of network and local radio. Kelly spent 20 years in a radio booth, worrying about hitting the network, stepping on the network and filling until the network was on line. As one of Premiere's partners, Kelly sought to change radio as we know it with newly available technology.

Premiere Radio entered the network field by supplying radio stations with three- to five-minute comedy shows. Premiere was a programming-oriented company, so when they decided to expand into network radio during morning drive-time they looked at the programming side. The popular country

genre, Premiere's acquisition of "Big Dog" 92.5 KZDG(FM) in Denver, and Gerry House and the House Foundation were selected as the testers for Premiere's new delivery system.

How could the network supply a show that sounded local, sounded smooth, made people laugh plus incorporated all the local elements, such as sports, weather and traffic? "With all those elements in mind," Kelly said, "the challenge was to make a network radio show that was coming out of Nashville, Tenn., sound like it was actually being done specifically and especially for each individual affiliate market, whether the market was Denver or San Francisco.

"It had to sound like Gerry House and the House Foundation was morning radio for that country station in that market even though the show was broadcast out of Nashville."

Rewriting the rules

In order to accomplish this challenge, Kelly realized it had to rewrite the playbook for network radio. Current network radio could not do the job, but cutting edge technology could. Kelly knew all the technology necessary was available—it was just all over the place, not designed in one package.

PREMIERE
RADIO NETWORKS
NEW YORK • LOS ANGELES • CHICAGO

Premiere implemented California Digital's new technologies, which were available in various forms but never all put together in one package to "create synergistic network radio programming." Working closely with California Digital in Los Angeles, outlining the problems of analog the company wanted to eliminate, and how it wanted the House Foundation to sound warm, local and to be user friendly, the end result for Premiere was a customized daX unit (Digital Audio Fax Unit), called "the Box" by Premiere.

Here's how it works as explained by Kelly: "The daX unit allows us to record the Gerry House and the House Foundation show in a segmented way onto a hard drive with what is called a two-minute flex window which gives the local operator the ability to access whatever segment of the show is coming up next—up to two minutes before or two minutes after where they would normally have to hit the network window. That allows the station to have seamless network productions."

The computer also enables the House Foundation to give local time at the exact time whenever the local station calls for it because the time checks are saved to an internal clock in the computer. Gerry puts the time checks on the hard drive and the local station uses the appropriate style for that particular programming need. In addition, Gerry pre-records the local station's call letters and promos, which are also stored on the hard drive.

Local and live

Kelly stated, "At any given time in any given segment, the listener is getting local station call letters and identifiers, the accurate time, Gerry live from Nashville, and being funny with his crew and interviewing famous people; and then verbally handing it off to the local host who intakes it from Gerry. The show goes back to

Nashville whenever the local host is ready and without being concerned about hitting any kind of network window, or being early or late."

With this unique system the local stations have plenty of time which creates that smooth seamless flowing transition from local to network to local. And local sounds like Nashville. "That's the difference with this network," said Kelly.

As innovative as this technology seems, it is in the embryonic stage. Premiere Radio Networks tested the product with Denver and has signed on an additional 35 stations. Kelly sees nothing but growth in Gerry House's future. However, the first few years he acknowledges the House Foundation will lose money.

Long-term outlook

At present, Premiere charges a fee of \$150 to \$250 on the low end to \$450 to \$500 per month on the high end as the monthly cash payment for the Gerry House program. Premiere also takes 40 minutes per week for its network commercials. "We're in this for the long haul," stressed Kelly. "We're getting people to try something completely new, believing that a network morning show is a viable alternative to the local live morning show. We expect to have 200-plus affiliates after three years, but we're losing money for the first couple of years."

The affiliates get the equipment free shipped from Premiere's Sherman Oaks offices after the equipment has been tested and the call letters, time checks by Gerry House have been loaded. But that's not all. Premiere's director of engineering, Barry Victor, supervises the equipment installation for each affiliate.

Kelly remembers his days as an anchor and "the network window" monster and is thrilled with the outcome of his project. However, he is quick to acknowledge the "blood and sweat" of Barry Victor and California Digital's design team Linda Donohue and Karen Beamer.

"I'm excited for radio," Kelly said, "because it really heralds the dawning of a new day for network and local radio interacting in a way which never really existed before." Seamless radio really exists.

ABG announces the first of its kind — 1994 Digital Products Guide

PLEASE CALL
TODAY FOR YOUR
COMPLIMENTARY
COPY OF THE
DIGITAL PRODUCTS
GUIDE FROM ABG.
YOUR SINGLE
SOURCE SUPPLIER
OF EVERYTHING
DIGITAL AND BEYOND!

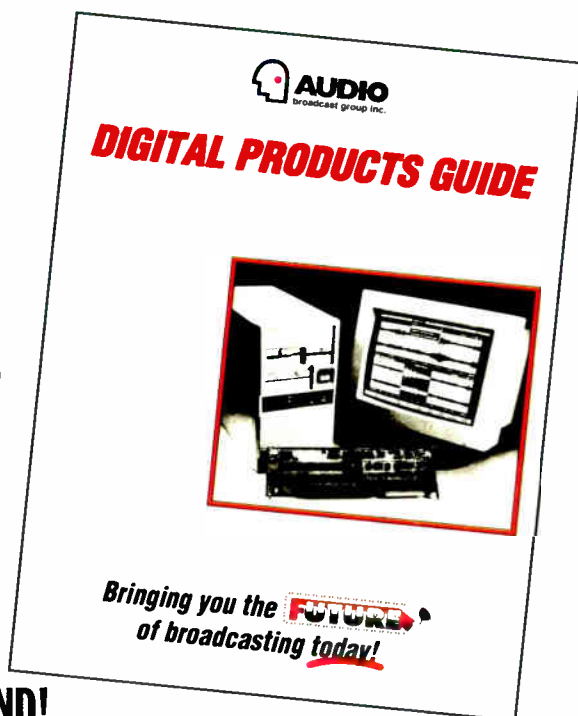

AUDIO
broadcast group inc.

MAIN SALES OFFICE
2342 S. Division Avenue
Grand Rapids, Michigan 49507-3051
PHONE: 800-999-9281
FAX: 616-452-1652
Dave Howland - Sales Mgr.
Jack Connors - Sales Engineer
Jerry Bufka - Customer Svc.

SOUTHEASTERN SALES OFFICE
200 Fareway Drive, Suite 2
Smithfield, North Carolina 27577
PHONE: 800-369-7623
FAX: 919-934-8120
Cindy Edwards - Sales Mgr.

WESTERN SALES OFFICE
P.O. Box 1638
Palmdale, California 93550
PHONE: 800-858-9008
FAX: 805-273-3321
Tony Mezey - Sales Mgr.

Circle (135) On Reader Service Card

ITC
FOR 25 YEARS I.T.C. HAS BROUGHT
STANDARD-SETTING PRODUCTS TO RADIO.
NOW
DigiCenter
ITC'S DIGITAL AUDIO SYSTEM
BEGINS THE NEXT 25!

- All the benefits of a complete audio management and delivery system.
- All the proven value and dependability of an ITC product.
- All the advantages of digital technology.

That's DigiCenter... another advancement in broadcasting that will expand your capabilities in programming, management and delivery of pure digital sound.

Find out how DigiCenter improves audio quality, personnel performance and station profitability. Call us and begin your future today.

1-800-447-0414
BROADCASTING AUDIO
For the NEXT 25 years

THE BENCHMARK IN
For the past 25 years

ITC Corporation • 2425 South Main Street • Bloomington, IL 61702 U.S.A. • (309) 828-1381 FAX: (309) 828-1386

Circle (182) On Reader Service Card

PROMO POWER

Setting an Effective Promotional Agenda

by Mark Lapidus

WASHINGTON What has at least four heads, takes two hours and sets the agenda for your radio station? Your promotion meeting. Most are attended by the department heads—general manager, promotion director, program director and general sales manager. Many take longer than they should. All set the promotional wheels in motion.

Like any good meeting, your promotion meeting requires a well-organized agenda. This agenda can be put on paper and handed out at the start of the meeting, or you may just write it down on the blackboard.

Think of the people attending your meeting and how each subject relates to their departments. Avoid topics that aren't pertinent to most of the group. You can always break into smaller groups later. It's an interesting exercise to add up the salaries of those in attendance in your meeting. Are you being cost effective with your staff's time?

Dissect the agenda

Let's dissect the promotion agenda: Begin by covering old business. Discuss recent promotions by briefly going over each appearance and major on-air activity the station has done since the last meeting. Evaluate the effectiveness of appearances based on crowd size/reaction and client feelings/retail sales. It's much more difficult to quantify on-air activities, yet if you don't get feedback from each department head, you won't know whether it's worth repeating this effort.

Next, pull out the calendar for the coming month and run through each activity to get everybody up to speed. This is something you do not want to spend too much time discussing. The concept is to make sure that everyone understands his or her responsibilities.

The "possibilities" part of your meeting follows. Spend this time laying out ideas the staff is generating. Those are basically the ideas which start with: "I think it would be great if we could..." This is also a good place to pile on the pitches you've received from non-profit groups for races, marathons, bike rallies and the like. You should act as a gatekeeper, making sure to eliminate activities that will not benefit the station.

If you're a general sales manager, you're probably wondering when in the world we're going to get around to sales promotions. This is the most challenging part of the meeting. If your promotion meeting is spending more than half the time talking about sales promotions, what you really need is a separate sales promotion meeting. This is not a bad thing...this is a good thing! It means that there's a considerable amount of your station's revenue that's being generated by sales promotions.

Call a spade a spade

A smart promotion director will call a meeting what it really is, and if most of what you talk about is sales promotions, then you need two meetings. If it's easier, first have a sales promotion meeting and then a programming promotions meeting. It's during this time that salespeople come in one at a time to discuss their needs. Each salesperson should have first cleared

these topics with the general sales manager. The GSM will filter out those clients with no money or horrible concepts.

The main focus of your sales promotion meeting should be brainstorming ideas to get the buys. Begin with the goal of the client. Is it to drive traffic to retail locations? Is it just to get the name of the product on-air? Is it for sampling opportunities? Most of the time the client will have a goal that can be ferreted out by a good salesperson.

If the client just says "I don't know what I want...I just wanted a promotion," it's still

very important to ask probing questions. Find out what they've done in the past that they liked. The salesperson needs to play detective and get clues. Once the goal is established, lay out the time frame and amount of money on the table. Larger guys mean larger promotions.

In brainstorming there are no chiefs, no idea is a bad idea and everybody has to participate. The best way to kill creativity is to tell someone that something won't work. Sometimes the dumbest ideas after they've been worked over are the ones that become part of radio history. Write

everything down on a blackboard. The salesperson should not leave the room with less than three new ideas for their client. They should also be clear about how many promotional mentions are included and how much of a buy they need to receive in return.

Three is the minimum

Any sales promotion you devise has to be a winner for the client, the station and your listener. If there's no listener benefit, it will probably not be successful for

continued on page 19 ►

**YOU CAN SHARE PROGRAMMING
AMONG YOUR RADIO STATIONS ...
At a Lower Cost Than Ever Before!**

Share programming among your station group or with other stations by sharing day parts, entire formats or by delivering your top-rated talent to other markets coast to coast. You can spread overhead costs, increase the quality of programming at the local station and build your audience by creating a satellite radio network. And now new digital satellite technology makes radio networking more affordable than ever before. Let us offer you a complete solution for your radio networking needs.
Call us at (202) 414-2626

NPR SATELLITE SERVICES®
Has moved to:
635 Massachusetts Ave., NW, Washington, DC 20001-3753
(202) 414-2626

A 60 Second Look at the Last 25 Years in Commercial Radio.

The DSE 7000.

*The fastest
digital
workstation
for radio
production.*

Simplest to use.

*And still the
best way to get
sixty seconds
of history
on the air.*

Orban.

Celebrating

25 years

in broadcast.

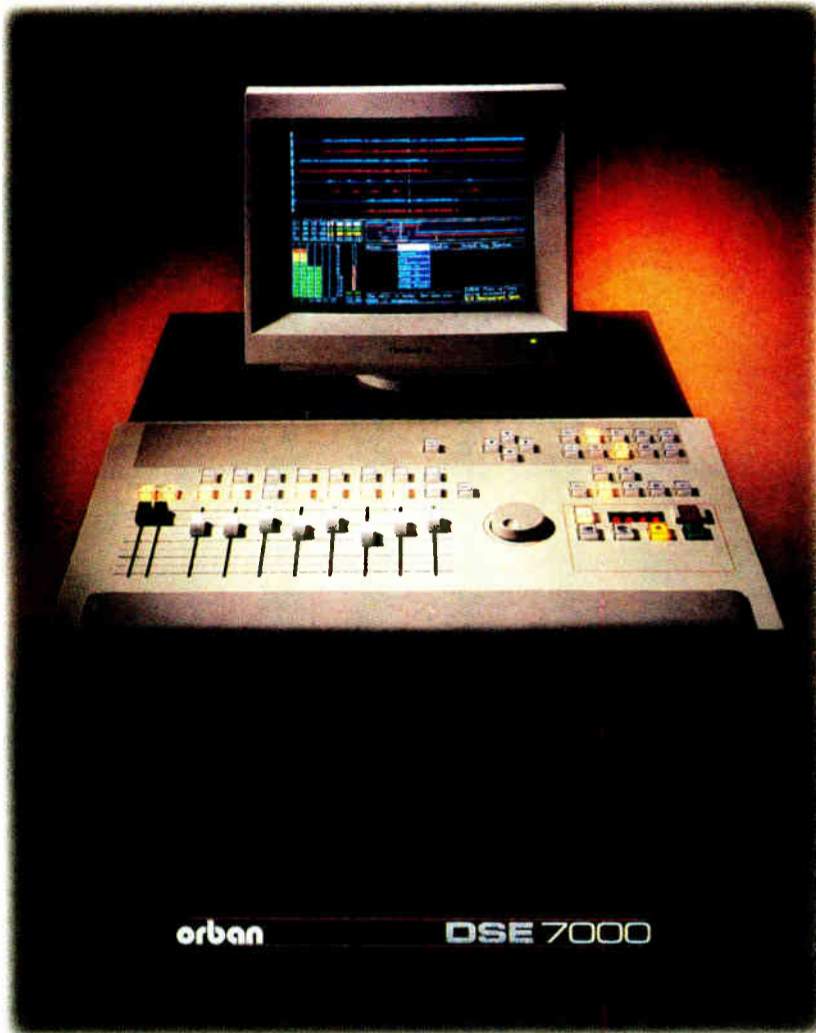

*The Eagle has landed...New York
State Thruway is closed, man...And
Pepsi's got a lot to give...Wake Up,
Maggie, I think I've got something to
say to you...Peace is at hand...Bye, Bye,
Miss American Pie...I am not a crook...
I shot the sheriff...Plop Plop, Fizz Fizz...
Tramps like us, baby we were born to...
Hi, I'm Jimmy Carter...Ah, Ah, Ah, Ah
Stayin' Alive, Stayin' Alive...No
Nukes...Are you better off than you
were four years ago?...Have a Coke
and a smile...She's got, Bette Davis
eyes...Where's the beef?...Beat it!...Beat
it!...Four more years...What's love got to
do with it?...Gorby! Gorby!...We are the
world, we are...The ultimate driving
machine...The Dow fell over 500 points
today...I'm Tom Bodette for Motel
Six...we'll leave the light on for ya...
That's "potatoe" with an "E"...You got
the right one baby, Uh Huh!*

There is just no faster way to slice through 25 years of radio, or your next sixty seconds, than the DSE 7000. *The New Speed Of Sound.*

orban[®]

H A Harman International Company

© 1994 AKG Acoustics, Inc. Orban and OPTIMOD are registered trademarks of AKG Acoustics, Inc.
All other trademarks are property of their respective companies. 1525 Alvarado St., San Leandro, CA 94577 USA Phone 1•510•351•3500 Fax 1•510•351•0500.

Circle (119) On Reader Service Card

Flawless Performance Evaluations

► continued from page 13
the evaluation.

An overall rating should be given. Explain how it was calculated. Were total points, weighted points, or average points used?

Discuss the employee's overall strengths and how he or she has contributed to the station's success.

Honest assessment

We all like to think we are performing our jobs perfectly. However, most of us have areas where we could improve our performance. Most of us know our weak points. So the staff member should not be surprised when areas that need to be strengthened are identified. How this part of the discussion is handled will determine if real progress will be made in improving performance. Explain the problem and suggest ways that problem

Promotional Agendas

► continued from page 17

the client either. For example, 5 percent off lunch is not a great listener benefit and will not help a restaurant client get bodies in the building. On the other hand, buy one lunch get a second free is a decent incentive. In addition, determine whether or not you can do the promotion in the client's own spots rather than occupying promotional inventory.

Carefully consider the time and placement of your meetings. People are at their freshest early in the morning. Start a little before the regular business day. If your office opens at 9 a.m., begin at 8:30 or 8:45 a.m. Once the switchboard opens, you're in trouble because someone is going to get a call just as they're supposed to begin with you. Early in the week works best so that everyone has time for action.

Finally, a word about the leader of the meeting. This person should be the promotion director or, lacking a person with this position at your station, the program director. It's the leader's job to develop the agenda, start the meeting on time, referee debate and encourage participation. Even though there may be several people higher up the organizational chart, it's vital that all lend full support to the leader. When the general manager shows up 10 minutes late to the meeting and interrupts the agenda regularly, it sends the wrong message to the rest of the participants.

Gotta go...another promotion meeting is gearing up down the hall.

□ □ □

Mark Lapidus is director of marketing for Liberty Broadcasting. Liberty owns WXTR(FM) and WHFS(FM) in the Washington market; WGBB(AM)-WBAB(FM) on Long Island, N.Y., and WMXB(FM) Richmond, Va. Mark can be reached at 301-899-3014; or write him care of RW.

could have been prevented or corrected.

Talk with the employee about career growth and career path. What position would that staff member like to hold two, three or five years from now? How can you and the station support those goals?

If a performance area is very weak, set up specific, attainable and measurable steps that the employee must take to correct the problem within a specific time period. Set up regular check points every two or four weeks to look at the problem and, hopefully, evaluate the improvement. If the employee's performance is improving, make sure to tell the staff member the improvements have been noticed.

Solicit input

Most performance evaluation forms have a section for employment comments. Your staff member may not want to add any comments. That is okay. However, this is an excellent opportunity to solicit ideas and feedback from the staff on ways to improve the station's operation and policies.

By asking an employee for his or her ideas, you convey the message that the station values his thoughts and

input. The employee may not give a response or new ideas during the performance evaluation meeting. Let him or her know that you are willing to discuss an idea at any time.

Both of you should sign the evaluation form. The original form should go into the employee's formal personnel file. The employee should receive a copy for his or her records.

Most performance evaluations are linked to merit pay increases. If your station's policy is to conduct performance appraisals and salary merit increases at the same time, you should be prepared to discuss a pay increase. The station's employee handbook should explain how merit increases are determined. In addition, be ready to explain any budget policies and annual merit increase pools that may govern the amount of merit increases that can be awarded. Be prepared to discuss the dollar amount, percentage and effective date of pay increases.

Following these steps will not guarantee effortless performance evaluations. Moreover, these steps will help assure fair, accurate and consistent assessments of performance.

□ □ □

Sue Jones is a Senior Manager Computer Data Systems, Inc. in Rockville, MD. She can be reached at 703-323-0491.

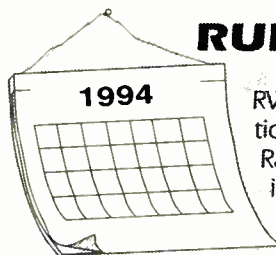

RUNNING RADIO CALENDAR

RW's Running Radio is designed to meet the information needs of radio station owners and general managers. Published in every other issue, Running Radio provides a unique forum for discussion of issue and techniques of importance to successfully running a radio station.

The publication schedule for the rest of 1994 includes:

- **June 1** — Station promotions and event marketing: How your station can create and execute a successful event.
- **June 29** — Delivery systems: What are the audio delivery systems out there and which one is right for you?
- **July 27** — Program syndication: From urban to country to talk, the programming available (be it long-form, specials or shorties) and how (barter/cash).
- **August 24** — Format trends: Programming consultants analyze trends in the business.
- **September 21** — Station trading: What is happening to the value of your station? Are stations holding their own? Brokers tell it like it is.
- **October 19** — Incentive selling and merchandising: Add that extra motivation with the latest in merchandising concepts and how to use them effectively.
- **November 16** — Station operations: What innovative managers are doing to improve performance and the bottom line.
- **December 14** — Business outlook: An assessment from group owners and industry executives of the last 12 months and their expectations for 1995.

CD Format Services....'90s Style!

Since 1991 we've offered music libraries & current hits on Ultrasonic-Q CD's. Our library of 6,000+ tracks has every flavor of A/C, Top-40, CHR, Country, Oldies and Classic Rock. We now have over 2000 clients worldwide!

If you deal with Broadcast Programming, TM Century or another service, call for our catalog and sample discs. See what you'll get and how little you'll pay with RPM. Complete format service starts at \$295.00 / month*. Current & Recurrent hit update service is \$16.95/week or \$49.95/month.

Program your station 90's style. Get a high quality service at a fair rate. If you don't use CD's, you're missing a chance to make a big improvement in your sound. Our personal professional service will be a real pleasure too.

50 STATES & CANADA:

800-521-2537

Top Hits U.S.A. & Ultrasonic-Q Radio Disc trademarks of Radio Programming and Management, Inc., Orchard Lake, MI. Ultrasonic-Q system is Patented.

02-THE ONES YOU LOVE (EDIT) RICK ASTLEY -(412)-405/F/10-B
 03-WITHOUT YOU - MARIAH CAREY -(325)-318/F/6 -AP
 04-THE LADY IS A TRAMP FRANK SINATRA W/ LUTHER VANDROSS -(322)-320/C/7
 10-I'M IN THE MOOD (East 87th Mix) - CECE PENITON -(400)-353/F/1 -A
 11-A DEEPER LOVE (C&C Hot Mix) - ARETHA FRANKLIN -(441)-439/C/0 -A
 12-ROCK & ROLL DREAMS COME TRUE (Radio) - MEATLOAF -(359)352/F/14-B
 13-LAY YOUR HEAD ON MY PILLOW - TONY TONI TONE -(435)-428/F/23-A
 14-MR JONES - COUNTING CROWS -(429)-427/C/5 -B
 15-DESIRE (EP VERSION) - EN VOGUE -(351)-344/F/2 -N

FORMAT - CUTS
 AC: 02 - 04
 CHR: 10 - 17
 COUNTRY: 20 - 25

ULTRASONIC-Q
RADIO DISC
 FOR BROADCAST ONLY

TOP HITS U.S.A.
 December 31, 1993
 DISC ID: T204
rpm RADIO PROGRAMMING AND MANAGEMENT, INC.
 Since 1970
 4198 Orchard Lake Road
 Orchard Lake, MI 48323
 800-521-2537 MI: 810-681-2660

16-RAINBOW MAN - GIOVANNI SALAH -(410)-403/F/40-B
 17-DIRTY DAWG - NKOTB F/ NICE AND SMOOTH -(412)-405/F/7 -B
 20-WHERE WAS I - RICKY VAN SHELTON -(306)-259/F/14-N
 21-TRYIN' TO GET OVER YOU - VINCE GILL -(343)-341/C/17-B
 22-LIFE #9 - MARTINA MC BRIDE -(359)-352/F/15-B
 23-(Who Says) YOU CANT HAVE IT ALL - ALAN JACKSON -(324)-321/C/8 -A
 24-IDA RED - ASLEEP AT THE WHEEL
 With Jody Nix-Huey Lewis-Willie Nelson-Ran Benson
 (302)-300/C/17-A
 25-ALREADY GONE - TANYA TUCKER -(415)-408/F/14-A

*Rates for markets of 50M population or less. surcharge for larger markets

Running Radio

A Supermarket of Radio Station Services

For information on the services shown below, circle the Reader Service number on the enclosed card or contact the advertiser directly.

It's A 4-Hour, Weekly
Rock-n-Roll History Lesson



Be The First In Your Market
To "Make The Grade"!

For Demo:

1-800-985-2665

Distributed by COPRA Media Productions, Inc.
4444 Westgrove Drive, Suite 210, Dallas, TX 75248

Reader Service No. 15

Affordable Radio Station Billing Software

Many Features Including:

- Daily Log with Automatic or Manual Ad Placement
- Print Customer Statements, Affidavits, Commission and Ad Agency Reports from Info in the Daily Log
- Keep Track of all Revenue and Receivables
- Dozens of Reports Including Open Ad Availabilities, Expiring Ads, Cart #, Sales Reports in various categories, Late Payments, A/R, Mailing Labels, and many more!
- Music Library with Random Playlist

Software price \$1,500

Six months free support

\$35 per month unlimited support after first six months
Our Products are Guaranteed! • Custom Design Available

Custom Professional Billing Systems

79 Moore Road, Summertown, TN 38483
(615) 321-0161 FAX: (615) 320-0847

Reader Service No. 29



OVER 70 CD'S OF PRODUCTION
MUSIC & SOUND EFFECTS

Dimension Music & Sound Effects, Inc.

P.O. Box 8495, Jupiter, Florida 33468-8495
800-634-0091 • 407-575-7004 • Fax: 407-575-3232

Reader Service No. 42

Money \$\$ Machine[®] Contest Lottery[®]

Multimedia Broadcast Promotions

"The Hottest
Money-maker
and Cume Builder"



Fardella

Engineering

Enterprises

FEE Fardella Engineering Enterprises
Custom Systems for the Broadcast Industry

(408) 229-2949 FAX 229-0432
(800) 546-0898

264 El Portal Way, San Jose, CA 95119

Reader Service No. 85

FORMAT Professional Audio Products

Item Code	Brand	Description	Price
ACD58	DENON	CD cart shells (25 units)	87.50 each
R-200M1	DENON	20 min "demo" master DAT	5.69 each
R-60D1	DENON	60 min. master DAT	5.99 each
R-90DA1	DENON	90 min. master DAT	6.99 each
R-120D1	DENON	120 min. master DAT	7.99 each
MQ-15	DIC Digital	Master Quality 15 min DAT	4.99 each
MQ-30	DIC Digital	Master Quality 30 min DAT	6.15 each
MQ-48	DIC Digital	Master Quality 48 min DAT	6.29 each
MQ-62	DIC Digital	Master Quality 62 min DAT	6.89 each
MQ-92	DIC Digital	Master Quality 92 min DAT	8.29 each
MQ-122	DIC Digital	Master Quality 122 min DAT	9.39 each
CDR 63	DIC Digital	Blank 63 min recordable CD	15.99 each
CDR 74	DIC Digital	Blank 74 min recordable CD	16.99 each
DA R16	TDK	16 min "demo" master DAT	4.99 each
DA R60	TDK	60 min master DAT	6.99 each
DA R90	TDK	90 min master DAT	7.99 each
DA R120	TDK	120 min master DAT	8.99 each
CD-W12EL	TDK	74 min recordable CD	16.99 each
CD-W12	TDK	60 min recordable CD	15.99 each
CD-W08EL	TDK	21 min (3 1/2") recordable CD	12.99 each
CD-W08	TDK	18 min (3 1/2") recordable CD	11.99 each
MD-NG60	TDK	60 min recordable Minidisc (MD)	10.49 each
MD-NG74	TDK	74 min recordable Minidisc (MD)	13.49 each

**FORMAT
PRODUCTIONS**

Broadcast Division

P.O. Box 466
Portland, Oregon 97207
Phone: 503-223-4 MAT
Fax: 503-222-6408
TollFree: 1-800-440-4 MAT

Reader Service No. 87

EVERYBODY WANTS IT!!

25-54

Imagine having your 25+ audience and expanding them to 54! It's easy with Globe Music Productions' 7-Day Lasting Music Library. EASY/AC will grab your audience with the most disposable income that your advertisers want.

Features Include:

- Delivery on 7" reel tape (no costly changes to your station)
- Music plays 7 days, 24 hours a day without repeats
- Largest library available at lowest cost
- AM's love it as much as FM's

**DON'T WAIT—
CALL NOW!**

Globe Music
Productions

Box 20465
Roanoke, VA 24018

Member of the National
Academy of Popular Music

703-344-3283

Reader Service No. 106

THE 70'S ARE HOT!

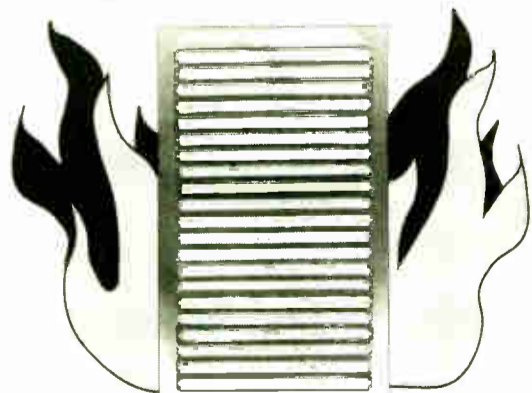

And Halland has radio's only "70's Gold" music library on CD! 545 of the best AC/CHR-Gold hits on 30 CDs. For a song list and info,

call 1-800-HALLAND today!

—Also ask about our other CD libraries—

Halland Broadcast Service

1289 East Alostia Avenue, Glendora, CA 91740
Phone: 818-963-6300 Fax: (818) 963-2070

Reader Service No. 62

Turn Sunday
INTO
Money-Day
WITH

NASCAR RACING

CALL

(904) 254-6760

**MRN
RADIO**

1801 International Speedway
Daytona Beach, FL 32114

Reader Service No. 77

**POST
MODERN
RADIO NETWORK**

- ♦ Nation's first all alternative programming
- ♦ One hour shows produced weekly by nationally known on-air personalities
- ♦ Delivered to you on CD, DAT or cassette
- ♦ Available on a Barter basis

**THE NATION'S NEW
MUSIC AUTHORITY
1-800-737-9099**

Contact:
John Soltys

Reader Service No. 64

UPLINK

Localize Your Networked Station's News

by Karl Baehr

ALBUQUERQUE, N.M. Local news offers you one of the best ways to interact with your community and is one of the easiest ways to localize a satellite format. It also can be the biggest headache for satellite station operators. Let's take a look at some ways to polish up your local news department.

Keep in mind that, no matter what the format, news and information is one of the foremost reasons people listen to the radio. Therefore, the news department is an important element of a radio station. Like other departments at the station, the news department must have a mission — a policy statement that clearly states mission and purpose.

Department with a mission

For example, your news mission might state: "When people think news and information, we want them to think K.... It is our policy to report events and information important to our community accurately, clearly and without bias with full and complete attention given to the facts of those events.

"There is a responsibility inherent to broadcast journalism, and with that responsibility in mind, it is the goal of our news department to maintain accuracy, objectivity and integrity in gathering and presenting the news in a forthright manner. It is better to be right than to be first."

Define your news organization. Many stations have a news director, though some stations still place the overall responsibility for the news department under the direction of programming.

If you do put news under the direction of programming, the right to "appeal" the PD's decisions directly to the general manager should be an option for the news director. The news director may have a different perspective on an issue and should have the opportunity to make his or her case.

Get copies of and adhere to broadcast journalism codes of ethics. Post these in a conspicuous place in the newsroom. Sounds a little Journalism 101-ish, doesn't it? Maybe so, but a good reality check is not a bad idea, as it is very easy to get wrapped up in the emotion of a story and lose sight of your real purpose as a broadcast journalist. Trust me, it happens.

Know the ramifications

Along these lines, familiarize yourself with the legal ramifications of obtaining and airing news stories. The NAB has a legal guide that is a good reference text.

Some fine journalists I know can go "get" the story but cannot write a clear, concise news story to save their lives. Get copies of the Associated Press (AP) Style Book. A great place to go for reference texts is a local university, or maybe a bookstore or library. At the library, style books will be cataloged under writing/news or reference texts/writing. Once you obtain copies, read them and make them available.

Make sure you have a good, easy way to obtain quality actualities. With all the palm-sized technology available, it is not a problem to get low-cost, hand-held stereo cassette recorders and microphones to accomplish this. An extension

microphone is necessary, even if the unit has a built-in mic. Put a mic flag that says "K... News" on it; let them know who they're talking to.

Concerning the use of actualities and their integration into newscasts, change them throughout the day. Do not play the same tired segment all day long and definitely not more than for one day! I have found that it is quite simple to have the morning news personality re-write and read the top story of the day and leave it for the afternoon newscasts. "A major shake-up at city hall this morning, K...s

News Director Joe Journalist has the story..." This keeps the news fresh, pertinent, but your audience won't be thinking, "I've already heard this," and leave.

Minimize errors

Unless it is an emergency, do not air newscasts live on a satellite station. It is really a whole lot easier if you provide the production elements and framework for the newscasts and then have them pre-produced for insertion in a specified network window. This is not only very convenient, but allows for fewer stumbles

and errors on the air.

Produce introductory themes for the various segments in the newscast and variations for newscasts, updates and special reports. There are several relatively inexpensive production libraries that have very useful beds for this purpose.

Regarding sources for news, re-evaluate a wire service. Again, there are several choices for wire services, from dedicated types to fax and modem types. They run the full range of cost and are useful, depending on your operation, in varying

continued on page 22 ▶

SEND YOUR AUDIO ACROSS THE STREET OR AROUND THE WORLD™

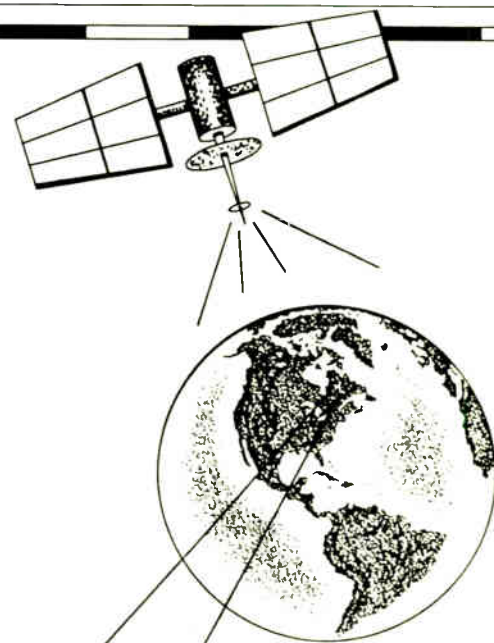

When you think digital audio, think California Digital. We provide satellite/digital technology to make all these options available at low cost:

- | Syndicate your top personality or format
- | Add affiliates - gain revenue sources
- | Share programming, talent and costs
- | Off-site announcer feeds
- | Create events with remotes
- | CD-quality live coverage of news, sports, and concerts

California Digital offers expertise in:

- | Digital Satellite Networks - C or Ku
- | Regional, National, International Nets
- | Remote Broadcasts
- | Rugged Fly-away Systems
- | Custom Ku Power Control Software
- | System Design & Engineering
- | FCC Licensing; Installation and Training
- | Equipment sales, leasing and financing
- | Switch 56 & ISDN program distribution

TOP TALENT IS LOCALIZING NATIONAL SHOWS WITH OUR LOW COST TECHNOLOGY

ASK US HOW YOU CAN DO IT TOO!

CALL: CALIFORNIA DIGITAL AUDIO

West Coast Office (805) 523-2310 Fax (805) 523-0480
 Midwest Office (612) 631-5064 Fax (612) 631-5010



MAKE MONEY BY CREATING A MUSIC PROGRAMMING NETWORK!

Localize Your News Image

► continued from page 21

degrees. Subscribe to the local daily morning paper and USA Today. If there is a local magazine, subscribe to it too.

If your station covers several communities, get in touch with the news publications there. These may only be weekly, but they will allow for greater coverage without a lot of hassle. Set up a network of "stringers." These can be writers for the newspapers discussed here.

Use good judgement

Let's talk about newspapers and radio for a minute. Most importantly, obtain the newspaper's permission before you read anything from its pages on the air. Violating copyright law is a bad way to start a relationship. A good relationship with the editors and news writers of your local paper and those publications in your surrounding area is a good thing. It creates a network instantly, and a functional conduit for the exchange of qualified information.

Request the newspaper reporters start carrying tape recorders, have your news staff start carrying a camera. Also solicit every newsletter, press release, etc., from every organization in your service area. Though many may not be called "news" necessarily, they can add a nice localized lifestyle story here and there to your newscasts. Don't blow these off as "just public affairs stuff." News is public affairs.

Create news formats based on your audience's needs throughout the day. Newscasts in the morning (three- to five-minutes), a "midday magazine" perhaps around noon and then go to an update or headline news format (90 seconds to two minutes) in the afternoon.

The magazine can be hosted by someone in the news department. This magazine should include the day's headlines, including an update on the top story of the day recorded by the morning news

personality and be perhaps 5 to 10 minutes in length, depending on your available network windows.

Workable format

A magazine-style program is a great place to begin doing mini-series type interviews, theme segments concerning local issues, elections, health, business and entertainment news. Providing this information in a "lighter than usual" news format allows your listener to maintain a reference point on the important stories and get a dose of local lifestyle news and information without having to sit through a 30-minute news block in the middle of the work day.

Do not try and throw everything at your listeners at once. Hit the headlines, offer a special segment in some detail. Hit the weather and get out.

As I have suggested that every person working at your station is a potential salesperson, so I maintain that every person working at your radio station is a potential newsperson. News can offer an avenue into your community. Your newspeople should be "out there," not just getting phone bits and re-typing wire stores. If you hope to create that sense of integrity and become a primary news source in your community, you must be active in that community. To accomplish this takes direction, effort and personnel. Again, internships are great, but make sure that you provide direction and maintenance for these interns, don't just shove them out the door telling them to go get a story.

□ □ □

Karl Baehr is president of KBE "Broadcasting By Design," a radio consulting firm providing support services for satellite radio stations and produces the Actual Radio Measurement (ARM) electronic survey system. He can be reached at 505-828-0488; or fax: 505-821-4226.

DXers Club Develops Audio Magazine on Tape

by Dee McVicker

MANNSVILLE, N.Y. What started as a good deed to help out some fellow radio hobbyists who were blind has turned into an entertaining talk show.

The National Radio Club (NRC), established in 1933, is a group of about 700 radio enthusiasts devoted to "DXing," the hobby of picking up skywave AM signals from very long distances. The club had published a regular printed bulletin for many years nine years ago when it began producing a monthly audio version of the newsletter and distributing it on cassette tapes.

Over the years, the show has evolved into an audio news magazine tracing all the latest developments in both AM and FM radio, from the latest trends in radio formats to call-sign and frequency changes.

Sound guide

The 90-minute newsletter is somewhat reminiscent of an all-news or talk-radio show. There is an "AM Switch" column, with news on AM station changes; the "Travellog," an audio sweep of one frequency in a given geographic area of the U.S.; "Bandscan," an analysis of radio programming available in cities across the country, from the bottom of the

dial to the top, and "Musings and Members," with reports from NRC members in the field.

All of the audio columnists are DXers who volunteer their time. John Bowker, who does the "Travellog" column, is on the road much of the year. He records station IDs of all the stations he passes on four tape decks in his van. Club members suspect he has now recorded the IDs of almost about every AM station in the United States and Canada.

Joe Snowbarger began contributing the "Bandscan" column a year ago. His segment attempts to give a new

perspective on the personalities in radio. It features lengthy recordings of radio programming from a different market every month.

"He'll start at the bottom of the dial and record excerpts of each station he comes to in a market," said NRC General Manager Ken Chatherton. "You really get an idea of what that station does on the air."

The audio magazine has come a long way since its first issue in April 1985. "The first year, about all we did was read off of the bulletin," said Chatherton. "The last eight years, it's more or less had a life of its own."

DXer and National Radio Club member Fred Vobbe of Lima, Ohio,

continued on page 47 ►

The 90-minute newsletter is somewhat reminiscent of an all-news or talk-radio show.

Running Radio Marketplace

A Supermarket of Radio Station Services

For information on the services shown below, circle the Reader Service number on the enclosed card or contact the advertiser directly.



Expose yourself with a minimum of risk.

Today's level of fierce competition demands that you prominently display your name every chance you get. Theft, vandalism and loss are an expensive reality.

Roll-A-Sign™ offers a better way. Up to four vibrant colors printed on durable,

high quality 4 or 6 mil plastic film display your logo and message brilliantly. Now you can afford to display a bright new sign at every public event. They even make great cost-effective promotional giveaways. Just roll off what you need and cut.



Call today and get exposed.

800/231-2417

Reef Industries, Inc. • P.O. Box 750245 • Houston, TX 77275-0245
713/484-6892 • 713/947-2053 FAX
©1994 Reef Industries, Inc.

Reader Service No. 81

Radio World

Vol. 18, No 9 Radio's Best Read Newspaper May 5, 1993

Attention Advertisers!

Reach 22,000+ readers world wide. Radio World's Product Showcase provides a perfect medium for test marketing your products and services. It's an efficient, effective and affordable advertising option.

"It Works! It's Great!"

Advertising is good for business!

Product Showcase ads always get impressive results!

Advertise in the Product Showcase Directory!

For more information, including rates and deadlines, Fax Simone at 1-703-998-2966 or call 1-800-336-3045

Jingle & EXPRESS
RETAIL CLIENT JINGLES

Just \$799 plus shipping

Major Market Sound!

Unconditional Money Back Guarantee!

30 Days To Final Product!

Call for FREE DEMO KIT
1-800-950-5787

Radio Concepts, Inc.

Reader Service No. 165

Now at more than 90% of the leading major market stations... thank you.



PR&E consoles... for broadcasters who place a high priority on reliability, features, performance and ease of use.



Pacific Records & Engineering Corporation
2070 Las Palmas Drive, Carlsbad, CA 92009
Tel: 619-438-3911 Fax: 619-438-9277 GSA: GS-03F-4064B

DESIGNS THAT MAKE THE DIFFERENCE

Circle (102) On Reader Service Card
World Radio History

INSIGHT-ON-RULES

More Power Is Allowed on Some Stormy Nights

by Harold Hallikainen

SAN LUIS OBISPO, Calif. I recently received a fax from the engineer at an AM station questioning his manager's decision to go to daytime power before sun-up to broadcast school closings "on really bad mornings when we have been hit with snow and ice."

Rule 73.1250(a) allows AM stations to use their daytime facilities at night "when necessary to the safety of life and property, in dangerous conditions of a general nature and when adequate advance warn-

ing cannot be given with the facilities authorized."

The commission also defines emergency situations in which daytime-power broadcasting is deemed acceptable: tornadoes, hurricanes, floods, tidal waves, earthquakes, icing conditions, heavy snows, widespread fires, discharge of toxic gasses, widespread power failures, industrial explosions, civil disorder, school closings and changes in school bus schedules because of emergency conditions.

Because of skywave interference to

other stations, such operation may only be used if regular unlimited service is nonexistent or inadequate. All operations

Immediately following the emergency, a station must send a letter of explanation to the FCC.

with day facilities at night must be non-commercial. Recorded music may be used to fill between emergency announcements, but no commercials.

Immediately following the emergency, a station must send a letter to the FCC in Washington, explaining the nature of the

emergency, giving the dates and hours of emergency operation and a brief description of the emergency broadcast. The station must

also certify compliance with the non-commercial provision and explain why no other authorized broadcast service was available.

So the engineer's manager is probably operating within the rules, assuming the proper procedures are followed.

★ ★ ★

As I made the 800-mile drive from San Luis Obispo to Las Vegas for the NAB convention, I had a chance to listen to a lot of radio, including one station's "prank calls."

One call rebroadcast from a week earlier was followed by an apparently live call. The woman on the other end of the line of both calls did not seem to have been informed that the calls were being broadcast or recorded for later broadcast, as required by Rule 73.1206.

In the first, taped call, a station announcer impersonated a hotel representative, at the suggestion of the woman's fiancé. She was told that the room reserved for the wedding reception was no longer available because someone else had offered more money to use it. The bride-to-be was understandably upset and later canceled the wedding when she found out her fiancé was behind the hoax.

The couple reconciled during the second call. The wedding was back on, but starting on shaky ground. (He could "be a jerk at times," she said.)

Was there a violation of Rule 73.1206? If events unfolded the way they appeared to over the air, the prank may not have been such a good idea.

★ ★ ★

I have previously discussed the possibility of a low-power FM service and the court case filed by an unlicensed Phoenix station after being shut down by the FCC. At this writing, the case (case 92-70734 in the 9th Circuit Court of Appeals) is still pending.

While researching this issue, I came across the case of an unlicensed low-power FM in Oregon that was also caught and shut down by the commission. But in this case, the commission did a good turn by helping the station operator get in touch with several cable systems. It now operates as an FM cable service.

At about the same time, I heard rumors that the FCC had granted a waiver to another unlicensed Oregon FM station. When I tracked down the operator, it turned out he never sought or was issued such a waiver. The station operates into a dummy load only and is barely audible to his next door neighbor.

□ □ □

Harold Hallikainen is president of Hallikainen and Friends, a manufacturer of transmitter control and telemetry systems. He also teaches electronics at Cuesta College, San Luis Obispo. He can be reached at 805-541-0200. He can also be reached on internet at ap621@cleveland.freenet.edu.

Prices Plummet for Music on Hard Drive

Copyright 1994 by Scott Studios Corp.

10:14:18A	Without You Mariah Carey :14/3:33/F HIT HM0105 10:14 # 1 for 2 Weeks in March, 1994	:14	Delete Del	Jingles & Spots 7	Music Library 8		
* Air * 3:33	Streets of Philadelphia Bruce Springsteen :25/4:03/F HIT HM2608 10:17		Auto 6	Jingles A	Appl- ause B	Sweep- er C	Jingles & Spots D
Start F2	Win It Before You Can Buy It Q: The Sound of the Tones :00/0:18/C PRO TO2214 10:21		F7 Move Up	Wear- ther E	News Open F	News Close G	Rim- shots H
Start F3	McDonald's 2 for \$2 Special JT Q: Thru Saturdays Only. :00/1:00/C COM DA1103 10:21		F8 Move Up	Morn- ing Jin. I	Oldies Jingle J	Legal ID K	Animal Noises L
Start F4	Bob's Bargain Barn BW Q: At Westland & East Park. :01/1:00/C COM DA4310 10:22		F9 Move Up	Top 8 at 8 M	Crowd Boos N	Happy B'day O	More Events 9
Start F5	Uptempo Jingle Q: Kiss FM. :00/0:06/C JIN DA1037 10:22		F10 Move Up	Contest Theme Q	Crowd Cheer R	Weath'r Service S	Options 0
Start F6							

If you've been waiting for hard disk prices to drop before you make the move from cart tapes to high quality digital audio, now's the time. Scott Studios now offers complete hard disk music and commercial systems at the best values ever! And, for a limited time, we're offering *free* digital transfers of your music from the best noise-reduced CDs to our hard disks!

Play Any Audio At A Touch

Scott Studios delivers 24 digital players on a computer touchscreen in your air studio. Six events (on the left of the screen) come in automatically from your traffic and music computers. Jocks can use the arrow keys to rearrange things at a touch.

Eighteen unscheduled jingles, sounders and effects are "always ready" (at right). You also get other screens with unlimited "walls of carts" that play instantly. Pick and play spots, jingles, comedy or song requests sorted ten ways.

Simple and Paper-free

Weather, live tags, promo copy and any part of the day's log pops up on Scott Studios' screen.

Multi-Studio Digital Audio

When spots are produced (or new songs are dubbed), they're electronically transferred to all your air studios. There's no time wasted carrying carts down the hall or redubbing for additional stations.

Compared to mere months ago, hard disk digital audio value is way up. And we offer excellent financing and lease plans. Call for details.

Scott Studios Corp.
13375 Stemmons Freeway, Suite 300
Dallas, Texas 75234 USA
(800) 330-3004

The Best Way to Hear from There

Only Zephyr™ gives you full-fidelity stereo on a single phone line.

No longer will your outside broadcasts be constrained by high cost and complicated equipment. Now all of your remotes can have near-CD quality sound. Using Integrated Services Digital Network (ISDN) telephone lines and the most advanced digital audio compression technology available, Telos makes setting up a remote as easy as sending a fax.

Zephyr is capable of transmitting broadcast quality audio virtually anywhere in the world for about the same price as an ordinary voice call.



It is the ideal solution for remote broadcasts, ad hoc networks, backup to microwave and satellite links, as well as many other applications.

To compress the program audio signal for transmission, Zephyr uses ISO/MPEG Layer III coding.

Several international listening tests have already demonstrated Layer III's superior performance at data rates of 64kbps or less per channel.

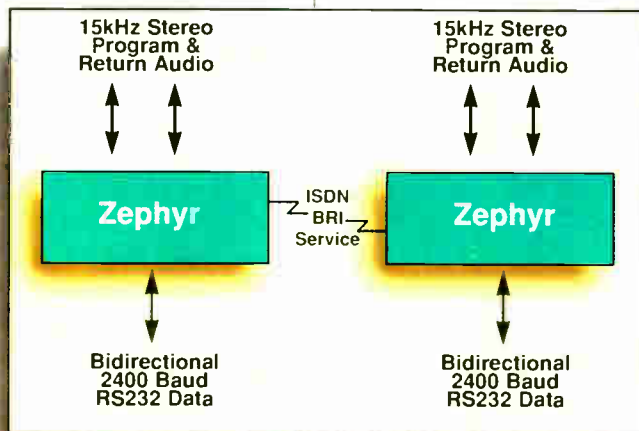

only from



2101 Superior Avenue
Cleveland, Ohio 44114
216.241.7225
FAX: 216.241.4103

- Full duplex 15kHz stereo operation on one ISDN line or two Switched 56 lines using Layer III coding.
- Compatibility with older 7.5kHz codecs that use G.722.
- 2400 baud RS-232 bi-directional data for communications and control.
- Four "end-to-end" simple parallel contact closures for summary alarm and control of recorders and other devices.
- Split channel mode allows individual mono signals to be transmitted to separate sites.
- The ISDN terminal adapter is built-in and no separate boxes are needed.
- V.35/X.21 port allows Zephyr to be connected to one or two Switched 56 lines, spread spectrum wireless modems, satellite links, and other data paths.
- Designed for simple operation with full metering, analog audio limiting, and straightforward controls.
- Each unit can serve as either a transmitter or receiver.



Telos **Zephyr** DIGITAL NETWORK AUDIO TRANSMISSION

If We Don't Have It You Don't Need It.



Serving broadcasters on six continents and in more than 100 countries, we have become the world's leading distributor of studio, production, and satellite equipment, offering the widest range of radio products from a single source.



We deliver when you need it. Over 90% of our orders are shipped within 24 hours. Computer technologies and experience in transportation management, packaging and rate negotiations has resulted in the most efficient shipping and receiving department unsurpassed by our competition.



Our experienced broadcast professionals are working when you are—Monday through Friday, 8:00 a.m. to 8:00 p.m. Eastern. When you know what you need, you'll get the right price. When you don't, you'll get experienced advice.



Satellite products we distribute include reception equipment for digital or analog SCPC, audio or video subcarrier data, uplink and downlink antennas and support products. We are your primary source for the most innovative and effective technology.



With today's growing shortage of broadcast engineers, many broadcasters lack the technical staff to evaluate, maintain and service their equipment. We provide unparalleled customer support with experienced, certified service technicians.



Customer satisfaction is number one. Customer service representatives are ready to check your orders and answer any questions you might have. You can always count on fast, friendly service.

1-800-622-0022

 **HARRIS
ALLIED**

Diodes Help Subdue Damaging DC Pulses

This revised course offers an introduction to the theory and practical application of active electronic devices. The course will give examples of how the devices work as well as ideas on how to use them.

Continuing Education Units will be offered to all who register with Northern Virginia Community College. You will be required to read all of the articles and participate in an exam that will be mailed to you at the completion of the course. You can register for the class any time while the series is running in RW.

To register, contact the Community Education Office, Annandale Campus, 8333 Little River Turnpike, Annandale, Va. 22003. The fee for the course is \$30.

Please make every effort to secure all of the articles yourself. Northern Virginia Community College and RW are not in a position to supply readers with back issues.

by Ed Montgomery

Part IX of XII

ANNANDALE, Va. Active devices can respond to specific electronic conditions without manual adjustments. The diode

shown in Figure One (B), takes advantage of both the positive and negative cycle while D_3 and D_4 rectify the negative cycle.

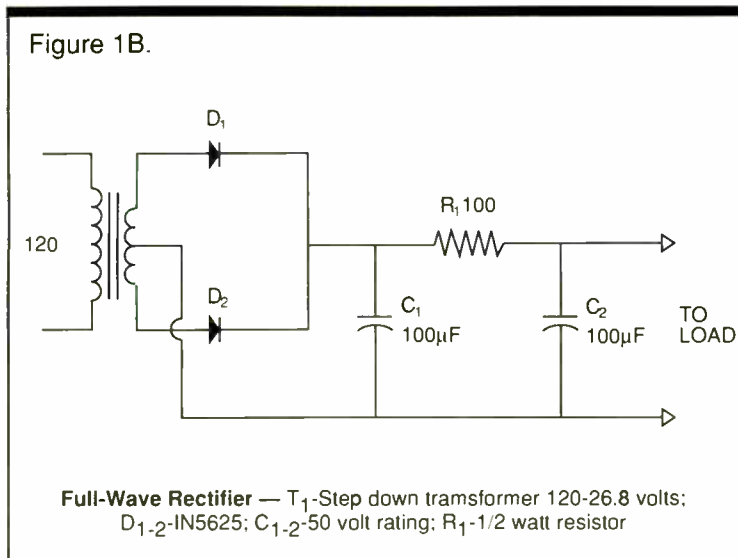

and negative side of the sine wave. It can produce twice as many pulses of DC and requires a transformer with a center-tapped secondary that is grounded. D_1 rectifies the positive peak, while D_2 rectifies the negative peak of the sine wave.

The wiring arrangement of the center-tap permits current from the positive and negative side of the sine wave to travel in the same direction through the load R_L . The full-wave rectifier produces a more consistent DC output.

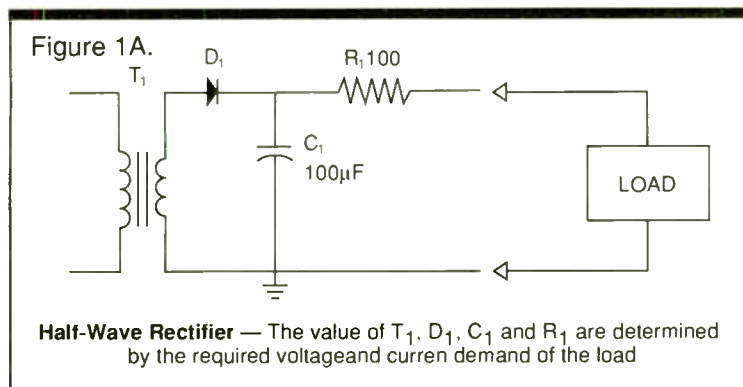

in its simplest design, for example, permits current to flow in one direction only. Diodes are primarily used in power supply design.

The most convenient way of producing and distributing electricity is alternating current (AC), but most electronic devices operate with direct current (DC). Power supplies change the incoming alternating current to direct current at the required voltage level.

Figure One (A) is a half-wave rectifier, one of the simplest electronic circuits. A transformer reduces the incoming voltage to 12 volts and the diode converts the incoming sine waves of alternating current to pulsating DC output.

The capacitor and resistor are filters used to smooth the pulses into a constant direct current flow. This type of circuit is quite practical in devices that do not require critical voltages.

A full-wave rectifier, as

shown in Figure One (C), requires four diodes connected across, or "bridging," the power line. It does not necessarily require a

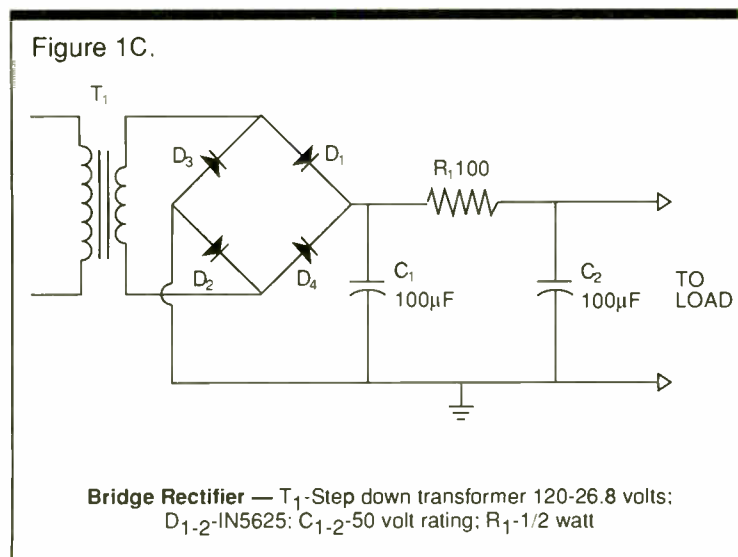

transformer. Four diodes are connected across the alternating current line. Diodes D_1 and D_2 rectify

the output, or ripple, from the sine-wave pulses. Special coils known as "chokes" steady the output voltage.

Bridge rectifiers are usually sold prepackaged with the four diodes in one case and are available in a variety of voltage ratings. Be sure to consult the manufacturer's instructions for proper orientation of the device's terminals.

Figure Two is another example of how a diode can be used to protect electronic circuits and eliminate pulses in communications lines.

"K" is the coil to a relay; "D" is the diode connected in to the circuit, normally reverse-biased to current flow. When S_1 opens, the magnetic field around the coil is released inducing a reverse voltage in the coil creating a current flow in the opposite direction that could damage other components or cause a pulse to occur. D_1 removes this problem by shorting all current flow through its junction confining all energy within the relay terminals.

When 60 hertz AC is applied to a half-wave rectifier, 60 pulses of DC are produced. The full-wave rectifier will produce 120 pulses of DC from the same source.

Capacitors and resistors filter

Diodes can do more than rectify an incoming signal. Figure Three illustrates a simple protection circuit for equipment that can operate on AC or DC. If DC voltage is applied in the wrong polarity, the diode will reverse bias prohibiting current flow.

The zener diode is designed to operate at the point where current begins to flow, which is the breakdown point for most devices. The zener acts as a voltage clamp. All excess voltage that could produce a higher voltage is shorted to ground. The zener diode limits or

Figure Four (A & B) shows a clipping circuit, where the diodes are connected back-to-back. When AC is applied, the output is limited to the voltages the diodes will pass. If this circuit is applied to analog audio circuits, the results could be severe distortion of signals exceeding the limits of the zeners.

Other types of diodes for special use include varactors, light-emitting diodes (LEDs), and photodiodes. The schematics of these devices are found in Figure Five.

Varactors operate like zeners in the reverse-bias mode. The charge built up in the junction is used, not as a clamp but, as a capacitor.

Varying the reverse bias voltage will broaden or narrow the depletion region of the diode junction; decreasing or increasing the charge within the diode, creating the effect of a variable capacitor. This action permits the varactor to replace capacitors in tuned radio-frequency circuits. Varactors are the main components of FM modulator circuits.

continued on page 53 ►

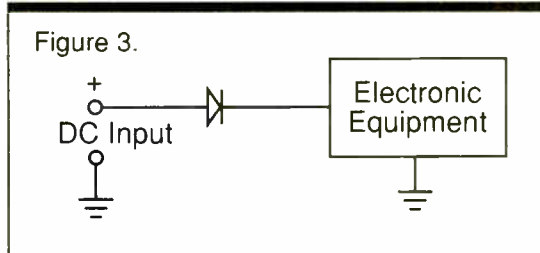
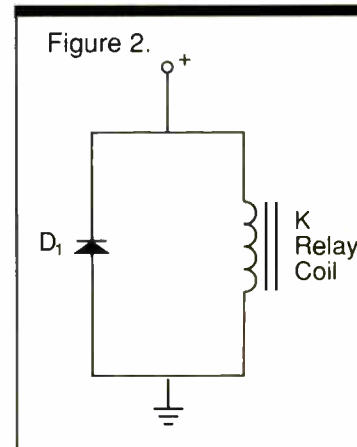

AN FM PROCESSOR / GENERATOR FOR \$1875. ARE WE SERIOUS?



Simplicity is the keynote of this full-featured, integrated FM Processor/Generator. Simple in concept, but without compromise in performance. It features gated, gain-riding AGC, split-spectrum compression and limiting, active overshoot compensation and digital synthesis of the composite multiplex output. There's even internal combining and a pilot sync output for RDS.

Just as amazing as its value is the way it sounds. Simplicity in circuit design yields a transparency that's often missing in more complex products.

We call our Model 715 "DAVID" because it can hold its own against bigger (and much more expensive!) competitors.

DAVID - great sound and great specs for \$1875. Are we serious? You bet!

Inovonics, Inc.

1305 FAIR AVE., SANTA CRUZ, CA 95060
TEL: (408) 458-0552 FAX: (408) 458-0554



FEEDLINE

Skywave Q and A Covers the Details

by W.C. Alexander

DALLAS The recent "Feed Line" column on skywave interference (RW, Jan. 12) generated quite a bit of mail, much of it with questions on the finer points of the issue.

Here are my responses to some of the better questions I received. Hopefully, answers will inspire more questions. The best columns are the ones that elicit this kind of response.

A local radio station is assigned to a U.S. clear channel. The Class A station

on that channel can be heard here at night. The local station signed on in 1970. Does that station have to sign off at night or can it request to stay on the air at a lower power (20 watts or so) with limited coverage?

This question comes up over and over. Back in the 1980s, many of the daytime broadcasters banded together in a loose association to seek some relief, and had some success.

The group won some changes in the Canadian and Mexican agreements and the FCC began allowing secondary nighttime operation by some daytime stations,

provided they did not cause interference to others. Some stations operating on domestic clear channels were positively affected by these changes.

The exceptions are the Class D stations on domestic clear channels with transmitter sites within the 0.5 mV/m 50 percent skywave contour of the co-channel Class A station. The secondary skywave service contour of the Class A station must be protected from interference at night, so if the Class D station is itself within that contour, no radiation whatsoever is permissible.

Six years ago, I worked for the Dallas station on 1040 kHz. WHO(AM) Des Moines, Iowa, was the Class A (then Class I-A) station on that channel. Dallas was well within WHO's skywave service contour, so our station was locked out of any nighttime operation.

In an effort to get some relief, I spent months putting together a huge study showing the WHO skywave service contour and all the areas within that contour that received some other aural broadcast service at night,

which consisted of only 12 percent of WHO's secondary service area.

Only 0.6 percent of the total population within the WHO contour was not receiving some other service. A great many AM stations were restricted to daytime operation for the sake of very few listeners.

The study accompanied a petition for rulemaking to delete protection to Class A secondary skywave service contours, paving the way for just about all the remaining daytime-only AM stations to get some nighttime operating authority. I thought we presented a scientifically sound argument.

The FCC did not deny the petition; it simply ignored it. I think nobody ever looked at the study or the petition. I wonder if the FCC will ever realize that skywave service is really no service.

Skywave probably generates little or no revenue for those stations that are entitled to it, and except for truck drivers, there is probably little audience (far less than 0.6 percent of the potential listeners that my study showed). It deprives listeners of local weather and emergency information.

Who wants to hear the Chicago weather when a tornado is ripping up the local countryside? People need timely local service.

Is it a general rule of thumb that stations on regional channels operate at lower power at night and do not sign off altogether?

The rule is first-come-first-served and best-protected. Stations established back in the 1920s and early 1930s had little interference to worry about and did not need much nighttime protection. Stations that came along later had to reduce radiation toward older stations at night and accept smaller coverage areas.

At sunset, most stations on regional channels must reduce power, change patterns or both. The amount of the reduction depends on the station's age. There

are exceptions in sparsely populated areas of the west.

Years ago, stations on local channels had to reduce their power from the 1 kW daytime level to 250 watts at night. Many of these stations are now full-time at 1 kW and nondirectional. Do you feel that allowing most of these stations to increase from 250 watts to 1 kW at night has benefited these stations?

Yes, to a degree it has, but not as much as you might think. Assume that all stations on the channel operate at 250 watts at night, and a given station has an RSS night limit of 10 mV/m. On a bad night (when propagation is good) that station provides service out to about five miles.

On a good night (when propagation is poor), the station may provide service out to its 5 mV/m contour, or about 10 miles. But on a summer night atmospheric noise may raise the limit by several mV/m and reduce the service radius back down to five miles.

If all the stations operate at 1 kW at night, all the field strengths will double. A station with an RSS night limit of 20 mV/m will still cover about five miles at night with typical propagation.

On a night with below normal propagation the station may provide service out to the 10 mV/m contour, or about 10 miles. The 1 kW nighttime increase pays off if the atmospheric noise is high (such as in industrial areas). The 10 mV/m should be plenty of signal to overcome all but the noise from a local thunderstorm.

Otherwise, it is pretty much an even trade: only the electric bill goes up.

You mentioned the skywave multiplier and skywave fields in calculating night limits. How are skywave fields calculated?

For the last several years, skywave field strengths have been calculated using the formulas in FCC MM Docket No. 88-508. These formulas take into account slant distance and the geomagnetic latitude of the midpoint of the path.

(I will be happy to provide a copy of the formulas to anyone who writes. I also have a computer program that calculates skywave fields using the FCC formulas. Send a 3 1/2-inch or 5 1/4-inch floppy and a self-addressed, stamped envelope, and I will mail you a free copy.)

The formulas and program yield a "skywave multiplier" in dB(μ V/m).

Convert the multiplier to μ V/m using the standard voltage decibel formula. (My program does the conversion to μ V/m for you.) Then, because it is "normalized" to 100 mV/m at 1 km of radiation from the transmitting station, it must be multiplied by the station's actual E_{μ} .

For example, if the converted skywave multiplier is 10 μ V/m and the transmitting station's E_{μ} is 900 mV/m at 1 km, 10 μ V/m multiplied by 900 mV/m at 1 km/100 mV/m at 1 km = 90 μ V/m skywave field.

□ □ □

Cris Alexander is director of engineering for Crawford Broadcasting. He can be reached at Box 561307, Dallas, Texas 75356.



Splatter Control.

The Delta Model SM-1 AM Splatter Monitor provides AM broadcast engineers with a means of accurately and easily measuring off-channel emissions to ensure compliance with the FCC regulations or the more stringent recommendations of the NRSC.

Manufactured in response to the NRSC (National Radio Systems Committee) for AM improvement, the SM-1 gives you the features you need to ensure compliance without buying an expensive spectrum analyzer.

The AM Splatter Monitor measures the level of splatter or any other spurious emissions which fall between 11 kHz and 100 kHz away from both sides of the carrier.

The AM Splatter Monitor is designed to be installed in an equipment rack and fed with an RF sample from the transmitter or common point. But, it's also portable so you can operate it from a twelve volt DC source, such as the cigarette lighter in your automobile. An RF sample is provided via an optional active antenna. This feature makes the Splatter Monitor ideal for investigating interference complaints.

The easy-to-operate SM-1 Splatter Monitor is the inexpensive way to verify FCC and NRSC compliance. Remember- the deadline is June 30.

Limited quantity in stock now!
8:00 a.m. to 8:00 p.m. EST
1-800-622-0022
Fax 317-966-0623

HARRIS ALLIED

©1994 Harris Corp.

Circle (161) On Reader Service Card

World Radio History

Products & Services Showcase

For more information on the products shown below, circle the appropriate Reader Service No.(s) on the enclosed Subscription/Reader Service card or contact the advertiser directly.

WIRELESS IFB SYSTEM

Used by hundreds of TV stations for van-to-field cueing in ENG & SNG applications. Transmitter provides mix of program and instructions to rugged, pocket receivers.

- 100% duty cycle
- Wideband audio
- Excellent operating range



COMREX

Comrex Corp., 65 Nonset Path, Acton MA 01720
Tel: 1-800-237-1776 Fax: 508 635-0401

READER SERVICE NO. 4

Shively

A good FM antenna is crucial to quality broadcasting. An antenna that is merely adequate will compromise the performance of even the best studio equipment and transmitter.

Shively regularly includes standard features that other companies either provide only as options or simply do not offer.

At Shively, we design and build antennas of uncompromising technical quality and performance. And, we build them to last.

call or write for more information

Shively Labs

A Division of Howell Laboratories, Inc.
19 Harrison Road, Bridgton, ME 04009
207-647-3327 FAX 207-647-8273

READER SERVICE NO. 99

S.C.M.S., Inc. Charlotte, N.C.

Low Prices – Experienced Staff
New and Re-built R.F. and Audio

This Month's Special

**DON'T BUY A
NEW COMPUTER!**

**UPGRADE YOUR CLASS AT MACHINE
TO A 40 MHZ 486
FOR AS LOW AS \$275.00
CALL FOR DETAILS**

Toll-Free 800-438-6040

FAX 704-889-4540

READER SERVICE NO. 211

NEW! Composite Audio DA and Switcher!



APPLICATIONS

- Switching Between Composite STL's
- Main/Alternate Processing Switching
- Feed Up to 3 Transmitters with Identical Audio
- SCA or SAP Generator Switching
- Non-Intrusive Composite Testing/Monitoring

FEATURES

- 2 Input Switcher
- 3 Isolated Outputs
- Individual Level Control for Each Output
- Front Panel and Remote Control with Full Status
- Power Fail Memory with Bypass Mode
- Inputs Selectable for Balanced or Unbalanced Operation



Broadcast Devices, Inc.
5 Crestview Avenue
Peekskill, NY 10566

Tel. (914) 737-5032 FAX: (914) 736-6916

READER SERVICE NO. 188

SOUND YOUR BEST ON THE AIR!



CART MACHINE SERVICES:

CART MOTORS REBUILT to quiet flutter-free
perfection-shafts resurfaced
Single \$120.00 Triple \$140.00

CART HEADS RELAPPED guaranteed to
perform like new
Same day turnaround

Replacement heads and motors available

REEL TO REEL SERVICES:

HEADS RELAPPED and precise digital/optical

ASSEMBLY ALIGNMENTS

performed for maximum
response & head life

CAPISTAN & REEL MOTORS REBUILT
for MCI, OTARI and more

For peak performance from your recording equipment, call
The Audio Magnetic Professionals

AMP SERVICES
224 Datura Street, Suite 614, West Palm Beach, FL 33401
Call 1-800-826-0601 for "Same Day Service" in Florida (407) 659-4805
Authorized Parts Dealers for: MCI • OTARI • TEAC/TASCAM

READER SERVICE NO. 96



Econco REBUILT POWER TUBES



Approximately One Half
the Cost of New

3,000 Hour Unconditional Guarantee
Call for Our Price List

Econco 1318 Commerce Ave Woodland, CA 95695
Phone: 916-662-7553 Fax 916-666-7760 Telex 176756
Toll Free: 800-532-6626 From Canada 800-848-8841

READER SERVICE NO. 50

AUDIO BROADCAST GROUP, INC. is proud to introduce the latest in its fine line of professional broadcast studio furniture. Specifically created for the high tech, digital 90's, the new Euro design features rounded radius corners, angled turrets, pull out keyboard drawers and functional PC work stations.

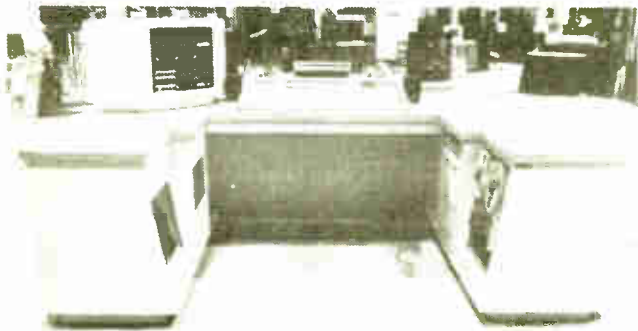

AUDIO BROADCAST GROUP, INC.
Supplying broadcast equipment and studio systems with integrity to the broadcasting community for over 32 years.

AUDIO BROADCAST GROUP, INC.
Your single source supplier of AM/FM studio packages, AM/FM transmitter installations, as well as all major lines of on air and production studio equipment.

For additional information on how we can serve you, please call today

For over 32 years

MAIN SALES OFFICE 2342 S. Division Avenue Grand Rapids, Michigan 49507 Phone: 800-999-9281 Fax: 616-452-1652	SOUTHEASTERN SALES OFFICE 200 Fareway Drive, Suite 2 Smithfield, North Carolina 27577 Phone: 800-369-7623 Fax: 919-934-8120	WESTERN SALES OFFICE PO. Box 1638 Palmdale, California 93550 Phone: 800-858-9008 Fax: 800-273-3321
---	--	---



**AUDIO
BROADCAST
GROUP**

READER SERVICE NO. 12

World Radio History

Attention Advertisers!

Reach 22,000+ Readers worldwide. RADIO WORLD's Product Showcase provides a perfect medium for test marketing your products and services. It's an efficient, effective and affordable advertising option.

For more information, including rates and deadlines, Fax SIMONE at

1-703-998-2966

or Call

1-800-336-3045

cool stuff award winners • test & monitoring • source gear • DAWs • microphones and monitors • RF gear • processing • consoles • STL, remote, telco, ISDN • automation • antennas, towers & RF cable

TEST & MONITORING

New Technology for Test Gear

by T. Carter Ross

LAS VEGAS Ranging from upgrades and reintroductions of traditional pieces of equipment to new remote monitoring systems and digital audio analyzers, NAB 1994 put a variety of new and familiar test and monitoring gear on display.

Belar introduced its new digital stereo monitor, the FMSA-1, which measures greater than 80 dB separation with the AES/EBU digital output. It can be combined with The Wizard modulation monitor for remote control of both units via PC. Units are expected to be available this summer. The Wizard and the Sentry 16 alarm system were also shown.

Inovonics Inc. showed its 530 FM modulation monitor. Combining a wideband FM receiver with very linear demodulation and metering circuitry for precise measurements, the 530 accepts both an antenna feed and a directly coupled RF sample. Balanced program audio out, composite baseband I/O and connections for remote readout are also included.

TFT Inc. showed its model 884 FM stereo modulation monitor/analyzer and the new model 923 AM modulation monitor. Also showing established product was **Modulation Sciences** with its

ModMinder.

Delta Electronics showed its new model SM-1 AM splatter monitor, which provides an accurate and simple measurement of off-channel emissions to ensure compliance with the FCC (NRSC-2) emissions standard.

Potomac Instruments showed its upgraded AA-51A audio analyzer. Although NAB was the official introduction of the AA-51A, the unit has been shipping since October. The upgrade features automatic total harmonic distortion measurements; shielded, active, balance inputs; a frequency counter; less than -92 dBm noise floor; 0.1 percent wow and flutter sensitivity, and switchable high pass and low pass filters.

Making its debut at NAB was the BNG-1000A broadband noise generator from **AVCOM of Virginia**. The BNG-1000A adds to the capability of spectrum analyzers by allowing them to perform frequency response measurements similar to the use of a tracking generator. Also on display was the NASA-1000A Network and Spectrum Analyzer, which acts as a stand-alone 1 to 1,000 MHz spectrum analyzer or as a network analyzer with its built-in tracking generator.

Neutrik featured several enhanced specifications and

options for its A2 two-channel audio measurement system. Processing speed has been enhanced and specifications, including flatness and Res. THD+N, have been improved.

Ward-Beck Systems, which has recently begun "readdressing the radio market" after devoting much of its energies to television, reintroduced its M405P portable extended range VU meter this year. While not a new product, the M405P had been pulled from the market, after repeated requests from engineers. Ward Beck decided to re-offer it.

Circuit Research Labs (CRL) introduced its digital audio analyzer, the DAA-50. It receives and decodes audio data according to the AES/EBU, IEC958, S/PDIF and EIAJCP-340 interface standards, identifying the signal format through LED status indicator lights.

Making a debut at the **Tektronix** booth was the AM70 programmable digital audio analyzer and generator. It features analog and digital outputs as well as an internal speaker and headphone output for confidence monitoring of digital audio signals.

Tektronix also displayed **Rohde & Schwarz'** line of test equipment, including digital audio radio (DAR) test gear. Tektronix and Rohde & Schwarz have entered a marketing agreement where Tektronix distributes Rohde & Schwarz's products in North America and Rohde & Schwarz will reciprocate by distributing Tektronix products in Eastern Europe.

RO.VER.-SAT introduced its HP4-TS high precision multi-standard multi-function radio, TV and satellite analyzer. It can measure field strength, spectrum function, VSWR and SNR ratio.

Shown in a prototype form at NAB, but aiming for November release is **Sescom's** new line of "rackem 'n' stackem" electronics. A series of 1U high and a half-rack wide, these units are designed for use in a very compact environment. Running the gambit from audio testers to LED VU meters, even an LED oscilloscope is in the works, these units make up a complete series of compact audio accessories.

Showing new metering systems were **Wohler Technologies** and **Logitek**.

Wohler introduced the MSM-2 multiple source audio metering system, which uses a 20-segment, tri-color bar graph meter for pre-

cise level monitoring across a wide dynamic range, and the AMP-2AM powered stereo audio monitor that features analog metering for both input channels.

Logitek introduced its Super-VU LED bar graph audio meters. The Super-VU meters simultaneously display VU and peak levels on the same bar graph with tri-color LEDs allowing VU to be shown in green and peak in red. Momentary

Gorman Redlich Mfg. Co. showed its digital AM antenna monitors and a portable, off-site EBS monitor.

J.N.S. Electronics showed the inf2000 Intelligent Rack Frame monitors and analyzes sub level operational systems. It includes an option for remote control via an RS-232 port or a modem.

The Italian-based company **Elenos** showed its RF Diagnostic



QEI Corp., Williamstown, N.J., applied spread-spectrum technology to digital processing to create the versatile QUICK-LINK, a system that can be quickly and easily set up as a remote pickup unit or backup studio-to-transmitter/transmitter-to-studio link.

The spread-spectrum approach of the QEI unit (which complies fully with FCC regulations) makes it practical to set up links that were once impossible or extremely costly due to signal congestion. QUICK-LINK can replace many



telephone-line connections currently in use, the company says. The link, shown here by Jeff Detweiler (r) and Eric Eckstein (l), operates on frequencies between 902 MHz and 928 MHz at bandwidths of between 10 Hz and 15 kHz for stereo or dual mono compressionless digital audio.

For more information, circle **Reader Service 98**.

or continuous hold of the highest peak reading can be selected.

Dorrough Electronics introduced the model 280 and 380 AES/EBU two-channel digital reading audio meters. They simultaneously display peak and perceived power and have a selectable peak-hold function.

FM Systems introduced the ALM 771 audio level master, which regulates an audio program level so that the sound volume, as perceived by the human ear, is consistent even when the source differs in amplitude by as much as 25 dB.

Audio Precision showed a test version of software for its System One and DSP designed for audio codec testing. The software uses a music-like signal to stress the codec output, 15 to 20 sine waves are overlapped. The software is modeled using the laws of psychoacoustics to create a model frequency to match the ranges of the human ear.

Burk Technology exhibited its remote transmitter monitoring system.

Loral Microwave-Narda displayed its line of non-ionizing radiation safety equipment, including personal monitors, survey instruments and area monitors.

telemetry and remote control system, which allows radio stations to maintain optimum working conditions for their amplifiers. Data is transferred via radio link or telephone lines to a PC located at the control station and it is displayed either in real time or in histograms.

Schmid Telecommunication added the SIAT-Max audio test generator to its family of short interval audio test products. SIAT-Max can be used to initiate fast and accurate audio tests prior to receiving incoming feeds; to insert test tones anywhere to test an audio path; to check a line after installing new equipment or for troubleshooting in the field; or, in conjunction with a measurement receiver, to monitor SNR, THD, crosstalk or frequency response.

A new high power RF calorimeter, the model 6085, was shown by **Bird Electronic Corp.**, as well as its line of RF power measurement instruments.

Holiday Industries Inc. introduced a new RF/microwave hazard measurement system. The HI-4000 uses fiber optic technology to help minimize field perturbation in RF/microwave hazard measurement.

A Broadcast Industry

BEST BUY

Mono Record / Play

Stereo Record / Play

\$1420

\$1640

F.O.B. Factory



DL Series

AUDI-CORD CORPORATION

1845 West Hovey Avenue, Normal, Illinois 61761 USA
Phone 309-452-9461 - Fax 309-452-0893

Available Through Your Regular Distributor

Circle (186) On Reader Service Card

Why would anybody put 50 compact discs into something like this?

So broadcasters would never have to so much as touch a CD again. No matter what.

No matter what size their CD library, 100 or 1000. No matter what they want to program for when. No matter what kind of computer equipment they have. No matter what goes wrong with a CD, a player, the changer.

No matter what.

High capacity CD players are all but a must these days, no question of that. How high a capacity, that's a question. Which one's the easiest to load, that's another good question. And what brand is the most reliable, that's probably the best question.

Introducing the 100-CD "Instant Library Change" CD Player/Changer from NSM of Germany.

It's the answer to all those questions. And a lot more.

Put simply, our Model 3101 is the most efficient, totally flexible, all-but-infallibly reliable CD Player/Changer ever made for broadcasters.

The snap-in/snap-out 50-CD magazines are the key.

Once CD's are loaded in the magazine's numbered slots, you never have to touch them again. You simply snap-in two magazines, 100 CD's worth, into our 3101 Player/Changer. Then any of its 100 CD's are all but instantly accessible. It takes an average of less than five seconds for our 3101 to find and begin playing any one of them.

You can change the entire library in just about the same time ... just by snapping out the two magazines, snapping in another pre-loaded set.

What happens if our 3101 breaks down?

We won't say it could never happen. We will say that it'll be rare. Our 3101 has the highest reliability rating in the industry, way above all the others. Its MSBF (Mean Swaps Between Failures) is over 200,000 and our current units in laboratory

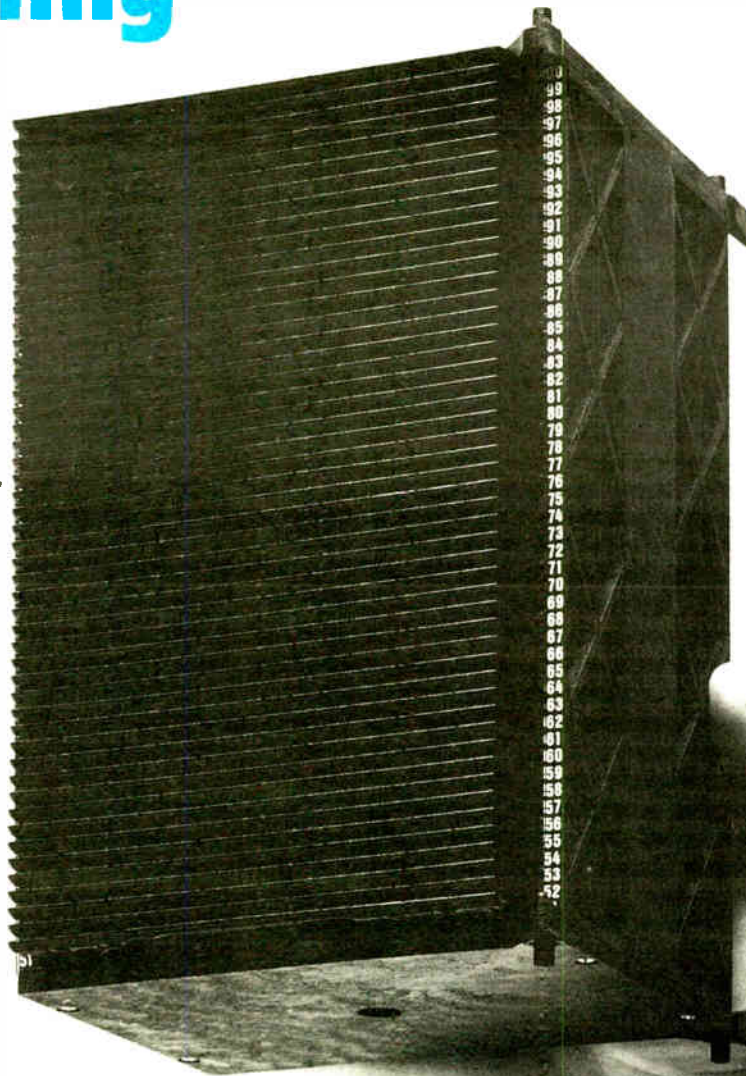

tests are experiencing well over 400,000. What's more, our reliability is street-tested every day in coin-operated jukeboxes throughout the country — we're the largest manufacturer of commercial jukeboxes in the world.

But when the inevitable happens — when something does go wrong — just snap-out the magazines and put them in another 3101. You're back in business. Try that with any other CD Player/Changer.

Link about as many 100-CD capacity 3101's together as you like.

In fact, up to 16 can be controlled through a single RS 232 interface by a single PC ... most likely, the very equipment you have right now.

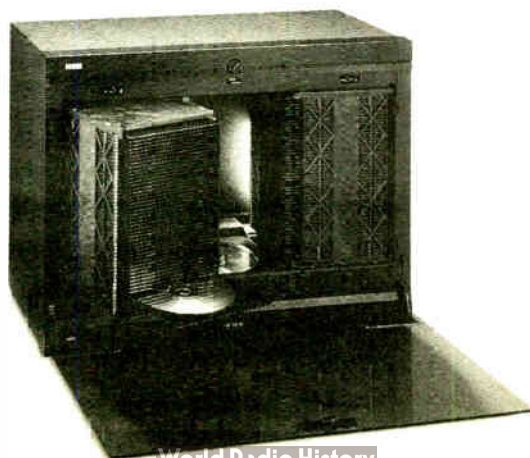

Program any selections, in any order, for any start time ... cue up, blend, whatever you like. Store any number of loaded 50-CD magazines you need nearby.

If you don't want to use a computer, no problem. We have a stand-alone controller that's fully programmable and has its own back-up CD player.

Not only won't you touch your CD's again, our 3101 won't either.

Each CD is cradled in its own tray. And our mechanism grips the trays to remove and replace CD's, never the CD's themselves.

The sealed changer also protects your CD's against dust, dirt, and other airborne contaminants.

We've told you a lot. Make us prove it.

Call, write or FAX for detailed literature and a copy of our 2-year limited warranty, the best in the business. Then try a "you heard it with your own ears" test of our 3101's superb sound quality. Your CD Changer search will be over.

And you'll know exactly why we put 50 CD's into a little magazine.

So you'll never have to do it again.

NSM
Consumer Electronics

40 Cain Drive • Brentwood, NY 11717
Phone: (516) 273-4200 FAX: (516) 273-4240

© Copyright, 1994, NSM - Bingen, Germany; Bensenville, IL; Brentwood, NY

SOURCE GEAR

Integration Is the Key to Source Gear

by Dennis J. Martin

LAS VEGAS In a single word, "integration" describes the direction digital audio based storage systems are heading, as demonstrated at the 1994 NAB convention.

Many now operate in network environments, forming centralized hubs that unite traffic and billing systems to music scheduling and other functions. Newswire and live copy, e-mail, and transmitter readings also have been added as these powerful systems evolve.

Yet the user interface still attempts to preserve the look and feel of familiar broadcast equipment.

More simultaneous operations are becoming commonplace, such as production editing/recording and on-air playback. Many are ideally suited for all modes of operation: live-assist, satellite or full walkaway automation. Standard computer platforms are common, sometimes making use of existing equipment. Increased storage times now allow entire music libraries to be stored and randomly accessed.

"Live digital radio" is how **Arrakis Systems** describes Gemini, a new centralized "resource." The device can simultaneously play, record, cue and audition tracks from any console, control panel, or even be remotely accessed via telephone. Just as office equipment is becoming integrated, Gemini allows you to check the transmitter readings, send e-mail, read the newswire and more while it is being used by on-air and production personnel.

Auditronics was celebrating *Destiny 2000*, its new program management system. *Destiny 2000* was created to integrate your existing music- and traffic-scheduling computers and production

and can perform in downlink applications. The DS2000 is similar but excels in uplink control applications. Simultaneous record/playback is standard, and both can be expanded to 178.5 hours of storage.

Furthering the increased efficiency concept, **Digital Universe™** is the new digital audio solution from **CBSI** (Custom Business Systems Inc.). It is a centralized audio storage and management system that provides almost unlimited expansion, simultaneous record/play of more than 50 channels per server, and includes factory diagnostics via modem.

DDS™, new from **Radio Systems**, is a multi-user, multichannel, multidevice digital audio source and controller. Short for Digital Delivery System, DDS can simultaneously air spots for one station, play music for another, record a newscast and print a report for traffic.

To simplify the transition to DDS, **Radio Systems** designed *The Digital Cart Machine*, a user interface that emulates traditional broadcast equipment. Three Digital Cart Machines can be mounted in a 19-inch rack assembly, making analog cart machine replacement simple.

LPB introduced **SALSA**, capable of

was also announced that the new **Denon DN-980F** and **DN-990R** pro MiniDisc (MD) machines are now shipping.

Digital Broadcast Associates was proudly demonstrating the **dB-CART Advantage Line**. The **Model LC-128** is record/play, and the **LC-128P** is play only—both use an ISO standard 3.5-inch magneto-optical disc. Linear and compressed modes and sample rates can be selected, and the 128 megabyte disks are rated for a million recordings.

The convention marked the introduction of two new products from **Fostex**: the **D-10** and the **D-30**. The **D-10** digital master recorder offers RAM scrubbing and jog/shuttle for "analog style" reel rocking, microprocessor edits, and repeatable punch-in recordings. The **Fostex D-30** digital master recorder also includes scrubbing and jog/shuttle plus preview, auto record, auto cue, instant start, and a digital I/O.

Two new professional portable DAT recorders were announced by **HBB**: the **PortaDAT PDR 1000** and the **PDR 1000TC**. Both use a four head, four motor transport and include analog and digital I/Os. Nickel metal hydride



LMA/DUOPOLY CONTOUR MAPS

The **DATAWORLD LMA/DUOPOLY** Market Survey Contour maps present a precise electronic verification of overlapping and intersecting contours.

AM 5 mV/m and FM 3.16 mV/m City Grade contours are shown in full color, including transmitter site indicator. The map is supported with a printout showing all of the stations which appear on the map.

Daily updating of **DATAWORLD'S** AM and FM databases protects against errors and omissions.

OTHER MAP OPTIONS

- SHADOWING (TERRAIN SHIELDING)
- CONTOUR COVERAGE
- POPULATION DENSITY
- ZIP CODE BOUNDARIES
- RECEIVED SIGNAL LEVEL
- SPECIAL REQUIREMENTS

1990 CENSUS

WHO ARE YOUR LISTENERS?

1990 BUREAU OF CENSUS POPULATION COUNTING

- Comprehensive Ethnic and Demographic Data
- Ethnic/Demographic Data Available for Each Zip Code Within Coverage Area
- Age Analysis Reflected in Ethnic Breakout
- Resolution Increased to Block Level
- Percent of County Coverage Shown

ETHNIC PIE-CHART DISPLAY

- Projects Ethnic Population in Multi-Color Pie Chart Form

dataworld®

800-368-5754 FAX: 301-656-5341



Andrew Corp., Orland Park, Ill., claims it can double the life span of an FM transmission line system with its **HRLine Inners Only™** conductors, which retrofit to conventional 6 1/8-inch line. The company estimates a system will protect transmission lines for more than 20 years.

The usual sliding bullet inner conductors eventually wear out and cause damage to transmission lines. **Inners Only**, shown here by **John Williamson**, saves on maintenance and repair costs with **Andrew's** proprietary bolted flange joints and with a flexible coaxial inner. The line is protected from damage caused by expansion and contraction during hot and cold weather.

Inners Only will fit to **Dielectric**, **Myat**, **Cablewave** and other manufacturer's transmission lines. For more information, circle **Reader Service 113**.

editing workstations into a single, networked system, all controlled by its console and computer. The system operates in live-assist, auto and manual modes.

AudioVAULT OnLINE™, new from **Broadcast Electronics**, also addresses the era of integration by networking radio stations. Offering simultaneous record and playback functions, **AudioVAULT OnLINE** also permits access to spot schedules and production audio from workstations on the network. Traffic, accounting and management personnel can instantly check and update information as necessary.

Also new from **BE** is **daBOX™**, described as an "all-in-one hard disk automation for radio." Full-time, walkaway programming is supported by **daBOX** because it controls up to seven CD players and one satellite service, plus simultaneously records and plays back digitized commercials from its hard disk.

Computer Concepts debuted **Audio Central Plus**, a central audio storage and distribution option for its **DCS** system. The new option speeds file access through a centralized, distributed database, features a dedicated audio server and high speed network topology, and supports up to 48 discrete stereo channels and 16 **DCS** machines.

The **DS1000** and **DS2000** Digital Storage Systems from the **DHK Group** were on display in the **Harris Allied** booth. The **DS1000** is designed for live-assist, satellite, and walkaway formats,

full satellite control and live assist functions. It interacts with common logging and billing systems and music scheduling software. Like other products in its category, it features simultaneous audio record/play, and extended walkaway periods. Somewhat unique to **SALSA** is its random access digital tape system option. An entire music library can be stored on a single digital cartridge, which holds 50 hours of stereo audio.

Other source equipment devices, such as digital cart machines and CD players, are evolving too. While cart machine manufacturers are busy looking for ways to deliver CD-quality audio without compression, CD players and changers are receiving their share of renewed attention.

AIR cart-mo™, new from **Air Corp.**, uses a 3.5-inch magneto-optical disk for up to 44 minutes of non-compressed mono audio at a sample rate of 24 kHz, or 11 minutes of stereo at 48 kHz. The device offers automatic cut rotation, three cue signals and closures, intro/outro preview ability, count down timer, four-line recorded disc label and **RBDS** and logging data.

Denon unveiled the new **DN-650F** CD Player and the **TU-650RDS** AM/FM Stereo Tuner. The **DN-650F** is a single-disc player that features **End Monitor**, **End of Message (EOM)** and **Fade-In** modes, and true **Instant Start**. The **TU-650RDS** is **Denon's** first tuner to incorporate **RDS** digital data technology. It

rechargeable battery technology powers the **PDR 1000** for up to two hours and avoids "memory effect." The **PDR 1000TC** is equipped to record, generate and reference time code.

Otari was highlighting the new **MR-10** MD Recorder/Player and the **CDC-600-2C** CD Auto Changer. The **MR-10** is a professional MiniDisc recorder/player that includes next play select and auto monitor functions; timer display; track mark, edit and **EOM** functions; mono/stereo switching; and a dedicated remote controller. The **CDC-600-2C** is a CD auto changer that holds 360 CDs and contains two CD players. Alternate or simultaneous playback is possible.

The **CAC-V180M** 18 Disc CD Autochanger was introduced by **Pioneer**. Three six-pack magazines permit libraries to be categorized. An **RS-232C** interface is available for external control, and the unit is said to be commercial-quality.

New from **Studer** was the **D730** and **D731** professional CD players. Both read CD-Rs without **TOCs**, include a cue wheel with dial and shuttle functions, allow start and stop cues to be set to any point, and an intro mode has an accurate count-down provision. The **D732**, also new from **Studer**, offers many of the features of the **D730** and **D731**, but at a budget price.

Other products in the audio storage category enjoyed upgrades, either through hardware or software refinements.

continued on page 34 ►

Products & Services Showcase

For more information on the products shown below, circle the appropriate Reader Service No. (s) on the enclosed Subscription/Reader Service card or contact the advertiser directly.

STABILINE Uninterruptible Power Supplies



19-inch rack mount . . . just the right size for studios and mobile production vehicles.

These true on-line UPS systems provide a reliable source of clean, continuous, sine wave AC power to broadcast and other voltage sensitive equipment. They accept industry standard 19-inch rack enclosures and can be mounted with or without standard slide rails, by L support brackets or by front panel plate. Typical operating times range from 10 to 30 minutes at full load and 25 to 60 minutes at half load. Auxiliary battery packs can extend time. All units are equipped with an RS-232 signal level interface DB-25 connector that interacts with commercially available computer/LAN operating system software for an orderly system shutdown. Ratings in 800 and 1250 VA, 120 V, 60 Hz models. Complete literature on request.

Call 1-800-446-6161 in USA & Canada

SUPERIOR ELECTRIC Bristol, CT 06010
Tel: 203/585-4500
WARNER ELECTRIC
FAX: 203/582-3784

READER SERVICE NO. 14

Omega Scientific Corporation

RF MATCHING NETWORKS

Phasors,
Diplexers,
ATU's
Intercept
Filters

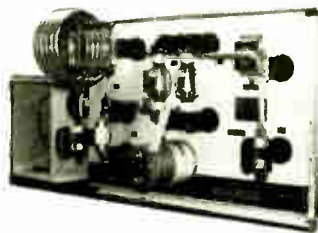

Custom Design and/or Manufacture

Call or FAX for RFQ info sheet

Ph: (210) 599-0789

FAX: (210) 599-0799

4246 Gate Crest, San Antonio, TX 78217

READER SERVICE NO. 219

Measure Up With Coaxial Dynamics Model 81070 WATTCHEM Transmitter Protection System.



NEW!
4-1/16 and 6-1/8 series line sections and elements to add to our exciting line-up

WATTCHEM—protects your transmitter and transmission line system. A permanent 19 inch rack installation used with any dual socket line section 7/8", 1-5/8", 3-1/8" and elements (additional) to monitor CW, TV, and FM power. Model 81070 features two easily read meters to monitor both forward and reflected power. The reflected meter provides a front panel adjustable set point which controls the trip level for fast transmitter shut down and alarm. Abnormal load conditions quickly cause transmitter shut down in less than 15 milliseconds including control relay. Both visual and audible alarms indicate system malfunction. Contacts provided for remote alarm and reset switching. Contact us for your nearest authorized Coaxial Dynamics Representative or Distributor in our World Wide Sales Network.



COAXIAL DYNAMICS, INC.

15210 Industrial Parkway • Cleveland, Ohio 44135
(216) 267-2233 or 1-800-COAXIAL • Fax: (216) 267-3142
Service and Dependability . . . A Part of Every Product

READER SERVICE NO. 35

Zercom Patch Switch



\$350.00

Zercom Patch Switch (Model #PS-1) will put an end to your confusing and unsightly patch bay. It is easy to install and use. Its stereo 10 in and 1 out or 1 in and 10 out configuration allows you to reverse stereo phase and perform stereo to mono summing with the push of a button. It provides additional input switching on overcrowded consoles, for the selection of satellite, remote, or studio feeds at the push of a button. Zercom Patch Switches can be easily bussed together using optional ribbon cable for more complex applications.

High quality Switchcraft brand switches do channel selection. There is room to add resistors to make audio pads inside. No internal active electronics. We recommend the Zercom Gain Box to increase levels as necessary for some applications.

ZERCOM

Box 84, Merrifield, MN 56465 • 218-7675-3151

READER SERVICE NO. 173



MADE
IN
U.S.A.

**I HAVE TO DRIVE TO THE TRANSMITTER?
... AGAIN ?!?!**

Why drive when you can call? Using Monroe's 6000 Series Remote Controls and your telephone, two-way radio, microwave link or other audio path you can have complete control over a remote site. For over 15 years Monroe Electronics has supplied the broadcast industry with reliable and affordable DTMF remote control systems.

Let us help reduce your driving time, call Monroe Electronics today.

Distributor and Representative inquiries invited.

ME MONROE ELECTRONICS
LYNDONVILLE, NY 14098

800 821 6001
716 765 2254
FAX 716 765 9330

READER SERVICE NO. 104

Finally! An affordable routing switcher.

- 6 balanced stereo inputs/outputs
- Front panel electronically interlocked switches
- Remote control via 25-pin D-type connector
- Status display on front panel switches
- Audio connections via wire captive terminal strips



- Applications**
- Console input expander
 - Studio switcher
 - Source equipment input/output selection
 - Composite/SCA audio switching
 - Remote control studio and EBS operation

6 x 1 Stereo Routing Switcher with front panel and remote control for around \$399.00

Call us!

BROADCAST tools 206.938.4089 VOICE-FAX-VOICE MAIL

6353 40th AVENUE SOUTHEAST, SEATTLE, WA 98136 USA

READER SERVICE NO. 150

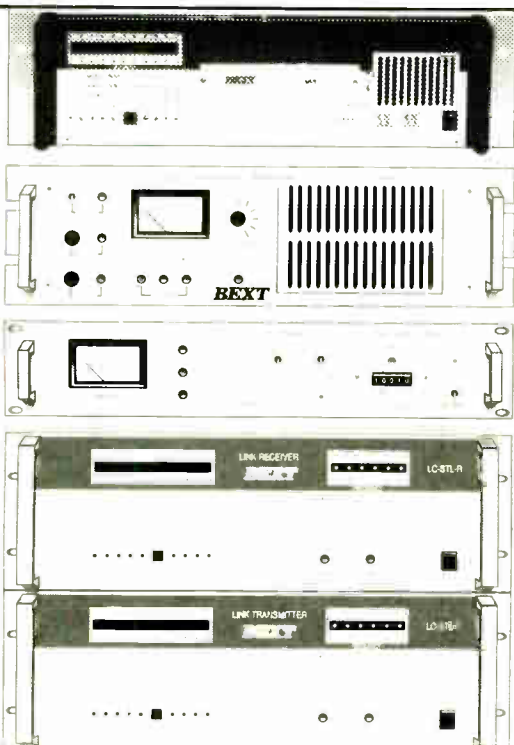

BEXT High performance RF

Exciters
Amplifiers
Translators
Transmitters
STL's

Backed by our two-year warranty and the BEXT 24-hour engineering hotline.

619-239-8462
FAX: 239-8474

1045 10th Ave.
San Diego, CA 92101

READER SERVICE NO. 17

WorldRadioHistory

EVEN THE BEST CAN BE MADE BETTER

Introducing the new

MINI-MIX 12A

THE COMPACT MIXER WITH A COMPACT PRICE FROM THE QUALITY LEADER

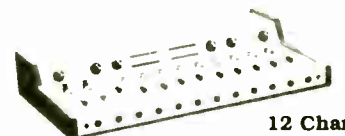

\$3499

12 Channels
25 Stereo Inputs

Service & Affordable Quality for Over 23 Years

AUTOGRAM CORPORATION

1500 Capital Avenue
Plano Texas 75074-8118

(214) 424-8585
1-800-327-6901

FAX (214) 423-6334

READER SERVICE NO. 63

Integration Is Key to Source Gear

► continued from page 32

The Gemini-Trak*Star-Digilink from Arrakis is now equipped with six new features: tagged text, start and kill date capability, a programmable playlog, hot link Digilink tasks, remote update of unattended sites and context-sensitive help.

Computer Concepts announced that a touch-screen interface has been added to its Digital Commercial System—DCS.

The Dynamax Air Marshal was reintroduced by Fidelipac.



A digital audio hard disk system, it features an intuitive user interface; provides simultaneous play, record and audition functions with up to four audio outputs per unit; is expandable to more than 200 hours of storage and is designed for live-assist and satellite formats.

New software is at the heart of the DigiCenter from ITC International Tapetronics. Described as an audio management system, DigiCenter is available in a variety of configurations—from an entry level system, up to full automation and live on-air control of two stations. DigiCenter interfaces with all major traffic and music

software packages.

MediaDISK™, from Media Touch Systems, is portrayed as a "networked digital storage system for automation and live assist," and is said to be constantly evolving. Operating on a Novell® LAN, audio can be accessed from any networked PC equipped with an audio card. User selectable modes of operation include Pick 'n' Play cart replacement, News Lineup, production recorder, background recorder, waveform editor and playback-to-air. One

information about drives, directories, cuts and more is displayed by OnScreen/II.

Version 3.0 operating system is new for the Akai DR4d hard disk recorder. The new operating system allows the DR4d to internally combine track data. Thus, any combination of tracks—up to all four—can be bounced to any destination track.

Many other centralized audio storage products were on display.

D-Cart, from the Australian Broadcasting Corp. (marketed by BASYS Automation Systems), is a multi-user, networked digital audio recording, editing and playback system. D-Cart is ideal for all formats, including news/talk and music, because any amount of audio material can be accessed randomly by almost any number of users.

"The MAR System from AEQ saves time by eliminating several intermediate steps. Using a touch-screen interface, one to more than 10 users can simultaneously access audio files in real time. Storage capacity ranges from five to 80 hours of stereo on hard disk, while rewriteable optical disks offer unlimited storage.

The DAD486x digital audio delivery system, from Enco, is designed for production, management, and multi-output reproduction functions in live-assist and automated formats. It is easily expanded, features time-shifted reproduction of automatically recorded events, operates under DOS on commonly available equipment, and can be configured as a standalone or multi-user LAN system.

Electric Works—The Management was demonstrating AXS™, a replacement for analog cart machines in the production and control rooms. Networked via a LAN, AXS is controlled using a keyboard, trackball or mouse, or optional touch screen or remote button box.

Functioning as a music and commercial source, the Pristine MMCS, Music Management and Commercial Control System, from Pristine Systems, includes Music Plus, a playlist generator. MMCS is compatible with both LANtastic and Novell® networks, and can control up to 48 multi-disc CD players or DAT machines.

Prophet Systems was demonstrating Wizard for Windows™, a digital automation system capable of running multiple stations. Programming, sales, production, and on-air operations can all be

integrated using Wizard for Windows.

RCS (Radio Computing Services) offers three master control solutions: Model 100 is designed for satellite affiliates that also need live-assist capability; the Model 200 is geared toward live-assist operations, but is also used for satellite programming and full automation, and the Model 300 is ideal for stations that store their music library and other audio on hard disk.

The Phantom was on display at the Register Data Systems booth. Ideal for satellite operations, The Phantom features six stereo inputs—which can be increased to 14—multiple sampling rates, and can re-time spots to fit into a satellite break without silence or overlap.

Genesis Digital Audio™, from Schafer World Communications, is intended to function as a live control room or as a complete satellite system. It is compatible with CD players, DAT machines, and is expandable to 30 hours or more of stereo or mono audio storage.

Multitrack digital recorders, and CD and MiniDisc players and recorders were also popular products at the convention.

Alesis was exhibiting ADAT®, a digital multitrack tape recorder. Supporting eight independent 16-bit linear audio tracks on a single S-VHS® tape, and sample rates from 40.36 to 50.85 kHz, 40 minutes (320 track minutes total) can be recorded on a standard S-120 NTSC S-VHS tape.

The AudioMetrics CD 10 CD cartridge machine was on display at the Harris Allied booth. The CD 10 cues to music, recognizes syndicator's Index 3 subcodes, and track numbers can be selected using either the track keys or the jog/shuttle wheel.

Germany's NSM introduced the 3101, a 100-CD "Instant Library Change" CD player/changer. The unit features two snap-in/snap-out 50-CD magazines, that allow access to any of the CDs in an average time of less than five seconds.

The 3101's MSBF (Mean Swaps Between Failures) is over 200,000. A user can link together as many as 16 3101 units through a single RS232 interface by a single PC.

The Marantz CDR610 compact disc recorder also was demonstrated by Harris Allied. It is a complete CD recording and playback system that creates a temporary table of contents. That feature allows recordings to be stopped and restarted.

Panasonic was showing its line of DAT Recorders: the SV-3900, SV-3700, and the SV-

3200. The SV-3900 uses one-bit high precision analog-to-digital converters and an advanced four-DAC system with 18-bit resolution.

The MDS-B1 is a MiniDisc recorder and the MDS-B2P is a player, both of which were highlighted at the Sony booth. Quick random access, EOM function, and up to 74 minutes of digital recording and playback are a few of their features.

The Tascam exhibit included their line of CD players, such as the CD-701 and CD-601; analog master cassette decks, like the 122MKIII; and Model 32 and BR-20 series of analog reel-to-reel decks.

At the Yamaha exhibit was the YPDR601 professional compact disc recording system, and its companion RC601 remote controller. The recorder allows "start-stop" recording, and TOC "Pre" and TOC "After" modes of operation.

Even some of the most technologically-advanced devices rely upon products from other manufacturers. Following is a brief look at a few supporting products at the convention.

Ampex offers a broad range of magnetic tape products. Of particular interest was Ampex 467 DAT digital audio tape, available in six different lengths, and Ampex 489, digital mastering audio tape, specifically designed for the new multitrack digital audio mastering applications.

Audiopak was displaying its complete line of cartridges—the A-2, AA-3, and AA-4. The AA-4 uses advanced 614 tape for increased headroom and superior high frequency response.

DIC Digital exhibited its line of DAT tapes and non-abrasive DAT Drive Cleaners, its 3.5-inch rewriteable magneto-optical discs, and its 63 and 74 minute recordable CDs.

The "hottest tape yet" was being shown by 3M. Type 996 audio mastering tape is capable of an operating level up to +9 dB. 3M also provided information on its DAT.

S-VHS, audio cassettes, open-reel and DAT tapes, and CD-R discs, were exhibited by Maxell. Introduced was an environmentally-friendly head cleaner.

In the Zonal booth was a complete line of open reel and DAT tapes, leader and spacing products, plus CD boxes and trays and cassette library cases.

Garner demonstrated its 682 Series of degaussers. The 682 Series is designed for cassettes and computer media in use today such as S-VHS and DAT tapes.

The TD-5 Tape Degausser, exhibited by Videomagnetics, erases all cassettes and tape reels up to two inches in width, including DAT and S-VHS.

SIERRA AUTOMATED SYSTEMS

From SAS, The Complete Range of Broadcast Audio Routing & Mixing Systems.

SAS 32000 Stereo Audio Routing & Mixing System—Perfect for mix-minus conferencing, mixer emulation, teleconferencing hubs and communication systems. Also ideal for plant and transmitter routing, satellite and remote distribution. Standard summing for mix-minus feeds, IFB, studio intercommunications, voice-over work, and more.

System size starts at 32 x 16 mono or stereo matrix modular configuration and expands up to 128 x 128. Serial bus RS-232 for terminal, local panel and modem control. Modular remote panels for console fit as well as standard rack mount panels. Custom and turnkey systems available.

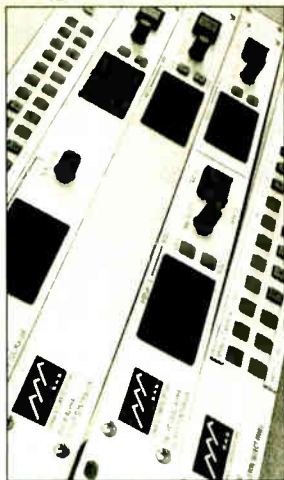

Sierra Automated Systems & Engineering Corp.
2112 North Glenoaks Blvd., Burbank, CA 91504
Voice 818.840.6749 Fax 818.840.6751

Distributed by RAM Broadcast Systems, Inc.
P.O. Box 3100, Barrington, IL 60011 Voice 800.779.7575
Fax 708.382.8818 In Canada 800.433.2458

DAWs

DAWs Handle the Tasks Of Audio Management

by Ty Ford

LAS VEGAS Workstation technology and applications have expanded to the degree that the terms "workstation" and "digital audio workstation" are, by themselves, no longer sufficient to describe the genre.

Some systems are designed for production and editing, others are designed to replace cart machines or purport to replace a facility's entire audio system—commercials, promos and music. Larger, networked systems interface with satellite-fed programming and live-assist and playlist/program log data.

Now some systems do all of the above. But be careful, because some are still barely capable of handling simplest chores and knowing exactly what is needed is not easy.

360 Systems is now shipping DigiCart/II with version 2.0 software including new file sorting options, record overwrite, pause during record, secondary and tertiary cues, easier stack manipulation, preset "hot keys," an updated ES-buss serial interface and operating system, three different remote control options and larger 70-minute capacity Bernoulli carts.

The company also showed a soon-to-be-ready I/O board that allows AES/EBU, SPDIF and analog operation for DigiCart/II and DigiCart/TC, a SMPTE chase/lock version of the DigiCart that features transport control, playlist generation, insert edits and VTR emulation.

ONSCREEN/II Windows PC software for DigiCart/II, with visual information about directories and cuts as well as file utilities capabilities for up to three machines, was also introduced.

Akai Digital showed new MIDI, SMPTE, SCSI interfaces for its DR4d workstation, and DL4 remote panel and version 2.0 software to implement the peripherals and SCSI backup. Version 3.0, due in May 1994 will support internal digital mixing, MMC (MIDI Machine Control), MTC (MIDI Time Code) and SMPTE. Akai also showed third-party software from Mark Of The Unicorn for waveform editing on a Mac.

Arrakis Systems is now shipping version 2.2 of its Digilink system software. It is being sent for free to 2.0 users.

Version 2.2 includes crossfades and overlaps for playback of files and CDs, implementation of in and out flags for audio transitions and AutoFill and Smart Squeeze for time adjustment of stop sets to fit satellite windows.

Users can make zero-to-two-second adjustments for each transition in 1/10 second increments. Fills can be PSAs, time calls or any other element in the fill file. New automatic music rotation allows an hour-by-hour, 10-rule music clock for music scheduling. The upgrade supports up to 40 different user-definable program clocks and up to 40 satellite and live jocks and increased use of computer utilities for backup, playlist purge, help and macros.

ProVox, a brand new Mac-interfaced one-track digital hard disk recorder from **Audion Laboratories**, is designed to replace tape recorders in radio station control rooms and newsrooms. The system includes a Mac, a Sound Tools card and Audion's VoxPro software to record, record insert, cut, copy, paste, "bleep"

undesirable sections and store audio on a Mac hard drive. Ten "cart keys" on the remote keyboard can fire individual sounds or spots. Waveforms are displayed on the Mac screen for editing.

Basys Automation Systems offered the new Australian-developed D-CART PC graphical user interface, designed as an option to the original terminal emulation. D-CART is a multi-user digital audio record/edit/playback system for newsrooms, adopted by ABC Radio Networks

continued on page 39 ▶



The CSA judges were impressed by a number of products in the Stick-On™ line from **Radio Design Labs**, Carpinteria Beach, Calif. The products, displayed next to Joel Bump, are



designed for quick and easy installation in several audio applications.

The ST-SX4 switcher accepts up to four unbalanced audio sources; the ST-OSC2 A and B dual audio oscillators provides left and right audio signals in two separate frequencies, 1 kHz and 10 kHz (in version A) or 100 Hz and 400 Hz (version B), and the ST-RG1 ramp generator features 0-to-10-volt output for use with remote control VCAs.

For more information, circle **Reader Service 40**.

YOU CAN RELY ON LPB®

Everyone knows the LPB Signature Series is the industry standard for rugged reliability. The LPB tradition of durable, reliable, easy-to-use consoles continues in our new linear fader consoles.

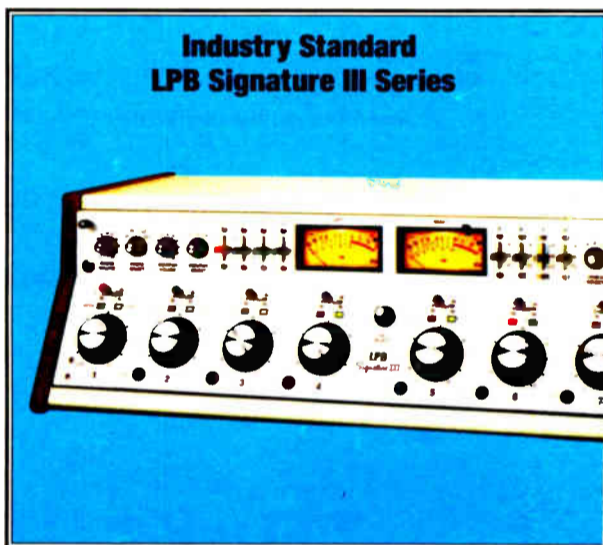

With over 3,000 units in operation worldwide, the LPB Signature III console represents a standard others are still unable to match. The Signature Series has proved its ability to perform on 6 continents, in settings ranging from metropolitan to jungle. With an incredible record of ruggedness and easy maintenance, it's no wonder over half of the Signature console owners have more than one. Features include 3 inputs per channel, two output buses and plug-in electronics. LPB Signature III consoles are available in 6, 8, 10, and 12 channel stereo and 6, 8, and 10, channel mono models.

The LPB 7000 Series takes the standards of the Signature III a step further, adding more features than any other console in its price range. With front panel switches rated for 5,000,000 operations, gold contacts, plug-in modular electronics and more, the LPB 7000 Series has the durability radio and TV stations worldwide expect from LPB. Features include two inputs per channel, three stereo output buses with one mono-mixdown standard and two more optional, user configurable muting and remote starts, and much more. Available in 12 and 18 channel stereo models.



It doesn't matter which LPB board you choose, you'll get a console you can count on 24 hours a day. One you'll keep for a long time. Ask any LPB console user - they're all around you.

LPB®

28 Bacton Hill Road • Frazer, PA 19355 • (610) 644-1123 • Fax (610) 644-8651

Circle (59) On Reader Service Card

from Moscow to NY & from Paris to Tokyo...

MORE STATIONS BUY ARRAKIS!!!

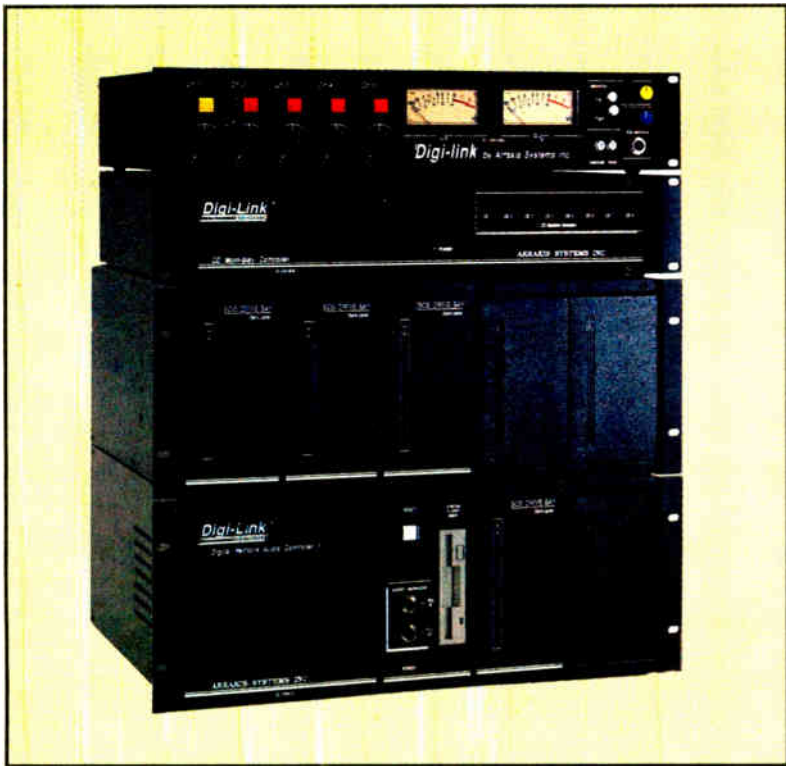

DIGILINK... THE #1 DIGITAL SYSTEM starting at under \$8,000

- 10 hours of stereo digital audio storage for \$7,995 complete
- Satellite, CD, Tape and Hard Disk Automation
- Simultaneous Play, Record, & Network transfer
- Digital Editor with Waveform Editing for tight production
- Crossfade CD's, sources, and hard disk audio
- Music Scheduling system built in for basic CD automation
- Digital Networking for transfer of audio and schedules

Digilink is the #1 selling digital audio hard disk system in radio today. You can replace your cart machines for live On Air and have an automation system for walk away at the same time! Link over 15 workstations & scheduling computers on our digital network and transfer audio and schedules between your studios.

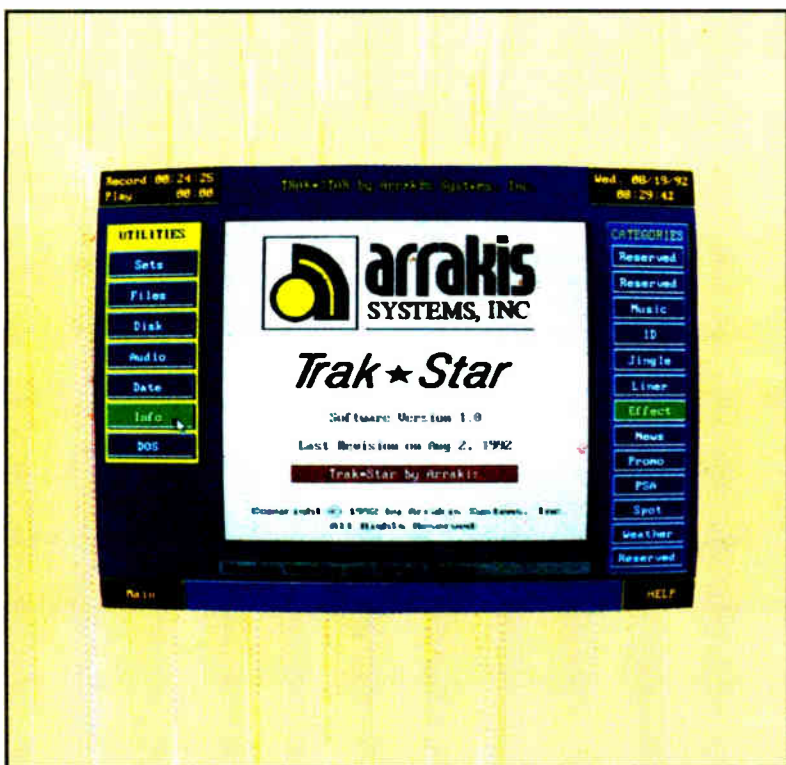

TRAK*STAR-8 THE 8 TRACK DIGITAL EDITOR starting at under \$5,500

- A digital audio editor designed for Radio production
- Learn to use in minutes, much faster than tape
- Cut, splice, move, and fade up to 4 stereo tracks
- Use Scrubbing to edit with your ears
- Use visual waveform editing to edit with your eyes
- An UNDO button enables you to go back and fix mistakes
- Digital Networking to transfer audio to your On Air machine
- Add Trak*Star-8 software to a Digilink for \$2,000

Trak*Star-8 is the first cost effective multitrack digital audio editor designed for the radio broadcast professional. Fast and easy to use, produce your commercials on Trak*Star and then transfer them in digital straight to the Digilink in your On Air studio. Dramatically reduce production time and save money!!!

2619 Midpoint Drive, Fort Collins, CO. 80525

Voice (303) 224-2248

12,000 Series Consoles



Standard Tabletop Mainframe displayed above

- Totally Modular Console-Input-output-monitor
- Three Mainframe Sizes - 8, 18, 28 input channels
- High Quality Construction-P&G Faders, etc.
- Polycarbonate overlay-for scratch resistance
- VCA Controlled Faders-for ultra reliability
- Universal Mainframe-any module in any position
- Inputs-2 per channel
- Outputs-3 stereo, Pgm, Aud, Utl
- CR Monitoring-stereo Monitor, Earphone, & Cue
- Studio Monitoring-two studios supported
- Talkback-two studios w/monitor dim
- Telephone interface-2 internal mix minus buses
- Timer-60 minute digital up timer standard
- Options-DA module, Remote selector module, Dual Machine Control Module

Deluxe thru-table mainframe displayed below

Typical List Price

\$4,000 - \$7,000

From France...to Moscow...to Japan and Taiwan, and around the world...the 12,000 console is On the Air.

The 12,000 is the #1 selling Arrakis console line from the #1 console manufacturer. With three stereo output buses and two mix-minus buses for telephone interface, the 12,000 can fill any application. The 12,000 also supports a control room and two studios standard. Panning or Mode select are available on the four models of input modules, VCA control of audio delivers reliability and performance.

Quality, performance, and durability make Arrakis consoles the leader around the world.



14 1/4" x 20 3/4"

Arrakis Systems is a world leader in radio studio technology. In Japan, Digilink is a brand name for hard disk audio for radio. For use around the world, the United States Air Force chose the 10,000 series console from among all competitors as its console of choice. When the United Nations needed 6 entire studios with consoles and furniture for a rush shipment to Cambodia early this year, they chose Arrakis 10,000 consoles and Modulux furniture. In Jamaica, Tahiti, and elsewhere, entire factory assembled and tested Arrakis studios are on the air. Around the world and of course in the United States...more stations buy Arrakis for their digital audio, console, and furniture needs!!!!

FAX (303) 493-1076

by **ARRAKIS SYSTEMS inc.**

There are many reasons for choosing AEQ products. Here are just a few.

Control and Flexibility in your Remote Event Transmission



The AEQ Portable Mixer MP-10

- ▶ Ideal for remote event transmission.
- ▶ Easy to install and operate.
- ▶ Provides portability and autonomy.
- ▶ Carrying case included.

Special features:

- ▶ Five transformer balanced inputs selectable Mic / Line.
- ▶ Front panel input controls.
- ▶ Capable of linking mixers together to increase number of inputs.
- ▶ Transformer balanced outputs.
- ▶ Internal Ni-Cd rechargeable batteries provides 4 hour autonomy.
- ▶ Automatic switch to battery if power fails.
- ▶ Dialing keypad, dual mode Tone / Pulse.
- ▶ Three headphone output jacks.

Stereo Quality Monitoring at Mono Price



The AEQ AM-03 Stereo Audio Monitor

- ▶ Designed to meet the monitoring needs of technicians working in VTR rooms, OB vans, radio and TV controls, etc.
- ▶ All the controls are in the front panel to facilitate easy and accurate operation:
 - Input selector (three selectable stereo inputs).
 - Output channel selector and balance.
 - Gain control and power switch.

Features:

- ▶ Three way audio system (mono for low and stereo for mid and high frequencies), consisting in five speakers. All contained in one unit 19" rack space.
- ▶ Electronically balanced inputs and output, with XLR connectors.
- ▶ Incorporated limiter for speakers protection.
- ▶ Audio phase meter.
- ▶ Headphones connector with automatic speakers disconnection.

The Ideal Combination



Digital Telephone Hybrid AEQ TH-02 EX

- ▶ Frequency Extender Mode as standard feature.
- ▶ Works with one or two telephone lines.
- ▶ The second line provides full Multiconference Mode. The operator and two callers can talk and listen to each other simultaneously.
- ▶ Hybrid null of 60 dB's.
- ▶ No adjustment required.
- ▶ Ideal companion to work with AEQ Portable Digital Line Extender TLE-02.

Portable Digital Line Extender AEQ TLE-02

- ▶ On Air phone call with audio presence, depth and clarity of voice. No "telephone sound".
- ▶ Easy to use. Designed for the non-technical user.
- ▶ Ideal for field reporters, totally portable. Light weight: 3.3 Lb.
- ▶ Great operation autonomy, using 8 AA batteries.
- ▶ Dialing pad in front panel, and Pulse / Tone selectable.
- ▶ Independent level control of Mic / Line input, auxiliary input and headphones.

Value & Performance



AEQ Mixing Console BC-500

- ▶ The AEQ Mixing Console BC-500 is designed for those radio stations seeking great audio quality at a competitive price. Its designers paid great attention to the control layout; the logical control design ensures a quick learning period as well as a trouble free operation.
- ▶ Advanced true modular design allows total flexibility. The module chassis has built-in meters and speakers and comes in a standard configuration with the following capabilities:
 - ▶ Six dual stereo inputs.
 - ▶ Four mono inputs Mic / Line selectable.
 - ▶ One Telephone Hybrid interface.
 - ▶ Studio control Intercom monitor.
 - ▶ One main stereo output plus mono sum output.
 - ▶ Power supply for On Air signaling.
 - ▶ The AEQ BC-500 comes with 4 blank modules to enhance this configuration.



AEQ AMERICA, Inc.: 2211 South 48th Street, Suite H - Tempe, AZ USA 85282
Phone: 1 (602) 431 0334 - Fax: 1 (602) 431 0497

DAWs Take on New Tasks

► continued from page 35
in 1992. Up to 24 people can work on the same audio piece at the same time.

Broadcast Electronics demonstrated several approaches to digital audio, including daBOX, an all-in-one HD radio station automation system that will control seven CD sources. Using Dolby AC-2 compression, the entry-level system provides five and a half hours of stereo storage. The system allows up to 126 CDs (seven packs of 18) with record/play capability. Two record or play boards are in the base package. Source and control options are available including network delay, spot overlap, an additional 88 players and up to 23 in-coming feeds.

BE also showed its AudioVAULT 100 modular windows-based, multi-tasking system for single workstation use and AudioVAULT 100 OnLINE for unlimited workstations and networked digital audio storage system. Both are now shipping and feature selected sampling and compression ratios.

AudioVAULT MTE is a windows-based package designed to work with AudioVAULT. It provides up to four analog or AES/EBU and SPDIF digital inputs; selected 16, 20 and 24 bit recording; multiple sample rates; real-time digital re-sampling; jog and shuttle; bounce and overdub; EQ; vari-speed; time squeeze; noise reduction, and up to eight-track playback with real-time mixing.

PACE, the new computerized editing system from **Corporate Computer Systems**, is designed specifically for newsrooms and radio stations. It is easy to learn due to extra engineering to create a familiar user interfaces. PACE is based on ISO/MPEG Layer II compression.

DigiDesign released the Pro Tools 2.03 software package and a Mac-based Session Eight to complement an earlier DOS version.

It also showed PostView, a system using a version of QuickTime which, via third-party hardware boards (Radius VideoVision Studio, SuperMac Digital Film and Raster Ops MoviePak cards), allows the capture of 60-field-per-second video. Imported video "movies" can then be brought into a Pro Tools session for frame-accurate sync of audio to the picture.

You can auto-spot or nudge audio to picture without VITC. The system also supports VTR control via Sony nine-pin or V-

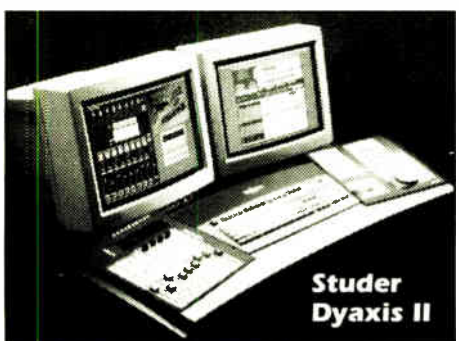

LAN protocols and requires at least a Quadra series running at 25 MHz with 16 megabytes of RAM, plus a system for full frame video playback. A SCSI accelerator for more than four tracks of audio is also required.

Digidesign showed a pre-release version of PostConform, a software package integrating EDL and auto-conform. The company also plans to begin shipping the Pro Tools 2.5 upgrade in the near future, as well as TDM (time domain multiplexing), a 256 channels 24 bit data buss, allowing virtual digital mixing environment and

DSP plug-ins from Digidesign and other third-party companies.

DAWN IIxe, the latest from **Doremi Labs**, with version 4.0 software is a multi-track digital audio editor/recorder with on-board mixing to either hard disk or magneto-optical drive. The basic two-by-eight-by-two system can be expanded eight tracks at a time up to 48 tracks. The system supports volume changes, pan, mute, solo, parametric EQ and mixing via an on-board DSP. File formats are compatible



Sometimes even the most precise, expert audio subjective analyst cannot find all of the flaws in a stereo signal. A visual representation of the signal can sometimes pinpoint what the ears cannot.

The MSD550 Master Stereo Display workstation from a Danish company,

with DAWN II, AIFF and OMF formats.

The system offers 20-bit resolution A/D conversion, 120 dB dynamic range, 32, 44.1 and 48 kHz sampling rates, variable playback speed, SMPTE lock and video sync. AES/EBU digital I/Os are 24-bit. The system requires a Mac Quadra 650 or better, with 12 megabyte RAM for multi-track work.

Running on a standard PC platform, the latest software for **Enco Systems'** DAD486x features ISO/MPEG Layers I/II and Dolby AC-2 compression. It also supports automated, live-assist and satellite formats. Their largest system consists of 21 workstations and three mirrored file servers.

ITC is now shipping DigiCenter, a digital audio delivery system with an option of three waveform editors. The system supports on-air operation of three stereo files and production simultaneously because it communicates directly with hard drive. The server system allows output of six stereo channels without compression.

It also showed DigiCenter News, a system to collect news wire text and record audio news feeds for editing, production and playback; the DigiCenter-LITE, a low-cost, but full-featured entry-level system in a computer-tower platform, and the new TM-220 integrated traffic-music merge and edit software developed for the DigiCenter.

Another ITC software package, developed by EZ Communications for DigiCenter, provides a multi-tasking environment for on-air, production and executive tasks.

Version 4.0 of **Lexicon's** Opus increases the system's simultaneous tracks from eight to 16 and increases the number of virtual tracks to 200. The upgrade supports 24 channels of digital mixing, improved screen display markers and a new 486 computer to speed up the display.

From its debut at NAB's 1993 Radio Show, the AXS system was promoted as a cart replacement system. It is a modular automation system covering cart machine replacement to CDs, satellite and music

stored on hard drive for live-assist or automated operation. A two-track production module is available that does recording and cut and paste editing.

Available in combo production and control room or just control room, a full system can carry up to three overlapping digital sources at the same time. Single playback systems are also available. AXS runs on a graphics DOS-based system, using a 486 PC that supports multi-tasking. It is LAN compatible and supports traffic, billing and music software packages. The AXS log format includes music and spots.

Micro Technology Unlimited showed its

Other features include: hot keys for start and end markers, auto save, up to 40 sound files in the same project, five parallel control lines for machine control and overdub.

Version 2.3 Beta was shown with four-channel digital and analog I/O and fewer screens. Version 2.4 fader controller, horizontal panning fader during playback.

After some intra-company reorganizing, the **AKG DSE-7000** made its first appearance as the **Orban DSE-7000**. New since last year's NAB was implementation of 64 megabyte RAM cards for a total of 256 megabyte (70 minutes) per production. Two software upgrades (3.51 and 4.0) including features such as, remote control, up to 2 gigabyte storage, library sound preview, improved on-line help, faster reload and improved error detection.

Orban was also showing two new I/O cards (analog and digital), both of which may be used in the same unit. The analog offers 32 kHz, 44.1 kHz rates with 64x oversampled Delta Sigma A/D conversion and 8x oversampling at the output.

The digital I/O offers AES/EBU and SPDIF at 32 kHz, 44.1 kHz and 48 kHz with auto-sample rate and format detection. Multiple sample rate converters allow asynchronous digital I/O operation: input, output and project sample rates may all be different. Output sample rate is constant, even in scrub and vari-speed modes.

Otari Corp.'s ProDisk 464 Version 4.3 includes waveforms in edit screen, a new hardware control panel and support for hardware control panel. CMX auto-conform. The soon-to-be-released 4.4 software supports record to edit screen, time compression and expansion, a new library structure with database search and magneto-optical drive support.

Pacific Recorders' Version 4.0 of the ADX software now runs on all systems. New features include the vertical track display, two-in/two-out, eight internal tracks, DSP, dynamic automation and built-in

continued on page 41 ►



DK-Audio, provides an especially well detailed visual representation by combining a correlation meter, level meter and audio vector oscilloscope within its current software package (Version 2.0). The current package is also available with a spectrum analyzer option which will measure acoustics, distortion noise and other factors.

Edwin J. Somers, service manager for Audio Service Corp., North Hollywood, Calif., U.S. distributor of DK-Audio products, is shown here holding the MSD550. For more information, circle **Reader Service 34**.

MicroSound with MicroEditor 2.2 software. The system now has mouse-able dynamic mixing of up to five stereo tracks live from one drive, 50 independent stereo playback tracks and SMPTE slaving. Mono sound files can now be brought into stereo productions. The latest version features two independent analog and digital I/Os. Delete and gain change edits are now done in less than a quarter of a second.

Belar
STEREOMONITOR

You can measure...

with the best monitor and the most accurate test set.

The FMM-2/FMS-2 series monitors provide an even greater degree of precision measurement than ever before... **You can measure** S/N below 90 dB, **You can measure** crosstalk below 85 dB, **You can measure** separations of better than 70 dB, **You can measure** frequency response to better than 0.25 dB, **You can measure** distortions to lower than 0.01%, and much more... Our uncluttered panels and autoranging voltmeters make these measurements a dream.

BELAR (610) 687-5550
ELECTRONICS LABORATORY, INC.
LANCASTER AVENUE AT DORSET, DEVON, PENNSYLVANIA 19333
Call or write for more information on Belar AM, FM, Stereo, SCA and TV monitors.

Products & Services Showcase

For more information on the products shown below, circle the appropriate Reader Service No.(s) on the enclosed Subscription/Reader Service card or contact the advertiser directly.



The Mariner

A Console for your Future

- DCA (Digitally controlled analog) faders
- Better than "CD" quality sound
- Modular frames hold 6, 12 or 22 mixers
- Five types of input mixers available
- Optional RS-232 serial interface
- LCD displays dynamically label each mixer
- Programmable machine control system
- 2 Mix-Minus outputs, Talkback & more
- Prices start at \$3900



Call: 800-231-5870 or 713-782-4492 for your nearest Logitek dealer

READER SERVICE NO. 67

EBS EQUIPMENT



- Model CEB Encoder-Decoder.....\$540
- Model CE Encoder.....\$375
- Model CE with Stereo Option.....\$405
- Model CD Decoder Only
(REQUIRED FOR LPTV).....\$320
- Receiver can be supplied to drive Decoder.\$100

- Encoder FCC Type Accepted •
- Decoder FCC Certified •
- Exceeds FCC Specifications •

All interconnections to the EBS equipment are made through a barrier terminal block. No special connectors necessary. In stock—available for immediate delivery.

GORMAN REDLICH MFG. CO.
257 W. Union St.
Athens, Ohio 45701

Phone 614-593-3150 • FAX 614-592-3898

READER SERVICE NO. 205

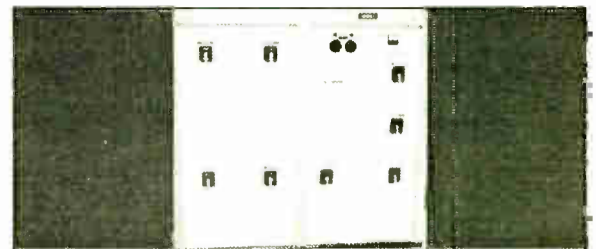

- CUSTOM ANTENNA PHASING SYSTEMS
- ANTENNA CONTROL SYSTEMS
- AM/MF ANTENNA TUNING UNITS
- DIPLEXERS & MULTIPLEXERS
- TRANSMITTER COMBINERS
- DUMMYLOADS (WITH MATCHING NETWORK)
- ASSOCIATED RF COMPONENTS
- CALL OR FAX FOR MORE INFORMATION

PHASETEK INC.

550 CALIFORNIA RD. UNIT 11
QUAKERTOWN, PA 18951

PHONE: 215-536-6648

FAX: 215-536-7180

READER SERVICE NO. 111

Realize the full potential of your MACKIE CR-1604

The Broadcast Tools *Console Controller II* allows users of a Mackie CR-1604 or virtually any MI type console to utilize many broadcast features at an incredibly low price.

- Turn mic & line inputs On/Off locally or remotely
- Switch between AIR signal and program audio
- Mute monitor speakers
- Activate ON-AIR light
- Start a Skimmer tape or cassette



Call us!

BROADCAST TOOLS 206.938.4089 VOICE•FAX•VOICE MAIL

6353 40th AVENUE SOUTHEAST, SEATTLE, WA 98136 USA

READER SERVICE NO. 22

GPS MASTER CLOCK/TIME CODE GENERATOR WORLDWIDE TIME

Locked to the Atomic Clock in the Global Positioning Satellite System, you can have time, date and time code within nanoseconds of UTC, anywhere in the world!!

ES-185

\$2495.00



STANDARD FEATURES INCLUDE:

- SMPTE/EBU, ESE, IRIG-B & ASCII Time Code Outputs • 1PPS Output • 6 Satellite Tracking • Battery Back-up • GPS Locked Indicator • Automatic Daylight Savings Time Correction • Time Zone Offset • Antenna • AND MORE!!

OPTIONAL FEATURES INCLUDE:

- Parallel BCD Output • 1 KPPS • 10 MHz Output • 220 VAC • 12 VDC • Video Inserter • Video Sync-Generator



3 YEAR WARRANTY

142 Sierra St., El Segundo, CA 90245 • (310) 322-2136 FAX: (310) 322-8127

READER SERVICE NO. 109

Introducing (ta-da) The Jr. Audio Director Plus™!

It's an 8 input to 2 output ON LINE or monitoring device.

\$550



The new Benchmark Jr. Audio Director Plus™ brings more to the party! It brings more control and selection features, and a stereo headphone amplifier, along with the performance and value that are traditionally a Benchmark for the industry.

In a half wide, 1RU high chassis, the Jr. Plus has two input switch banks which allow left and right outputs to select between eight sources. Additional switches provide a Mono Mix, with adjustable gain reduction of 3 to 6 dB, and a Right Channel Polarity reversal. LEDs indicate switch action. Inputs may be passively mixed ahead of the input amp by depressing two or more buttons.

Installation is "instant" with a No-Mod™ Rack Mount adapter and plugable Euro-Style barrier strips.

Available now.



BENCHMARK MEDIA SYSTEMS, INC.

Phone 800-262-4675, or 315-437-6300, FAX 315-437-8119

READER SERVICE NO. 177

Manufacturers

Is your company or product featured in our pages? Distribute extra copies of **Radio World** articles to your customers with

Radio World's reprint service.

Print as many copies as you want for **one low price.**

For information, call Simone Mullins at

1-800-336-3045

DAWs Take on New Tasks

► continued from page 39
three-band parametric EQ.

Pacific's ADX BASIC stand-alone, streamlined, two-in/eight-out version of the larger workstation is expandable to the larger system. It now includes a Macintosh Quadra 610, a 16-inch monitor, keyboard and mouse, with a 1.2 gigabyte internal hard drive that provides three track hours at 44.1 kHz. The system also includes an eight-channel digital editing and control system and a separate dedicated hardware transport control. Additional SCSI devices can be added to increase the storage and backup speed.

The ADX Workstation now includes a Mac Quadra 650, expandable to 2.4 gigabyte of memory, larger 16-inch monitor, 630 megabyte magneto-optical drive and six track-hours recording time with expanded record time of over 24 hours available. The system supports eight-in/eight-out recording. On-line factory support via modem is standard with the ADX Workstation and optional with the ADX Basic.

A new unnamed system featuring horizontal and vertical editing screen scrub for all eight tracks, faster editing, dynamic level is expected to be shipping within three months.

Shippable in three months, Digital Delivery Systems by **Radio Systems** is a Unix-based system that allows call up of any cut in the system on any control face. It is intended to be used as a cart and music replacement storage and playback system capable of playing back six stereo hours (at 6:1 compression) through 16 stereo sources simultaneously.

The Phantom, by **Register Data Systems**, is designed for satellite-fed or on-premises automation, or live-assist operation. It uses an 486-based CPU interfaced with video, communications, DSP and data acquisition systems.

RDS's AMX-84 includes eight 10,000 ohm balanced stereo inputs that can be switched to any of four 600 ohm stereo balanced outputs. The software system allows for a high degree of programming flexibility for spots, music and drop in announcements. Recording of feeds or spots do not effect programming. Spots are rotated according to user programs.

Each input source has its own list of hourly clocks. Auto-Fill detects incomplete spot breaks and fills them with a specified list. Each clock contains information about stop sets that will occur within the hour. A running one-month history of all system events, expired cart report, log problem report are part of the standard system.

Roland Corp. was showing software version 2.0 for its DM-80 system. The new package supports waveform editing in the remote control, additional (+0) markers, enhanced backup features, auto-trim threshold editing, cross-production access of sound elements and increased editing of the mix automation data.

Roland also previewed version 2.0 of Multitrack Manager for the Macintosh with the firmware upgrade, this new version also supports the use of up four DM-80 units for a total of 32 tracks.

SADiE Inc. showed its new SADiE Disk Editor, a PC-based system with the promise of lifetime software updates. New version 2.0 software supports two-in/four-out operation and includes internal digital bounce mixing, dynamic compression/expansion, gated dynamics, three-band parametric EQ

plus hi/low shelf, noise abate (downward expansion), digital vari-speed with no sample rate change, sample rate conversion, time compression/expansion, display of eight discrete tracks, overdub, punch in/out, PQ coding for CD preparation and improved SMPTE chase/lock.

Version 2.1, due later this year will show multiple channel waveforms and offer

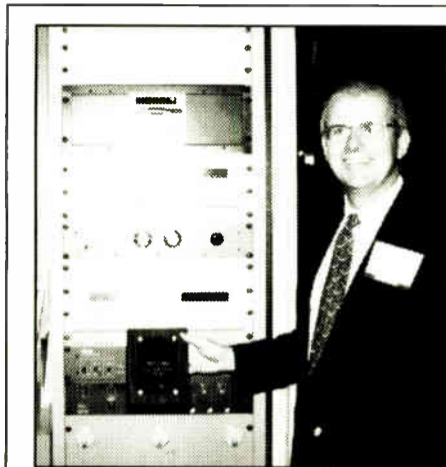

Moseley Associates Inc.'s latest digital RF link, the Starlink 9000, is loaded with features. It can transmit CD-quality stereo with Radio Data System (RDS) information in a wireless STL configuration or using wired T1,

CD-R support, mix automation, auto conforming and machine control.

Spectral Synthesis introduced version 2.0 software for its Audio Engine supports moving fader automation, on-the-fly punch in/out, magneto-optical support for backup or recording for up to four tracks at a time.

Up to seven Q-Cards may be used for acceleration for DSP functions. The system supports effect processing dual, single-band parametric EQ for each of 16 channels in real time.

Spectral Synthesis was also showing its AX-S stripped-down, two channel A/D converters AES/EBU and talking about its Prisma single-card, 12-channel workstation due in June. It should be file-compatible with the audio engine system and is now shipping to dealers for demo purposes.

Spectral Synthesis also demonstrated **Innovative Quality Software's** Software Audio Workshop using a SoundBlaster card to bring in video for spotting effects and music. SAW's version 2.6 supports the mixing and playing of four stereo 16-bit audio files (four stereo 48 kHz files) using standard Windows sound card drivers. The SAW system requires a 386-DX-40 PC, 8 megabyte RAM, Windows 3.1 and a 16-bit sound card with a Windows 3.1 compatible driver.

Studer/Editech showed the MultiDesk™ assignable console for the Dyaxis II. It includes eight automated touch-sensitive moving faders plus a master fader, computer keyboard, a scrub control, and assignable buttons for machine control of up to four external machines, auto-locator, jog wheel. Also new, MultiMix Version 2.0 software provides dynamic automation with or without MultiDesk.

Having weathered a financial reorganization in April 1993, **The Synclavier Co.** is back with direct-to-disk recording, now on same SCSI buss as a Mac CPU. This arrangement allows the Synclavier to be put on the Mac desktop where sound files, sequences, and cues can be dragged and dropped to and from any device, Mac or Synclavier and translated into AIFF, Sound Designer II, OMFI and Quicktime

as well as Synclavier sound files.

Sounds can be auditioned directly from the Macintosh through Apple sound manager 16 bit 44.1 or 48, mono or stereo. S/Link, the proprietary software for a Mac, uses the Ethernet output of mac. The system requires a Mac IIx or faster with 8 megabyte RAM.

The MegaRAM 64 megabyte memory card option enables a maximum configuration of 768 megabyte of sampling RAM (equivalent to two and a half hours of continuous recording at 44.1 kHz).



E1, ISDN or Switched 56 circuits.

Starlink also has two built-in digital SCA generators for operation between the 22 kHz and 185 kHz FM subcarriers and comes with a card for up to 256 kilobits per second of other voice, data and fax communications.

Like earlier Moseley digital transmitters, the Starlink is constructed with open architecture to allow the user to choose a compression system.

Dave Chancey (left) demonstrates the system. For more information, circle **Reader Service 159**.

The FastTrax 2.4 gigabyte removable disk drive option for the PostPro SD, provides one and a half hours of recording time at 44.1 kHz on each of up to 16

tracks, with the ability to swap drives during a session for backup during off hours.

TimeLine Inc. is the most recent owner of the Waveframe workstation. It has combined the two previous software packages, The Editorial and DRM, into the new version 6.0.

Look for the Studioframe DAW-80, which works on a Windows platform with a 486 66, 8 megabyte RAM offers eight analog I/O channels, two digital I/O channels, 16-bit input and 18-bit output, MIDI automation, LTC reader/generator, VITC and composite sync reader. The system incorporates a 10-by-two mixer with two AUX sends with eight-in/eight-out/eight-record/playback architecture and supports M/O storage and streaming tape backup.

Solid State Logic demonstrated the evolution of its SoundNet multi-user networking systems, WorldNet-Project and WorldNet-Audio. The first enables the transfer of entire projects; the second relays "live" digital audio.

ScreenSound Version 5, which supports a faster processor and an extended range of operational features, was also shown. Version 5 also offers the option of integral random access video in the form of VideoTrack.

Also new was SSL's Scenaria OmniMix digital surround sound audio/video system. Configured for the post-production market, OmniMix features a substantial hardware control surface with 16 moving faders, dedicated metering and controls. VideoTrack is also available with the system.

Is your Talk Show



THERE?



or HERE!

TS612

DCT
Direct Connect Technology

DCT: PLUG IN. TURN ON. TALK.

A complete system for ONE or TWO studios

TWO built-in Gentner DCT Superhybrids

Generates its own Mix-Minus

Up to 12 incoming analog lines

Call Gentner TODAY for more information!

Radio World's
"COOL STUFF" Award
at NAB 1994

801-975-7200

Gentner
The Talk Show Equipment Leader

MICROPHONES & MONITORS

Variety of Wireless and Studio Mics

by John Diamantis

LAS VEGAS The trend in microphones this year is an expanded presence of wireless systems with diversity receivers, especially UHF frequency synthesized types. There is also an increase in the number of affordable studio condenser type microphones.

Shure's new products include the EC and SC VHF wireless microphone series. The EC4 receiver utilizes Shure's Marcad Diversity Technology with digitally-controlled frequency synthesis. Boasts improved selectivity and noise rejection through improved filtering. Handheld transmitters are available with SM58 and SM87, as well as the BETA 58 and 87 microphone elements, and utilize a new high efficiency antenna to improve performance. Up to 15 EC systems can be used together.

Shure was also displaying its current stable of microphones including the fine SM7 studio mics as well as the popular music and performance series including the SM57, SM58 BETA 58 and the new BETA 87.

Sennheiser showcased some of its new K6 modular electret shotgun mikes, capable of operating on AA batteries, as well as its rather comprehensive line of recording, studio and wireless mics. Their new proforce line of mics are cost effective stage and handheld vocal types, including a wireless system with diversity receiver.

Sennheiser's mainline studio mic series,

the MD line was also displayed including the station standard MD 421-U cardioid, and the 441-U supercardioid.

Big news from Neumann is the recent introduction of their new TLM 193, a large capsule, condenser U87 sound alike for less than half the cost. List price is \$1,295. While it didn't have quite the last bit of warmth as its big brother the U87,

products, featuring its new UHF wireless systems using the S 700 handheld and TS 900 pocket transmitters, with the NE 700 receivers featuring two independent diversity receiver sections, beyerdynamic also was displaying its complete line of dynamic and condenser mics, including the MC 742 stereo condenser and the MC 834 condenser with transformerless out-



The Zephyr Digital Network Audio Transceiver provides audio network distribution of 15 kHz stereo signals over the current copper telephone infrastructure, thanks to

Integrated Service Data Network (ISDN) technology. **Telos Systems**, Cleveland, introduced Zephyr a year ago as the first U.S. to use the ISO/MPEG Layer III compression standard, and announced its general availability during NAB '94.

IDB Communications currently uses Zephyr, shown (left) by Steve Church, Toni Thimet and Kevin Nosé, to backhaul live entertainment and sports events. Individual stations could use Zephyr for remote broadcasts or as backup satellite and microwave links. The system also provides for ancillary data transmission over two 64 kilobit-per-second channels, which can be used for talk-back and other functions.

For more information, circle **Reader Service 78**.



and its pattern is not switchable (stuck on cardioid), it certainly allows more stations and recording studios to offer that "Neumann sound" without driving their accounting departments into a panic. Also showing were the KM 100 miniature microphone system, using interchangeable heads allowing a wide range of different patterns and frequency responses.

beyerdynamic had on hand many new

put and high SPL capability just right for high-volume announcers.

Sony corporation was displaying a large selection of microphones to suit most any situation. The WRR-840A and 820A are high quality UHF wireless receivers (Sony calls them tuners) featuring frequency synthesis and diversity reception. The companion transmitters include handheld WRT-810A, and 830A, as well as belt-pack model WRT-820A all of which feature frequency synthesis, selectable RF output, and will run on two AA batteries for eight hours. Sony is also one of a small group of microphone manufacturers currently producing a vacuum tube condenser microphone. While they are pricey (around \$3,500) they sound great and have great specs.

Samson introduced a new wireless diversity system utilizing digital to select which antenna to route to a single receiver circuit. This not only makes for better reception, but allows a more cost effective product to be produced. This means more bang per buck.

Nady systems showed its new ENG-11, and ENG-12 snap on wireless system designed to convert any microphone to wireless operation. The ENG-11 is a VHF system, with a camera mount receiver for ENG applications. The ENG-12 is a UHF system with up to 160 channels available. The receiver is either a camera mount, or you can use their new 950 GS UHF multichannel rack mount receiver. This box uses frequency synthesis for channel selection, and systems are available from 450 to 950 MHz. If you are running more than one wireless mic the Nady UHF amplified antenna distribution system is for you. It feeds from four to eight diversity systems utilizing only two antennas.

Audio Technica displayed its new studio mic the AT4050/CM5 studio capacitor mic. It has a lot going for it: features like three switchable polar patterns, high SPL capability, discrete electronics, and a price tag under \$1,000. Audio Technica was also showing its dynamic mic line as well as a line of wireless products.

EV updated its 635A ENG mic, calling it a 635N/D, and claiming it is now more indistructable than ever. It's also now available in camera-black finish. EV

package, like all Lectrosonics equipment, is built for the long haul.

Telex is introducing an affordable UHF wireless system. The FMR-450 can operate with up to 50 systems simultaneously, and features a diversity receiver, a new compandor design for a signal to noise ratio of greater than 110 dB. Their new handheld transmitter, the HT-200, uses a new antenna type to prevent hand interference. Its available with four different head configurations from Shure and EV.

NAB '94 show floor was not full of monitors. Very few companies displayed monitors. Of those who were, only a small handful were actually demonstrating them. The rest were just on display.

There were two hits of the show in the monitor category. One of these were the Alesis Monitor One. These monitors were very clean, portrayed a great stereo image and had unusually good low frequency response for a speaker size.

The other monitor hit was KRK's monitoring systems. Several sets of these monitors were at various vendor booths. The KRKs utilize what appears to be the focal tweeter (the guy in the booth didn't know), which is just about the cleanest sounding dynamic tweeter available. These models are reasonably priced for a quality monitor: \$1,000 per pair.

JBL Professional UREI discontinued its ubiquitous 4312A monitor meaning that after 20 some years of aural consistency. The models 4206, 4208 and 4412A were on display. JBL also had only one pair of mini-monitors hooked up.

Electro Voice displayed about six different monitors, including the Sentry series, and a couple of new monitors—the S-40 compact. This is a pretty good little speaker, and is small enough to sit on your test bench or mount in your remote van. Mounting brackets are an optional extra.

Wohler offered some interesting monitors: the rackmountable Models AMP-1A and AMP-2. Sound real good, too. The Wohler folks were actually sending audio through them. They come with balanced inputs through XLR connectors, offer options like transformer input, headphone out, multiple switchable inputs and would work great in the rack room, tape editing station or remote van.

TRUE BLUE FOR THE VIEWS.



Talk radio pros expect the unexpected, but there's one thing they can always depend on—the reliability of true blue.

audiopak
BROADCAST CARTRIDGES

P.O. Box 3100 • Winchester, VA 22601
Tel: (800) 522-CART or (703) 667-8125
Fax: (703) 667-6379

“The thing is just impossible to screw up! The DM-80’s non-destructive editing is the only way to go, and revisions are extremely easy and very quick!”

—David Esch, Director of
Commercial Production
WPNT, Chicago

“We looked at DAWs for a year—no other product could even come close to the DM-80’s price/performance ratio.”

—Bill Robinson,
Production Director
WQCD N.Y., NY

“I love this machine! It’s reliable, and user friendly. I can edit in 1/3 the time, and I wasn’t familiar with disk recorders—the DM-80 is easy to learn and use.”

—Michael Cook,
Program Director
KSJJ/KPRB, Redmond, OR

Broadcast professionals speak out about the DM-80 Digital Audio Workstation!

“I’ve been editing on tape half my life, and was hesitant to give up “rocking the reels”—but I found this machine is incredibly easy to edit with. And its expandable storage put it way ahead of the competitors we compared.”

—George Zahn,
Operations Director
WVXU, Cincinnati

“We universally love our DM-80’s! They have revolutionized the way we work here and we have made it a point to spread this word to other public radio stations.”

—Richard Paul
Special Projects Engineer
WAMU-FM, Washington, DC

“The DM-80 does more than DAWs costing twice as much. It’s very rugged—you can set it up and forget about it. And it’s easy to use.”

—Tony Diggs,
Chief Engineer
WKHK Richmond, VA

“It’s like a digital studio in your lap! The DM-80 is a very affordable, portable, high quality digital editing system.”

—Howard Silberberg,
Sound Engineer
United Nations Radio
N.Y., NY

“The DM-80 is a great production tool—it really changed our sound! I like its fast and easy editing capabilities.”

—Mike Britton,
Production Director
KODY/KXNP, North Platte, NE

“We originally chose the DM-80 because of its user friendliness. Then we discovered the real magic of this device: a promo announcement that normally would take 4 hours can be done in 30 minutes.”

—Tom Collins,
International College of
Broadcasting & Recording, Dayton

“The DM-80 is easy to learn, and once learned...it’s fast, very fast! We also like its clean digital sound.”

—Barry Witherspoon
Program Director
WSTO-FM, Evansville, IN

We couldn't say it any better.

Call (213) 685-5141, Ext. 337, or FAX (213) 722-0911 for more information about the DM-80 Digital Audio Workstation for the magic of hard disk recording and random access editing at your fingertips.



Products & Services Showcase

For more information on the products shown below, circle the appropriate Reader Service No. (s) on the enclosed Subscription/Reader Service card or contact the advertiser directly.

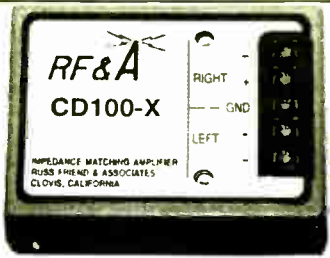

CD100 • X Compact Disc Adapter-Amplifier

Matches any consumer compact disc player or cassette deck to broadcast console input. Only \$99.00 FOB factory or from any broadcast dealer.

Russ Friend & Associates

342 N. Sunnyside
Clovis, CA 93611

Phone 209-298-6838 FAX 209-298-8270

Turntable Parts/Felts
Russco, Collins TT-200, Sparta

READER SERVICE NO. 158

Digital Dream System \$9,995.00!



Just \$9,995.00 for this dual digital audio Satellite control with Production system. You get two powerful 486SX-25 computers, VGA color monitors and 535 meg hard disk (9+ hours mono storage). LAN and DMX-4 audio switcher. Includes interface and control hardware. Nothing else is required! This pricing is good for a limited time.

- Great Sound: Premium apt-NTM audio card standard
- Simultaneous record/play for *time shift* P13R recording
- Separate Production room system with LAN net connect to Control for complete backup & safety.
- Satellite system handles all standard formats
- CD system option from \$1,500 uses Pioneer single or triple 6 packs or 300 disc jukeboxes
- Live assist included, ready for Traffic & Music interfaces
- Many options: External button boxes, more audio & I/O

The Management

1-800-334-7823 1-817-625-9761 FAX: 817-634-9741
P.O. Box 1-36457 Ft. Worth, TX. 76136
1600+ Stations - Our 13th year

* Extra charge for combined Satellite & CD systems. No holds or splits, larger hard drives available at extra cost.

READER SERVICE NO. 2

EQUIPMENT FINANCING

MARTIN LEASING CO.

FIXED RATE
LONG TERMS

UPGRADES
TRANSMITTERS
ANTENNAS
DIGITAL EQ.
AUTOMATION
STUDIO EQ.

- 1-Page Credit Application
- New or Used Equipment
- \$5,000-\$2,500,000
- 100% Financing—No Down Payment
- Conserves Bank Lines
- Under \$50,000—No Financials Required
- Nationwide Funding
- Refinancing Available
- Other Equipment, Too!

QUICK RESPONSE 24-48 HOURS

BEN WEINGARTEN

1-800-253-2734 EXT. 22

TEL: (310) 274-7988 FAX: (310) 274-1905

THE BROADCASTING EQUIPMENT SPECIALIST

READER SERVICE NO. 21

WHY PAY MORE FOR LESS?

PRISTINE INCLUDES EVERYTHING YOU NEED AT ONE LOW PRICE, INCLUDING REDUNDANT SYSTEMS!

PRISTINE CD DIGITAL AUTOMATION SYSTEM including: 2 heavy duty 486/33/DX computers • 8+ hours of Dolby AC-2 stereo hard disk audio • music scheduling system • traffic system interface • digital editing package • 8 Pioneer TM-3 CD Players • CD audio mixer & amp • installation & training • leasing available

Pristine SYSTEMS \$18,995
INCORPORATED

Distributed Nationally by
PROFESSIONAL MANAGEMENT SERVICES, INC.
803/370-2400 • FAX 803/370-2314
INTERNATIONAL 310/670-7500 • FAX 310/670-0133

READER SERVICE NO. 8

ARE YOU LOOKING FOR A COST EFFECTIVE ALTERNATIVE TO MANUFACTURER SERVICE?

SERVICE, REPAIR & CALIBRATION

- STL's • RPU's • TSL's
- Exciters • AM/FM
- Broadcast Monitors •
- Remote Control Systems

SPECIALIZING IN EQUIPMENT BY

- Belar • Marti •
- Moseley • McMartin
- TFT • And others...

> An authorized <
TFT service center

IN CASE OF EMERGENCY

We can help get you back on the air with our STL Loaner Program. We have STL's available that will be set to your frequency prior to shipping. We also provide over-the-phone technical assistance.



2198 Hubbard Lane, Grants Pass, OR 97527

(503) 471-2262

READER SERVICE NO. 9



ZEPHYRUS

Quality, service, delivery, and reliability have come to SCPC

The Zephyrus 300 family of satellite subcarrier receivers is trusted by thousands of broadcasters. Carrying on the tradition of excellence (at a fair price) is our 700 series analog SCPC line. Entry of all operating frequencies is done on a front-panel keypad. "Old fashioned" meters monitor RF and audio levels.

ZEPHYRUS ELECTRONICS, Ltd.

171 S. 122 E. Ave, Tulsa, OK 74128
918-437-3333 Fax 918-438-7322

READER SERVICE NO. 51

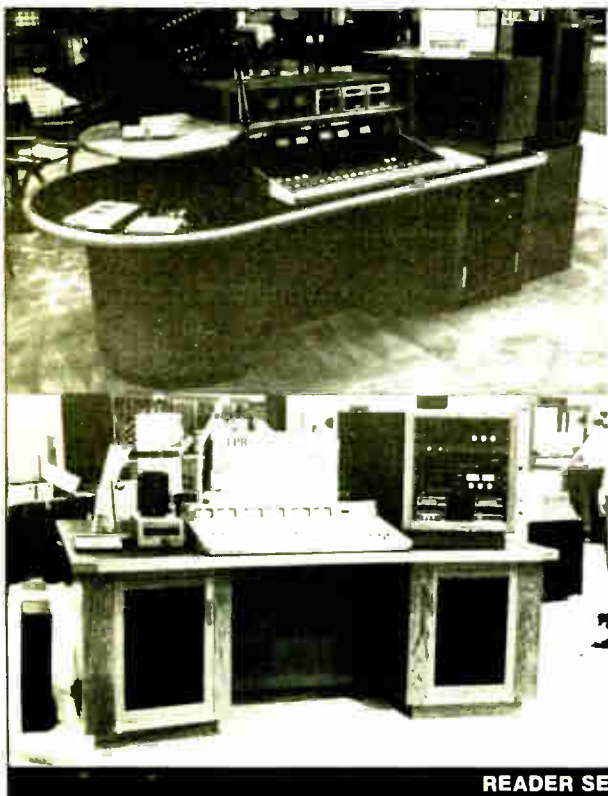

NAB Show Furniture

Available NOW at discounted prices.

For information and pricing, call:

Tel: 800-676-0216

Fax: 215-640-5880

STUDIO
TECHNOLOGY

4 Pennsylvania Ave, Malvern, PA 19355

READER SERVICE NO. 23

Attention Advertisers

Reach 22,000+ broadcast equipment buying prospects at AM, FM and AM/FM radio stations, networks and groups, recording studios, engineering and consulting firms every month.

Products & Services Showcase appears monthly in Radio World.

To advertise your product or service, contact Simone Mullins at

RADIO WORLD

P.O. Box 1214
Falls Church, Va 22041 USA

Tel: 1-800-336-3045

FAX: 703-998-2966

RF GEAR

RF Gear Provides Users With Economy and Value

by T. Carter Ross

LAS VEGAS In RF gear the words most manufacturers used were the ones broadcasters wanted to hear: "value," "economy" and "efficiency."

While new solid state and digital products were on the floor, there were several new tube-based transmitters as well. And while there were no massive steps forward in RF technology, manufacturers were reporting heavy interest from both domestic and international broadcasters in their products.

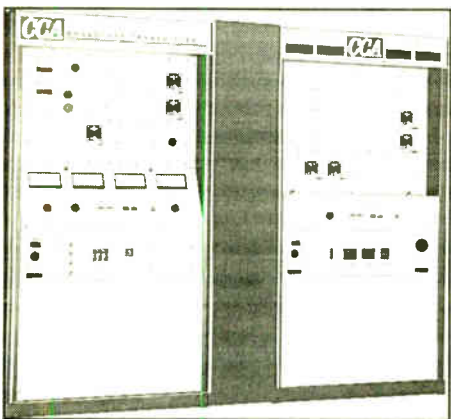

CCA displayed a variety of transmitters during the NAB show this year.

ments. It is packaged with a Quantum 300E exciter/driver that is specifically designed for the needs of a high power solid state transmitter.

The QEI 675B advanced technology FM exciter was also introduced at NAB. Making use of ultra-linear frequency modulated oscillator (FISO) technology, the 675B is an all solid state on carrier direct FM phase locked, frequency synthesized exciter.

Also showing a new solid state unit was CCA. The FM 1000UA solid state 1,000 W FM broadcast transmitter employs two independent power amplifiers with the power combined in an external, rack-mounted cabinet. Output power is continuously variable from 500 to 1,100 W. Construction of the unit is modular for most major subassemblies for ease of maintenance.

Also on display at CCA's booth were FM 60G high-performance 60 MF exciters and CCA's established lines of AM, FM and shortwave transmitters.

Continental Electronics brought a prototype of its new 317D 50 kW solid state AM transmitter to NAB '94. It is expected to be ready for shipping soon, and the first installation is planned for a station in Dallas. Also new to Las Vegas was Continental's 816R 30 kW FM transmitter. It is similar to Continental's established line of transmitters with many identical components and was first introduced at the 1993 Fall Radio show. Nearly a dozen 816R units have been shipped and are in use in the field.

With an interesting product that gleaned it a "Cool Stuff Award" from RW, **Crown Broadcast International** showed its FM100 and FM200 transmitters. Designed as a "radio station in a box" the FM100 and FM200 package an exciter, solid state transmitter, processor and stereo generator all into a single compact unit.

In addition to its established lines of AM and FM solid state transmitters, **Nautel** demonstrated the prototype of its NE50 digital FM exciter. The exciter uses direct digital synthesis to generate the modulated FM carrier. Nautel anticipates to be shipping units late in the fall.

Broadcast Electronics Inc. (BE) released the new 3 kW FM-3C transmitter, based on the same technology as the FM-1C 1 kW transmitter. The FM-3C uses the latest switch-mode power supply technology, providing a broader power output range, greater efficiency. It also protects RF devices from AC line surges and spikes. VSWR foldback allows operation into 3:1. BE also displayed its established AM and FM transmitters.

Bext introduced a new option for its HPT series of exciter/transmitter/translator/boosters. The HR option yields a unit that receives signals even in the presence of a very strong adjacent channel, even if co-located. Also, every HPT unit now comes standard with what used to be the HS option for increased sensitivity.

Bext also introduced the SF Series of solid state MOSFET FM amplifiers, from 100 to 1,000 W nominal output and the LEX 25 programmable FM exciter, with continuously variable output power from 0 to 25 W. Both units are designed for quality performance at a "no frills" price.

Also showing established products were **LPB** with its line of low-powered AM

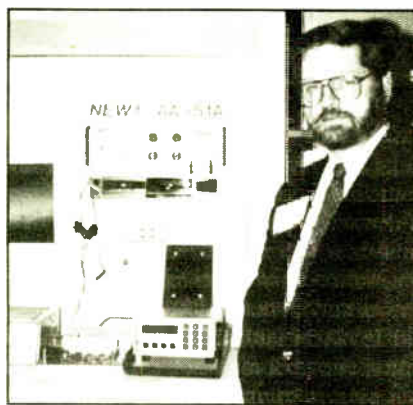

Automated audio equipment testing moves a step ahead with the AA-51A Audio Analyzer from **Potomac Instruments**, Silver Spring, Md. It automatically adjusts the tuning and settings for many of the most common test measurements.

Among the tests that are made quicker, easier and offer more accurate are harmonic distortion at many different frequencies or power levels; intermodulation distortion; frequency response; wow and flutter from tape machines and turntables, and stereo phase errors and differential gain.

The AA-51A, shown here by Guy Berry, is equipped with ample shield-



ing to insure accurate readings in areas with high levels of RF radiation, including broadcast transmitter sites.

For more information, circle **Reader Service 207**.

The Assistant Chief stereo signal generator, which was demonstrated in the Potomac Instruments booth operating together with the AA-51A audio analyzer (see photo) is expected for third-quarter release from **Burk Technologies**, Pepperell, Mass.

An engineer at the station transmitter site can use a touch tone phone to access and control an Assistant Chief hooked up to studio equipment. He can use the system to check and adjust frequency response, distortion, noise and stereo of studio equipment.

The system can also be used with remote microwave, satellite cable TV and studio-to-transmitter links. For more information, circle **Reader Service 103**.

transmitters and **Larcan-TTC Inc.** with TTC's line of solid state FM transmitters. **Omnitronix Inc.** showed its line of solid state AM transmitters that include built-in C-QUAM stereo.

Delta Electronics showed its ASE-2 AM stereo exciter for adding C-QUAM stereo broadcasts to AM programming.

Despite the number of new solid state products on display, transmitter tube manufacturers and rebuilders were a strong presence at NAB.

Svetlana Electron Devices more than doubled the number of products in its line between NAB '93 and this year. On display were a new line of high-gain, zero-bias triodes, and a number of popular tetrodes also made a debut at the show.

Varian Associates Inc. introduced a new Eimac 4CM100000A tetrode suit-

able for 100 kW shortwave transmitters. Also on display were multi-phase cooled 4CM300000GA and 4CM50000G power tetrodes.

Also showing transmitter tubes this year were **Thomson Tubes**, **EEV** and **Penta Laboratories**. **Econco** displayed its rebuilt power tubes.

The prototype of a digital calorimeter made its debut at **Altronic Research's** booth. It is air-cooled, but leaves open the option of water cooling, has a touchscreen and can be remote controlled. Altronic hopes to have models ready for sale within three months.

Kintronic Labs and **Bird Electronic Corp.** also showed dummy loads.

Superior Electric displayed its WHC Series of Stabiline power conditioners—

continued on page 46 ▶

Shortwave Success

COVERAGE and CLARITY. More than in any other segment of our industry, these factors are *vital* in international shortwave broadcasting. Forget major-market catch-phrases like "transparency" and "competitive loudness," *you've got to be heard and understood.* Your reception fringe area *is* your market, and intelligibility without distortion is your key to success.

Developed to implement the U.S. "NRSC" transmission standard, Inovonics' Model 222 is now available in several different versions to satisfy the regional needs of every shortwave broadcaster. Asymmetrical limiting, a sharp low-pass filtering function and "adaptive" pre-emphasis yield a program signal shaped for maximum "reach."

Contact your local distributor, or write, FAX or call us for full details on this surprisingly inexpensive answer to shortwave transmission improvement.

Inovonics, Inc.
 1305 FAIR AVE., SANTA CRUZ, CA 95060
 TEL: (408) 458-0552 FAX: (408) 458-0554

PROCESSING

Processing Boxes Unveiled at NAB

by Ed Bukont

LAS VEGAS For audio processing products, NAB 1994 was about reality. The emphasis was on taking present technologies and making useful and affordable products that are needed today.

Many manufacturers displayed refined or upgraded, rather than replacement versions of their existing product line. Standardization of operation, connection, and performance

Radio hall, displayed "exit signs" noting their participation in the Open Media Framework (OMF).

While recognizing the widespread acceptance of the AES/EBU serial digital audio format, analog inputs and outputs are not dead yet but are often ignored. When one considers the amount of harmonic, EMI and RFI generating devices that share power and ground conductors, located in close proximity to each other and often using direct cou-

Differential inputs, using less than a handful of extra components and the 1/4-inch plug already present on many semi-pro devices are an inexpensive enhancement that adds to the value and utility of a product while keeping it compatible with all analog output standards. To be truly professional, the device should have differential inputs that will allow it to operate in areas with noisy electrical and ground systems and over cable runs longer than 15 feet which is about the practical length for unbalanced audio. It has been an unfortunate trend that while incor-

porating quantum leaps in digital technology and 18bit DAC chips sets for better audio quality, the basics of analog I/O continue to be ignored. In the short time that digital devices have proliferated, the industry has moved toward balanced data channels such as RS-422 or 485 because unbalanced dig-

ital audio and control data, such as RS-232, like unbalanced analog audio, is easily corrupted by inductive noise pickup and ground loops even in small systems. If manufacturers can understand the need for and provide balanced data channels, why is there still a reluctance to provide differential (active balanced) audio inputs. Even high-end consumer gear offers such "luxuries" as standard items today.

Proof that professional quality doesn't start at \$2,000 was delivered by three companies who continue to address analog needs.

Aphex Systems provided a fine example of the general theme on the floor in the Model 106 Easyrider audio compressor. In one rack unit, for under \$450, you get FOUR channels of intelligent level control with the high quality and performance for which Aphex is legendary. Even in fast mode, where one might expect to trade audio performance for accurate level control, there is no such tradeoff. Also introduced at a similar price was the four channel Model 105 Logic Assisted Gate (single channel version available for the 9000 series mainframe). All items are line level, balanced in, unbalanced out and are built with typical Aphex ruggedness and aesthetic treatment. Additional

continued on page 48 ►



Neutrik USA, the Lakewood, N.J., subsidiary of the European-owned Neutrik AG, is offering a combination three-pole female XLR/quarter-inch phone jack receptacle for broadcast studios and live concerts.

The product, shown here by William Dorman, is designed to save time, space, labor and cost by cutting down on the



number of input receptacles needed in a studio setting. Many consoles come with two input XLRs and a phone jack, but usually only one of the jacks can be used at one time.

The receptacle features low capacitance ($\leq 3\text{pF}$ for the XLR; $\leq 5\text{pF}$ for the jack) for potential digital audio transmission applications, the company says.

The receptacle is available in nonswitching mono and stereo and switching stereo jack versions. For more information, circle **Reader Service 30**.

were common themes on the floor. Digital technology offerings displayed more function and recognition of user needs than has been typical in the past.

Multimedia World, however, concentrated on video and audio post-production and distribution products. This may signal a separation between the heavy-duty multichannel audio and video recording aspects, displayed in the Radio/TV halls and the necessary technologies for Multimedia post-production/editing/mastering. Several manufacturers, including a handful in the

pled technology, a bit of editorial criticism is in order here. Through digital technology, many products incorporate a wealth of effects and functions to enhance the user's technical options and create an ostensibly "professional" product. Many products, by some of the industry's giants, offer those features at an attractive price which too often is also the justification for using semi-pro audio connections. It is disappointing to see unbalanced, rather than differential inputs, being offered as a "professional" product.

plated technology, a bit of editorial criticism is in order here. Through digital technology, many products incorporate a wealth of effects and functions to enhance the user's technical options and create an ostensibly "professional" product. Many products, by some of the industry's giants, offer those features at an attractive price which too often is also the justification for using semi-pro audio connections. It is disappointing to see unbalanced, rather than differential inputs, being offered as a "professional" product.



Audion Laboratories, Bainbridge Island, Wash., introduced the VoxPro™ digital editing workstation, which records, edits and plays back audio with a fraction of the time and difficulty of reel-to-reel tape machines and analog editing equipment (such as razor blades).

VoxPro, shown here with Michael and Charlie Brown, is easy to use because its commands and functions are similar to those of a familiar PC or word processor.

Among the system's more imaginative features, "visible sound" allows a sound editor to see a color-coded representation of sound waves during the editing process. The "bleep" feature highlights inappropriate words on the screen and automatically places a bleep over them with the touch of a button.

For more information, circle **Reader Service 69**.

Accessible RF Equipment

► continued from page 45

fast acting, fully isolated power conditioners for sensitive loads. Superior is also aiming to build up its export market, a goal aided by the increased number of international visitors to this year's show.

dataworld Inc. demonstrated its global communications mapping, database and information services.

International manufacturers also made a strong showing at this year's NAB.

The Italian company **Itelco** made its first foray into the American radio market this year. Using the same platform as its T254 and T225 FM transmitters, the T242 combines a transmitter and exciter into a single box with optional built in RDS and stereo coding for a compact 250 W unit. Although new to the U.S. market, Itelco transmitters are used in many networks around the world, including Radio Monte Carlo in Monaco.

Marconi, based in Chelmsford, England, showed for the first time in the U.S. its line of low-powered solid state FM transmitters. The Marconi Eddystone B6600 Series was introduced at the Montreux TV show last year, and are available in 300 to 2,000 W models.

The Paris-based **Thomcast**, the result of a merger between Thomson-CSF and ABB, showed its range of AM, FM, short-wave, medium wave and long wave transmitters.

Italian transmitter

Elenos S.R.L., headquartered in Italy, showed its line of FM exciters and transmitters as well as FM power amplifiers.

The Barcelona-based **Link Comunicaciones S.A.** showed its new automatic emergency transmitter. The CSSC (compact solid state cavity) reserve transmitter requires an external antenna, and is available in 200, 400 and 600 W models. The "survey receiver" section of the transmitter constantly

monitors the broadcast center, and the reserve transmitter begins automatically broadcasting if the transmission is interrupted.

Aquila Broadcasting Services (ABS), a Spanish transmitter manufacturer, displayed its line of FM transmitters. Also based in Spain, but with distribution headquarters in Miami, is **O.M.B.**, which introduced a new portable 10 W FM transmitter.

The Italian company **DB Elettronica Telecom** displayed its line of FM broadcast transmitters, exciters, translators and amplifiers, as did **CTE International**.

In the RDS/RBDS field, **Inovonics** showed a prototype of its encoder and decoder. While a street date for the encoder has not yet been set, the decoder will be out by year's end.

One interesting piece is the **Moseley Starlink 9000**, not only is it a digital STL, an audio processor and an audio generator, it also includes RBDS and/or SCA generation among its capabilities.

Circuit Research Labs (CRL) showed its SC-100, which allows a station to add RBDS or SCA broadcasts without a PC. A front panel ASCII keyboard and an easy-to-use menu system program messages once the SC-100 is connected between the input of an exciter and the output of a stereo generator.

Modulation Sciences (MSI) showed both the PRD-3000 Precision RBDS Decoder, which uses a regular RBDS-compatible receiver and PC to analyze the content of any station's RBDS content, and its Data Sidekick data subcarrier broadcast system. MSI also plans to introduce soon an RBDS data receiver.

Also showing RDS encoding and decoding equipment were **RE America** and **Rhode & Schwarz**. **BE** showed its RBDS management system, and **Coupon Radio** was present, making the case for broadcasters to take full advantage of the opportunities RBDS/RDS present.

Need a New Digital Satellite Receiver for DATS/"SEDAT"?

New DATS 7.5/15? New 3.5 Voice Cue? "SEDAT" Cards? We are shipping now! We can even convert your S/A 7300/7325!

Zephyrus for JSA Zephyrus 700 SCPC

We Repair & Rebuild all Popular Receivers Quick Service! 24 Hour Tech Support

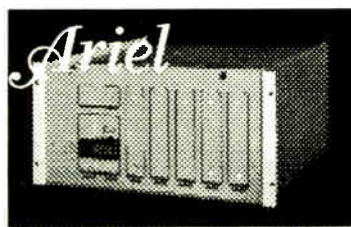

Fairchild Dart Compatible LNB-Type

Satellite Systems

(719) 634-6319

"SEDAT" is a Trademark of Scientific-Atlanta, Inc.

DXers Club Developed Audio Mag

► continued from page 22
made the first tape. Vobbe knew two blind disc jockeys who were also DXers.

"These two fellows had been members of the National Radio Club for quite a while and they both had wives that could see, so they could read "DX News" to them," Chatherton said. "But they once mentioned to Fred, 'You know, it's too bad you can't do something for those others that can't see.' The idea started from there."

Wide following

The instantly favorable response to the audio magazine revealed just how popular DXing was among the blind. "I think DXing is a hobby that a lot of the blind people have taken up because it's the sort of thing they can do on their own," Chatherton said.

Most blind DX hobbyists purchase tactile radios, or radios marked in braille to indicate frequencies and volume control.

"We have a convention every year over Labor Day, and we're beginning to now get five or six of our blind members every year," he said.

A surprisingly large 25 percent of the

The instantly favorable response to the audio magazine revealed just how popular DXing was among the blind.

200 audio magazine subscribers are not blind. Portions of the show are sometimes heard on international shortwave or on SCA reading services for the blind.

Will National Radio Club's audio magazine ever seek a frequency of its own? Probably not, Chatherton said. "I see it changing, like there's been changes in the hobby over the last 60 years, but I see it staying simply the voice of the hobby."

But NRC is expanding its audio products in other directions. It has begun offering an annual "After Dark" series of tapes as a compilation and addendum to the audio magazine. The four-tape series features interviews with a wide range of significant figures in radio history, from Wolfman Jack to Leonard Kahn.

□□□

To find out more about the National Radio Club's monthly DX audio magazine or its annual "After Dark" series, write: National Radio Club, Publications Center, P.O. Box 164, Mannsville, NY 13661.

Dee McVicker is a free-lance writer and regular contributor to RW. She can be reached at 602-545-7363.



Desktop sound editing for the newsroom and other on-air applications is made easy with the DAVE-2000 Series II Digital Audio Voice Editor from **Videoequip Research Ltd.**, Scarborough, Ont.

DAVE-2000, shown here by Dave Tomiszser, is a circuit board that fits into IBM PC 286 or higher. Analog or digital audio input is stored on the PC hard drive, manipulated and reassembled before transfer to another audio medium.

A minute of digital audio requires about two megabytes on the hard drive.

Local area networks of DAVE-2000 computers can be configured to allow for multiple users. A playlist program allows for immediate playback of audio segments in any desired order.

For more information, circle **Reader Service 162**.



Hard Disk Recording Doesn't Have To Be Hard On Your Wallet.

"...in a price/performance comparison, the DR4d would be hard to beat. Thumbs up on this one." George Petersen, MIX Magazine



"...great sound, useful features, and friendly operation... sure to set a new standard in affordable recording" David Frangioni, EQ Magazine

"If you're a broadcast engineer.... the DR4d may seem like one of the greatest inventions in the history of audio." Geazy Yelten, Electronic Musician Magazine

If you're involved in production for radio, then you're aware of the increasing demand for digital audio quality. So your next multitrack recorder should be digital, but which format: tape or hard disk? You've heard about the great editing tricks offered by disk-based systems, but there's a problem.... don't all hard disk systems require expensive add-in hardware and software, to already expensive computers? Not anymore!

The DR4d is the solution for those looking for an alternative to expensive, complex computer-based systems, or the limitations and mechanical uncertainty of tape recorders. It offers a perfect combination of hard disk recording benefits with an easy-to-use interface.

The DR4d can record up to four tracks simultaneously to standard SCSI hard disks, either internal or external drives. An optional 213MB internal disk offers 40 track minutes of recording (44.1kHz) right out of the box. To expand your recording time, simply connect external drives to the DR4d's supplied SCSI port.

With standard tape machine-style controls the DR4d is by far the easiest hard disk recorder to operate, which means that you can get to work immediately, rather than setting up and operating a computer system. Punch ins/outs can be performed manually or automatically from the front panel, or by footswitch, just like you'd expect.

Now you can start to take advantage of the power of random access editing. You can cut, copy, and paste sections of audio with ease. Our Jog/Shuttle wheel lets you scrub through the audio at various speeds, forwards or backwards. Try out different arrangements. Create perfect tracks by combining the best sections from multiple takes. Whatever. And you can edit with confidence, be-

cause if you change your mind you can instantly Undo your last edit - even after the power is turned off and on again! Imagine it. Do it. It's that simple.

Another DR4d advantage is not having to wait for tape to shuttle back and forth. You can instantly move to 108 memorized locations at the touch of a button, and these locate points may be entered manually or on-the-fly. It's also simple to set up seamlessly looping repeat sections, so it's easy to jam over tracks. No more wasting time on rewinding tape!

Of course, how the DR4d sounds is as important as how it works. Advanced 18-bit oversampling A/D and D/A converters insure crystal clear sound, and with a full 96dB dynamic range, the DR4d offers no-compromise specs. The four balanced 1/4" input and output jacks are switchable between -10 and +4 operation, and 2-channel digital I/O is included (XLR and RCA).

Backups can be made to a standard DAT machine.

Need more than four tracks? Four DR4d's can be linked to create a 16-track system. And for synchronization to other gear, just add the optional MIDI or SMPTE interfaces.

And best of all, the DR4d is an **affordable** reality: suggested list is only \$2495.00 (or \$1995.00 w/o hard disk)! Multitrack disk recording *is* within your reach! Please call or write for further information.

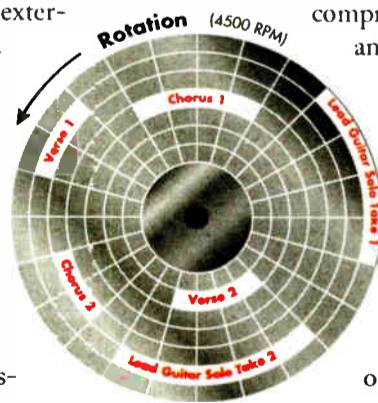

On a spinning hard disk, the various sections of music can be accessed almost instantaneously by the moving heads of the drive mechanism. This allows you to seamlessly output different parts in any order, with no time spent rewinding. Audio can be moved and rearranged in ways not possible with tape!



P.O. Box 2344 Ft. Worth, TX 76102
(817) 336-5114 Fax 870-1271

Circle (72) On Reader Service Card

Refinements in Processing

► continued from page 46

new products include the two channel Model 622 Logic Assisted Expander/Gate for more demanding applications and the Model 623 Mono Compellor/Aural Exciter. Try this unit for driving SCA generators or speech program circuits. Two units may be slaved for stereo operation.

Audio Technologies Inc. (ATI) has a well deserved reputation for building useful products that solve problems of interfacing and controlling audio systems. Their latest line, the NanoAmp series, brings those functions and performance within nearly everyone's reach in several small, light weight and affordable packages. Included so far are a 3x1 mic/line

mixer and four input expander, a bi-directional IIF/Pro level adaptor and uni-directional, 4 channel, IIF-to-Pro or Pro-to-IIF level adaptors. A particularly nice feature for accommodating network or large studio applications are "TRS" model versions with 1/4" TRS for I/O connect. Units use, and can share, an outboard power supply and offer several rack or desk mounting options. NanoAmp products range in price from \$210.-\$325.00 plus power supply and mount.

dbx, a division of **AKG**, has harnessed the team which brought you the **Orban** line of products to create highly versatile studio processing equipment of high quality and low price. The Project 1 Model 242

Parametric EQ offers five bands of equalization with boost/cut, frequency and bandwidth (Q) adjustments. The first and fifth bands offer shelving adjustments rather than Q. The 1 rack space unit has balanced TRS inputs and sells for under \$400.00.

Evolution, rather than replacement, and at a lower cost, was nicely demonstrated by **Eventide**, which has expanded in two directions its industry staple, the H3000 Harmonizer line of studio processors. The Dynamic Harmonizer versions include the H3000-D/SX Studio Dynamic Ultra-Harmonizer which offers many of the features found in their legendary Ultra-Harmonizer products, as well as the new DFX package but at a cost of under \$2,000. MIDI interface, soft keys and a large backlit LCD display allow for ease

of use. The H-3000D/SE Studio Enhanced Dynamic Ultra-Harmonizer continues to provide analog type and exclusively digital effects found in the H3000SE functions plus Mod Factory presets and new presets for over 400 presets in all. An added feature is the speaker-based 3D spatial imaging program from Empirical Labs. Both items offer balanced analog I/O.

Symmetrix, also known for high quality analog products, displayed the newest member of the 600 series of digital processors is the Model 602 digital audio production processor that preserves the look and feel of the 601 Voice Processor. The unit features AES/EBU and analog I/O in a one rack space programmable stereo processor with gain, equalization and effects which may be stored in non-volatile memory.

The Symetrix 420 power amp, successor to the popular A-220 power amp was shown with front panel controls for level and tracking, speaker muting, and mono sum. Inputs remain balanced XLR or TRS.

Sony Professional Products provided something for everyone with new products in every audio category. Expanding the HR (half rack) line of products is the HR-MP5 MultiProcessor which features analog I/O, MIDI and remote interfaces in a stereo 18 bit, 48kHz sample rate processor. Unfortunately, despite being in the "professional audio" catalog, the MP5 has unbalanced audio I/O.

A good example of making digital user friendly while incorporating standard technology is the Digital Delivery System (DDS) from **Radio Systems**. Long known for making quality and function affordable, the RS folks have introduced a well researched approach to the replacement of analog carts and ease of operator use. Concentrating on the end result, Radio Systems' UNIX-based system provides the operator with cart-like convenience in a hard disk system that does not require another keyboard and monitor in the already cramped control room. This system is not intended to be an automation system but is rather a live assist system for those stations that want digital audio quality and convenience in an operator friendly system that won't clutter the control room and can integrate with existing equipment. Using individual control heads that approximate the look & feel of cartridge MACHINES, the operator can pre-program multiple events (audio cuts, external sources, CD's etc.) and then run them as desired. Each control head may operate one or more inputs and switcher outputs that can appear at your existing audio console, tape machine etc. and can integrate with the existing console logic. Sources can be sequenced within the system to appear at one output.

Perhaps because audio is a part of almost everything displayed on the floor, from Radio and TV to Multimedia and communications systems, there were a plethora of audio monitoring and quality control products displayed. **AEQ**, (Spain) displayed their AM-03 Self-amplified Stereo Audio Monitor. This balanced in, stereo, three-input device incorporates a 3-way speaker system with monaural woofer and mid/hi drivers for each channel. All in one rack space and a phase monitor made of an LED matrix that very nicely approximates a Lissajous pattern.

Getting those monitored signals around and to where they have to go, especially in complex places or beyond the studio, has been made easier but affordable. **Radio**

continued on page 50 ►

NEW DIGITAL CLARITY

Clarity Of Purpose: "Design and build an actual digital replacement for the analog cart machine utilizing individual, Magneto-Optical discs."

Clarity Of Design: "Meet operator needs in form, fit, and function. Minimize space requirements and maintenance. Maximize reliability and ease of operation."

Clarity Of Execution: "Familiar controls...no keyboards*, no touch screens, no hard drives, no operator training."

CLEAR, CLEAN, UNCOMPRESSED, UNCLUTTERED

AIR cart · mo™

- The clarity of 3.5 inch Magneto-Optical media
- Individual, affordable
- Clarity in operation, a true replacement for cart machines
- Linear, familiar and reliable
- Conforms to the ASPECT® standard
- Clearly superior

*Keyboard needed for production labeling



AIR corp SYSTEMS

• 1845 W. Hovey, Normal, IL 61761 • TEL: 309-454-4900 FAX: 309-452-0893

Okay, so your new FM processor finally arrives.

You install it. But now, no matter what you do, or how you adjust it, you can't get it to sound better than your old processor.

On some stuff, it actually sounds worse.

You Realize:

1. *"All-digital" doesn't always mean better performance.*
2. *There's more to a great processor than specs and reputation.*
3. *It might be too late to get your money back.*
4. *You should have purchased the Unity 2000i.*

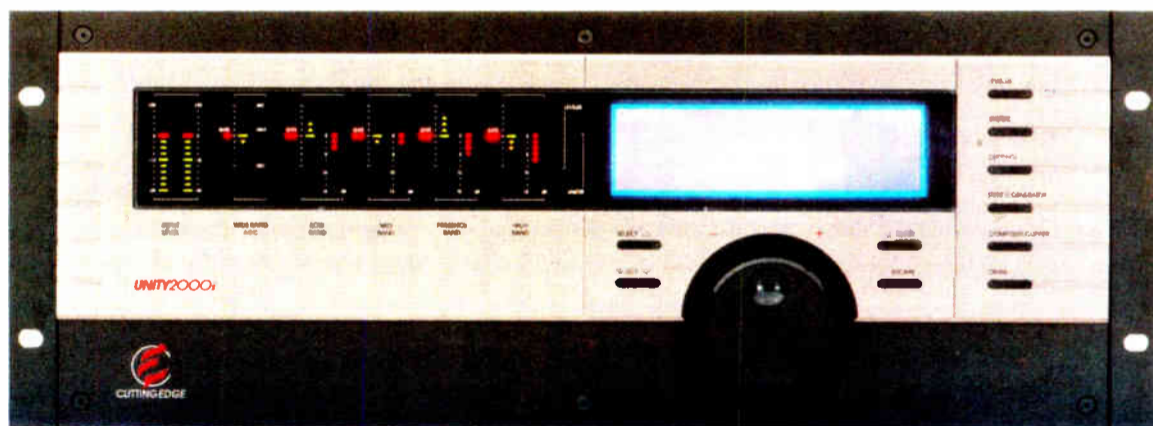

The Unity 2000i. The world's best sounding FM processor. Better sound, more listeners, bigger profits. That's what it's all about.



CUTTINGEDGE

2101 SUPERIOR AVENUE, CLEVELAND, OHIO 44114 • TEL: (216) 241-3343 • FAX: (216) 241-4103

Circle (218) On Reader Service Card

Processing Boxes Unveiled at NAB

► continued from page 48

Design Labs displayed five additions to its Stick-On series of audio and control devices for broadcast, studio and sound system requirements. Two products, the ST-RG1 Ramp Generator and RLC1 Remote Level Control, complement the existing ST-VCA1 Voltage Controlled Amplifier by allowing remote operation of the VCA module. In practice, the RLC1 touch panel is mounted in a switchplate type cutout and controls the RG1 Ramp Generator. The generator in turn provides a control voltage to the VCA and a tally voltage to operate a remote status LED. The Ramp Generator can control two VCA's for stereo operation. That VCA could control any line level audio signal such as might be selected by the new ST-SX4 four input, monaural audio switcher. Also new are two audio oscillators, the ST-OSC2A (1 kHz and 10 kHz) and OSC2B (100 Hz and 400 Hz). Look for new Rack-Up series and switcher products later this year.

Benchmark Media Systems always seems to have made one more neat little packaged product that can do many things. So it is with the "Jr. Audio Director Plus" which lets you independently select between eight sources which can feed either left, right, mono sum or stereo to the output. Mono summing options, a phase reversal (right channel) switch, level meters, headphone jack and controls for input and output gain are on the front panel. All this in a 1/2 wide, one space high rack mountable (w/adaptor) package for \$550. A particularly good use might be directing IFB to talent headphones when one person has to produce remote programming for several users such as might occur in network or duopoly radio.

OpAmp Labs, another problem solving company has a neat, cost effective product in their M9C interface that addresses a frequent analog concern in the midst of digital production. If you are in corporate video or multimedia production, you probably have found that no matter how many mics and cables you have, everyone on-location is using something different. The M9C allows you to input Mic or Line level on an XLR, RCA or phone

jack and, at the other end of the palm sized box, output Mic or Line level on an XLR, RCA or phone jack. The unit operates on a 9V battery for up to 30 hours.

A useful addition to your bag of tricks, which could follow the OpAmp Labs interface is the **FM Systems ALM771** Audio Level Master. This compact mono AGC device, with stereo strapping option, uses program dependent gating and loudness controls to prevent breathing and to cause the processing to provide a more natural effect on the audio being processed.

Cramming as many features as possible

The YDG2030 (Graphic) and YDP2006 (Parametric) are both stereo devices with balanced analog I/O connections and adjustable delayed output (up to 730ms) as may be required to compensate for audio for video sync problems or in large sound reinforcement timing applications. A wealth of digital control interfaces allow the units to be integrated into various computer based control systems either directly or through the Yamaha IFUY485 interface unit for converting RS-232 to Y485 control data. The Graphic unit features dual 30-band equalizers, four notch filters, HPF and LPF.

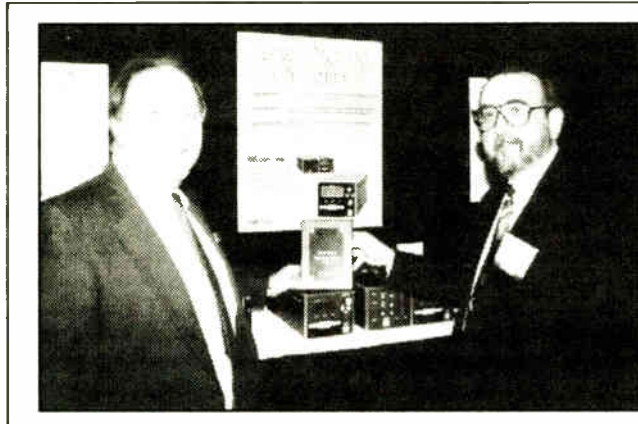

AIR Corp. Systems, Normal, Ill., offers high-quality digital audio, the convenience of 3.5-inch, 128-megabit magneto-optical disk storage and freedom from the possible headaches of data reduction with its AIR cart-mo™, shown here by Andy Rector and Jim Loupas.

A single disk holds 11 minutes of compressionless stereo with a frequency response of 5 Hz to 20 kHz +/- .5 dB when recorded at the standard rate of 48 kHz. Sampling may be adjusted down to 24 kHz for up to 22 minutes stereo and 44 minutes mono. AIR Corp. claims that both wow and flutter, as well as phase error at 15 kHz are unmeasurable.

For more information, circle **Reader Service 6**.

into a box, which means getting as many as functions as possible out of digital signal processing (DSP) chipsets was an option before, today it is a necessity. What one is ultimately trying to accomplish, as described by Geoff Mendenhall of **Harris Allied**, is to "...provide an analog type function to digitized audio data with software running on specially designed high speed microcomputer. Given a computer of appropriate size and the proper set of DSP chips, it should be possible to perform almost any complex analog function with additional function and precision that is unattainable with analog technology." (NAB 94 sessions) That is a good description of the task embodied in creating a digital equalizer system, as both **Yamaha** and **Klark Teknik (Mark IV Pro Audio Group)** demonstrated.

Yamaha, among its many products introduced at the show, demonstrated two very versatile digital equalizer products and a digital audio standards converter.

The parametric unit may be used as a stereo 6-band or mono 12-band equalizer with eight notch filters, HPF and LPF. The Yamaha FMC2 Digital Format Converter allows for two channel, TRI-directional conversion between AES/EBU, CD/DAT and Yamaha digital audio standards. External wordclock input and loophru are provided on BNC connectors.

Klark Teknik's DN3600 equalizer really put Mendenhall's thoughts to the drawing board. This system, which can work in automatic cooperation with the DN60 Real Time analyzer, incorporates selectable algorithms whose responses are modeled on the highly regarded Klark Teknik DN360 and DN 27 analog products. The unit allows for 66 presets of two channels of 30-band equalization with variable frequency low pass, high pass and two variable frequency notch filters. The large LCD display provides various displays that mimic analog equal-

Optimod 8100. Glenn Clark, who designed the original TEXAR Audio Prism has a new multiband product in the works that is currently being beta-tested. From the Washington, D.C. market comes The Purple Processor, a replacement product for cards 3/4/5 in the Optimod 8100 which has undergone beta testing and is ready to ship. The processor uses dbx VCAs in a four band processor with a front end broadband AGC. Final agreements are pending with a major broadcast equipment dealer and shipment is expected later this spring at \$3,000.00 per system.

Orban (a division of AKG) and **Cutting Edge** (a division of **Telos**) both introduced remote control software for their on-air audio processors, the Optimod and the upgrade product Unity 2000i respectively. Cutting Edge also introduced the Unity AM for AM applications, which uses the same remote control software as the 2000i.

First class quality

First class performance

Incredible price! -- \$995*

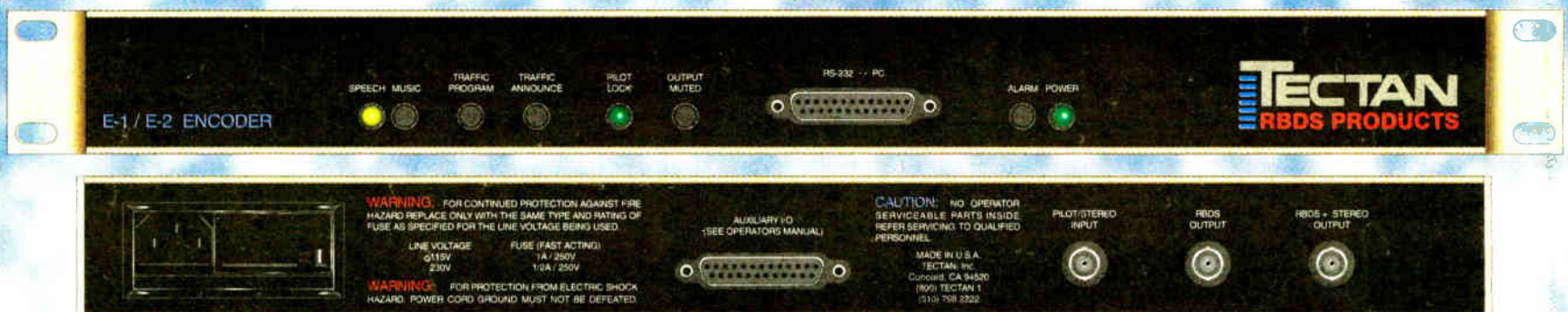

No-compromise RBDS just became affordable!
Phone 1-800-TECTAN-1 for details.

* Limited time introductory price for E-1 Encoder. Introductory price for the E-2 Encoder is \$1195. Shipping & handling \$25 additional for 2-day air shipment anywhere in the U.S.A.

CONSOLES

Consoles Packed with Wide Range of Options

by Nancy Reist

LAS VEGAS The consoles and mixers on display at the NAB this year were as varied as the broadcasters who examined them. A number of models feature digital capabilities. They provide broadcasters with the opportunity to run multiple digital systems in a central location with a familiar console.

Many of these boards also are capable of operating in a traditional analog setting as well. Flexibility and expendability were also prominent attributes of many of the consoles. Options both in module selection and module configuration allow broadcasters to purchase boards that meet their specific needs and modify them as those needs change.

Penny & Giles introduced the MM16 MIDI Management System, which provides 1,024 channels of programmable and assignable MIDI control in a compact unit. The MM16 features: transport and sequencer controls; the ability to enter data through either increment/decrement keys or a rapid response data wheel; 16 programmable keys, and 64 program memories which are accessed by 8 program select keys.

Perhaps the most unique feature on the MM16 is its bank of 16 "endless belt controllers," which can be individually assigned to different tasks.

Arrakis debuted several consoles which have the capability of operating alone or controlling their Gemini workstation software. The 1,200-5S and 1,200-10S are small low-cost boards which feature talkback, a mix-minus bus, opto-isolated remote starts, and switches which can access functions of the Gemini software. The higher-end 22000 console offers three-band EQ modules and an 8-bit data bus multiple workstation control. The 22000 also can be configured with "smart modules" which provide more sophisticated digital control.

Auditronics displayed a variety of on-air and production consoles. The new Destiny 2000 program management system and audio console is another example of the merger of the console and the hard disk system. The Destiny 2000 is designed to operate in either auto mode or live-assist mode and features and controls music and traffic log systems. It communicates with hard-disk audio computers, multideck CD jukeboxes, and satellite sources.

Graham-Patten's D/ESAM was on display both at its booth and as part of Harris Allied's demonstration digital radio station. This programmable digital mixer is designed like a video switcher and emphasizes audio for video capability, but its flexibility and high capacity are appropriate for radio as well. It features register memory to restore previous settings, multiband parametric equalization, audio delay, audio processing loops, and four independent output buses.

Studer's new C-Series audio mixing consoles emphasize flexibility and digital options. The consoles can be custom configured with a variety of stereo and mono input combinations, custom machine controls and intercom switches, customized connector panels and optional jackfields, and a selection of penthouse meter modules.

Soundcraft also provides many configuration options in its Series 30 Console, an on-air and production console making its United States debut. The Series 30 is fully modular and each module can be individually configured with options such as fader starts, cues, talkbacks and pfls. The signal path can be changed within individual modules as well. Effects units and patch bays also can be added to the board.

Soundcraft also introduced the Series 10S, a console designed for smaller radio studios. It comes with a choice of mic/line, stereo line/line, and telco inputs and is available in 12, 20, or 28 input frames. In addition, Soundcraft displayed its high-end Europa and Vienna II consoles, and the LMI, a portable 4 bus mixer.

Custom configuration also is an important aspect of **Wheatstone's** new A-6000 console. The console is designed with open architecture so each module can be plugged into any slot and is easily exchangeable. The input module on/off switches are user programmable to provide a variety of functions such as mute, timer, tally, and external machine control.

Four main output buses, four mix-minus buses, sealed switches, A/B select, and optional telephone, tape remote, intercom, and preselect modules are available. Also displayed were the A-300 and A-500 radio air consoles, and the MR-40, SP-5, and SP-6 production consoles.

AEQ introduced the BC-500, a modular console designed as a cost-effective alternative for local broadcasters. The standard configuration of four mono switchable mic/line input modules and six double line stereo input modules can be modified to meet the users specific requirements. The BC-500 also comes with an external telephone hybrid input/output module.

LPB displayed its new 7000 Series 12 and 18-channel stereo consoles. The con-

continued on page 52 ▶



The dB-CART from **Digital Broadcast Associates (DBA)**, Portland, Ore., records digital audio without data compression, but with user-friendliness equal to analog carts.

The dB-CART LC-128 conforms to the same standard used in AIR Corp.'s version and meets about the same performance levels with up to 20 kHz frequency response and 10 minutes of stereo audio at 48 kHz sampling.

DBA also offers the VL-128, a lower-end, more affordable version of the dB-CART. It records as much as 15 minutes of FM-quality (15 kHz frequency response) digital audio at 32 kHz sampling.

Jeff DeBry is shown here with the dB-CART. For more information, circle **Reader Service 52**.

LISTEN TO WHAT SOME OF OUR CUSTOMERS ARE SAYING ABOUT THEIR CCA TRANSMITTER...

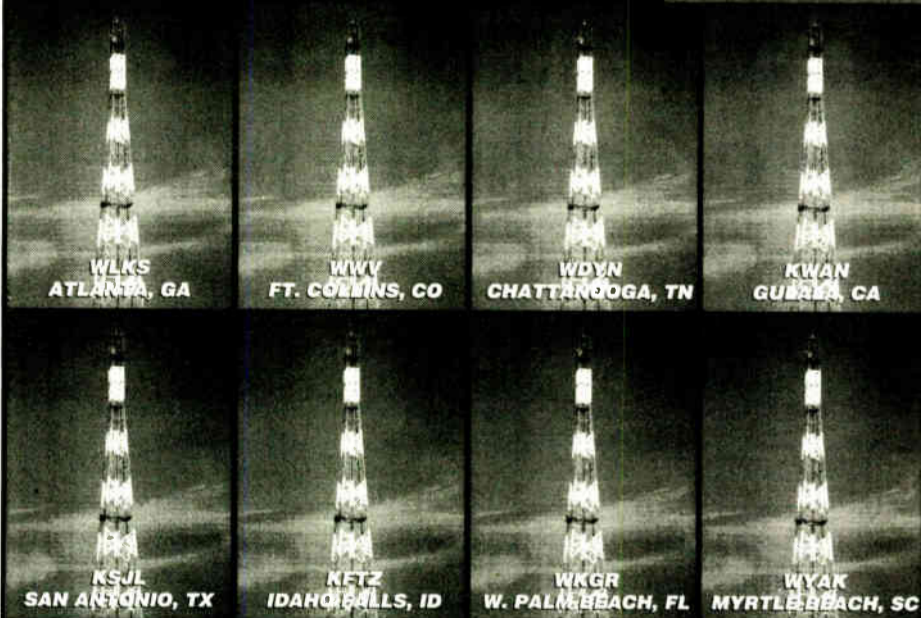

ENOUGH SAID?

CCA Electronics, Inc.

P.O. Box 426 • 360 Bohannon Road
Fairburn, Georgia 30213 USA
(404) 964 3530 • FAX: (404) 964-2222
24 hour service, 365 days-a-year.

CCA

Does Your MX5050 BII or MKIII* need a lift?

OTARI FACTORY SPECIAL!!!

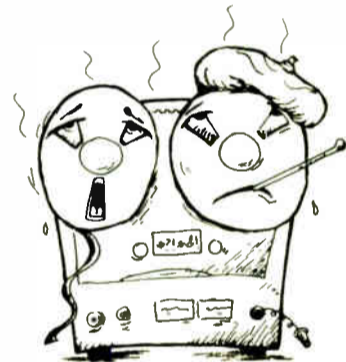

Get It Refurbished & Add Some Life To It!

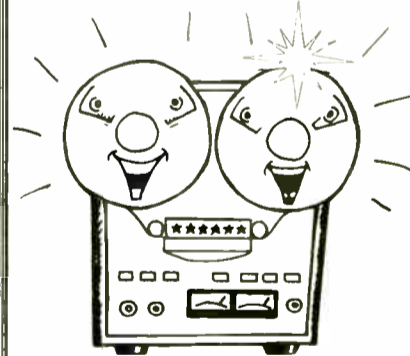

2-Track Tape Decks

Just **\$999⁰⁰**

- 6 MONTH WARRANTY!
- New Head Assembly
- New Capstan Motor
- New Relays and Rollers
- New Brake Drums and Bands
- ...and more!

Call us at 415-341-9504.
But HURRY, because this offer ends July 1, 1994.

*Call us about other models.

Consoles Packed with Enhancements

► continued from page 51

soles have a unitary front panel with modular electronics. They come with two inputs per channel, two selectable VU meters, talkback, a timer controlled by channel on/off switches, three stereo output buses, and one standard and two optional mono-mixdown plug-ins.

LPB's Signature III series also was shown. It uses rotary faders and comes in a variety of input and output combinations.

Last year, Sony introduced a prototype of its DMX-B4000 series of digital audio mixers. Now they are in production. Sony showed the DMX-B4008 which comes with a 16 X 8 input switching matrix and 8 input stereo faders. The console features internal digital signal processing at 32-bit resolution and selectable sampling frequencies of 44.056, 44.1 or 48 kHz.

The processing includes high and low fixed filters, phase invert, three-band equalization, panpots, auxiliary levels and input trims. It can be programmed for each operator and is controlled with a touch screen. The programming also comes with three password-controlled security access

levels. The DMX-B4016 version comes with 16 stereo input faders and can be upgraded to 24. Sony also showed its multitrack digital mixer series, DMX-S6000.

Pacific Recorders & Engineering blends the workstation and the console with their ADX mixstation. The programmable console features moving fader automation, snapshot automation, 8 analog inputs and outputs, and two 8-character alpha-numeric readouts above each fader. It can be installed into Pacific Recorder's ABX or Productionmixer consoles.

Logitek Electronic Systems demonstrated some new digital options for its Mariner Audio Mixing Console. The Mariner features digitally controlled analog faders, waterproof switches, and opto-isolated remote starts. It now has the option of a RS-232 serial interface which facilitates automated and live-assist operation. A 24-character lighted LCD display can provide information such as program titles, run times, and which module is scheduled to fire next.

Fidelipac introduced a new mic EQ module for its Dynamax MXE console.

The five-band module also features a pan pot for mic placement. The MX Series includes low-cost consoles equipped with six to 12 rotary (MXR) or linear (MXL) faders. The MXE console is more compact version of the MXL and permits 10 to 18 linear faders. Each input module in the MX Series console has two inputs with independent level controls and remote start. Fidelipac's Broadcast Audio Series IV Consoles also were displayed.

Audio Technologies Inc. presented the Vanguard series of consoles. These self-shielding consoles are designed to be compact and easy to operate and repair. They feature completely sealed switches, replaceable faders, and VCA level controls. Dual mix-minus telephone adapters, remote control switches, speaker muting and tally light relays also are available.

Solid State Logic's SL 8000 GB on-air production console was displayed for the second year. The console provides master status switching between broadcast, record, and remix operation modes. The console also features a range of custom options.



The new Model 106 Easyrider™ four-channel compressor from **Aphex Systems**, Sun Valley, Calif., maintains especially clean audio paths, the company says, because of its proprietary built-in VCA 1001 voltage-controlled attenuator and special "smart" circuitry. Easyrider's circuitry makes the unit



user-friendly and easy to set up. It is also designed to attack flaws in an input signal or release characteristics to improve the signal.

The compressor, shown here with Chrissie McDaniel, also features -10 dB/+4 dBu switches for all four channels.

The Model 106 is the third in Aphex's ST (Serious Tools) series, following the Model 104 Type C² Aural Exciter® and Model 105 four-Channel Logic-Assisted Gate™. For more information, circle **Reader Service 32**.

The Renaissance series, previewed by **Ward-Beck Systems** last year, is now in production. These consoles are automation-ready for live-assist operation and come in eight, 16, or 24 module sizes. Possible modules include mic/stereo line input, mic input, stereo line input, control room monitor, studio monitor, summing output, stereo line selector, and meter/mix minus.

Neotek showed its Esprit broadcast console and its Elite multitrack music production console. Neotek's consoles also are configurable to buyer specifications, are built with solid alloy frames and use custom-made low-loss capacitors with symmetrically etched foil.

Dateq showed the BCS50, a VCA-controlled modular console. The BCS50 has three output buses and can include up to 16 mono mic/line, stereo line/line, and telephone modules. The nontelephone modules have fixed-frequency three band EQ and two mix-minuses. The telephone module may operate with Dateq's analog built-in hybrid or with an external digital Telos hybrid.

Amidst a wide selection of processing equipment, data and automation systems, and telephone hybrids, **AEV** displayed the PCM 8000 console. This console's 16 and 24 channel versions feature four master stereo outputs, a telephone module with three lines which can be interconnected for conferencing, auxiliary inputs and outputs, submasters, and talkback. The smaller MMS 412 and BSM 622 also were shown.

A battery-powered four-output mixer was showcased at the **Audio Developments Ltd.** booth. The AD 146 is available in four frame sizes accommodating six, eight, 10 or 12 input modules. It also comes in four styles: a portable version with a handle, drop-through mounting for existing furniture, rack mounting, or in a wooden console. The buyer can select a combination of mic/line, mono line, or stereo line inputs. The AD 146 includes three-band EQ on each input module, limiters for each output, a flexible monitor module, and a 1 k and 10 kHz switchable tone generator.

Shure Brothers displayed its portable stereo mixer. The FP32A is a three-input two-output mixer which operates on two 9V alkaline batteries for at least eight hours. It features 48V phantom, 12V phantom, and 12V T (A+B) power, pop-up pan pots, and the capability of linking with other FP32A mixers.

Mark IV Pro Audio Group showcased the DDA Q11 console, a true LCR (left, center, right) console with a choice of eight mono groups, eight stereo groups or four true LCR groups.



Radio stations can now eliminate dedicated phone lines for on-air news reports and call-in programs with the new Direct Connect Technology (DCT) product line from **Gentner Communications Corp.**, Salt Lake City. DCT interfaces allow direct connection to any digital or analog telephone system, which makes the use of regular business phone lines practical for on-air purposes.

The first two products in the DCT line are the G2700 Superhybrid and the TS612 multiline system for six or 12 lines. Other DCT features include direct connection to audio consoles and to digital audio storage systems, as well as direction connection between DCT interfaces to set up conference calls.

Elaine Jones and Paul Anderson appear here with the DCT. For more information, circle **Reader Service 3**.



ARE YOU READY FOR COMPRESSION?

New DIGI-READY™ Phase-Locked Commercial LNBS from Cal-Amp

These new *Digi-Ready*™ LNBS fulfilled the need for phase-locked downconverters necessary to receive digitally compressed satellite programming signals. Although some digital compression formats are undefined, phase-locked commercial LNBS, which maintain low Bit Error Rates, are recommended to ensure proper reception of digitally compressed signals. *Please call your commercial distributor for additional details.*

DIGI-READY™ LNB Specifications:

- Input Frequency 3.7-4.2 GHz
- Output Frequency 950-1450 MHz
- 45° K Noise Figure, Typical
- Phase Noise -80 dBc / Hz @10 KHz
- PLL Oscillator Stability ± 2.3 ppm (± 12 KHz)
- Input VSWR 1.5:1 (Isolated Model: Part No. 31814)
- 2 year Warranty
- Made in the USA

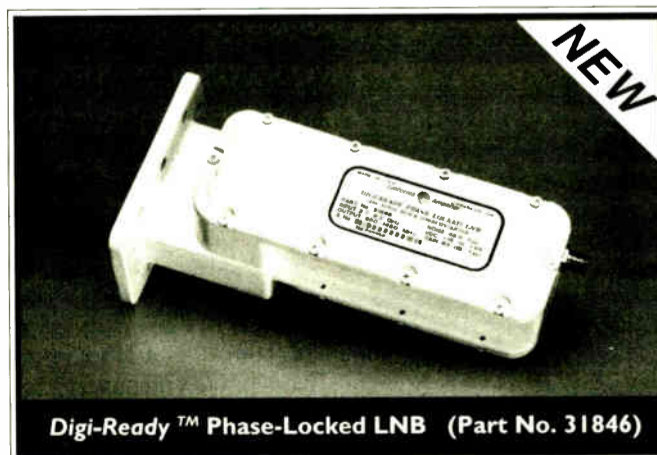

California Amplifier, Inc.

460 Calle San Pablo Camarillo, CA 93012
Phone (805) 987-9000 Fax (805) 987-8359

California Amplifier

STL, REMOTE, TELCO, ISDN

STL Technology Is Leading-Edge New

by Nancy Reist

LAS VEGAS Products to facilitate consolidation dominated the NAB displays this year. Program distribution services, remote controls for equipment ranging from tape decks to transmitters and satellites, and a variety of products to enable broadcasters to send signals efficiently through different channels were very common.

Needless to say, many of these products were digital. Digital compression, or data reduction as some people prefer to call it, was an important component of many of the products displayed at the NAB this year.

Dolby Labs demonstrated its newest compression scheme, AC-3. AC-3 is a multi-channel algorithm that uses psychoacoustic principles. It has been selected by the FCC Advisory Committee for use with HDTV and has been implemented in the film industry, but it hasn't been applied much in radio yet.

This year, however, Dolby introduced the DP 521/DP522 codecs, which support both AC-2 and AC-3. The system is available in a variety of configurations and can be used in point-to-point

or point-to-multipoint applications. The system accepts and passes data in the S/PDIF format and an AES/EBU interface is optional.

Audio Processing Technology presented its data reduction alternative, apt-X100, which features single chip coding and decoding, real time compression of 16 bit PCM to 4 bits, and a coding delay of less than 6 ms at 32 kHz sampling. The apt-X algorithm does not use psychoacoustic masking.

The scheme is used in many digital workstations and automation systems. apt-X compression is used in the DSM100 digital audio transceiver, designed to carry full duplex digital audio signals over low capacity digital communication circuits such as those available on the ISDN or T1.

The DSM100 can be operated in conjunction with a new product, the Pro-Link ISDN Manager. The Pro-Link is a high-speed, secure system for transferring high-quality audio on ISDN communication circuits. In conjunction with the DSM100, it provides a bandwidth of up to 22 kHz.

Comrex uses the apt-X100 algorithm in its new Model DX100 codec. The

continued on page 54 ▶

Diodes Can Control Damage

▶ continued from page 27

LEDs are designed to illuminate with forward biased. They come in red, yellow

LEDs and photodiodes are often used in remote control systems and fiber-optic transmission and reception.

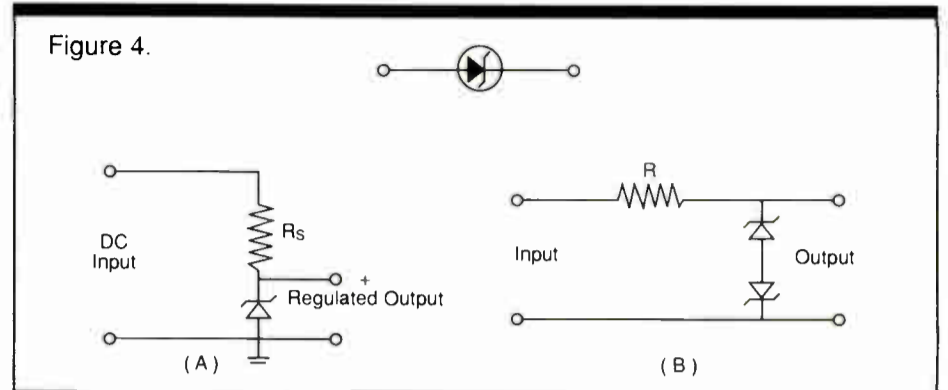

and green as well as infrared. Colored diodes are often used in place of lamps in modern circuits.

LEDs were originally used for displays in watches and calculators, but they were eventually replaced by liquid-crystal displays (LCDs) in those applications because of their high current demands. LEDs require a current flow of 10 to 20 milliamps with 1.5 to 3 volts applied.

Photodiodes also operate in reverse bias. When light strikes the PN junction, current flows forward. They are an integral part of the charge-coupled device (CCD).

Ed Montgomery is a communications teacher at Thomas Jefferson High School for Science and Technology. He has taught broadcast engineering at Northern Virginia Community College and worked as a broadcast engineer for several radio stations. He can be reached at 703-750-5090.

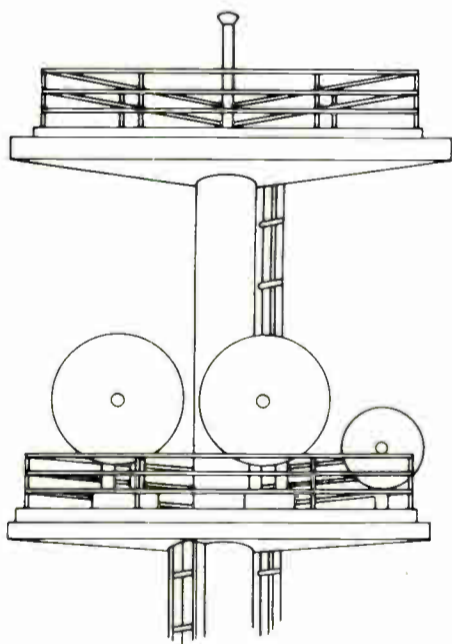
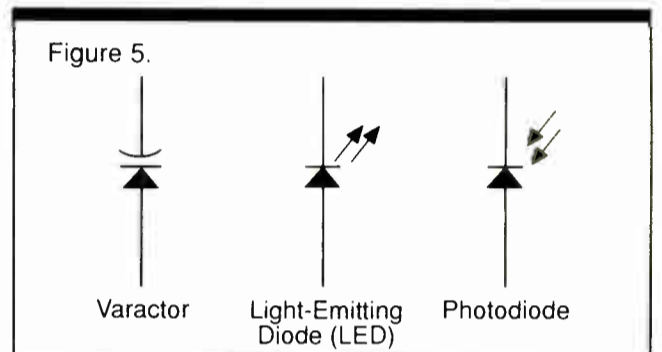

"I recommend STABILINE® Voltage Regulators for any brand of transmitter that is being placed in a harsh operating environment."
— Steve McElroy, CCA ELECTRONICS

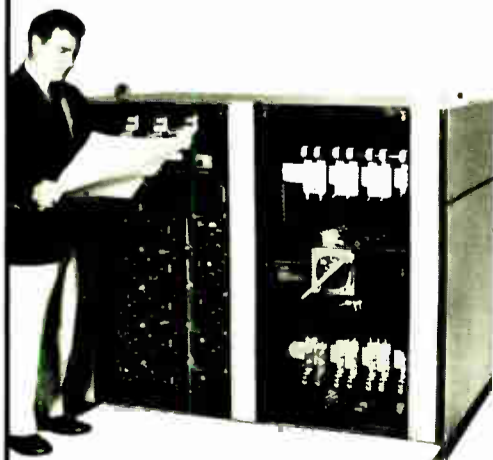

3-phase, 500 kVA WHR Series Voltage Regulator

How to tame transmitter power problems.

WHR Series STABILINE® Voltage Regulators for AC power systems up to 660 volts.

Transmitters placed in remote, unattended locations such as mountain tops and wilderness areas depend on long utility power lines for service. Unfortunately, the lines often produce poor voltage regulation and other damaging power aberrations. Poor regulation can reduce power tube life by as much as 70% and the performance of associated equipment is similarly affected.

For example, a 15% undervoltage can decrease power tube life because cold operation promotes contaminant buildup in the tube. Conversely, a 10% overvoltage decreases life because increased temperature accelerates the decarburizing process.

The problems can be easily corrected.

Cost-effective WHR Series STABILINE® Voltage Regulators are the preferred choice of broadcasters worldwide for use with transmitters, receiving stations, studios and mobile production vehicles. These high power voltage regulators maintain constant voltage to your sensitive equipment even when the power line input voltage and system load vary widely.

Features include:

- Hold output voltage within ±1%
- Power ratings from 2 to 1680 kVA

- Maintenance bypass plus other standard options
- 99% typical efficiency
- High overload capacity
- 19-inch rack mount versions
- Designed for UL and CSA approvals

A host of options allow you to customize your application.

Standard options include:

- Single or three phase models
- Analog or digital control
- Bypass switch
- Ammeters
- Frequency trip meter
- Tropicalization
- Manual raise-lower switches
- Zig-zag neutral generation
- Single or individual phase control
- High energy transient suppression
- Input voltage range alarm contacts

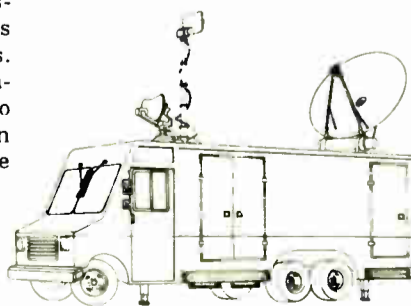

"Our production vehicles don't leave without one."
— Ron Crockett, SHOOK ELECTRONICS



For Catalog WHR692 and to learn how WHR Series STABILINE® Voltage Regulators can be the solution to your power problems, write, fax or phone Ted Gladis at

1-800-446-6161

SUPERIOR ELECTRIC
WARNER ELECTRIC

383 Middle Street • Bristol, CT 06010
203/582-9561 • Fax: 203/582-3784



STL Gear Goes Digital

► continued from page 53

DX100 operates at a variety of data rates and bandwidths. It is capable of wideband stereo at a data rate of 256 kilobits per second (kbps). Comrex also has a new ISO/MPEG Layer II codec, the DX200.

It may be user configured for a variety of output data rates and for stereo, joint stereo, dual mono or mono operation. Both the DX100 and the DX200 come with an inverse multiplexer, which will combine two independent 56 or 64 Kbps data channels. Both systems will work with ISDN, Switched 56, satellite, wireless modem or fractional T1 applications.

ComStream favors the ISO/MPEG compression standard. It is incorporated in the new ABR200 digital audio receiver, which has a 4800 bps data output and features rate and mode flexibility for use with C and Ku-band satellites. It also includes remote control cue signals, an RS-232 asynchronous data port up to 9600 baud, and software that can be upgraded over the satellite link.

ComStream's DAC400 also employs ISO/MPEG compression. The DAC400 can be used for simultaneous two-way point-to-point communication with another DAC400-based system or it may be used to send audio, data, and cue controls to ABR200 audio receivers.

NPR Satellite Services uses ComStream equipment in its new digital distribution system. NPR sells the satellite time that is not used by public stations to commercial broadcasters. It offers a Single Channel Per Carrier (SCPC) service of both analog and digital audio on the Galaxy IV satellite. More than 20 fixed uplinks are established in major markets, with transportable uplinks for more remote locations.

Corporate Computer Systems also employs MUSICAM (ISO/MPEG Layer II) coding scheme in its codecs. The company introduced the CDQ2001, which features 20kHz transmission, a new 18-bit A/D converter, selectable 32/48 sampling rate and remote control via a dial-up PC.

CCS' dealer, California Digital also offers a Ku satellite power control system, PowerSat, which enables broadcasters to operate at higher power when it rains.

RE America also selected the ISO/MPEG compression scheme for the "Easy ISDN" package it showed at the NAB. Easy ISDN is based on the RE 660 and RE 661 Musicam Codec. It accepts AES/EBU and S/PDIF digital audio signals with a sampling frequency of 32, 44.1, or 48 kHz, as well as analog signals. A simple user interface allows the user to configure the encoder, while the decoder responds to the signal it receives.

The codec transports audio at bit rates ranging from 56 to 384 kbps and includes inverse multiplexing on two 56/64 kbps channels or one virtual 112/126 kbps channel. RE America also announced that it will



soon introduce the 662/663, which will have three built-in terminal adapters for up to three ISDN lines. Software upgrades to the new model will be available.

Telos Systems integrated ISO/MPEG Layer III into the new Zephyr codec, which it featured at the NAB. Layer III uses filters on the 32 main frequency bands developed for Layer II and subdivides them 18 times for a total of 576 bands. Psychoacoustic masking calculations are made on these bands.

IDB Broadcast worked with Telos Systems to develop a specialized version of the Zephyr, which it uses with its new Digital Audio Network, the A/FX. The A/FX is based in many cities throughout the U.S. and Canada and is capable of providing 15 kHz stereo service for special events, two separate paths for dual language sports transmissions, and a variety of remote transmission and distribution services.

IDB also announced that it will be distributing radio spots from production facilities to radio stations using its digital network and TeleSPOT computer workstations.

Intraplex provides a variety of coding options for different terrestrial, microwave radio, and satellite transmission applications. The PT/PR 350 Series comes with 16-bit linear coding with 4x oversampling to eliminate multiple compression stacking. It can transmit 15 kHz stereo in a T1/E1 circuit with room to add

uncompressed, stereo 15 kHz digital signal. The system is portable, does not require licenses, and comes with 10 unique front-panel selectable coding channels.

The remote transmitter may be powered by either AC or DC sources and sends two user signals to the receiver to control or flag equipment at the studio.

Gentner introduced its new Direct Connect Technology (DCT) line of telephone interfaces. DCT products can be connected directly to any telephone system, so that existing systems can be used in the studio. They also provide their own "mix-minus" feed to callers and can be used with any line-level audio input.

DCT products can be linked together with a single cable to facilitate conferencing. The G2700 DCT provides record, cue, and a monitor amp with built-in speakers. The TS612 DCT is a multi-line system with call screening and multi-studio capability.



Small college stations and community groups looking to set up a translator service could hardly find a more economic alternative than the FM100 solid state transmitter from Crown Broadcast, a newly formed subsidiary of Crown International, Elkhart, Ind.

An audio processor, stereo generator and RF generator are all built into one 100-watt transmitter. FM100 users can adjust the power down to 20 watts and the frequency between 88 MHz and 108 MHz. The unit weighs 25 pounds and will fit into a suitcase.

The FM100's list price is \$5,695, which includes a limited three-year warranty. A spare parts kit is optional.

Don Pettifor and Phill Sandahl are shown at left next to the transmitter, which is also available in a 200-watt version. For more information, circle **Reader Service 48**.

voice and data channels.

The PT/PR 355 Series can transmit four 15 kHz audio channels in a single circuit using J.41 14:11 compression. The PT/PR 150 Series can transmit up to 12 15 kHz audio channels in a single T1 circuit using the apt-X100 compression technology.

QEI bypasses both telephone lines and compression controversies with its Quick-Link digital stereo microwave system for remote broadcasts. The Quick-Link uses Spread Spectrum RF technology to send an

AEV displayed its "Exclusive FM," a 10-band audio processor and coder which provides storage of 256 processed sounds, an internal pink noise generator to aid spectrum analysis, and independent control for variables such as threshold limiting, gain, clipping and attack. AES-EBU fiber-optic digital audio inputs, a digital stereo encoder and transformer balanced inputs and outputs are optional. AEV also showed a wide range of telephone hybrids including the portable Telereport 10 and 20 hybrids and the multiple-line ITB 202.

Wegener Communications demonstrated the use of its Addressable Network Control System and the DR96 SCPC receivers. TMX announced it will use the Wegener products to deliver national radio spots directly to radio stations via C-band satellite. Participating stations will receive the material in real time using a DR96 receiver and a Panasonic SV-3900 DAT, which are connected to the station's existing C-band dish.

Moseley Associates said that the Starlink 9000 was its major attraction for this NAB. The Starlink 9000 is an open-architecture, modular digital transmission system that comes with a selection of "plug and play" personality modules. The frames can house 3, 8, or 16 interchangeable modules. Transmitter and receiver modules are available to cover the 200-2000 MHz frequency band and come with an on-frequency VCO that is phase-locked to a computer-controlled reference.

A four-port multiplexer module can multiplex four data streams with rates of up to 2.048 Mbps. The standard stereo source coder module offers 16-bit linear PCM at 32, 44.1, or 48 kHz and a choice of either sub-band ADPCM or ISO/MPEG coded material. It includes a built-in sample rate

continued on page 61 ►

THE SIMPLE SOLUTION FOR DIGITAL AUDIO TRANSPORTATION

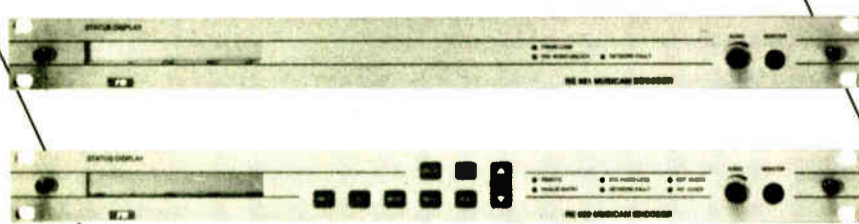

- ▲ MUSICAM ISO/MPEG Layer 2, 2A
- ▲ Switched 56, 64 kbit/s, ISDN, Fractional T-1
- ▲ User data channel from 300-9600 baud
- ▲ Easiest set-up locks to network or internal clock
- ▲ Fully automatic decoder reduces operator set up

- ▲ Multiplex or redundant two times 56/64 for 112/128 kbit/s
- ▲ Mono, Dual Mono, Stereo, Joint Stereo operation
- ▲ AES/EBU and SPDIF digital interface *included*
- ▲ Two-times V.35, X.21 or RS 422 interface *included*
- ▲ Headphone monitor *included*

The RE 660/661 MUSICAM Digital Audio Codec was developed to enhance MUSICAM technology, providing up to 20 kHz of audio bandwidth. From satellite networks to switched

56 telephone lines, the full-featured RE 660/661 is completely bit rate flexible up to 384 kbit/s.

Applications range from network program distribution to remote pick-ups for sports, concerts, special events, news gathering, STL back-up, audio backhaul, recording and post production studios.

When it comes to digital audio transportation, nothing comes close to the RE 660/661 for providing quality audio with hassle free set up. Backed by 55 years of experience in analog and digital audio products, the RE 660/661 is the simple MUSICAM solution for all your digital audio transmission needs.

Available through Broadcasters General Store, Harris Allied and RF Specialists



RE AMERICA, INC.
31029 Center Ridge Rd. ▲ Westlake, Ohio 44145
Phone: (216) 871-7617 ▲ Fax: (216) 871-4303

SONY

GET OUT OF THE SAME OLD LOOP.

Tired of going around and around with your old cart machine?
Then it's time to head straight for Sony's digital MiniDisc Cart. A direct result of Sony's leadership in MiniDisc technology, the MiniDisc Cart is a simple plug-in replacement for your NAB cart. And it gives you everything analog simply can't deliver. Like superior sound quality, random access, and re-recordable discs with up to 74 minutes of record time each, and more. Learn how you can get out of the loop. Call 1-800-635-SONY ext. MD.

INNOVATION AT WORK.



MD PLAYER MDS-B2P



MD RECORDER MDS-B1

There's a Right Way



"I did it right from the start with Computer Concepts' DCS."

I don't sweat when it comes to our spot-heavy morning drive or complicated LMA formats. The reason is simple: First I did my homework. And then I bought a DCS hard disk system from Computer Concepts. In fact, I bought several.

I smile at the thought of multiple program formats and satellite automation, live and live assist. I laugh at complex spot rotations, two-channel crossfades with simultaneous recording and networking to traffic—they're no problem for the DCS.

And Computer Concepts customer support is terrific. Their software experts can even troubleshoot my DCS and upgrade the software remotely, via modem.

No wonder Computer Concepts DCS has turned hundreds of stations into happy customers. I'm glad I'm one of them. Oh, I almost forgot. The price was right, too.



"I should have bought a DCS in the first place."

I thought I'd impress HQ by buying the cheapest hard disk system I could find. After all, they all look the same! Their promises sounded good and I wanted to believe.

I found out promises come cheap. But their system wasn't really cheap—not once you added up the little "extras" it took to do the bare minimum. And it still couldn't do all the things our station really needed.

I found out the hard way, at 3 AM when the system we bought crashed. And in morning drive, when missing spots meant dollars down the drain. When I finally reached customer support, they said they were working on software they thought would fix my problem, but they weren't sure when it would be done. Guess what I told them?

Now I know better. We're getting a Computer Concepts DCS. I learned a costly lesson: Get it right the first time. Call Computer Concepts first.

and a Wrong Way

DCS by **Computer Concepts**
CORPORATION

Computer Concepts Corporation
8375 Melrose Drive, Lenexa, KS 66214
Phone: (913) 541-0900 Fax: (913) 541-0169

World Radio History
Circle 183 On Reader Service Card



Honorable Mention of 'Cool Stuff'

RW's Cool Stuff judges, stout individualists as a breed, could not unanimously agree on the worthiness of many products. But a few devices met the rigorous coolness standards of most of the judges and were agreed to be honorably mentionable in this space.

The golden-eared judges favored the Alesis Monitor One™ studio reference monitor from Alesis Corp., Los Angeles. Alesis recognized that many audio mixing rooms have acoustical defects that reflect and distort the sound. The Monitor One's "top-to-bottom" construction is designed to aim the main power of the sound directly at the mixer operator.

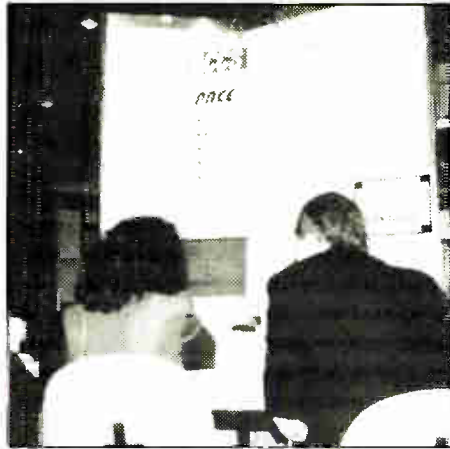

Radio Systems Inc., Bridgeport, N.J., was aiming for the same level of user friendliness with its DDS® (digital delivery system) hard disk storage device. The machine looks and operates much like a traditional broadcast cart machine from the DJ's perspective.



But DDS does things no cart machine ever did. A user can access up to 144 cuts with the push of one button using the systems



"Sound Slate" interface. Multiple interface panels can access the system simultaneously through DDS's UNIX-style operating

system. DDS will also control CD juke boxes and other audio inputs. For more information, circle Reader Service 122.

Many believe 1994 will be a breakthrough year for acceptance of Radio Broadcast Data System (RBDS) technology among U.S. broadcasters. If that is true, many broadcasters will need test equipment, such as the Model PRD-

3000 RDS/RBDS monitor, decoder and analyzer from Modulation Sciences.

continued on page 58 ▶

The unit also comes with the Alesis SuperPort, which is meant to maintain a more accurate bass response than is common in most small monitors. For more information, circle Reader Service 117.

Another pretty cool studio tool is the PACE (parallel audio computerized edit) system from CCS Audio Products, Holmdel, N.J., which provides modern digital audio features, including ISO/MPEG Layer II compression, and high quality while at the same time stressing user friendliness.

The computer software and graphics use the terminology and images familiar to all sound engineers. PACE con-

QEI meets all your FM broadcast transmitter needs.

Selection

- 10 Watt - 1250 Watt Solid State
- 1 kW - 30 kW Single Tube
- Choice of Single or Three Phase Power Supply on 3.5 kW to 30 kW models

Service

- 24-Hour Service Hotline: (609) 728-2020
- **Free** Initial On-Site Checkout for FMQ-Series Transmitters
- **Free** Spare Parts Kit with every FMQ-Series Transmitter
- Extended PA Tube Warranty—the **only one** in the Business

Reliability

- Ultra-Low Maintenance
- Single Tube Design Eliminates Driver Tube
- No Sliding Contacts—Avoids Wear-Out
- Positive Pressure Cabinet to Prevent Dust Infiltration

Experience

- Over 20 Years of Field-Proven Designs
- RF Products for Broadcast, Scientific and Military Applications
- Total In-House RF Design and Manufacturing

Learn more about the finest FM broadcast transmitters in the business. Call Jeff Detweiler today toll free—(800) 334-9154.

QEI Corporation
 One Airport Drive • P.O. Box 805
 Williamstown, NJ 08094

Tel: (800) 334-9154
 Fax: (609) 629-1751
 24-Hour Service Hotline
 Tel: (609) 728-2020

RDS / RBDS

RBDS technology for FM broadcasting is emerging as a new revenue source for your station. Beat your competition. Be a leader in your market with RDS / RBDS technology from CRL.

SC-100 Features:

- Easy loop-thru installation
- Two expansion slots for future DSP card upgrades
- Fully programmable from the front panel ASCII keyboard

Watch your profits soar!

Call Today for a free demonstration.

Circuit Research Labs, Inc.
 (602) 438-0888 (800) 535-7648
 FAX (602) 438-8227



Worthy of Mention

continued from page 57

Somerset, N.J.

The device interfaces with a PC to measure RBDS injection and display data stream contents. The PRD-3000 is also equipped with a tuneable receiver so that stations can take the same measurements for nearby RBDS stations. For more information, circle **Reader Service 167**.

MiniDisc (MD) storage and playback technology, with its many potential advancements in audio storage and studio automation, is another technology that is likely to grow in popularity. Thanks to Sony's ATRAC (adaptive transform acoustic coding) compression

algorithm, 74 minutes of audio can be recorded on a single 2.5-inch magneto optical disk.

The MDS-B1 player/recorder, available through **Sony Corp. of America**, has several audio production features, includ-

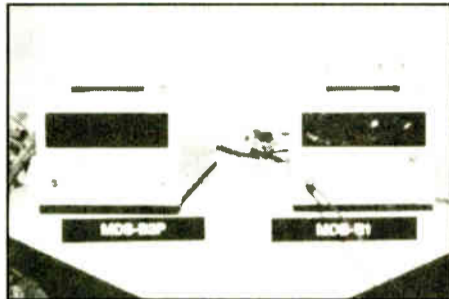

ing cut to track, track titling and an automatic cue to the next blank track to protect against unintentional overdubbing.

Both the MDS-B1 and MDS-BP2 player are compact and as easy to use as any home audio device. For more information, circle **Reader Service 73**.

Otari Corp., Foster City, Calif., offers its own MD recorder, the MR-10, which offers a table of contents of professional editing options, such as memory star, stop/standby and single/repeat play modes. It also features a +4dBu active balanced line input/output that can be used to select input impedance between 600 and 10,000 ohms. For more information, circle **Reader Service 86**.

Denon Electronics, Parsippany, N.J., introduced its DN-990R MD Cart™ recorder and DN-980F MD Cart player at NAB '94. The Denon MD systems are built especially with automation in mind, with a serial RS-232C port for remote communications and cue/end of cue signals.

The recorder includes a built-in Serial Copy Management System, which can be bypassed if desired. Both devices are compact enough for three to be contained side-by-side on a 19-inch rack.



For more information, circle **Reader Service 24**.

WHEN QUALITY COUNTS

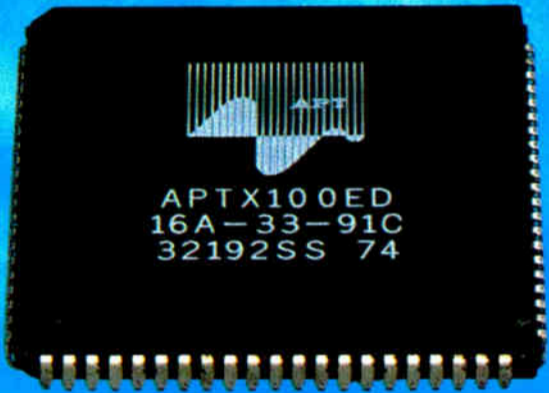

It has to be apt-X100 - the only true single chip audio compression solution - adopted by the world's leading manufacturers of broadcast equipment.

In professional broadcast, telecommunications and recording applications, the benefits of APT's predictive audio compression system are clear. Higher resistance to tandem coding errors, lower coding delay and a higher immunity to data errors mean less noise - so if you need to exploit the advantages of compression without risk - you'll be using the most appropriate solution. For details of both single chip and board level solutions - call APT.

Audio Processing Technology
Edgewater Road
Belfast BT3 9JQ
Northern Ireland
Tel 0232 371110
Fax 0232 371137

Audio Processing Technology



Audio Processing Technology
6255 Sunset Boulevard
Suite 1026
Los Angeles
CA 90028 USA
Tel 213 463 2963
Fax 213 463 6568

apt-X and apt-X are registered trademarks of APT

Circle (164) On Reader Service Card

10

If you see this as a ten, not a binary two, we've got the digital audio system for you.

The DAD486x Digital Audio Delivery System combines the benefits, reliability, and economics of modern computer technology to provide a powerful CD quality digital audio system that does not require a programmer to operate it. With DAD on the job, you can instantly switch between Live Assist and fully Automated formats, and reap the advantages of instantaneous access to hundreds of tracks or completely controlled programming.

Operating DAD requires virtually no learning curve, as it emulates the equipment that you have always used. The optional Touchscreen is the ultimate in intuitive operation, or you can use the same fader starts or other remote controls that you do now. The super fast Graphic Waveform Cut and Paste Editing will make you wonder how you ever tolerated grease pencils and razor blades. And interface to satellite program networks is so easy that it takes only minutes to install, no special software required.

Maybe the most remarkable feature of DAD is that it runs under DOS, the most

commonly utilized software in the world, and on standard off the shelf hardware. Maintenance support, parts, and expansion hardware can be easily obtained anywhere. And you are assured that as computer technology continues to evolve, DAD will grow with it. You never need to be out of date. There are no monthly licensing fees and upgrades are free for the first year.

DAD can be configured to fit any size facility, from a stand alone Workstation that does double duty for both Production and On-Air to multiple Workstations, each equipped for a specific application, operating on a true Local Area Network. Redundancy and backup features can be configured to meet any need or budget. And DAD talks to CD Jukeboxes, Routing Switchers, and more.

DAD486x rates a "Ten" as the ultimate digital audio system!



To receive more information call us at 1-800-ENCO-SYS



1866 Craigshire Drive, St. Louis, Missouri 63146 USA
Tel: 800-362-6797 or 314-453-0060 Fax: 314-453-0061

Circle (172) On Reader Service Card

Software Audio Workshop wins with Radio!

SAW was recently voted one of the "Top-Ten" Radio Products by Broadcast Engineering Magazine at the 1994 Las Vegas NAB show.

A Revolution in Hard Disk Editing!

SAW offers professional Hard Disk Editing and Multitrack Mixing for Windows with: 4 Simultaneous Stereo Playback Tracks. Simultaneous Synch Record/Play. Live Automated Non-Destructive Mixing. Realtime Preview Of All Processing Functions. Incredibly Fast Assembly Language Displays & Processing. And Much, Much More!



INNOVATIVE
QUALITY
SOFTWARE
3111 S Valley View Blvd Ste F102
Las Vegas NV 89102
Tel. (702) 368-2213
Fax (702) 368-2470



Lotus Communications Corporation

To Innovative Quality Software

I just wanted to extend my congratulations for releasing what has to be the most impressive dollar value in digital audio today. Throw away your razor blades. For the price of a modest reel to reel tape machine you can own a multi-track digital workstation. (We've been able to buy 486 local bus computers with 340 Meg HD, 8 Meg of RAM, SVGA non-interlaced monitors, a mouse, DOS and Windows. The Card-D Plus, and S A W for less than \$2,500.00 total)

I wrote this letter for the sole purpose of encouraging a larger number of broadcasters to jump into the unbelievable advantages of multi-track digital editing. Lotus stations have had digital workstations for more than 4 years now. We have a number of different systems. Between operating these systems and demos on others, we have learned a few things that work and a few that don't. We've also learned that some of the things we thought were important, were not. That's why I'm so impressed with S A W. It's right on target.

March 12, 1994

1) Software friendliness is not important..... it is absolutely essential.

No one has developed a system that doesn't have a learning curve, not even S A W. Remember what we are dealing with, in most cases, are disk-jockeys, not the high-tech creatures we might have hoped for. If it doesn't come easy, they will, generally, not tackle it. The S A W system is the only editor that I have found where a jock could actually produce something usable the first day out of the box. The key problem with most workstations is that there are too many steps required to completing a task, making them cumbersome. Don't be fooled by the vega-matic salesmen that demonstrate them either

2) Don't do things in a digital workstation that can be done better with discrete devices in real-time.

We have several workstations with full DSP functions, such as EQ, Echo/Reverb, Pitch Shifting, Time Compression/Expansion, etc. The time involved moving the audio file to the DSP module then waiting, sometimes, a very long time for the processing to take place, then moving the audio file back into the editing window, often, without the ability to hear the processed file until it's back in the editor, involves too many steps, takes too much time, and cost too much extra to consolidate within the workstation. For far less, you can buy a graphic or parametric equalizer, a digital reverb/echo, a pitch shifter/harmonizer, and a limiter/compressor, to put in your rack. You can adjust audio in real-time and make the modification to the audio at any step within the process, using accessories which were designed to do just that particular job, more efficiently, quicker, with a greater degree of adjustment and accuracy and most important, being able to listen to it in real-time while you are making the adjustments. Use the workstation for just what it was intended, nondestructive editing, synchronizing, mixing, moving audio to where you want it, complete control of every element

3) Speed is important. (get a system that's on amphetamines)

There are lots of slugs in the workstation market. Don't buy one of them if you want to improve your efficiency. After all, the two reasons for editing your audio in a workstation environment are to improve creativity, but just as important, to improve productivity. You can't accomplish more work if you are waiting on the system. You need a fast computer, and you need fast software. S A W is as fast as anything I've seen at any price. This is a Windows based system written in machine language. Don't expect to see the little hourglass on the screen very often.

At 10 times the price, S A W is a competitive product. At its' market price, you'd have to be crazy not to buy it, even if you have a \$50,000 system in your main production studio, put S A W in Prod. 2 and Prod. 3. If your in a 1 station market, and you can afford a reel to reel, you can afford this system.

Thanks for the time,
Linda Williams
Linda Williams
V.P. Engineering
LOTUS COMMUNICATIONS CORP.

6777 Hollywood Boulevard, Los Angeles, CA 90028 • (213) 461-8225 • FAX (213) 467-8256

KWKW Los Angeles, CA
KTKT/KLPX (FM) Tucson, AZ
KGST Fresno, CA

KENO/KOMP (FM) Las Vegas, NV
KOXR Oxnard, CA
LOTUS HISPANIC REPS Nationwide

KOZZ/KOZZ-FM Reno, NV
KFSD-FM San Diego, CA

KZEP/KZEP-FM San Antonio, TX
KTEZ (FM) Lubbock, TX
LOTUS SATELLITE NETWORK

For More Information And Pricing

Contact:

BSW
BROADCAST SUPPLY WORLDWIDE

Phone: 800 • 426 • 8434 Fax: 800 • 231 • 7055

7012 27th Street West Tacoma, Washington 98466

AUTOMATION SYSTEMS

Creative Control with Automation

by Dee McVicker

LAS VEGAS This NAB convention drove home the point that personal computers have become as much a staple of the NAB convention as electricity, in part because of their use in radio automation. This is no surprise to regular show-goers, who have witnessed automation intelligence go up and prices plummet as stations consider creative ways to streamline operations and costs.

This year, a few new players were introduced to the automation fray, an overwhelming majority of existing systems got a face lift, and a gamut of creative innovations were on display. Many of the first-genera-

tion automation manufacturers converted their systems to run under the Windows environment, a much more friendly operating environment than text-based DOS.

Other manufacturers addressed the issue of digital storage of music with some interesting adaptations of technology, and still others added new features that blurred the lines even more between automation, digital editing, and overall station control.

Among the new products was **Broadcast Electronics'** daBox system, which no doubt drew as much interest for its affordability as its sports bar display. DaBox packs a lot of automation in a small package and low price (list is \$5,995, includ-

ing the computer hardware). It stores five hours of stereo audio, can sequence up to seven CD players and has support for satellite automation.

BE also had on display its high-end AudioVAULT-100 storage system, which can be used to automate four separate stations.

AEQ's MAR (Management of Audio Resources) touchscreen system made its first NAB Spring convention, after its introduction at the Fall Radio Show. It was one of the more economical and user friendly systems on the floor with hard disk recording/playback and advanced editing features.

New to the U.S. market was AEV

Electronic Professional Equipment's Aurad System 2, which can be used on-air in live-assist mode or to automate from 64 digital sources.

Prophet Systems' Wizard for Windows was on display this NAB, exhibiting superb digital editing, song scheduler, and hard drive automation.

Fidelipac also showed a hard disk system, its Air Marshal. The system was introduced at NAB '93, and now has new cut-and-paste editing features, traffic module and scheduling program.

Consumer Business Systems Inc. (CBSI) showed its Digital Universe, which was introduced last NAB. This system operates under Windows NT, and is one of the few to promote uncompressed audio storage. Digital Universe also expands the automation concept to just about every facet of radio, with software modules for station billing, reporting and even sales analysis.

Media Touch, one of the first-generation names in PC automation, came to the show with its MediaDISK Digital Audio system, which exhibited a few new features. Foremost of interest was its News-TRAK Cut 'n Paste digital editor for faster news editing.

Gefen Systems, the only Macintosh-based system on the floor, showed its newest feature for the CDJ-Pro management system for background music and station automation.

Computer Concepts made several contributions to automation this year. It put "cart machines" on-screen for its DCS hard disk system, plus introduced a new traffic system, V.T.—for Visual Traffic—is an intuitive, sales-driven traffic system that uses graphical screens for traffic functions. The new traffic update is intended to ease the logging and billing load for LMAs, duopolies and other recent ownership changes.

Register Data Systems (RDS) brought its Phantom hard disk system, and exhibited enhancements in the system's traffic and billing and a new splice editing feature that can edit compressed or uncompressed audio.

At the **BASYS** booth, the D-CART was on display with powerful multi-user recording, editing and playback features. It's being positioned by the company as the system of all systems to prepare broadcasters for the tapeless studio—and perhaps DAB.

Several companies appeared to have made progress in the digital storage area. **Dalet Digital Media Systems** announced its system's use of recordable and durable CD-ROM, which can hold approximately 100 songs each as computer files. Other Dalet enhancements include new multitrack operation and a new application for text editing that links sound and text together for actualities, that can be programmed to scroll at the rate different announcers read the news. A music rotation module is also now available for the system.

Also of note on the music storage front was an interesting introduction by **Radio Systems**. Its Digital Delivery System is a digital control panel that looks like a cart machine, even built to the exact same dimensions. These cart machines communicate with a UNIX-based host computer for modern automation functions, but with the same look as traditional on-air cart machines.

Arrakis Systems showed its master control center, Gemini II, for live digital radio or what it predicts will be the next step in radio automation: to integrate all sources and functions of a radio station into one control panel. Arrakis also had several new

continued on next page ►

For the world's strongest AM transmitters, look to Nautel



Totally solid state AMPFET ND 10 10kW AM

Nautel AM transmitters keep you on the air with an unmatched combination of value, performance and reliability

Low cost of ownership—with typical efficiency ratings up to 80 percent, a totally solid state Nautel transmitter pays for itself in tube replacement and utility

Superior audio transparency—Nautel AM transmitters utilize inherently linear digital Pulse Duration Modulation for the cleanest sound you can broadcast. Audio is ruler-flat throughout the range and distortion is typically less than 0.5%

Field-proven reliability—Nautel transmitters give you multiple protection systems for both power line and lighting transients, VSWR protection, soft failure design, reserve cooling and safe on-air servicing

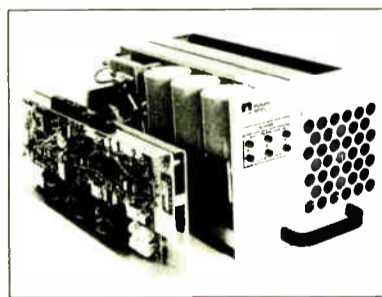

Removable AM Power Module

Make a strong transmitter choice. Call us today for all the facts on our totally solid state AM and FM transmitters.



Nautel Maine Inc.
201 Target Industrial Circle
Bangor, Maine 04401 USA

Phone: (902) 823-2233

Nautel

(Nautel Electronic Laboratories Limited)
R.R. #1, Tantallon, Halifax County,
Nova Scotia, Canada B0J 3J0

Fax: (902) 823-3183

► continued from previous page
enhancements for its Digi-Link and Trak*Star systems, which can take multi-track products to final air.

Radio Computing Services (RCS) enhanced its voice tracking function of its Master Control system. This enables announcers to do all their voice tracking at one time, instead of during real-time operation, and cuts down tremendously on on-air talent time. RCS also exhibited its digital integration solution with digital modules ranging from music selection and song tracking to production and news editing.

Enco's DAD486x was at two NAB booths. Harris Allied and Enco. Both booths touted the system's expandability and new user-friendly interface, including a cart-like look to the screens. The Audisk DS2000 was also on display, with new editing features for trimming, fading and scrubbing. The system is also now capable of local area networking for central storage of music libraries.

A-Ware Software's MusicMaster was expanded to include more in-depth reporting of playlists and simplified music editing. Another plus: MusicMaster comes with an on-line training course.

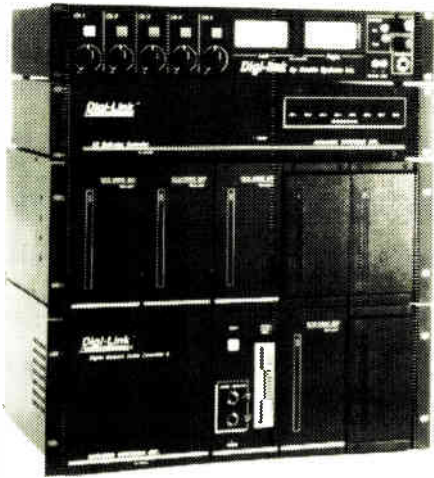

Arrakis Digi-Link

Pristine Systems was also enhanced prior to the show. It now has a traffic module and music scheduler.

The Management's Digital DJ, one of the few log-based systems on the market, was almost an entirely new incarnation from last year's model. It now has more multitasking functionality so live-assist and satellite operation can operate simultaneously.

ITC also added new technology to its **DigiCenter**, which was launched during last year's NAB and was noted for its on-screen cart machine. DigiCenter has an enhanced user interface, advanced CD player and jukebox control, 4 gigabyte and 9 gigabyte hard disk drives, and even a streamlined version for entry-level automation (the DigiCenter LT-120).

ITC also introduced its plan to trade some old ITC equipment for a DigiCenter.

Jefferson-Pilot Data Services showed its popular JDS2000/1000 management software with business applications, such as sales and activity tracking.

TM Century brought out its Ultimate Digital Studio II, which features new enhancements in remote control and second-generation CD player automation, among others.

STL Gear Goes Digital

► continued from page 53

converter. Other modules include channel coders, stereo/RDS generators, SCA generators, digital line drivers, voice/data/fax cards, and remote control.

Hallikainen & Friends now offers a computer interface for Moseley TRC-15 remote controls equipped with a Hallikainen & Friends TEL-171 digital telemetry adaptor. The "intelligent transmitter operator" ITO-178 is a plug-in card that fits into any expansion slot of an IBM-compatible computer and connects to the TEL-171 digital adaptor.

The interface gives the computer control of the TRC-15 and access to the meter readings from the TEL-171. Accompanying software permits the operator to automate remote-control chores. Metering and status information can be logged on both the disk and a printer. The ITO-178 also provides user inputs and outputs to keep track of station events like EBS tests received or sent.

Burk Technology demonstrated the ARC-16 system, a digital transmitter remote control system available in a variety of configurations to meet specific operator needs. A studio controller with a 32-character LCD display shows out-of-tolerance conditions. The optional Enhanced Speech Interface permits telephone control, which will also dial a series of telephone numbers to announce out-of-tol-

erance conditions.

An optional second port allows the control of two or three transmitter sites with a single unit. It can also be used for a redundant control/metering link. Other options include computer control, an antenna monitor interface, sample kits, an SCA receiver and battery back-up.

Marti Electronics offered the STL-15C, a composite studio-transmitter link and intercity relay. The system, which is composed of a transmitter and companion receiver, allows the user to change frequencies in the field. It is available in five frequency bands: 140-180, 200-260, 280-340, 400-480 and 890-960 MHz. Depending on the available channel bandwidth, the STL-15C can transmit composite FM stereo with a subcarrier or mono audio with two subcarriers.

Digital data or digital stereo audio are possible, but require external modems. Multi-channel audio or data requires an external MUX.

Dawn Satellite promoted its Coversat, satellite antenna covers, designed to let the signal through while protecting antennas from snow and debris buildup and excessive sun. The covers are made of a 12 ounce polyester mesh core fabric woven in a rip stop pattern and double laminated with waterproof vinyl. The covers are fire resistant and treated against ultraviolet breakdown.

How Many New Features Can You Find On Potomac's New AA-51A?

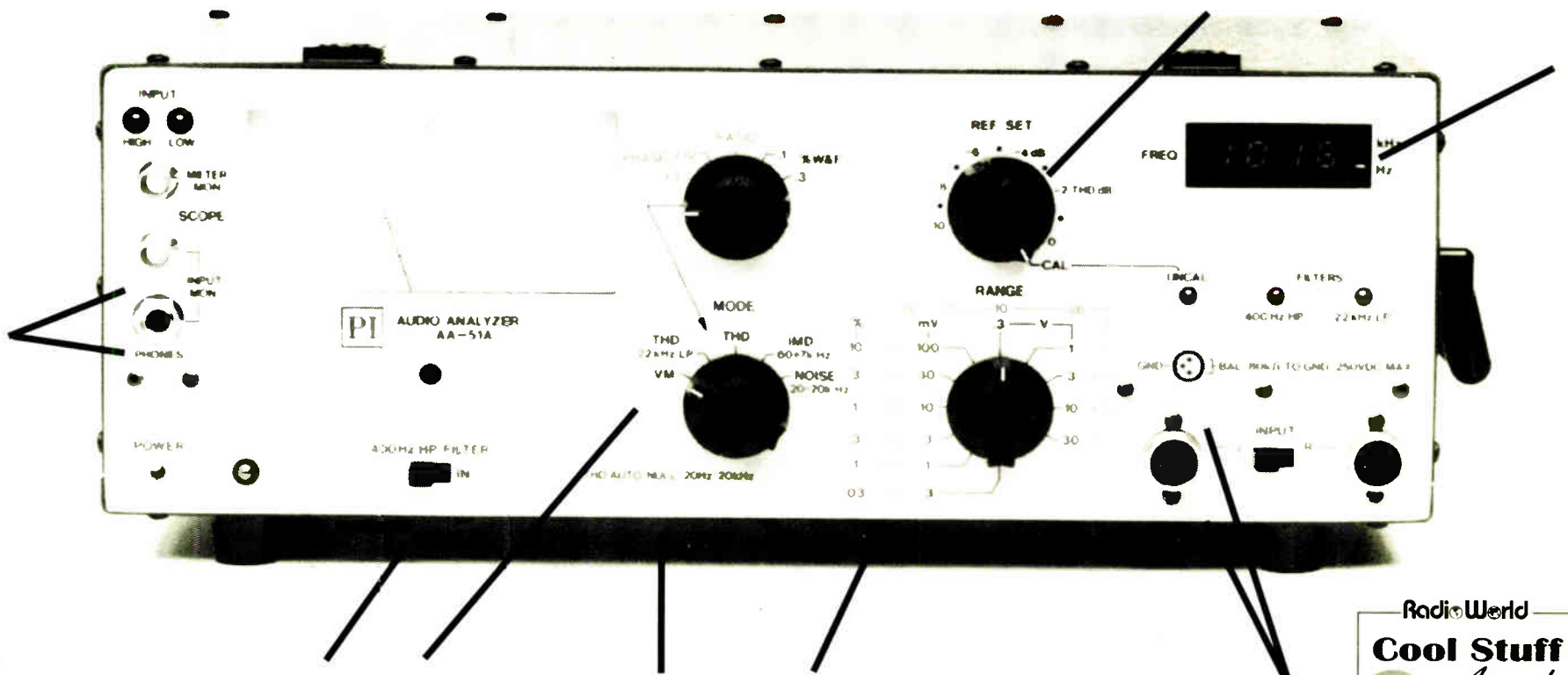

PI Potomac Instruments, inc.
932 Philadelphia Avenue, Silver Spring, Maryland 20910 • (301) 589-2662 • FAX (301) 589-2665

ANTENNAS & TOWERS

Innovation in RF Cable, Antennas, Towers

by John Bisset

LAS VEGAS Antennas, towers, and cable—at this year's NAB, not a hum-drum subject. In fact, there were a number of exciting innovations displayed. **Andrew Corporation** won one of RW's coveted *Cool Stuff Awards* for its HRLine and Inners Only transmission line.

Although presently available in 6-1/8 inches, smaller diameters are in the works. What makes this product so unique is its "bullet-less" design. Using a threaded screw and corrugated inner conductor, a constant tension is placed on the

center conductor which prevents sagging. The corrugated center also expands and contracts with temperature changes. A special adapter that maintains tension on the inner conductor permits easy disassembly. Andrew has over 8,000 feet of this new line in use, with two more stations ready to convert after the show. For budget minded stations with standard rigid line in place, Andrew's Inners Only provides only the new corrugated inner conductor which is placed inside the existing rigid outer conductor.

Cablewave and **MYAT** displayed a full line of rigid and semi-flexible coaxial

cables for both AM and FM use. For RF switching, **Passive Power Products** of Portland, Maine, displayed its "Quick Patch" coaxial patch panels. PPP's rigid components utilize a unique double-spring inner conductor bullet that insures 360 degree contact surface during expansion and contraction. This same bullet is used on its Quick Patch panels that come in 3- to 7-port versions.

Speaking of transferring RF, **Harris Allied** displayed a new four-port motorized transfer switch for AM transmitters. With silver plated contacts, the switch provides low loss; and requires only one ampere of cur-

rent to operate. The motorized contactor is similar to those offered by Delta or Dielectric, but less expensive, since it does not have to pass FM frequencies.

This year's NAB was a banner year for new products displayed by international manufacturers. In the RF arena, this was particularly true. **SIRA Sistemi Radio**, an Italian firm, displayed its SWU-FM-43, an FM switching system that will handle up to 100 kW. Another product from Italy, manufactured by **Elenos Broadcasting Equipment Company**, was the CHV02 Changeover Unit. Rather than packaging this switch in the typical square box, the CHV02 is constructed around a four foot long length of rigid line. Mounting and routing coaxial runs into and out of the switch are facilitated by this design.

As the international equipment manufacturer has entered the U.S. broadcast market, one U.S.-based company is making tremendous strides in mapping the world. **Dataworld** is in the process of expanding its communications mapping and database services to countries outside the North American continent. With the increase in privatized stations on other continents, it will not take these broadcasters long to appreciate the wide variety of services Dataworld can provide.

A joint effort between **Jampro Antennas** and **Central Tower** is sure to generate new business. These two companies have developed the FMT - Frequency Matched Tower. This collaboration represents the latest technology in RF signal improvement through manipulation of the antenna/tower relationship.

Ever since the real-world field measure-

Harris Allied displayed a new four-port motorized transfer switch for AM transmitters.

ments from **Air System Technology**, who demonstrated the outrageous effects of ladder positioning or coaxial line placement on an FM pattern, I'd wondered when someone would "put it all together." These companies are squarely addressing the problem of support structure distortion by providing a tower that matches the antenna element spacing.

The result is tower members that create a symmetrical backdrop for each of the radiating elements.

Electronics Research Incorporated (ERI) displayed a new FM antenna mounting system designed to enhance antenna performance. The geometric properties of the Lambda Antenna Mounting System minimizes gain loss due to non-uniform current flow distribution at each antenna bay level. The design reduces distortion in the vertical and horizontal plane patterns, as found with non-symmetrical antenna mountings. Two San Francisco-based FM's reported significant improvement in multipath distortion after installing integrated ERI antenna/Lambda systems on two different mountain locations.

With HDTV around the corner, and the

continued on page 64 ►

From San Francisco to Singapore From New Zealand to New York

CCS Audio Codecs Connect the World



CDQ1000 Mono Codec

- 10 kHz, 8.2 kHz or 7.5 kHz operation.
- CCITT G.722 and MUSICAM compression for universal compatibility.
- Bi-directional transmission.
- Ideal for news feeds, talk shows or voice-over announcements.



CDQ2001 Stereo Codec

- 20 kHz CD quality transmission.
- New 18-bit A/D converter.
- Selectable 32/48 kHz sampling rate optimized for FM broadcasting or recording studios.
- Remote controllable via dial-up PC modem.



Discover Crystal Clear Digital Audio Discover CCS



CCS Audio Products
33 West Main Street
Holmdel, NJ 07733, USA
908-946-3800 FAX: 908-946-7167



CCS Europe GmbH
Ludwigstraße 45
D-85399 Hallbergmoos, Germany
49 811 5516 0 FAX: 49 811 5516 55

invented the DigiCart[®] recorder to bring CD quality audio to broadcasting. Our on-going technical efforts provide customers with the service, upgrades and confidence expected in the broadcast community.

360



DIGICART/II

DIGICART/II

THE PROVEN UPGRADE FROM ANALOG CARTS

STANDARD FEATURES

- Instant access to any of 10,000 cuts
- 2-hour internal hard disk
- 68-minute Bernoulli cartridge drive²
- 16-bit linear recording for true CD quality
- Selectable Dolby AC-2 Data Reduction¹
- Normal operation provides 20 kHz stereo audio
- Digital Editing
- DSP generated fades & levels changes
- Bright 40-character display shows cut name, ID#, running time, and helpful user prompts
- Pre-program breaks and spot rotation
- Automatic record-on-audio
- Five year hard drive warranty
- Five year Bernoulli disk life
- Worldwide sales and service

BREAKTHROUGH PRICING

- Only \$4,995 record/play stereo, including a 2-hour hard disk. Other models from \$4,250 less hard disk. DigiCart/II is by far the lowest priced digital cart recorder on the market.
- Low-cost media—Only \$1.42 per minute²

OPTIONAL FEATURES

- Mini keyboard for titling and remote control
- Two new remote controls include LCD display
- "Hot Keys" give instant access to 16 spots
- Larger hard disks store 4 or 8 hours of stereo
- External hard disk arrays store up to 48 hours
- AES/EBU and SPDIF digital I/O³
- Toolkit for developing custom serial port programs

FOR A FREE 12-PAGE BROCHURE, CALL 818.342.3127

360 Systems

PROFESSIONAL DIGITAL AUDIO

360 SYSTEMS

18740 OXNARD STREET, TARZANA, CALIFORNIA 91356

818.342.3127 FAX 818.342.4372

DigiCart/II

¹User-selectable. ²150 MB Bernoulli Disk. ³SMPT/EBU Time Code board and Digital I/O available 1994. Stated specifications are with Dolby AC-2 operation.

Innovation Displayed in RF Cable

► continued from page 62

potential for radio broadcasters to cash in on tower space rental. **Stainless Inc.** is now offering HDTV Tower Analysis. A bulletin available from the company describes steps that can be taken to prepare your broadcast tower for HDTV.

Stainless also announced it was awarded the contract to fabricate and install a new 718 foot AM tower for Group W's KDKA - America's oldest commercial radio station. Installation of the modified Franklin design is due to begin this summer. Mr. Jeff "Bix" Bixby of Moffet, Larson, and Johnson, the telecommunications consulting firm that developed the electrical and RF aspects of the design, stated that the new configuration will significantly improve the "self-fading" situation that exists with the present tower. The new design will be energized at the 271-foot level, 80 feet below the mid-height, where Franklin towers are usually fed.

Kline Towers provided a maintenance checklist for towers at their booth. They have also formed an alliance with **Dielectric Communications** to provide turnkey tower/antenna systems.

At the **Doty-Moore Tower Service Company** booth, the unique Naptex E-field protective suit was displayed. Complete with hood, gloves, and mesh screen socks, the suit costs nearly

\$1,000.00. Its benefit? Stations don't have to cut back power while climbers work on the tower. Manufactured in Germany, the overlapping stainless steel fibers effectively shield the human body from RF energy. The suit was tested by the Navy for OSHA, and exceeds the ANSI Standard.

Also in the Doty-Moore booth was Gil Garcia and the folks from the Texas Association of Broadcasters. Gil was once again demonstrating the T.A.B. Safety Pen—an inexpensive pen-shaped device that glows red when in the presence of RF or an AC field. The pen can save your life, since its glowing red tip will warn you of any live AC or RF circuits prior to working on them. To order one of the pens, call T.A.B. at 512-322-9944.

Alan Dick and Company, well known for its spearhead panel antennas also displayed its FMAC circularly polarized antennas, designed for side mounting on towers. For windload concerns, ADC has also developed a low-windload Spearhead panel antenna.

Keeping the broadcaster's budget in mind, **Dielectric Communications** displayed its DCR-H series of economical, yet circularly polarized antennas. Intended for the Class A stations, the antenna can be either center or end fed.

At the **Shively Labs** booth, the explosion in translators was reflected in interest in the 6812 Stainless Steel Translator antenna. Interest in Shively's antennas seemed to span extremes—on the high power side, there was a renewed interest

mounting effects. Shively is one of many antenna manufacturers that offer this service.

Scala Electronic Corporation mounted one of its CL-FMRX High Performance FM Monitoring Antennas to a piece of tower section. These antennas are ruggedly built, cost about \$300, and can be supplied with either 50 or 75 ohm terminations. There are two models, one for

NAB94

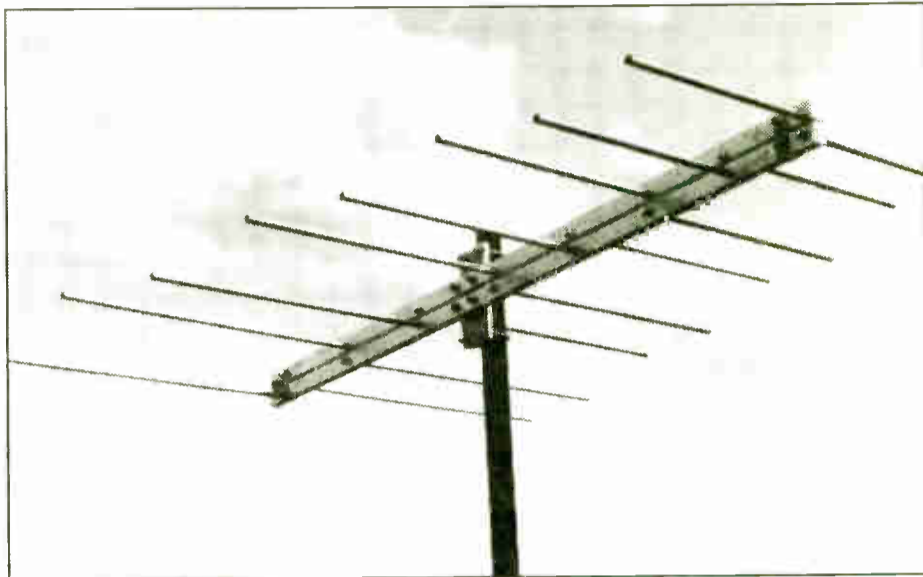

Scala Electronic CL-FMRX

in the 6814 and 6810 high power side mounted antennas. Antenna upgrades involving one high power antenna shared by several stations is showing a comeback. Shively also displayed its antenna pattern modeling service. More stations are doing pattern work due to concerns about coverage and tower

center mounting, as on a rooftop pole; the second model can be easily end-mounted on a tower leg. The elements are laminated to insure years of noise-free operation. The Yagi is broadbanded, weighs 18 pounds, has a 6.5 dBd gain, and minimum front-to-back/front-to-side ratios of 25 dB.

THE RF EXPERTS KNOW—MYAT DELIVERS

MYAT DELIVERS QUALITY

You can rely on MYAT rigid line and components to deliver a clean, powerful signal to your antenna. Pure highest quality copper, brass and silver plus computer-aided design and manufacturing ensure consistency and accuracy. No wonder demanding broadcasters worldwide choose MYAT products for their passive systems. We take Quality Control very seriously.

MYAT DELIVERS RELIABLE PERFORMANCE

Our non-galling silver-plated beryllium copper contact springs, brass elbow reinforcements and virgin Teflon inner supports are designed for maximum velocity, minimum attenuation and long service life. Every MYAT component is tested before shipping and backed with a full one year warranty. MYAT products are built for the long run.



MYAT DELIVERS WHEN YOU NEED IT

Major transmitter manufacturers with strict production schedules rely on MYAT to deliver quality components on time and within budget. So do leading broadcasters like the Empire State Building's newest TV tenants. At MYAT, commitments are kept.

LET MYAT DELIVER FOR YOU

Whether you're planning a new tower, upgrading an older installation, or coping with an emergency, you can depend on MYAT rigid line and components. Thousands of RF experts around the world already do. Contact your RF distributor, or phone us for our catalog, installation planning guide and engineering reference. Its detailed drawings can help you put together an efficient, trouble-free transmission line that will last for decades. For a free copy call 201-767-5380 or fax 201-767-4147.

RIGID LINE: RADIO'S EFFICIENT CHOICE

40 YEARS OF EXPERIENCE. 40 YEARS OF EXCELLENCE.
380 Chestnut Street • P.O. Box 425 • Norwood, NJ 07648
Tel 201-767-5380 • Fax 201-767-4147

Radio World

Broadcast Equipment Exchange

"Broadcast Equipment Exchange" accepts no responsibility for the condition of the equipment listed or for the specifics of transactions made between buyers and sellers.

RADIO RESOURCES

CALL US TO RECEIVE YOUR COPY OF THE NEW TECHNICAL NECESSITIES CATALOG

PRE-OWNED EQUIPMENT CURRENTLY AVAILABLE:

Belar FM Mod Monitor
Harris THE-1 Exciter
BE PT-90 P/S
Belar RF Amp
BE FMSB Transmitter
Eventide Delay BD 931
ITC Series 1 R/P Stereo
Marti STL-8 Mono
Wheatstone A-500 Console
And Many Other Items... Call for Prices \$5

PRE-OWNED EQUIPMENT ITEMS WE NEED:

AM/FM Transmitters
Optimods
Field Strength Meters
STL & RPU Equipment
Otari MX 5050 Bil Reel to Reels
Plus Many Other Items...

TEST EQUIPMENT AVAILABLE TO RENT:

Potomac Field Strength Meters
Delta Impedance Bridge
Delta Receiver/Generator
Textronix Spectrum Analyzer (for AM splatter measurements)

Call Steve or Chuck
1-800-54-RADIO
1-410-783-4635 FAX

Circle (66) On Reader Service Card

AMPLIFIERS

Want To Sell

New 10 kW FM amp under \$24,000. Call for details. Bill Hoffman, 518-743-1601.

Dynaco stereo 120 solid state, rack mount \$229. Dynaco stereo 70 tube amp w/ new tubes! Dynaco PAT 4 pre-amps \$59. W Gunn 619-320-0728.

ACOUSTICS

STUDIOFOAM

SOUND ABSORBENT WEDGES
TESTS UP TO 40% BETTER THAN SONEX
* COSTS LESS * BETTER COLORS * BETTER CUT *

SONOMATT

4' X 8' X 2" Sheets \$29.99 Ea. In Pairs \$49.99
VENUS 12" x 2" x 4" NRC 1.30 Flat 10K-125KHz
Then They Really Kick In (125KHz NRC-
BASED TRAPS) 1.63! Charcoal Gray 2 For Just \$150!!

1-800-95-WEDGE

Circle (68) On Reader Service Card

AMPLIFIERS

Want To Buy

Marantz Model 1, audio console pre-amp, single or pair, and Model 6 stereo adapter. P Chance, Imperial Analog, 925 Clinton Street, Philadelphia PA 19107. 215-574-8147.

Western Electric pwr amp wrking or not & output transformers for same. RQ Studio, Larson Rd #4, N Reading MA 01864. 508-664-0174.

WANTED:

Pultec EQ's; Fairchild, Teletronix, dbx, UREI, Sontec Limiters. Neumann, Telefunken, AKG and RCA mics. MacIntosh or Marantz Gear; Lang, Neve and API gear. Misc old tubes and guitars.

DAN ALEXANDER AUDIO

1340 Mission Street
San Francisco, CA 94103
(415) 252-7102
FAX: (415) 252-7524

ANTENNAS/TOWERS/CABLES

Want To Sell

ERI FML-3E, 3 bay low power antenna, 2 yrs old, exc cond, on 107.7, \$4000, we pay shipping. G Vaile, KYTN, 723 W 14th St, Little Rock AR 72202. 501-433-1077.

Continental 37-CP-3 3 bay FM antenna, 105.5 MHz, \$4800. C Fletcher, WLJE, 2755 Sager Rd, Vawariga IN 46383. 219-462-8125.

Andrews various 3" & 1 5/8" connectors, 100' of 3 1/8" Andrews line, (2) RF chokes, Continental 814B + manual, BO: Continental ERI Rototiller tuned to 97.7, 3 bay, 1 5/8" lead, 1.5588 gain, BO/trade. B Hill, KALK FM, 106 S Jefferson, Mt Pleasant TX 75455. 903-577-9770.

Jampro JMPC-10 10 bay CP FM antenna on 107.1, new condition, stored inside, \$9500/BO. B Zellmer, KSIR, Box 2475, Greeley CO 80632. 303-353-6522.

FM - ANTENNAS

Designed and built for your frequency. Choose from 1 to 12 bays and five power levels. Financing available. Call Jimmie Joynt at S.W.R. **214-335-3425**

157' tower R-25, still in air, you take down, great cond. J Kesler, WOBZ, POB 446, Livingston KY 40445. 606-843-22A 9999.

Phelps-Dodge 3 bay FM, on 107.1, avail now, B/O, will trade. D Sports, WCLA-FM, POB 427, Clayton GA 30417. 912-739-3035.

Jampro 6 bay, w/radomes, 99.1 MHz. K Stone, KUTZ FM, 12710 Research Blvd #380, Austin TX 78759. 512-331-9191.

Shively 6813, 2 bay w/radomes, rebuilt and in factory boxes, 95.4 MHz, \$2400. B Bailey, WHYR, POB 567, Saco ME 04072. 207-284-9600.

Want To Buy

4 or 5 Bay CP FM antenna, tuned to 92.7, low power pref. S Greeley, 602-855-1051.

RF connector, BNC or Type N to 1 5/8 EIA flange. B Campbell, KRIG, 918-333-7943.

Stand by antennas on 104.3, 95.7 and 99.7. B Lacy, KEMA FM, 3611 Soncy 6A, Amarillo TX 79121. 806-355-4554.

AUDIO PRODUCTION

Want To Sell

ART 2001, stereo compressor, limiter, gate, de-esser, exciter, like new, \$300. K Thomas, Rebel Recording, 5555 Radio Lane, Jacksonville FL 32205. 904-388-7711.

Modulation Sciences Stereo Maxx, \$1000; CBS dyn EQ 4500, \$50. Orban 526A mono sib cntr, \$150; (3) Logitek AIA-200 phono preamps, \$50, Gorman Redlich EBS, \$250. D Matyis, KVET/KASE, 705 N Lamar, Austin TX 78703. 512-495-1300.

UREI 539 1/3 oct EQ (4), \$300 ea; UREI 525 crossover (4), \$325 ea; Crown MX-4 crossovers (4), \$195. R McMillen, Super Duper Audio Duplicating, 1634 SW Alder St, Portland OR 97205.

Teac AN-300, Dolby, 4 chnl, noise reduction, \$45; MXR (dbx type II) \$35; dbx 124 (type II) noise reduction, 4 chnl, \$45. G Dunn, 5383 Willow Lake Ct, Byron CA 94514. 510-516-0299.

CASSETTES • CARTS • REELS

J & I AUDIO/VIDEO

A wholesaler in the Radio and Television market. Now running SPECIALS on audio and video. BASF CASSETTES-AMPEX R-Rs AUDIOPAK, FIDELIPAC & ITC CARTS For more information call Kris Elliot at 1-800-942-1711 or write to: J&I Audio/Video 20899 Kelvin Pl. Woodland Hills, CA 91367

Circle (20) On Reader Service Card

Sennheiser wireless infrared stereo headphones & xmtr, little use, work great, \$150; dbx 4BX dynamic range expander, \$250. DigiDesign ProTools 8 track comp system, little use, new software, \$8500. R McMillen, Super Duper Audio Duplicating, 1634 SW Alder St, Portland OR 97205.

Eventide BD955, digital delay, \$875. B Hill, KALK, 106 S Jefferson Ave, Mt Pleasant TX 75455. 903-577-9770.

ITC

REPAIR • REFURBISHMENT • UPGRADE

Remanufactured machines available for sale or rent.

Direct from the only qualified ITC Cart Machine Repair Center

- All work warranted for 1 year minimum
- Service contracts available

Call Rusty

(800) 447-0414
(309) 828-1381



International Tapetronics Corporation
2425 South Main Street
Bloomington, IL 61704

ADC 96 & 144 Pr TT patchbays, exc cond, 1 rk space, 3 rows of 48, top 2 rows normalled, \$149, 96 is 2 row normalled, \$129 (you remove old wiring) or we totally refurbish w/new front panel, ready to install, \$199-229. TT cords up to 10 per bay at \$9 ea, reg \$13.95, also 1/4" bays. Audio Village, 619-320-0728, or Fax 619-320-2454.

Audiofile II, single column, 10 slots, 3 Audiofile I, various shape, 903 boards. B Bailey, WHYR, POB 567, Saco ME 04072. 207-284-9600.

Schafer Cetec 7000, Level II software, Audiofiles (2), ITC R/R (2), monitors (2), in operation, \$2500 firm. S Yates, KRBA/KUEZ 121 Calder Sq, Lufkin TX. 409-634-6661.

IGM-SW automation controller w/9 USC source cards, IGM Go-cart 24 w/GSI (3), IGM-EN FSK encoder w/television 905, IBM PS/2, manuals & cables, \$3500. L Collins, WJYY/WRCI, POB 1923, Concord NH 03302. 603-228-9036.

SMC DP-1 CPU, 24 deck Carousel, 5' 19" racks (6), Revox PR99 R-R tape, you freight it, \$3000. T Wetzel, KEXO, 715 Horizon Dr, Grand Jct CO 81506.

SMC MSP-1 automation system, 1984 model incl 2-450 bi-directional Carousels, 721 dual play cart drawer, remote head & power supply in SMC rack w/all manuals, \$1995/BO. B Christie, Grande Radio Group, POB 907, La Grande OR 97850. 503-963-4121.

Smartcaster, latest software, 7 day walk away, 5 hr rec time, exc cond, \$2500. J Schloss, KICD-AM/FM, 2600 N Hiway Blvd, Spencer IA 51301. 712-262-1240.

Looking for Audio Bargains?

We BUY ★ SELL ★ TRADE
QUALITY USED EQUIPMENT
317-962-8596



Demeter 4 ch rack mt tube direct box NEW \$795. W Gunn 619-320-0728.

Want To Buy

Fairchild 600 conac or 602 Conex high freq limiters. J Gangwer, 942 32nd St, Richmond CA 94804. 415-644-2363.

AUTOMATION EQUIPMENT

Want To Sell

Smartcaster 8K mono, will interface w/satellite, (2) 60 MEG hard drives, \$3900. B Hill, KALK FM, 106 S Jefferson, Mt Pleasant TX 75455. 903-577-9770.

HE HALL Electronics

1305-F Seminole Trail Charlottesville VA 22901

Here are just some of the bargains we have in stock:

ITC 3D mono cart player w/IE cards -	Rebuilt	\$ 1,695
Eventide H-3000B harmonizer - (1 only)	NEW	\$ 1,995
Harris CC-II Mono RP Cart Machine - Closeout -	Rebuilt	\$ 395
CRL 'DYNAFEX' DX-2 Stereo Noise Reduction -	Rebuilt	\$ 259
Marti MW-500 Microwave booster amp -	Rebuilt	\$ 1,295
Marti RPT-40 40 Watt RPU transmitter -	Rebuilt	\$ 895
LPB RC-25B Tube-type 20 Watt AM transmitter -	Rebuilt	\$ 295
Telos 10 Digital Hybrid -	Rebuilt	\$ 895
Orban 622B Stereo Parametric EQ -	Rebuilt	\$ 495
Aphex Broadcast Aural Exciter II -	Rebuilt	\$ 295
ATI BC8SR 8 Pot Console -	Rebuilt	\$ 1,295
Technics SL-1200 MK-II Turntables -	Rebuilt	\$ 195
Harris Diplomat 10 Pot Dual Mono Console -	Rebuilt	\$ 895
Harris Stereo Statesman 5 Pot Stereo Console -	Rebuilt	\$ 695
AKG BX20E1 Stereo Spring Reverb w/Remote -	Tested	\$ 395
ITC DCM-1 Cart Evaluation System (3 pcs.) -	Rebuilt	\$ 145

Call us for the Best New & Completely Rebuilt Equipment! (804) 974-6466

DYNAMAX

BROADCAST PRODUCTS BY FIDELIPAC

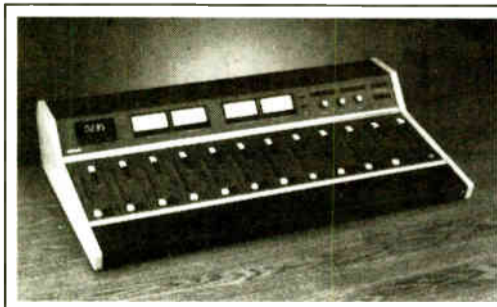

- True modular design
- Excellent RF immunity
- Prices start at under \$ 3,000.00!

Call us for your complete console needs!

HENRY RADIO

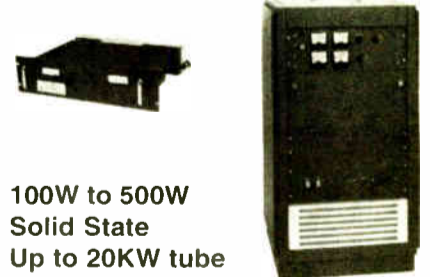

100W to 500W
Solid State
Up to 20KW tube

Call for new 2KW!

Your COMPLETE RF Source

- All Feedline Sizes
- Most Antenna Brands
- Wide Transmitter Selection

Fax: (804) 974-6450

Circle (216) On Reader Service Card

World Radio History

AUTOMATION EQUIPMENT...WTS

Format Sentry System complete w/never used DS1-700 hard drive, Pioneer 6-pack CD players (32), less than 2 years old, \$18,000. D McKay, KXTZ, 367 Water St, Henderson NV 89015. 702-564-6066.

BE Control 16 brains w/audio switchers (2); Otari ARS 1000 R-R in exc cond (5); working SMC Sonomag Carousels (2); SMC Sonomag Carousels good for parts (3); ITC triple slacker cart machine w/R/P; ITC triple slacker w/PB only, cabinets included. M Jones, WZKB, POB 520, Wallace NC 28466. 910-285-4900.

Want To Buy

NBC and Mutual detector boards to decode network automation signals. P Bjornstad, KDBS, 2100 W 11th, Eugene OR 97402. 503-686-6165.

CART MACHINES

Want To Sell

SMC 590, cart recorder in gd cond, mono R/P, newer style head gasket w/many spare parts, \$150. B Bailey, WHYR, POB 567, Saco ME 04072. 207-284-9600.

ITC Delta players, mono, vgc, \$675; Harris triple deck stereo, gd cond, \$600. K O'Malley, 804-446-1328.

Great Prices on original equipment tape heads for ITC, BI, Fidelipac, Otari, Tascam & others!

HE HALL Electronics

(804) 974 6466 • FAX 6450

ITC R/P mono, R/P, SP stereo playback, WRA stereo record amp, w/3 tones. D Matyis, KVET/KASE, 705 N Lamar, Austin TX 78703. 512-495-1300.

Audi-Cord S series PB (3), 3 tone, gd cond w/spares, \$500. J Schloss, KICD-AM/FM, 2600 N. Hiway Blvd, Spencer IA 51301. 712-262-1240.

Rapid-Q mono player, \$95. G Dunn, 5383 Willow Lake Ct, Byron CA 94514. 510-516-0299.

ITC R/P, exc cond, \$750. R Statham, WSTU/WHLG, 1000 NW Alice Avenue, Stuart FL 34994. 407-692-1000.

BE 5300C tripledeck, stereo, PB, mint less than 50 hrs, BO. R Kaufman, Pams Prods, POB 462247, Garland TX 75046. 214-271-7625, after 3PM CDT.

Want To Buy

Ethnic community stn, in need of low cost mono cart machines w/tones, need R/P & P/B machines, minor repairable units ok. P Ryan, KYMC, 2122 Marconi Ave, St Louis MO 63110. 314-664-7080.

ITC 800 series mono R/P (2), deck PB (2); mono R/P stereo (2); Gates stereo 10 chnl board. D Thompson, Bdct Engr Consultants, 2740 Cherry Ln, Walnut Creek CA 94596. 510-933-4881.

ITC, BE, Fidelipac cart machines: single, triple, mono, stereo, play & record/play. Call M O'Drobinak @ 619-758-0888.

CASSETTE & REEL-TO-REEL RECORDERS

STUDER SERVICE SPECIALIST

Thousands Serviced • Unbeatable Rates
Precision Capstan Resurfacing
Audio Advantage
Tel (615) 742-3834
PRICE-QUALITY-SERVICE
Let Us Prove It

Want To Sell

Teac AH101S like new w/box, \$150; Teac A1500U, like new, low hrs, \$200; Pioneer RT701, new heads, \$300; Viking Telex RD84, record amps (3), \$80 ea. J Parsons, 2781 Fayson Circle, Deltona FL 32738. 904-532-0192.

Crown SX-722 stereo R-R 1/2 trk recoder, \$300. G Hultman, Hultman Media, 300 Limp Creek Rd, Grants Pass OR 97527. 503-474-6466.

Revox A-77 10.5" open reel recorder, 3.75, 7.5 ips, 4 trk, needs minor work, would consider trade. D Fields, POB 194, Avoca AR 72711. 501-451-8803.

Tascam 688 MIDI studio, 8 trk recorder/mixer, mint cond, \$1800. N Hersh, UN Radio, 212-353-3410.

Revox A7, (6) 1/2 trk, 3 high speeds, 3 low speeds, \$100/ea; B77 (2) 1/2 trk, low speed, \$300/ea. D Matyis, KVET/KASE, 705 N Lamar, Austin TX 78703. 512-495-1300.

REVOX PARTS/SERVICE

Cassette-CD-Open reel
Rebuilt B77s, \$900.⁰⁰
Capstan resurfacing, ALL BRANDS.
JM TECHNICAL ARTS
30 Music Sq. W. #156
Nashville, TN 37203 (615) 244-6892

Otari ARS 1000 (2) gd cond, w/25 Hz, \$400/ea. B Hill, KALK FM, 106 S Jefferson, Mt Pleasant TX 75455. 903-577-9770.

Sony F1, digital PCM for 2 ch link, or recording on VCR (2), \$1800/both. T Markham, The Warehouse Studio, 2071 Emerson St, Jacksonville FL 32207. 904-399-0424.

Otari Pro+4, 16tk MX70, gd cond, w/text tapes & remote, BO; Fostex D20 time code DAT w/Sony control 9 pin, \$4500. 412-281-4470.

Sony PCM-F1 digital recording system modified w/Apogee input filters and external sync input, system capable of locking to external video house sync, incl 2 SL-2000 portable Beta recorders, AC power supplies, NiCad batteries, tuner-timer module, cables, road case, complete system \$1500; F1 processor only \$1000. R Streicher, Pacific Audio-Visual Enterprises, 545 Cloverleaf Way, Monrovia, CA 91016. 818-359-8012.

Ampex 440C, 4 trks, 4 & 2 trk, headsets, roll-around, nds work, pick up only, \$400. 212-219-3670.

Sony/MCI JH-24 24 track, 2" multitrack master recorder w/add'l 16 trk head stack, full locator, very gd cond, all manuals, one owner, lots of life, \$15500 FOB Austin TX. J Block, Production Block Studios, 906 E 5th St, Austin TX 78702. 512-472-8975.

Akai 6 x 9, 3 motor, 3 head, \$50; Toshiba PC G30, 2 motor 2 head, \$30; Sony TCM 5000 EV, portable, \$125. G Dunn, 5383 Willow Lake Ct, Byron CA 94514. 510-516-0299.

Otari MX5050BII (2) at DIRT CHEAP prices for P/T at NCE-FM station. Robert 214-226-2949.

Tascam 322 channel recorder/reproducer, exc cond, remote, \$700; remote dbx unit control signal, punch in/out remote. 619-582-3356.

Sony F1 digital PCM (2) for 2 ch link or rec on VCR, \$1800 both. T Markham, The Warehouse Studio, 2071 Emerson St, Jacksonville FL 32207.

Tascam DA-30 digital audio tape deck, new, remote control, users manual, warranty, \$995 + shipping. D Lent, WHKS Radio, 817 N Main St, Port Allegany PA 16743. 814-642-7004.

Revox PR99 (2) one working, \$1800; one not working, \$500/BO. J Kesler, WOBZ, POB 446, Livingston KY 40445. 606-843-9999.

Sony TCD-D7 portable recorder, \$600. R Suracci, Fine Art Productions, 67 Maple St, Newburgh NY 12550. 914-561-5866.

Otari 5050 MK III-8 trk, heads excellent, \$2450. Wayne Gunn 619-320-0728.

METROTECH
DICTAPHONE
LOGGERS
PARTS AND
SERVICESEQUOIA
ELECTRONICS

4646 Houndshaven Way
San Jose, CA 95111
(408) 363-1646
FAX (408) 363-0957

Scully '100' recorders, record/play amps, 8, 16, 24 track heads. Sequoia Electronics, 4646 Houndshaven Way, San Jose CA 95111. 408-363-1646.

Otari Mark II-IV 1/2" 4-track, multi-track, mint, less than 50 hours, Best Offer. R Kaufman, Pams Productions, POB 462247, Garland TX 75046. 214-271-7625, after 3PM CDT.

16 track 2" \$3450, MCI JH110C-8 \$2800, 110C-8 play only \$500, ATR800 mono or Tascam 7300 or 2502 \$600 ea, MCI Locator III \$1195, Tascam 52 2 trk \$1200, Ampex AG350 electr \$50/ch. W Gunn 619-320-0728.

CLEAN PATCH BAYS
NO DOWN TIME

VERTIGO BURNISHERS AND INJECTORS
RESTORE ORIGINAL PERFORMANCE
TO YOUR PATCH BAYS

\$34.95 Ea.

VERTIGO RECORDING SERVICES

12115 Magnolia Blvd #116 818-907-5161
North Hollywood, CA 91607 Fax 818-784-3763

Recordex 6 cassette rewriter \$100; Tascam 40-4 4 track 10" in flight case with free dbx \$750; MRL new short test tapes \$39 for 1/4" to \$199 for 2". W Gunn 619-320-0728.

Want To Buy

Portable R/R recorder with built-in speaker, must accommodate 1/4" mono tapes on 5" & 7" reels, must play at 7.5 & 15 ips, good working condition. S Vainrib, Vainrib Audio Productions, 764 Dividing Ridge Dr, Birmingham AL 35244. 205-987-5198.

Tascam 58 1/2" 8 trk wanted to buy or trade for Otari 5050 MK III-8 or...? Wayne Gunn 619-320-0728.

Ampex ATR100 taperecorders for parts. Circuit cards, heads, motors, machine parts, or electronic parts. Call 818-907-5161.

Ampex tube recorders and mixers. W Gunn, 619-320-0728.

CD PLAYERS

Want To Sell

Denon 950FA, perfect condition. \$650. K Thomas, Rebel Recording, 5555 Radio Lane, Jacksonville FL 32205. 904-388-7711.

Denon 950FA, CD players (2), good condition, rebuilt, \$750 each. J Leutzinger, KIXQ FM, 2620 Dogwood Rd, Joplin MO 64801. 417-624-1310.

Want To Buy

CD controller, hardware &/or software to control Pioneer 18 disc CD players, for continuous music service. G Finney, WPMW, 7137 Heather Lane, Macon GA 31206. 912-788-2124.

COMPUTERS

Want To Sell

Tektronix 4662 interactive digital plotter, complete with 3 complete sets RGBB colored pens and IBM compatible software, pens fresh, very good condition, \$950. C Stuart, POB 1236, Susanville CA 96130. 916-257-2702.

IBM RT-PC A1X, about 60 programs, adv operating, interactive system, will trade; Samsung Syncmaster, SVGA 14", \$360. R Suracci, Fine Art Productions, 67 Maple St, Newburgh NY 12550. 914-561-5866.

Want To Buy

Tandy 6000HD w/at least 1 floppy drive. Mel Crosby, 408-363-1646, FAX 408-363-0957.

EMPLOYMENT

To place ads in this section, use the ActionGram form. To respond to box numbers write Radio World, PO Box 1214, Falls Church, VA 22041. Attn: _____

POSITIONS WANTED

Bdcting school grad, at end of road, aspiring to be top of the heap. Dallas, 405-848-5334.

Hard working guy willing to work in country or contemporary Christian stn, can handle on-air, production or news. S Weller, 918-258-5154.

14 yr pro from Akron-Canton seeks FT AOR, CHR, or Hot AC gig. R Allen, 216-773-1549.

I know there is a position open for a creative, fun-loving, hardworking air personality who likes to exp with production. Brad, 405-722-2846.

Agree experience isn't only years, tapes? Full time announcing, programming aspiration, computer literate, in radio since 1980, announcing, marketing experience. Janet, 502-895-5888.

Let's make millions together! Programming, sales & technical genius with exclusive new talk/music format, looking for major market to kick it off. Bill, 813-844-3823.

Marketable, motivated air-talent seeks change, medium/major market, exp with many fmts, currently doing A/C, great references. Jay, 413-532-9135.

News, Wx, Sports & Sidekick guy w/degree willing, for reasonable \$ and job satisfaction, to move to your station, and begin contributing day one. Jim, 208-234-7549.

Recent graduate with on-air, journalism, production & sales experience, seeking news or production position, looking for a challenge. J Johnson, 336 NE 178th St, Seattle WA 98155. 206-364-7808.

True entertainment value w/unique style, witty, cynical, confident, copywriting and prod whiz kid. Tom, 918-622-2079.

Account Executive with 20 years media sales, ad and promo experience seeks position in Tucson, Phoenix or San Diego market. B Lukas, 602-750-9211.

HELP WANTED

Combo air personality/sales for suburban country format. Salary plus generous commission. WKMB, 1390 Valley Rd, Stirling NJ 07980.

LIGGETT BROADCAST, INC. seeks Chief Engineer for WJIM AM/FM & WFMK FM, Lansing, MI. Senior SBE Certification with minimum three years experience as chief required. Must have thorough understanding of AM/FM transmitters, RPU, STL, studio equipment and digital audio systems. Computer skilled. EOE. Show history of stable employment. Send resume, references, salary history to James A. Jensen, President, Liggett Broadcast, Inc., 160 E. Grand River Ave., Williamson, MI 48895.

CHIEF ENGINEER: Immediate opening for Chief Engineer for 4 Class B FM radio stations in one of the most attractive cities in the Midwest. Minimum of 5 years experience and S.B.E. certification required. Knowledge of high power Continental and Harris FM transmitters is essential, along with the ability to troubleshoot audio and RF equipment to the component level. Stations are currently upgrading from analog to digital in both production and on-air environments. Salary \$35,000+. Full medical package, car, 401(k) plan. EOE, M/F/H. Please send resume with at least 3 professional references to:
**Mr. Charles Stone
Broadcast Services
1650 Tysons Blvd.
Suite 790
McLean, VA 22102**

AM/FM (AC/CHR) combo in central NJ seeks engineer for part time wk. Applicant should have prior radio experience, specifically studio maintenance. We are building new studios, installing new computer network, and upgrading transmitter plants. Chief Engineer swamped. If you are looking for a foot in the door, this could be it. J Hadden, POB 9750, Trenton NJ 08650.

West Coast RF manufacturer seeks Sales Engineer to provide engineering assistance to sales department. Also seeking Salesperson for Latin American territory (bi-lingual Span./Eng a must). Send resume to: Radio World, POB 1214, Falls Church, VA 22041. Attn: Box # 94-05-04-01RW.

CHIEF ENGINEER - Colorado Mtn Radio Group needs all around engineer to construct & maintain studio, transmitter, computer automation. Applicant needs to be able to deal with high altitude remote sites. We are an EOE Employer. Contact Marty Hijmans: 303-949-0140.

CHIEF ENGINEER
Virginia broadcast group seeking FM broadcast engineer with several years experience. Requirements: Technical school graduate, SBE certified, proficient at troubleshooting audio quality, radio station RF and studio systems, strong PC and digital system knowledge. Send resume and salary requirements to
Radio World, Box 1214
Falls Church, VA 22041
Attn: Box #94-04-20-01RW EOE, M/F

CONSOLES

Quantum 12A mixing console, highly modified for live concert recording applications, incl ATA road case, \$1300; Fostex 2050 line mixer, ten (8+2) line level inputs, stereo outputs, incl rack mount adaptors, \$100. R Streicher, Pacific Audio-Visual Enterprises, 545 Cloverleaf Way, Monrovia, CA 91016. 818-359-8012.

Russco Mono 505, rack mount (1), table top (1), \$250 ea. J Parsons, 2781 Fayson Circle, Deltona FL 32738. 904-532-0192.

Soundcraft Spirit 163 mixing console, 16 inputs, sep assignable stereo and mono outputs plus 4 aux busses, modification incl pre/post fader switches for Aux-2, tape return to monitor, line level monitor outputs, mono-sum to monitor, exc cond, \$1550. R Streicher, Pacific Audio-Visual Enterprises, 545 Cloverleaf Way, Monrovia, CA 91016. 818-359-8012.

Arrakis 500SC exc cond, 8 chnl stereo, will trade for studio or air processing, \$1750. B Hill, KALK FM, 106 S Jefferson, Mt Pleasant TX 75455. 903-577-9770.

Collins 2125-1 stereo broadcast console and 260S-1 expansion unit for 8 chnls, w/shop manual and extra parts/cards, in working cond, \$395 + shipping. M Masters, 312-777-1700.

Gately Prokit mixer, reverb & equalizer, rough, \$75. 212-219-3670.

EV/Tapco 100M pwr mixer, 10 inputs, 2 built-in 150 W amps, phantom pwr, monitor send, reverb, 16 band EQ, slide faders, only 36 lbs, w/case, \$800/BO. R Shull, WFAS AM/FM, POB 551, White Plains NY 10602. 914-693-2400.

Radio Shack 32-1200, 3 mic w/pn post, 2 line, 2 turntable inputs, cue & headphone amp, \$50; Gates Yard, 6 chnl wall parts except electronics, \$100. G Dunn, 5383 Willow Lake Ct, Byron CA 94514. 510-516-0299.

BE 5S250, 5 channel, \$2175/BO, BE 5S25 8 channel stereo, \$3000. J Kesler, WOBZ, POB 446, Livingston KY 40445. 606-843-22A 9999.

Auditronics 501 26 inputs, 16 outputs, built in patch bay, 4 effects sends, 4 effects returns, 6 aux sends, flexible routing, \$4900. T Burr, KSFO, 300 Broadway, San Francisco CA 94133. 415-398-5600.

Auditronics 110, 12 mono chnls w/faders, 2 stereo chnls, 3 remote starts, inc Auditronics PS-30 w/nice custom console furniture w/space for 2 deck mounted R-R recorders, \$850. B Lacy, WAVQ FM, 3611 Soncy 6A, Amarillo TX 79121. 806-355-4000.

Ramko DC5AR 5 channel mixers, vgc, \$225 each. 916-725-2434.

DISCO-PRO SOUND
EQUIPMENT

Want To Sell

SAE click & pop impulse noise reduction unit, \$185/BO. D Elliot, 25 San Raphael, Monarch Beach CA 92629. 714-489-5787.

Fender 6 input, 400 W. R Suracci, Fine Art Productions, 67 Maple St, Newburgh NY 12550. 914-561-5866.

ABOUT OUR EMPLOYMENT SECTION

HELP WANTED: Any company or station can run "Help Wanted" ads for \$1.50/word or buy a display box for \$60/column inch. Payment must accompany insert, use your MasterCard or VISA; there will be no invoicing. Blind box numbers will be provided at an extra charge of \$10. Responses will be forwarded to listee, unopened, upon receipt. Call 800-336-3045 for details.

POSITIONS WANTED: Any individual can run a "Position Wanted" ad, FREE of charge (25 words max), and it will appear in the following 2 issues of Radio World. Contact information will be provided, but if a blind box number is required, there is a \$10 fee which must be paid with the listing (there will be no invoicing). Responses will be forwarded to the listee, unopened.

Mail to: BROADCAST EQUIPMENT EXCHANGE
PO Box 1214, Falls Church, VA 22041
Attn: Simone Mullins

DISCO-PRO SOUND EQUIP...con't

Want To Buy

UREI filter set. D Elliot, 25 San Raphael, Monarch Beach CA 92629. 714-489-5787.

FINANCIAL SERVICES

EQUIPMENT FINANCING ON ALL RADIO EQUIPMENT

- Easy to qualify
- Fixed-rate, long-term leases
- Any new or used equipment
- 100% financing, no down payment
- No financials required under \$50,000
- Refinancing existing equipment



Call Mark Wilson (800) 275-0185

LIMITERS

Want To Sell

Optimod 8100, \$2500; 8000, \$1000. K Law, KIAI, 341 S Yorktown Pike, Mason City IA 50401. 515-423-1300.

Altac 1591A compressor, \$225. A Garen, KPDC, 5110 Stark, Portland OR 97215. 503-231-7800.

Aphex 104 Aural Exciter with Big Bottom, like new, \$200. K Thomas, Rebel Recording, 5555 Radio Lane, Jacksonville FL 32205. 904-383-7711.

CRL stereo preparation processor 5PP-80C, \$1300; CRL AM stereo matrix processor, \$1600/BO. J Kesler, WOBZ, POB 446, Livingston KY 40445. 606-643-22A 9999.

FOA 105B CRL SMC-600A stereo modulation controller, \$250. B Lacy, WAVQ FM, 3611 Soncy 6A, Amarillo TX 79121. 806-355-4000.

Want To Buy

Fairchild 670 or 660 tube compressor/limiter, Teletronics LA-2A tube compressor/limiter or UREI LA-3A solid state compressor/limiter, call after 3PM CST. 214-271-7625.

903 (looking for 4) and 905 (looking for 2), just the modules, not the frame. R Streicher, Pacific Audio-Visual Enterprises, 545 Cloverleaf Way, Monrovia, CA 91016. 818-359-8012.

AKG C422EB large diaphragm stereo microphone, including remote pattern selector, 20 meter cable, windscreen and shockmount, excellent condition, \$1850; AKG D-140 dynamic cardioid mics, \$225/pair. R Streicher, Pacific Audio-Visual Enterprises, 545 Cloverleaf Way, Monrovia, CA 91016. 818-359-8012.

Urban Optimod 8000 and 8100; Harris stereo triband AGC. B Lacy, KEMA FM, 3611 Soncy 6A, Amarillo TX 79121. 806-355-4554.

MICROPHONES

Want To Sell

EV RE-15 in mint cond (2), \$200. M Harrington, 501-223-9056

RCA 77DX (1), RCA 44BX (1), both in exc cond, BO over \$800 for either. R Bums, RF Studios, 1326 Highmeadow Drive, Garland TX 75040. 214-271-4386.

TEAC ME-120 matched pair; electret, slim, both omni & cardioid elements, windscreens, batteries, orig cases, mike stand adaptors, \$99 for both. J Sunier, Sunier Productions, 21 Stetson Ave, Kenfield CA 94904. 415-457-2741.

Electro Voice EV20, like new, only slightly used, \$275. D Bohanan, Bohanan Broadcasting, POB 21829, St Simons Island GA 31522. 912-638-9502.

Audio Technica C87, \$125 mic flags w/your logo. R Suracci, Fine Art Productions, 67 Maple St, Newburgh NY 12550. 914-561-5866.

Nady 151 VR wireless, lavalier, \$60. G Dunn, 5383 Willow Lake Ct, Byron CA 94514. 510-516-0299.

Manley Labs CR3A, new, \$795 w/shockmount, windscreen & case, no risk trial in your studio. Also have used mics & everything else. Get our catalog! Liberal trade policy too. Audio Village, 619-320-0728.

Telefunken, Sheeps, Neumann, AKG tube mics. Telefunken, Siemens, Tab tube mic pre's. RCA, WE, mics sale or trade. Tracy 615-821-6099, no calls after 10PM EST.

Want To Buy

Ethnic community stn, in need of gd low cost mics and mic preamps. P Ryan, KYMC, 2122 Marconi Ave, St Louis MO 63110. 314-664-7080.

CBS or NBC call letter plate for RCA 44 mic. M Harrington, 501-223-9056.

Shock mount for RE-20. B Holloway, WPGU, 204 E Peabody Dr, Champaign IL 61820. 217-333-2016.

RCA 77DXs/44BXs ribbon, chrome/TV grey, gd cond, BO. R Kaufman, Pams Prods, POB 462247, Garland TX 75046. 214-271-7625, after 3PM CDT.

Neumann U87s, KM84s, AKG 451s, EV RE20s, Sennheiser 421s. W Gunn 619-320-0728.

77-DX's, 44-BX's, WE KU-3A's On-Air lights, recording lights & audition lights. Top price paid. Fast response. Bill Bryant Mgmt, 2601 Hillsboro Rd, G12, Nashville TN 37212. 615-269-6131, FAX: 615-292-3434.

MISCELLANEOUS

Want To Sell

19" equip racks, floor rack w/wheels, 76" of rack space ea (2), \$75; 48 jack patch bay with many patch cables, \$100. G Dunn, 5383 Willow Lake Ct, Byron CA 94514. 510-516-0299.

JVC HR-S10U portable VHS recorder w/companion tuner/timer unit, \$300 complete. R Streicher, Pacific Audio-Visual Enterprises, 545 Cloverleaf Way, Monrovia, CA 91016. 818-359-8012.

AUDIO TRANSFORMERS

- LOW DISTORTION 2% THD @ 30 Hz
- BROAD FREQUENCY RESPONSE 10 Hz - 20,000 Hz
- MAGNETIC SHIELDING 10-30 60 dB
- VARIOUS MECHANICAL CONFIGURATIONS
- 60+ TYPES STOCKED FOR DELIVERY

DISCOUNT ON PREPAID ORDERS PLUS FREE SECOND DAY AIR

FREE CATALOG OF AUDIO ACCESSORIES

USA & CANADA ORDERS (800) 634-3457
FAX ORDERS (800) 551-2749

SESCOM, INC.
2100 WARD DR
HENDERSON NV 89015 USA
TECH LINE 1-702-565-1993 M-F 9am to 4pm (PST)

Circle (170) On Reader Service Card

Furman PB-40 Patch Bay, 1/4" plugs on front, RCA jacks on back, \$50. G Hultman, Hultman Media, 300 Limp Creek Rd, Grants Pass OR 97527. 503-474-6466.

Qume QVT-101 serial ASCII data terminals (4), great for remote dial-in, studio-to-control room comm, compatible w/Gentners VRC-2000 for auto logging, \$35 ea. G Finney, WWPWB, 7137 Heather Lane, Macon GA 31206. 912-788-2124.

Mitsubishi C3479CP, RGB, excellent condition, \$700 + shipping. R Suracci, Fine Art Productions, 67 Maple St, Newburgh NY 12550. 914-561-5866.

65 kW, 3 phase generator, manual transfer, auto start, diesel, excellent condition, low hour, \$8500. J Schloss, KICD-AM/FM, 2600 N Hiway Blvd, Spencer IA 51301. 712-262-1240.

Rotron Blowers for Elcom, Harris, CCA, CSI, McMortin, rebuilt & new. Goodrich Enterprises Inc. 11435 Manderson St, Omaha, NE 68164. 402-493-1886 FAX 402-493-6821

Parts for RCA BC-15/BC-18 consoles; parts for RCA RT27/BA 27 mono cart machines, esp motors & pinch rollers; Xtal 90.7 MHz, for Gates M6095 exciter, T9-D holder; Gates FM 250B blower for RF deck and interlock for rear door panel. B Wick, WYRS, POB 545, Manahawkin NJ 08050. 609-597-8089.

Uniden UST-5000 sat receiver with baseband output, Kenwood KA-3500 40 W stereo amplifier, Kenwood KT-5300 AM/FM tuner, Realistic 5 band equalizer, BE Spotmaster 500C cart machine, Teac X-3 MK3 7" reel deck, Best Offer on any component. G Finney, WWPWB, 7137 Heather Lane, Macon GA 31206. 912-788-2124.

Gentner Versa Patch, good condition, \$150. B Lacy, KEMA FM, 3611 Soncy 6A, Amarillo TX 79121. 806-355-4554.

Patch Cords ADC Bantam Pro Patch, 6", 12", & 18". Brand new, never used, \$5 ea + shpg. Will talk quantity or trade for stuff. KEES Engineering, 609-859-0994.

Want To Buy

Radio transformers by Chicago, UTC, Triad, Peerless, Freed, Sola, send list. J Gangwer, 942 32nd St, Richmond CA 94804. 415-644-2363.

Jazz record collections, 10" LP/12" LP be-bop, swing, dixie, highest prices paid. B Rose, Program Recordings, 228 East 10th, NUNY 10003. 212-674-3060.

MONITORS

Want To Sell

C-QUAM monitor, \$3000. J Kesler, WOBZ, POB 446, Livingston KY 40445. 606-843-22A 9999.

Belar FMM-2 & FMS-2. M O'Drobinak, 619-758-0888.

Want To Buy

EBS Receiver encoder/decoder. B Wick, WYRS, POB 545, Manahawkin NJ 08050. 609-597-8089.

McMartin TBM 4500 stereo FM mod monitor; McMartin TBM 4500 FM frequency monitor. D Thompson, Broadcast Engineer Consultants, 2740 Cherry Ln, Walnut Creek CA 94596. 510-933-4881.

McMartin (buy & sell) any model. C Goodrich, 11435 Manderson, Omaha NE 68164. 402-493-1886 or fax 402-493-6821.

RECEIVERS & TRANSCEIVERS

Want To Sell

AM STEREO RECEIVERS
From \$34.95 Portable, Home, Auto
RRADCO
Phone/FAX 708-513-1386

Denon DRA-95VR 65 w/CH, pre-main loop, wireless rem, manual, black, lk new in box, will consider trade. D Fields, POB 194, Avoca AR 72711. 501-451-8803.

SCA RECEIVERS—ALL TYPES

Reading Service / Ethnic / Data Professional / Table
Will work to meet your receiver needs

DAYTON INDUSTRIAL CORP.
(Manufacturer)
2237 Industrial Boulevard
Sarasota, FL 34234
Tel: 813 351 44545 FAX: 6081

Motorola SP3113171 Type CC3155 multi XFL, 2 freq repeater, carrier squelch & PL100.0 Hz, 10 W, RX158 MHz, TX152 MHz, \$500. B Dickerson, WEAG AM-FM, 1421 S Water St, Starke FL. 904-964-5001.

Broadcast quality SCA modules. Why pay a bundle when you can buy factory direct from Background Music Engineering, 1-800-944-0630.

IN ADDITION TO GCR-201 CONTACTORS, WE MANUFACTURE GCR-501

- 40 Amps
- 40 kV
- Free Carona Rings

GELECO:

Ph: (416) 421-5631
Fax: (416) 421-3880

REMOTE & MICROWAVE EQUIP

Want To Sell

Broadcast Products super roving radio, 28" self contained trailer, looks like giant boom box, complete w/air, elec heat & 6500 W Honda built-in generator, \$25000. D Brown, CHYM/CKGL, 305 King St W, Kitchener, Ontario N2G 4E4. 519-743-2611.

Moseley digital remote control system, DRS-1 control terminal, remote terminal, selection unit (2), status panel (2); DLS-1 sampling terminal, sampling interface, printing terminal; TAU-3 tolerance alarm unit. B Lacy, WAVQ FM, 3611 Soncy 6A, Amarillo TX 79121. 806-355-4000.

Mobile Remote Unit, boombox, fully self contained, great atn getter, excellent condition. W Grant, WZBQ, Drawer 4, Tuscaloosa AL 35402. 205-339-3700.

RENTALS RENTALS RENTALS

COMREX 3-line extender

Frank Grundstein 215-642-0978
Audio/Video Consultants

Hilo Mast NK-9, 32 ft collapsible mast for remote vehicle, 25 lb air pressure to raise, locking collars, \$1300/BO. W Borneman, WBYN, 280 Mill St, Boyertown PA 19512. 610-369-7777.

Burk TC-8, 5 yrs old, exc cond, in use, w/manuals & interface, \$1100. J Murphy, WMXO/WMNS, 118 W Henley St, Olean NY 14760. 716-223-3591.

Comrex 3XR 3-line decoder, with remote control. Perfect condition. \$2950. S Kirsch, Silver Lake Audio, 2590 Hillside Ct., Baldwin NY 11510. 516-623-6114.

Want To Buy

Marti, TFT, or equiv 450 MHz rcvr, pref dual freq. P Bjornstad, KDBS, 2100 W 11th, Eugene OR 97402. 503-686-6165.

Remote pickup system in 450 band; satellite RX system, C baud, Zephyrs. B Wick, WYRS, POB 545, Manahawkin NJ 08050. 609-597-8089.

Moseley 303, composite STL. B Lacy, KEMA FM, 3611 Soncy 6A, Amarillo TX 79121. 806-355-4554.

950 MHz STL dishes, 4' (2). B Lacy, KEMA FM, 3611 Soncy 6A, Amarillo TX 79121. 806-355-4554.

SATELLITE EQUIPMENT

Want To Sell

Adcom 7550 exc cond, BO or trade. B Hill, KALK FM, 106 S Jefferson, Mt Pleasant TX 75455. 903-577-9770.

Scientific Atlanta 7450 receiver with AD7007 down converter, AD7010 demod & AD6305 block converter, with manual, 2 yrs old, \$1500.

PHONE: 703-998-7600 FAX: 703-998-2966



Call Simone Mullins, Classified Ad Manager, to reserve space in the next issue. Use your credit card to pay, we now accept VISA and MASTERCARD.

Radio World

5827 Columbia Pike, 3rd Floor
Falls Church, VA 22041

Select from these categories for best ad positioning:

- | | | |
|----------------------------|---------------------------|--------------------------|
| Acoustics | Consoles | Software |
| Amplifiers | Disco-Pro Sound Equip. | Stations |
| Antennas & Towers & Cables | Financial Services | Stereo Generators |
| Audio Production (Other) | Leasing | Tapes, Carts & Reels |
| Brokers | Limiters | Tax Deductable Equipment |
| Business Opportunities | Microphones | Test Equipment |
| Cart Machines | Miscellaneous | Transmitter/Exciters |
| Cassette & R-R Recorders | Monitors | Tubes |
| CD Players | Receivers & Transceivers | Turntables |
| Computers | Remote & Microwave Equip. | Positions Wanted |
| | Satellite Equipment | Help Wanted |

Classified Advertising Rates Effective January 1, 1994

	1x	3x	6x	12x
1-9 col inch (per inch)	\$60	58	54	49
10-19 col inch (per inch)	55	52	49	44
Distributor Directory	100	95	90	85
Professional Card	65	60	55	50
Classified Line Ad		\$1.50 per word		
Blind Box Ad		\$10 additional		

To compute ad costs: Multiply the number of ad inches (columns x inches) by the desired rate schedule for your per unit cost. Example: a 3" ad at the 1x rate is \$180, at the 3x rate \$174, at the 6x rate \$162, at the 12x rate \$147, etc.

DISTRIBUTOR DIRECTORY

The following distributors serving the broadcast industry would be glad to help you with any of your requirements.

...earthquake jars the west, hurricane pounds the east, blizzard blankets the north, tornado sweeps up the middle, and rain in Georgia...

RADIO! The beat goes on!
CROUSE-KIMZEY OF ANNAPOLIS

tops in broadcast equipment
1-800-955-6800
ask for Kathleen

CORNELL-DUBILIER MICA CAPACITORS

FROM STOCK

JENNINGS VACUUM CAPACITORS

FROM STOCK

JENNINGS VACUUM RELAYS

SURCOM ASSOCIATES

2215 Faraday Ave., Suite A
Carlsbad, California 92008
(619) 438-4420

SATELLITE EQUIPMENT...WTS

K Austin, KFXI, 1101 Hwy 81 N, Marlow OK 73055, 405-658-2556.



Need a New Digital Satellite Receiver for DATS/"SEDAT"? New DATS 7.5/15? New 3.5 Voice Cue? "SEDAT" Cards? We are shipping now! We can even convert your S/A 7300/7325!

Zephyrus for JSA Zephyrus 700 SPCP

We Repair & Rebuild all Popular Receivers Quick Service!

Satellite Systems (719) 634-6319

Wegener 1601 series w/1606-52 receiver card, 1626 dual demod, 1648 tone decoder, 1683-08 translator, 1644-01 relay cards (3), 1605-12 power supply, originally set up for Moody Broadcasting, \$900. G Finney, WPWB, 7137 Heather Lane, Macon GA 31206. 912-788-2124.

OuterSpace Experts!

We SELL *TRADE *BUY SATELLITE EQUIPMENT 317-962-8596



Adcom 7550, like new, \$1500. B Hill, KALK, 106 S Jefferson Ave, Mt Pleasant TX 75455. 903-577-9770.

Wegener main frame and mini-main-frame for Unistar. P Baillon, KMCM/KMTA, 1218 Pioneer Bldg, St Paul MN 35101. 612-222-5555.

Want To Buy

Fairchild or SA digital receiver. W Thomas, WIRO/WMLV/ POB 292, Ironton OH 45638. 614-532-1922.

SERVICES

NRSC PROOFS

For \$500, you can comply with the new \$73.44 spec & have the documentation in hand to prove it!

MICROWAVE FREQUENCY SERVICES

Services available in Southern Central CA, AZ and NV. Group discounts available

Call 1-800-2-GET-LEGAL
fax 310-425-6299 avail 24 hrs

Fairchild Dart 384 needs voice cue. J Poole, KMAG-KWHN, 423 Garrison Ave, Ft Smith AR 72901. 501-782-8888.

SOFTWARE/ DATABASES

Want To Sell

PC SOFTWARE for Broadcasters. Traffic, Billing, & Accounting. Powerful, inexpensive. Works with automated, satellite or live operations. INTERFACES with popular DIGITAL AUTOMATION SYSTEMS. Try it for 90 days, no obligation.

Absolute Broadcast Automation
Naples, Florida (813) 643-3689

U.S. RADIO STATION DATABASE: stand-alone program containing 11,700+ stations. Many searches, prints mailing labels. MAC/IBM (specify disk size). Visa/MC \$99.95/yr. (+quarterly updates):

1-800-626-2360 ext. 300
BBH Software, Inc.

Circle (39) On Reader Service Card

STATIONS

Want To Sell

Investors for new FM station to be built in Rocky Mountain area, 25 kW, good university town, serious investors only, no job seekers. Hawkeye Radio, 5546-3 Century Ave, Middleton WI 53562.

AM Station in lake reion of SE Kentucky, on 1590 with night power, with 2000 square foot brick building, tower, 5 acres on major highway, all equipment, priced to sell. J Kesler, 606-843-9999.

CP-25 kW in Rockies, 2 hrs from Denver, serious inquiries only. Hawkeye Radio, 5546-3 Century Ave, Middleton WI 53562.

Person to lease/purchase station for small beach town on West coast of FL, monthly payments as low as \$4000. B Lacy, WAVQ FM, 3611 Soncy 6A, Amarillo TX 79121. 806-355-4000.

Want To Buy

Bdct group seeks FM commercial stn in IN, IL, OH, MI. Vera, POB 48267, Evergreen Park IL 60642. 312-445-9200.

STEREO GENERATORS

Want To Buy

SCA generator, 67 kHz for music application. G Finney, WPWB., 7137 Heather Lane, Macon GA 31206. 912-788-2124.

TAPES/CARTS/REELS & CD's

A&D Cart Rebuilding

Do Bad Carts Have Your Temperature Rising?

Let A&D clean, load & pack your carts. They'll be serviced within 10 working days! *Guaranteed!*

3706 Void Ct. 715-835-7347
Eau Claire WI 54701 Fax: 715-835-1151

Want To Sell

Audiopak AA-3, more than 300, from :40 to 7:30, \$2 ea. M Siegel, 800-560-6670.

Scotchcart II's, 1000 btwn :40 & 7:00, most are btwn 2:30 & 5:00, all in exc cond, \$1.89 ea. R Burns, RF Studios, 1326 Highmeadow Drive, Garland TX 75040. 214-271-4386.

Used & new carts 40s, 70s, 2 min, 2 1/2 min, 3 min, 3 1/2 min, 4 min, 4 1/2 min, 5 min & longer lengths, several hundred, \$1 ea, you take all. M Taylor, KNEO Radio, POB 845, Neosho MO 64850. 417-451-5636.

TAPE WORLD 1-800-245-6000 Only 4-95 Shipping!
We beat any total price! FREE CATALOG Fax 412-261-4298

SONY	MAXELL	TDK	FUJI
DAT 120 7.49	XL11 90 1.79	1120HS 1.89	SHS1120 11.49
DAT 120 mc 9.99	XL11 590 2.29	1120ERG 2.59	SHS1120 7.89
1120V 2.39	XL11 5100 2.69	SA 90 1.69	DR1 90 2.9
1120VHG 3.29	DAT 120 7.99	SAX 90 2.19	JVC
L-750HG 3.99	1120HGK 2.99	HR 8 120 5.99	1120SX 1.79
max qty 74 11.99	BAM 120 3.49	DAT 120 6.99	SHS1120 6.99

M-F, 8-5 VISA, MC, DISC. 220 SPRING ST. BUTLER, PA 16003
OVER 400 DIFFERENT BRANDS • SAME DAY SHIPPING

TM Century 10.5" reels, Christian praise & worship w/some contemporary APX 85 reels, \$350/BO would consider trade: southern gospel CD library, etc. D Fields, POB 194, Avoca AR 72711. 501-451-8803.

3M/TC, Scotchcart II's, like new 4.5 & 5.5 min carts, \$1.50 ea for 100, smaller qty \$1.70 ea. D Nuechterlein, WUCM, University Center MI 48710. 517-652-6863.

Sony L-500 Beta videotape, high qual (no dropouts), 2 hrs at Beta II, 1 hr at Beta I, used once only for digital audio, 500 tapes left, \$1 ea any quantity. J Sunier, Sunier Productions, 21 Stetson Ave, Kentfield CA 94904. 415-457-2741.

10" reels (450), Bonneville Ultra format for production use, \$5/ea or \$2000/all. B Hill, KALK FM, 106 S Jefferson, Mt Pleasant TX 75455. 903-577-9770.

Pams Jingles ref tapes, 1951-1976, BO. R Kaufman, Pams Prods, POB 462247, Garland TX 75046. 214-271-7625.

Karsky's rewind loop carts. Also sell reconditioned carts. Service guaranteed. Call 605-348-9928.

Classic library, all on 7" reels, \$300. D Pulwers, Dave's Price Audio, 310 N Howard St, Alexandria VA 22304. 703-751-9346.

Want To Buy

Robert Hall production music discs from the 60s & 70s, particularly interested in news sounders, etc. D Bohanan, Bohanan Broadcasting, POB 21829, St Simons Island GA 31522. 912-638-9502.

45s, LPs of 50s, 60s, pop, C&W, radio transcript of Beatles, Elvis, etc, must be in very good condition, for personal library.

D Fields, POB 194, Avoca AR 72711. 501-451-8803.

Pre-recorded open reel tapes, including master dubs, RCA, Mercury, Livingston, Westminster, etc, 2 trk, in-line or stacked heads, all categories, labels and artist. P Chance, Imperial Analog, 925 Clinton Street, Philadelphia PA 19107. 215-574-8147.

Fidelipac/Audiopak Mastercart II gold or AA-4 light blue in 2:30 through 4:00 lengths, must be in vgc, call after 3PM CST. 214-271-7625

TAX DEDUCTIBLE

New non-comm station seeking EBS decoder/encoder, cart machines (mono), any unwanted from microphones to antenna. B Wick, WYRS, POB 545, Manahawkin NJ 08050. 609-597-8089.

Non-profit Christian High School preparing to teach students bdct industry, need all types of equipment & supplies including console, cart machine, R-R deck, turntable & tonearm, mics, preamps, etc, contribution is tax deductible. D Potter, Bethany Christian High School, POB 163, Jackson MN 56143. 507-847-4429.

MARATHON PRODUCTS COMPANY
Audio Cartridge Rebuilding Division

Rebuilding/reloading, like new, all brands, any length up to & including 3.5 minutes, \$1.95 ea. FOB out plant, 48 hrs delivery. (New rate effective 9/1/93)

New NAB Marathon cartridges prices on request.
35 Years professional experience!
Lifetime member AES R.D. MYERS Sr.
Manufacturers of Audio Devices, Continuous Tape Mag.

69 Sandersdale Rd. Charlton, MA 01507
1-508-248-3157 or 1-508-853-0988

Circle (124) On Reader Service Card

Pepper Tanner library, including sound effects category and jingles, great for collectors, good condition, 305 discs, \$199 + shipping. P Tinkle, WCMT Radio, POB 318, Martin TN 38237.

80 reels country music with cues, song list with ea reel, \$5/ea + shipping. D Sports, WCLA-FM, POB 427, Clayton GA 30417. 912-739-3035.

100 asst'd new CDs in boxes, \$200 + shipping; Denon 120 tapes, new, \$8 ea. R Suracci, Fine Art Productions, 67 Maple St, Newburgh NY 12550. 914-561-5866.

Russ Lang cart rack/tower, like new, holds 864 carts, with casters, \$200 + shipping. R Zorn, WMHR, 4044 Makyes Rd, Syracuse NY 13215. 315-469-5051.

Scotchcart II's, like new 4.5 to 5.5 min, \$1.59 ea; 100 qty \$1.49 ea, take all 300 for \$1.20 ea. D Nuechterlein, 6130 Dehmel Rd, Frankenmuth MI 48734. 517-652-6863.

Ampex 406/456 1/4" tape (82 reels), exc cond; also Ampex 406/456 (61 reels), gd cond, \$100/BO. R Herman, Frontier Radio, POB 9292, Austin TX 78766. 512-258-7505.

CONSULTANTS

COMMUNICATIONS TECHNOLOGY ASSOCIATES, P.E.

- AM/FM/TV/MMDS FACILITY DESIGN & FIELD ENGINEERING
- DIRECTIONAL ANTENNA DESIGN AND OPTIMIZATION
- FCC APPLICATIONS AND ALLOCATION STUDIES
- COMPREHENSIVE COMPUTER-ASSISTED ENGINEERING SERVICES

TED LONG BARRON HOFFMAN
910-688-3632
FAX/DATA 910-490-3298
INTERNET CTAVAX.COM

PC - SOFTWARE

AM FM TV Search Programs
Contour Mapping-STL Paths
RF HAZ-1990 POP Count
FAA Tower-Draw Tower

Doug Vernier
Broadcast Consultant
1600 Picturesque Dr
Cedar Falls, IA 50613

800-743-DOUG

EVANS ASSOCIATES
Consulting Communications Engineers

TV • FM • AM • ITFS • Satellite
FCC Applications, Design and Field Engineering

Video/Data/Voice • Light Fiber & Microwave • Wide-Area Networks & STL's

210 S. Main Street
Thiensville, WI 53092
(414) 242-6000 • FAX (414) 242-6045
Member AFCCE

W. LEE SIMMONS & ASSOC., INC.

BROADCAST TELECOMMUNICATIONS CONSULTANTS

5 Gracefield Road
Hilton Head Is., SC 29928

1-800-277-5417
803-785-4445
FAX: 803-842-3371

Where In The World Are You?

Reach radio professionals worldwide by advertising in **Radio World's** international edition.

Call Simone for more information.
1-800-336-3045

GOODRICH enterprises, inc.

Parts and technical service for all MCMARTIN TRANSMITTERS, CONSOLES, EXCITERS, RECEIVERS, TRANSMITTER AND INDUSTRIAL TUBES.

11435 Manderson St.
Omaha, Nebraska 68184 U.S.A.
PH: 010-1-402-493-1886
FAX: 010-1-402-493-6821

MAL2 FM STUDY SOFTWARE

since 1987
was \$995 — now only \$195
Inexpensive quarterly data updates

from the *Matteck Company, Inc.*
602-703-1009

Mirkwood Engineering Services

Broadcast and Telecommunications Consultants

Multidiscipline Engineering and Planning Firm including • Application & Allocation Services

- Project, Engineering & Construction Management • Site Acquisition
- Rural & Remote Site Installations
- Field Service • Studio Design & Installation

50 Park Ave. Claremont, NH 03743
(603) 542-6784

MLJ Moffet, Larson & Johnson, Inc.
Consulting Telecommunications Engineers

Two Skyline Place, Suite 800
5203 Leesburg Pike
Falls Church VA 22041

(703) 824-5660
FAX: 703-824-5672

Member AFCCE

MULLANEY ENGINEERING, INC.
Consulting Engineers

- Design & Optimization of AM Directional Arrays
- Analysis for New Allocation, Site Relocation, And Upgrades
- AM-FM TV LPTV Wireless Cable (MDS/MMDS/ITFS/OFS)
- Environmental Radiation Analysis
- Field Work
- Expert Testimony

9049 Shady Grove Court
Gailthersburg, MD 20877
Phone: (301) 921-0115
Fax: (301) 590-9757

Consulting Communications Engineers

- FCC Data Bases
- FCC Applications and Field Engineering
- Frequency Searches and Coordination
- AM-FM-CA/TV-ITFS-LPTV

OWL ENGINEERING, INC.

1306 W. County Road. F,
St. Paul, MN 55112
(612)631-1338 "Member AFCCE"

JEFFREY W. PEARCE
Professional Broadcast Technical Engineer

General Engineering Services

- Transmitter & Studio Site Upgrades
- New Construction • STL/TSL Systems
- RPU/RENG Systems • Remote Control Systems • Station Inspections

3131 N. Lewis Ave., Waukegan, IL 60087
Phone 708-249-9140
FAX 708-336-6497

Don't Gamble with your advertising dollars.

Advertise in Radio World and reach 22,000+ subscribers.

Call Simone at 1-800-336-3045 today!

T. Z. Sawyer Technical Consultants
AM-FM-TV-LPTV

- FCC Applications & Exhibits
- Experimental Authorizations
- AM Directional Antennas
- High Power Antenna Arrays
- Frequency Studies
- Class Upgrades
- STL Applications
- Station Inspections

1-800-255-2632
FAX: (301) 913-5799 • 6204 Highland Dr. • Chevy Chase, MD 20815

REMOTE EQUIPMENT RENTALS

COMREX and GENTNER
1, 2 & 3-Line Extender Systems
Now With The New GENTNER EFT-3100
MARTI VHF/UHF RPU Systems
Switched-56 Systems
Call or FAX Dwight Weller-
WELLER AUDIO-VISUAL ENGINEERING
Baltimore, MD
Phone: (410 or 800) 252-8351
FAX: (410) 252-4261

LOCATION SERVICES IN THE UNITED KINGDOM

Planning remotes from the U.K.?
we provide a comprehensive service

- we organize venues for your shows
- we provide temporary equipment
- live links via ISDN/switched 56
- experienced radio engineers
- we help you line-up guests

Contact New York (212) 229-9118
Good Morning from Great Britain
Wired for Sound Ltd., London N15

TAX DEDUCTIBLE EQUIP...cont

Non-profit 501-C3 cart machines, R/R and SCPC, on 63.10. J Hayes, 1101 NW 43 Pl, Des Moines IA 50313. 515-244-2848.

TEST EQUIPMENT

Want To Sell

Delta OIB3, operating impedance bridge, exc cond, in padded container, \$1150. C Stuart, POB 1236, Susanville CA 96130. 916-257-2702.

General Radio 916AL impedance bridge, 100 kHz - 5 MHz, w/manuals, cables, fresh calibration, \$325 firm. C Scott, WKYU-FM, Western KY University, Bowling Green KY 42101. 503-745-5489.

TRANSMITTERS

Want To Sell

Gates BC1J recently taken out of service, gd cond, \$2000. J Yinger, WLQV, 29200 Vasser Rd Ste 650, Livonia MI 48150. 810-477-4600.

DEMOED EQUIPMENT

BEXT Inc. has a few demoed exciters, amplifiers and STI's for sale. All demoed systems are sold first come first served and have the same 2 year warranty as BEXT's new equipment. For information:

619-239-8462

ITA 1000, 1 kW FM xmtr, new finger stock & tuning assembly w/manual & harmonic filter, \$1500; Collins 830-F-1A 250 W pwr amplifier, exc cond, w/spare tube & manual, \$1500. K Austin, KFXI, 1101 Hwy 81 N, Marlow OK 73055, 405-658-2556.

McMartin BA-1 K, exc cond, tuned to 1450 kHz, kept in AC'd room. R Vega, WOCN, 350 NE 71st St, Miami FL 33138. 305-759-7280.

CCA Electronics has the following trade-in equipment for sale:

QEI 695T 5kW FM with 695 Transparent Plus exciter and ARC 27 remote control. Also RCA BTA 50 50kW AM & RCA BTA 10 10kW AM. Please contact Steve, Howard, or Darrin at **404-964-3530**.

Rotron CXH 33433A xmtr blower, gd working cond, used as standby, \$200; Eimac 3CX3000 A7, new, tested but not used, \$475; Eimac 3CX3000A7, rebuilt by Econco, tested but not used, \$375; Eimac 3CX3000A7, used 3 years, still good when removed, \$75. B Murphy, KVRH AM/FM, 7600 C.R. 120, Salida CO 81201. 719-539-2575.

Singer 2.5 kW w/exciter, filter, \$5000. J Schloss, KICD-AM/FM, 2600 N. Hiway Blvd, Spencer IA 51301. 712-262-1240.

C-QUAM exciter, \$3000/BO. J Kesler, WOBZ, POB 446, Livingston KY 40445. 606-843-22A 9999.

Continental Electronics 1100 W on 1590. \$8000/BO. J Kesler, WOBZ, POB 446, Livingston KY 40445. 606-843-9999.

FM - TRANSMITTERS

Factory new not used. Why buy a used Transmitter when you can own a new FM Transmitter for about the same cost? Call JIMMIE JOYNT at 214-335-3425.

Gates BC 500GV, parted out, everything avail except mod reactor & capacitors, 1 part or all. J Mathis, WCSI, 3212 Washington St, Columbus IN 47203. 812-372-4448.

New McMartin 20 W, B1M-8000 FM exciter. New McMartin 1BM1005D FM relay/rebroadcast rxvrs; also some used McMartin B910 exciters 15W. Goodrich Inter., 11435 Manderson St, Omaha, NE 68164. 402-493-1886 fax 402-493-6821

CSI 3kW, 1981 single phase, excellent condition, \$10500. J Davis, SCB Inc, POB 7762, Amarillo TX 79114. 806-355-1187.

QEI Q30000, 1989 30,000 W FM xmtr, exc cond, \$28,500. J Davis, SCB Inc, POB 7762, Amarillo TX 79114. 806-355-1187.

Spare parts for CCA AM50,000D, including, HV transformer, mod. transformer, mod. reactor, HV filter choke, tube sockets and more. Call Transcom Corporation 800-441-8454 or 215-884-0888.

Want To Buy

50/25 kW AM, older okay if in good condition & spare parts included; phasor, LTUs, etc also needed for 2 tower single pattern. B Zellmer, KSIR, Box 2475, Greeley CO 80632. 303-353-6522.

RCA BTF-10C & BTF-10D, would like to contact other users to share info on care & feeding, parts sources, finger stock, plate blocking capacitor, call to join users group, will share all information. D Payne, WZPL, 3500 DePaw Blvd Ste 1060, Indianapolis IN 46268. 317-879-9999.

McMartin FM exciter. D Thompson, Bdct Engr Consultants, 2740 Cherry Ln, Walnut Creek CA 94596. 510-933-4881.

Collins 310Z-2 Exciter, RF amp module, dead or alive. D Voy, KMAQ, 129 N Main St, Maquoketa IA 52060. 319-652-2426.

Harris MW1-A, PA modules, dead or alive. D Voy, KMAQ, 129 N Main, Maquoketa IA 52060. 319-652-2426.

RCA FM exciter; BE FX30 exciter; Bird wattmeters (2). B Lacy, KEMA FM, 3611 Soncy 6A, Amarillo TX 79121. 806-355-4554.

McMartin AM/FM xmtr, any model, exciter or stereo modules. Goodrich Ent., 11435 Manderson, Omaha NE 68164. 402-493-1886.

TUBES

Want To Sell

Cleaning our unneeded tube inventory, about 50 small tubes and sev type 810 and 813 tubes, both new and used. J Mathis, WCSI, 3212 Washington St, Columbus IN 47203. 812-372-4448.

4CX250B, 4-400, 833, 813, 5CX1500, 4-1000, all types, full warranty EIMAC, Amperex, RCA. Westgate 800-213-4563.



Svetlana
ELECTRON DEVICES

Quality* Power Tubes

- | | |
|-------------|----------|
| 3CX15,000A7 | 4CX1500A |
| 3CX10,000A7 | 4CX350A |
| 3CX3000A7 | 4CX350AC |
| 3CX2500F7 | 4CX250B |
| 3CX2500F3 | 4CX250BC |
| 3CX2500A3 | 4CX250R |
| 3CX2500H3 | 4X150A |
| YC130 | 5CX1500A |
| 4CX15,000A | 5CX1500B |
| 4CX10,000D | 811A |
| 4CX5000A | 813 |
| 4CX5000R | 833A |
| 4CX3500A | 8560AS |

- Watch this list grow.
- Manufactured in Russia's largest power tube factory.
- Generous* warranty based on high quality.
- Honest prices based on quality at low cost.
- Shipment from USA stock.

Broadcasters

Call: 205-882-1344
FAX: 205-880-8077

OEMs, Distributors,
Volume Purchasers
Call: 415-233-0429
FAX: 415-233-0439

Circle (45) On Reader Service Card

REBUILT ELECTRON TUBES

Partial List: 6623, 23791, TH150, 6425F, 5604, 6696, 6697, 5681, 5682, 5671, 7804, 3CX10,000H3, 3CX20,000H3, 4CX5000A, 4CX35,000C

Worn out power tubes purchased

Vacuum Tube Industries, Inc.

1-800-528-5014
508-584-4500 X75

D and C Electronics Co.

Lowest Price on Tubes including:

- 4-1000A/3-1000Z/8877/4CX250B/833A
- 4-500/5-500/4-400/4CX 3500/5CX1500

and much more!
Factory Warranty!

1-800-881-2374
(904) 688-2374

Se habla Español
FAX: (904) 683-9595

ECONCO

Quality Rebuilt Tubes

Approximately 1/2 the Cost of New

Call for Our Price List

800-532-6626
916-662-7553

FAX 916-666-7760

Circle (1) On Reader Service Card

For the Best Price

& 24 Hr service on transmitting tubes call 402 493 1886 day or night. FAX 402 493 6821.

Want To Buy



Freeland Products, Inc.
"If you don't need TO SAVE MONEY we can't help you."
However, if saving money interests you... WE CAN REBUILD YOUR DUDS (used tubes) for about 1/2 the cost of new tubes!

Call TODAY 1-800-624-7626 For a FREE Information Packet

WE BUY MANY TYPES OF USED TUBES

WANTED!

Electron Tubes

All Kinds & Quantities
Metal Case Caps
Black Beauties

Hurlbutt Enterprises

CHARLIE DRIPPS

4331 MAXSON RD.
EL MONTE, CA 91732
(818) 444-7079 • (800) 334-8223
FAX (818) 444-6863

TURNTABLES

Want To Sell

Russco Cue Master (4), \$150 ea J Kesler, WOBZ, POB 446, Livingston KY 40445. 606-843-22A 9999.

Technics SL 1200 MK2, w/Stanton cart, \$275; Sony SQD 2050, 4 chl dec decoder, \$30; turntable preamp, RIAA curve (2), \$20 ea. G Dunn, 5383 Willow Lake Ct, Byron CA 94514. 510-516-0299.

JVC 4-DD-5 quadraphonic disc demodulator, low hours, \$50. D Pulwers, Dave's Price Audio, 310 N Howard St, Alexandria VA 22304. 703-751-9346.

ADVERTISING SPACE IS AVAILABLE!

Call **800-336-2045** for more information!



Without Advertising a Terrible Thing Happens

... NOTHING

We've Blown Away the Biggest Myth in the FM Transmitter Business...

"Quality FM Transmitters are Expensive...!"

The "ECO Series"...

- Top Quality
- Excellent Reliability
- Feature Packed

BUDGET PRICED!

The 'Next Transmitter Generation' is here NOW!!

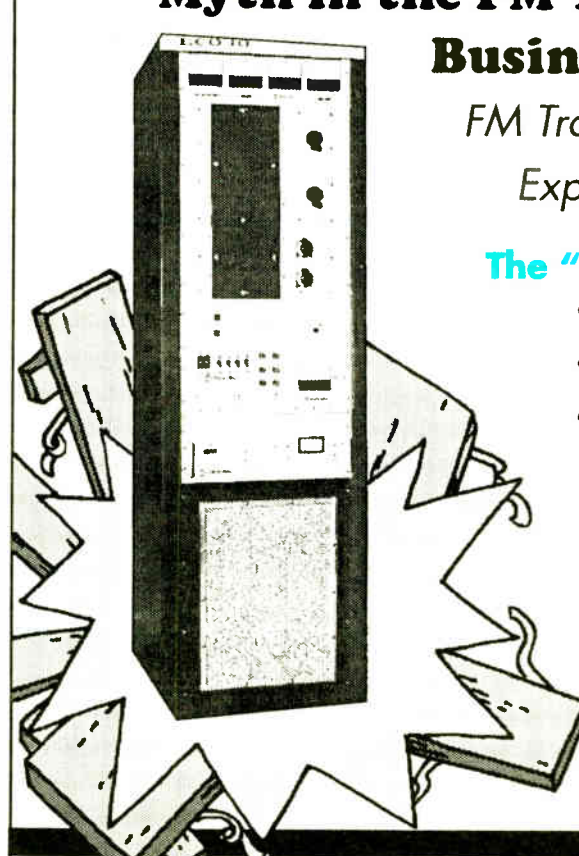

"The Transmitter People"
Energy-Onix

752 Warren Street, Hudson NY 12534

518-828-1690

FAX: 518-828-8476

Circle (116) On Reader Service Card

TRANSCOM CORP.

Serving the Broadcast Industry Since 1978

Fine Used AM & FM Transmitters and Also New Equipment

For the best deals on Celwave products, Andrew cable and Shively antennas.

- | | |
|----------------------------|--|
| 300 watt FM 1989 TTC 300J | 1 kW AM 1974 Harris BC1H1 |
| 1 kW FM 1978 Collins 831C2 | 5 kW AM 1968 CCA AM5000D |
| 2.5 kW FM 1978 CCA 2500R | 5 kW AM 1979 Continental 315F |
| 3 kW FM 1975 CCA 3000D | 5 kW AM 1977 RCA BTA 5L |
| 3 kW FM 1980 CSI 3000E | 10 kW AM 1983 Harris BC10H |
| 3 kW FM 1974 Harris FM3H | 50kW AM 1986 Continental 317C-3 with spare parts |
| 5 kW FM 1991 BE FM5B | 50kW AM 1982 Harris MW50B with spare parts |

1077 Rydal Road #101
Rydal PA 19046

800-441-8454 • 215-884-0888 • FAX No. 215-884-0738

Circle (185) On Reader Service Card

PETER DAHL CO.

Save \$\$

Heavy Duty Replacement Transformers, DC Filter chokes and capacitors for AM & FM transmitters manufactured by: AEL, CCA, CSI, COLLINS, CONTEL, CONTINENTAL, BAUER, GATES, GE, HARRIS, ITA, McMARTIN, RAYTHEON, RCA, SINGER, SINTRONIX, WILKINSON. Many other models also available.



FAST Delivery and FREE Technical Support.

—Write For Free List—
5869 WAYCROSS AVENUE, EL PASO, TEXAS 79924
(915) 751-2300 FAX: (915) 751-0768

ADVERTISER INDEX

This listing is provided for the convenience of our readers. Radio World assumes no liability for inaccuracy.

Page No.	Advertiser	Reader Service No.	Page No.	Advertiser	Reader Service No.
63	360 Systems	65	27	Inovonics	155
38	AEO	53	45	Inovonics	201
29	AMP Services	96	47	Int'l Music Corp. (Aka)	72
7	ATI	49	44	J Squared Technical Service	9
48	Air Corp.	206	12	J.R. Nelson	193
36,37	Arrakis	80	35	LPB	59
30	Audi-Cord	186	40	Logitek	67
16	Audio Broadcast Group	135	14	Man from Mars	28
29	Audio Broadcast Group	12	44	Martin Leasing	21
6	Audio Precision	153	33	Monroe Electronics	104
58	Audio Processing Technology (APT)	164	20	Motor Racing Network	77
42	Audioarts/Div. of Wheatstone Corp.	13	11	Murphy Studio Furniture	46
71	Audiopak	83	64	Myat	120
33	Auditronics	45	31	NSM Consumer Electronics	142
59	Autogram	63	17	National Public Radic	115
39	BSW	100	60	Nautel	208
40	Belar	56	33	Omega Scientific	219
33	Benchmark Media Systems	177	18	Orban/AG/dbx	119
29	Bext	17	51	Otan	41
33	Broadcast Devices Inc.	188	23	Pacific Recorders	102
40	Broadcast Tools	150	40	Phaselek	111
4	Burk Technology	22	20	Post Modern Radio Network	64
51	CCA Electronics	107	61	Potomac Instruments	129
57	CRL	180	8	Premiere Radio Network	101
52	California Amplifier	16	44	Pristine Systems	8
21	California Digital	58	57	GEI	137
33	Coaxial Dynamics	35	9	RE America	163
56	Computer Concepts Corp.	183	22	Radio Concepts	55
3	Comrex	70	19	Radio Concepts	165
29	Comrex	4	14	Radio Programming & Management	74
13	Continental Electronics	90	14	Radio Spirits	76
20	Copra Media Productions	15	22	Reef Industries	81
62	Corporate Computer System (CCS)	105	43	Roland Corp. U.S.	213
20	Custom Professional Billing Sys.	29	44	Russ Friend & Associates	158
49	Cutting Edge	218	27	S.C.M.S.	211
32	Dataworld	184	46	SWR Inc.	94
15	Denon America	95	7	Satellite Systems Inc.	10
20	Dimension	42	24	Scott Studios	144
40	ESE	109	29	Shively Labs	99
58	Econco	50	34	Sierra Automated Systems	148
14	Enco Systems	172	55	Sony	—
20	Energetic Music	134	10	Standard News	91
20	F.E.E.	85	44	Studio Technology	23
20	Format Productions	87	33	Superior Electric	14
41	Gentner	37	53	Superior Electric	147
14	Ghostwriters	11	11	Sveltiana Electron Devices	31
20	Globe Music Production	106	50	Tectan	127
40	Gorman Redlich	205	25	Teles	93
20	Halland Broadcast Service	62	44	The Management	2
1	Harris Allied Broadcast Equip.	146	9	UPI	136
28	Harris Allied Broadcast Equip.	179	72	Wheatstone	181
16	Harris Allied Broadcast Equip.	161	44	Zephyrus Electronics	51
	ITC	182	33	Zercom	173

ACTION-GRAM

Equipment Listings

Radio World's Broadcast Equipment Exchange provides a FREE listing service for radio stations and recording studios only. All other end users will be charged. Simply send your listings to us, following the example below. Please indicate in which category you would like your listing to appear. Mail your listings to the address below. Thank you.

Please print and include all information:

Contact Name _____
Title _____
Company/Station _____
Address _____
City/State _____
Zip Code _____
Telephone _____

I would like to receive or continue receiving Radio World FREE each month.

Yes No

Signature _____ Date _____

Please Circle only one entry for each category:

I. Type of Firm

- D. Combination AM/FM station
- A. Commercial AM station
- B. Commercial FM station
- C. Educational FM station
- E. Network/group owner
- F. Recording studio
- G. TV station/teleprod facility
- H. Consultant/ind engineer
- I. Mfg. distributor or dealer
- J. Other _____

II. Job Function

- A. Ownership
- B. General management
- C. Engineering
- D. Programming/production
- G. Sales Manager
- E. News operations
- F. Other (specify) _____

Brokers, dealers, manufacturers and other organizations who are not legitimate end users can participate in the Broadcast Equipment Exchange on a paid basis. Line ad listings & display advertising are available on a per word or per inch basis.

WTS WTB Category: _____
Make: _____ Model: _____
Brief Description: _____
Price: _____

WTS WTB Category: _____
Make: _____ Model: _____
Brief Description: _____
Price: _____

WTS WTB Category: _____
Make: _____ Model: _____
Brief Description: _____
Price: _____

*Closing for listings is every other Friday for the next month's issue. All listings are run for 2 issues unless pressed for space or otherwise notified by listee.

Broadcast Equipment Exchange

PO BOX 1214, Falls Church, VA 22041 Tel: 800-336-3045 Fax: 703-998-2966

PublisherStevan B. Dana
Associate PublisherCarmel King
Marketing ConsultantAl Leon
Marketing AssistantAnnette Deutscher
Production DirectorKim Lowe
Production ManagerJulianne Stone

ProductionVicky Baron, Lisa Lyons, Lisa Mamo
Ad CoordinatorKathy Jackson
Ad Coordination ManagerSimone Mullins
Circulation DirectorRebecca Şeaborg
Accounts ReceivableSteve Berto

Advertising Sales Representatives

U.S. East: Skip Tash703-998-7600 Fax: 703-998-2966
U.S. West: Dale Tucker916-721-3410 Fax: 916-729-0810
International: Stevan B. Dana+1-703-998-7600 Fax: +1-703-998-2966
Europe: Dario Calabrese+39-2-753-0274 Fax: +39-2-753-2697
Japan: Eiji Yoshikawa+81-3-3327-2688 Fax: +81-3-3327-3010

Free Subscriptions are available upon request to professional broadcasting and audiovisual equipment users. For address changes, send current and new address to RW a month in advance at P.O. Box 1214, Falls Church, VA 22041. Unsolicited manuscripts are welcomed for review; send to the attention of the appropriate editor.

To advertise in



Call Simone Mullins at:
1-800-336-3045
or FAX:
703-998-2966

SUBSCRIPTION/READER SERVICE FORM

Radio World

FREE Subscription/Renewal Card

I would like to receive or continue receiving Radio World FREE each month. Yes No

Signature _____ Date _____

Please print and include all information:

Name _____ Title _____
Company/Station _____
Address _____
City _____ State _____ ZIP _____
Business Telephone () _____

Please circle only one entry for each category:

I. Type of Firm

- D. Combination AM/FM station
- A. Commercial AM station
- B. Commercial FM station
- C. Educational FM station
- E. Network/group owner
- F. Recording Studio
- G. TV station/teleprod facility
- H. Consultant/ind engineer
- I. Mfg. distributor or dealer
- J. Other _____

II. Job Function

- A. Ownership
- B. General management
- C. Engineering
- D. Programming/production
- G. Sales manager
- E. News operations
- F. Other (specify) _____

Reader Service

May 4, 1994 Use until August 4, 1994

Please first fill out contact information at left. Then check each advertisement for corresponding number and circle below.

Purchasing Authority

1. Recommend 2. Specify 3. Approve

001 023 045 067 089 111 133 155 177 199
002 024 046 068 090 112 134 156 178 200
003 025 047 069 091 113 135 157 179 201
004 026 048 070 092 114 136 158 180 202
005 027 049 071 093 115 137 159 181 203
006 028 050 072 094 116 138 160 182 204
007 029 051 073 095 117 139 161 183 205
008 030 052 074 096 118 140 162 184 206
009 031 053 075 097 119 141 163 185 207
010 032 054 076 098 120 142 164 186 208
011 033 055 077 099 121 143 165 187 209
012 034 056 078 100 122 144 166 188 210
013 035 057 079 101 123 145 167 189 211
014 036 058 080 102 124 146 168 190 212
015 037 059 081 103 125 147 169 191 213
016 038 060 082 104 126 148 170 192 214
017 039 061 083 105 127 149 171 193 215
018 040 062 084 106 128 150 172 194 216
019 041 063 085 107 129 151 173 195 217
020 042 064 086 108 130 152 174 196 218
021 043 065 087 109 131 153 175 197 219
022 044 066 088 110 132 154 176 198 220

Copy & Mail to: Radio World, PO Box 1214, Falls Church, VA 22041, or FAX to: 703-998-2966

Auditronics reinvents radio with...

THE *Destiny* 2000

PROGRAM MANAGEMENT SYSTEM



The most exciting NEW advance in radio broadcasting since the advent of computer technology!

You won't have to scrap your existing computer equipment. When the Destiny 2000 Program Management System and Console are installed, it will integrate your current computers and equipment into one master program management system. Your music schedule and traffic schedule computers, as well as your production room hard disk computers, can be networked into one system,

all controlled by the Destiny 2000 console and computer.

It's the control room of tomorrow! The clutter is gone. The commercial copy, the music and traffic logs are in the computer. The CD's are in the jukebox and the tape carts are in the hard disk storage. The control room of tomorrow is here today... tapeless and paperless.

The Sound Of Perfection

AUDITRONICS

3750 Old Getwell Road • Memphis, TN 38118 • (901) 362-1350 • FAX (901) 365-8629

Circle (45) On Reader Service Card

Every City Has One.

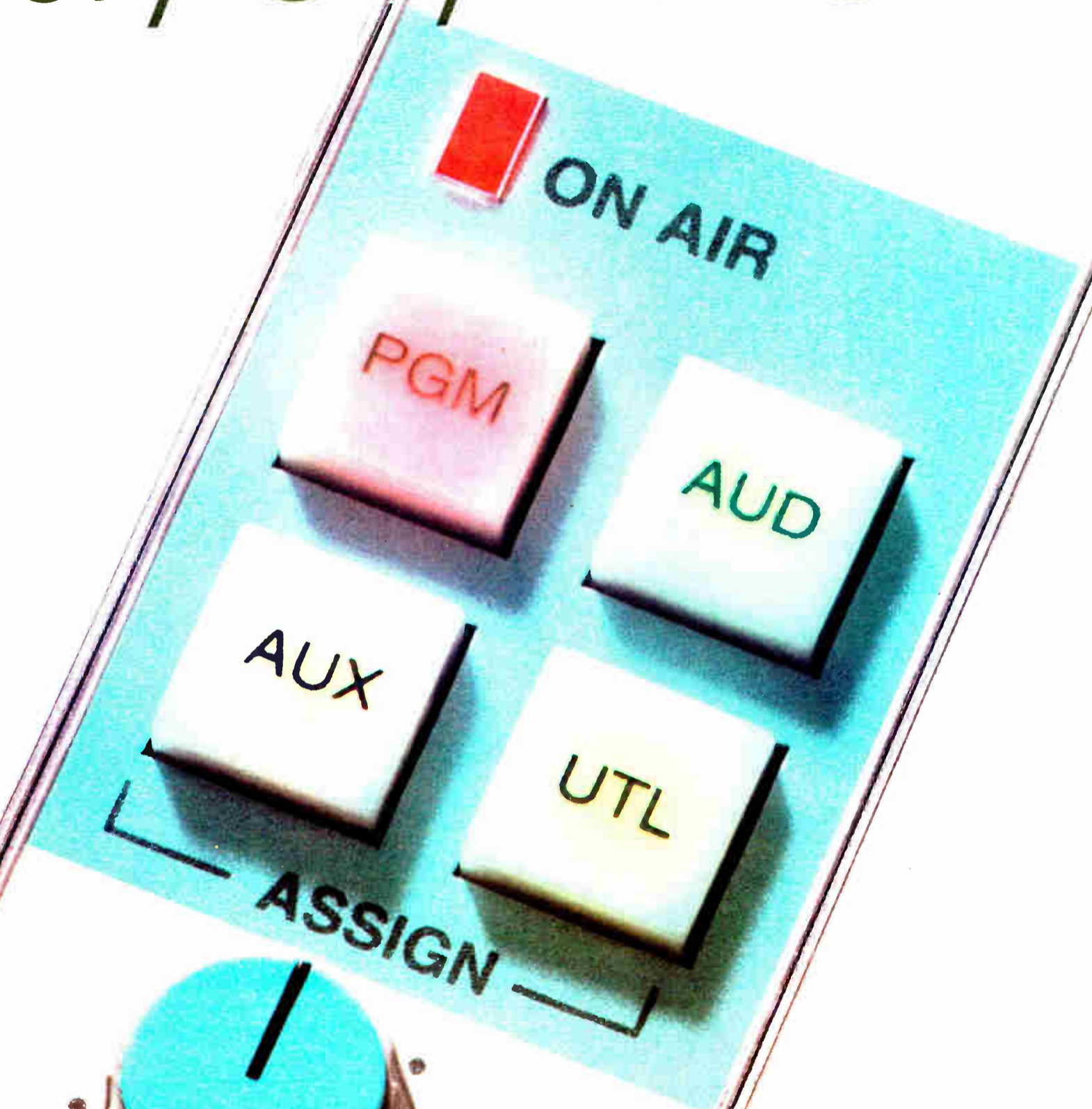

A Number One Station.

The A-6000 On-Air Console is for you.

 Wheatstone Corporation

7305 Performance Drive, Syracuse, NY, 13212
(tel 315-452-5000 / fax 315-452-0160)