

\*\*\*\*\*3-DIGIT 857  
J750970 D08 9203 S1198 1331

TOM MILLER  
ASST CE  
KTZR  
2033 S AUGUSTA PL.  
TUCSON AZ 85710

# Radio World

**NAB94**  
See pp. 59-71

Vol 18, No 5

Radio's Best Read Newspaper

March 9, 1994

## DCR to Begin Satellite DAR Service

by Frank Beacham

**HORSHAM, Pa.** Digital Cable Radio (DCR), the digital audio service with 30 channels of music and special programming, is expanding beyond its cable television

roots to be delivered nationwide this summer on direct broadcast satellite.

The premium, commercial-free audio service is expected to become the first to deliver its programming directly from satellites to consumers located at any fixed

location in the United States.

DCR, a partnership between General Instrument, Sony Software, Warner Music Group and several leading U.S. cable operators, will supply its programming to DirecTV, a unit of General Motors Hughes Electronics. DirecTV, headquartered in Los Angeles, is scheduled to begin a limited roll-out of its DBS service in April and to expand to a full launch later in the year.

"This (DCR's announcement) will shock the broadcasting industry," said John D. Abel, executive vice president of the National Association of Broadcasters (NAB). "This is the equivalent to the guys coming in from Japan with inexpensive cars in the 1960s. It shocked the automotive industry eventually, and it (digital audio via satellite) will do the same for broadcasters. We cannot stop digital."

### Not just cable

To shed its cable-only roots, the audio service is changing its name to "Music Choice" from Digital Cable Radio, though the corporate entity will retain its original name. Music Choice will retain the current programming lineup which includes 30 around-the-clock channels that include classical, jazz, blues, hip-hop, modern rock, contemporary country, new age and other formats. The name change will be launched to cable operators on May 2.

Perhaps of greatest importance to DCR, the Music Choice service will be offered as

a basic service in DirecTV's Personal Choice II package which will be offered at \$29 a month. This means DCR will not have to market the music service as an optional premium service as it now does with cable television subscribers. And, since Music Choice will work through



in depth

## Broadcasters Are Careful Compression Customers

by Randy Sukow

**WASHINGTON** It is difficult to gauge the broadcast industry's attitude toward digital audio compression systems.

Compression systems are selling well. The proliferation of new digital RF and studio equipment with compression options suggests a market for them. The cost benefits of squeezing two, four or more signals into channels that used to carry only one signal are not questioned.

But the current anxiety about the proliferation of compression systems in the broadcast chain, especially when compression potentially means noise and distortion from "dueling algorithms," originated from broadcasters.

Compiling radio industry opinions on compression has been surprisingly laborious. **RW's** request for individual station managers' and engineers' experiences with compression drew a disappointing response. (See box, page 13).

In lieu of the survey, **RW** contacted several radio engineers from a wide range of market sizes, to record their experiences with audio compression and plans for future compression use.

Most were generally satisfied with the compression systems they were using, but

cautious about adding other compression systems to their facilities.

They also tended to be less optimistic about remedies for audio artifacts than equipment manufacturers and algorithm developers. But many broadcasters share manufacturers' desire for a system to use just one compression system in the broadcast chain and eliminating multiple analog-to-digital conversions.

### Satisfied customers

The most satisfied engineers have not had serious trouble with dueling algorithms or other compression artifacts.

"Generally, the problems have been solved by just adjusting the hardware. There haven't been problems with the software," said John Nielsen, chief engineer at KTTS-AM-FM Springfield, Mo.

KTTS receives satellite feeds from ABC Radio that are compressed with Scientific Atlanta's SEDAT system. It also operates various digital audio effects machines and will soon have ten 360 Systems DigiCarts with optional AC-2 compression.

Nielsen has heard some transcoding problems at his stations, but nothing that could not be corrected. "Most of the time, when

continued on page 11



DirecTV's existing home receiver, a separate set-top receiver will not be required for the music channels.

"This is a big opportunity for us for two reasons," DCR President Dave Del Becarro said. "Automatically huge numbers of people will be exposed to Music Choice. It doesn't have to be sold. We'll

continued on page 8

Digital Audio Made Easy with DAD. No matter what your requirements - one workstation or ten networked - the DAD486x does it best while it improves your bottom line. Unsurpassed quality, flexibility and high performance are standard. Whether you're live assist, automated or satellite, DAD delivers. And you'll love how easy it is to use. Call us toll-free.

Phone: 800-622-0022 Fax: 317-966-0623

**HARRIS ALLIED**

Circle (22) On Reader Service Card

See Us At NAB Booth 2218

# NEWSWATCH

## Infinity Fined Again

**WASHINGTON** The FCC has once again levied fines on several Infinity Broadcasting stations that air the syndicated Howard Stern Show.

The indecency fines, totaling \$400,000, were for Stern broadcasts in August, September and October, 1993, which are violations of the FCC's no-indecency programming hours, 6 a.m.-10 p.m. The stations involved were WJFK (AM), Baltimore; WXRK-FM, New York; WYSP (FM), Philadelphia and WJFK-FM in Manassas, Va., a station that

serves Washington.

The FCC said that Infinity's "continuing course of apparent misconduct in broadcasting indecent material is troubling, but (the FCC) concluded that under existing circumstances, monetary forfeitures were the appropriate remedy for the cited violations."

The Commission has previously fined Infinity several times, in excess of a million dollars so far (none has been paid, yet) for indecency, and hinted that the violations could impact approval of Infinity station transactions.

A recent district court decision seems to undermine the FCC's indecency rules,

but it went ahead with the latest action. In a press release on the latest fines, the Commission, however, said that "we do not read the Court's decision to restrict our ability to enforce against broadcast indecency, except with regard to the midnight to 6:00 a.m. safe harbor period..."

The FCC also acknowledged that the court ruling "has raised issues regarding our enforcement program that can be most appropriately addressed in a rule-making proceeding. Accordingly, we will exercise our discretion...to limit our response to these latest broadcasts to monetary forfeitures."

On the air, Stern has said the FCC has singled him out for alleged violations, but ignores other radio personalities that also air similar or worse material.

## Harman Acquires Studer

**WASHINGTON** Harman International has added Studer Revox, based in Regensdorf, Switzerland, to the list of professional audio companies it now owns.

Last month, Harman, the parent company of JBL Professional, Soundcraft, Allen and Heath, DOD, Lexicon, BSS and AKG, acquired the pro audio side of Studer. The consumer hi-fi division of Studer was excluded from the deal, but "negotiations with interested buyers are still in progress," according to a Studer press release.

"With the takeover of Studer Revox, the Harman group will have an unmatched range of products in the professional audio sector," the press release said.

Some of Harman's companies sell competing products, such as Studer's Dyaxis line and the AKG digital workstations.

Studer U.S. had recently consolidated most of its business operations in Menlo Park, Calif. The Studer company has subsidiaries in the U.S., France, Canada, Germany, Great Britain, Japan, Singapore and Austria.

# Only AUDIOARTS Has It...

**WHEATSTONE'S STRENGTH!** With Wheatstone's professional experience, engineering know-how, support capability and corporate stability behind it, this AUDIOARTS console design is the right choice.

The A-50 is cost effective through clever engineering and the latest advances in CAD design and electronic assembly procedures. It was developed by the same design team that creates Wheatstone's high end equipment. This console's performance is light years beyond the competition.

Naturally, it has all of the most important features: machine control functions, programmable channel logic, and three busses (Program, Audition, and Telephone). It also has the monitors you need: control room, studio and headphone—each with its own level control. It's designed so you can expand or add accessory modules as your needs grow.

You can benefit from our major market experience. Take advantage of Wheatstone's expertise and reputation; call us today for immediate action.



**AUDIOARTS ENGINEERING**  
7305 Performance Drive, Syracuse, NY 13212 / 315-452-5000 / fax 315-452-0160

## Index

### RUNNING RADIO

#### Generation X Aims at Mainstream Radio

by Charles Taylor 15

#### Assess Your Station's Engineering Realistically

by Karl Baehr 17

#### Radio Should Consider Its Role on Info Highway

by Judith Gross 18

#### Maximize Sales While the Answer Is Yes

by Bob Harris 20

#### Job Descriptions Can Help Management

by Sue Jones 23

#### Whose Voice Represents Your Station

by Mark Lapidus 24

### FEATURES

#### Computer Models Weighed for AM DAs

by Harold Hallikainen 27

#### Switch Placement Requires Planning

by James R. Murphy 28

#### DGS Provides Rapid ISDN Solutions

by Dee McVicker 43

#### Tracing the Details of Transistor Upkeep

by Ed Montgomery 44

#### Alternative RF Networks for Radio

by Thomas Osenkowsky 46

#### Radio Engineers: Leading a Thankless Life

by Jim Wojciechowski 51

#### Ways to Tackle Splatter Monitoring

by Tony Dinkel 52

#### Workbench

by John Bisset 54

#### Doing the Uplink/Downlink Math

by W.C. Alexander 57

LISTENER IMPRESSION

# Sony Introduces AMAX Stereo Walkman

by John Gatski

**WASHINGTON** Although the AMAX voluntary AM tuner performance standard has been in effect for about two years, manufacturers have been slow to produce radios that meet the criteria.

Designed to spur the quality of AM tuner performance, best described as dismal over the last 20 years, the joint electronics industry/broadcast industry AMAX standard requires that radios have a bandwidth of 50 to 7.5 kHz (6.5 kHz for portables), adjustable bandwidth, noise blanking (battery portables are exempted), and external AM antenna connection (home units).

Recent FCC action on AM improvement, including adoption of Motorola's C-QUAM stereo transmission standard and preference for AM stereo stations in the new expanded band, has contributed to the need for better AM radios.

Hopefully, Sony's new SRF-42 AM stereo/FM stereo portable is a sign of more AMAX-quality radios to come. The \$34.95 portable "walkman"-type radio features AM stereo-mono/FM stereo, manual tuning, headphone jack and headphones, and removable belt clip. The band selector switch has three positions: FM stereo, AM mono and AM stereo. The radio is powered by two AA batteries. The unit is manufactured in Malaysia.

In listening tests with the SRF-42, I sampled the radio through various head-

phones and via connection to a home hi-fi set up. As mentioned in past **RW** radio/tuner evaluations, Washington, D.C. does not have a lot of AM stereo stations, so I tuned in the ones I am familiar with: WMZQ-AM (1390 kHz), a country station; and WWDC-AM (1260 kHz), a golden oldies station. Although no performance measurements were made, listening tests revealed the SRF's AM sound is much improved over the mono, narrow-band AM (usually about 2.5 kHz) of most modern AM tuners.

To really enjoy the SRF-42, however, you should invest in better headphones. The SRF-42 comes with a basic "jogger" headphone setup that does not do the radio justice. The headphones sound okay, and their lightness is good for the on-the-move folks, but the SRF-42 offers more than the OEMs can provide.

I tried a two-year old set of Sony MDR-P1 closed headphones, which cost about \$24. The high end and the bass immediately came to life when I tuned into WWDC and WMZQ. Next, I auditioned the SRF-42 with my studio-quality Sony MDR-V6 headphones, which cost about \$100. Again, a marked improvement in the audio. The highs were brighter, the stereo separation was wider and the bass was deeper.

A welcome side benefit of the AM stereo mode is that mono stations sound better because of the extended bandwidth; the highs are brighter, but without stereo. The AM stereo chip is Sony's portable C-

QUAM chip that is designed to operate with less battery power. On the negative side, when you open up the bandwidth, there also is an increase in typical AM noise. Remember, there is no noise blanking requirement for the AMAX battery portables.

I also connected the SRF-42 to the hi-fi via a portable CD interconnect. There was a sense of stereo space in the AM mode, and the sound was more open than most mono AM radios, but I preferred the headphone sound. Anyway, the SRF-42 is not designed to be a home tuner—although the FM stereo mode did sound pretty good on the home system.

My review sample did have some quirks. Initially, the battery compartment would not open, but I attributed its stubbornness to a couple of hours' storage in the cold confines of my car. Also, since the SRF-42 has manual tuning and a small tuning scale, it was a bit hard to dial in some stations. But once they were tuned in, they locked on and did not drift from stereo—either on AM or FM.

Also, in my opinion, the radio's selector switch needs an FM mono position. There are times when the listenability of distant or hard-to-tune stations can be enhanced

by going mono. The SRF-42, however, is not alone in not having a mono FM option; many car radios don't have the feature either—and they probably need it the most.

Most of the user comments about the SRF-42 have been positive. The National Association of Broadcasters (NAB) also has been impressed with the SRF-42; at its booth at the winter Consumer Electronics

Show (CES), NAB provided demonstrations along with the Denon TU-680 NAB home tuner. But as good as the SRF-42, the GE Superadio (re-viewed in **RW** last year), the Denon, and the high-end Carver TX-11b home tuner are in providing the best AM sound available, I can still hear a difference between FM stereo and AM stereo. In repeated comparisons of WMZQ's AM and FM signals on radios I have auditioned, the FM always has tighter bass, a smoother midrange and more high frequency content.

But this is not a knock on the SRF-42. Compared to other portables and most home and car AM tuner sections, it is a 1000 percent improvement in sound! Sony has come up with a product that AM stereo broadcasters can be proud to have their audiences listen to.

For more information, contact Sony at 800-847-SONY; or circle Reader Service 193.



## We maintain a Double Standard

Audio Precision offers two different standard-setting product lines.

**The automated System One — the industry standard for bench and factory.**

- Graphic results on PC screen with hard copy to printers
- Automated proof procedures & limits testing
- State-of-the-art performance and speed

**The self-contained Portable One Plus & Portable One — for service bench and field.**

- Compact and affordable stereo test sets for applications not requiring automation
- Both offer comprehensive capability & high performance in a rugged package
- Portable One Plus adds sweeps, graphs and printer port

The System One and Portable One... two families of test sets designed for different jobs, each with the quality and performance that you have come to expect from Audio Precision.

**Audio precision**

P.O. Box 2209, Beaverton, OR 97075  
503/627-0832 1-800/231-7350  
FAX: 503/641-8906, TELEX: 283957 AUDIO UR

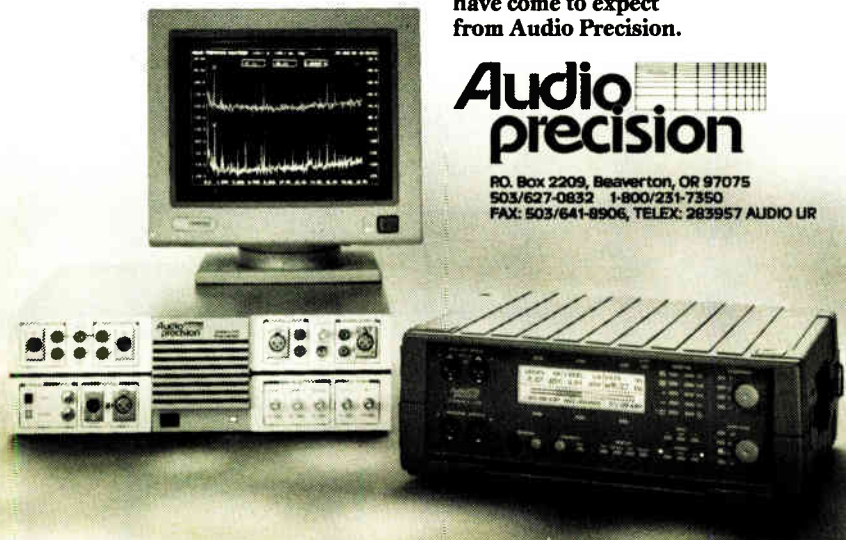

Circle (33) On Reader Service Card

See Us At NAB Booth 3402

Circle (189) On Reader Service Card

World Radio History

## The Backhaul Standard



NCAA football photo courtesy of Host Communications

### Features:

- Transmits 50 Hz - 5 KHz via Two Dial-up Phone Lines
- Provides Quiet Program Channel, Even on Noisy Long Distance Circuits
- Rugged, Portable Field Encoder



So many Comrex Two Line Frequency Extenders are in use throughout the world that they have become the industry standard for transmitting sports, news and other remote broadcasts. Because they work on normal analog telephone lines, the Two Line Extenders can be used anywhere. Ruggedly built for reliable, on-the-road duty, these "backhaul workhorses" provide high quality broadcasts across continents or just across town.

Call or fax us for complete information, including our "Try It Before You Buy It" offer.

**COMREX**

Comrex Corporation  
65 Nonset Path, Acton, MA 01720  
800-237-1776 508-263-1800  
Fax 508-635-0401

Comrex (UK) Ltd.  
75 The Grove, Ealing  
London W5 5LL, UK  
081-579-9143 Fax 081-840-0018

See Us At NAB Booth 12206

# Abuzz with Good Radio Stories

**WASHINGTON** Have you noticed that the air seems a little electric these days? It always seems to get that way right before NAB time. News of impending announcements and breakthrough introductions is simmering just below the surface, waiting for that moment when the NAB exhibit floor officially opens.

Fortunately news travels fast and I've got a tidbit or two to help whet your appetite for NAB. Two of radio's big-name companies, Arrakis and Gentner, have formed a strategic alliance that has resulted in the introduction of a new technology protocol and product system.

The protocol, GAP<sup>2</sup>, defines the method of linking telephone technology to hard disk studio systems and will serve as the platform for an entire series of new products from both companies.

If it seems that every other story in the news these days is about the digital "superhighway," perhaps it's because companies on the move these days all seem to be forging an "on-ramp" for themselves. Arrakis' Mike Palmer and Gentner's Russell Gentner view their

Gentner is in booth 2612; Arrakis is just down the aisle at 3912.

★ ★ ★

Last time out I gave you a rundown of the nation's top 13 radio markets. This time out, I thought you'd like to know



CRC's Gonzales, Barret L. Alley, president, and Richard Santiago, general manager.

what the top-billing stations in the U.S. are pulling in and who they are. I turned once again to Broadcast Investment Analysts (BIA) Investing in Radio 1994.

To no one's surprise, WGN(AM) Chicago ranked No. 1 in the country with 1993 revenue of \$41 million; KABC(AM) in Los Angeles ranked No. 2 with \$32 million; WFAN(AM) in New York is third with \$30 million; KLOS-FM and KOST-FM, both in L.A., ranked four and five with \$28 million and \$28 million, respectively; WINS(AM) in New York ranked No. 6 with \$28 million; KGO(AM) in San Francisco ranked seven with \$26 million; WABC(AM) in New York ranked No. 8 with \$25 million; KRTH-FM in Los Angeles ranked No. 9 with \$25 million, and WLTW-FM in New York rounded out the top 10 with \$25 million.

Take note that six of the top 10 are AM stations, and New York and Los Angeles each boast four of the top 10 billers.

★ ★ ★

One of the many great things about the U.S. is its ability to absorb immigrants and turn them into winners. Immigrants turn their hands at many trades, and radio

broadcasting is no exception. The folks at Cadena Radio Centro (CRC) in Los Angeles reach 87 percent of the U.S. Hispanic population with 80 affiliates in 62 cities (roughly 15.5 million people). CRC serves its audience in Spanish.

Recently, CRC was awarded the Golden Mike Award for the best radio network news service from the California Radio and Television News Association. The network received the award for its investigative series on Mexicans who risk their lives crossing the U.S.-Mexico border.

"Routes to the North" was produced by CRC's News Director Antonio Gonzalez and was based on his undercover experience. Gonzalez actually negotiated with a "coyote," (the underground guide and contact for the trek), navigated the sewers of Tijuana, crossed the Tijuana river and entered the U.S. for a \$350 "freedom" fee. He proceeded to adopt an assumed identity, obtained a green card and a social security number for a \$75 fee. Congratulations CRC—I look forward to hearing more from this daring bunch.

★ ★ ★

Much of the information we put in *RW* every two weeks is determined by who are readers are and what they expect from us. *RW* welcomes input from all of you. I'm particularly encouraged by the great response elicited by some of the new things we are doing, particularly in Running Radio and Studio Sessions. Keep the letters coming!

I would like to remind you as well that I'm looking for good articles written by Contract Engineers, based on their experiences. It is estimated that well over half of all radio stations' technical service needs now are provided by outside contract engineers instead of full time or even part

time chief engineers who are employees of the station.

Our bimonthly series devoted to the trials, tribulations, concerns, business practices, case studies, client relations, horror stories, and whatever else is helpful or enlightening to contract radio engineers is picking up steam. I'd like to see it turn into a forum, written by you, for your colleagues.

Remember, topics are wide-ranging, but focus more on the business of contracting rather than the pieces which deal with fixing specific hardware. Such articles also are very welcome, but will appear in John Bisset's *Workbench*.

Participate in this forum by submitting articles, preferably in WordPerfect (via modem or diskette).



Russ Wood was named vice president for marketing and sales for Bonneville International Corp. Wood will assist and support sales efforts at the various Bonneville divisions, coordinating development and implementation of multidivision marketing and sales projects, designing and implementing company-wide sales training, and enhancing communication among the sales departments.

Jeff "Ozzie" Sattler is the new vice president and general manager at Group W's WLLZ(FM) in Detroit. Prior to this, Sattler was GM of KCKI(FM) in Tulsa, Okla.

CBS News' Dick Reeves retired last month after 34 years with the company. Reeves joined CBS in 1960 as a news writer at WCBS(AM) New York and was part of the team that launched that station's all-news format in 1976. Reeves had been anchoring several of the CBS Radio "News-on-the-Hour" segments.



companies' alliance as a vehicle for delivering "the promise of the digital highway to broadcasters today." Said Palmer: "With Gentner's dominance in telephone, and Arrakis' dominance in digital storage and studio equipment, these products will make it easier for broadcasters to choose the right technology path to meet both current and future needs."

Be sure to stop by their respective booths and see what they will be introducing.



## Get on the right track...

**U**nattended operation helps you operate your station profitably. All it takes is a satellite or automation program source, a good transmitter control system, and a way to handle EBS.

You take care of the program source... We'll help with the rest.

A transmitter control system from Burk Technology relieves you of the need to keep someone at the station just to take transmitter readings. Add our exclusive Studio I/O and we'll run EBS for you, too.

Burk gives you the flexibility to run your station the way you want, and in full compliance with FCC rules.

Call us now. We'll show you a new way to run a railroad.

TOLL FREE 1-800 255-8090

**BURK**  
TECHNOLOGY

7 Lomar Drive, Pepperell, MA, 01463 (508) 433-8877

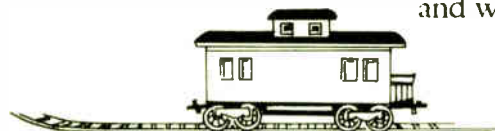

READERS FORUM

If you have comments for Radio World, call us at 800-336-3045 or send a letter to Readers Forum (Radio World, Box 1214, Falls Church, VA 22041 or MCI Mailbox #302-7776). All letters received become the property of Radio World, to be used at our discretion and as space permits.

Fair share

Dear RW,  
This letter is in response to the letter to the editor from James B. Wood of Inovonics and the "Readers Forum" item about the Electronic Industries Association's solicitation of funds to defray the costs of digital radio testing (RW, Jan. 12).

What is wrong with asking interested parties to share the costs of digital radio? Radio broadcasters tell us that digital radio technology is critical to radio's future. Yet EIA has to take the lead on testing and scant few dollars have been offered or contributed by broadcasters for any testing other than in-band, on-channel (IBOC) system testing.

Systems proponents, EIA and electronics manufacturers have committed roughly \$1 million on digital radio testing while NAB has committed to split costs with EIA and proponents for IBOC testing. The level of funding budgeted (some \$50,000) pales in comparison to the testing required, especially since over 40 percent of the testing program is to ensure that these new DAR systems will protect existing AM and FM broadcasters from interference.

It's time to step up the financial commitment. For the electronics industry, digital radio will be one of a few exciting products consumers will want. For broadcasters, it will be the only way to compete.

It's time the broadcasters stepped up to the plate so that they can stay in the game.

Gary J. Shapiro, group vice president  
Consumer Electronics Group  
Electronic Industries Association  
Washington

Stern reproof

Dear RW,  
The editorial "A Call to Action" (Jan. 26) nearly made me blow out a major

**Radio World**  
Vol. 18, No. 5 March 9, 1994

Editor ..... Lucia Cobo  
Managing Editor ..... Randy Sukow  
News/Studio Sessions Editor ..... John Gatski  
Associate Editor ..... T. Carter Ross  
Contributors ..... Frank Beacham/N.Y.  
Bruce Ingram, Pamela Watkins, Nancy Reist  
Technical Editor ..... John Bisset  
Technical Advisor ..... Tom McGinley  
Editor (International) ..... Alan Carter  
Managing Editor (International) ..... Charles Taylor

Radio World (ISSN: 0274-8541) is published bi-weekly by Industrial Marketing Advisory Services, Inc., 5827 Columbia Pike, Suite 310, Falls Church, VA 22041. Phone: 703-998-7600, Fax: 703-998-2966. Second-class postage rates are paid at Falls Church VA 22046 and additional mailing offices. POSTMASTER: Send 3579 forms and address changes to Radio World, P.O. Box 1214, Falls Church VA 22041. Copyright 1994 by Industrial Marketing Advisory Services, Inc. All rights reserved.

—PRINTED IN THE USA—

Next Issue of  
**Radio World**  
March 23, 1994

artery. I would expect such content in "Broadcasting," but it amazed me to see it in RW.

Infinity's proposed purchase of stations in Los Angeles and Washington would give them two FMs in L.A. and an AM with two FMs in D.C. Based on recent trends, it's sensible to assume that Infinity plans to create duopolies in both cities.

Duopolies mean engineering. on-air news and support staffs will be chopped. In the real world, this means more unemployment for radio people.

Duopolies and mergers have gutted radio at the expense of quality. It has put a few more dollars into the bank accounts of investors who, for the most part, are so alien to radio that they wouldn't know a cart machine from a salad shooter.

So what if the FCC is shy a commissioner or two or three? Maybe Infinity will be inconvenienced by waiting a few extra months to enhance their revenue stream. The commission is crumbling from a funding and manpower crisis that makes the editorial's concerns seem puny.

The engineer in charge of the Seattle FCC field office was answering the office phone the last time I visited. His office clerk left last year and he wasn't allowed to hire a replacement. They can only take calls a few hours a week to reduce the workload on the few remaining people. Check any FCC field office in the country for a similar story.

Many D.C. staff people are gone too. They haven't been replaced because of a hiring freeze. Now they have been saddled with Cable Act enforcement. The FCC infrastructure is about to pop a hernia.

Nearly all of the important work on issues quoted in the editorial, "DAB, AM band expansion and new RF radiation regulations," is done by staff, not commissioners. Without a competent staff, the commissioners have little to do but debate policy. Let's not decry the shortsightedness of a commissioner or two, let's push for FCC funding.

As to the "outrages to the First Amendment," it's outrageous that the Infinity case has been twisted into a miniature constitutional crisis. Howard Stern's mouth brings in millions of dollars to Infinity's revenue stream.

If Mr. Stern's free speech stopped pulling in megabucks, he'd be canned in a New York minute. In such an unlikely event, Mr. Stern's free speech rights would take a back seat to Infinity's right to profit. That's show biz, sweetheart.

What's this sedition about a corporation's First Amendment rights anyway? Stroll down to the local courthouse and take a look at the names of those who gave their lives to protect this country. How many corporate names are etched into those bronze or granite memorials? Infinity's grand daddy didn't die to defend the American way.

Where is Infinity's support for the Pacifica Foundation stations during their ongoing free speech battles with the FCC? Is free speech less important if it's not done for profit? People who pervert

Just Another Digital Tool

Digital audio data compression (the broad term for what is actually data reduction) is a flourishing topic that can be examined from many angles.

One angle is the broadest view. Radio station operators, afraid of the possible audio damage created by multiple passes of compression, should look at how all other media approach data compression.

TV uses it. Compression is the basis for high definition television, interactive video, 500-channel cable systems and other high-speed video data services of the near future.

Wired and wireless telephone companies, newspaper and book publishers, computer software developers and music recording houses are using compression in some form. Some have been using it for many years.

Compression is nothing more than a form of computer bit manipulation—one of many tools all media will use in the digital era. Questions of whether to use it, or which algorithm to use, will eventually not be important.

In the future, radio stations will compress signals to participate in a digital audio radio (DAR) service. Stations will need compression to transmit several different types of data besides audio when the DAR transition is complete.

As stations in 1994 prepare for that future, the compress-only-when-necessary argument seems a bit extreme. Some station operators do not need it, but will find it does little or nothing to damage their audio and saves them money.

The problems of dueling algorithms and multiple digital/analog conversions may soon right themselves if California Digital Audio's daX, Scientific-Atlanta's SEDAT OSI and single-compression-system approaches almost certainly to be developed for other algorithms are successful.

The safest course of action starts with learning as much as possible about a compression system before making an equipment or service purchase. Then try to stay with that same algorithm in as many applications as possible when compressing more than one link in the broadcast chain.

After all, the best way to take advantage of future technology is to not be afraid of current technology.

—RW

the First Amendment for money deserve to have their tongues ripped out and sold to the highest bidder.

If it takes five years for Infinity or Westinghouse or Gannett to take over a few more stations, what has the public lost? Survey your readers. If trafficking in radio stations doesn't come up as one of their top three reasons for the current lame state of radio, I'll personally kiss Howard Stern anywhere but on that mouth.

Sandra Woodruff  
Issaquah, Wash.

*Editor's note: RW agrees (and has editorialized before) that the FCC is woefully underfunded and overextended, especially since passage of the 1992 Cable Act. But that does not excuse a foot-dragging Clinton Administration's failure to appoint commissioners, possibly leaving the agency unable to finish routine tasks, like license transfers. It is not a "puny" matter, but the kind of thing that discourages new investment in the radio industry, potentially leading to considerably more unemployment than any duopoly-related displacement.*

*To answer Sandra Woodruff's question about the First Amendment: Profit has nothing to do with it; Infinity and Pacifica are both entitled to free speech. Corporations are indeed protected speakers. As a tolerably profitable corporate entity, RW exercises its First Amendment rights in every issue and protests unreasonable government efforts to restrict broadcasters.*

Another way

Dear RW,  
Regarding the article about quality air checks (RW, Jan. 26), another way to get more of the air signal on the air check tape is to use the profanity delay unit.

Simply feed audio to the unit all the

time and use its output to feed the air check machine. With a simple capacitor across the mute relay coil (to keep it pulled in for a while longer), the timing can be adjusted to get the recorder to record six seconds before the mic is turned on and then six seconds after it is turned off.

This would be unavailable when the delay is needed for its intended purpose.

Stuart Engelke, chief engineer  
WWDJ(AM) Hackensack, N.J.

Kudos to Rowland

Dear RW,  
I'm writing to applaud you for running Steve Rowland's Radio Documentary Series. Being a graduate student at Central Michigan University in the broadcasting department and hoping to eventually produce radio documentaries myself, I find this series invaluable.

I hope to see more articles in RW dealing with this aspect of radio production in the future.

Leslie A. Clingman  
Mount Pleasant, Mich.

Thanks John

Dear RW,  
Thanks to John Diamantis for his article on the allure of vacuum tubes. I'm happy to hear I won't have to throw away my old tube checker after all.

Frank Luepke  
KIWA-AM-FM Sheldon, Iowa

Correction:

Burt I. Weiner's name was misspelled in the Feb. 9 "Readers Forum." He can be contacted at 818-409-0185.

# Why has Jim Stevens bought three Format Sentry™ Digital Automation Systems in one year?

1. Because he liked the Format Sentry that runs KIXI Seattle so much.
2. Because he knows Format Sentry is quick to install and easy to learn. It's up and running fast.
3. Because he trusts Format Sentry. He knows he won't be worrying about operations; he can take care of business.

## Why should you buy Format Sentry Digital Automation from Broadcast Electronics?

1. Because Format Sentry is radio's most station-proven digital automation, with over 500 systems delivered. It works.
2. Because Format Sentry is straightforward and easy to operate, even for people who don't know computers.
3. Because Broadcast Electronics and Sentry Systems people are working together to keep Format Sentry on the cutting edge of technology. So you don't have to worry about the future. Take care of *your* business. Call us now.

**(800) 426-9082**



**BROADCAST  
ELECTRONICS, INC.**

**WORLD LEADER IN BROADCAST TECHNOLOGY**

# Radio Withstands L.A. Quake's Fury

*Editor's note: The following is Marvin Collins, chief engineer for KFI/KOST in Los Angeles, first hand account/report on the aftermath of the Northridge, California earthquake in January. The quake caused billions of dollars in damage to homes, business—including audio equipment companies—but most radio broadcasters escaped extensive damage.*

by Marvin Collins

**LOS ANGELES** "Wow! What a wake up call that was." I thought to myself as my wife and I were awakened at 4:31 a.m. Monday, January 17. Immediately, I realized a substantial earthquake was in progress.

I told my wife to remain in bed and avoid being injured by falling or broken objects.

I figured the earthquake was not all that bad because we never lost power at my house. Once the shaking stopped and my wife calmed down a little, we ventured out of bed to check for gas leaks, water leaks and to see what had crashed to the floor. We were fortunate to have no major damage—only a few items fell to the floor and even fewer were broken.

## On the air

After making sure the house was okay, I took a moment to make sure that KFI and KOST were still on the air. I was relieved that they were. (I learned later that both stations went off the air for a short interval while the emergency generator restored power. The studio location was without commercial power for five hours. The AM transmitter site in La Mirada, 25 miles away, and the FM site on Mt. Wilson, 17 miles away, never lost power. At all three sites, power was never lost during the hundreds of aftershocks in southern California, several dozen of which were in the three to five on the Richter scale.)

After I returned to bed, I continued listening to radio and watching television until after sunrise. The quake soon turned out much worse than I had initially thought. At a magnitude 6.6 on the Richter scale quake, it resulted in some very strong acceleration forces in certain areas of southern California. Watching television showed the enormity of the damage to southern California. In the west San Fernando Valley, major freeways were knocked down.

## Radio dependent

For many people, radio (via battery-operated receivers) became the main source of information about their damaged neighborhoods.

Radio broadcasters fared quite well in the quake. Studios suffered with computer terminals on the floor, monitors off the wall, etc., but with one exception all remained on the air or were able to return to the air moments after the shaking stopped. The one exception was KWNK, licensed to Simi Valley with studios in the Fallbrook Mall in the west end of the San Fernando Valley, very close to the epicenter of the Northridge earthquake.

KWNK owner, Manny Cabranes, reported electrical power was lost at the mall for several days. Also power was lost at the KWNK transmitter for 48 hours. Neither location had a backup power source. At the KWNK studio, even after power was restored, inspection of

the mall had to take place. It was three days before KWNK staff received approval from the mall management to enter their studio. Once inside, it was determined that the damage to the studio was mostly cosmetic.

KWNK has an LMA agreement with XETRA and both stations are broadcasting sports programming from the San Diego XETRA studios as well as KWNK studios. With the KWNK studios out of commission, there were large blocks of programming that needed a studio in the Los Angeles area.

For example, sports personality Jim Rome normally does his weekday 11 a.m. to 3 p.m. show from the KWNK studios. Sportscaster Rick Schwartz does a 7 p.m. until midnight show from the KWNK studios. Howard Friedman, the XETRA/KWNK operations manager, called KFI asking if studio space could be used for these shows. With the short notice inherent in an earthquake, a plan was put in place where a small KFI production studio could be used.

## Using Switched 56

It was fortunate that KFI recently installed Switched 56 capability. IDB Communications normally provides uplink service for XETRA. The satellite serves as an STL to the XETRA transmitter site near Tijuana, Mexico. The output of the same satellite/STL is normally received at the KWNK studios in the Fallbrook Mall.

It was fortunate that XETRA had program circuits to and from IDB Communications in Culver City, which are normally used for the L.A. Kings hockey games. A Switched 56 connection was made between the KFI production studio and IDB Communications. IDB simply made the appropriate patches and 7.5 kHz bandwidth audio traveled to the XETRA studios in San Diego.

The IFB/mix minus audio was sent from the XETRA studios via the program line

to IDB and then patched into the full duplex switch 56 circuit to the KFI production studio, where Jim Rome and Rick Schwartz monitored pre-delay programming in their earphones.

Thanks to the Switched 56 capability it took all of half an hour to have the KFI production studio turned into an XETRA/KWNK studio. This arrangement continued for nine days until the KWNK studio in the Fallbrook Mall was restored to normal operation.

The KWNK transmitter was able to go back on the air as soon as power was restored. In order to receive programming at the transmitter site, a small satellite dish was borrowed from California Digital. The satellite receiver was removed from the studio and installed at the transmitter site to receive the satellite/STL signal from their San Diego studios.

All-news station KFVB was able to remain on the air and provide earthquake coverage, but it lost the flashing beacon lights on their tower. The earthquake probably caused a failure of the lighting transformer that feeds power to the flashing lights.

## Expanded AM-Band Stations Could Be on Air by Summer

by John Gatski

**WASHINGTON** If the FCC doesn't encounter massive resistance to the new expanded band (1605 kHz-1705 kHz) allocation process, stations may be on the air by summer, according to FCC AM Branch Chief Jim Burtle.

As of mid-February, Burtle said the FCC's computer model is trying to come up with the best allocation scheme that might accommodate about 200 of the nearly 1,000 stations that applied for the expanded band. Some 50 kW daytimer stations have even applied—apparently willing to forgo the big power signals for the ability to get a nighttime signal. The FCC, however, has its eye on full-time stations that generate a lot of interference.

Under Docket 87-267, the "AM improvement" docket, the FCC will implement the expanded band as one method to reduce interference and crowding on the existing band. Successful applicants will be allowed 10 kW daytime and 1 kW nighttime power authorization. The stations also will be encouraged to convert to AM stereo. They will be allowed to simulcast on their original frequency and the new one for up to five years.

Protection contours for the expanded band will include an 800 kilometer co-channel and 200 kilometer first adjacent (except for the stations next to the high frequency stations on the existing band).

Burtle said the FCC is close to having a complete allocation scheme "within a month or two," but not everyone will be happy. The maximum would be 200 stations if we lived in an ideal world," he said, hinting that even fewer stations may be accommodated in the new band without interference.

Burtle said the specific timetable for stations getting construction permits to make necessary technical changes (such as transmitters, diplexers, AM stereo generator, stereo boards, etc.) will depend on how many petitions of reconsideration are filed by stations that are not pleased with either their allocation or their rejection for a slot.

## On Target.

Performance, value, and reliability through innovative technology.

5 models available.

- BC6DSL
- BC6DSR
- BC8DSL
- BC8DSR
- BC12DSL

## Vanguard Series™ STEREO BROADCAST CONSOLES

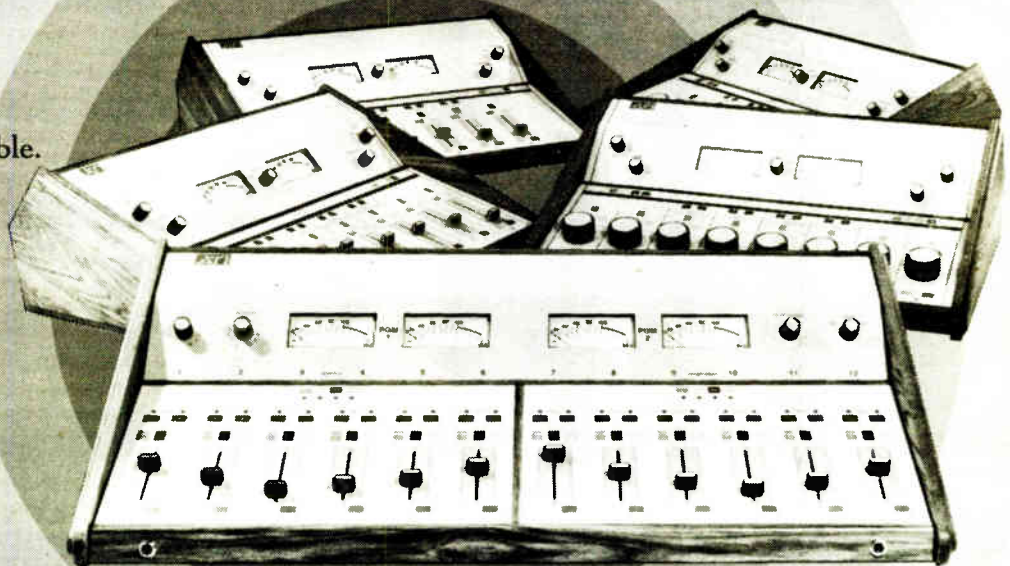

**ATI** AUDIO TECHNOLOGIES INCORPORATED

1-800-959-0307

Call or write for free detailed brochure.

328 W. Maple Ave. Horsham, PA 19044, USA  
(215) 443-0330 FAX: (215) 443-0394

# DBS Digital Audio Expected in 1994

► continued from page 1

develop critical mass quicker. And, secondly, we will be showcased through all the DirecTV venues like Sears, Circuit City and others."

Music Choice will be a beneficiary of a \$120-plus million marketing campaign directed at selling consumers the benefits of video and audio media beamed directly from satellites. In the world's first

deployment of a totally digital television and audio delivery system, Thomson Consumer Electronics, who is building the RCA-brand consumer satellite receivers, has teamed with DirecTV and Hubbard Broadcasting's United States Satellite Broadcasting (USSB), provider of a second DBS service on the same satellites.

The \$1 billion project is the first major competitor to cable televi-

sion in the United States and is the first mass market programming service to ever deliver digital TV pictures and compact disc-quality sound on all channels.

A Hughes-built communications satellite—named DBS-1—was successfully launched from French Guiana on Dec. 17, 1993, on a French-built Ariane rocket. It is the first of two DBS satellites that will beam down the DirecTV

and USSB program services across the United States.

To receive Music Choice and the other programming services consumers must purchase the new Thomson-built RCA-brand DSS digital satellite receiving system, whose basic model is set to go on sale for \$699 in April. The DSS (Digital Satellite System) package consists of an 18-inch user installable satellite

dish, a set-top receiver/decoder and a remote control.

## Local dealers

The DSS receiver package and programming services offered by DirecTV and USSB will be offered through RCA consumer electronics dealers, traditional satellite dealers (known in the trade as TVRO dealers) and the National Rural Telecommunications Cooperative, an alliance of 700 telephone and electric systems serving rural and suburban areas in the lower 48 states.

Thomson recently unveiled a large retail display for the RCA DSS system and announced stringent dealer requirements for handling the satellite package.

"A key to successful RCA DSS sales will be the marriage of hardware and software at retail," said Gilbert M. Ravelette, Thomson's vice president of brand management. "The dealer must commit to that philosophy or the effort will not reach its full potential."

Efforts will be made to sell both DirecTV and USSB program packages to purchasers of the hardware. Programming on the two services does not overlap and allows subscribers to customize premium channel selections.

Currently, according to Del Beccaro, DCR has 125,000 subscribers on cable television systems. He would not predict how many subscribers the DirecTV alliance will bring. "It's hard for us to project and DirecTV doesn't say. The analysts are looking for a million to a half million subs in the first year," he said.

After cable television and DBS, Del Beccaro said telephone is the next major distribution outlet for Music Choice. "There are test markets going on and ultimately they will provide digital audio services," he said.

## A DCR Coup

As for direct satellite-to-automobile service, Del Beccaro said "the technology still needs to move. It must get better." As for DCR's chief competitor, Digital Music Express (DMX) of Los Angeles, Del Beccaro said the DBS announcement is as "reaffirmation" of his company's leadership. "The fact that Sony and Warner came to us. The fact that DirecTV picked us is a reaffirmation that we are the lead horse from a long term strategic standpoint," he said.

Keno Thomas, DMX's executive vice president of marketing, said his company would "take the high road" in responding to its competitor's announcement. "It would be foolish for me to say we would not have liked to have been part of DirecTV," he said. "But overall this is a good day for the category of digital audio because it will put some heat on the cable side and help the marketplace realize how valuable digital audio can be."

Thomas said DMX is exploring ways other than cable to distribute audio to potential customers.

## DAWN... THE SATELLITE COMMUNICATIONS SPECIALISTS

### Professional

Before Dawn, end-users were in the dark about details relating to satellite communications equipment. Dawn Satellite specialists are meeting the product and service needs of today's commercial satellite users.

As product providers for the Radio, CATV, Broadcast TV, and Educational markets, we employ experts who can competently advise you on all your communications needs.

And, unlike some companies, our commitment to you does not end there — we continue to provide engineering and technical support even after the sale.

Dawn Satellite delivers only quality products with unparalleled service, in a very cost-effective manner. We will prepare you to meet the dawn of a new age in satellite communications.

**Call Toll Free  
1-800-866-6969**

### Expertise

Dawn Satellite is dedicated to shedding light on all of your satellite communications requirements. Some products and services provided are:

#### Products:

- ◆ Digital Ready LNB's
- ◆ Satellite Antennas
- ◆ Block Translators
- ◆ Downconverters
- ◆ Satellite Receivers
- ◆ Cable and Connectors
- ◆ Antenna Motorization Systems
- ◆ Accessories

#### Services

- ◆ Technical Assistance
- ◆ Design and Engineering
- ◆ Installation
- ◆ Field Service

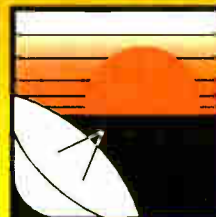
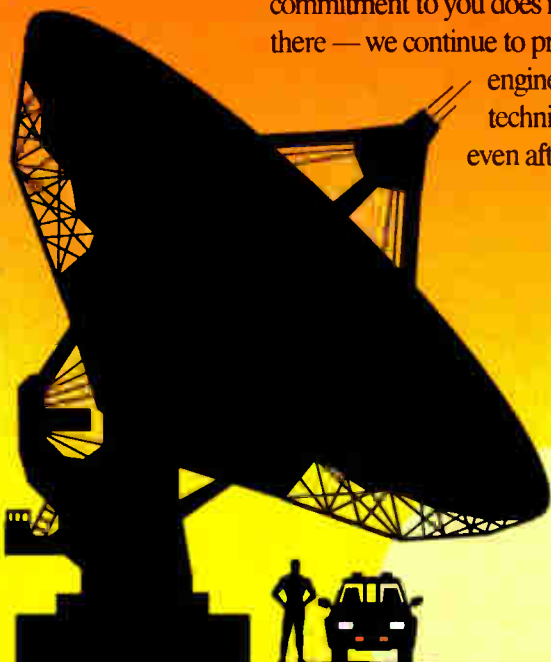
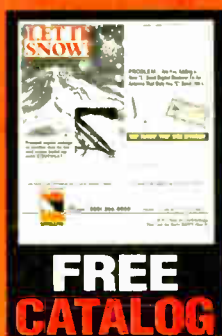

**DAWN  
SATELLITE**

*The Satellite Communications  
Equipment Specialists*

1190 South Lapeer Rd., P.O. Box 628, Oxford, MI 48371 (313) 969-0010 Fax: (313) 969-0377



# EVERYBODY TELLS US THAT BROADCAST ENGINEERS ARE VERY CONSERVATIVE. OKAY. READ THIS AD NOW AND THEN BUY A CR-1604 IN FIVE YEARS.

**W**e understand why broadcast engineers have a wait-and-see attitude about new products. Your station (and your job) depend on rock-solid reliability and sonic performance you can count on.

We'd like to introduce you to Mackie... even if we do probably seem like a wet-behind-the-ears newcomer compared to some manufacturers. We've been around six years now. During that time we've gained a serious reputation for building high-value, trouble-free mic/line mixers.

Mixers with legendary headroom, ultra-low noise and unique features that make using them easier.

Mixers so good that they're regularly used to create major label compact discs, feature movie soundtracks, and more commercial production work than you can shake an RE20 at. For example, our CR-1604 16-channel mic/line mixers are used nightly on the Tonight Show, Arsenio Hall, Conan O'Brian and David Letterman Shows<sup>1</sup>.

Our mixers have also covered hundreds of thousands of miles with acts like Peter Gabriel, Madonna, Whitney Houston, Paula Abdul, Bruce Springsteen, Reba McEntyre, Alabama and Michael Jackson<sup>1</sup>. Compared to the relative security of a station production room, a six-month world tour is about the most brutal test that any electronic component can go through. Our mixers have a reputation for being bullet-proof on the road — even when loading dock mishaps and power surges have taken out everything else in the same rack.

As for use at broadcast facilities, well, we're not total newcomers. A quick scan of our warranty database shows that over 70 U.S. radio stations already have Mackie mic/line mixers in place.

Does that mean you folks aren't as conservative as everybody says? If so, call your favorite broadcast supply house, or dial us toll-free for complete information on Mackie's line of mixers.

If you are conservative, keep an eye on us, anyway. We want your business even if we have to wait five years.

**3-band equalization** done right:  $\pm 15\text{dB}$  at 80Hz,  $\pm 12\text{dB}$  at 2.5kHz (perfect for voices),  $\pm 15\text{dB}$  at 12kHz. Far more useful than traditional 100Hz, 1kHz, 10kHz EQ.

**Sealed rotary potentiometers** resist contamination from dust, liquids and smoke. Plus they have a smooth, positive feel without a trace of wobble.

The Mackie Designs 16x2 CR-1604 Mic/Line Mixer. Suggested retail price, \$1095<sup>2</sup>. Available at America's top broadcast supply houses.

**Six recording studio-grade microphone preamps** with +48VDC phantom power. Discrete circuitry with four conjugate-pair, large-emitter geometry transistors delivers  $-129.6\text{dBm}$  E.I.N., 300K bandwidth, 0.005% THD... and incredible headroom. A Very Famous Maker of Expensive German Microphones uses a CR-1604's preamps to demo their mics at tradeshows.

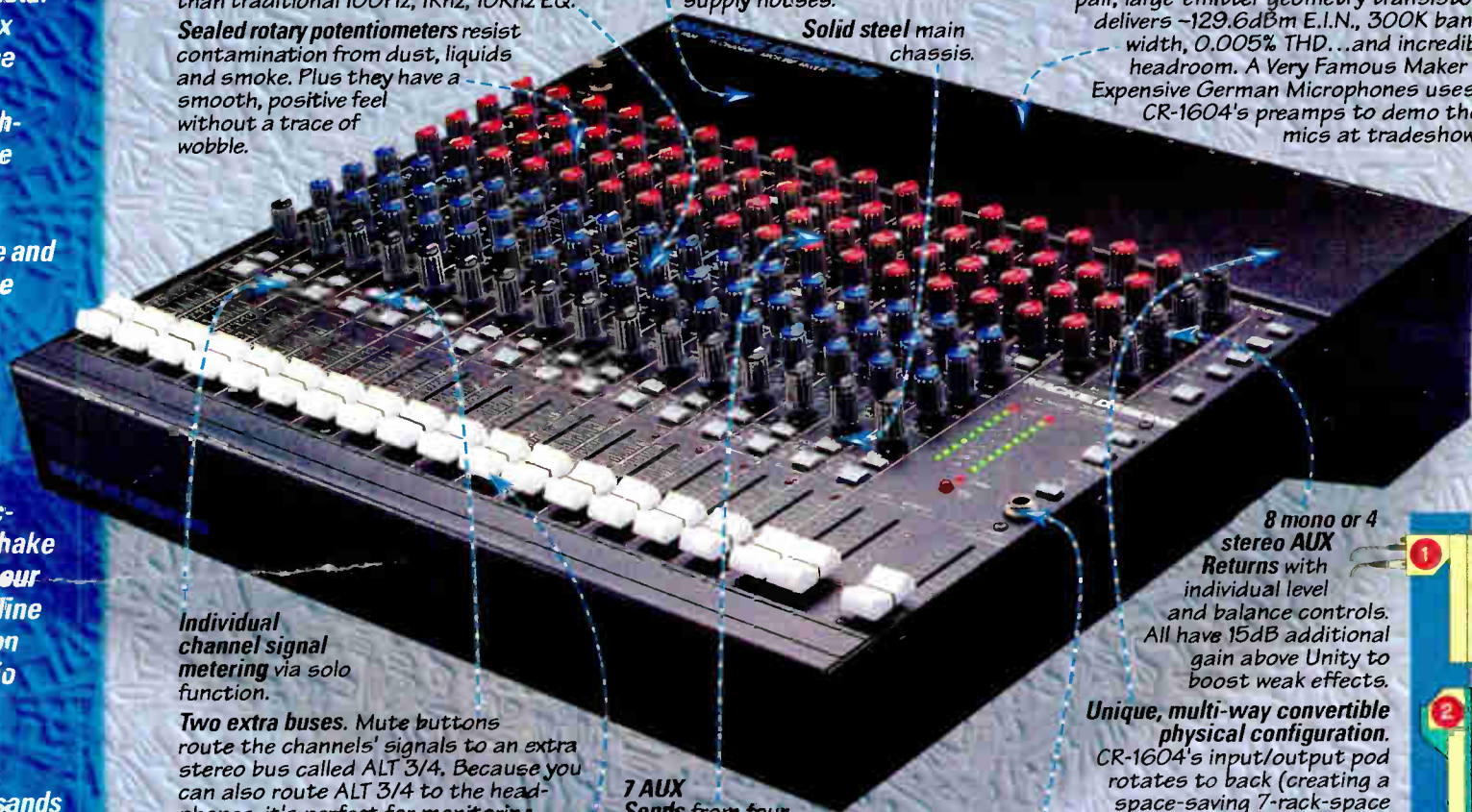

**Solid steel main chassis.**

**Individual channel signal metering** via solo function.

**Two extra buses.** Mute buttons route the channels' signals to an extra stereo bus called ALT 3/4. Because you can also route ALT 3/4 to the headphones, it's perfect for monitoring advance audio cues: Preview a signal that hasn't been brought up in the mix yet... then add it by unmuting the channel.

**UnityPlus gain structure** gives high headroom and low noise at the same time. Set the fader to center-detent Unity Gain, press channel solo to monitor the channel via the CR-1604's LED meters, adjust the input trim ONCE, and you're ready. Because there's 20dB MORE gain available on the fader, you won't need to constantly re-adjust the trim.

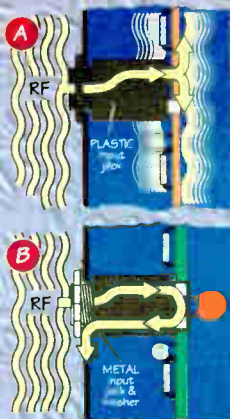

**Maximum RF protection.** Most compact mixers use plastic jacks that transmit RF to the main circuit board where it's re-radiated and picked up by anything that rectifies (A). The CR-1604 uses metal jacks and washers plus a shunting capacitor to de-rail RF before it gets to any circuit traces (B). A Radio World reviewer tested a CR-1604 on a transmitter hill with 3 VHF TV and 1 FM sticks plus several microwave repeaters and shortwave transmitters. When he plugged in a notoriously RF-prone microphone, he detected NO RF.

**Not shown:** Inserts on Chs. 1 thru 8, main left/right bus inserts, phantom power switch, balanced/unbalanced main stereo outputs and separate mono output. XLR10 Mic Preamp Expander connects to the CR-1604 pod to provide 10 more preamps complete with trims and phantom power.

**7 AUX Sends** from four knobs. AUX 1 can be used as an effects send or headphone monitor cue via the MON. Sends 3 & 4 become AUXs 5 & 6 when the SHIFT button is pressed. All sends give you 15dB more gain above Unity so that you can get tons of effect even when the channel fader is pulled down.

**Powerful headphone amp** (with volume control) drives any phones to head-banging levels even an AOR production person will appreciate.



**A chip off the old block:** Perfect for remotes, our MS1202 12x2 Mic/Line Mixer has 4 of the same superb mic preamps that distinguish our larger CR-1604, plus phantom power, 2 AUX sends/ch., 2 stereo AUX returns, channel patching, 2-band EQ, 3-way 12-LED peak metering, headphone monitor amp with level control, built-in power supply. Suggested retail is just \$399!

**8 mono or 4 stereo AUX Returns** with individual level and balance controls. All have 15dB additional gain above Unity to boost weak effects.

**Unique, multi-way convertible physical configuration.** CR-1604's input/output pod rotates to back (creating a space-saving 7-rack-space mixer shown in Fig. 1), or to front (10 rack spaces, shown in Fig. 2) with our optional RotoPod bracket. Use the CR-1604 on a tabletop with jacks on the same plane as the controls via the RotoPod bracket (Fig. 3 below), or jacks to top (Fig. 4 below). Our XLR10 Mic Preamp Expander can also be added in any of these configurations.

**Rugged design and construction.** Including mil-spec, double-sided, thru-hole-plated fiberglass circuit boards (horizontally-mounted on brass stand-offs for impact-resistance), double-parallel-wired faders for 2-times redundancy, and electronic protection against power surges, impedance mis-matches and static discharges.

**Better-than-digital specs and headroom.** The CR-1604 has a dynamic range of 108dB and an internal S/N ratio of  $-116\text{dB}$  (versus compact discs' 96dB dynamic range.) This means you're getting a mixer that can handle the output of digital workstations, CDs and DAT tapes without overload.

<sup>1</sup> Mention in this ad denotes documented usage only. Mention is not intended to infer endorsement by any of the television shows listed.

<sup>2</sup> Price is slightly higher in Canada.

# MACKIE.

MACKIE DESIGNS INC. • 20205 144<sup>th</sup> Ave NE • Woodinville, WA • 98072 • 800/898-3211  
FAX 206/487-4337 • Outside the U.S. call 206/487-4333 • Represented in Canada by S.F. Marketing 800/363-8855



# The Dynamax MX Series

"E" Models From 8 to 18 Channels  
New Beige Finish or Metallic Gray

- True modular design
- Ultra-reliable motherboard construction
- VCA mixer and monitor control
- Active balanced line inputs, transformer isolated mic inputs
- Active balanced main and monitor outputs
- Full monitoring/cueing facilities with VCA level control and active source selection
- Built-in cue amp with speaker and amplified stereo 8-ohm headphone output
- Independent remote start for each "A" and "B" input
- Opto-isolated remote module on/off
- Selectable fader start
- New Optional 5-band mic EQ module with pan
- Two inputs per module, mic/line or line/line – line inputs may be mono or stereo, consumer or professional format
- Four assignable outputs – two stereo plus two mono
- Available in 8, 10, 12, 14, 16, or 18 channel models
- Independent level controls for each "A" and "B" input
- Separate audio and logic power supplies
- Sturdy, all-steel construction
- Durable Lexan overlay control surfaces
- Count-up event timer standard
- Two input expansion switches standard
- Excellent RF immunity

*Equipment Solutions To Keep You Number One*

**BSW**®

BROADCAST SUPPLY WORLDWIDE

7012 27th Street West Tacoma, Washington 98466

Toll Free 800-426-8434

Toll Free Fax 800-231-7055

# Data Reduction Aids Some Stations

► continued from page 1

you are working with digital, live-assist automation equipment, the problem is human error," he said.

Vern Killon, director of engineering for KRVN-AM-FM Lexington, Neb., said he has had "excellent results" with his AC-2 studio-to-transmitter links (STLs) and Digital Compact Cassette (DCC) recorders with ISO/MPEG Layer 1. Killon also receives SEDAT feeds (which he says sometimes have a harsh edge, even after adjustment) and experimented with apt-X equipment, but opted not to purchase it.

From his network vantage point, Bob Donnelly, general manager of ABC Radio's satellite operations, said digital compression artifacts are not a major affiliate concern. "Most of the concern we get from stations has to do with (satellite) signal integrity. I would say those issues are also more in the forefront in Switched 56 and ISDN environments," he said.

### Extreme caution

ABC was, however, a sponsor of Herb Squire's dueling algorithm tests (see story, page 35) and Donnelly is among those who believe broadcasters should closely monitor compression distortions.

The relative lack of concern about compression at some stations may be tied to the dwindling numbers of engineers on staff and growing number of managers overseeing technical operations.

Contract engineer Jim Addie of Addie-Tech, LaGrange Park, Ill., said he was working with a station setting up a stereo ISDN remote. "They probably don't know that there is going to be data reduction, and I don't think they care, because if they had to do it any other way than ISDN, they wouldn't do the remote. It's too expensive to do it any other way," he said.

Full-time station engineers, even those who have not had major problems with compression, tend to agree with Donnelly's call for caution.

"I have mixed feelings about compression,"

said Gary Wachter, chief engineer, KFYY(AM)-KKFR(FM) Phoenix, who receives a SEDAT feed and works with a compressed digital audio workstation, but has not experienced any transcoding algorithms. "If I can do without it, I prefer to,



but in some limited bandwidth areas—telephone communications and STL links—it's a necessary evil at this point."

### Duopoly-related

Many broadcasters have little or no compression in their operations, but are planning to install it in the near future.

"Everything is still analog here...We still have a lot of ITC cart machines that just haven't reached the end of their life cycles yet. But within six months or so we might be seeing some changes," said Larry Waggoner, chief engineer at KFH(AM)-KXLK(FM) Wichita, Kan., where SEDAT and a few CD machines are the only traces of the digital age.

But KFH-KXLK are two of four stations set to be sold to a group in the process of establishing a four-station duopoly in Wichita "and we expect they'll be making some changes" once the deal is complete, Waggoner said.

The FCC's new radio ownership rules, which encourage radio market consolidation duopolies and local marketing agreements, are often the trigger for digital equipment purchases.

WRLT(FM)-WRLG(FM) a recently formed duopoly of Class A stations in the

Nashville area, installed a Moseley DSP-6000 STL with apt-X compression to deal with scarce available microwave spectrum. Compressed WRLG signals were needed to form an adequate STL path when WRLG's studios moved in with WRLT. Chief Engineer J. Gibson Prichard said.

The stations also receive SEDAT and MUSICAM satellite feeds and are planning to install an AC-2 program storage system. Prichard has had few problems with the systems, although he said male voices and other low-pitched audio is sometimes damaged, which he attributes to apt-X.

### Anti-algorithm

Some stations do not compress their signals at all and have no immediate plans to start, citing both quality or economic reasons.

Herb Squire, chief engineer of classical and jazz programmed WQEW(AM)-WQXR-FM New York, who raised the temperature of the dueling algorithm debate last year, uses only one compressed ISDN link for basketball broadcasting and occasional remotes.

"We're not typical at this point because we don't take a lot of material from outside, and what we do take is mostly on analog phone lines. It's not an issue yet," Squire said. He does not plan to store compressed music because the cost of hard-disk memory is going down fast enough to allow for uncompressed libraries.

"Data reduction should be used when that is the only alternative you have for getting from point A to point B," such as a difficult STL path, he said.

Gordon Carter, chief engineer of commercial classical station WFMT(FM) Chicago, who participated in subjective listening test of compression systems for National Public Radio (see story, page 32), is in a situation similar to Squire's.

"We haven't really found the need for it," Carter said.

continued on page 13 ►



## Quality\* Power Tubes

- 4X150A
- 4CX250B
- 4CX250BC
- 4CX250R
- 4CX350A
- 4CX15,000A
- 4CX15,000J
- 5CX1500A
- 5CX1500B
- 8560AS

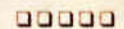

- Watch this list grow.
- Manufactured in Russia's largest power tube factory.
- Generous\* warranty based on high quality.
- Honest prices based on quality at low cost.
- Shipment from USA stock.



**Svetlana**  
ELECTRON DEVICES

Broadcasters  
Call: 800-239-6900  
FAX: 205-880-8077

OEMs, Distributors,  
Volume Purchasers  
Call: 415-233-0429  
FAX: 415-233-0439

## THE SIMPLE SOLUTION FOR DIGITAL AUDIO TRANSPORTATION

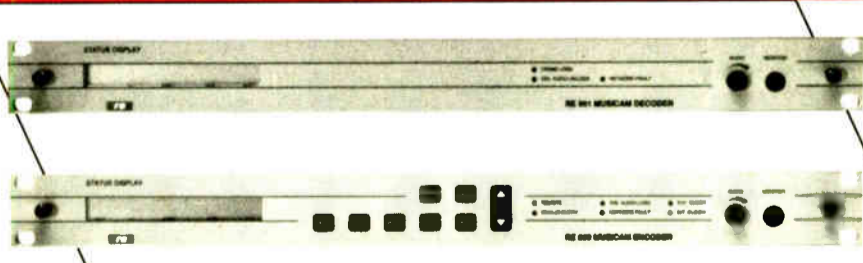

The RE 660/661 MUSICAM Digital Audio Codec was developed to enhance MUSICAM technology, providing up to 20 kHz of audio bandwidth. From satellite networks to switched 56 telephone lines, the full-featured RE 660/661 is completely bit rate flexible up to 384 kbit/s. Applications range from network program distribution to remote pick-ups for sports, concerts, special events, news gathering, STL back-up, audio backhaul, recording and post production studios.

When it comes to digital audio transportation, nothing comes close to the RE 660/661 for providing quality audio with hassle free set up. Backed by 55 years of experience in analog and digital audio products, the RE 660/661 is the simple MUSICAM solution for all your digital audio transmission needs.

Available through Broadcasters General Store, Harris Allied and RF Specialties

<ul style="list-style-type: none"> <li>▲ MUSICAM ISO/MPEG Layer 2, 2A</li> <li>▲ Switched 56, 64 kbit/s, ISDN, Fractional T-1</li> <li>▲ User data channel from 300-9600 baud</li> <li>▲ Easiest set-up locks to network or internal clock</li> <li>▲ Fully automatic decoder reduces operator set up</li> </ul>	<ul style="list-style-type: none"> <li>▲ Multiplex or redundant two times 56/64 for 112/128 kbit/s</li> <li>▲ Mono, Dual Mono, Stereo, Joint Stereo operation</li> <li>▲ AES/EBU and SPDIF digital interface <i>included</i></li> <li>▲ Two-times V.35, X.21 or RS 422 interface <i>included</i></li> <li>▲ Headphone monitor <i>included</i></li> </ul>
--	--

**RE AMERICA, INC.**  
31029 Center Ridge Rd. ▲ Westlake, Ohio 44145  
Phone: (216) 871-7617 ▲ Fax: (216) 871-4303

# YOU DON'T KNOW WHAT YOU'RE MISSING

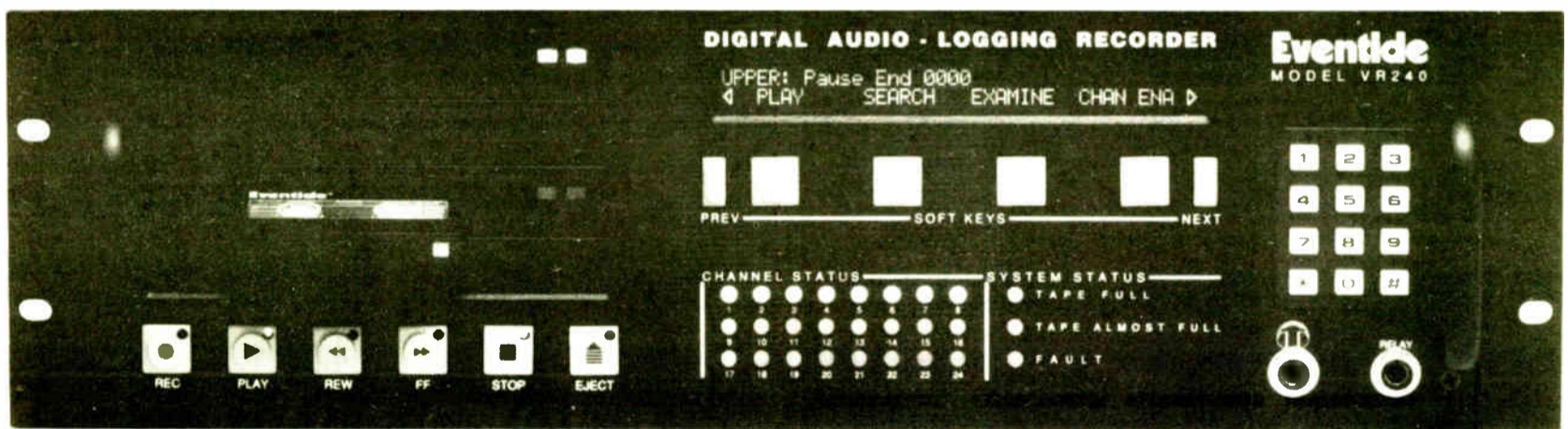

**If** you don't have an Eventide® VR240 Digital Broadcast Logger, you're missing the easiest, most efficient way to keep track of everything that goes out on your air, and more. There's no bulky, high maintenance, hard-to-use hardware, because Eventide has compressed a complete 8-to-24 channel digital broadcast logging system into one easy-to-use three-rack-space device. There's no need for a tape warehouse, either—the VR240 records up to ten days worth of audio on a single ultra-compact DAT cassette. With the dual-drive option, total unattended logging time stretches up to three weeks. And yes, you can search and play a tape on one deck while simultaneously recording audio on the other.

Without an easy, practical, multi-channel logging system, you're missing what's going on with your crosstown competitors, what your talent (and call-ins) *really* said on the air, when that commercial *actually* ran, who called your contest lines, what the police and fire

dispatchers said. The VR240 even records modem, fax, and transmitter remote control telemetry transmissions. The advantages of logging have always been clear. Now the Eventide Digital Broadcast Logger gets rid of the disadvantages.

There's no broadcast logging system as advanced as the VR240. And with hundreds of Eventide-built digital loggers already in service worldwide, there's no other digital logger with our track record of reliable service. So don't miss out—call Eventide or your broadcast distributor for full information on the logger that makes full-time logging practical: The Eventide VR240 Digital Broadcast Logger.

## Eventide

One Alsan Way • Little Ferry, New Jersey 07643 USA  
Tel: 201-641-1200 • Fax: 201-641-1640

# One-Scheme Approach Viewed Favorably

► continued from page 11

WFMT used a compressed ISDN remote link for a short time, but an advertising client provided the equipment and when the client left all compression ended. The station was also a test facility for Sony's MiniDisk system with ATRAC compression. But the station opted against buying the system because there was little pre-recorded classical music available on MiniDisc.

## Reservations

Carter also had reservations about subjecting classical music, with its wide range of volume and pitch levels, to heavy compression. Jazz music was even more adversely affected by compression during the NPR tests, he said.

WRLT-WRLG's alternative rock format is more "forgiving" of compression errors, Prichard said. "You can't tell whether the effects of the compression are something that they were trying to do in the studio when they recorded the album."

The effects are more noticeable during jazz and new age programs the stations air on the weekends, Prichard said.

Regardless of any past experience with compression systems, engineers seem interested in pursuing the idea of one compression system throughout the broadcast chain, as California Digital Audio Systems Inc. (CDAS) is proposing for MUSICAM (see Part I of this report, Feb. 23).

The final decision on DAR should determine the single algorithm in broadcast studios, Tony Masiello, vice president, technical operations, CBS Radio said. CBS supports MUSICAM

through its involvement in the USA Digital in-band, on-channel DAR development. "It will allow a station to stay digital as much as possible—analogue in the microphone and then the next time it's analogue is when it's on somebody's speaker."

## Open-ended architecture

"I would like to see a data-reduction system in an open-ended architecture where the actual data transmission doesn't depend on a particular encoding and decoding

process," Addie said. Stations would instead be able to choose their own compression approach and stay with it throughout their operation.

But the single-algorithm approach will not help those stations that have already invested heavily in compression equipment. "I don't think that's a bad argument, but if you're using various manufacturers' pieces of equipment, you can't do that," said KRVN's Killon.

For budgetary reasons, it will be several years before KRVN upgrades to a single-compression-system operation.

□ □ □

RW Associate Editor T. Carter Ross contributed to this report.

**RW's In-Depth Audio Compression continues on page 32.**

## RW Poll Gets Low Response

RW's survey of digital audio compression users in the radio industry was a bust. The Dec. 8 and 22, 1993, and Jan. 12, 1994, "Readers Forum" pages, included invitations to radio station managers and engineers to submit their experiences with compression—setbacks and benefits—as well as their opinions on future applications of compression.

The survey drew only four responses, one of them from an equipment company president, Robert Easton of 360 Systems.

Perhaps Easton's letter explains the low response level. "After delivering thousands of DigiCarts over the years, we haven't received a single phone call from the broadcast industry about the quality of Dolby AC-2 data compression," he said.

In spite of broadcasters' concerns about compression reported elsewhere in this issue, most broadcasters may be fully satisfied with their equipment purchases and found sufficient remedies for whatever compression artifacts they have encountered.

The three engineers that did respond agreed that dueling algorithms are potentially a serious problem.

"I view the problems associated with data reduction systems as very serious since they are likely to become standardized at some point, and we will have to live with them," Jim Addie, an Illinois-based contract engineer, said.

The two station engineers responding, said they would make the same purchases of compression equipment or services if they had it to do over again.

## EVOLUTION OF DESIGN

*"The Best Is Now Even Better"*

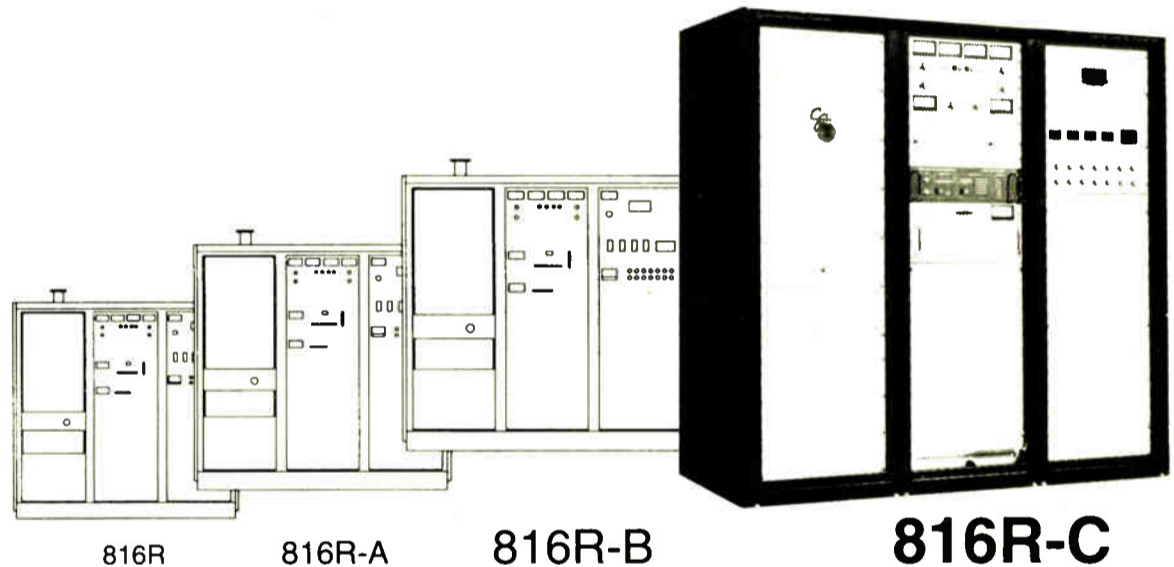

### New Continental 816R-C Series FM Transmitters 21.5kW 25kW 27.5kW 30kW 35kW

They may look alike . . .but each generation 816R is a landmark design enhancement. We keep those qualities that make this the World's most reliable, high performance transmitter. We make changes only where new technology improves the performance and dependability of the 816R.

#### WHAT'S THE SAME:

- Self Neutralized 1/4 Wave Cavity
- Exclusive Solid-State Softstart™
- Self-Contained\* in Single Cabinet
- Built-in Filament Voltage Regulator
- No External Harmonic Filter
- Positive Air Pressure Cabinet
- Continental's Two Year Warranty

\*Separate HV Power Supply in 35kW

#### WHAT'S NEW:

- New Digital Synthesized 802B Exciter
- Solid State IPA In Roll Out Drawer
- All PC Cards Now in Front Panel
- Complete Power Supply Access
- Improved Metering Positions
- Designed for Ease of Maintenance
- New Continental Colors



**Continental Electronics Corporation**

P. O. BOX 270879 DALLAS, TEXAS 75227-0879 214-381-7161 TELEX: 73-398 FAX: 214-381-4949

**IN STOCK NOW  
READY FOR IMMEDIATE DELIVERY**

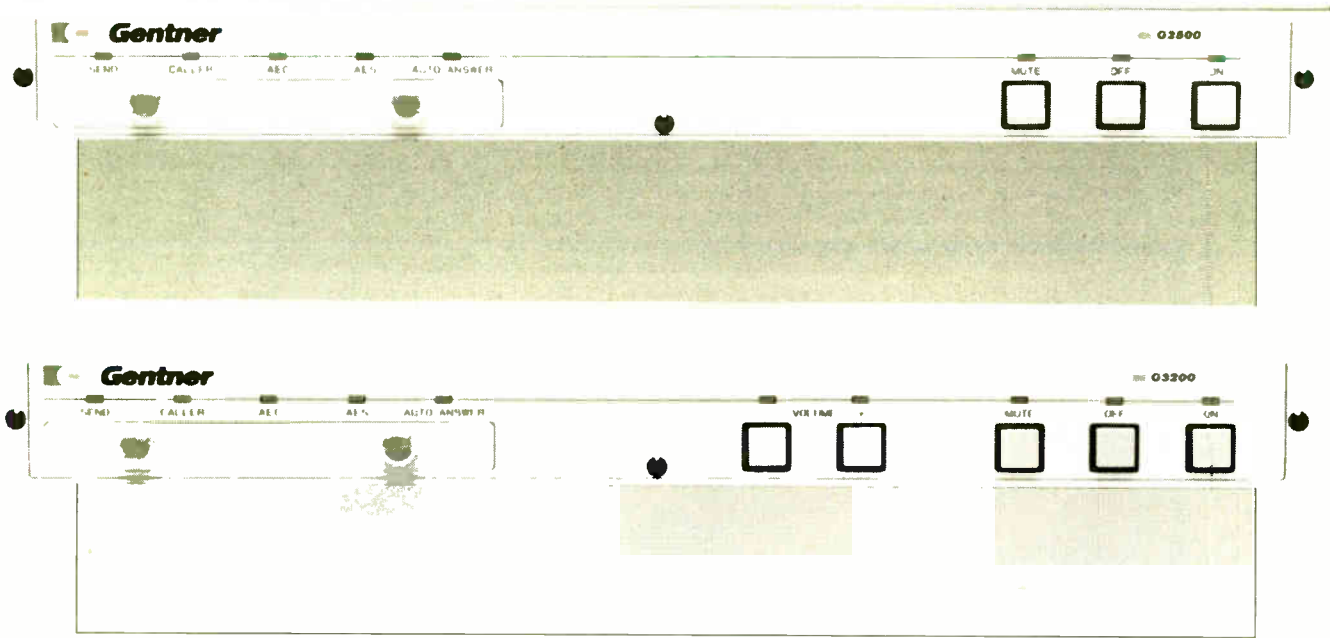

# Superhybrids.

Improve your telephone audio with Gentner's new G2500 and G3200 digital hybrids. These "Superhybrids" provide the very best telephone audio quality. The same quality you've come to expect from Gentner.

Use the G2500 with any audio board or console. Unlike other hybrids available today, the G2500's Auto Mix Minus allows you the freedom to feed program output down the telephone line, even when the output contains caller audio. The G2500 automatically removes the caller audio from its feed path.

Take the G2500 anywhere you like. The automatic answer/disconnect, nulling, re-null on new line selection, RS-232 control, and single-cable conferencing with another G2500 lets you take it with you. And an acoustic echo suppressor further reduces the chance of feedback.

Designed for large talk shows or talk shows with a live audience, Gentner's G3200 combines both digital hybrid technology and digital acoustic echo cancellation to provide clean telephone audio. No matter how good the studio's room acoustics, some of the caller audio

appearing on the studio speakers will work its way back to the mics. The G3200 recognizes this caller audio and digitally subtracts it from its SEND audio path. The result is clean, intelligible audio on both sides of the telephone call. And you won't have to worry about volume—turn the studio speakers up as loud as you want.

If you need additional feedback control (for poor acoustic areas), use the G3200's Acoustic Echo Suppressor (AES). It acts as a reverse "caller control," suppressing send audio when the caller talks.

The same automatic

features as the G2500, plus a built-in auto mic mixer (up to 3 mics) and power amplifier, make the G3200 ideal for use in any talk show location.

Consistent and superior telephone audio, call after call.

## Gentner

Put Gentner's digital hybrid technology to work for you. Call the professionals at Harris Allied.

**8:00 a.m. to 8:00 p.m. EST**  
**1-800-622-0022**  
**Fax 317-966-0623**



# Running Radio

Assess Your Station's Needs. See **Uplink** page 17

Your Resource for Business, Programming & Sales

## USAirplay

### Generation X Aims at Mainstream Radio

by Charles Taylor

**WASHINGTON** If R.E.M., The Cure and Soul Asylum are your radio artists of choice, then "X" just might mark the spot for you.

"Radio X," a newly formulated radio for-

market, has been the target of intense examination and deliberation in advertising and retail circles. The faction's interests and beliefs, not to mention its \$125 billion worth of buying power, have been picked, pawed and pondered by everyone from car manufacturers to political parties vying for

to take dominant elements of the target group's preferred music—just left of mainstream—and bring them into the mainstream. This mark would fall somewhere between the youth market's current enchantment with rap, "gangsta" and hip hop, and the late-20s demographic's consolation in Mariah Carey, Jon Secada and (eek!) perhaps even Michael Bolton.

"Generation X is not satisfied with radio today. No one is giving them what they want," insists Cheryl Broz, a consultant with Shane Media and the 29-year-old developer of Radio X. "This is a provocative format with an attitude—a top 40 method with an AOR approach."

#### Sample hour

A sample hour of the format's catalog might include INXS, The Pretenders, the Psychedelic Furs, Talk Talk, The Cure and Duran Duran—many of the artists that 18-29 year olds developed their musical

leanings with. Broz says these artists are carefully balanced with new acts often heard on traditional modern rock stations such as Beck, Spin Doctors or Nirvana.

"I'm all for supporting these acts, but the key is to be familiar," Broz acknowledges. "Too much new music makes the station sound uncomfortable."

In other words, the music is hip, but not too, the artists on the edge, but with enough mainstream success to have delivered them from college-level popularity.

#### Roots in modern rock

Such a format is no doubt rooted in modern rock radio, which attempts in most major markets to be the cutting edge outlet. College radio, usually low power, pushes the limits further, serving as the true renegade and often first level of acceptance for many artists.

Radio X draws elements of this brand of radio in its personalities and liners, but makes it agreeable to the middle ground of its age demographic through music that dares to be different from top 40's balladry and rap extremes, but

continued on page 21 ▶



Generation X Consultant Cheryl Broz

mat, hopes to revolutionize the airwaves by appealing to a hip, trendy demographic that marketing gurus label "Generation X."

The group, which generally characterizes streetwise, societally disillusioned 18-29 year olds struggling with a resistant job

the forceful youth vote. And justifiably: the age bracket comprises more than 46 million Americans, according to Advertising Age magazine.

Radio X, offered by developer Shane Media as a CD library and consulting package, aims

## UPI Takes News Delivery to a Higher Level!

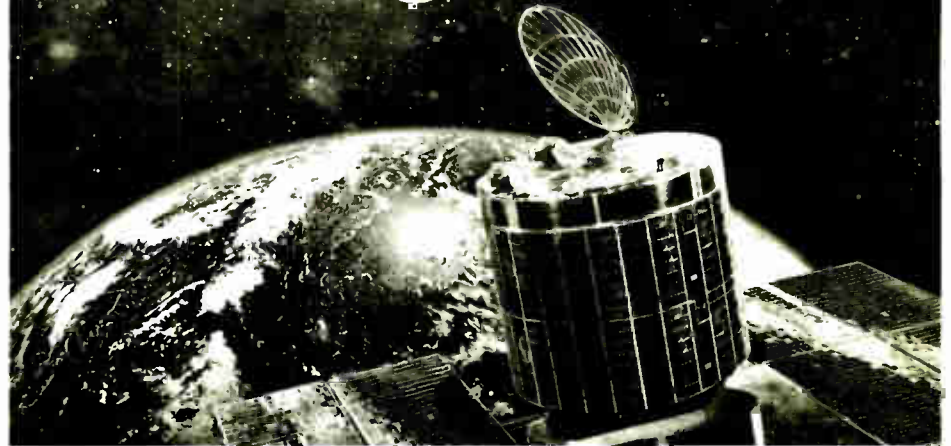

United Press International is making global news more accessible, understandable and affordable than ever before with their Global News Network. Today's most advanced information highway delivers news and information anywhere in the world at a super fast 20,000 words per minute.

#### BOOTH

**515 & 614**  
Multimedia World  
Hilton Convention Center

**(800) 503-9993**

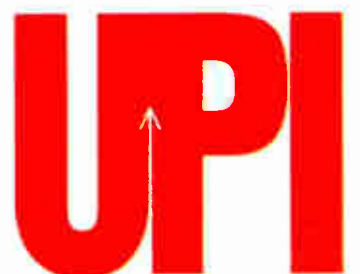

UNITED PRESS INTERNATIONAL

For a faster and simpler way to view and analyze the news, UPI also introduces UPI WorldView™ software for Windows®. Each member of your organization can now retrieve only the news they want - just by clicking on a button. With photographs, clip art, audio sound bites and, eventually, video, UPI WorldView gives you the complete story.

For a demonstration of UPI Global News Network and UPI WorldView, stop by our booths at NAB'94.

Windows® is a registered trademark of Microsoft™ Corporation

## ATTENTION P.D.s

Schedule the best in "OLD-TIME RADIO" with

### When Radio Was...

Hosted by ART FLEMING, original star of "JEOPARDY"

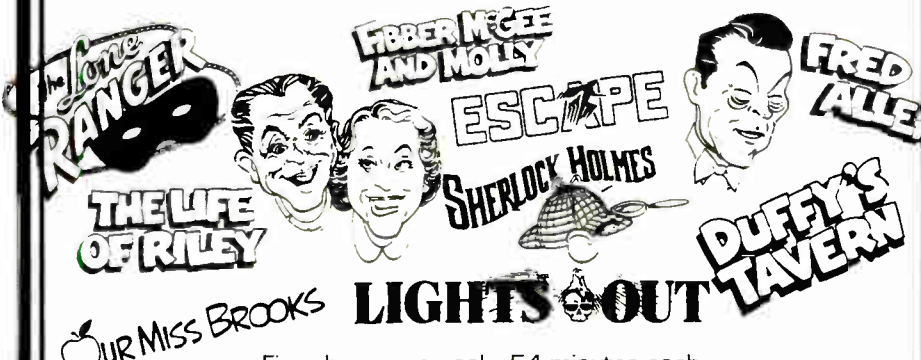

Five shows per week—54 minutes each.

**BARTER, NO CASH PAYMENTS!**

Delivered via Satellite (SATCOM).

For more information contact David West at

**DICK BRESCIA ASSOCIATES (201) 385-6566**

When Radio Was

celebrates its 4th year on 100 stations.

**OTARI'S NEW R-DAT:  
PROFESSIONAL QUALITY WITHIN YOUR REACH.**



When you've had enough of unreliable "warmed-over" consumer decks, we've got a *professional* R-DAT for you at an affordable price.

Our new DTR-90 delivers the rock-solid reliability and superb sound that have made Otari audio machines the choice of professionals everywhere, and at the same time delivers all the performance and features you'll ever need.

For example, so you can make changes fast and easily, the DTR-90 is the only R-DAT available with individual record insert on Ch. 1, Ch. 2, and time-code channel. And its user-friendly front panel features an LCD screen that gives you powerful functions often relegated to DIP switches in other R-DATs—you can even detach the control section of the front panel and use it as a remote unit!

You'll also appreciate the optional Time-code Card with its chase synchronizer for tight lock with VTRs and ATRs, as well as features like read-after-write and punch-in, punch-out.

And if you need a complete electronic editing system, you can't do better than couple the DTR-90 with Otari's CB-149 editor for flawless digital editing.

For the complete story on this quality-built and affordable R-DAT, call Otari at (415) 341-5900.



**Otari Corporation**  
378 Vintage Park Drive  
Foster City, CA 94404  
U.S.A.  
(415) 341-5900  
Fax: (415) 341-7200

**Otari Corporation**  
U.S.A.  
(415) 341-5900  
Fax: (415) 341-7200

**Otari Inc.**  
Japan  
(0424) 81-8626  
Fax: (0424) 81-8633

**Otari (UK) Ltd.**  
United Kingdom  
(0753) 530777  
Fax: (0753) 542600

**Otari Deutschland GmbH**  
Germany  
02159-50861-3  
Fax: 02159/1778

**Otari Singapore Pte., Ltd.**  
Singapore  
(65) 743-7711  
Fax: (65) 743-6430



UPLINK

# Assess Your Station's Engineering Realistically

by Karl Baehr

**ALBUQUERQUE, N.M.** This year, KBE celebrates its tenth anniversary. We've been through many stations during that time, and one thing that continually amazes me is that many operators tend to neglect that which is their very life's blood: the sound of their radio station. It seems that many adopt the "if it ain't broke, don't fix it" attitude and that engineering only becomes important when something is broken. This puts the engineering department pretty far down on the totem pole and always in crisis management.

This time out I have enlisted the assistance of our consulting engineer in Houston, Rick Jones at System One Studio Concepts. In fact, the process we will discuss is the same process we initiated at a client of ours in that area recently.

Following is a list of 10 things you can do right now to improve your station's engineering:

- Assess where your station stands technically. Take a look at your EBS, logs, tower lighting systems, remote control system (particularly if you are using a remote monitoring service), STL, studio and production room equipment and transmitter site.

A great way to get a bearing is to use the FCC self-inspection report. Rick would be glad to get a copy to you and you can call him at 713-946-1946.

- Once you have a gauge as to where you are now, identify the weaknesses. Proceed systematically and schedule what is to be done, do not go about it randomly. Prioritize any modifications or fixes or replacements. Depending on your condition, you may want to improve your processing or add to your studio/production room equipment.

Give yourself time to evaluate your options. Do you want to just order new equipment or put out the word and maybe find a good used piece of gear?

### Clean as a whistle

- Clean everything! Don't just polish the knobs and clean the heads. Get out that shop vacuum and get the dust, cobwebs and crud out of all your gear. Piles of dust and dirt help to retain heat and you could be cooking your gear to death. Most electronic gear does not need any help generating heat.

Keep in mind that a majority of problems associated with automated cart/tape systems can be attributed to misalignment and/or calibration.

- On line with my opening comment, sit down with your engineer and set up effective parameters for repair/replacement and budget. Trust his judgment; if you do not for some reason, find someone who's judgment you do trust. Pressure to put on a bandage where surgery may be required will only affect your overall performance negatively. Do not develop a relationship where your engineer is hesitant to tell you what is really needed as he feels you will say "no" if it costs anything.

- When was the last time you visited your transmitter site? Are all the systems out there as efficient as they can be? Remote, STL, phones, ventilation, cleaning? Proper transmitter maintenance

will of course enhance your performance and the longevity of your transmitter, thus minimizing the possi-

bility of catastrophic failure.

**One thing that continues to amaze me is that many operators tend to neglect that which is their very life's blood: the sound of their radio station.**

An hour or so here and there for your engineer costs a damn sight less than a

new or even used transmitter!  
• If you have backup systems, generators, UPS, transmitters, EBS, phone or

lighting systems, these require regular testing and maintenance too. The purpose for these systems is a safety net

should your primary systems fail.

Make sure that every backup system is functioning properly and that your staff know how to engage them beyond fumbling through a manual they may have never read. Which brings us to...

### Write the manual

- Together with your engineer, develop a logical, easily understood manual that includes vital functions such as transmitter control, how to shunt to backup systems, who and when to call for help, the whole process, step by step. If I was paid for everytime I got a call in the middle of the night, "...we're off the air,"

continued on page 21 ►

**THESE GM'S CALLED US...**

**IMPORTANT MESSAGE**  
FOR: C.T.  
DATE: 7/30/93 TIME: 10:25 AM PM  
M: John Mehron  
OF: WNUA  
PHONE: 312/645-9550  
TELEPHONED:  PLEASE CALL  
CAME TO SEE YOU:  WILL CALL AGAIN  
WANTS TO SEE YOU:  RUSH  
RETURNED YOUR CALL:  SPECIAL ATTENTION  
MESSAGE: Mid-day numbers look great Telemarketing really worked!

**IMPORTANT MESSAGE**  
FOR: Courtney Thompson  
DATE: 1/20/93 TIME: 1:30 AM PM  
M: Dave Kendrick  
OF: KKSF  
PHONE: 415/788-2022  
TELEPHONED:  PLEASE CALL  
CAME TO SEE YOU:  WILL CALL AGAIN  
WANTS TO SEE YOU:  RUSH  
RETURNED YOUR CALL:  SPECIAL ATTENTION  
MESSAGE: Cume up 68% as a result of the cassette box & mailer Call asap!  
SIGNED: KOF

**IMPORTANT MESSAGE**  
FOR: Courtney  
DATE: 5/12/93 TIME: 11:20 AM PM  
M: Skip Schmidt  
OF: KOAI-FM  
PHONE: 214/691-1075  
TELEPHONED:  PLEASE CALL  
CAME TO SEE YOU:  WILL CALL AGAIN  
WANTS TO SEE YOU:  RUSH  
RETURNED YOUR CALL:  SPECIAL ATTENTION  
MESSAGE: Thanks for the insightful seminar you gave to our sales staff... they'll sell out the news letter!

**Different markets... different circumstances... one common goal... IMMEDIATE RESULTS!**

These GM's realized that it takes a lot more than "the lowest price" or even a "good idea" to win today. Because they sought the highest return on their investment, they hired Broadcast Direct Marketing.

Dave Kendrick's phone call ultimately resulted in a CUME jump from 249,500 to 365,800 in San Francisco... one of the most competitive radio markets in America.

So, as you look for your next CUME, TSL and/or revenue driven campaign, call us first. We'll deliver a free market profile... and confidentially work together with you to evaluate your goals.

**BROADCAST DIRECT MARKETING INC.**  
DIRECT MAIL • TELEMARKETING • DATABASE

**MIAMI 305-858-9524 • CHICAGO 708-382-5525 • LOS ANGELES 818-782-9524**

## TECH TALK

# Radio Should Consider Its Role on Info Highway

by Judith Gross

**NEW YORK** Did you ever feel like this? Driving along at a reasonable speed, you look over to your left and see these humongous trucks and fast foreign cars zipping along in the same direction—only a lot faster.

Then it hits you: you're on the access road when you ought to be on the six-lane. And there isn't an entrance ramp any-

where in sight. That's how radio station owners and managers may begin to feel if all this talk of the information superhighway keeps on.

The question fueling fears these days is: will radio, now 70-something, be left behind in the dust?

## No easy answers

There is no easy answer to that question, but it's one the

NAB Board heard something about at a Futures Summit held during its annual legislative forum. Speakers ran the gamut from high tech companies (Microsoft) to advertising (Saatchi & Saatchi), and the Board is to be lauded for at least starting to think about the problems and opportunities of the new world that has suddenly opened up by the marriage of telephone, computer and

program provider.

In part, that marriage has been forced, with decisions like the one allowing the phone companies to get into providing video services. In part, it has been merely forged by new technologies looking for a profit center. But what radio managers need to do is look at what's out there, at how the overall picture is changing and at where they may seize an opportunity or

head off a pitfall while there's still time.

## What's out there?

Anybody's list of what technologies radio should be scrutinizing will be somewhat arbitrary at this early stage. My own list includes those which I believe speak the most directly to radio's place in our electronic age.

**Data Compression/Multiplexing:** We've already had a glimpse of some of its potential in DAB. Spread spectrum techniques also fit in here. The key point here is the possibility of splitting up one signal stream into several simultaneous signals. Also, data compression through phone lines and satellite will extend the reach of a signal or replace "wired," "local" or "in person" methods, such as we've seen in the audio recording industry.

**Cable:** In the home, radio may have already felt the sting of competition from digital cable radio. Or some stations might have found a new opportunity to be carried as part of a cable service. Now there are plans to offer services like this off satellite.

**Direct Satellite:** It was a threat when talks of DAB first surfaced, and it has not gone away. It may well become real only after radio has become fully digital from end to end, but the technology is within reach and at some point, a direct from satellite audio service is a likely reality.

**Direct Downloads:** Radio has been a music pioneer over the last few decades—the first place you could hear a new recording, or hear enough of it to decide to buy it. As hard disks team up with modems, phone lines become digital, and all three become more advanced, there is the possibility of direct downloads of new recordings to the consumer.

**Data Transmission:** Whether through subcarriers and/or some form of digital multiplexing or a new way of high speed data transmission, broadcasters, with their installed base, are uniquely poised to answer the demand for data transmission. The NAB's John Abel astutely tackled this possibility in his talk at the Futures Summit, and it's one that could play a large role in radio's future.

**Interactive Service:** Once a signal is digitized, technology has done its job to make interactive service a reality. The rest is up to the receiver manufacturer and the service provider. How about a foolproof way to determine ratings, without the need to write in a diary? Or a voice-

continued on page 48 ►

For 25 Years I.T.C. Has Brought  
Standard Setting Audio Products to Radio.  
NOW  
**DigiCenter™**  
ITC's Digital Audio System for Radio  
BEGINS THE NEXT 25!

- All the benefits of a complete audio management and delivery system.
- All the proven value and dependability of an ITC product.
- All the advantages of digital technology.

**T**hat's DigiCenter... Another significant advancement in broadcasting that will expand your capabilities in programming, management, and delivery of pure digital audio sound.

DigiCenter is brought to radio by ITC—the company serving you so well for 25 years. And, we'll be around for another 25, continuing our reputation for benchmark products, and for customer service.

**THE BENCHMARK IN**  
For the past 25 years...



See DigiCenter in action. We'll give you a hands-on demonstration of how DigiCenter will expand your horizons both operationally and economically. Find out how DigiCenter improves audio quality, personnel performance and station profitability. Call us and begin your future today.

**1-800-447-0414**

**BROADCASTING AUDIO**  
For the NEXT 25 years

ITC Corporation • 2425 South Main Street • Bloomington, IL 61702 U.S.A. • (309) 828-1381 FAX: (309) 828-1386

# Running Radio

## A Supermarket of Radio Station Services

For information on the services shown below, circle the Reader Service number on the enclosed card or contact the advertiser directly.

### POST MODERN RADIO NETWORK

- ◆ Nation's first all alternative programming
- ◆ One hour shows produced weekly by nationally known on-air personalities
- ◆ Delivered to you on CD, DAT or cassette
- ◆ Available on a Barter basis

**THE NATION'S NEW MUSIC AUTHORITY**  
**1-800-737-0900**

Contact:  
 John Soltys

Reader Service No. 43

### EVERYBODY WANTS IT!!

#### 25-54

Imagine having your 25+ audience and expanding them to 54! It's easy with **Globe Music Productions'** 7-Day Lasting Music Library. **EASY/AC** will grab your audience with the most disposable income that your advertisers want.

#### Features Include:

- Delivery on 7" reel tape (no costly changes to your station)
- Music plays 7 days, 24 hours a day without repeats
- Largest library available at lowest cost
- AM's love it as much as FM's

**DON'T WAIT—CALL NOW!**

**Globe Music Productions**

Box 20465  
 Roanoke, VA 24018

Member of the National Academy of Popular Music

**703-344-3283**

Reader Service No. 165

### Affordable Radio Station Billing Software

Many Features Including:

- Daily Log with Automatic or Manual Ad Placement
- Print Customer Statements, Affidavits, Commission and Ad Agency Reports from Info in the Daily Log
- Keep Track of all Revenue and Receivables
- Dozens of Reports Including Open Ad Availabilities, Expiring Ads, Cart #, Sales Reports in various categories, Late Payments, A/R, Mailing Labels, and many more!
- Music Library with Random Playlist

**Software price \$1,500**

Six months free support

\$35 per month unlimited support after first six months

Our Products are Guaranteed! • Custom Design Available

#### Custom Professional Billing Systems

79 Moore Road  
 Summertown, TN 38483  
 (615) 321-0161 FAX: (615) 320-0817

Reader Service No. 99



### Turn Sunday Into Money-Day

1301 International Speedway  
 Daytona Beach, FL 32114  
**(904) 254-6760**

Reader Service No. 21

### NO VACATION OR COFFEE BREAKS FOR THIS RECEPTIONIST!

Welcome to the KXXX information line...

- Press 1 for concert dates
- Press 2 for local ski up-dates brought to you by Big O tires
- Press 3 now for an operator
- Press 4 to leave comments about KXXX programming



finally, an answering system that has more, for less

#### FEATURES

- All digital technology
- PC/Fax switch box
- Choice of 1 or 2 line systems
- 4 separate mailboxes, with call forwarding
- 3 announce mailboxes for product information
- Music or product information on hold
- Speaker monitor, do not disturb, conversation record

**1-line system \$399.95**

\*1 line units require 3 way calling

**2-line system \$499.95**

**CALL NOW TO ORDER 1-800-440-4MAT**

**FORMAT PRODUCTIONS**

FOR MORE INFORMATION: WRITE  
 P.O. BOX 466, Portland, OR 97207  
 Phone (503) 223-4MAT  
 Fax: (503) 222-6408

Not Just Music Libraries Anymore!



Reader Service No. 103

### THE 70'S ARE HOT!

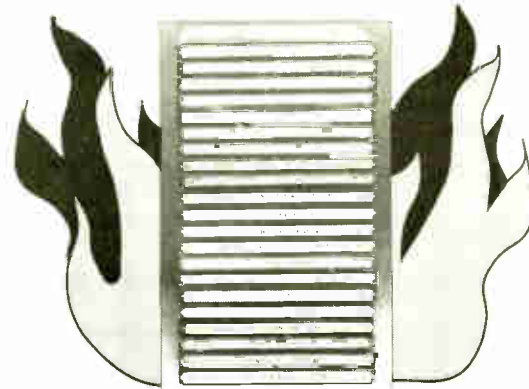

And Halland has radio's only "70's Gold" music library on CD! 545 of the best AC/CHR-Gold hits on 30 CDs. For a song list and info, call **1-800-HALLAND** today!

—Also ask about our other CD libraries—  
 1289 East Alosta Avenue, Glendora, CA 91740  
 Phone: 818-963-6300

Reader Service No. 72

**E**fficient & **\$**  
**S**conomical **\$**  
 \$\$\$ \$\$\$\$\$

Radio World's Running Radio Marketplace reaches over 22,000 radio station owners, managers, programmers and consultants every month.

To advertise your services, contact Skip Tash at **1-800-336-3045**

### Money \$\$ Machine® Contest Lottery®

#### Multimedia Broadcast Promotions

"The Hottest Money-maker and Cume Builder"

NAB Las Vegas

**Multimedia World - Booth 712**

at the Hilton



Fardella  
 Engineering  
 Enterprises

**FEE** Fardella Engineering Enterprises  
 Custom Systems for the Broadcast Industry  
**(408) 229-2949 FAX 229-0432**  
**(800) 546-0898**

264 El Portal Way, San Jose, CA 95119

Reader Service No. 219



#### Expose yourself with a minimum of risk.

Today's level of fierce competition demands that you prominently display your name every chance you get. Theft, vandalism and loss are an expensive reality.

high quality 4 or 6 mil plastic film display your logo and message brilliantly. Now you can afford to display a bright new sign at every public event. They even make great cost-effective promotional giveaways. Just roll off what you need and cut.

Roll-A-Sign® offers a better way. Up to four vibrant colors printed on durable,



Call today and get exposed.  
**800/231-2417**

Reel Industries, Inc. • P.O. Box 750245 • Houston, TX 77275-0245  
 713/484-6892 • 713/947-2053 FAX  
 ©1994 Reel Industries, Inc.

Reader Service No. 34

# Maximize Sales While the Answer is Yes

by Bob Harris

**DALLAS** I just violated one of my own major rules of salesmanship. It involved Super Bowl XXVIII in Atlanta. Our firm produces incentive travel packages for all major sporting events, like the Super Bowl.

We were hosting about 150 people from companies like Frito Lay, Ore-Ida Foods, Glidden Paint, Neiman-Marcus, Cooper Tools, Texas Commerce Bank, as well as some radio stations.

The Super Bowl has truly become one of the biggest "events" in America. It is so much more than just a football game. The biggest stars of radio, TV, movies, politics, sports, as well as football, are all there.

## Forgetting the rule

There are parties and people everywhere, and that's how I broke my sales rule. I have always believed that you should never stop selling when the last thing the client said was "yes."

Just like a radio station, our firm sells packages. The packages include the basics: room, meals, transportation and game ticket. Most radio station packages include the basics. What I failed to do, and I think many radio salespeople fail to do, is sell the extras.

I didn't offer my clients the opportunity to buy more from me. I didn't give the people who had said "yes" to spending money with me the chance to spend more money. I didn't ask for the additional order.

And it would have been very easy. Once they bought our basic package, I could have given them the opportunity to buy optional extras, like the official NFL Tailgate Party. After spending the weekend with my

clients and seeing how much money they spent on other entertainment and gifts, I know I missed the boat by not offering them the chance to buy more from me.

I bet that 80 percent (that old 80-20 rule again) of America's radio salespeople stop selling when the client says "yes." If you've just sold someone and they are in a buying mood, why not ask for some optional extra buy. Why not offer to double their schedule with "overnights" for just 10 percent more? Why not try to add a few dollars with an additional sponsorship?

## Care for some fries?

When I sold for KLIF Talk Radio here in Dallas, Sabrina Burks, now sales manager of the station, always used the analogy of fast food restaurants' suggestive selling line, "Do you want fries with that hamburger?" to demonstrate her point.

And to bring that suggestive selling point home, if you watched the Super Bowl you saw a McDonald's commercial telling you to order the "Super Size" Coke and fries for just 39 cents more. Just think how many millions of dollars that will add up to for McDonald's if just one percent of their patrons order the "Super Size."

For radio sales people, I think the rewards can be just as big, but you must be creative. When your clients says "yes" to your proposal, be ready to ask for additional business. Don't revisit the order you just got, but offer an option or two that makes your station even more of a win-win investment.

Certainly every salesperson knows, or should know, that you must "ask for the order." (I always say "ask for the BIG order.") But how many of us ask for the

order after we just got an order? Don't stop selling when they've just said "yes"!

You should go into any sales call (cold, hot or just drop-in) armed with a menu of results-oriented options to present. You certainly don't stop selling when they say "no," do you? The sales process has just begun. So you must have more than one option to present when they say "no" to your first proposal.

By the same token, when they say "yes," bring out your next proposal (that you know will work for the client), and ask for the order again. Even if you are turned down, you have lost nothing. But what if your prospect says "yes." Maybe that

"yes" to that extra order will be enough to put you over your monthly goal.

To be successful in any endeavor, you must go the extra mile, put in the extra time and act like a winner. Keep asking for the order, even after they say "yes," and you're on your way to being a sales winner!

□ □ □

*Bob Harris is a sales and marketing consultant to the food manufacturer, food broker and radio industries, and is based in Dallas, Texas.*

*He can be reached at PSM, 900 East Park Blvd., Suite 130, Plano, TX 75074; telephone: 214-424-9660, or fax: 214-578-7084.*

## Keep Those Cards and Letters Coming

It was extremely gratifying to hear from so many old and new friends after my first **Radio World** column. When good people you haven't heard from in a long time call, like Joe Vincent, former honcho with the RAB, and Greg Hilton, building a country dynasty in Salt Lake City with KSOP, it really makes one feel good.

And new friends like Tom Lewis, who lives here in Dallas and was kind enough to bring me his copy of **RW** with my first column, before I had even gotten my copy. And Rich Reinhardt, a rookie salesperson with KLYV, Dubuque, Iowa, and Rod Knodel, GM at KCLI, Clinton, Okla., and Donald Sabatke, who created the "Tower of Power" sales promotion that ran on over 500 stations.

Thanks to all of you and the many others who wrote or called, I do want to hear from you; this column is for you, not me. What would you like to hear more about, what's troubling you, what great ideas do you have to share?

Our future column will be devoted to stations that create and use their own newspapers or magazines to get more business, just like Art Suberbielle, owner of KANE, New Iberia, La., does with his superb "Acadiana Lifestyle" monthly newspaper.

If you add revenue with some form of print, I'd like to share your story with **RW** readers. Please contact me at PSM, 900 East Park Blvd., Suite 130, Plano, TX 75074, 214-424-9660; FAX: 214-578-7084.

# Running Radio Marketplace

## A Supermarket of Radio Station Services

For information on the services shown below, circle the Reader Service number on the enclosed card or contact the advertiser directly.

### PRODUCTION

# MUSIC

THE MOST COMPLETE PRODUCTION MUSIC AND SOUND EFFECTS LIBRARY AVAILABLE

Holy Matrimony  
Philadelphia  
Grumpy Old Men  
Ironwill  
The Air Up There  
Dream On  
In Living Color  
Saturday Night Live  
Reasonable Doubts  
Seinfeld  
Full House  
Sisters  
American Journal  
Siskel & Ebert  
Comedy Central  
Vicki!

FREE demo and information package. CDs are available for review. Over 1000 CDs

NAB Booth #13148/13149

## PROMUSIC

1-800-322-7879  
Fax 407-995-8434

NOW REPRESENTING

MATCH  
MUSIC LIBRARY

Reader Service No. 50

## Sean Caldwell PRODUCTIONS VOICEOVER SERVICES

### PROMOS SWEEPERS

dry voice or produced

Z100 NEW YORK  
Y100 PHILADELPHIA  
KISS-FM DALLAS

CHR COUNTRY AC AOR NT  
DIGITAL MULTI-TRACK

FREE DEMO  
(610) 640-5899

Reader Service No. 93



OVER 70 CD'S OF PRODUCTION MUSIC & SOUND EFFECTS

Dimension Music & Sound Effects, Inc.

P.O. Box 8495, Jupiter, Florida 33468-8495

800-634-0091 • 407-575-7004 • Fax: 407-575-3232

Reader Service No. 217

# Assess Station Needs Realistically

► continued from page 15

what do I do? I can't get the transmitter to come back up." Save yourself some time, prepare a manual and review it with everyone during a staff meeting.

- With regard to maintenance and logging, make sure that equipment and engineering logs are maintained at all sites where equipment is located. These logs should contain all preventive and corrective maintenance records for studio and transmitter equipment. Review

these logs on a regular basis.

- Make sure you have current tech manuals on hand for all the equipment your station owns. These manuals sometimes have a way of "walking off," which is easy to prevent. Inventory all of your manuals. Put an ID sticker on them with a serial number. If the manual is loose-leaf, put individual stickers on each section and note how many pages/inserts are in each section and catalog them accordingly.

Make it clear that your engineer is responsible for those manuals and have an agreement to this effect. Review your library periodically to make sure your manuals are current and all is there. This

is not to create suspicion, but the fact is that without a current tech manual on the piece of equipment being worked on, your engineer may be flying blind. If you lack manuals your engineer feels are important, order them.

- With regards to logging and reporting, establish a protocol for reporting and what is done when discrepancies are found. Require your engineering staff to prepare status reports and a review of the station's engineering every week. Review them with your engineers to maintain timelines and communication.

Set and maintain a regular maintenance schedule with your engineer. Develop a

checklist with your engineer and review it every week. In most cases relatively low-cost maintenance offsets major expenses due to a lack of attention.

The main thing to remember is this: no matter how good your programming is, if your on-air sound is below par, you are restricting your station's overall performance. Next time out, 10 things you can do right now to improve your relationship with your network. Until then...

□ □ □

*Karl Baehr is president of KBE "Broadcasting By Design," a radio consulting firm providing support services for satellite radio stations and produces the Actual Radio Measurement (ARM) electronic survey system. He can be reached at 505-828-0488; or fax: 505-821-4226.*

## Xers Are Target Of Radio

► continued from page 15

accessible all the same.

Such a hybrid capitalizes on top 40's mainline appeal, while discouraging the feeling of listener exclusivity that some feel modern rock fosters.

"A lot of modern rock jocks are talking down on Generation X," Broz says. "On Radio X, the jocks must be real, they must be themselves and they have to relate to the listeners and their music."

The big question, however, is whether or not an audience that already thrives on bucking the mainstream will accept a radio station that purports to deliver to an alternative crowd and yet, ironically, is precise in not straying terribly far from the center line. It's an intriguing paradox.

No doubt Radio X's motive is not to break new ground. It instead aims to capitalize on the brewing of the next major mainstream musical trend—the modern rock movement.

Rap, like any musical fad, from disco to house music, will eventually see its peak. The stronger variables of the genre will entrench themselves into top 40 and other formats in the longer term, and the search for the "next big thing" will ensue. Radio X offers a jump on it.

I've said for some time that modern rock is the ripest category from which tomorrow's CHR radio will shape its playlists. Already, New York's Z100, historically one of the nation's most popular stations, has dramatically changed its direction over the past six or so months—away from the predominant heavy street and urban core that top 40 radio has driven into the ground since the beginning of the decade.

Likewise, 99X in Atlanta, Georgia, long regarded as an innovator in the Southeast, switched from its mainstream moniker of Power 99 a couple years ago to a more progressive sound.

"It's difficult for Generation X people to find their own corner of the stage," Broz says. "This kind of radio can reach them in every market. As long as it's tailored for each market, it can work anywhere."

## SEND YOUR AUDIO ACROSS THE STREET OR AROUND THE WORLD™

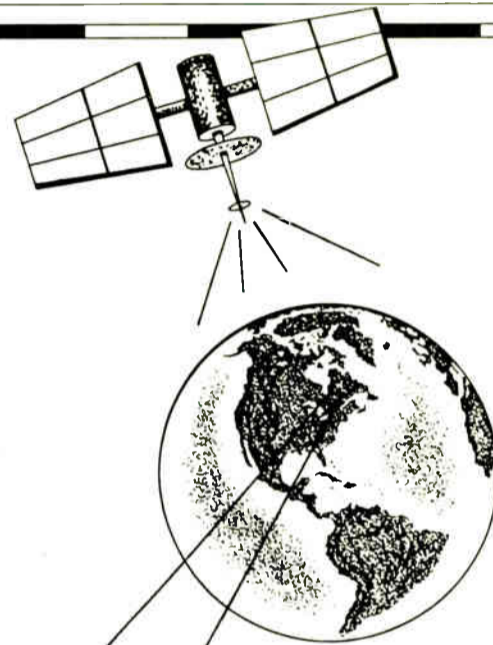

**When you think digital audio, think California Digital. We provide satellite/digital technology to make all these options available at low cost:**

- | Syndicate your top personality or format
- | Add affiliates - gain revenue sources
- | Share programming, talent and costs
- | Off-site announcer feeds
- | Create events with remotes
- | CD-quality live coverage of news, sports, and concerts

**California Digital offers expertise in:**

- | Digital Satellite Networks - C or Ku
- | Regional, National, International Nets
- | Remote Broadcasts
- | Rugged Fly-away Systems
- | Custom Ku Power Control Software
- | System Design & Engineering
- | FCC Licensing; Installation and Training
- | Equipment sales, leasing and financing
- | Switch 56 & ISDN program distribution

**TOP TALENT IS LOCALIZING NATIONAL SHOWS WITH OUR LOW COST TECHNOLOGY**  
ASK US HOW YOU CAN DO IT TOO!

**CALL: CALIFORNIA DIGITAL AUDIO**

West Coast Office (805) 523-2310 Fax (805) 523-0480  
Midwest Office (612) 631-5064 Fax (612) 631-5010

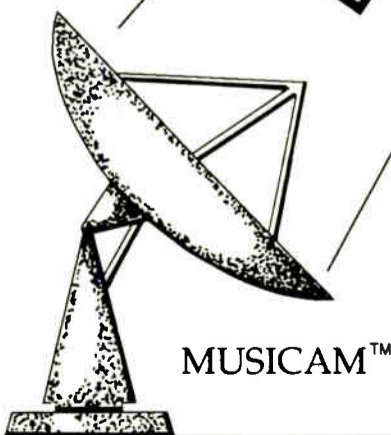

**MAKE MONEY BY CREATING A MUSIC PROGRAMMING NETWORK!**

# STATION SERVICES

News and Services for Business, Programming and Sales

## A Morning Drive Show for Overnights

**NEW YORK** "After Midnight," a live satellite country overnight show from Los Angeles hosted by Blair Garner, is available Monday through Saturday from midnight to 6 a.m., ET.

"After Midnight" includes great country music, live call-ins from the audience and interviews with the biggest names from Nashville to Hollywood. It also includes opportunities for listeners and the chance to win prizes, hear comedy and trivia, and find out the latest entertainment and sports news.

"It's like a morning drive program for overnight listeners," said Larry Daniels, general program manager of KNIX-FM in Phoenix.

For information, contact Cindy Grogan, "After Midnight" director of affiliate relations, in New Jersey at 800-261-9053; fax: 201-261-0518; or circle **Reader Service 61**.

## Music From the Past 51 Years

**ROANOKE, Va.** After three years of production effort, Globe Productions offers its EASY/AC format.

Available on tape, the music library consists of a variety of selections that will play 24 hours a day for a week without a repeat. The library uses music from the past 51 years.

For information, contact Jeff Shepherd in Virginia at 703-344-3283; or circle **Reader Service 183**.

## Barney Puts Little Kids to Sleep

**RICHARDSON, Texas** The Lyons Group and MJI Broadcasting have teamed up to syndicate "Bedtime with Barney™," a unique 10-minute radio show aimed toward preschoolers and their families.

The weekly show includes a support cast

of children and charming sound effects and music and features the well-known purple dinosaur Barney recounting an age-appropriate story that encourages children to use their imagination.

The stories presented range from standards like "The Gingerbread Man" to stories from around the world like "Roly Poly Riceball."

MJI Broadcasting is targeting adult music stations as well as children's stations to create a "Barney network."

For information, contact Beth Ryan at the Lyons Group in Texas at 214-390-6094; fax: 214-390-9915; or circle **Reader Service 140**.

## The Music Bakery Offers Much Music for Little Bread

**DALLAS** The Music Bakery serves up fresh music of the highest professional quality, and features live instruments, real musicians and award-winning compositions for productions and presentations.

Subscribers receive a new CD every other month for the one-time buy out price of \$48 each. Each disc contains a variety of music styles in full lengths (approximately four minutes), 60 seconds, 30 seconds and tags.

For information, contact Jack Waldenmaier in Texas at 800-229-0313; fax: 214-414-3160; or circle **Reader Service 199**.

## Race Cars on Radio

**JOHNSON CITY, N.Y.** Sportcom Associates now uplinks its Motor Sports Radio programs on Galaxy 4.

"Race Talk" is a twice-weekly, five-minute look at news, results and personalities of major league auto racing. "Radio Road Test" is a weekly five-minute program of driving impressions of American and foreign cars and light trucks. Both programs are anchored by Paul Kaminski.

For information, contact Sportcom Associates in Massachusetts at 607-770-9165; fax: 607-770-9165; or circle **Reader Service 206**.

## Team Sports Network

**DENVER** Jones Satellite Networks (JSN) unveiled its seventh format on March 1—The Team Sports Network, a live, 24-hour sports/talk format. The Team Sports Network is a joint venture with WTEM(AM) SportsRadio 570 in Washington.

The Team uplinks live from WTEM and focuses on talk and entertainment with high-profile personalities and guests, call-ins and up-to-the-minute information on all facets of the world of sports.

For information, contact Mike Tyler in Colorado at 800-453-5663; fax: 303-799-0966; or circle **Reader Service 63**.

## UPI Launches Global News

The launch of Global News Network provides United Press International with the ability to offer accessible, affordable and understandable news. The network uses six satellites and advanced information management technology to deliver news and other information instantly to anywhere in the world.

With the aid of the new IPTC/NAA Information Interchange Model (IIM), companies can use their existing hardware to access information on the Global News Network. UPI emphasizes the speed of its network, which transfers 20,000 words per minute.

UPI has also introduced WorldView software for Windows, a graphical user interface (GUI) that allows users to select the news they wish to read. The software allows each user within an affiliated news organization to retrieve only the news he or she needs. UPI Worldview incorporates photos, clip art, audio sound bites and eventually, video.

The UPI announcement comes on the heels of the company's restructuring. UPI's new management team is led by L. Brewster Jackson, CEO, former president and CFO of Pressnet Systems Inc., an electronic information service. Jackson's team includes Vice President of Operations Jean R. AbiNader, former president and CEO of the U.S.-Arab Chamber of Commerce, and Vice President of Worldwide Sales L. Thomas Adams. Adams joins UPI from his position as executive vice president and COO of the Corporate Consulting Group.

# STATION SERVICES

## BUY - OUT MUSIC

•Industrial •Technical •Logos  
•Dramatic •Romantic •Variety  
•Contemporary •Sports •Travel

11 Great Volumes! Low Buyout Pricing!  
Multi-Unit Discounts! CDs And Cassettes!  
Free Catalog!

**ENERGETIC MUSIC**  
P.O. Box 84583 • Seattle, WA 98124

**1-800-323-2972**

**READER SERVICE 28**

**427 SOUND EFFECTS**  
**\$89.00**

For a 5-CD set with a 30-day money-back guarantee.

*Take an extra \$10 off if you mention this ad!*

Send \$79 to Ghostwriters  
2412 Unity Ave. N., Dept. RW  
Minneapolis, MN 55422

For credit card orders call  
**(612) 522-6256**

**READER SERVICE 115**

**Walter Cronkite's**  
**Twentieth Century**  
America's Great Journalist Looks Back  
at Significant Events on This Date in History  
Delivered Seven Days a Week

**When Radio Was**  
With **ART FLEMING**

**FRED ALLEN** **DUFFY'S TAVERN** **SHEPHERD GILBERT**  
**WALTER WINCHE AND MOULT** **SHIRLEY JONES**  
**ESCAPE** **The Lone RANGER**

The Best in Old-Time Radio! 5 hour-long show per week

The man who drained Lake Michigan and filled it with chocolate



**Stan Freeberg Here**  
Satirical Commentary for the '90s five times per week

**ALL BARTER**

Contact **DAVID WEST** at

**(201) 385-6566**

More Fine Radio Programming From

DBA reserves the right of final selection of affiliates for any of its programs



## Dump the file cards!

### HOT MIX

music scheduling software  
Get better and fresher rotations  
Buy-out price only **\$495.00**  
**Programming Services Available**  
Music Logs/Programming  
Format Restructuring

Call us today!

**LA PALMA BROADCASTING**

**(714) 778-6382**

## CUSTOMIZED AIRCHECKS ARE HERE!



Broadcast Historian Ed Brouder offers customized airchecks of Top 40 legends • Over 2,700 airchecks available • Use our catalogue to build your own collection • Perfect for Oldies Programmers, Collectors, Jocks. We have them all!

Send \$10 for our catalogue, \$5 for cassette.

**MAN FROM MARS PRODUCTIONS**

159 Orange Street  
Manchester, New Hampshire 03104

**READER SERVICE 36**

## ATTENTION PROVIDERS!

Promote your services to **Radio World's** 22,000+ readers. Reach Radio Station and Recording Studio owners/managers and engineers with your message. For information on affordable advertising call **Simone** at **1-800-336-3045**.

March 9, 1994

## MANAGER'S NOTEBOOK

# Job Descriptions Can Help Management

by Sue Jones

**BURKE, Va.** Radio Stations employ a small number of people compared with other organizations generating the same amount of business and revenue. The number of staff members could be as few as one but usually does not exceed 50. In organizations this size, everyone knows the reporting structure and his or her basic job responsibilities. So why is it important to even develop position descriptions?

The answer is they are another management tool. Just as satellite delivered programming can be used to change an inefficient period of operation into one more efficient, position descriptions provide the infrastructure to manage the station's operations more efficiently and cost effectively. Taken as a whole, position descriptions are the blueprint of an organization. They define the parts of an organization and detail every part's specifications.

## Several advantages

Before you discount position descriptions as a waste of time, after all, "everyone knows what a DJ does," consider these advantages:

- Management's review and analysis of all the organization's position descriptions may uncover overlapping duties.
- Periodic reviews may also identify employee responsibilities that might be more effectively assigned to another position.
- A complete set of position descriptions will assist management in structuring or restructuring the organization, if necessary, for either growth or downsizing.
- They are the basis for determining employee classifications and compensation levels.
- They assist the organization to comply with various federal laws such as the Fair Labor Standards Act that regulates minimum wage, overtime and child labor standards; Equal Pay Act; and Title VII. Position descriptions contain essential information which help determine exempt and non-exempt classifications (determines if you are required to pay overtime), equal pay for equal work, and the existence of artificial employment barriers.
- They can be used to compare position descriptions with other organizations in the broadcast industry for establishing industry standards for salaries and job related duties.
- They help determine and set the pay scale of positions.
- They are essential for recruiting, performance appraisals, organizational structure and analysis of relative worth of jobs in relation to each other.
- Annual Management reviews ensure equity and consistency in personnel policy.
- They can help you avoid penalties, civil suits related to the federal labor laws. Willful violation of those regulations can result in heavy fines or imprisonment of the officers and directors.

## Components

With that as a backdrop for all the reasons your station should have them, the next step is to look at what a well written position description should contain. Good position descriptions define the job to be accomplished. Descriptions help individual employees understand what the job

entails and what the station expects of him or her. They encourage high employee productivity. They define the standards to measure the employee's performance against stated objectives and expectations.

A complete position description should include sections that address qualifications for the position. For example, do you want to require your chief engineer to be SBE certified? Perhaps you want the chief engineer to have the SBE certification but you may not require it for the assistant engineer who is subordinate to the chief who will be supervising the assistant's work.

They should include job knowledge requirements. Do you want to require a specific number of years' experience for any of the positions? In some stations, you may have a sales manager with subordinate senior and entry level sales representatives. Do you want your managers to have a minimum number of years' supervisory experience before you hire them?

If you include these specifications in your position descriptions, it eliminates non-qualified people from being selected for the position either from the recruiting process or from unqualified internal hopefuls when a senior position in their career

group becomes vacant.

A well written position description would also include the assigned duties and responsibilities for the position. Do you require your on-air talent to make personal appearances for special promotions? If so, how frequently is it required? Once a month? Twice a month? Will they receive additional compensation for these appearances? This information could be critical in the recruiting process and at performance evaluation time.

Do you require your traffic director to work more than eight-hour days, if necessary, to generate weekend program logs?

## More details

Position descriptions should also include information about coordination with other

continued on page 28 ▶

# YOU CAN SHARE PROGRAMMING AMONG YOUR RADIO STATIONS ... At a Lower Cost Than Ever Before!



Share programming among your station group or with other stations by sharing day parts, entire formats or by delivering your top-rated talent to other markets coast to coast. You can spread overhead costs, increase the quality of programming at the local station and build your audience by creating a satellite radio network. And now new digital satellite technology makes radio networking more affordable than ever before. Let us offer you a complete solution for your radio networking needs.  
Call us at (202) 822-2626.

## NPR SATELLITE SERVICES®

Has moved to:  
635 Massachusetts Ave., NW, Washington, DC 20001-3753  
(202) 414-2626

Circle (123) On Reader Service Card

See Us At NAB

PROMO POWER

RUNNING RADIO

March 9, 1994

# Whose Voice Represents Your Station?

by Mark Lapidus

**WASHINGTON** You're eavesdropping on a DJ, answering the request lines. Callers are making song requests; they're also asking questions and making statements about your radio station. Many of these are emotional: "I love your station"... "I want those concert tickets"... "Your new morning guy blows"... "That party you guys put on was incredible"... "Is your night DJ single?"... "The Top 100 was awesome"... "I'd like to run that race you were just talking about."

Your listeners clearly feel they have a

bond with you. Because communication is vital to any good relationship, let's examine the main methods you can use to communicate on-air, including the scheduling, writing and producing of live liners, recorded promos and station IDs/drops.

### A lot of work

Lots of hours go into the logistics of contests and activities. Unfortunately, the last element (which is also the most important) is the writing, recording and scheduling of announcements that promote these endeavors. Instead of throwing this vital task to one per-

son, assemble a programming team which could include your promotion director, program director, production director and, for big projects, the general manager.

Brainstorm on unique copy angles. Discuss how frequently announcements should air, when the pre-promote starts, when the main copy airs and how many days to run follow-up announcements. Set the number of live versus recorded spots. Finally, assign tasks and deadline dates.

You would never put a stack of commercials in the control room and tell your DJs just to rotate them evenly. Yet many stations still do this with their own promotional announcements without pondering which are the most important. Devise a system that allows you to schedule announcements easily and how

station might look: :00-recorded top of hour ID; :10-recorded station drop; :20-recorded promo; :30-live liner stop set; :35-recorded station drop out of stop set; :45-live liner into stop set and at :50-recorded station drop out of stop set.

In this scenario, you'd make sure that the live liner and recorded promo contained totally different information. Another common approach is to air recorded promos first in stop sets. This is fine as long as live liners are not read directly into them—it's too confusing.

### Live liners

These announcements are read live by your DJs. These may be written in outline form so that the announcers totally ad-lib them. However, if you have any DJs (particularly part-timers) who are not good at ad-libbing, an outline form presents problems. I prefer full copy. Those with a talent for ad-libbing will have no problem doing so with a complete script.

Effective liners are shorter than twenty

**Assemble a "promo" programming team which could include your promotion director, program director, production director and, for big projects, the general manager.**

many to air each hour. Most music scheduling computer programs allow you to do this right on the DJ's music log.

If it's more convenient, log them manually page by page on either the music or commercial log, or invent a separate hot clock. Assign a letter or number to each announcement. This designation goes on the announcement and the log. The toughest problem to tackle is how many to air each hour; this depends on your format and number of stop sets. You may even wish to vary this according to daypart.

Here's how a midday hour for an AOR

seconds without too much detail. If necessary, write several liners about the same subject, stressing a different detail each time. With music formats where DJs commonly talk over song intros such as oldies, country, CHR or AC, these can be read over the intro of songs, cutting down on the clutter that a listener may perceive.

### Recorded promos

Hopefully, you've selected one voice for your station. While there are certain promos that require one of your regular DJs, the best approach is to utilize

continued on page 27 ▶

## WHEN QUALITY COUNTS

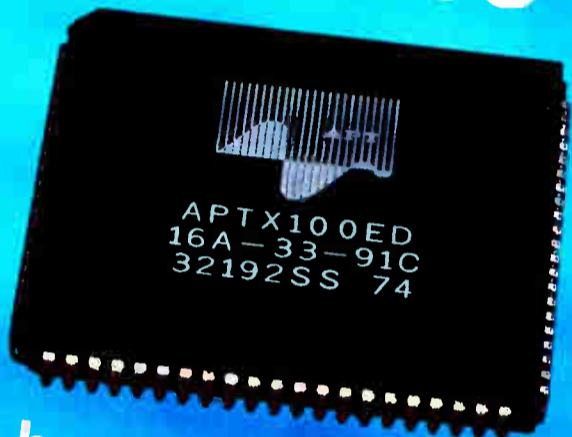

It has to be apt-X100 - the only true single chip audio compression solution - adopted by the world's leading manufacturers of broadcast equipment.

In professional broadcast, telecommunications and recording applications, the benefits of APT's predictive audio compression system are clear. Higher resistance to tandem coding errors, lower coding delay and a higher immunity to data errors mean less noise - so if you need to exploit the advantages of compression without risk - you'll be using the most appropriate solution. For details of both single chip and board level solutions - call APT.

Audio Processing Technology  
Edgewater Road  
Belfast BT3 9JQ  
Northern Ireland  
Tel 0232 371110  
Fax 0232 371137

Audio Processing Technology



Audio Processing Technology  
6255 Sunset Boulevard  
Suite 1026  
Los Angeles  
CA 90028 USA  
Tel 213 463 2963  
Fax 213 463 6568

apt-X and apt-X are registered trademarks of APT

On Reader Service Card

See Us At NAB Booth 4306

## Do You Want A Better Sounding Station?

CRL CAN HELP YOU. No matter the size of your station or the size of your budget, we have an engineered solution for you.



**Amigo FM.** Feature by feature the Amigo offers the best value in today's market. The Amigo has the ability to give any station a "big station" sound at half the cost of typical FM processors.

Call Today!

Give your station that distinctive sound you need to build bigger audiences.



Circuit Research Labs, Inc.  
(602) 438-0888  
FAX (602) 438-8227

Circle (81) On Reader Service Card  
See Us At NAB Booth 3015



# 8-Track Digital Audio Editing Station For Under \$10,000



*See the Session 8 on display at BSW NAB booth 4820*

## The Digidesign Session 8™

Digidesign's award winning Session 8 brings together virtually every leading edge recording technology available today such as: direct-to-disk digital multi-track recording, digital mixing and track bouncing, random access "cut and paste" style editing, and digital signal processing.

One of the first things you'll notice about Session 8 is how good it sounds. It supports 16-bit audio for 20 Hz to 20 kHz frequency response. It also has the simplest user interface available in a computer based editing system. If you know how to use a recorder and mixer, Session 8 will be a snap!

Session 8 includes it's own on-screen mixer, digital equalization, insert points and patch bay so it can be used as a stand alone studio or in conjunction with your existing mixer and effects. The optional R1 controller offers remote control with real analog style faders.

Now Session 8 operates on either PC or MAC platforms, and even with a computer, is still under \$10,000.

Best of all it's available from Digidesign, the manufacturer with more workstations in broadcast production than any other, and BSW, the industry leader in service and selection, with over 20 years experience in serving broadcasters.

**For More Information Or To Order Call The BSW  
Digital Specialist Nearest You**

**East of the Mississippi, Contact:**

**Laura Tyson**  
Voice: 800 • 762 • 5566  
Fax: 908 • 459 • 5540

**West of the Mississippi, Contact:**

**Rick Kemp**  
Voice: 800 • 426 • 8434  
Fax: 800 • 231 • 7055

**BSW**  
BROADCAST SUPPLY WORLDWIDE

7012 27th Street West • Tacoma, WA 98466 USA

Okay, say you meet the right girl, take her home to meet your family, get down on your knee in front of everyone and plead with her to elope and spend an eternity together fraught with romance, passion, and lifelong commitment, and suddenly she says:  
“I can’t. It’ll violate my parole.”

## You Feel:

1. *Justifiably confused.*
2. *Grateful for the honesty.*
3. *Like you bought a Unity 2000.*



Optimod-FM 8200. 100% digital. Fully upgradable. The truth. The whole truth, and nothing but.

**orban**<sup>®</sup>

**H** A Harman International Company

1525 Alvarado St., San Leandro, CA 94577 USA Phone 1•510•351•3500 Fax 1•510•351•0500.  
© 1994 AKG Acoustics, Inc. Orban and OPTIMOD are registered trademarks of AKG Acoustics, Inc. All other trademarks are property of their respective companies.

## INSIGHT ON RULES

# Computer Models Weighed for AM DAs

by Harold Hallikainen

**SAN LUIS OBISPO, Calif.** The FCC began a reexamination of its AM directional antenna performance verifications rules and policies in June 1993.

The petitioners for the rule change—consulting engineers duTreil, Lundin & Rackley; Hatfield & Dawson; Suffa & Cavell, and Silliman & Silliman—say modern computer models give a more accurate analysis of the radiation pattern by using recently developed modeling techniques (such as NEC and MININEC) than the current field strength analysis methods.

Also, because many AM arrays are now located in urban and suburban areas where measurement of array patterns is difficult and expensive, computer modeling is considerably less expensive than sending people out with field strength meters.

**Computer modeling may result in a more accurate representation of the actual radiated pattern.**

With arrays that are simple to model (series-fed uniform cross-section towers on level ground) and accurate sampling systems, it's possible to adjust the array to calculated parameters and walk away. Of course, the accuracy of the sampling system is critical.

## Two samples

Ben Dawson of Hatfield and Dawson says it might be interesting to measure each tower's feed in two different ways, with a loop on the tower and a base current sampling transformer. Another "two-sample" approach might be to sample both the base current and voltage.

I can imagine a Delta TCT sampling transformer with two outputs, one for current, the other for voltage. You would then run two sample lines back to the antenna monitor. If everything is calibrated properly, you could directly mea-

sure the base voltage, current and the phase angle between the two. From these measurements, power and driving point impedance could be easily calculated.

If the model has correctly determined the tower driving point impedances, it should be possible to build a directional array using calculated inductor and capacitor values. You would set up each component with a bridge, turn on the transmitter and see the array parameters (current and voltage magnitude and phase) come up very close to that predicted—no more field strength readings.

Is this a good thing? It certainly looks like it would save money for stations if they have a good sampling system.

Proponents say computer modeling results in a more accurate representation of the actual radiated pattern than doing field strength measurements along the ground. Our existing FS measurement techniques suffer inaccuracies due to the closeness to the ground (E and H field do not have their free space relationship), local reradiation (typically from overhead power wiring) and terrain variations.

A more accurate method of determining the actual field pattern could decrease interference as arrays are adjusted to truly radiate properly.

For more complex arrays (shunt-fed, folded unipole, nonlevel ground, self-supporting towers) that are more difficult to model, the existing FS measurement techniques may still be more accurate. The proponents are, therefore, suggesting the change for easy-to-model arrays only.

But when FS measurements are required, they suggest fewer than the current rules require. Five to 10 good points are sufficient; the rest of the points on a radial just verify what is already known, they say.

## Proposing rules

Proponents say the field strength measurement requirement should be made optional when an accurate model of the array can be generated. Those who wish to continue using the existing techniques (whether a good model can be generated or not) would be free to do so.

Those arguing against the proposal dis-

pute the accuracy of prediction techniques and question whether they will insure that interference levels do not increase. If the FCC does accept the proposal, it will have to put various limitations on the type of arrays to be modeled and require very good documentation of the sampling system.

The FCC is also looking at how other structures in the vicinity of the array should be factored into the measurements. Dawson suggests that reradiators more than one wavelength away from the array and less than 45 degrees tall have a minimal effect on the far field and could be omitted from the model.

It may be possible to be a little loose with the model because the field variations would be far less than variations caused by propagation changes, such as skywave.

Reply comments in the initial inquiry have been submitted and it remains to be seen whether the commission will take the next step and propose a rule change. It would be quite a departure from the way directional antenna systems have been analyzed for over 50 years.

□□□

*Harold Hallikainen is president of Hallikainen and Friends, a manufacturer of transmitter control and telemetry systems. He also teaches electronics at Cuesta College, San Luis Obispo, Calif. He can be reached at 805-541-0200, or on Internet at ap621@cleveland.freenet.edu.*

## Selecting the Right Voice For Your Station's Local Image

► continued from page 24

somebody who is not heard regularly on-air or in commercials. Your listeners will be conditioned to know when they hear that voice, they're about to learn something fun about your station. Ideally, this same voice is used in your station IDs/drops.

If you can't afford to hire a "big" local voice, consider contracting a national talent; you can fax them copy and have tapes overnighted back to you. Many owners and general managers are uncomfortable about the expense because they feel a DJ can do the job, but this local approach can make promos sound unimportant. As with live liners, the biggest challenge is writing.

Find the best writer on your staff and work with him or her regularly. You may wish to create a small pool of people to examine copy and voice opinions. It may take some time for your copywriter to develop a tough skin, but after a while he will appreciate the assistance.

## The right exposure

To prevent overexposure of recorded promos, rotate several different versions or update them daily. Save recorded elements for later use, cataloging them as you go. This will save

time and money, as stations have a tendency to repeat many of the same events and contests.

It seems amazing that recorded announcements shorter than ten seconds set the stage for much of your identity, but when done properly, these truly make the magic of radio. Your slogan belongs here with great music, sound bite or effect. While individual sound bites might need changing on a regular basis, most of these should air for long periods of time so that people identify them with you.

Reality check—Most of this material is elementary and that's precisely what makes it so important. Even if you're already doing most of the above, try putting yourself to this test: Record two hours of promos/liners/IDs/drops off-air, editing out all music and talk. Listen to this tape without interruption. If you're entertained and emotionally involved with what you hear, take the rest of the day off. If not, plan on working this weekend!

□□□

*Mark Lapidus has worked in radio for more than twenty years as a DJ, program director and promotion director in Ohio, West Virginia, North Carolina, Texas and most recently Washington.*



# Did you know?

**Broadcast CD Libraries: 1100 cuts \$2495.00**

**Weekly CD Top Hits U.S.A. - \$16.95/week**

**Format Services - \$295.00 per month**

It doesn't take a genius to recognize a great deal. RPM has a library of 6,000+ cuts digitally remastered for superb on-air quality. We also offer on-time weekly CD hits. Best of all, our services are priced for the 90's. Call for our catalog listing all 6,000 cuts and a sample disc. We're in our 25th year of serving broadcasters and we'd like to work for you.

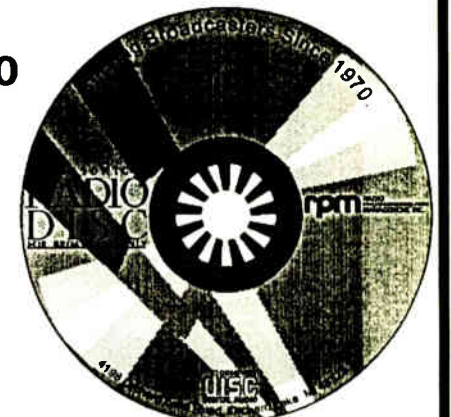

**rpm** RADIO PROGRAMMING AND MANAGEMENT, INC.

**50 States & Canada: 800-521-2537**  
**Over 1700 clients Worldwide!**

Fax: 810-681-3936

Top Hits U.S.A. and Ultrasonic-Q Radio Disc are trademarks of Radio Programming and Management, Inc., 4196 Orchard Lake Road, Orchard Lake, Michigan 48323. The Ultrasonic-Q system is Patented.

# Switch Placement Requires Planning

by James R. Murphy

**MORGANTOWN, W.Va.** Nearly all radio stations have a plethora of switches for performing normal, day-to-day functions.

Switches are mounted on panels, housed in mini-boxes stuck to the side of a cabinet or case and a few even end up hanging by their own wiring. These pushbutton farms are often in close proximity to the studio console and are as

apparent that I needed a rack panel two spaces high, with 14 switches.

On top of that, I would have to duplicate the same panel in two other studios. This meant I would need 42 panel cutouts, not to mention the wiring involved, a lot of work.

## An easier way

I am a rather lazy person with absolutely no desire to drill and file 42 holes in aluminum. I immediately set out to find an easier way.

A few scratchpad sheets later, I came up with what I call my "function execute" switch. Although there is some circuitry required, there are only two switches—a thumb-wheel and a momentary pushbutton—at each location.

The switchbox can easily be mounted on a one-inch-by-six-inch panel in a console, or in a minibox of similar dimensions. All you need then are the six conductors connected

to a central location housing the actual switching relays, and the system is ready for you to control up to 16 functions.

(By the way, this is an excellent project for the young apprentice engineer or operator, or for anyone wanting to brush

up on digital logic. I include some basic language to assist those not fully grounded in digital electronics.)

As in most designs, there are many ways of accomplishing a given task. The design chosen here is based on cost and availability of parts. For instance, a tri-state buffer could have been used just as easily, but a more common, thus more

readily available chip was used.

I always try to use parts that are available as "equivalents." My only exception here is the thumbwheel, which is available through most mail order supply houses.

## As many as you want

Figure 1 shows the basic flowchart. Although only four switch modules are shown, many more may be paralleled into the central decoder and relay driver. A big

continued on page 30 ▶

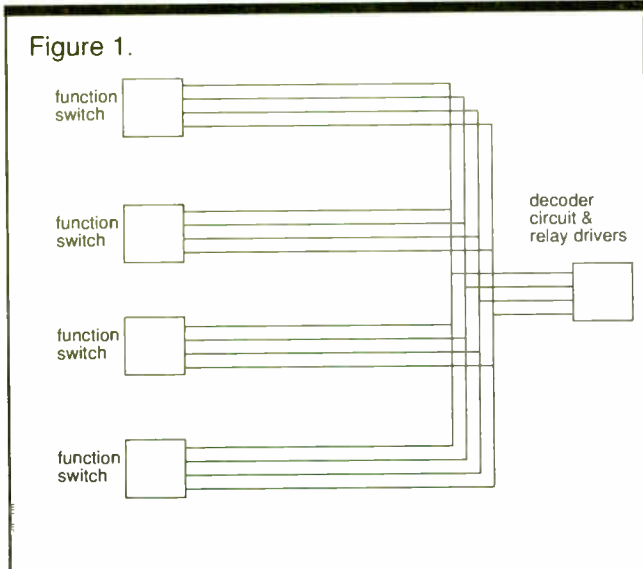

attractive as the electric box in Herman Munster's basement.

When I completed a recent studio installation, I began laying out the panel space for the various switches. After much drawing and measuring, it became

# Writing a Job Description

▶ continued from page 23

work groups in the station and management. As the general manager, do you want to be notified if the station is off the air at 2:00 a.m. or will notification later that morning during business hours be sufficient?

Another essential item includes reporting requirements. Whose responsibility is it to notify you when the station is off the air? The DJ can tell you that you are off the air but may not have a clue why. Your engineer could tell you why and give you an estimate of the time that will be required to correct the problem. Having these reporting requirements clearly defined in advance can save valuable decision making time during such a critical period.

Do you require weekly and or monthly reports from the department heads. How many positions report to the department head. These requirements should be listed on the department heads' position descriptions. These additional duties compared with the subordinate staff justify higher salaries for the department heads.

Another area that should be specified in the position description is special working conditions. Will you require your sales representatives to use their own vehicles and gas when they are making client calls? Will you compensate them for mileage and/or gas? Do you provide special vehicles for any positions such as 4-wheel drives for the engineer? Will you expect the engineer to pick up other staff members on inclement weather days if they are unable to get to the station with their own transportation?

Do you provide a promotional vehicle

for the DJs to use during personal appearances? Will you expect them to transport promotional gear and sound reinforcement equipment in their own car?

In addition to the basic sections, position descriptions should all be in the same format making management review of them simpler. The person responsible for developing them should follow the same guidelines for developing them. If you do not have position descriptions, you could have each staff member assist by writing his or her daily responsibilities. Your department heads could complete them using the same format.

The final review and approval could be the general manager and/or owner. When the task is complete, the position descriptions should provide a balanced and integrated picture of the organization. They should be reviewed annually and updated, as necessary.

If your station is expanding, it will be much easier to describe a new position. If you are downsizing, position descriptions will be valuable in assessing the work load of other positions and splitting one position's responsibilities among others.

Position descriptions play a vital role in your station from recruiting to daily work to performance evaluation. They provide internal structure that promotes fair compensation and defines expectations. They can be one of your most valuable management tools in running your station.

□ □ □

Sue Jones is a Senior Manager for Computer Data Systems Inc. in Rockville, MD. She can be reached at 703-323-0491.

# TRUE BLUE

# FOR

# THE BLUES.

More stations play their music on the world's best-selling tape carts.

**audiopak**  
BROADCAST CARTRIDGES

P.O. Box 3100 • Winchester, VA 22601  
Tel: (800) 522-CART or (703) 667-8125  
Fax: (703) 667-6379

Circle (104) On Reader Service Card

Every **FIFTEEN SECONDS**  
WE'RE HEARD  
AROUND THE WORLD!  
ID'S, SWEEPERS & PROMOS

*J.R. Nelson* PRODUCTIONS

PHONE / FAX for DEMO & RATES  
**(803) 268-6521**

Circle (218) On Reader Service Card

# NAB 1984

Apple introduces  
the Macintosh computer.

Professional CD  
players are previewed.

The first broadcast  
product using digital  
signal processing (DSP),  
the Telos 10 digital hybrid,  
is shipped by Telos Systems.

# NAB 1994

Telos Systems puts  
your station on the  
information superhighway  
with...

# *Zephyr*<sup>TM</sup>

*The Best Way to Hear from There*

Available now

**NAB Booth 5200**



TELOS SYSTEMS • 2101 SUPERIOR AVENUE • CLEVELAND, OHIO 44114 • TELEPHONE: 216-241-7225 • FAX: 216-241-4103

# Which Switch and Where?

► continued from page 28

advantage to this system is that all functions can be activated from all locations.

The switch assembly is shown in Figure 2. This unit's thumbwheel switch selects a binary address. For example, with the thumbwheel on "0," all outputs of the switch are high, and are inverted by IC1. The analog switch, IC2, is open, so the four data outputs are isolated from the lines.

Placing the thumbwheel switch on "7" would place a binary 7 to the input of IC2. If you are learning binary or BCD logic, a logic probe check at A(1) would be HI, B(2) would be HI, C(4) would be HI, and D(8) would be LO (1 + 2 + 4 + 0

= 7).

The data lines are in the high impedance state until the execute switch (SW2) is pressed momentarily. This puts a LO on the EXECUTE line as well as pin 1 of IC1. Pin 2 goes HI, enabling (closing) the analog switch.

The addresses you have selected on the thumbwheel are now placed on data lines A, B, C and D. This address will remain on as long as you keep the switch pressed.

Incidentally, diode D1 allows for the LO to pass to the EXECUTE line, but prevents other switches from enabling the analog switch on this unit.

The heart of this unit is the 74154 demultiplexer (shown in Figure 3) which takes a four-bit address and, when enabled at the G2 terminal by the (active LO) EXECUTE line, places any data that might be on G1 to the decoded address 0

0 (Pin 1). This is simply because I wanted to have a not-used channel position. You could easily use output 0 by connecting the proper relay driver assembly.

Because the selected output of IC3 goes LO, and to save some cost, I used a PNP

can mount these boards almost anywhere.

I attached my perf-board vertically beneath a channel module on our console, cut the holes for the two switches and the installation turned out looking

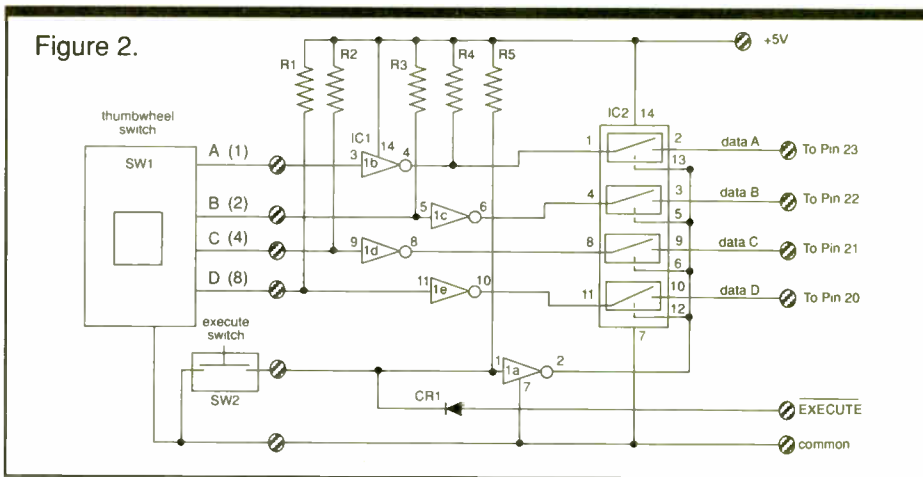

transistor, connected to the high side, as the relay driver. The LO output turns the

"factory."

For the decoder and relay driver, I used a 3.5-inch rack panel with a rather large (3 x 10 x 13) chassis mounted to it to hold the electronics, relays and a small 5 V power supply. I mounted the relays on the same board as the 75154.

The four data lines, the switch and the common, along with the 30 contacts from the 15 relays, are brought out to terminal strips on the back.

Be sure to have properly-sized wire for the data and control lines. AWG 22 or 24 should work fine, unless the runs are unusually long. If you do have long runs, adjust the 74154 logic to within TTL levels—less than 1 V for LO, above 3.5 V for HI.

With this system, you can start and stop tape recordings from any studio. Satellite channels can be changed, and the console channel starts can be activated. The list can go on and on, from automation commands, to the setting of clocks and placing studios on the air.

□ □ □

James R. Murphy is director of engineering for West Virginia Radio Corp., Morgantown, W.Va. He can be reached at 304-296-0029; or fax: 304-296-3876.

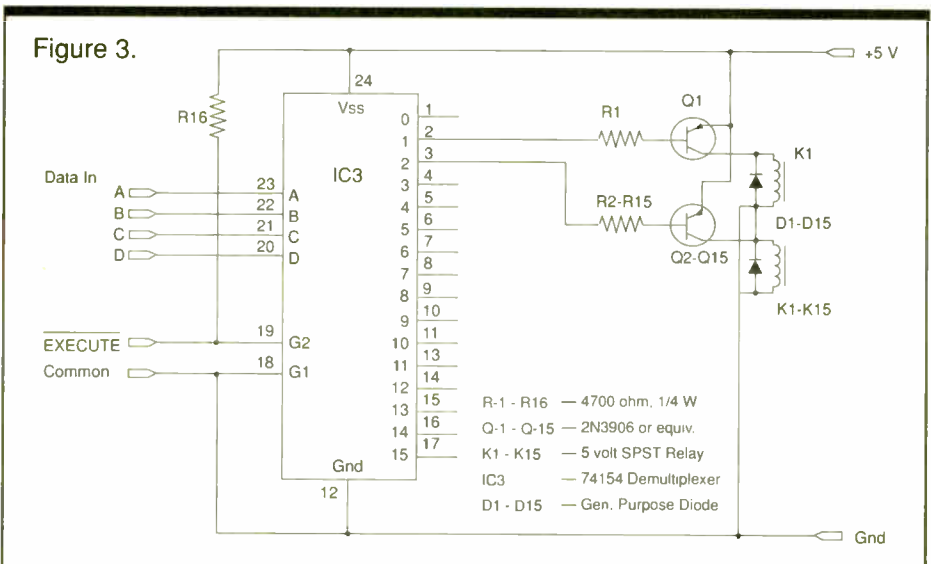

through 15. I have strapped my "data" to this pin at LO, so it always delivers a LO to the selected output address.

Remember, the highest you can count with a four-bit number is 16. If you count zero as a number, the highest number is 15.

I have not connected anything to output

transistor on, pulling the collector to the positive rail of the power supply, energizing the relay.

### Construction

I built the switch circuits using small perf-boards, about two inches by three inches, and point-to-point wiring. You

## FM ANTENNAS

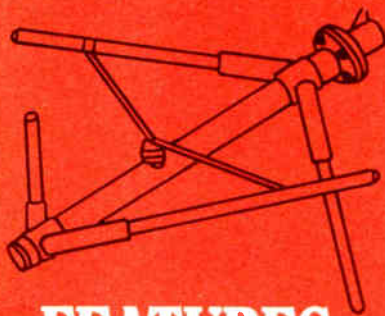

## FEATURES

Multi-Element Arrays

Input Powers from 100W to 240 kW

Circular, Vertical, or Horizontal Polarization

Custom Directional Antennas

Quality Construction Built to Last



Systems With Reliability

1-800-762-7743

Systems With Reliability

Transmission Lines & Antennas Celebrating Our 25th Year

Cambria County Industrial Park  
Ebensburg, Pa. 15931-0856  
Fax: 814-472-5552

Circle (141) On Reader Service Card  
See Us AT NAB Booth 16043

# THE SECRET'S OUT—DIGITAL FURNITURE

MODULAR FLEXIBILITY WITH A CUSTOM FIT

We Offer Six Elegant Lines of Studio Furniture

4153 BONITA STREET  
SPRING VALLEY, CA 91977  
PHONE 619/698-4658  
FAX 619/698-1268

**MURPHY**  
STUDIO FURNITURE

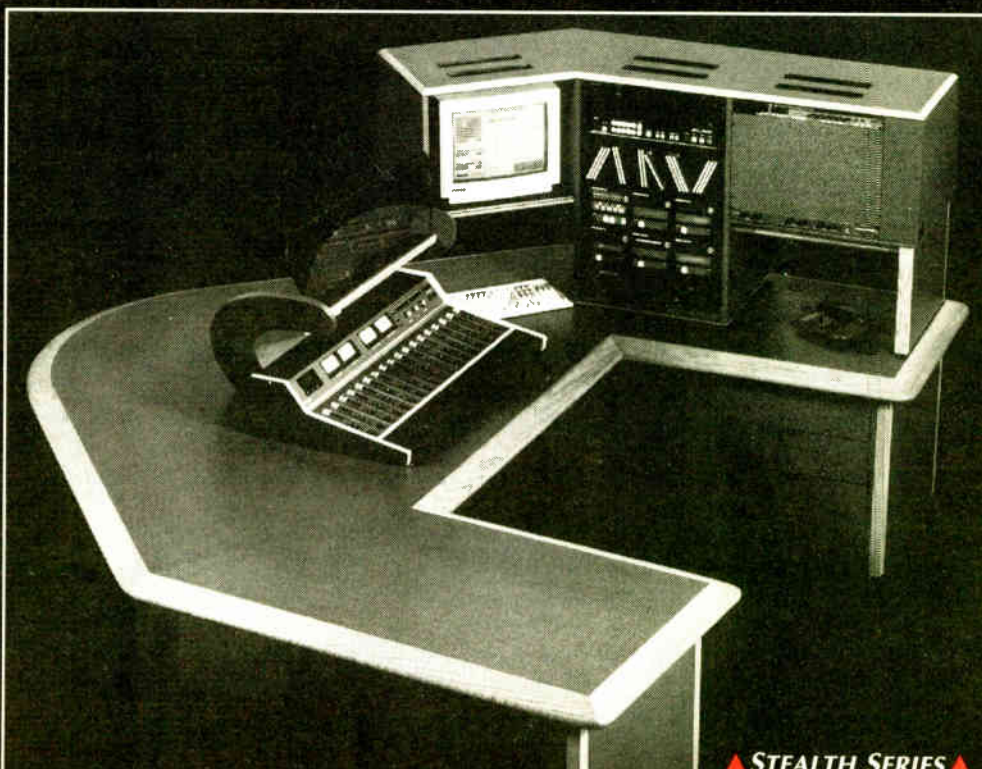

▲ STEALTH SERIES ▲

Circle (192) On Reader Service Card

# The Best Way to Hear from There

**Only Zephyr™ gives you full-fidelity stereo on a single phone line.**

No longer will your outside broadcasts be constrained by high cost and complicated equipment. Now all of your remotes can have near-CD quality sound. Using Integrated Services Digital Network (ISDN) telephone lines and the most advanced digital audio compression technology available, Telos makes setting up a remote as easy as sending a fax.

Zephyr is capable of transmitting broadcast quality audio virtually anywhere in the world for about the same price as an ordinary voice call.



To compress the program audio signal for transmission, Zephyr uses ISO/MPEG Layer III coding.

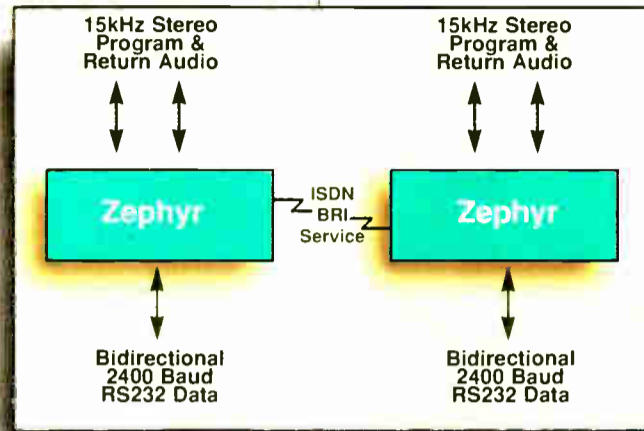

It is the ideal solution for remote broadcasts, ad hoc networks, backup to microwave and satellite links, as well as many other applications.

Several international listening tests have already demonstrated Layer III's superior performance at data rates of 64kbps or less per channel.

*only from*



2101 Superior Avenue  
Cleveland, Ohio 44114  
216.241.7225  
FAX: 216.241.4103

- Full duplex 15kHz stereo operation on one ISDN line or two Switched 56 lines using Layer III coding.
- Compatibility with older 7.5kHz codecs that use G.722.
- 2400 baud RS-232 bi-directional data for communications and control.
- Four "end-to-end" simple parallel contact closures for summary alarm and control of recorders and other devices.
- Split channel mode allows individual mono signals to be transmitted to separate sites.
- The ISDN terminal adapter is built-in and no separate boxes are needed.
- V.35/X.21 port allows Zephyr to be connected to one or two Switched 56 lines, spread spectrum wireless modems, satellite links, and other data paths.
- Designed for simple operation with full metering, analog audio limiting, and straightforward controls.
- Each unit can serve as either a transmitter or receiver.



**Telos Zephyr** DIGITAL NETWORK AUDIO TRANSMITTER

# NPR Picks MUSICAM for Satellite Network

National Public Radio (NPR) announced last month that ISO/MPEG Layer II (MUSICAM) will be the compression system transmitted over its newly redesigned Public Radio Satellite System (PRSS).

NPR's analog C-band satellite program distribution technology, which is currently installed in about 350 non-commercial radio stations in the U.S. and Puerto Rico, has been in place since the late 1970s. NPR has been distributing programming over two transponders on Galaxy IV since last year.

Transponder capacity will be markedly

increased by June 1995, when the compressed digital PRSS is scheduled to be completed. (The conversion is to be done in stages beginning in December 1994).

The new system's main components are to be the ABR700 MUSICAM satellite receiver from ComStream Corp., San Diego, which was specially designed for the NPR project (3,000 units have been ordered), and an IBM-developed automated network feed system, or what NPR calls Satellite Operation Support System (SOSS).

NPR reached the decision to use

MUSICAM after a long evaluation process. It published a call for bids for a digital encoding system in 1990 and replies were received from vendors offering MUSICAM, Dolby's AC-2 and Scientific-Atlanta's SEDAT.

"We promised our affiliates that we would be careful to choose an audio coding system that was equal to or better than our analog signals," said Burnham Morse, NPR's PRSS project director. At the same time, NPR wanted to be able to multiplex significantly more programming per transponder.

A series of subjective listening tests

were organized in NPR's behalf by consultant and author Skip Pizzi. Rather than a double-blind test structure, with each encoding system compared to the other competing systems, NPR opted to compare each system to the existing analog only.

"All the systems offered to us exceeded our expectations and exceeded the sound and the feel of the analog system," Morse said. ComStream's MUSICAM system was chosen for its price and product availability, and not because its audio quality outperformed SEDAT or AC-2, she said.

"Generally speaking, the digital systems beat the analog, but when we went through multiple iterations of the coding, we started getting some problems. It really can start to get pretty bad," said Gordon Carter, chief engineer, WFMT(FM) Chicago, who was on the test panel.

The test group tried to piece together different coding/decoding scenarios, including all the compression passes likely to be used when digital audio radio transmission begins. Scenarios of up to eight compression passes were tested, sometimes with the same compression system and sometimes mixing them.

"It was somewhat program-dependent, but (degradation after eight passes) was

## The First Digital Audio that Jocks Like!

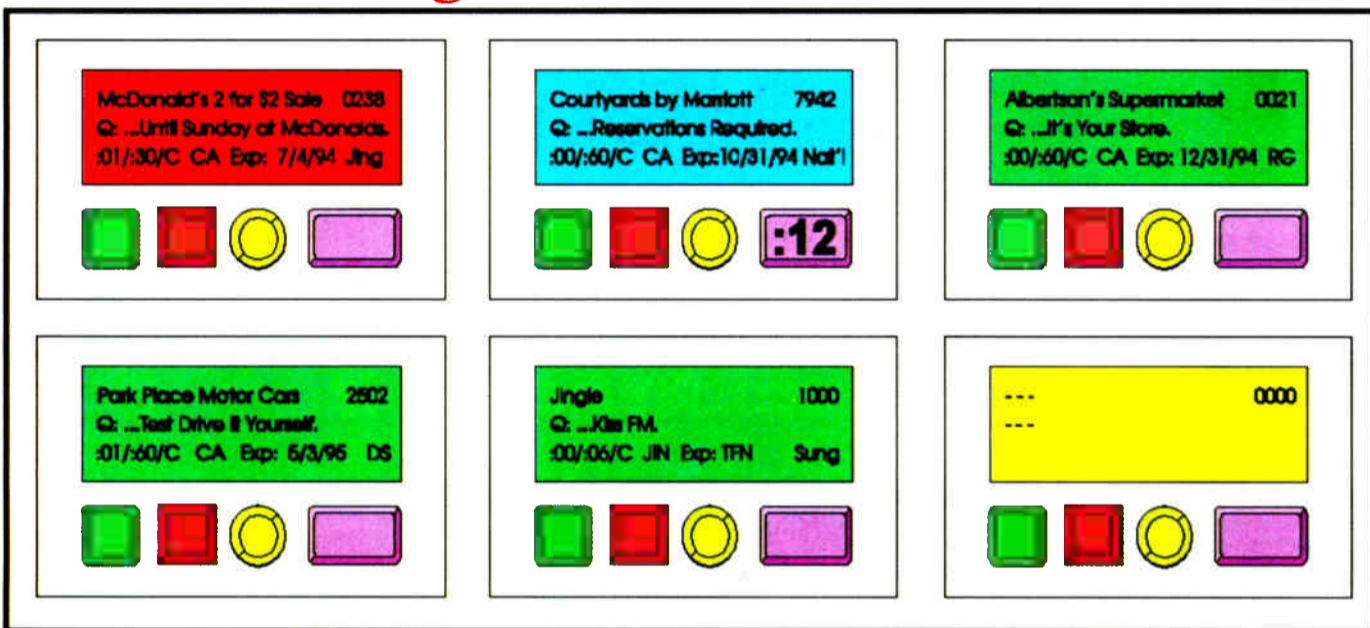

## Awesome High Quality - Amazing Low Cost

Make your move to stunning sound with CompuCarts cart machine replacement. It's an easy-to-use PC system with Scott Studios' software for digital hard disk audio. You see six "cart players" on screen in your air studios and a "cart recorder" in production. Account name, lengths, start and end dates, categories, outcues, initials and countdown timing displays clearly on screen. Or, at a touch you can see your program log, live copy, or pick from any spots, jingles or music.

Touch any of six start buttons (or our optional touch screen) and your commercials, jingles and liners are instantly on-the-air from hard disk. There's no clutter or confusion in your air studio: no computer keyboard, no mouse, no trackball, no stacks of floppy disks and no racks of cart tapes. CompuCart automatically receives each day's log from your traffic PC, and updates can be made by "10-key".

When new production is done, all commercials are instantly playable in every CompuCarts air studio. Nobody has to redub spots or retype labels for additional stations. Your people will also save time because nobody has to walk anything down the hall from production to air studios. CompuCarts cost less than analog gear, and no expensive "file servers" are needed for Multi-Studio Digital. CompuCarts can also control CD juke boxes, automate certain shifts, or run a satellite format. Call, FAX, or write for details.



(214) 620-2211 FAX: (214) 620-2707  
(800) 330-3004

**Scott Studios** Corp.  
13375 Stemmons, Suite 200  
Dallas, TX 75234-5774



quite severe to the point where the digital systems were unacceptable while the analog was moderately passable," Carter said. "The digital algorithms appeared to be actually chopping holes in the programming."

NPR has been aware and concerned about potential dueling-algorithm artifacts since the tests and advises its affiliates to use compression sparingly, Morse said. Plans for NPR's own studios (which are currently being moved and rebuilt in a new Washington location near Capitol Hill) do not include a compressed automated storage and playback system, she said.

(The IBM SOSS system will handle signal switching only and will not be involved in program playback or any other application requiring compression.) Whatever dueling algorithm problems may arise at NPR are likely to come from outside productions. NPR keeps several different playback and record devices to accommodate the several tape and disk formats program producers use, Morse said.

If compression algorithm artifacts still prove to be a problem in the future, the ComStream system has been designed to convert to uncompressed AES/EBU digital audio or to analog. "We specified that early on, that any products had to have that option," Morse said.





THE WORLD'S  
OLDEST DISC RETRIEVAL SYSTEM

VS.

THE WORLD'S  
NEWEST DISC RETRIEVAL SYSTEM

No matter how technologically advanced an industry may become, it's always a good idea to keep things simple. Well, what could be simpler than programming audio by hand? The Pioneer CAC-V3200 Compact Disc Autochanger.

As a professional audio user, you'll be impressed that it provides access to 300 CD's with uninterrupted playback thanks to dual CD players. And they can be connected together to program thousands of



CD's. You'll also appreciate that its built-in interface makes it pre-programmable for error-free playback by almost any computer. And its fade-in and fade-out capabilities, pitch control, and analog and digital outputs make it a remarkably ingenious piece of equipment.

However, if you just want to get practical about the whole thing, you can look at it this way, too. The CD Autochanger makes audio programming so absolutely efficient and error-free that your life will be made easier and your business could become more profitable. Which makes it seem rather impractical not to find out more.

Call Pioneer and ask about the CAC-V3200 Compact Disc Autochanger. You'll find it to be a simple decision that deserves a big hand.



 **PIONEER**  
The Art of Entertainment

# THE RECORDABLE CART GOES DIGITAL! INTRODUCING THE DENON MD CART.

As the company that first employed digital technology to record music, it's not surprising that Denon has become the broadcast standard for on-air CD playback with its CD Cart<sup>™</sup> Players. Now, Denon is about to repeat its ground-breaking tradition with the introduction of Denon MD Cart<sup>™</sup> Recorders and Players.

Based upon digitally recorded, removeable MD technology, Denon has created the DN-990R MD Cart Recorder and DN-980F MD Cart Player... and in the process has effectively replaced the 25 year-old NAB Cart.

Erase and re-record for commercial/spot production and playback using widely available blank MDs. Record and re-record with CD-like sound quality, durability and reliability.

Audition Denon MD Cart machines today. And remember, whenever digital broadcast equipment is made better, it will be made by Denon.



**DENON**  
The First Name in Digital Audio

# Compression Systems Are Gaining a Foothold

Predictions of broadcast technology trends are always problematical and predicting the future of a technology moving as rapidly as data compression is probably foolhardy.

But so far, it is safe to say that a number of audio compression systems have earned a long-term foothold in the U.S. marketplace, including ISO/MPEG Layers I and II (MUSICAM), Dolby's AC-3, Audio Processing Technology's apt-X and Scientific-Atlanta's SEDAT.

Two other systems that are not yet widely used but appear to have growth potential are ISO/MPEG Layer III and AT&T's PAC.

The most interesting marketplace competition will be among the systems that could potentially be marketed as universal algorithms, capable of handling most or all the compression needs in the broadcast chain, right up to the listener once digital audio radio (DAR) service begins.

Already there are those who propose

single-algorithm operation with MUSICAM. But each individual compression system has its high and low points—none can claim to be the best algorithm for all applications.

Some insight into the future of compression can possibly be gleaned from a closer look at the leading compression systems—when and why they were developed, as well as their current level of development.

## ISO/MPEG

If broadcasters gravitate toward a single encoding system as a de facto standard for all broadcast operations, the International Standards Organization/Moving Picture Expert Group (ISO/MPEG) standards have the early natural advantage.

ISO/MPEG Layers I, II and III are a combination of technologies developed by several European laboratories (see Figure 1).

Separate development projects through-

out the 1980s resulted in two leading encoding systems, MUSICAM and ASPEC. MUSICAM became the basis for Layers I and II in 1989, after going through an ISO/MPEG process that sought to create a standard that would do for the digital audio world what DOS did for personal computing.

Layer II is the most famous and widely used MPEG system today, with several companies licensed to build it into studio, RF, cable and satellite equipment as well as integrated service data networks (ISDN). It is also proposed for digital audio broadcast transmission and audio-for-video applications. Layer II must operate at 192-256 kilobits per second (kbps) to maintain audio quality.

Layer I is a simplified version of Layer II that operates at about 384 kbps. Philips adopted this bit rate for the Digital Compact Cassette (DCC) system to attain Layer I compatibility. Before MUSICAM was adopted by ISO/MPEG, there was extensive testing between the

two layers and "it seemed almost transparent after blind tests," said Sunil S. Nethisinghe, manager, multimedia audio products, Philips Semiconductors.

Some developers later said an even more versatile standard than Layer II was needed to accommodate all broadcast applications with high audio quality while operating at lower bit rates. Layer III, completed last year, attempts to meet those objectives by combining elements of MUSICAM with ASPEC. It operates at 32-320 kbps, with 192 kbps recommended for compact disc quality.

The matter of which applications Layer III handles better than Layer II is still a matter of evaluation and argument in Europe (see Part I of this report, Feb. 23). But there seems to be general agreement that transitions between Layers II and III are as transparent as between Layers I and II.

California Digital Audio Systems Inc. (CDAS) is recommending conversions from Layer II to III and back to II in its "digital audio Xpress" (daX) broadcast approach, to be discussed during the coming National Association of Broadcasters convention.

CDAS envisions the ISO/MPEG encoding schemes used interchangeably throughout the broadcast chain, eliminating transcoding between other compression systems and nearly all digital-to-audio conversions. If daX catches on, ISO/MPEG could have a worldwide competitive edge.

## SEDAT OSI

The idea of retaining audio quality through reduced transcoding is not new. Scientific-Atlanta (SA) has been developing a similar system for its Spectrum Efficient Digital Audio Technology (SEDAT) encoding in recent years.

The SEDAT OSI (open system interconnection) approach calls for a series of

continued on page 36 ►

## Squire Answers Critics

**NEW YORK** Compression system developers and manufacturers may be glad to hear that Herb Squire does not plan to test their systems anymore.

Squire, chief engineer, WQEW(AM)-WQXR-FM New York raised the issue of incompatible digital audio compression systems, or dueling algorithms, to new levels of attention last year by

future. Sometimes passes will be added without station engineers even being aware of it.

"Even your source music may have been data reduced in some way before it even gets to your CD," he said. Frank Sinatra sings with several internationally famous vocalists on his current "Duets" album, but was rarely in the same studio with them when it was recorded. Engineers shuttled compressed music between studios over telephone lines for later mixing (RW, Nov. 23, 1993).

Squire also disagreed with those who say the noise produced by his tests was indistinguishable from noise created by multiple analog/digital conversions. In earlier tests, Squire said, he put uncom-

pressed classical music through 10 D/A and A/D conversions and the rise in the noise floor was imperceptible without headphones.

"I would say that any noise produced by the conflict between the algorithms is going to exceed anything that would be created in just the conversion alone," he said.

Squire also criticized vendors who say stations have the responsibility to test compression systems before making final equipment purchases.

"You're playing 'Beat the Clock' with a deadline. You don't have the ability to sit back for a few weeks and do a qualitative analysis," he said. "The way the broadcast industry is today, you're dealing with very minimal (station engineering) staffs and you don't have the luxury to do that kind of thing."



Herb Squire, chief engineer, WQEW(AM)-WQXR-FM New York

demonstrating how they can result in obnoxious noise and drastically reducing a radio station's audio quality.

"I've proven there is a problem," he said, leaving it up to others to follow his lead by testing possible solutions.

(He was scheduled to deliver his dueling algorithm talk to the Institute of Electrical Engineers' Colloquium on Cascading Audio and Video Compression Systems in London earlier this month, but is not planning another NAB presentation this year.)

Squire is well aware of the criticisms that followed release of his tests results (see Part I of this report in the Feb. 23 issue). He has answers for all of his critics and a few things to say about some of the dueling algorithm solutions proposed so far.

He agrees with critics who say that two or three passes of digital compression is typically the limit at most stations today, but that the number will increase in the

## Wizard for Windows™

by Prophet Systems, Inc.

The Premier Digital Audio System Designed by Broadcasters

### Wizard For Windows features:

- \* WINDOWS and NOVELL Network Technology.
- \* DESIGNED BY BROADCASTERS...We know what you need!
- \* INSTANT ACCESS to all audio from multiple terminals simultaneously
- \* Windows DIGITAL REAL-TIME EDITOR that's also easy to use!
- \* HARD DRIVE AUTOMATION, put all your music on hard drive.
- \* Fully Integrated CD AUTOMATION SYSTEM.
- \* On-line COPY SYSTEM, integrate your sales and programming.
- \* BLOCK STRETCH/SQUEEZE, insures that spot blocks time out to the right length every time for seamless integration with satellite services.
- \* Advanced database design with over 40 REPORTS and simplified log entry/modification.
- \* Innovative DIGITAL REEL-REEL, automatically records network feeds including PROGRAM BREAKS!
- \* Advanced MUSIC LIBRARIAN system, generates your song play list automatically while you sleep.
- \* Supports SATELLITE, MANUAL ASSIST formats plus FULLY AUTOMATED PROGRAMMING.
- \* Full Audio, Data & Equipment Redundancy to PROTECT your valuable data.
- \* Traffic and Music System INTERFACES for most major systems.



SEE THE SYSTEM THAT EVERYONE IS TALKING ABOUT at BOOTH #5222 at the N.A.B. SPRING SHOW or Call PROPHET SYSTEMS at 1-800-658-4403 for a full information packet. In Australia or New Zealand, contact Broadcast Solutions Pty Limited at (02) 439-6662.

Windows is a Registered Trademark of Microsoft Corporation. Novell is a Registered Trademark of Novell, Inc.

Circle (20) On Reader Service Card

# Compression Algorithms

► continued from page 35

interface chips installed in satellite receivers, digital recorders, digital editors and other equipment, allowing signals to be routed in either compressed SEDAT or AES/EBU digital audio, without conversions to analog. (See Figure 2.)

The OSI approach, however, has been on the drawing board for a long time. SA announced the plan a year and a half ago (RW, Nov. 4, 1992), but has not advanced it very much since then. "We haven't had the technical people available to develop the product," said Jack Fenster, director, broadcast radio product management at SA's Melbourne, Fla., development facility.

Nevertheless, SEDAT is one of the

receiving ABC Radio, CBS Radio, AP Broadcast Services and other news network feeds.

SA got involved with equipment development for satellite radio networks in the early 1980s when it acquired AdCom, in Melbourne which developed DATS (Digital Audio Transmission System), the world's first digital audio satellite transmission system. DATS delivers FM-quality (15 kHz) mono audio and data channels for news wires and remote control commands.

Radio networks began demanding better quality by 1990. SA responded to a call for bids from ABC Radio by revising DATS with SEDAT, which delivers 20-kHz, 128-kbps audio. "It turned out that MUSICAM was too far away from

Figure 1.

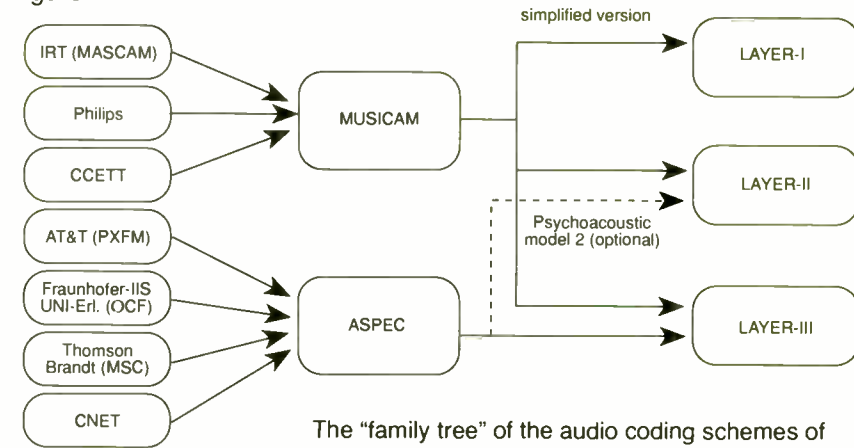

The "family tree" of the audio coding schemes of IS 11172-3. Layer 111 combines the best idea of ASPEC and MUSICAM.

ABC and CBS began SEDAT distribution in September 1991 and other news networks gradually followed their lead.

Since then, SA has been working to create a SEDAT family of compression systems to accommodate a wider range of programming.

The current system, redubbed SEDAT-I, is used mainly as a voice-only system for news and talk distribution. In January

SA began distributing receivers for the more specialized SEDAT-III, a low-bit-rate mono system, developed to support talk programming on ABC and Unistar.

ABC also hired SA to develop SEDAT-IV, a 128-kbps stereo system billed as having CD-quality for distribution over the Satellite Music Network. Production models of SEDAT-IV receivers are

expected to be ready by this summer. (SA has development of an even higher-quality stereo system, SEDAT-II, ordered by Unistar and IDB Broadcast, temporarily on hold.)

SEDAT's competitive standing with MUSICAM appears to depend on user reaction to its revised algorithms and progress in OSI development. But at least one major SEDAT customer already appears to be a probable defector.

"We are staunch supporters here of MUSICAM," said Tony Masiello, vice president, technical operations, CBS Radio. "Besides our involvement in DAR (CBS is a partner in USA Digital, which is proposing three MUSICAM-based transmission systems), we have developed a digital audio editing product for news, and our compression algorithm of choice is MUSICAM."

Masiello said manufacturers should provide multiple encoding options on their equipment so that each broadcaster can configure facilities to one preferred compression scheme. "If you want to be a SEDAT house, go ahead, but every-

continued on page 38 ►

Figure 2.

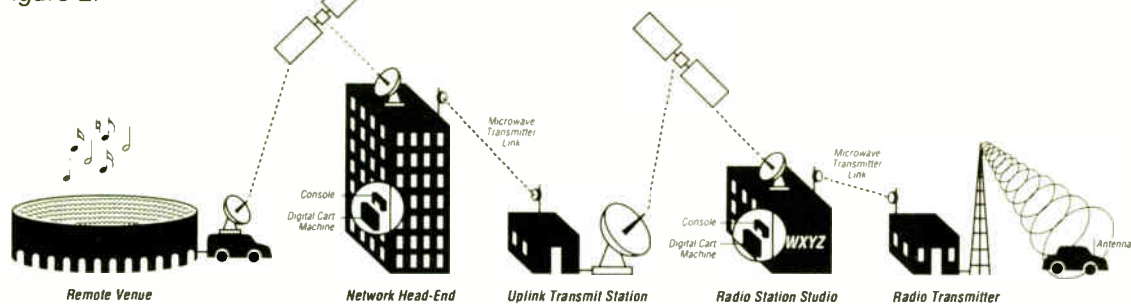

Scientific-Atlanta's vision for SEDAT OSI (open system interconnection)

major U.S. compression systems by virtue of the hundreds of affiliate stations

being ready and ABC wanted something sooner," Fenster said.

## TRADE UP TO A CCA FM BROADCAST TRANSMITTER

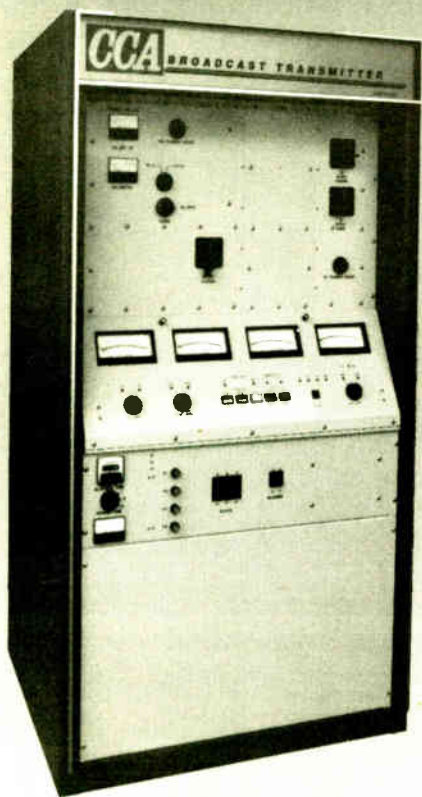

Available Models:

- 2.5 KW    12 KW
- 4 KW     20 KW
- 5 KW     25 KW
- 8 KW     27.5 KW
- 10 KW    35 KW

# CCA

**CCA TRANSMITTERS**

P.O. Box 426 • Fairburn, Georgia 30213 • USA  
1-404-964-3530 • FAX: 1-404-964-2222



You can measure...

with the best monitor and the most accurate test set.

The FMM-2/FMS-2 series monitors provide an even greater degree of precision measurement than ever before... You can measure S/N below 90 dB, You can measure crosstalk below 85 dB, You can measure separations of better than 70 dB, You can measure frequency response to better than 0.25 dB, You can measure distortions to lower than 0.01%, and much more... Our uncluttered panels and autoranging voltmeters make these measurements a dream.

**BELAR** (610) 687-5550  
**ELECTRONICS LABORATORY, INC.**  
LANCASTER AVENUE AT DORSET, DEVON, PENNSYLVANIA 19333  
Call or write for more information on Belar AM, FM, Stereo, SCA and TV monitors.

**GO WITH THE WINNERS.**

**DYNAMAX DCR1000 SERIES  
DIGITAL CARTRIDGE RECORDER**

*"With a full log, we have no time for  
make-goods. The DCR1000 has  
never let us down. We've had no  
problems, and we eliminated all  
cart related maintenance."*

*Fred Holub  
Chief Engineer  
KLAX  
#1 Station Overall  
Los Angeles, CA*



**DYNAMAX™**  
BROADCAST PRODUCTS BY FIDELIPAC

**Fidelipac Corporation**  
P.O. Box 808  
Morrestown, NJ 08057  
USA  
609-235-3900  
FAX: 609-235-7779

# Many Systems Are in Crowded Field

► continued from page 36  
thing in the station should be SEDAT," he said.

## AC-2 and apt-X

Many believe that no formal or de facto standard will form around ISO/MPEG or any other approach, regardless of technological advancement or new interface approaches.

"I don't know whether every combination the ISO now has in the marketplace will necessarily achieve what we all want to happen, which is excellent sound quality without loss," said Bob Donnelly, general manager, satellite systems, ABC

Radio. "I think it's too early to tell what will happen."

Well-established algorithms, such as Audio Coding (AC)-2 from Dolby Laboratories, San Francisco, and apt-X from Audio Processing Technology (APT), Belfast, Northern Ireland, are licensed to several manufacturers and are already present at many U.S. stations.

A number of audio storage, automation and studio-to-transmitter links (STL) suppliers have installed Dolby AC-2 codecs in their products. "It was designed for high-quality professional, applications for cases where you want to have similar complexity for encoders and

decoders," said Louis Fielder, manager of Dolby's digital audio coding group. AC-2 has 192 kbps codecs featuring 10 millisecond (ms) coding delay (used chiefly in the Dolby DSTL), and a 120 kbps system for other applications.

Dolby began digital audio compression work in the early 1980s to develop a codec for direct broadcast satellite audio transmission. AC-1 never made it on DBS, a media that is still struggling to establish itself over a decade later. But it was the compression system used by the Digital Cable Radio service.

AC-2 was finished in 1986 and is still the most widely used of Dolby's audio

compression systems in the radio industry.

In television, Dolby's audio-for-motion-picture development led to AC-3, which was recently chosen by the FCC's Advisory Committee on Advanced Television Services as the audio compression system for the proposed high definition television standard. "AC-3 was the natural vehicle (for HDTV) because of its five-channel capability that we strongly believe is an important factor in future high-quality audio for pictures," Fielder said.

"AC-3 being taken on as the (HDTV) standard has forced the issue to some degree," says Michael Smyth, head of APT's Los Angeles office. "You can't have both. It's either low coding and you can't do tandem coding, or it's a lot more bits with tandem coding."

At 384 kbps, AC-3 will have well under 100 kilobits per channel, "so the problem of tandem coding will be compounded...Any coding done before that is going to be noticeable to the consumer," Smyth said.

## Wide variety

APT's apt-X algorithm, which typically operates at 192 kbps, has been applied to a wide variety of compression applications, similar to AC-2. But Smyth emphasized the practicality of apt-X's short coding delay of under 4 ms at 32 kHz sampling before comparing audio quality.

"The whole telecommunications side is ours for the taking," Smyth said. "G.722

## in depth

## AUDIO COMPRESSION Part 2

requires that the coding delay is less than 5 ms. MUSICAM's is up to 200 ms. Dolby and MUSICAM are never going to be accepted by telecommunications people."

Smyth's brother, Stephen, developed apt-X in Ireland during the late 1980s. He was working with ISDN-type algorithms, such as the European-developed G.722, for British Telecom while completing his PhD at Queens University in Belfast. As he experimented, he gradually applied wider bandwidths to the algorithms to test their high-fidelity music performance.

The work evolved into apt-X, a G.722 derivative completed in 1989. The algorithm has not changed substantially since then. "That's one of the things our customers like. They know when they get apt-X, there is a history behind it. Four years is a long time in this field," Michael Smyth said. About 75,000 channels worth of apt-X equipment has been sold so far.

Other compression newcomers are bound to appear in the same way, Smyth said, because specific applications are often found that are not adequately addressed by the existing technology: "I don't believe you're going to get fewer algorithms; you'll get more."

Relative newcomers include two major international corporations—AT&T Bell  
continued on next page ►

## From San Francisco to Singapore From New Zealand to New York

## CCS Audio Codecs Connect the World



### CDQ1000 Mono Codec

- 10 kHz, 8.2 kHz or 7.5 kHz operation.
- CCITT G.722 and MUSICAM compression for universal compatibility.
- Bi-directional transmission.
- Ideal for news feeds, talk shows or voice-over announcements.



### CDQ2001 Stereo Codec

- 20 kHz CD quality transmission.
- New 18-bit A/D converter.
- Selectable 32/48 kHz sampling rate optimized for FM broadcasting or recording studios.
- Remote controllable via dial-up PC modem.



## Discover Crystal Clear Digital Audio Discover CCS



CCS Audio Products  
33 West Main Street  
Holmdel, NJ 07733, USA  
908-946-3800 FAX: 908-946-7167

COME HEAR US  
AT NAB '94  
BOOTH #4826



CCS Europe GmbH  
Ludwigstraße 45  
D-85399 Hallbergmoos, Germany  
49 811 5516 0 FAX: 49 811 5516 55

► continued from previous page

Labs with its Perceptual Audio Coding (PAC), developed for digital audio broadcasting, and Sony Corp.'s Adaptive Transform Acoustic Coding (ATRAC) system, the enabling technology in its MiniDisc (MD) magneto optical format.

But PAC is not yet in circulation in the radio industry or any other communications media. It is the proposed compression system for three of the proposed DAR transmission systems now being tested by the Electronics Industries Association and National Radio Systems

applications is uncertain.

Otherwise, AT&T has not yet explored the feasibility of mingling PAC with other algorithms or developing a CDAS daX-like broadcast chain for PAC, should a PAC-based system be approved.

Nikil Jayant, head of AT&T Bell Labs' signal processing branch, said internal dueling algorithm tests are planned, but that getting the systems ready for EIA/NRSC testing has been AT&T's chief concern so far. (Dueling algorithms are not part of the EIA/NRSC DAR test schedule.)

Sony's ATRAC was among the compression algorithms tested during Herb Squire's trials last year, but professional MD equipment has only begun to hit the radio market. There is little real-world experience of ATRAC interacting with

other compression systems other than the Squire tests.

MD's background is comparable to Philips' DCC. Both were originally meant to be consumer formats and eventually redesigned for broadcast applications. In fact, Sony and Philips both hold patents on elements of MD and DCC.

But the two companies parted company when it came to choosing the recording media. "To replace tape with tape did not seem to solve all the problems the consumers were complaining about," said Sony spokesman Paul Fochino.

ATRAC allows for 74 minutes of near-CD-quality on a 2.5-inch disk rather than DCC's conventional audio cassette, an obvious space- and money-saving advantage for stations installing digital audio automation systems.

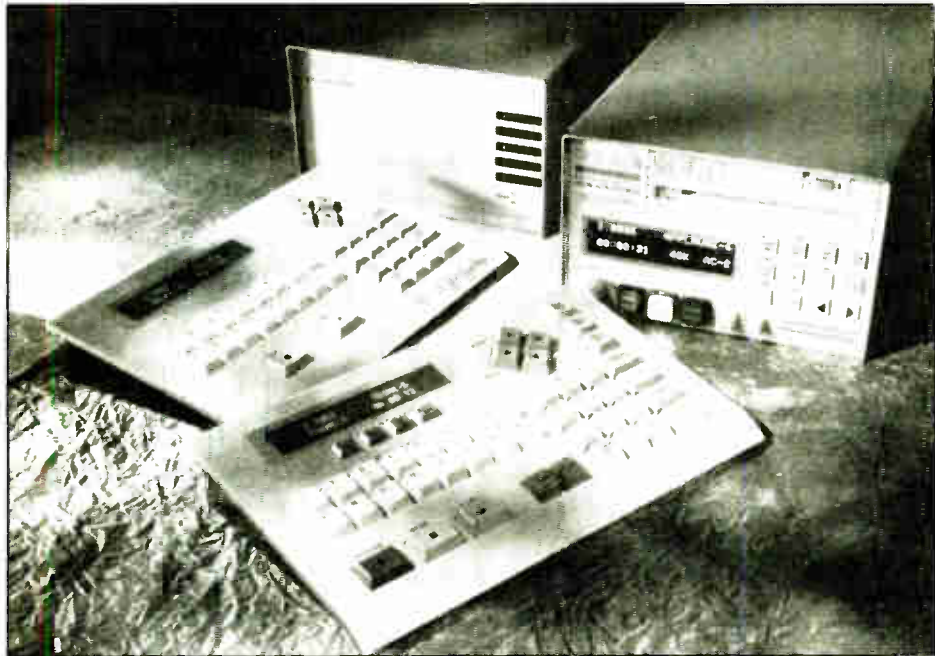

360 Systems' DigiCart/II with optional Dolby AC-2 compression

The PAC algorithm's goal is similar to MPEG/ISO Layer III—CD-quality digital stereo at a low data rate of 128 kbps. AT&T's internal subjective testing rated PAC at 4.5 on the CCIR scale of five. MUSICAM and ASPEC at 128 kbps were rated at 2.5 and just under 3.5 respectively.

Committee: the Amati in-band, on-channel system, NASA/JPL's S-band satellite system and AT&T's own in-band, adjacent-channel system (RW, July 14).

MUSICAM is the only other algorithm being considered for DAR in the U.S. If a MUSICAM system is ultimately chosen by the FCC, PAC's future in other

# MARTI

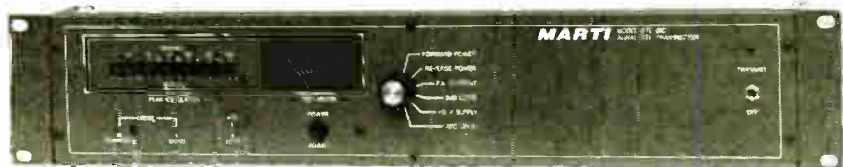

## STL-15C Composite Transmitter

**MARTI's** broad range of radios, with the latest developments and the most advanced designs are actually less expensive to build than the competition. So our higher performance cost less. Call or write for more information.

### MARTI Electronics, Inc.

PO Box 661

Cleburne TX 76033-0661

Phone: (817) 645-9163 • FAX: (817) 641-3869

See us at NAB Booth 3918/3919

## QEI meets all your FM broadcast transmitter needs.

### Selection

- 10 Watt - 1250 Watt Solid State
- 1 kW - 30 kW Single Tube
- Choice of Single or Three Phase Power Supply on 3.5 kW to 30 kW models

### Service

- 24-Hour Service Hotline: (609) 728-2020
- **Free** Initial On-Site Checkout for FMQ-Series Transmitters
- **Free** Spare Parts Kit with every FMQ-Series Transmitter
- Extended PA Tube Warranty—the **only one** in the Business

### Reliability

- Ultra-Low Maintenance
- Single Tube Design Eliminates Driver Tube
- No Sliding Contacts—Avoids Wear-Out
- Positive Pressure Cabinet to Prevent Dust Infiltration

### Experience

- Over 20 Years of Field-Proven Designs
- RF Products for Broadcast, Scientific and Military Applications
- Total In-House RF Design and Manufacturing

Learn more about the finest FM broadcast transmitters in the business. Call Jeff Detweiler today toll free—(800) 334-9154.

**QEI Corporation**  
One Airport Drive • P.O. Box 805  
Williamstown NJ 08094

Tel: (800) 334-9154

Fax: (609) 629-1751

24-Hour Service Hotline

Tel: (609) 728-2020

from Moscow to NY & from Paris to Tokyo...

# MORE STATIONS BUY ARRAKIS!!!

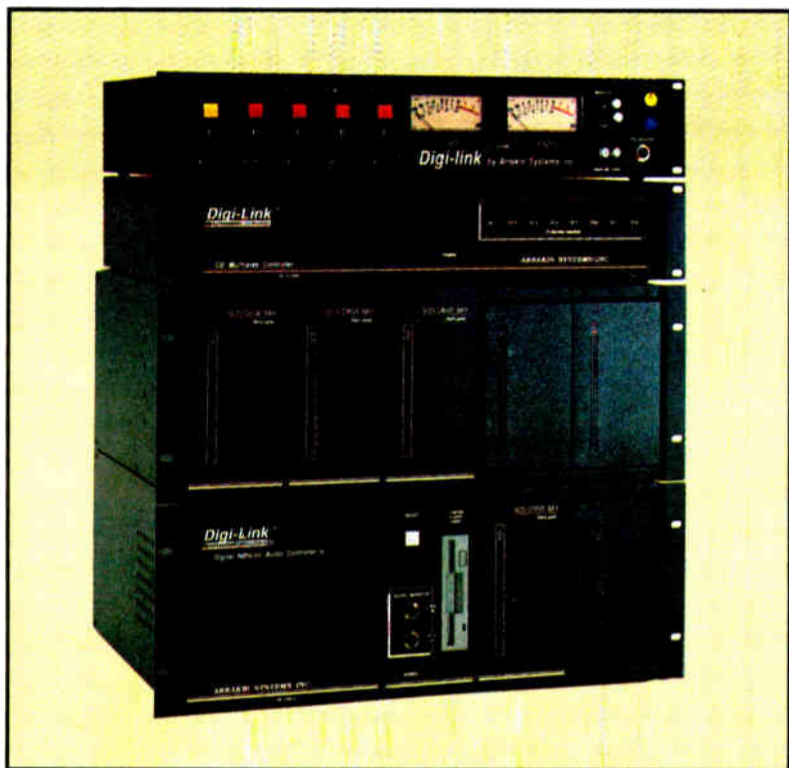

## **DIGILINK...** **THE #1 DIGITAL SYSTEM** **starting at under \$8,000**

- 10 hours of stereo digital audio storage for \$7,995 complete
- Satellite, CD, Tape and Hard Disk Automation
- Simultaneous Play, Record, & Network transfer
- Digital Editor with Waveform Editing for tight production
- Crossfade CD's, sources, and hard disk audio
- Music Scheduling system built in for basic CD automation
- Digital Networking for transfer of audio and schedules

Digilink is the #1 selling digital audio hard disk system in radio today. You can replace your cart machines for live On Air and have an automation system for walk away at the same time! Link over 15 workstations & scheduling computers on our digital network and transfer audio and schedules between your studios.



## **TRAK\*STAR-8** **THE 8 TRACK DIGITAL EDITOR** **starting at under \$5,500**

- A digital audio editor designed for Radio production
- Learn to use in minutes, much faster than tape
- Cut, splice, move, and fade up to 4 stereo tracks
- Use Scrubbing to edit with your ears
- Use visual waveform editing to edit with your eyes
- An UNDO button enables you to go back and fix mistakes
- Digital Networking to transfer audio to your On Air machine
- Add Trak\*Star-8 software to a Digilink for \$2,000

Trak\*Star-8 is the first cost effective multitrack digital audio editor designed for the radio broadcast professional. Fast and easy to use, produce your commercials on Trak\*Star and then transfer them in digital straight to the Digilink in your On Air studio. Dramatically reduce production time and save money!!!

2619 Midpoint Drive, Fort Collins, CO. 80525

Voice (303) 224-2248



## 12,000 Series Consoles

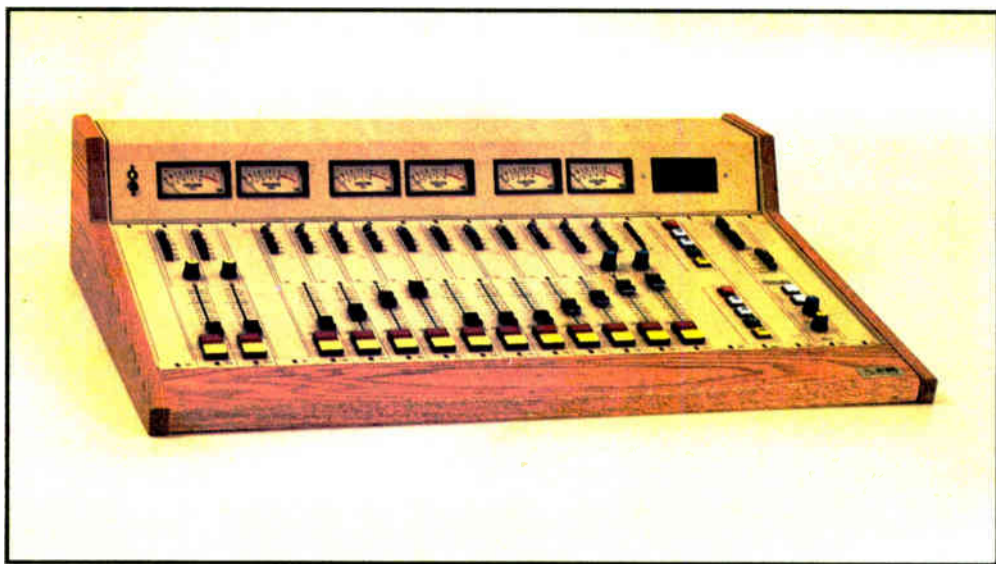

Standard Tabletop Mainframe displayed above

- Totally Modular Console-Input-output-monitor
- Three Mainframe Sizes - 8, 18, 28 input channels
- High Quality Construction-P&G Faders, etc.
- Polycarbonate overlay-for scratch resistance
- VCA Controlled Faders-for ultra reliability
- Universal Mainframe-any module in any position
- Inputs-2 per channel
- Outputs-3 stereo, Pgm, Aud, Utl
- CR Monitoring-stereo Monitor, Earphone, & Cue
- Studio Monitoring-two studios supported
- Talkback-two studios w/monitor dim
- Telephone interface-2 internal mix minus buses
- Timer-60 minute digital up timer standard
- Options-DA module, Remote selector module, Dual Machine Control Module

Deluxe thru-table mainframe displayed below

### Typical List Price

**\$4,000 - \$7,000**

From France...to Moscow...to Japan and Taiwan, and around the world...the 12,000 console is On the Air.

The 12,000 is the #1 selling Arrakis console line from the #1 console manufacturer. With three stereo output buses and two mix-minus buses for telephone interface, the 12,000 can fill any application. The 12,000 also supports a control room and two studios standard. Panning or Mode select are available on the four models of input modules, VCA control of audio delivers reliability and performance.

Quality, performance, and durability make Arrakis consoles the leader around the world.



14 1/4" x 20 3/4"

**Arrakis Systems is a world leader in radio studio technology. In Japan, Digilink is a brand name for hard disk audio for radio. For use around the world, the United States Air Force chose the 10,000 series console from among all competitors as its console of choice. When the United Nations needed 6 entire studios with consoles and furniture for a rush shipment to Cambodia early this year, they chose Arrakis 10,000 consoles and Modulux furniture. In Jamaica, Tahiti, and elsewhere, entire factory assembled and tested Arrakis studios are on the air. Around the world and of course in the United States...more stations buy Arrakis for their digital audio, console, and furniture needs!!!!**

FAX (303) 493-1076

by **ARRAKIS SYSTEMS inc.**

# Here's To A Great Broadcast Future!



Now that TTC is part of LARCAN we've got a lot to celebrate, because we've combined the resources of two great transmitter companies. On the radio side, we already have more solid state FM transmitters in the field than all other domestic companies. In TV, LARCAN is today's market leader with the popular M Series solid state VHF transmitters and our new cutting-edge solid state UHF line. LARCAN-TTC excels with the ultra-efficient, high power UHF HDR Series IOT transmitters and our complete low power UHF/VHF lines. And LARCAN-TTC is definitely HDTV-ready—*right now*. The engineering resources and corporate strength of LARCAN-TTC will insure you a great broadcasting future. Visit us at NAB '94, booths 15758 and 15708 to see products worth celebrating.

## LARCAN TTC

LARCAN: 228 Ambassador Drive, Mississauga, Ontario L5T 2J2  
TEL: 905-564-9222 FAX: 905-564-9244

LARCAN-TTC: 650 S. Taylor St. Louisville, CO 80027  
IN U.S.: 1-800-TTC HDTV TEL: 303-665-8000 FAX: 303-673-9900

High Power U.S. Sales: LDL Communications:  
14440 Cherry Lane Court, Laurel, MD 20707 TEL: 301-498-2200 FAX: 301-498-7952

OFFBEAT RADIO

# DGS Provides Rapid ISDN Solutions

by Dee McVicker

**SAN FRANCISCO** A little over a year ago, when the bomb exploded at New York's World Trade Center, news media all over the country scrambled to cover the story. As in most cities, San Francisco-area TV stations were in a fierce competition to be the quickest to reach the public with complete news of the explosion.

They also wanted to promote their coverage as quickly as possible.

A few hours to go before the evening news, and within just a few hours after the explosion, KGO-TV had distributed a radio spot to 25 area radio stations using a new wired digital service, the Digital Generation Systems (DGS) Network.

It took KGO-TV less than an hour to produce its radio ad at its own studios, and minutes to send it by telephone line via DGS to the radio stations.

**Good timing**

The DGS Network receivers had been installed at the radio stations just weeks before to handle advertising activity during the Nielsen February sweeps, the peak season for TV station advertising on radio.

"(KGO-TV) had been advertising quite heavily on the local radio stations at the time of the World Center bombing, so when they got the news over the wire, they were able to put together a spot in their studio in about an hour and we broadcast it for them out to all the radio stations," said DGS President Henry Donaldson.

As part of the test market for the DGS Network, Bay area stations were equipped with personal computers for electronically receiving advertising spots from television stations, commercial producers and other advertising services. The cost to radio stations, said Donaldson, included only the incoming telephone line. Computers and all other equipment was provided free of charge by DGS.

"I really do think it is a great idea," said Mark Van Gelder, production director, KSFO(AM)-KYA(FM) San Francisco. "Especially during sweeps weeks, when we run a lot of television commercials and a lot of those are time sensitive."

"I think it's going to replace a lot of services, especially bicycling tapes," said Dave Bramnick, vice president and general manager, KFRC(AM)-KFRC(FM).

After testing the system in the San Francisco market, DGS officially launched its service nationwide in October 1993. During its New York City debut, radio pitchman Tom Bodett, whose Motel 6 radio spots won the 1991 Radio Advertising Bureau's Mercury Gold Award, demonstrated the DGS by sending an audio message from his DGS-equipped production studio in Homer, Alaska, to the DGS receiving computer at the Rainbow Room at Radio City Music Hall.

"Now that it's possible to send spots within hours, DGS has practically moved production studios into radio stations," Bodett said.

Over 500 radio stations now use DGS to bicycle ads electronically, including major-market stations in Baltimore, Philadelphia, New York and Washington.

Most began using the system to narrow the time gap between finished production and on-air broadcast of radio spots, and to improve the radio ad quality.

Advertising agencies and their production houses also benefit from the digital delivery service. Over 60 signed up with DGS in its first two months of national operation.

Like wired services emerging in the digital age, the DGS Network travels along real-time networks, such as IDB and ED-NET, and public digital connect services, such as Switched 56 and ISDN. Radio spots typically originate at advertising

studios and are wired over high-speed lines to DGS's central exchange in San Francisco, and then dispatched to designated radio stations.

**Transmit times**

The time it takes to transmit spots varies from three minutes to 20 minutes or more, depending on the type of telecommunications link used, Donaldson said. All spots sent through the system are converted to 16-bit digital audio at a sampling rate of 48 kHz for CD stereo quality.

Using high-speed byways, DGS is able

to deliver radio spots faster and in better condition than the more traditional methods used by radio stations and ad agencies, such as dubbing and shipping audio tapes.

"Radio's greatest benefit is its immediacy and its ability to reach and change copy," said Bramnick, who credited DGS with helping improve radio's immediacy and its competitive edge against competing media.

"At the moment, the stations need only put in a regular telephone line," Donaldson said. Spot delivery costs are paid by advertising agencies, and run from \$10 a spot to \$35 a spot.

□□□

*Dee McVicker is a free-lance writer specializing in the broadcast industry. She can be reached at 602-545-7363.*

## When you spell it out in black & white...

### LPB®

1. **Since 1960, LPB has manufactured the best low power broadcast transmitters in the world.**
2. **LPB Signature Series Consoles More than 3,000 sold worldwide making it the #1 console series in the world.**
3. **New LPB 7000 Series Consoles Already operating in Asia, Europe, North and South America.**
4. **Quite simply, we don't put the LPB name on anything that isn't the highest quality and reliability you can get for your money.**

### The Competition

1. **Hasn't.**
2. **Can't compete.**
3. **Can't match LPB in quality, features, and value.**
4. **No comparison.**

**...there is no competition.**

LPB introduces

# THE NEXT GENERATION DIGITAL AUDIO SYSTEM.

NAB Booth # 1924

LPB®

28 Bacton Hill Road • Frazer, PA 19355 USA • Phone 610-644-1123 • Fax 610-644-8651

# Tracing the Details of Transistor Upkeep

This revised course offers an introduction to the theory and practical application of active electronic devices. The course will give examples of how the devices work as well as ideas on how to use them.

Continuing Education Units will be offered to all who register with Northern Virginia Community College. You will be required to read all of the articles and participate in an exam that will be mailed to you at the completion of the course. You can register for the class any time while the series is running in RW.

To register, contact the Community Education Office, Annandale Campus, 8333 Little River Turnpike, Annandale, Va. 22003. The fee for the course is \$30.

Please make every effort to secure all of the articles yourself. Northern Virginia Community College and RW are not in a position to supply readers with back issues.

by Ed Montgomery

## Part V

**ANNANDALE, Va.** Depending on their construction, transistors can exhibit several characteristics. Some are designed to be a switch, where current flows at its maximum or not at all, while others operate in the linear range with current constantly flowing in varying intensities, as in analog amplifiers.

Figure 1 illustrates the bipolar transistor's family of characteristic curves. A small change in base-emitter current results in a very large change in current

In this illustration, collector current ( $I_C$ ) is displayed on the vertical axis and collector voltage ( $V_C$ ) on the horizontal axis. The different curves illustrate various conditions of collector current at different collector voltages.

For example, if the base current  $I_B$  is increased from 60 microamps at point A to 180 microamps, at point B, there will be a corresponding increase in collector current from 3.25 milliamps to 7.75 milliamps. The 120 microamps change in  $I_B$  results in a 4.5 milliamp change in  $I_C$ .

The ratio of change of  $I_B$  to  $I_C$  is known as "Beta," the figure that shows the amplifying capability of the transistor. In this case,

Beta is 37.5.

Circuit designers observe these characteristic curves to gauge how much linear distortion will be introduced when a specific level of signal is amplified.

Figure 2 illustrates many of the characteristics a manufacturer supplies in the device. This information is important when the time comes to replace a failed transistor.

More often than not, the replacement transistor will not have the same identification number as the original. A cross reference guide lists the

number of the replacement device as well as these characteristics.

$P_T$  is the maximum amount of power

Figure 2.

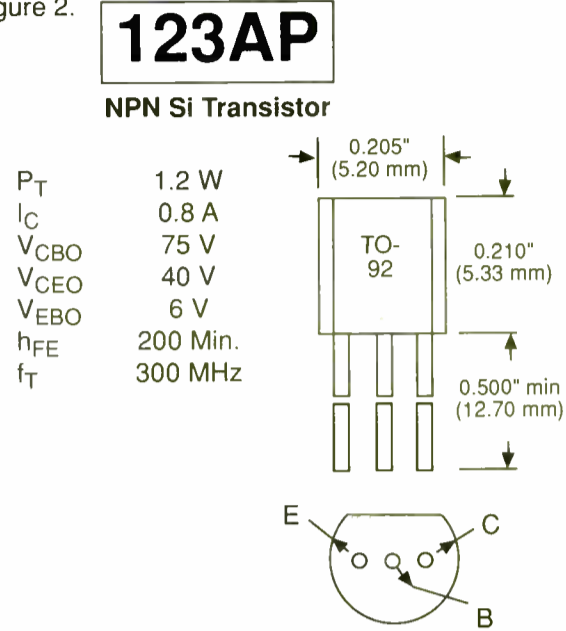
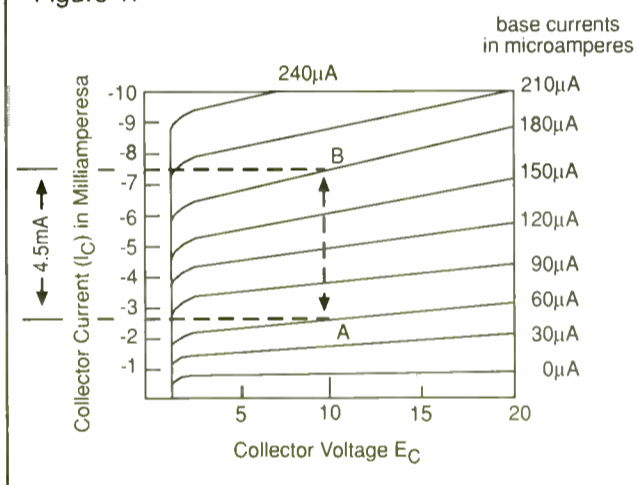

Figure 1.



flowing from the emitter to the collector.

same identification number as the original. A cross reference guide lists the

the transistor can dissipate without being de-stroyed.  $I_C$  is the maximum collector current that can be handled.  $V_{CBO}$ ,  $V_{CEO}$  and  $V_{EBO}$  are the voltages present between the collector and base; collector and emitter, and emitter and base.

$V_{CEO}$ , for example, is the voltage that will drive the transistor into maximum collector current saturation. Increasing the voltage beyond this point will have no effect on the collector current. These are usually maximum ratings and are helpful when the exact replacement device is no longer available.

$h_{FE}$  is the "Beta" rating for the device and  $f_T$  indicates the gain bandwidth of the transistor. Even though bipolar transistors are current controlled, voltage measurements across the junctions are published because it is usually impossible to measure such small currents when the device is in a circuit.

Voltage measurements are easier to come by, but avoid shorting the leads of the transistor together when measuring. Transistors operate at very low currents and voltages. Shorting the leads together could destroy the transistor junction.

Transistor checkers are used to check the viability of the device and measure diodes and field-effect transistors (to be discussed in the next installment). Checkers are designed to connect to a device that is either in or out of the circuit. They measure forward and reverse or leakage currents, a characteristic that can increase as the device ages, ultimately causing it to fail.

You can waste a great deal of time by trying to make a bad or marginal transistor function, even if the checker indicates it is good. When time for troubleshooting is considered in with the cost of repair, you often will find it cheaper to simply replace the transistor.

□ □ □

Ed Montgomery is a communications teacher at Thomas Jefferson High School for Science and Technology. He has taught broadcast engineering at Northern Virginia Community College and worked as a broadcast engineer for several radio stations. He can be reached at 703-750-5090.



## LMA/DUOPOLY CONTOUR MAPS

The DATAWORLD LMA/DUOPOLY Market Survey Contour maps present a precise electronic verification of overlapping and intersecting contours.

AM 5 mV/m and FM 3.16 mV/m City Grade contours are shown in full color, including transmitter site indicator. The map is supported with a printout showing all of the stations which appear on the map.

Daily updating of DATAWORLD'S AM and FM databases protects against errors and omissions.

### OTHER MAP OPTIONS

- SHADOWING (TERRAIN SHIELDING)
- CONTOUR COVERAGE
- POPULATION DENSITY
- ZIP CODE BOUNDARIES
- RECEIVED SIGNAL LEVEL
- SPECIAL REQUIREMENTS

## 1990 CENSUS

### WHO ARE YOUR LISTENERS?

### 1990 BUREAU OF CENSUS POPULATION COUNTING

- Comprehensive Ethnic and Demographic Data
- Ethnic/Demographic Data Available for Each Zip Code Within Coverage Area
- Age Analysis Reflected in Ethnic Breakout
- Resolution Increased to Block Level
- Percent of County Coverage Shown

### ETHNIC PIE-CHART DISPLAY

- Projects Ethnic Population in Multi-Color Pie Chart Form

dataworld®

800-368-5754 FAX: 301-656-5341

SIERRA AUTOMATED SYSTEMS

## From SAS, The Complete Range of Broadcast Audio Routing & Mixing Systems.

SAS 32000 Stereo Audio Routing & Mixing System—Perfect for mix-minus conferencing, mixer emulation, teleconferencing hubs and communication systems. Also ideal for plant and transmitter routing, satellite and remote distribution. Standard summing for mix-minus feeds, IFB, studio intercommunications, voice-over work, and more.

System size starts at 32 x 16 mono or stereo matrix modular configuration and expands up to 128 x 128. Serial bus RS-232 for terminal, local panel and modem control. Modular remote panels for console fit as well as standard rack mount panels. Custom and turnkey systems available.

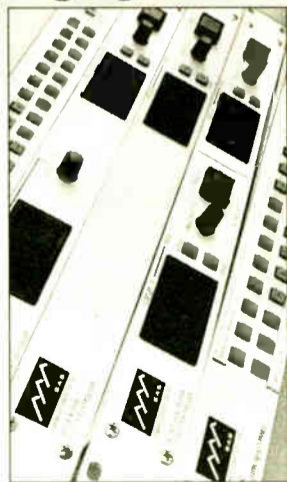

Sierra Automated Systems & Engineering Corp.

2112 North Glenoaks Blvd. Burbank, CA 91504  
Voice 818.840.6749 Fax 818.840.6751

Distributed by RAM Broadcast Systems, Inc.  
P.O. Box 3100, Barrington, IL 60011 Voice 800.779.7575  
Fax 708.382.8818 In Canada 800.433.2458

“The thing is just impossible to screw up! The DM-80’s non-destructive editing is the only way to go, and revisions are extremely easy and very quick!”

—David Esch, Director of  
Commercial Production  
WPNT Chicago

“We looked at DAW’s for a year—no other product could even come close to the DM-80’s price/performance ratio. And it doesn’t break!”

—Bill Robinson,  
Production Director  
WQCD N.Y., NY

“I love this machine! It’s reliable, and user friendly. I can edit in 1/3 the time, and I wasn’t familiar with disk recorders—the DM-80 is easy to learn and use.”

—Michael Cook,  
Program Director  
KSJJ/KPRB Redmond, OR

# Broadcast professionals speak out about the DM-80 Digital Audio Workstation!

“I’ve been editing on tape half my life, and was hesitant to give up “rocking the reels”—but I found this machine is incredibly easy to edit with. And its expandable storage put it way ahead of the competitors we looked at.

—George Zahn,  
Operations Director  
WVXU Cincinnati

“We originally chose the DM-80 because of its user friendliness. Then we discovered the real magic of this device: a promo announcement that normally would take 4 hours can be done in 30 minutes.

—Tom Collins, Director  
International College of  
Broadcasting & Recording,  
Dayton

“The DM-80 does more than DAWs costing twice as much. It’s very rugged—you can set it up and forget about it. And it’s easy to use.”

—Tony Diggs, Chief Engineer  
WKHK Richmond, VA

“All our engineers were amazed at how easy it was to do things on the DM-80...We’d gotten demos from most of the other DAW manufacturers, but once we got a demo on the DM-80, we were sold—it does more, and does it a lot faster.”

—Lynn Debin, Director of Engineering  
Key Market Communications  
Augusta, GA

“I used to be a tape guy—I don’t touch it anymore unless I have to. I like being able to bounce from track to track without noise build up, and the DM-80’s flexibility and sound quality are excellent!”

—Dave Clark, Production Manager  
KFRG Colton, CA

“It’s like a digital studio in your lap! The DM-80 is a very affordable, portable, high quality digital editing system.”

—Howard Silberberg, Sound Engineer  
United Nations Broadcast  
Network, N.Y., NY

“We often record commercials and play them on the air without ever going to tape...We own a DM-80 competitor that just collects dust.”

—Bob Mayben, Chief Engineer  
WRVR/WOGY Memphis

**We couldn't say it any better.**

Call (213) 685-5141, Ext. 337, or FAX (213) 722-0911 for more information about the DM-80 Digital Audio Workstation for the magic of hard disk recording and random access editing at your fingertips.



# Alternative RF Networks for Radio

by Thomas Osenkowsky

**BROOKFIELD, Conn.** An engineer occasionally encounters a strange-looking RF network that looks like a Tee network with extra components.

Figure 1 shows just such a lagging -60 degree Tee network. The shunt leg coil, L3, is used to fine-tune C3 by cancelling some of its capacitive reactance. C3 is usually chosen to have a little more Xc than is required by the network, hence the need for L3.

A vacuum capacitor may be recommended for higher power applications, but they tend to be expensive.

created. You can resonate a nearby station's frequency so that its RF does not enter your transmitter's PA stage and create intermodulation products or affect the accuracy of your modulation monitor.

Notice that I used two components for the input leg of the network. By design, you need +j9.4 ohms, which equals 1.5μH at 1000 kHz. Any variation in the phase shift or load resistance might lower the required inductance to the point where it becomes impossible to adjust the network.

A .005 capacitor to get a little Xc into the picture allows for a better range of

fixed capacitor) because only one unique combination of L and C will do the job.

These equations are algebraic variations

tion voltages. In some cases, however, a parallel component can be very helpful.

In Figure 3 a modified Tee network is used in a three-tower DA. Note the very high drive point impedance. A 50 pF capacitor placed across the base insulator changes the drive point impedance to

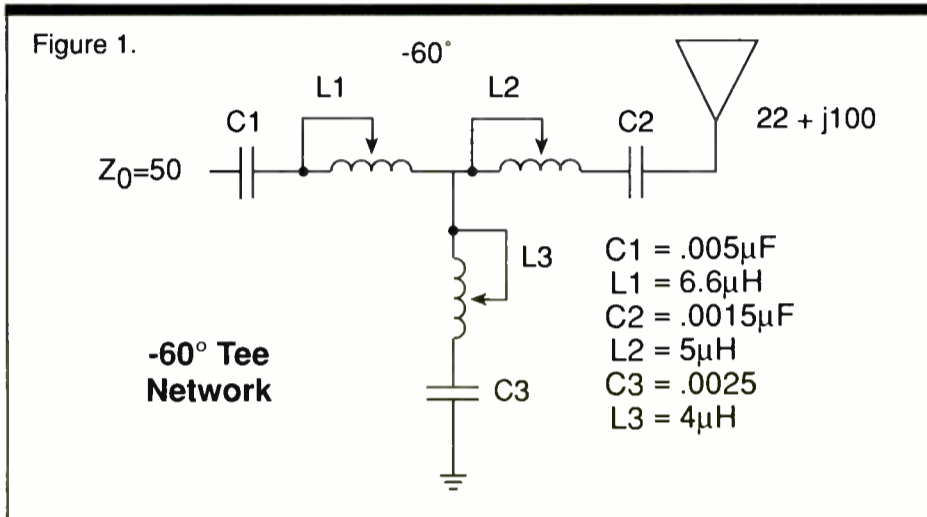

Equation 1 can be used to calculate the series resonant frequency of the L3-C3 combination. The -60 degree Tee network requires -j38.3 ohms in the shunt branch. Using a .0025μF capacitor for C3 and a 4μH coil, the resonant frequency (short circuit) is 1584 kHz. If we used a .0015μF capacitor and a 10.8μH coil, resonance is 1251 kHz.

Equation 2 can be used to calculate a combination of C3 and L3 that will resonate a lagging Tee shunt leg above carrier or a leading Tee shunt leg below carrier.

This can be advantageous. If the lagging Tee is resonated at 2 times the carrier, additional second harmonic attenuation is

input-arm adjustment without compromising bandwidth.

Recall the rule of SARL PARC (Series Above Resonance Inductive, Parallel Above Resonance Capacitive). A combination of L1 and C1 produces the required inductive reactance for the input arm. It cancels equal but opposite reactances at the sideband frequencies, provided that the upper sideband is capacitive.

Figure 2 shows such a network for a given impedance sweep. Equation 3 calculates the unique values of L1 and C1. For the shunt branch in Figure 1 and the input branch in Figure 2, you must use a vacuum variable capacitor (or carefully chosen

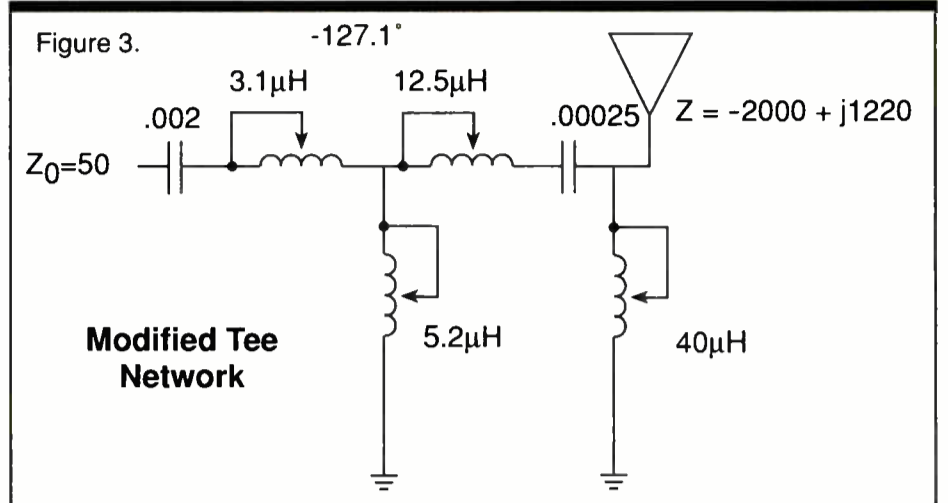

of the basic reactance formulas. Transmitter output networks often use these principles in their design.

Parallel combinations are not demon-

-2045 -j1204, assuming no mutual coupling in the system. A standard Tee network would be of little value here.

(Thanks to Jerry Westberg of Westberg Consulting for suggesting this scheme.)

Shunting the tower with a 40μH coil converts -2016 + j1220 to -37.2 + j318, which is easily matched to 50 ohms by a Tee network. The phase shift caused by the 40μH coil is -52.13 degrees.

The direction of power flow is the sign that the actual phase shifts are reversed because we are dealing with a negative tower and phase shift.

With a little imagination, some simple manipulation of network arms can produce astounding results.

**Equation 1**

$$F_r = \frac{1}{2\pi \sqrt{CL}}$$

**Equation 2**

$$C = \frac{F_0}{2\pi X_3 F_r^2} - \frac{1}{2\pi X_3 F_0}$$

$$L = \frac{1}{4\pi^2 F_r^2 C}$$

**Equation 3**

$$L = \frac{F_u \cdot |X_u|}{2\pi F_u - F_0}$$

$$C = \frac{1}{4\pi^2 F_0^2 L}$$

X<sub>3</sub> = Absolute shunt arm reactance required by Tee network (ohms)  
 F<sub>0</sub> = Carrier frequency (MHz)  
 F<sub>r</sub> = Desired reject frequency (MHz)  
 F<sub>u</sub> = Upper sideband frequency (MHz)  
 |X<sub>u</sub>| = Absolute value of upper sideband reactance (ohms)  
 π = 3.141592653589793  
 C = capacitance in μF  
 L = inductance in μH

strated here because they tend to produce high circulating currents and junc-

**If You Think We Only Supply Cable Harnesses ...**

**Think Again.**

You should see the quality and pricing on Clark Wire & Cable bulk cable and connectors.

**CLARK WIRE & CABLE**

1-800-CABLE-IT!  
 151 S. Pfingsten Road #B  
 Deerfield, IL 60015

Clark Wire & Cable has industry standard audio and video cables available in as many as ten jacket colors. Our customized A/V cables are designed with your needs (and pocketbook!) in mind.

**If You Think We Only Supply Bulk A/V Cables ...**

**Think Again.**

Clark Wire & Cable provides custom high quality cables, cut to length and terminated to your specifications.

- Patch Cords
- ADAT Harnesses
- DA-88 Harnesses
- DT-12 Audio Snakes/Harnesses
- RGB Cables
- Remote Camera Cables
- Digital A/V Assemblies
- Complete Facilities
- And More!

**CLARK WIRE & CABLE**

1-800-CABLE-IT!  
 151 S. Pfingsten Road #B  
 Deerfield, IL 60015

**Figure 2.**

Input Arm

Tee Network Load Impedance

Freq	Z
990	28 - j12
1000	26 - j9
1010	24 - j6

After -95° Tee Network

Freq	Z
990	48.9 + j7
1000	50 + j0
1010	48.2 - j8

Load VSWR 1.15/1.17

With Modified Input Arm

Freq	Z
990	48.9 - j1
1000	50 + j0
1010	48.2 - j0

Load VSWR 1.03/1.04

Thomas Gary Osenkowsky is an SBE certified senior broadcast engineer and NARTE first-class certified engineer. He can be reached at 5 Beachwood Grove, Brookfield, Conn. 06804.



# Systems with Style

When KABC/KLOS decided to rebuild from the ground up, they called Pacific Recorders & Engineering to provide its expertise in studio systems planning and execution. After all, when you're dedicated to winning, you don't gamble with success. PR&E has a proven track record of building the world's leading broadcast facilities for over twenty years. This record translates into the uncommon depth and breadth of experience which we bring to each new project. From news to rock, talk, or full-service, we're comfortable and conversant with all formats.

When you see the attention to detail, the design elegance, and the fanatical commitment to quality, you quickly realize why PR&E consoles and studio systems are found in nearly every leading broadcast facility in the nation.

But what may really surprise you is how much money you can save by working with us. That's right, save money. You see, we design and build so many world-class studio systems, we avoid the "surprises" by having the details down to a science. Why don't you give us the opportunity to work with you on your next studio project? We think you'll be pleasantly surprised at how easy it is to realize the operational efficiency and benefits of a genuine PR&E system.

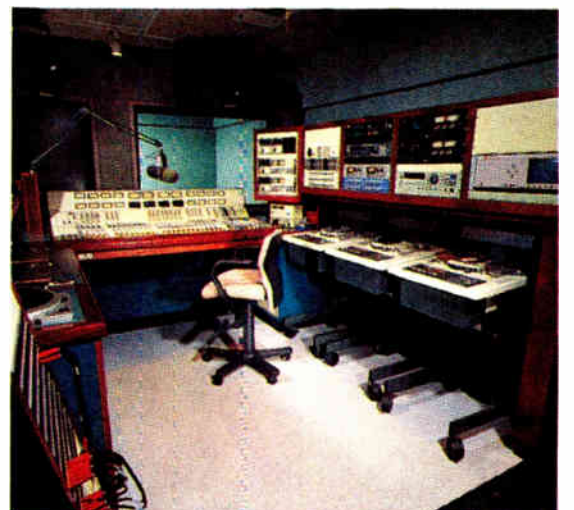

Pacific Recorders & Engineering Corporation  
 2070 Las Palmas Drive, Carlsbad, CA 92009  
 Tel: 619-438-3911 Fax: 619-438-9277 GSA: GS-03F-2057A

**DESIGNS THAT MAKE THE DIFFERENCE**

# Radio's Role on the Superhighway

► continued from page 18

activated shopping service from home and eventually from your car? Or information downloads for news, weather, sports and stock quotations exactly when you want them?

**Time Shifting:** TV networks already know about this one. And radio stations with hard disk systems are using them to pre-tape and self-automate dayparts, then send their morning man out to sell time. One live person sitting in a booth down the street announcing the time is rapidly becoming an antiquated concept.

**DAB:** There isn't much to add to a topic that's already been talked to death, except to point out that many of the new technologies that will affect radio have their origin once a signal becomes digitized. It may not happen tomorrow, but it will become a reality as we move into the 21st Century (only a scant half dozen years from now).

## Seizing the moment

If all this seems scary, let me borrow a quote from John Abel's Future Summit talk and repeat that when it comes to new technologies: "The limits are measured by our creativity." For starters, radio broadcasters are probably going to be better off if they stop thinking of themselves as providers of a single program in which to sell a limited number of availabilities. The one program

per signal idea is going to have to change, and radio owners are going to have to focus first on their inherent advantages.

Foremost among them are radio's installed base and the ability to transmit a wireless signal. Radio is everywhere. It is said to have a 99 percent penetration rate: contrast that with cable's 63 percent. Radio is in homes, in cars, in our ears, and even, in my case, in the subway. That means that anybody wanting to reach large numbers of people quickly and inexpensively will have to consider the radio signal of tomorrow as an opportunity. The first name for radio was "the wireless."

We might want to revive that moniker as we move into the future too, because one of broadcasting strengths is the ability to go from here to there, without cables. If I want to send my story to *RW* Editor Luci Cobo these days, I have to hook up my computer to a modem and my modem to a phone and her computer has to be hooked up to each one as well (okay, we use electronic mail, but it's the same principle). What if I was on safari in Kenya (I wish!)? Radio could reach me. But Luci couldn't.

## Endless possibilities

The point is, a wireless form of communication provides a crucial link, a connecting access road, if you will, on the info superhighway. Once station

owners start thinking like that, all kinds of possibilities open up. With "digitization," station owners can think of themselves as signal owners and transmission providers. And one signal will multiply

**Anybody wanting to reach large numbers of people quickly and inexpensively will have to consider the radio signal of tomorrow as an opportunity.**

into several signals transmitted at once. In addition to data signals, these could be narrowcast program signals, each to a different niche market, each with its own advertising. If one commercial cluster every 15 minutes is profitable, five (or more) on each of five signals can be five times as profitable.

The same holds true for "programs on demand." News, weather, traffic and stock quotes on demand can all be sponsored. So can music downloads and over-the-air shopping services. Or revenues can be split among the signal provider (you) and the retailer offering the item for sale.

Additional revenue streams are possible from leasing multiplexed signals for data transmission. And how about deals

with the satellite and cable companies to carry your signal? National news and personalities like Howard Stern and Rush Limbaugh will be in demand even for direct satellite services. Sometimes radio just does it better.

Of course, by now you realize that the important point in all of this is not really an expansion of technology, but an

expansion of the way radio broadcasters think of themselves.

And just as General Sarnoff looked at Marconi's wireless and saw a music box that could provide music to every home, we can look at the explosion of new technology and see radio signals becoming the access lanes to the information superhighway.

In fact, I see a sign for an on-ramp just up beyond that next curve. Care to join me on the six-lane? I think the General would approve.

□□□

*Judith Gross is VP/Head Copywriter for MediaScan, an advertising and public relations firm specializing in broadcast and pro-audio technology. She can be reached at 212-929-6108.*

## THE RF EXPERTS KNOW—MYAT DELIVERS

### MYAT DELIVERS QUALITY

**Y**ou can rely on MYAT rigid line and components to deliver a clean, powerful signal to your antenna. Pure highest quality copper, brass and silver plus computer-aided design and manufacturing ensure consistency and accuracy. No wonder demanding broadcasters worldwide choose MYAT products for their passive systems. We take Quality Control very seriously.

### MYAT DELIVERS RELIABLE PERFORMANCE

**O**ur non-galling silver-plated beryllium copper contact springs, brass elbow reinforcements and virgin Teflon inner supports are designed for maximum velocity, minimum attenuation and long service life. Every MYAT component is tested before shipping and backed with a full one year warranty. MYAT products are built for the long run.



### MYAT DELIVERS WHEN YOU NEED IT

**M**ajor transmitter manufacturers with strict production schedules rely on MYAT to deliver quality components on time and within budget. So do leading broadcasters like the Empire State Building's newest TV tenants. At MYAT, commitments are kept.

### LET MYAT DELIVER FOR YOU

**W**hether you're planning a new tower, upgrading an older installation, or coping with an emergency, you can depend on MYAT rigid line and components. Thousands of RF experts around the world already do. Contact your RF distributor, or phone us for our catalog, installation planning guide and engineering reference. Its detailed drawings can help you put together an efficient, trouble-free transmission line that will last for decades. For a free copy call 201-767-5380 or fax 201-767-4147.

### RIGID LINE: RADIO'S EFFICIENT CHOICE

**40 YEARS OF EXPERIENCE. 40 YEARS OF EXCELLENCE.**  
**380 Chestnut Street • P.O. Box 425 • Norwood, NJ 07648**  
**Tel 201-767-5380 • Fax 201-767-4147**



# NEW DIGITAL CLARITY

## CLARITY OF PURPOSE:

*"Design and build an actual digital replacement for the analog cart machine utilizing individual, Magneto-Optical discs."*

## CLARITY OF DESIGN:

*"Meet operator needs in form, fit, and function. Minimize space requirements and maintenance. Maximize reliability and ease of operation."*

## CLARITY OF EXECUTION:

*"Familiar controls...no keyboards\*, no touch screens, no hard drives, no operator training."*

Clear, Clean,  
Uncompressed, Uncluttered

## **AIR cart · mo**

- The clarity of 3.5 inch Magneto-Optical media
- Individual, affordable
- Clarity in operation, a true replacement for cart machines
- Linear, familiar and reliable
- Conforms to the ASPECT® standard
- Clearly superior

\*Keyboard needed for production labeling.



**AIR corp**  
SYSTEMS

• 1845 W. Hovey, Normal, IL 61761 • TEL: 309-454-4900 • FAX: 309-452-0893

See the **AIR cart · mo** at NAB '94 in the Radio Hall • Right turn just inside the doors, Booth #3926

# There's a Right Way



**"I did it right from the start with Computer Concepts' DCS."**

*I don't sweat* when it comes to our spot-heavy morning drive or complicated LMA formats. The reason is simple: First I did my homework. And then I bought a DCS hard disk system from Computer Concepts. In fact, I bought several.

I smile at the thought of multiple program formats and satellite automation, live and live assist. I laugh at complex spot rotations, two-channel crossfades with simultaneous recording and networking to traffic—they're no problem for the DCS.

And Computer Concepts customer support is terrific. Their software experts can even troubleshoot my DCS and upgrade the software remotely, via modem.

No wonder Computer Concepts DCS has turned hundreds of stations into happy customers. I'm glad I'm one of them. Oh, I almost forgot. The price was right, too.



**"I should have bought a DCS in the first place."**

*I thought* I'd impress HQ by buying the cheapest hard disk system I could find. After all, they all look the same! Their promises sounded good and I wanted to believe.

I found out promises come cheap. But their system wasn't really cheap—not once you added up the little "extras" it took to do the bare minimum. And it still couldn't do all the things our station really needed.

I found out the hard way, at 3 AM when the system we bought crashed. And in morning drive, when missing spots meant dollars down the drain. When I finally reached customer support, they said they were working on software they thought would fix my problem, but they weren't sure when it would be done. Guess what I told them?

Now I know better. We're getting a Computer Concepts DCS. I learned a costly lesson: Get it right the first time. Call Computer Concepts first.

# and a Wrong Way

DCS by **Computer Concepts**  
CORPORATION

Computer Concepts Corporation  
8375 Melrose Drive, Lenexa, KS 66214  
Phone: (913) 541-0900 Fax: (913) 541-0169

Circle (164) On Reader Service Card

World Radio History

GUEST COMMENTARY

# Radio Engineers: Leading a Thankless Life

by Jim Wojciechowski

**HOUSTON** Leaving the radio business, after having worked as a chief engineer for quite a few years at various medium and major market stations, has turned out to be one of the best decisions I ever made. Quite frankly, I've never been happier.

Never in working life, beginning with a factory job at age 16, did I ever feel so completely unappreciated and used.

**Remote worries**

My last broadcast job afforded me the wonderful opportunity to provide the station ownership with a remote broadcast vehicle (my truck), a service vehicle (my truck), tools, test equipment, insurance and gasoline out of my own pocket.

I was given the honor and privilege of being on-call 24 hours a day, 365 days a year, always available to take care of the smallest problem, from a microphone not working (the "mute" switch depressed) to a PCB fire at the 30-year-old transmitter site.

Weekends were the best. From September to December, Saturdays were dominated by live college football broadcasts. The engineer was always first to arrive and last to leave, which was never considered by the sales department when it scheduled a remote from the local carpet store for me the following morning.

On Friday nights and Monday mornings (up at 4:30 a.m., even if you were up all night repairing the transmitter) there were always remotes. After all, who needs a social life or family or marriage?

During my last tenure as a chief engineer, I had a staff of one: me. This staff designed and built a modern state-of-the-art studio facility, a directional AM transmitter site, an FM transmitter site, a complex RPU system with remote receive sites, coordinated several live sporting events (college and pro) and

dealt with many interference complaints.

This staff appeared before planning commissions, zoning boards and other government agencies on behalf of its employer and wrote several letters and legal papers for various administrative agencies, while trying to take care of the day-to-day operations and repairs at a broadcast station.

The general sales manager plugged the toilet and wanted the chief engineer to take care of it. (He was angry when I refused.)

While doing this at my primary station, I also had to do contract work to make ends meet. This meant being on-call for several stations in the area, a real nightmare during severe weather season, but a necessity because my real income from my primary station was \$3 dollars an hour after subtracting my expenses that were not reimbursed from my salary and dividing that number by the number of hours worked.

**Priorities**

My performance was not judged by this organization's sales-driven management according to any of the efforts I've described. I was evaluated by how quickly I could get around to repairing a cart machine, or set up the 100-percent flawless remotes the sales department demanded.

In a society that replaced reality with image, time spent away from the studio or out of sight of the sales staff was assumed to be time spent home sleeping (or worse). My job performance was measured by my ability to see to each individual's needs, rather than my work for overall good of the station.

Is it any wonder so many broadcast stations are unable to create a competitive product?

I heard through the grapevine that some considered my job performance inadequate. It hurt. I gave up part of my health

and several good years of my life, wasting precious time in an industry that considers technical skills the equivalent of migrant labor.

Perhaps if I had the right "image" and could sell remote broadcasts, I would have been considered "hard-working" or "creative."

Not too long ago, the Society of Broadcast Engineers expressed concern that the broadcasters have been unable to attract young people to broadcast engineering. The cause of the problem is right under their noses.

McDonald's offers much better working

conditions and more respect than most broadcast stations. As long as these attitudes continue, the once great industry of broadcasting is doomed to a future of technical and marketplace obsolescence.

In case you've asked the obvious question: "Why did you put up with it?" I can't say. But I'm currently in therapy.

□ □ □

*Jim Wojciechowski was chief engineer at various radio stations for eight years. He recently left the broadcast industry to work for an instrumentation and atmospheric sciences firm.*

For hops across town or across the county, the coolest stations are choosing BEXT STL's because they work. From 1.5 to 15 watts, starting at \$3,980 complete.

**BEXT**  
1045 10th Ave.  
San Diego, CA 92101  
619-239-8462  
FAX: 239-8474

Circle (100) On Reader Service Card

See Us At NAB Booth 2414

World Radio History

**Who needs the Dividend Composite Filter?**

**every FM station that**

- Has subcarriers for RBDS, data services, or other applications, especially when those subcarriers generate revenue
- Uses a microwave STL
- Includes composite clipping in their processing
- Wants to regain lost modulation
- Seeks to reduce multipath related distortion

The Dividend Composite Filter reduces noise often generated by audio processing and STLs in the upper composite spectrum from 53kHz to 99kHz. Now you can protect your subcarrier signals, regain lost modulation, reduce multipath related distortion, and maintain signal integrity for only \$1195.

**the dividend composite filter**



2101 SUPERIOR AVENUE, CLEVELAND, OHIO 44114 • TEL: (216) 241-3343 • FAX: (216) 241-4103

Circle (12) On Reader Service Card

See Us At NAB Booth S200

# Ways to Tackle Splatter Monitoring

by Tony Dinkel

**LONG BEACH, Calif.** On June 30, 1994, all AM radio stations are faced with a new requirement. They will be required to perform and document an RF emissions proof of performance, covering occupied bandwidth and harmonics.

Those of us who installed National Radio Systems Committee (NRSC)-standard processors on our transmitters before June 1990 got a grace period. That time is almost up.

I have actually been performing this service for both my AM and FM clients for the last several years. There are several ways to accomplish these measurements.

## Splatter monitor

The most popular and low-cost approach is to use a "splatter monitor," which is manufactured by Delta Electronics (RW, Feb. 9). It allows you to tune your station's carrier frequency, then tune off from center with various filters to trace the AM signal's spectral content on an analog meter.

Among several of the attractive features of this instrument are: frequency agility, allowing a group owner or consultant to purchase one and have it usable at all of his facilities; the ability to be powered from 12 volts DC for easy use in a vehicle, which is a necessity when following the rule, and a reasonable price.

However, the splatter monitor has its

limitations. It will only tune to 100 kHz offset from the channel to which it is tuned. The required harmonic measurements must be performed with a field intensity meter or general coverage receiver.

Because it uses a demodulator, the splatter monitor detects signals on both sidebands simultaneously. This can be a hindrance if there is an interfering signal on one sideband and not the other.

Also, the splatter monitor does not pro-

**In congested areas, some critical areas of sweep may be obscured by the signals of other transmitters.**

vide hard copy output. The results must be logged by hand.

My preferred technique is to use a "properly operated and suitable swept-frequency RF spectrum analyzer," as allowed in FCC Rule 73.44(a). My analyzer is a Tektronix model 492, which I find to be perfectly suitable for NRSC compliance studies.

It does not operate from 12 volts DC, which is mandatory. The rules require establishment of a field measurement point. In most of my measurement experiences, that point is not near a 110 VAC outlet. The problem is solved, however, with an Exeltech 500 watt power inverter,

By combining the versatility of the analyzer and the unencumbered availability of an AC power source of excellent quality into my Nissan Pathfinder 4x4, I have created a mobile platform capable of near laboratory grade measurements.

## In the field

To perform an NRSC proof, the location for the measurement must be established. For non-directional stations, the rules are easy: 1 kilometer from the antenna. I use

a Sony GPS receiver as a guide in determining this point.

Directional stations are a bit more involved; the conditions at each facility vary. The analyzer must be connected to a suitable test antenna. I use a 108-inch CB whip attached to the rear quarter panel of my vehicle.

At least three separate sets of data are to be taken. The first is a close-in sweep at 5 kHz per division. This resolves points -25 dBc at 10.2 kHz and -35 dBc at 20 kHz.

This measurement requires a 10-minute "peak hold" or "max hold" and 300 Hz resolution bandwidth on the instrument. It is best to watch the display as it builds up. A single burst of noise can ruin a good data run.

The second sweep requires the analyzer be set to 25 kHz per division. In this sweep the "30 kHz to 60 kHz is removed from carrier and must be attenuated at least 5 + 1 dB/kHz below the carrier" and the -65 dBc at 60 to 75 kHz data points. This sweep width allows a good view of the spectral content of the transmitter under test.

However, in congested areas, such as Los Angeles, some critical areas of the sweep may be obscured by the signals of other transmitters. This makes verification

of compliance difficult. The problem also affects the third and final sweep, which is a search for harmonics.

In the case of one station, KFI(AM) Los Angeles on 640 kHz, the second harmonic falls on 1280 kHz, which is an active channel. To verify KFI transmitter compliance, the station on 1280 kHz would have to sign off while the measurement is made.

To date, this has not been done, although a test was conducted in front of the transmitter building with a car radio receiver tuned to 1280 kHz. The station transmitting on that frequency was received without interference—not bad for 1,000 feet from a 50 kW stick, in my opinion.

Observations were taken through the fifth harmonic. There were no responses above the noise floor of the analyzer.

## Satisfying requirements

As each sweep is taken, the analyzer's "delta marker" feature is used to verify frequency offset versus dB below carrier of the trace. This is a sort of compliance preview. Each sweep is then frozen using the "save" feature and stored individually in its designated digital memory within the analyzer.

After the individual sweeps have been stored, a trip is made to the client's studio or transmitter building. Each trace is then recalled individually and examined for compliance. The delta marker can be used to mark desired points of interest on the trace. After the markers are in place, each screen is plotted on a Tektronix HD-100 four-color plotter.

The result is a complete record of each measurement including all instrument settings, satisfying the requirements of Rules 73.44 (a), (b) and (d).

Using a spectrum analyzer to determine NRSC compliance is likely the most sensible and easy approach to the complete task.

□ □ □

*Tony Dinkel is a technical consultant in the area of high-performance STL systems and related services. His company, Microwave Frequency Services, Long Beach, Calif., also does RF compliance studies for AM and FM stations. He can be reached at 213-385-0101; fax: 310-425-6299.*

# MARTI

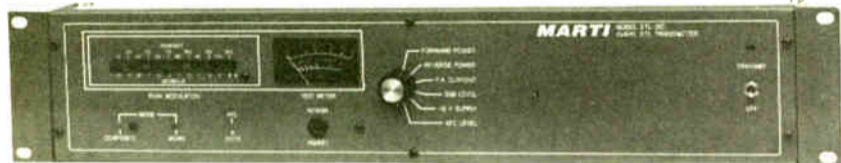

## STL-15C Composite Transmitter

**MARTI's** broad range of radios, with the latest developments and the most advanced designs are actually less expensive to build than the competition. So our higher performance cost less. Call or write for more information.

**MARTI Electronics, Inc.**

PO Box 661

Cleburne TX 76033-0661

Phone: (817) 645-9163 • FAX: (817) 641-3869

See us at NAB Booth 3918/3919

**GEPCO INTERNATIONAL**

Audio, Video & Broadcast Cables

**GEPCO**  
GEPCO INTERNATIONAL  
CHICAGO, IL

2225 W. HUBBARD ST., CHICAGO IL 60612-1613  
(312)733-9555 FAX (312)733-6416 (800)966-0069

# Model SM-1 AM Splatter Monitor

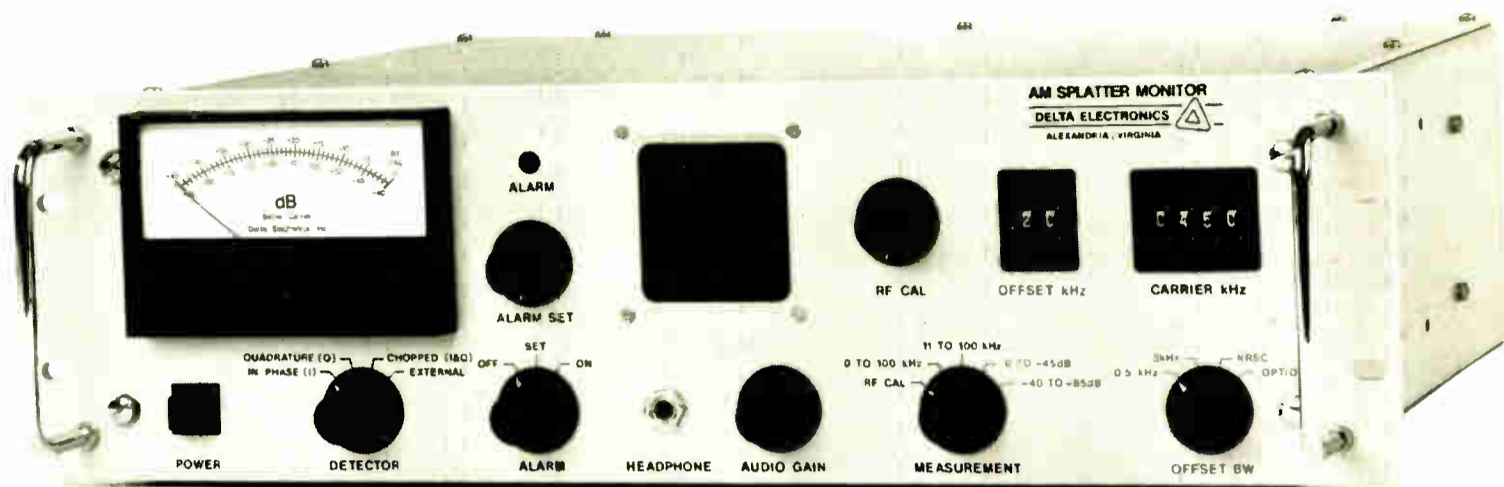

## Features

- Inexpensive means of verifying FCC compliance
- Easy to operate and interpret measured results
- Measurement of I, Q, I+Q (chopped) and external audio signals
- 450 kHz to 1800 kHz phase-locked operation with 10 kHz or optional 9 kHz channel spacing
- Portable operation from external 12 VDC supply and optional active antenna for near field signal monitoring
- Quadrature modulation measurement enables transmitter adjustments for minimum IPM
- External audio input enables evaluation of audio processor's NRSC filter performance
- Optional peak hold circuit
- Optional spectrum analyzer 300 Hz resolution bandwidth model filter assembly
- Front panel speaker and headphone jack permit audible monitoring of interference
- Adjustable alarm output permits remote control monitoring of interference
- Rear panel I and Q outputs and buffered meter output

The Model SM-1 Splatter Monitor provides AM broadcast engineers with a means of accurately and easily measuring off-channel emissions to ensure compliance with the FCC (NRSC-2) emissions standard. Manufactured in response to the recommendations of the National Radio Systems Committee (NRSC) for AM improvement, the instrument provides many of the features of an expensive spectrum analyzer at a significantly reduced price. The Splatter Monitor measures the level of splatter or any other spurious emissions which fall between 11 kHz and 100 kHz away from both sides of the carrier.

The Splatter Monitor provides both fixed and portable operation. While normally installed in an equipment rack and fed with the transmitter or common point RF sample, it also operates in the field from a twelve volt DC source. An optional active antenna then provides the RF sample. This portability is very useful for investigating interference complaints.

**DELTA ELECTRONICS**



**1-800-8-DELTA-8**  
Telephone 703-354-3350  
Fax: 703-354-0216

**Delta Electronics, Inc.**  
5730 General Wahsington Drive  
Alexandria, VA 22312

# WORKBENCH

## Cable Ties that Bind

by John Bisset

**FALLS CHURCH, Va.** Anyone who has done a lot of remotes and has not used Rip-Tie® Velcro cable wraps has missed one of the greatest inventions of all time. They are especially useful after a remote, when cable can be coiled and secured with the Velcro fasteners (as shown in the photo).

Rip-Ties have evolved into a studio use—

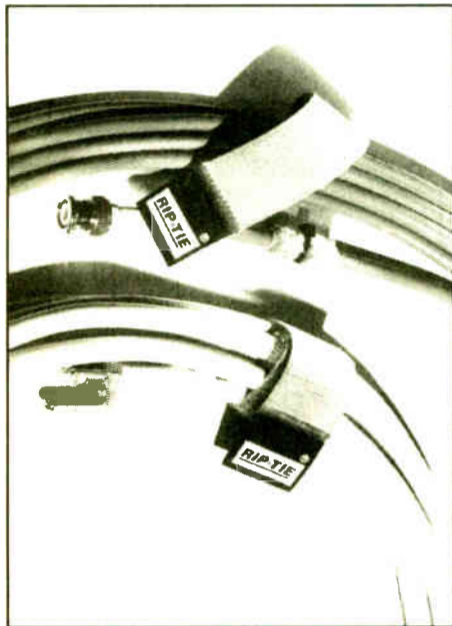

Seam-Tech's RIP-TIE® cable wraps, shown above, now come in an adhesive-backed version to permit neat routing of cables and wiring under consoles and inside racks.

securing wiring runs under console cabinets or in racks. How often are control

rooms wired neatly with plastic wire ties, only to be cut later when the time comes to install new wiring?

Snaking another wire around the bundle through the cable mount saddle is frustrating and time-consuming, especially if you are working with wide-diameter cables.

Before using Rip-Ties for under-the-console studio wiring, take a look at the even simpler Cable-Catch Velcro cable organizer. One side of the Velcro has an adhesive strip, similar to wire tie saddles, which permits quick and secure mounting to any flat surface. The mating piece has a sewn tab that enables the user to open the organizer with one hand to add or remove wires.

For information on Rip-Ties and a free sample can, circle **Reader Service 82**.

★ ★ ★

From a little north of WSOY, Robin Cross of WNIU(FM) DeKalb, and WNIJ(FM) Rockford, Ill., reports on an interesting way to recycle those anti-static sheets used in clothes dryers. Rubbing them over computer monitor screens will remove dust and reduce future dust buildup due to high voltage inside the monitor.

Robin warns that it is important to use sheets that have been through the dryer. Sheets from right out of the box leave too much residue on the screen. There is enough anti-static compound left in the sheets after coming out of the dryer to keep dust away and not smudge the monitor.

Robin Cross can be reached at 815-753-0088.

★ ★ ★

RW's *From the Trenches* columnist Alan Peterson faxed me a simple, yet very useful tip I have since tried at a couple of satellite

installations with very good results.

After resetting his satellite dish for what seemed to be the thousandth time, Alan has attached a six-inch length of PVC pipe to the outer edge of the dish which he uses as a "rifle site."

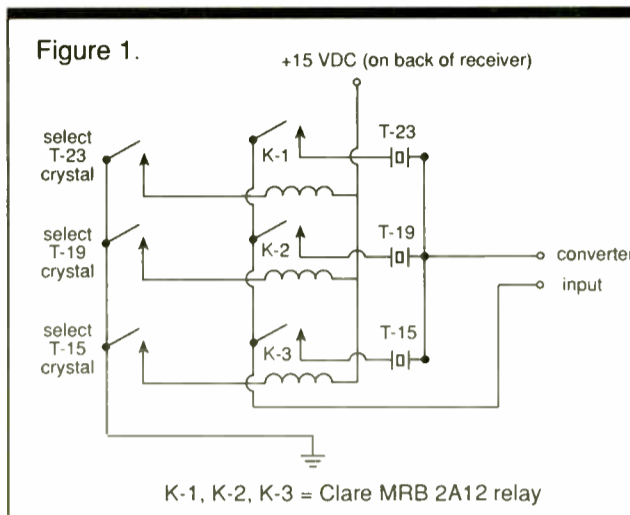

When the dish is properly aimed at the satellite, the pipe is positioned to view a fixed point of reference not directly in the line of signal. For example, the rooftop air conditioner on another building, the light on top of the water tower or any other nearby structure could be used as a fixed point.

If the dish is blown out of line, aim the pipe until you see your point of reference and the signal returns. Alan says this method also works well with theatrical spotlights.

★ ★ ★

Frank Konwinski, chief engineer at WSOY-AM-FM Decatur, Ill., has a scheme for remote switching of crystals in a Scientific-Atlanta DAT-32. WSOY(AM) often has to quickly switch to different

transponders during promos or IDs.

Figure 1 illustrates the plan. Three Clare MRB-2A-12 relays are tied to each of the crystals. In the control room, a three-station latching pushbutton switch selects between the relays for Transponder 23, 19 and 15.

Fifteen volts to power the relays is available on the back of the receiver, with the selected crystal output being fed into the converter input on the receiver.

The relays must be mounted within six inches of the crystals and the converter input. At first, Frank mounted the relays and crystals on the back of the down converter, but when the crystals were switched, the SEDAT cards would lock up and the system could only be reset by

unplugging the power supply.

If you want to get fancy, the relays have an extra pair of contacts that can be wired for status. Frank used the "eyelash"-type pushbutton switches used on many audio consoles. These are the latching switches that display a red flag when one is depressed. The eyelashes cover the red flag when the switch is not selected.

Frank Konwinski can be reached at WSOY, 217-877-5371.

□ □ □

*John Bisset is a principal with the contract engineering group Multiphase Consulting. Submissions to Workbench can be sent to his attention, in care of RW, or faxed to 703-764-0751. Published submissions qualify for recertification credit for all SBE certification levels.*

## Products & Services Showcase

For more information on the products shown below, circle the appropriate Reader Service No.(s) on the enclosed Subscription/Reader Service card or contact the advertiser directly.

### EBS EQUIPMENT



Model CEB Encoder-Decoder.....	\$540
Model CE Encoder.....	\$375
Model CE with Stereo Option.....	\$405
Model CD Decoder Only	
(REQUIRED FOR LPTV).....	\$320
Receiver can be supplied to drive Decoder.	\$100

- Encoder FCC Type Accepted •
- Decoder FCC Certified •
- Exceeds FCC Specifications •

All interconnections to the EBS equipment are made through a barrier terminal block. No special connectors necessary. In stock—available for immediate delivery. [See Us At NAB Booth 4812](#)

**GORMAN REDLICH MFG. CO.**

257 W. Union St.  
Athens, Ohio 45701

Phone 614-593-3150 • FAX 614-592-3898

READER SERVICE NO. 49



### A Console for your Future

- DCA (Digitally controlled analog) faders
- Better than "CD" quality sound
- Modular frames hold 6, 12 or 22 mixers
- Five types of input mixers available
- Optional RS-232 serial interface
- LCD displays dynamically label each mixer
- Programmable machine control system
- 2 Mix-Minus outputs, Talkback & more
- Prices start at \$3900

**Logitek**

Call: 800-231-5870 or 713-782-4492  
for your nearest Logitek dealer

READER SERVICE NO. 71

### Omega Scientific Corporation

### RF MATCHING NETWORKS

Phasors,  
Diplexers,  
ATU's  
Intercept  
Filters

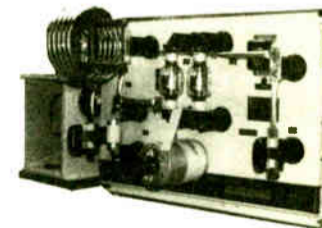

Custom Design and/or Manufacture

Call or FAX for RFQ info sheet

Ph: (210) 599-0789

FAX: (210) 599-0799

4246 Gate Crest, San Antonio, TX 78217

READER SERVICE NO. 85

# The Aphex Audiophile Air Chain



## Higher Quality *and* Extended Coverage!

Smart broadcasters know that quality sound is essential to attract and keep loyal listeners ... and advertisers.

That's why premier stations around the U.S.A., and around the world, rely on the Aphex Audiophile Air Chain.

Now there's one more reason to turn to Aphex — better coverage of your listening area.

Stations that have installed the powerful combination of the Aphex *Compellor*® Model 320, *Aural Exciter*® Type III, *Dominator*™ II Model 720 and the *new Digicoder*™ digitally controlled stereo generator — as well as their listeners — are raving about better signal quality and a reduction in multipath.

*"A surprise bonus has been the apparent increase of coverage in fringe areas — we are getting very positive responses from listeners in Sacramento, 100 miles away."*  
- Tim Pozar, CE, KKSF-FM, San Francisco.

*"Immediate improvements in fringe signal quality were noted. These improvements included a reduction in multipath and picket-fencing."*  
- Gary Greth, CE, KLON, Long Beach, CA.

**APHEX** *Improving the way the world sounds*<sup>SM</sup>  
SYSTEMS 11068 Randall Street, Sun Valley, CA 91352 ■ (818) 767-2929

Compellor, Dominator, Aural Exciter and Digicoder are trademarks of Aphex Systems Ltd.

©Aphex Systems

Circle (7) On Reader Service Card

World Radio History

See Us At NAB Booth 3924

# If We Don't Have It You Don't Need It.



Serving broadcasters on six continents and in more than 100 countries, we have become the world's leading distributor of studio, production, and satellite equipment, offering the widest range of radio products from a single source.



We deliver when you need it. Over 90% of our orders are shipped within 24 hours. Computer technologies and experience in transportation management, packaging and rate negotiations has resulted in the most efficient shipping and receiving department unsurpassed by our competition.



Our experienced broadcast professionals are working when you are—Monday through Friday, 8:00 a.m. to 8:00 p.m. Eastern. When you know what you need, you'll get the right price. When you don't, you'll get experienced advice.



Satellite products we distribute include reception equipment for digital or analog SCPC, audio or video subcarrier data, uplink and downlink antennas and support products. We are your primary source for the most innovative and effective technology.



With today's growing shortage of broadcast engineers, many broadcasters lack the technical staff to evaluate, maintain and service their equipment. We provide unparalleled customer support with experienced, certified service technicians.



Customer satisfaction is number one. Customer service representatives are ready to check your orders and answer any questions you might have. You can always count on fast, friendly service.

 **HARRIS  
ALLIED**

## 1-800-622-0022

See Us At NAB Booth 2218



FEEDLINE

# Doing the Uplink/Downlink Math

by W.C. Alexander

Part II of III

**DALLAS** If you aren't a math whiz or don't care about working through the calculations, you might want to skim through the formulas in this month's column, which deal with satellite transponders and how they work. You will still get a good idea of the factors that influence satellite systems.

A C-band satellite transponder receives the uplink signal in the 6 GHz band, amplifies it, translates in frequency, filters and retransmits the signal back down in the 4 GHz band. A Ku-band transponder receives 14 GHz signals, processes them in the same order and retransmits them in the 12 GHz band.

The measure of how well the uplink path works is called "G/T," defined as:

$$(G/T) = G_a - 10 \log(T_s) \text{ dB/K}$$

where:

- $G_a$  = Antenna gain referenced to LNA input (dBi)
- $T_s$  = System noise temperature referenced to LNA input (K)

The downlink side of the transponder is characterized by saturated EIRP. SFD, the uplink RF flux that is required at the satellite to saturate the transponder, ties the G/T of the uplink and EIRP of the downlink together and defines transponder sensitivity. All these parameters vary according to the geographic location of the earth station with respect to the satellite.

The reason for this is a function of the satellite's antenna aperture and radiation pattern. The G/T and EIRP performance of different satellites are typically called "footprints."

A couple of other parameters of interest are the input ( $BO_i$ )/output ( $BO_o$ ) power transfer and intermodulation response. Both parameters are normally specified in terms of input and output back-off, or as a function of the power reduction in dB with respect to saturation.

Carrier-to-noise ratio (C/N) is used to calculate the overall performance of a satellite system, from uplink through the transponder to the downlink. First calculate space loss:

$$L_s = 185.05 + 10 \log [1 - 0.295 \cos(H) \cos(AL)] + 20 \log f$$

where:

- H = Latitude of earth station
- AL = Difference in longitude for earth station and satellite
- f = Frequency in GHz

With the space loss in hand for both uplink and downlink, the overall satellite link can now be calculated. Calculate uplink C/N by:

$$(C/N_o)_u = EIRP_u - L_u + (G/T)_s + 228.6$$

or

$$(C/N_o)_u = S - A + (G/T)_s + 228.6$$

and

$$S = SFD - BO_i$$

where:

- S = Flux density ( $\text{dBW/m}^2$ )
- $L_u$  = Uplink space loss (dB)
- $EIRP_u$  = Uplink EIRP (dBW)
- $(G/T)_s$  = Satellite G/T (dB/K)
- $A_i = 21.5 = 20 \log f$  (GHz) ( $\text{dBm}^2$ )
- SFD = Saturation flux density ( $\text{dBW/m}^2$ )
- $BO_i$  = Transponder input back-off (dB)

Now compute the downlink side:

$$(C/N_o)_d = EIRP_d - L_d + (G/T)_{e,s} + 228.6$$

and

$$EIRP_d = EIRP_s - BO_o$$

where:

- $EIRP_d$  = Downlink EIRP (dBW)
- $EIRP_s$  = Saturated EIRP (dBW)
- $L_d$  = Downlink space loss (dB)
- $(G/T)_{e,s}$  = Earth station G/T (dB/K)
- $BO_o$  = Transponder output back-off (dB)

Now compute the total carrier-to-noise density ratio of the system:

$$(C/N_o)_t = [(C/N_o)_u^{-1} + (C/N_o)_d^{-1}]^{-1}$$

In the Ku-band, rain is the primary limiting factor in propagation. Raindrops interact with electromagnetic waves by causing absorption, scattering and depolarization.

The attenuation level is determined by the intensity of the rainfall and the path length exposed to rain. There is much more attenuation, for example, from a one-inch-per-hour rainfall produced from a cloud base at 20,000 feet than the same amount of rain from a 1,000-foot cloud base.

Rainfall rates for various parts of the country have been studied by NASA and other agencies. Maps showing rainfall in various regions are included in the "NASA Propagation Effects Handbook for Satellite Systems Design" (ORI TR 1679).

Rain attenuation is calculated in two steps. First determine the rain rate in millimeters

per hour as a function of statistical probability. Then calculate the actual rain attenuation associated with the rain rate which exceeds that probability. Those of us without precision rain rate measurement equipment and ceilimeters, can refer to the aforementioned NASA publication.

Add the probable rain attenuation to the satellite link as a margin to allow for the specified availability under conditions of heavy rainfall. At the same time, be prepared for periods of complete attenuation during rain fade.

In addition to causing attenuation, thermal radiation from raindrops increases the earth station antenna noise temperature. In other words, not only is the signal attenuated, the noise level is increased as well, causing a "double-whammy" to the link's  $C/N_o$ .

Finally, an AM processor that combines technical excellence with format flexibility, ease of operation, and bottom line results.

The Cutting Edge Unity AM is a complete, multi-band AM processor designed to make your station stand out on the dial. While Frank Foti uses the same processing sections as his Unity 2000i FM processor, he has specially tailored the Unity AM to suit AM's unique characteristics.

Processing includes a selectable Broadband AGC, selectable Phase Rotator, adjustable low-frequency Bass Enhancer, four-band Processor/Leveler, four-band multiple time constant Limiter, and final Limiter. The use of feed-forward processing allows the Unity AM to process more consistently at all levels. The result is a more open, realistic sound with greater perceived loudness.

Frank has provided presets for a number of formats and programming requirements, including Talk and News, Country, CHR, and more. These are just starting points for your processing adjustments, as there are fifty user memory locations that can be compared by merely pushing a button.

The Unity AM's user menus are logically arranged to be learned in minutes. The easy-to-interpret set-up metering in the Processing Display allows you to see the activity of all processing functions so that you can determine the overall effect of any changes you make.

Better sound, better ratings. The Unity AM puts both in your hands.



**stand out on the dial**

**the unity am**  
the world's best sounding am processor



CUTTINGEDGE

2101 SUPERIOR AVENUE • CLEVELAND, OHIO 44114 • TEL: (216) 241-3343 • FAX: (216) 241-4103

# TOMORROW RADIO.

Tomorrow Radio is here. AudioVAULT OnLINE™ harnesses the full power of today's advanced digital networks. Now you can provide recorded audio to every studio and information about that audio to every desk. Now you can achieve total station connectivity, and total station productivity. Start big or small. Start today.

START NOW.

GET OUR

AudioVAULT OnLINE  
INFORMATION PACKET.

(800) 426-9082

FAX (206) 441-6582

# TODAY.



AudioVAULT OnLINE



**BROADCAST  
ELECTRONICS, INC.**

*WORLD LEADER IN RADIO BROADCAST TECHNOLOGY*

## Exhibitor Directory

The 1994 Exhibitor Directory is a listing of information provided by exhibitors who responded to an RW NAB questionnaire. Past and potential NAB exhibitors were asked about new and established products scheduled to be shown at NAB this year. Questionnaires returned by the deadline are included here. TBD for booth number means a booth assignment had not yet been made.

**COMPANY** **BOOTH #**

**360 Systems** **5420**  
Introducing: The DigiCart/TC, a random access digital audio hard disk recorder designed for SMPTE time code synch applications between video and audio.  
Also: The DigiCart II digital audio recorder and the A16/B audio routing switcher.  
Contact: Doug Leighton, Marketing Manager  
18740 Oxnard Street  
Tarzana, Calif. 91356  
818-342-3127

**3M** **16605**  
On display: The 908 analog recording master tape for Nagra recorders, featuring 75 dB signal-to-noise ratio, and line of recording media.



**A-Ware Software** **5120**  
On display: MusicMaster scheduling and music maintenance system, which interfaces with almost any automation and traffic system. Also Closeline, a school and business closing management system.  
Contact: Joe Knapp  
A-Ware Software, Inc.  
22600 Arcadian Avenue  
Waukesha, WI 53186  
414-521-2890

**Acoustic Systems** **12807**  
On display: Modular broadcast/recording enclosures including the BB/Econoline and BB/Proline series of voice-over booths.

**AEQ** **2300**  
On display: The Management of Audio Systems (MAR) digital audio workstation and storage device. Company line of studio gear, including power amplifiers, audio monitors, consoles, portable mixers and telephone hybrids.  
Contact: Gerard Vargas  
AEQ  
2211 South 48th Street, Suite H  
Tempe, AZ 85282-1008  
602-431-0334

**AIR corp Systems** **3926**  
Introducing: AIR cart.mo digital cartridge machine. A digital replacement for analog cart machines. Featuring non-compressed audio at a 48 kHz sampling rate. AIR cart.mo uses removable 3.5 inch Magneto-Optical discs.

**Akai** **4602**  
On display: The DR4d self-contained four-track hard disk recorder and DD1000i re-writeable magneto optical recorder, both now utilized in broadcast and radio production environments. Other products will include the S-Series of digital samplers.

**AKG/Orban/dbx** **2806**  
Introducing: The Orban DSE 7000 digital audio workstation and the Optimod-FM 8200 digital processor. AKG's new C3000 microphone, designed for radio announcers, also will be in the booth.  
Contact: Amy Herndon  
1525 Alvarado St.  
San Leandro, CA 94577  
510-351-3500

**Altronic Research** **2700**  
Introducing: The model 67150 150 kW medium wave, air-cooled dummy load, processor-based calorimetry system for air or water systems, and the Model 6700 and 0700 series of dummy loads.  
Contact: Doug Starkey  
P.O. Box 249  
Yellville, AR 72687  
501-449-4093

**Andrew Corp.** **15674**  
On display: The MR-050 Series DryLine Dehydrators, SD-002 Series Static Dessicators, IEC connectors for HELIAX, VALUFLEX HELIAX jumper cable assemblies, and 3M Cold Shrink weather-proofing kits.  
Contact: Bobbi Rick  
10500 W. 153rd St.  
Orlando Park, IL 60462  
800-255-1479

**ASACA** **16619**  
On display: Audio analyzers, switchers, magneto optical recorder and other audio equipment.

**Aphex Systems** **3924**  
Introducing: Expander Gate Model 622, featuring Logic-Assisted Gate circuitry. Four-channel Logic-Assisted Gate Model 105, featuring VCA 1001 for pristine audio quality and high-speed performance. Easyrider four-channel compressor Model 106.  
Also: Audiophile AirChain, including the Compellor Model 320, aural exciter type C2 with Big Bottom Model 104, Dominator II Model 720 and Digidoder. Full line of professional audio processing equipment.  
Contact: Chrissy McDaniels, Sales Coord.  
11068 Randall St.  
Sun Valley, CA 91352  
818-767-2929

**Arrakis Systems** **2412**  
Introducing: MixStar consoles, including the 22,000 20- and 30-input modular consoles; the 1,200-5S compact, five-input console; 1,200-10-S 10-input console; and the 1,200-TRT four-channel turret for news/talk operation. Deskstar furniture line.  
Also: DigiLink digital audio system. TrakStar digital audio editor. 12,000 Series consoles.  
Contact: David Burns  
214 South 19th St.  
Richmond, IN 47374  
317-935-7087

**ATI** **13603-13604**  
Introducing: The Nanoamp Series of low-cost utility amplifiers, which includes expandable mixers, microphone, and line amps. Also: The MicroAmp and Encore Series of amplifiers.  
Contact: Ed Mullin  
328 W. Maple Avenue  
Horsham, PA 19044  
215-443-0330

**ASC Audio Video Corp.** **19753**  
Introducing: The Virtual Recorder, a digital random access replacement for VTRs, in combination with commercial spot insertion systems and audio workstations.

**Audi-Cord Corp.** **3926**  
On display: Full line of DL Series NAB cartridge machines, available in either mono or stereo configurations. Dual recorder reproducer for simultaneous recording or cartridge copying.  
Contact: Andy Rector  
1845 W. Hovey Ave.  
Normal, IL 61761  
309-452-9461

**Audio Accessories** **13041-13042**  
The company will show its audio panels, jacks, patch panels and cords.

**Audio Precision** **3402**  
Introducing: An improved bit-rate digital encoder/decoder testing software.  
Also: The Systems One, System One Plus DSP, and Portable One Plus.  
Contact: Tom Minter  
P.O. Box 2209  
Beaverton, OR 97075-3070  
800-231-7350

**Auditronics** **2302**  
Introducing: The Destiny 2000 on-air management console for use with hard disk storage.  
Also: The Airmaster 90 on-air console, 210 Series, and 800 series.  
Contact: Murray Shields  
3750 Old Getwell Rd.  
Memphis, TN 38118  
901-362-1350

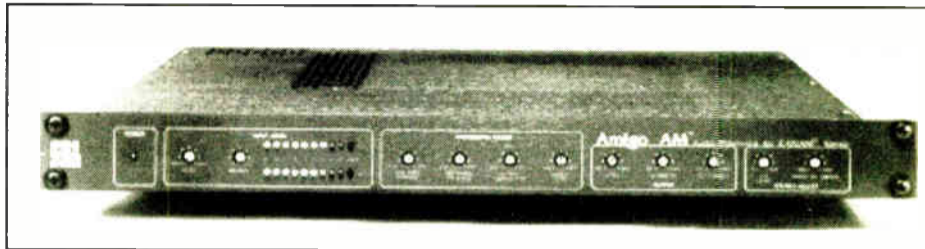

CRL's Amigo AM

**Audio Services** **4506**  
Introducing: The DK Audio MSD-550 Master Stereo Display.  
Also: The Fostex PD-2 portable DAT, and TASCAM DA-88.

**Autogram Corp.** **4520-2**  
On display: MM-8A and MM-12A low-cost 8 slide pot audio console. PM 1032, part of the Pacemaker Series of 6, 8, 10 and 16 slide pot consoles. R/TV-20 top-of-the-line slide pot audio console.  
Contact: Ernest T. Ankele Jr.  
1500 Capital Ave.  
Plano, TX 75074  
800-327-6901

**APT** **4306**  
Introducing: The Pro-link, which combines an ISDN terminal adapter with six channel I-MUX.  
Also: The DSM100 digital audio transceiver, ACE 100 Series of PC and Macintosh expansion cards, and X-console.  
Contact: Steve Cheung  
Edgewater Road  
Belfast BT3 9JQ  
Northern Ireland  
0232-371110

**AVCOM** **11607**  
Introducing: The BNG-1#00A broadband noise generator that can be used with spectrum analyzers.  
Also: The GAE-1575 GPS antenna extension.  
Contact: Charles Odom  
500 Southlake Blvd.  
Richmond, VA 23236  
804-794-2500

**Audiopak Inc.** **4018**  
On display: NAB standard continuous-loop audio carts, including A-2, AA-3 and AA-4 for the recording and broadcast of spots, jingles, announcements and music. Lubricated audio tape for use in all types of endless loop cartridges and cassettes, including Formulas 605, 613 and 614.  
Contact: Gordon Stafford  
P.O. Box 3100  
Winchester, VA 22604  
703-667-8125

**Audio Developments** **16125/16225**  
Introducing: The ADO62 and AD145 location and edit mixers. AD081 Flexi Link Systems and ADO150 Series 19-inch 1U studio rack equipment.

**BASYS Automation Systems** **19247**  
Introducing: The NetStation for Windows, a PC-based newsroom system workstation.  
Also: The D-Cart digital audio record, edit and playback system.  
Contact: Kristin Schleiter  
5 Odell Plaza  
Yonkers, NY 10701  
914-376-4800

# SEE what's NEW for FM at NAB '94

**RBDS:** We have come up with some interesting ideas on how this new technology can help your image and your profits!

**"DAVID":** Our popular FM-Stereo Processor—Generator, plus the full line of very affordable, Inovonics quality broadcast products.



OFF-AIR FM-STEREO MOD-MONITOR

The new Model 530, already in hot demand! Find out why.

## Booth 2306

### Inovonics, Inc.

1305 FAIR AVENUE — SANTA CRUZ, CA 95060  
TEL: (408) 458-0552 — FAX: (408) 458-0554



# Products & Services Showcase

For more information on the products shown below, circle the appropriate Reader Service No. (s) on the enclosed Subscription/Reader Service card or contact the advertiser directly.

## S.C.M.S., Inc. Charlotte, N.C.

Low Prices – Experienced Staff  
New and Re-built R.F. and Audio

### THIS MONTH'S SPECIAL Complete Digital Production Studio with Digital Work Station "STEALTH"

- 4 track recording/editing
- Multi built in effects and processing
- Over 1 hour record time standard
- Expandable memory/record time
- Built in mixer
- Complete with 486 CPU, SVGA monitor, keyboard, powered speakers, mike & JVC DAT machine

A complete production room for only  
\$3695.00 Less DAT only \$2985.00

Toll-Free 800-438-6040  
FAX 704-889-4540

READER SERVICE NO. 70

## A switch for the better...

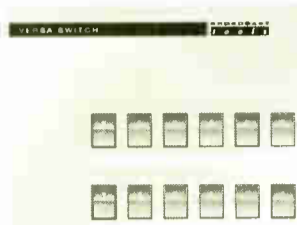

The Broadcast Tools Versa Switch is literally one dozen high quality LED lighted momentary switches, terminated on wire captive terminal strips. Remote control assorted equipment from one location!

The sloped panel desk top case is ergonomically designed and lends itself well to all environments. A rear panel opening allows for easy access to the terminal strips and the front panel write-in strips have ample space for most descriptions. LED's may be driven from a wide voltage range of 5-24 VDC.

Call us!

**BROADCAST TOOLS** 206.938.4089 VOICE•FAX•VOICE MAIL

6353 40th AVENUE SOUTHEAST, SEATTLE, WA 98136 USA

READER SERVICE NO. 1



MADE  
IN  
U.S.A.

I HAVE TO DRIVE TO  
THE TRANSMITTER?  
... AGAIN?!?!

Why drive when you can call? Using Monroe's 6000 Series Remote Controls and your telephone, two-way radio, microwave link or other audio path you can have complete control over a remote site. For over 15 years Monroe Electronics has supplied the broadcast industry with reliable and affordable DTMF remote control systems.

Let us help reduce your driving time, call Monroe Electronics today.

Distributor and Representative inquiries invited.

**ME MONROE ELECTRONICS** 800 821 6001  
716 765 2254  
LYNDONVILLE, NY 14098 FAX 716 765 9330

READER SERVICE NO. 47

## NEW! Composite Audio DA and Switcher!



### APPLICATIONS

- Switching Between Composite STL's
- Main/Alternate Processing Switching
- Feed Up to 3 Transmitters with Identical Audio
- SCA or SAP Generator Switching
- Non-Intrusive Composite Testing/Monitoring

### FEATURES

- 2 Input Switcher
- 3 Isolated Outputs
- Individual Level Control for Each Output
- Front Panel and Remote Control with Full Status
- Power Fail Memory with Bypass Mode
- Inputs Selectable for Balanced or Unbalanced Operation

**bdi**

**Broadcast Devices, Inc.**  
5 Crestview Avenue  
Peekskill, NY 10566

Tel. (914) 737-5032 FAX: (914) 736-6916

READER SERVICE NO. 48



## ZEPHYRUS

Quality, service,  
delivery, and reliability  
have come to SCPC

The Zephyrus 300 family of satellite subcarrier receivers is trusted by thousands of broadcasters.

Carrying on the tradition of excellence (at a fair price) is our 700 series analog SCPC line. Entry of all operating frequencies is done on a front-panel keypad. "Old fashioned" meters monitor RF and audio levels.

**ZEPHYRUS ELECTRONICS, Ltd.**

171 S. 122 E. Ave, Tulsa, OK 74128  
918-437-3333 Fax 918-438-7322

READER SERVICE NO. 16



## CD100 • X Compact Disc Adapter-Amplifier

Matches any consumer compact disc player or cassette deck to broadcast console input. Only \$99.00 FOB factory or from any broadcast dealer.

**Russ Friend & Associates**

342 N. Sunnyside  
Clovis, CA 93611

Phone 209-298-6838 FAX 209-298-8270

Turntable Parts/Felts  
Russco, Collins TT-200, Sparta

READER SERVICE NO. 161

## Realize the full potential of your MACKIE CR-1604

The Broadcast Tools Console Controller II allows users of a Mackie CR-1604 or virtually any MI type console to utilize many broadcast features at an incredibly low price.

- Turn mic & line inputs On/Off locally or remotely
- Switch between AIR signal and program audio
- Mute monitor speakers
- Activate ON-AIR light
- Start a Skimmer tape or cassette

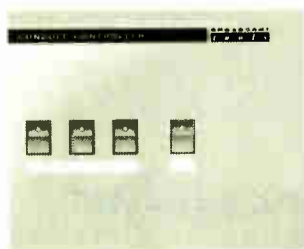

Call us!

**BROADCAST TOOLS** 206.938.4089 VOICE•FAX•VOICE MAIL

6353 40th AVENUE SOUTHEAST, SEATTLE, WA 98136 USA

READER SERVICE NO. 112

## The Power of Digital From Roland® and Audio Broadcast Group



If you're a Progressive Broadcaster ready for the power of Digital Audio workstations, you must seriously consider the Roland® DM-80. With no computer to be concerned with, the DM-80 is extremely easy to learn. It's unparalleled combination of features, speed, stability and low cost are unmatched in the industry!

Please Call Today and Feel The Power

For over 32 years

### MAIN SALES OFFICE

2342 S. Division Avenue  
Grand Rapids, Michigan 49507

Phone: 800-999-9281  
Fax: 616-452-1652

### SOUTHEASTERN SALES OFFICE

200 Fareway Drive, Suite 2  
Smithfield, North Carolina 27577

Phone: 800-369-7623  
Fax: 919-934-8120

### WESTERN SALES OFFICE

P.O. Box 1638  
Palmdale, California 93550

Phone: 800-858-9008  
Fax: 800-273-3321



**AUDIO BROADCAST GROUP**

READER SERVICE NO. 52

**Belar 2508**  
Introducing: A new digital FM stereo monitor analyzer.  
Also: The Wizard modulation monitor and company's established line of products.  
Contact: David Hirsch  
119 Lancaster Avenue, P.O. Box 76  
Devon, PA 19333-0076  
610-687-5550

**Benchmark Media Systems 11059**  
On display: The Jr. Audio Director Plus, an eight-input, two-output monitoring device; RGM-10 remote gain and metering control, AudioWorld Interface, MDA-101PA microphone preamp, DA-102M and DA-111 and DA-112 stereo distribution amplifiers.  
Contact: Rory Rall  
5925 Court Street Road  
Syracuse, N.Y. 13206-1707  
315-437-6300

**BEXT 2414**  
Introducing: The SF Series of solid state MOSFET FM amplifiers from 100 to 1000 watts, and the LEX 25 programmable FM exciter.  
Also: The line of FM amplifiers and STLs.  
Contact: Dennis Pieri  
739 Fifth Avenue  
San Diego, CA 92101  
619-239-8462

**beyerdynamic Inc. 11315**  
Introducing: DT 190 sportscaster headset/microphone combo. DT 150 monitoring headphone. MC 834 large diaphragm condenser microphone for on-air voice work. MEM 86 set shotgun microphone system. MCE 50 Series miniature clip-on microphones. M424 control room talk-back microphone. VHF and UHF wireless microphone systems. NE 700 TE2 two-channel diversity receiver.

**Broadcast Programming 1424-1425**  
Introducing: Digital AC Christian format on CD; Chartbreakers, monthly CD service; DigitaLease, package of digital automation equipment, researched formats and all necessary CDs to allow a station to become digital in one step at one price.

**Bradley Broadcast 4002**  
On display: The Telos Zephyr digital transceiver that uses ISDN lines, and the Telos One-x-Six Talk Show System, a digital hybrid six-line phone console system. Other products will include Digidesign's Session 8 digital studio and the Audioarts line of broadcast mixing consoles.

**Broadcast Electronics 3424**  
Introducing: The FM-3C 3 kW solid state FM transmitter, the D.A. Box digital audio storage system and the AV-100 networked digital audio storage system.  
Also: The FM-1C 1 kW solid state FM transmitter; FM-30B 30 kW FM transmitter; AM-5 5 kW AM transmitter; RBDS; MT-90 12-channel console; AT-90 12-channel console; AV-100 digital audio storage system; CORE automation system; Sentry automation system and VMC-16 voice remote control system.  
Contact: Kim Winking  
4100 N. 24th St.  
Quincy, IL 62301  
217-224-9600

**Broadcast Marketing International 19328-19329**  
New products to be displayed are: Kobold ENG 200 compact lighting system and Noriyuki time code equipment.

**Broadcast Supply Worldwide 4820**  
On display: The Arrakis DigiLink and TrakStar systems as well as the KORG and DigiDesign digital workstations.  
Contact: Tim Schwiager  
7012 27th Street West  
Tacoma, WA 98466  
800-426-8434

**Burk Technology 4818**  
Introducing: Software options for the ARC 16 transmitter remote control system.  
Also: The LX-1 six-input stereo selector.  
Contact: Phil Halter  
7 Lomar Drive  
Pepperell, MA 01463  
508-433-8877

**Cablewave Systems Inc. 15753**  
Introducing: Cablewave broadcast antenna pattern computer software for pattern viewing with database of product information. N and 7/16 DIN series cable connectors with improved water blocking design.  
Also: Flexwell air and foam coaxial cables. Cablewave BU series of side-mount and top-mount broadcast antennas. Rigid line coaxial cables. CP-1000 and HP-1000 FM antennas.

**California Amplifier 15383-5**  
Contact: Tom Ellsworth  
460 Calle San Pablo  
Camarillo, CA 93012  
805-987-9000

**Capitol/OGM Production Music 12905**  
On display: A full line of production music for contemporary markets including the new Archives line.

**CBSI 1624**  
Introducing: Broadcast accounting and traffic department software including Design Financial reports, Custom Reports and PowerPlus. Also: The Classic and Elite Traffic and Billing systems, as well as the InterAcct. software.

**CCA 4220**  
On display: The full line of AM, FM and shortwave broadcast transmitters as well as company's 60 watt FM exciter.  
Contact: Steve McElroy  
360 Bohannon Road  
P.O. Box 426  
Fairburn, GA 30213  
404-964-3530

**Central Tower 1906**  
On display: Antenna support towers, guyed towers and welded sections.

**Clark Wire & Cable 19537-8**  
Introducing: Clark 1300 Series audio snakes. Hannay cable reels.  
Also: Bulk audio and video cable and connectors. Remote composite cables, patchbays and terminated reels. OEM custom terminated cable assemblies and harnesses.  
Contact: Julie Clark  
151 S. Pflugsten Rd., #B  
Deerfield, IL 60062  
708-272-9889

**Clear-Com Intercom Systems 18015**  
On display: AMS-1022 stereo audio monitor. Wired and wireless two, four, eight and 12 channel partyline intercom systems. Pro-40 lightweight headset product line. Matrix Plus II digital 100x100 central matrix intercom system.

**CRL 3015**  
On display: The DAA-50 digital audio analyzer, a digital audio interface tool for analysis and decoding of AES/EBU and consumer digital audio signals. Other products include RBDS-SC-100 generator and the Real Time Event Sequencer.

**Coaxial Dynamics Inc. 5116**  
Contact: John R. Ittel  
15210 Industrial Pkwy.  
Cleveland, OH 44135  
216-267-2233

**Cole Wire and Cable 10759 & 10859**  
On display: Cable and wire for audio and video. High voltage transmitter cable.

**Comark 16113**  
On display: IOX TV transmitter lines, IOT and the S Series transmitters.

**Communications Data Services 4019**  
On display: Data and computer applications for radio and GIS industries.

**Comtech 13402-13403**  
Introducing: The EC8 microprocessor control system with optional IBM compatible software for control of the company's line of satellite antenna systems.

# How to tame transmitter power problems.

## WHR Series STABILINE® Voltage Regulators for AC power systems up to 660 volts.

Transmitters placed in remote, unattended locations such as mountain tops and wilderness areas depend on long utility power lines for service. Unfortunately, the lines often produce poor voltage regulation and other damaging power aberrations. Poor regulation can reduce power tube life by as much as 70% and the performance of associated equipment is similarly affected.

For example, a 15% undervoltage can decrease power tube life because cold operation promotes contaminant buildup in the tube. Conversely, a 10% overvoltage decreases life because increased temperature accelerates the decarburizing process.

The problems can be easily corrected.

Cost-effective WHR Series STABILINE® Voltage Regulators are the preferred choice of broadcasters worldwide for use with transmitters, receiving stations, studios and mobile production vehicles. These high power voltage regulators maintain constant voltage to your sensitive equipment even when the power line input voltage and system load vary widely.

### Features include:

- Hold output voltage within ±1%
- Power ratings from 2 to 1680 kVA

- Maintenance bypass plus other standard options
- 99% typical efficiency
- High overload capacity
- 19-inch rack mount versions
- Designed for UL and CSA approvals

A host of options allow you to customize your application.

### Standard options include:

- Single or three phase models
- Analog or digital control
- Bypass switch
- Ammeters
- Frequency trip meter
- Tropicalization
- Manual raise-lower switches
- Zig-zag neutral generation
- Single or individual phase control
- High energy transient suppression
- Input voltage range alarm contacts



For Catalog WHR692 and to learn how WHR Series STABILINE® Voltage Regulators can be the solution to your power problems, write, fax or phone Ted Gladis at

**1-800-446-6161**

**SUPERIOR ELECTRIC**  
WARNER ELECTRIC

383 Middle Street • Bristol, CT 06010  
203/582-9561 • Fax: 203/582-3784



"Our production vehicles don't leave without one."  
— Ron Crockett, SHOOK ELECTRONICS

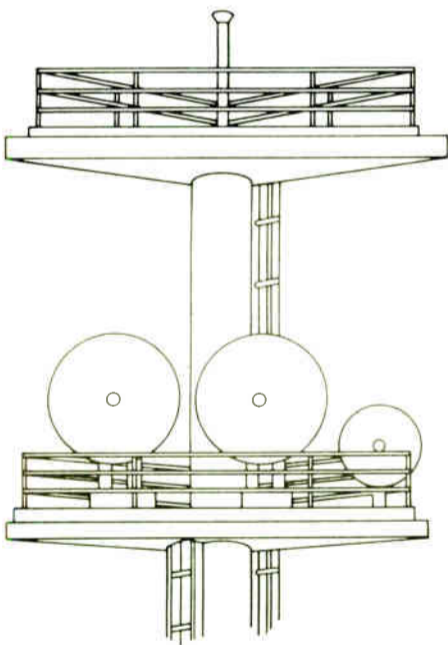
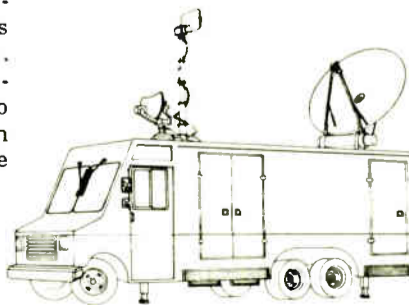

"I recommend STABILINE® Voltage Regulators for any brand of transmitter that is being placed in a harsh operating environment."  
— Steve McElroy, CCA ELECTRONICS

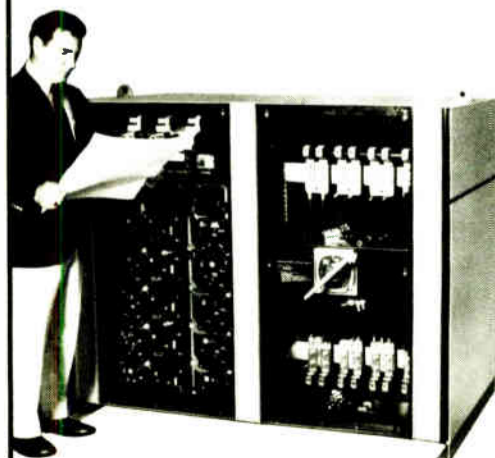

3-phase, 500 kVA WHR Series Voltage Regulator

# Products & Services Showcase

For more information on the products shown below, circle the appropriate Reader Service No. (s) on the enclosed Subscription/Reader Service card or contact the advertiser directly.

**SOUND YOUR BEST ON THE AIR!**

**CART MACHINE SERVICES:**  
**CART MOTORS REBUILT** to quiet flutter-free perfection-shafts resurfaced  
 Single \$120.00 Triple \$140.00

**CART HEADS RELAPPED** guaranteed to perform like new  
 Same day turnaround  
 Replacement heads and motors available

**REEL TO REEL SERVICES:**  
**HEADS RELAPPED** and precise digital/optical  
**ASSEMBLY ALIGNMENTS** performed for maximum response & head life

**CAPISTAN & REEL MOTORS REBUILT** for MCI, OTARI and more

For peak performance from your recording equipment, call The Audio Magnetic Professionals

**AMP SERVICES**

224 Datura Street, Suite 614, West Palm Beach, FL 33401  
 Call 1-800-826-0601 for "Same Day Service" in Florida (407) 659-4805  
 Authorized Parts Dealers for: MCI • OTARI • TEAC/TASCAM

**READER SERVICE NO. 158**

**DON'T GAMBLE WITH LIGHTNING!**

**STAT-CAT**

**BOOTH 3704**

ELEVEN YEARS EXPERIENCE PROVIDING AFFORDABLE TOWER LIGHTNING PROTECTION TO THE BROADCAST INDUSTRY.

**Coran Corporation**

Write to us today for a **FREE** brochure!  
 P.O. Box 2548, Farmington, N.M. 87499  
 Call (505) 325-5336 FAX (505) 326-2337

**READER SERVICE NO. 142**

**TAPECASTER®**  
**X-701 Series Cart Machine**



**1/2 Price With Trade-In\***  
**Limited Time — Call Now!**

**TAPECASTER, INC.**  
 7174A 302 Industrial Dr.  
 Southaven, MS 38671  
**Tel: 1-601-349-2881 • Fax: 1-601-349-2882**  
**Toll Free: 1-800-638-0977**  
 \*Some restrictions apply

**READER SERVICE NO. 124**

**Introducing (ta-da)**  
**The Jr. Audio Director Plus™!**  
 It's an 8 input to 2 output ON LINE or monitoring device.

**\$550**



The new Benchmark Jr. Audio Director Plus™ brings more to the party! It brings more control and selection features, and a stereo headphone amplifier, along with the performance and value that are traditionally a Benchmark for the industry.

In a half wide, 1RU high chassis, the Jr. Plus has two input switch banks which allow left and right outputs to select between eight sources. Additional switches provide a Mono Mix, with adjustable gain reduction of 3 to 6 dB, and a Right Channel Polarity reversal. LEDs indicate switch action. Inputs may be passively mixed ahead of the input amp by depressing two or more buttons.

Installation is "instant" with a No-Mod™ Rack Mount adapter and plugable Euro-Style barrier strips.

**Benchmark**  
 the measure of excellence

**BENCHMARK MEDIA SYSTEMS, INC.**  
 Phone 800-262-4675, or 315-437-6300, FAX 315-437-8119

**READER SERVICE NO. 188**

**Finally!**  
**An affordable routing switcher.**

- 6 balanced stereo inputs/outputs
- Front panel electronically interlocked switches
- Remote control via 25-pin D-type connector
- Status display on front panel switches
- Audio connections via wire captive terminal strips



**Applications**

- Console input expander
- Studio switcher
- Source equipment input/output selection
- Composite/SCA audio switching
- Remote control studio and EBS operation

**6 x 1 Stereo Routing Switcher with front panel and remote control for around \$399.00**

**Call us!**

**BROADCAST tools** 206.938.4089 VOICE•FAX•VOICE MAIL  
 6353 40th AVENUE SOUTHEAST SEATTLE WA 98136 USA

**READER SERVICE NO. 204**

**ARE YOU LOOKING FOR A COST EFFECTIVE ALTERNATIVE TO MANUFACTURER SERVICE?**

**SERVICE, REPAIR & CALIBRATION**

- STL's • RPU's • TSL's
- Exciters • AM/FM
- Broadcast Monitors • Remote Control Systems

**SPECIALIZING IN EQUIPMENT BY**

- Belar • Marti • Moseley • McMartin
- TFT • And others...

An authorized TFT service center

**IN CASE OF EMERGENCY**

We can help get you back on the air with our STL Loaner Program. We have STL's available that will be set to your frequency prior to shipping. We also provide over-the-phone technical assistance.

**TECHNICAL SERVICE**

2198 Hubbard Lane, Grants Pass, OR 97527

**(503) 471-2262**

**READER SERVICE NO. 181**

**GPS MASTER CLOCK/TIME CODE GENERATOR**  
**WORLDWIDE TIME**

Locked to the Atomic Clock in the Global Positioning Satellite System, you can have time, date and time code within nanoseconds of UTC, anywhere in the world!!

**ES-185** **\$2495.00**



**STANDARD FEATURES INCLUDE:**

- SMPTE/EBU, ESE, IRIG-B & ASCII Time Code Outputs
- 1PPS Output
- 6 Satellite Tracking
- Battery Back-up
- GPS Locked Indicator
- Automatic Daylight Savings Time Correction
- Time Zone Offset
- Antenna
- AND MORE!!

**OPTIONAL FEATURES INCLUDE:**

- Parallel BCD Output
- 1 KPPS
- 10-MHz Output
- 220 VAC
- 12 VDC
- Video Inserter
- Video Sync-Generator

**3 YEAR WARRANTY**

142 Sierra St., El Segundo, CA 90245 • **(310) 322-2136 FAX: (310) 322-8127**

**READER SERVICE NO. 116**

**Comrex** 12206  
 Introducing: 20 kHz mono/stereo digital audio codecs, DX-100 apt-X, Model DX-200, DX-210, DX-230, and DX-240.  
 Also: Established lines including 7.5 kHz digital audio codecs.  
 Contact: Lynn Distler  
 65 Nonset Path  
 Acton, MA 01720

**Connectronics** 13628  
 On display: Line of audio and video cables including JB9600 Easy-Wired TT Patchbays and XB range of modular patchbays.



Crown's CM-312

**Continental** 3418  
 On display: Full line of broadcast transmitters and other RF equipment. New product information was not available at presstime.  
 Contact: Steve Claterbaugh  
 P.O. Box 270879  
 Dallas, TX 75227  
 214-381-4949

**Corporate Computer Systems (CCS)** 4826  
 Introducing: The CDQ2001 MUSICAM codec, an enhanced version of the CDQ2000, with 18 bit A/D converter.  
 Also: The CDQ1000, CDQ2000 and the PACE MUSICAM digital audio editor.  
 Contact: Doreen Avleth  
 33 West Main St.  
 Holmdel, N.J. 07733  
 908-946-7167

**Comstream** 4000  
 Introducing: A desktop version of its ABR75B satellite digital audio receiver that is suited for business music applications.  
 Also: The ABR 200 and ABR75/75B integrated receivers.

**Cortana** 3704  
 On display: Stati-Cat lightning prevention system.  
 Contact: David Stockmar  
 P.O. Box 2548  
 Farmington, NM 87499  
 505-325-5336

**Crown International Inc.** 4400-3  
 Introducing: CM-312 head-worn microphone.  
 Also: Line of Crown microphones and amplifiers for broadcast purposes.  
 Contact: Bob Herrold  
 1718 W. Mishawaka Rd.  
 Elkhart, IN 46517  
 219-294-8000

**CTE International Srl**  
 Contact: Enrico Antoniazzi, Comm. Dept. Mgr.  
 Via R. Sevardi, 7  
 42010 Mancasale  
 Reggio Emilia, Italy  
 39-522-516660

**Cutting Edge Technologies** 5200  
 Introducing: New Unity Remote Software, Unity AM processor and will demonstrate the Unity 2000i FM processor. The new VIP-voice processor also will be shown as will the Dividend Composite Filter.  
 Contact: Danielle Cline  
 2101 Superior Avenue  
 Cleveland, OH 44114  
 216-241-3343



**Dalet** 3803  
 Introducing: Ednews news editing software. Traffic scheduling system.  
 Also: Cart replacement, satellite automation, non-destructive audio editing and walk-away music automation digital audio systems.

**Dataworld Inc.** 1918  
 Introducing: Customized maps, including international.  
 Also: AM, FM, TV, LPTV and wireless cable databases. Customized maps, directories, allocation and interference studies. Population counting. FCC Flag service. Terrain elevation retrieval. FM and TV area-to-locate studies. AM daytime and nighttime channel studies. Unused call-sign listings.  
 Contact: Jack Neff  
 4827 Rugby Ave., Ste. 200  
 Bethesda, MD 20814  
 301-652-8822

**Dawn Satellite Inc.** 17779  
 Contact: Rose Prete  
 1190 S. Lapeer Rd., Ste. 100  
 Oxford, MI 48371  
 313-969-0010

**DB Elettronica** TBD  
 On display: TD4/16 and RD4/16 16-bit digital decoders. Vivaldi digital stereo coder. PE 21 FM exciter for new analog and digital audio processors. PM 100/PM 250 FM exciter. KN 500/KN 1000 FM solid state amplifier. DCV Series STL translator.

**Delta Electronics** TBD  
 On display: The Delta Splatter Monitor, as well as the ASE-2 AM stereo exciter, ASM-1 AM stereo monitor, OIB-1, OIB-3, and CPB-1,1A impedance bridges, RG-4 receiver/generator, TCA RF ammeters, 6730E, 6740B transfer switches, AAM-1 analog antenna monitor and PRH-1 high power pulse reflectometer.  
 Contact: Joseph S. Novak  
 Delta Electronics  
 5730 General Washington Dr.  
 Alexandria, VA 22312  
 703-354-3350

**Denon America** 4303-4  
 Contact: Michael Stelts  
 222 New Rd.  
 Parsippany, NJ 07054  
 201-882-7460

**DIC Digital** 19183  
 Introducing: Beta Cam SP metal particle tapes.  
 Also: HQ DAT cassette for multipurpose applications and live recording. Digital MQ Series studio two-pack for safe DAT cassette storage and transportation. CD-R recordable CD, available in 18-, 63- and 74-minute recording times. CR-4000 4mm/DAT and CR-8000 8mm dry, non-abrasive cleaning system. Complete line of DAT tape. Professional MQ Series and HQ Series  
 Contact: Rich Mancuso  
 500 Frank W. Burr Blvd.  
 Teaneck, NJ 07666  
 201-692-7700

**Dielectric Communications** 15719  
 Introducing: digiTLine-broadband rigid transmission line designed to transmit any VHF, FM or UHF frequency with extremely low VSWR. Improved DCR-M quadrapole antenna-broadband FM antenna with low VSWR bandwidth in excess of 10 MHz.  
 Also: TDM, TCL and TUP television broadcast antennas. DCR-C C.P. FM antenna. Model 200B automatic dehydrator for pressurization of broadcast feedlines. 50000 Series RF switches. 5000 Series oil load and 4000 Series dry load. 7000 series calorimeter.  
 Contact: Jay S. Martin  
 P.O. Box 949  
 Raymond, ME 04071  
 207-655-4555

**Dolby Laboratories Inc.** 1620  
 Introducing: Four-channel DSTL® digital aural STL system. AC-3 digital audio coding. DP521 codec for AC-3 coding. DP501 codec for AC-2 coding.  
 Also: Model 740 Spectral Processor. Dolby SR professional noise reduction. Dolby Surround. Dolby film sound products.  
 Contact: Kevinn Tam  
 100 Potrero Ave.  
 San Francisco, CA 94103  
 415-558-0200

**Dorough Electronics** 18815  
 On display: Audio Level Meters. Stereo Signal Test Model 1200.

**Econco** 2210  
 On display: Rebuilt power tubes and klystrons for radio and TV transmitters.  
 Contact: Debbie Baker  
 1318 Commerce Ave.  
 Woodland, CA 95776  
 800-532-6626

You  
 Won't  
 Want  
 To  
 Miss It

HARRIS  
 ALLIED

Perfect Bob. Perfect Judy.



Push Here.

The programmable 601 Digital Voice Processor.  
 Pushbutton perfection for every on-air voice.

206.282.2555 800.288.8855

- 128 User Programs
- De-essing
- Parametric EQ
- Compression • Limiting
- Automatic Gain Control (AGC)
- Dynamic Noise Reduction
- Downward Expansion
- Echo • Doubling • Modulation



**Electronics Research Inc.** 3212  
On display: Side mount FM antennas. Master, multi-station antennas, filters and combiners in medium and high power configurations. Master antenna remote monitoring and reporting equipment. Lambda™ antenna mounting systems. Antenna support towers and structural engineering services. Turn-key construction and emergency repair services.  
Contact: David Davies  
108 Market Street  
Newburgh, IN 47630  
812-853-3318

**Energetic Music Inc.** 3921  
Introducing: EZ-1 Easy Listening #1, light "middle of the road" background music. Jewish Party Music volumes I & II, music for Bar and Bat Mitzvahs, weddings, anniversaries, Horas and folk dancing. 427 Sound Effects library.  
Also: Energetic Music Buy-Out Library.  
Contact: Monty Smith  
P.O. Box 84583  
Seattle, WA 98124  
800-323-2972

**ENCO Systems Inc.** 5121-5122  
On display: DAD486x digital audio delivery system.  
Contact: Larry Lamoray  
1866 Craigshire Dr.  
St. Louis, MO 63146  
314-453-0060

**Eventide Inc.** 4809-10  
Introducing: H3000-D/SX Studio Dynamic Ultra-Harmonizer. H3000-D/SE Studio Enhanced Dynamic Ultra-Harmonizer with new 3D speaker-based spatial imaging effects.  
Also: DSP4000 Ultra-Harmonizer. VR240 digital broadcast logger. BD980 broadcast delay.  
Contact: Gil Griffith  
One Asian Way  
Little Ferry, NJ 07643  
201-641-1200

**Electro-Voice** 15716  
On display: RE27N/D microphone. a professional quality dynamic cardioid mic. RE36N/D microphone for broadcast applications. S-40 compact monitor system.

**Energy-Onix** 5408-5410  
Introducing: New line of transmitters.  
Also: SSA/SST Series of low power solid state FM transmitters. Legend Series of medium power solid state FM transmitters. MK Series of grounded grid triode tube FM transmitters. AM and shortwave transmitters.  
Contact: Ernie Belanger  
752 Warren St.  
Hudson, NY 12534  
518-828-1690

**ESE** 12808-12809  
Introducing: ES-185 GPS master clock/time code generator. ES-2940 dual 1x4 and video distribution amplifiers and a five output black burst generator. ES-195 GVG master 21 interface/master calendar. New LUX-Line product family.  
Also: master clock systems, clocks and timers. Time code products. Audio and video distribution amplifiers. Audio level indicators and interfaces.  
Contact: Brian Way  
142 Sierra St.  
El Segundo, CA 90245  
310-322-2136

**Elenos SRL** 1024  
On display: SF series amplifiers based on MOSFET solid state technology. Range of radio broadcasting products including FM power amplifiers, exciters, radio links, filters combiners, aeriels, remote control RF diagnostics.

**f.g**

**FM Systems** 19528  
Introducing: ALM 771 audio level master.  
Also: AVM audio volume meter. AMM audio modulation meter.

**Faraday Technology Ltd.** 19123-19124  
On display: Video filters. Video delay lines. Cable Clone for testing integrity of serial digital signals.

**Fidelipac Corp.** 1920  
On display: Air Marshal digital hard disk system. MX E Series console. Dynamax SRC digital audio sample rate converter.  
Contact: Bob McNeill  
97 Foster Rd.  
Moorestown, NJ 08057  
609-235-3900

**Focal Press** 13404-13405  
On display: Books about broadcasting.

**Fostex** 19185  
Contact: David Oren  
15431 Blackburn Ave.  
Norwalk, CA 90650  
310-921-1112

**FRESH/The Music Library** 2000  
On display: TBA

**Garner Industries** 13622-13623  
Introducing: Model CF 750 Type II/IIA extended range degausser.  
Also: Line of tape erasers for all formats.

**Gentner Communications Corp.** 2612  
Introducing: G2500 and G3200 telephone Superhybrids. TC-101 telephone interface. ET-100 Personal Teleconferencer.  
Also: Line of telephone interface products including couplers, hybrids, call directors and audio bandwidth extenders. VRC-2000 remote control system. Audio routing and distribution products. On-air audio processing equipment. Teleconferencing products and services. Assistive Listening System for ADA compliance in public buildings.  
Contact: Elaine Jones  
1825 Research Way  
Salt Lake City, UT 84119  
801-975-7200

**Gorman Redlich Mfg. Co.** 4812  
On display: Off-site EBS monitor. Models CM and CMR digital antenna monitor. Model CEB EBS encoder-decoder.  
Contact: James T. Gorman  
257 W. Union St.  
Athens, OH 45701  
614-593-3150

**Graham-Patten Systems Inc.** 11551  
On display: D/ESAM® 800 and D/ESAM 400 digital edit suite audio mixers.

**h,i,j**

**Halland Broadcast Services Inc.** 3700  
Introducing: Halland's Country Hits CD music library. The Nineties AC/CHR library update.  
Also: The Seventies AC/Gold CD library. Rock 'n' Roll Graffiti Oldies library. The Eighties Plus AC/CHR library.  
Contact: Steve Steinberg  
1289 East Alosta Ave.  
Glendora, CA 91740  
818-963-6300

**Hallikainen & Friends** 1712  
Introducing: DRC200 transmitter control system software update. Election Central software.  
Also: DRC190 transmitter control system. TEL 171 digital telemetry adaptor. ITO178 board and software for controlling a Moseley TRC-15A with a TEL 171. TVA series of audio mixers.  
Contact: Harold Hallikainen  
141 Suburban Road, Building E4  
San Luis Obispo, CA 93401-7590

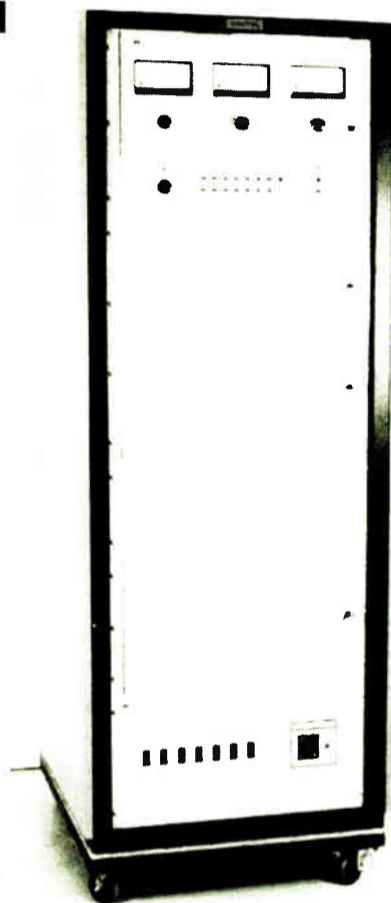

NAB BOOTH 1912

## INTRODUCING NAUTEL NE50

## DIGITAL FM EXCITER

AND FEATURING  
SOLID STATE AM & FM TRANSMITTERS  
FM 4 KW, 7 KW, & 10KW  
AM 1 KW TO 100 KW & HIGHER

The new NAUTEL NE50 Digital FM Exciter will further enhance the performance advantage of solid state NAUTEL FM Transmitters.

The Exciter uses Direct Digital Synthesis (DDS) to generate the modulated FM carrier. This produces a signal of exceptional spectral purity and CD quality audio fidelity which does not degrade over time.

Designed for tomorrow's direct digital input, the NAUTEL NE50 accepts today's composite, mono and SCA inputs using a revolutionary A to D technique with ultra low distortion and noise.

Phone (902) 823-2233 Canada FAX: (902) 823-3182

### NAUTEL

Nautical Electronic Laboratories Limited  
RR#1 Tantallon, Halifax County  
Nova Scotia, Canada B0J 3J0

Nautel Maine Inc.  
201 Target Industrial Circle  
Bangor, Maine 04401 U.S.A.





**Harris Allied** 2218  
 Introducing: Harris Quest 1 FM transmitter. AIRcart digital cart machine. Audisk. Cylind S-Band spread spectrum modems. ENCO DAD486x digital audio delivery system. Gentner telephone hybrids. Mini Disc recorders/players. nVision digital interface products. Orban DSE-7000. RE America digital audio codecs.  
 Also: Harris Platinum Series® PT 10FM transmitter. Digit™ digital FM exciter. Harris DX 10 and DX 100 digital solid state MW transmitters. Harris AMS-G1 C-QUAM® stereo exciter. Harris HT 10FM and HT 35FM FM transmitters. Audio-Metrics CD-10 CD cart player. Tascam DA-88. Roland DM-80. Auditorics consoles. RE America RDS/RBDS equipment. Harris Allied radio studio systems.  
 Contact: Martha Rapp  
 3200 Wisnann Lane  
 P.O. Box 4290  
 Quincy, IL 62305-4290  
 217-222-8200

**Henry Engineering** 3700  
 Introducing: Fast Trac II voice-over audio workstation. Stereoswitch three-input stereo line switcher.  
 Also: Matchbox. Telephone Information System. USDA. Twinmatch. Micromixer. Logiconverter. MixMinus-Plus. Superelay.  
 Contact: Hank Landsberg  
 503 Key Vista Drive  
 Sierra Madre, CA 91024  
 818-355-3656

**HHB Communications** 1403  
 Introducing: New recording media product and an addition to the company's CEDAR range of audio restoration products, among other new products.  
 Also: The PORTADAT range of portable DAT recorders, featuring 4-head, 4-motor transports derived from DDS technology. The advanced media products range of HHB DAT tape, and the CEDAR DC-1 de-clicker, the CR-1 de-crackler, featuring buzz removal and distortion reduction as well as the CEDAR II production system. The HHB CDR Indexer, and the ATC range of studio control monitors and the Coles line of mics.

**Holiday Industries Inc.** 3920  
 On display: RF and MW instrumentation and EMF meters.  
 Contact: Michael Leighton  
 14825 Martin Dr.  
 Eden Prairie, MN 55344  
 612-934-4920

**IDB Broadcast** 5226 & 5227  
 On display: Information on company's 15 kHz Switched 56 Digital Sports Interconnect Transmission services. Also 3D2 - direct digital audio, high quality audio transmissions for recording studios.

**Inovonics** 2306 - 2308  
 Introducing: Operational RBDS display.  
 Also: Line of audio recording, signal processing and instrumentation equipment for broadcast, including the Model 530 FM modulation monitor, "Sentinel" all-mode diagnostic receiver, and "David" FM processor/stereo coder.  
 Contact: Jim Wood  
 1305 Fair Ave.  
 Santa Cruz, CA 95060  
 408-458-0552

**Intraplex Inc.** 5118  
 Introducing: The PT 350 and PR 350 are program audio transmitter and receiver modules that transmit in 16-bit linear uncompressed format. The Intralink STL+ is a fully integrated STL package for transmitting high quality, uncompressed linear stereo audio over T1 lines.  
 Also: Line of high speed digital communications equipment.

**International E-Z Up** 5212-5213  
 On display: World's Fastest Shelter free-standing canopy. Instant Shelter canopy.

**International Tapetronics Corp.** 1218  
 Introducing: A series of enhancements to company's DigiCenter digital audio management system, including DigiCenter-EDITOR, an integrated multitrack waveform production editor operating on a workstation; DigiCenter-NEWS, a networked array of workstations offering collection, editing and management of both audio and text information for news applications; DigiCenter-PLUS, expanded networking capabilities for background file transfers, backups and maintenance, and the DigiCenter-LITE, a low-cost entry level system in a computer tower hardware platform.  
 Also: The DigiCenter audio management system; digital program repeater, a solid state, full bandwidth mono recorder and reproducer; audio routing switcher with adjustable input levels, mono/stereo switching, various remote controls and RS 232/422 control; ITC Cart II cartridge machine, as well as the Delta and Series 99 cart machines and the ESL V, and Series 1 and 2 cart machines. ITC will offer remanufactured versions of all varieties of its cart machine line.  
 Contact: Charlie Bates  
 2425 South Main St.  
 Bloomington, IL 61704  
 309-828-1381

**ITELCO S.p.A.** 19414  
 Introducing: New FM exciter-transceiver with output power from 100 W to 250 W. MOSFET amplifier, automatic power control built-in switched power supply and plug-in construction.

**JBL Professional** 15713  
 introducing: MPA series amplifiers. SR6670A power amplifiers.  
 Also: 4400A series studio monitors. Models 4206 and 4208 studio monitors.

**J.N.S. Electronics Inc.** 2306 - 2308  
 On display: Digital audio program transmission equipment, including the D-Mux 500 series, a stereo or mono audio multiplexing systems using 16-bit technology for multiple 15 kHz, 7.5 kHz, or 3 kHz audio feeds, and the RFL-700 Series 1.5 to 2.3 GHz digital microwave link for D-Mux. Modular rack frames, including the 8000 Series "the Frame" modules for audio and video amplification and distribution, monitoring, switching, audio test, RF demodulation, off-air reception and program changeover functions. Audio routing systems, including the 8300 Series stereo to 100 X 1 and the 9000 Series, mono/stereo to over 100 X 100.  
 Contact: John Leonard  
 P.O. Box 325000  
 San Jose, CA 95125  
 408-729-3838

**Jampro Antennas Inc.** 1915  
 Introducing: JCPD flat panel circularly polarized antenna. JADP cavity backed panel antenna. JIDC inter-digital combiner. JIDF inter-digital filter.  
 Also: Penetrator series of FM antennas.  
 Contact: Marlene D. Young  
 6340 Sky Creek Dr.  
 Sacramento, CA 95828  
 916-383-1177

**Jefferson Pilot Data Services Inc.** 13811  
 On display: JDS 2000/1000 broadcast management system that interfaces with traffic, billing, accounts and sales; BIAS, on-line integrated traffic sales, management and general accounting system; SALESLINE, sales management linking sales to traffic and accounting, and PC SESAMI, a PC-based avail system that provides proposals and research information.

**k,l**

**Kintronic Laboratories, Inc.** 4824  
 On display: AM/MW antenna matching networks. HF open wire transmission line switch. HF balun. HF open wire feedline. HF feedthrough panel. AM/MW multiplexed antenna systems and tuning units. Air-cooled dummy loads. AM/MW directional antenna phasing system. Open frame and vacuum RF contractors. Rigid transmission line. RF patch panels. Equipment racks. Isocouplers. Fixed and variable inductors. Meter jacks and plugs. Coaxial cable clamps. Static drain chokes. Lighting chokes.  
 Contact: Tom King  
 P.O. Box 845  
 Bristol, TN 37621-0845  
 615-878-3141

**Klark Teknik** 2412  
 Introducing: DN3600 programmable graphic equalizer, a digitally controlled analog unit includes two special function keys that allow user to alternate between an EQ curve, relative fader position for channel A or B, or a combination.

Your Listeners Are Ready For RDS/RBDS... Are You?

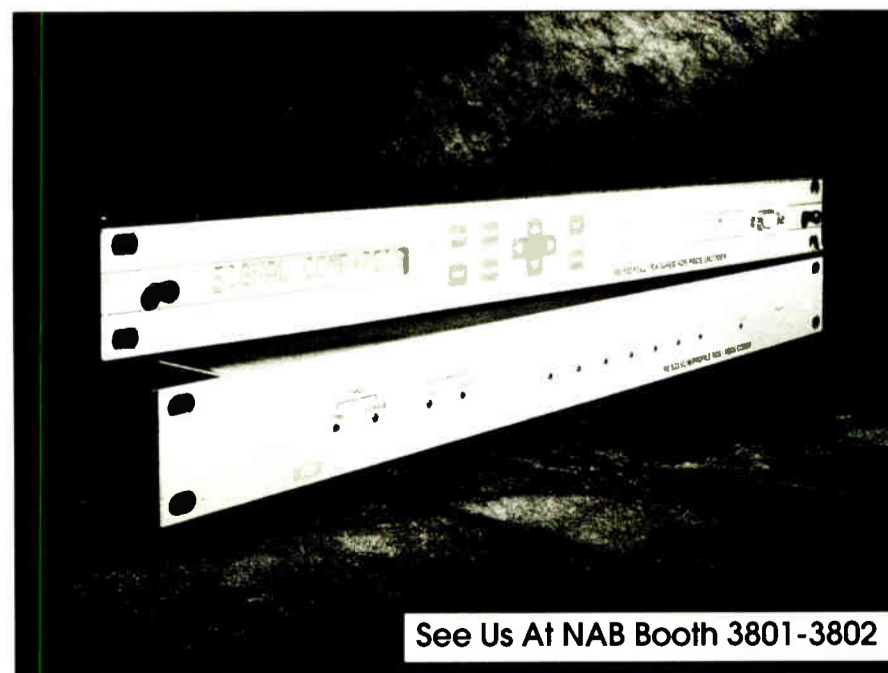

See Us At NAB Booth 3801-3802

Available through: ▲ Broadcasters General Store ▲ Harris Allied ▲ RF Specialties

This year, RDS/RBDS consumer radios are being purchased by your listening audience, which means the time is right to pursue the revenue opportunities RDS/RBDS has to offer.

RE AMERICA continues its tradition as the leader in RDS/RBDS technology, now with a family of products. Whether you choose the RE 533 for single-user datacasting or the RE 532 for multi-user datacasting, RE has the right encoder to meet your budget and operational needs.

RE takes the risk out of choosing an RDS/RBDS encoder by employing flashprom technology in both the RE 533 and the RE 532. Future upgrades and enhancements are simply downloaded via disc software available from RE. You make the choice, the RE family has got you covered.



RE AMERICA, INC.  
 31029 Center Ridge Rd.  
 Westlake, Ohio 44145  
 Phone: (216) 871-7617 ▲ Fax: (216) 871-4303

**Korg** Las Vegas Hilton—BSW 4820  
 Introducing: Version 4 software for the SoundLink digital audio workstation & EDL Auto conform software.

**Logitek Electronic Systems Inc.** 3215  
 Introducing: Super-VU precision bargraph audio meter with simultaneous display of loudness and peak levels with selectable functions including peak and maximum hold phase density and sum display; Crossfire II four-channel automated mixer, local or remote control levels and crossfades as well as RS 232/422 computer port; Serial Sound SS-SRC sample rate converter that accepts AES/EBU or S/PDIF data at ±50 percent of output sample rate.  
 Also: On-air modular console with frame sizes that hold 6, 12 or 22 mixers. Mixer modules feature DCA faders. Optional RS-232 control.  
 Contact: Tag Borland  
 3320 Bering Dr.  
 Houston, TX 77057  
 800-231-5870

Only  
 Harris  
 Allied  
 Has  
 One



OVER  
5 MINUTES  
OF 15KHZ STEREO AUDIO  
ON EACH 13MB FLOPPY DISC



# The Dynamax DCR1000 with New Version 2.0 Software

**THE OBVIOUS DIGITAL SOLUTION TO CART MACHINE PLUG-IN REPLACEMENT**

## The Recorder

- Selectable sampling rates
- Secondary and Tertiary cues
- AES/EBU digital input
- Start on audio
- Direct digital dubbing from CD
- PC keyboard for titling
- New* • Cut & paste editing
- New* • Variable length beds
- New* • Kill date checking
- New* • Disk label printing

## The Reproducer

- Simple cart-like operation
- No on-air personality training
- Just three front panel buttons
- Instant start and cue
- Maintenance-free design
- Awesome audio quality
- New* • Rotation & chaining
- New* • Replay lockout
- New* • Count-up/count-down timer
- New* • RS232 logging/remote control

## The Media

- 13MB stores over 5 minutes stereo audio with 15kHz bandwidth and 15 minutes mono with 10kHz
- Standard low-cost 2MB floppy disk holds 60-second commercials
- New* • Non destructive media diagnostic test

**NAB Special!**

**FREE Record Module with purchase of 3 players**

8:00 a.m. to 8:00 p.m. EST • 1-800-622-0022  
Canada 1-800-269-6817 • Toronto 416-731-3687  
U.S. & Canadian Fax 317-966-0623

**HARRIS  
ALLIED**

**LPB Inc.** 1924  
Introducing: LPB SALSA, a digital audio system with satellite automation, live assist and audio production capabilities, plus optional full automation from compact disc, hard disk or other audio sources.



**Manhattan Production Music** 13635  
On display: Company's line of Audiophile Sound Effects Series. Chesky Records Classical Series, and 42 CDs of production music.

**Mark IV Pro Audio Group** 1000  
Introducing: Klark Teknik DN3600 stereo programmable graphic equalizer; DDA QII console, a true LCR (left, center, right) unit with choice of eight mono, stereo or four true LCR outputs. Also: Klark Teknik's 300 Series graphic and parametric equalizers. 400 Series parametric equalizers. 500 Series compressors and gates. 700 Series digital delays. 800 Series crossovers. DDA's QMR, PROFILE and INTERFACE consoles. MIDAS' XL3-16 broadcast remote console.

**Marti Electronics** 3918-3919  
Introducing: STL-15C frequency agile composite STL link, now available in export frequencies from 150 MHz to 480 MHz. Also: STL-10 SCPS STL systems available from 150 MHz to 960 MHz. Systems for remote broadcast, the RPT-30, RPT-15 and RPT-2. Contact: Dan Rau 1501 N. Main St., P.O. Box 661 Cleburne, TX 76033 817-645-9163

**Maxell Corp. of America** 1661  
On display: Professional audio and video products, including audio cassettes, R-DAT cassettes and reel-to-reel products. Product line includes 3/4-inch digital audio tape, optical disks and CD and CD-R.

**McCurdy Radio Industries Ltd.** 13111  
On display: DCS 3000 DSP serial digital intercom system, using advanced technology to meet demanding local and network broadcast requirements. MICROCOMPACT digital intercom system for small mobile units and studios. M/2000 automation system. McCart digital audio storage and multi-channel playback system. UMD-32 tri-color 32-character under monitor display units. ATS-100 stereo audio test set. ATS 2656 stereo audio monitor with integral 6x1 switcher. UIO-80 universal interface unit for serial/parallel machine control interface. 9000 Series audio and video distribution amplifiers and accessories. Contact: Dan Kupiec 108 Carnforth Rd. Toronto, Ontario M4A 2L4 800-267-8800

**Media Touch Systems Inc.** 1006  
Introducing: Media Touch digital audio editing program. Pick 'N Play studio control software package. "Auto-Record" workstation. Also: OpLOG live assist/automation control system. MediaDISK digital audio system. Contact: Jim Waterman 50 Northwestern Dr., Unit 11 Salem, NH 03079 603-893-5104

**Modulation Sciences Inc.** 11102-11104  
Introducing: Software upgrade for Model RDS-1 RDS/RBDS encoder; RDS/RBDS data receiver. Also: RDS/RBDS coder, FM ModMinder, Modulation Monitor/analyzer, StereoMaxx spatial image enlarger, CP-803 composite processor, Sidekick audio and data subcarrier generators, DSCA-1 data SCA receiver, composite D/A, wired STL. Contact: Arthur Constantine 12A World's Fair Drive Somerset, NJ 08873 908-302-3090

**Moseley Associates Inc.** 2824  
Introducing: The StarLink 9000, all-digital modular system for simplex/full duplex transmissions, including 13 Personality Modules. Two new options for the DSP 6000: ISO/MPEG source codec and built-in AES/EBU rate converter. Optional programmable intelligent coprocessor module and interfaces for VM 700A video analyser, satellite controllers and video/audio switchers for the MRC 2. Also: The MRC 2 transmitter control system, the MRC 1620 transmitter control system, the RPL 4000 remote pickup link system, the DSP 6000 digital audio codec for RF and T1 applications. Contact: Jamal Hamdani 111 Castilian Dr. Santa Barbara, CA 93117 805-968-9621

**MYAT Inc.** 4619-21  
On display: Adjustable quarter wave stub second harmonic filter and line of rigid coaxial transmission line products and components. Contact: Robert Hilsdorf P.O. Box 425 380 Chestnut St. Norwood, NJ 07648 201-767-5380

**Nady Systems Inc.** 11327  
Introducing: 950 GS UHF wireless microphone system, a wireless receiver, rack-mount true diversity frequency synthesis unit with selectable channels arranged in groups for easy access. Also: Line of established company wireless mic systems.

**NAGRA Lysis** 1213  
Introducing: Integrated Information System to provide a user-friendly environment with plug-in modules for sound editing, scheduling, broadcasting, administrative tasks and news editing. It is an open system based on distributed computing, client-server architecture, high speed networks, high capacity storage and multitask and multi-user needs. Contact: Tom Jenny 1865 Air Lane Dr. Nashville, TN 37210 615-391-3399

**Nautel Maine Inc.** 1912  
Introducing: NE50 Digital FM Exciter uses direct digital synthesis (DDS) to generate the modulated FM carrier. NE50 accepts composite, mono and SCA inputs using a/d technique designed for ultra low-noise and distortion. Also: Company's full range of AMPFET Series AM and FM solid state transmitters. Contact: Jorgen Jensen 201 Target Industrial Cir. Bangor, ME 04401 902-823-2233

**Nemal Electronics Inc.** 13619  
On display: Composite audio/video cables. Audio snake cables. Custom audio/video interface panels. Audio/video cable and patch cords. RF connectors and adaptors.

**Neotek Corp.** 2226-2227  
On display: Esprit Series console system for broadcast production, offering eight aux busses and mix-minus from every input module. Mono/stereo configuration. Information will be available on company's line of consoles for multitrack recording, broadcast production and editing.

**NPR Satellite Services** 4807-8  
On display: Audio interconnection services, including fixed and transportable uplinking, digital audio transmission, digital fiber links and service to Galaxy and Satcom.

**Neumann/Sennheiser** 12136  
Contact: Albert C. Zang, Jr. 6 Vista Dr. Old Lyme, CT 06371 203-424-9190

**Neutrik USA** 3906  
Intro: NanoCon three-pole sub-miniature connector. Models NC3FX and NC3MXY solderless/ screwless insulation displacement connectors. Model NJ\*FD-V vertical 1/4" jack. Contact: James E. Cowan 195 Lehigh Ave. Lakewood, NJ 08701 908-901-9488

**NVISION Inc.** 20081  
Introducing: NV1050 Four-channel Sample Rate Converter, accepts AES/EBU signal, sample rates 32-50 kHz. NV1055 Four-channel Digital Audio Mix/Minus and Routing Module. NV1060 Digital Audio Delay Compensator Module, provides up to 20 video fields (330 mS) of delay. Optional BNC/1-volt Digital I/O interfaces for NV1000, NV3064 and NV3512. Also: NV1000 modular terminal hardware. NV2000 digital audio transmission systems. NV3512 expandable digital routing switchers. NV3064 compact digital routing switchers. NV4448 sample rate converter. NV 5500/5200/5100 sync generators.

## Be Prepared With The ParaTool®

Only \$60.95\*

A GREAT GIFT!

\*plus \$4.00 for surface shipping in the U.S.A.

**Radio World**  
**TOOLS of the TRADE**

Charge your purchase via fax with your Visa or Mastercard. Fill in this form and fax to **703-998-2966** (no CODs or collect calls please)

## At Last! A New Dats/Sedat Digital Satellite Receiver

Shipping Now!

- Dart 384 Compatible - Dats/Sedat/McCurdy
- Uses consumer-grade LNB & RG-6
- Adapts easily to current LNA systems
- 5 card slots
- Extra heavy duty power supply
- New 7.5/15 KHz switchable Dats card

The Ariel

**Satellite Systems**  
(719) 634-6319  
(Fax) 635-8151

**24 Hour Phone / Fax Technical Support**  
**All Networks & Receivers**

CREDIT CARD SALES FORM (Please Print Clearly)

ITEM	QUANTITY	PRICE	TOTAL
Paratool			\$
CARD NUMBER _____			
EXPIRATION DATE ____ / ____		CHECK ONE: <input type="checkbox"/> MASTERCARD <input type="checkbox"/> VISA	
NAME ON CARD: _____			
BILLING ADDRESS: _____ Country _____			
AMOUNT \$ _____			
SHIPPING INFORMATION:			
NAME: _____			
ADDRESS: _____ Country _____			
PHONE: _____ FAX: _____			

Or to order by mail, send the completed form to:  
**Radio World Tools of the Trade**, P.O. Box 1214, Falls Church, VA 22041 USA

RW185

# Products & Services Showcase

For more information on the products shown below, circle the appropriate Reader Service No.(s) on the enclosed Subscription/Reader Service card or contact the advertiser directly.

## EVEN THE BEST CAN BE MADE BETTER

Introducing the new

### MINI-MIX 12A

THE COMPACT MIXER WITH A COMPACT PRICE FROM THE QUALITY LEADER

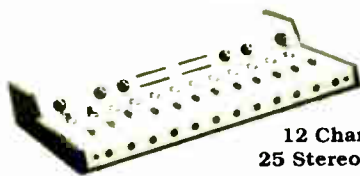

\$3499

12 Channels  
25 Stereo Inputs

Service & Affordable Quality for Over 23 Years

## AUTOGRAM CORPORATION

1500 Capital Avenue (214) 424-8585  
Plano Texas 75074-8118 1-800-327-6901  
FAX (214) 423-6334

READER SERVICE NO. 131

## Custom!

Shively FM Antennas offer standard features often unique in the industry: Custom-designed stainless steel mounts, included as standard equipment on Shively commercial antennas, ensure a secure and exact interface between the antenna and its support structure. Unlike others who use pieces of chain and "J-bolts", Shively's custom approach assures you of an installation that goes together right the first time, with a minimum of rigging time, and stays that way! Watch future issues of **Radio World** for other unique Shively features.

## Shively Labs

A Division of Howell Laboratories, Inc.

19 Harrison Road, Bridgton, ME 04009  
207-647-3327 FAX 207-647-8273

READER SERVICE NO. 6

## Uniformity. Durability. Dependability.



They're important to Audiopak...

...and to us.



BROADCAST CARTRIDGE SERVICE, INC.  
15131 Triton Lane, Suite 108  
Huntington Beach, CA 92649  
(714) 898-7224

READER SERVICE NO. 39

## WIRELESS IFB SYSTEM

Used by hundreds of TV stations for van-to-field cueing in ENG & SNG applications. Transmitter provides mix of program and instructions to rugged, pocket receivers.

- 100% duty cycle
- Wideband audio
- Excellent operating range



## COMREX®

Comrex Corp., 65 Nonset Path, Acton MA 01720  
Tel: 1-800-237-1776 Fax: 508 635-0401

READER SERVICE NO. 185

## ONE GOOD TURN AFTER ANOTHER

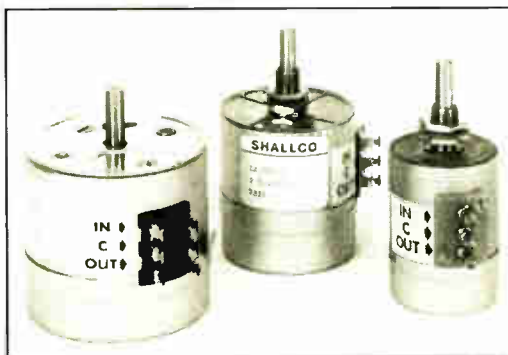

Is the success story for Shallco/Daven style step attenuators. Over 50 years of combined service to the broadcast industry. You can depend on us for reliable products and service. Request New Catalog A20 for additional information.



SHALLCO, INC.  
PRECISION ELECTRICAL COMPONENTS  
P.O. BOX 1089 • SMITHFIELD, NC 27577 • TEL 919/934-3135

READER SERVICE NO. 75

## 1200L Digital Message Announcer

Answers the telephone line and plays your message



The 1200 will play a 3 part message to incoming callers consisting of a greeting message (usually an advertisement spot), the information you are providing (sports scores, weather, etc.), and a closing message (also an ad spot). This creates a captured audience for your advertising clients and helps generate revenue for your station. These messages can even be updated remotely over the telephone (password required).

## RACOM PRODUCTS INCORPORATED

5504 State Road, Cleveland, OH 44134  
Local: (216)351-1755 Fax: (216)351-0392

National: 800-722-6664

READER SERVICE NO. 78

## Effective & Affordable at Last.

Studio Communications by Broadcast Tools



Most broadcast consoles... even very high end consoles... don't have adequate talkback/intercom capabilities. The Broadcast Tools SMI 5B (Studio Monitor Intercom) provides the solution you've been looking for.

- Dual headphone amplifier with host EQ
- Split monitor and headphone talkback with dimming
- Mic or line talkback input
- On-Air programable privacy
- Simple interconnection between studio and console
- Full remote control

Call us!

BROADCAST TOOLS

6353 40th Avenue SW, Seattle, WA 98136 USA Phone • Voice Mail • Fax 206-938-4089

READER SERVICE NO. 190



If you see it in the pages of Radio World, we can finance it for you!



Assisting you with all your new & used equipment needs.

PLC 1-800-999-9546 (ext. 132)  
Priority Leasing Corporation

READER SERVICE NO. 144

**o,p**

**Omnimusic** 19201-2  
On display: Omni-FX sound effects library on 12 CDs, organized by application.  
Contact: Jerry Burnham  
6255 Sunset Blvd., Ste. 803  
Hollywood, CA 90028  
800-828-6664

**Omnitronix** 4806  
Introducing: 2,800 W panel for Omni-50 50 kW AM broadcast transmitter.  
Also: Omni-5000 5000 W AM broadcast transmitter.  
Contact: John Solt  
113 Dickerson Rd.  
North Wales, PA 19454  
215-699-2400

**Otari Corp.** 1209  
Introducing: MR-10 MiniDisk recorder. A high-capacity CD changer. A new broadcast console and a line of lower-priced consoles with Concept I-type features.  
Also: Line of professional audio recorders from 1/4-inch two-track analog to 1-inch 32-channel digital. R-DAT recorders. ProDisk 464 digital audio workstation. Automatic and semi-automatic audio and video cassette loaders. Pancake and in-cassette audio duplication systems. T-700II TMD high-speed video duplicator.  
Contact: Deborah Bryce  
378 Vintage Park Dr.  
Foster City, CA 94404  
415-341-5900

**Pacific Recorders & Engineering** 13047-9  
Introducing: ADX Basic, streamlined version of company's ADX workstation.  
On Display: ADX Digital Workstation. Turnkey broadcast systems. Studio furniture. Consoles. Peripherals.  
Contact: Jim Miller  
2070 Las Palmas Dr.  
Carlsbad, CA 92009  
619-348-3911

**PanAmSat** 15171  
On display: Satellite transmission services.

**Penny & Giles** 4527  
Introducing: MM16 MIDI Management System, real-time control for production/post-production applications. VCA16 Audio Control Module.  
Also: PGF 8000 and 3000 Series linear faders. Analog and digital T bars. E-belt digital controllers.

**Potomac Instruments** 2310  
Introducing: AA-51A automatic audio analyzer, compatible with test software on NAB CDs.  
Also: AG-51 audio generator. FIM-41 AM field meter. FIM-71 VHF field meter. FIM-72A UHF field meter. 1900 antenna monitor. RC-164 remote control. 1500-PC remote control. SD-31 synthesizer detector. SMR-II AM monitor receiver. 1700 Series remote control interface products, including the 175-TLM tower light monitor.  
Contact: David G. Harry  
932 Philadelphia Ave.  
Silver Spring, MD 20910  
301-589-2662

**Pristine Systems Inc.** 3800  
On display: Pristine digital control system for digital radio programming; uses Pioneer 6- and 18-slot CD players and Tascam DAT machines for music and Dolby AC-2 digital hard disk audio for commercials, promos, voicetracks, liners, etc. Music Plus music scheduling software.  
Contact: Boyce Williams  
8489 W. Third St., Ste. 1017  
Los Angeles, CA 90048  
310-670-7500

**Professional Sound Corp.** 5124-5  
Introducing: PSC IntelliSlate SMPTE time code slate devices, able to read and generate time code on 24, 25, 29.97 and 30 frame rates, and 29.97 and 30 drop frame. Headset microphone. PSC OmniPlate microphone. PSC Universal Shock Mount System. Solar panel/rechargeable power supply.

**Promusic Inc.** 13148-9  
On display: Promusic production music library of over 1,000 CDs, with an average of 15 new releases per month. The Match production music library. Digifects and Sound Ideas SFX library. The Big Whoosh, containing over 250 production elements.

**Prophet Systems Inc.** 5222  
Introducing: CD and hard drive automation module & copy editing module for Wizard for Windows.  
Also: Wizard for Windows digital editing/automation system, utilizing Windows 3.1 and Novell 3.12 technology.  
Contact: Kevin Lockhart  
111 W. Third St.  
Ogallala, NE 69153  
800-658-4403

**q,r**

**QEI Corp.** 4218  
Introducing: Digital remote pickup system. Digital transmitter-to-studio link. 675-B FM exciter.  
Also: CAT-LINK digital STL/TSL featuring Q-MAX 16-bit digital discrete audio card and digital composite system cards. AUTOMOD closed-loop automatic gain control for FM. Solid state and single-tube FM transmitters at 10 W-30 kW.  
Contact: Jeff R. Detweiler  
1 Airport Dr., P.O. Box 805  
Williamstown, NJ 08094  
800-334-9154

**Radio Express** TBD  
Introducing: TM Century's HitDisc E, weekly compilation of new breakers in European hits and alternative music.  
Also: Weekly syndicated programs: American Top 40; Hot Mix, including top 40, modern, techno, and retro versions; American Gold; American Country Countdown.

**Radio Design Labs** 5406-7  
Introducing: Additions to the "Stick-On" line of products, including ST-OSC2A and ST-OSC2B audio oscillators, ST-SX4 audio switcher and ST-RG-1 ramp generator with remote control.  
Also: Complete line of "Stick-On" products, over 33 items in all. Complete line of "Rack-Up" products. ACM-2 AM Noise Monitor. AMX-84 8x4 stereo audio switcher/combiner.  
Contact: Jerry Clements  
P.O. Box 1286  
Carpinteria, CA 93014  
805-684-5415

**Radio Systems Inc.** 3012  
Introducing: DDS digital audio delivery system for on-air delivery, built on a multi-user operating sys.  
Also: RS Series consoles. RS-1000 professional DAT machine. TI-101 telephone interface. Super Clock analog and digital master clock/timer systems. Mono and stereo distribution amplifiers.  
Contact: Daniel Braverman  
601 Heron Dr.  
Bridgeport, NJ 08014  
609-467-8000

**RE America** 3801-2  
Introducing: RE 4500 ETSI digital video codec. RE 660 MUSICAM encoder. RE 661 MUSICAM decoder. RE 532 RDS/RBDS encoder.  
Also: RE 533 slim-profile RDS/RBDS encoder. RE 8720 tie line encoder. RE 8739 tie line decoder.  
Contact: Andrew Bosworth  
31029 Center Ridge Road  
Westlake, OH 44145  
216-871-7617

**Register Data Systems** 4508  
Introducing: Windows-based traffic and billing system. Hard disk-based live-assist and music automation.  
Also: Phantom digital audio automation system. PC-based traffic and billing software packages.  
Contact: Brad Harrison  
P.O. Box 980  
Perry, GA 31069  
800-521-5222 or 912-987-2501

**Radio Computing Services Inc.** 5202  
On display: MASTER CONTROL digital on-air studio. PRO-SONIX digital multitrack editor. RCS Traffic spot scheduler. SELECTOR music scheduler.

**Richardson Electronics Ltd.** 12901  
Introducing: Sennheiser and Shure audio products. RF transistor pallets. Directional couplers. Amphenol connectors. Unilator capacitors. WL Gore assemblies.  
Also: EIMAC power grid tubes and accessories. Amperex and National power grid tubes. Motorola, SGS-Thomson, M/A Com and Philips RF transistors.

**Roland Corp. US, Pro Audio Division** 3406  
Introducing: Version 2.0 firmware for DM-80 digital audio workstation. DM-80-S version 2.0 Multitrack Manager Macintosh System software for DM-80 workstation.  
Contact: Laurel Cash  
7200 Dominion Cir.  
Los Angeles, CA 90040-3696  
213-685-5141, ext. 338

**RF Industries** 19481  
On display: Universal flush-mount wall plate system for telephone/CATV cable connection. SMA cable connectors. RFA-4084 "Gripper Nipper" wire cutter.

**s,t**

**S.W.R. Inc.** 16043  
Contact: David K. Edmiston  
Rd. #3, Box 182  
Industrial Park Rd.  
Ebensburg, PA 15931  
814-472-5436

**Sandar Electronics A S** 3703  
Introducing: 16x16 video/stereo audio router.  
Also: Audio/video program routers and conference equipment. Distribution amplifiers and equalizers. Routers and distribution amplifiers for 34-140 megabits per second.

**Sanken Microphones** 2002  
Introducing: The CSS-5 stereo shotgun microphone featuring three modes of operation, mono, normal and wide.  
Also: Full line of studio, MS stereo, field production and lavalier mics.

**Schmid Telecommunications America Inc.** 1606-8  
On display: SIAT (short interval audio test) System. SIAT-MAX hand-held automatic audio test generator. RESCO Windows-based remote monitoring and control system for broadcast and data transmission.

**Scott Studios** 4020  
Introducing: CompuCarts, 16 digital audio players on a computer touchscreen and cart recorder in production. Uncompressed mode for CompuCarts or Production Bank digital audio. Light Pen version of Scott CD juke box controller. CD Player controller for Pioneer CD players

**Selco Products Co.** 4618  
No display information available at presstime.  
Contact: Celeste Favata  
7580 Stage Rd.  
Buena Park, CA 90638  
714-521-8673

**COME SEE US AT NAB BOOTH 4824**

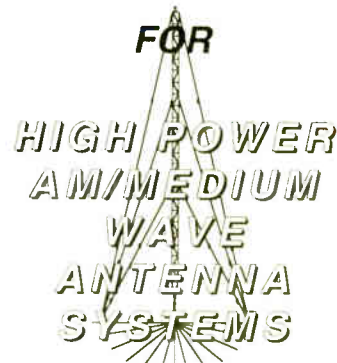

**COME TO THE COMPANY YOU CAN COUNT ON!**

**KINTRONIC**



**LABS, INC.**

**FROM CONCEPT TO OPERATION**

**KINTRONICS OFFERS THE STATE-OF-THE-ART DESIGN SERVICES AND TOP QUALITY PRODUCTS TO PUT YOUR STATION ON THE AIR WITH THE COVERAGE YOU NEED ANYWHERE IN THE WORLD**

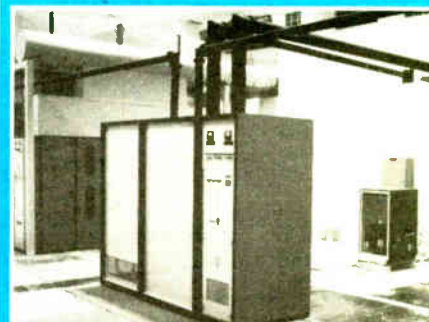

**MODEL CB-200X 200KW MW XMTR COMBINER MAGWA STATION STATE OF KUWAIT**

**KINTRONICS PRODUCTS INCLUDE:**

- AM/MW**
- OMNI OR DIRECTIONAL ANTENNA SYSTEMS
- MULTIPLEXED ANTENNA SYSTEMS
- TRANSMITTER COMBINERS
- DUMMY LOADS
- RF COMPONENTS
- RIGID TRANSMISSION LINE
- RF SWITCHES
- AND MUCH, MUCH MORE**

**KINTRONIC LABORATORIES INC.**  
P.O. BOX 845  
BRISTOL, TENNESSEE 37621-0845  
PHONE: 615-878-3141  
FAX: 615-878-4224

**COME SEE US AT NAB BOOTH 4824**

**ULTRAMOD . . . UM2000 FM STEREO MODULATION SYSTEM**



The **UM2000** is a complete FM processing and stereo generating system featuring:

- Dual band, stereo AGC and peak processors of exceptional clarity.
- Digitally synthesized stereo generator with separation exceeding 60dB at 1 KHz, and typically 55 dB at 15 KHz.
- Dual composite outputs for feeding main and auxiliary transmitters or STL's.
- Separate Pilot output for composite processor interfacing.

**CALL TODAY!**



42 Elaine St., Thompson CT 06277  
203-935-9066 or 203-935-9242  
FAX: 203-935-9919

**—FOR BROADCASTERS WHO SPEND THEIR OWN MONEY—**

# Products & Services Showcase

For more information on the products shown below, circle the appropriate Reader Service No.(s) on the enclosed Subscription/Reader Service card or contact the advertiser directly.

## CD Storage Systems

Rugged ABS cabinets designed for high density storage of CD's. Storage from 500 to over 1000 per cabinet, based on storage format and type of CD.

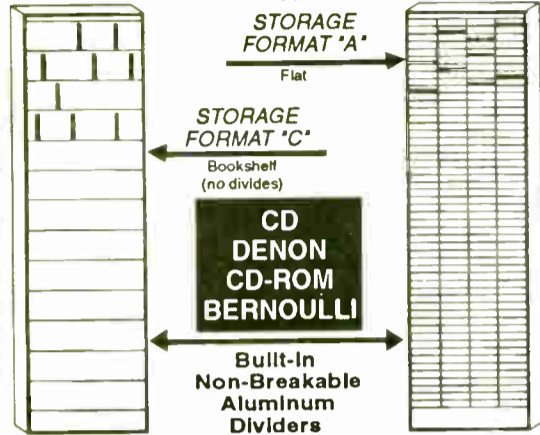

### Tape Storage Systems

Tripp Communications Sales • TCS  
P.O. Box 5267, Walnut Creek, CA 94596  
Tel: 510-256-6006 Fax: 510-256-6007

READER SERVICE NO. 2

## RECORDABLE CDs

Allows

- ✓ INSTANT CUEING  
of station ID's and spots
- ✓ CONSERVE SPACE  
consolidate selected cuts
- ✓ ULTIMATE FIDELITY

Quick Service

AS LOW AS \$59.00 PER DISK!

Your Transfer Headquarters!

Third Story Recording  
5120 Walnut Street  
Philadelphia, PA 19139

1 - 800 - 497 - DISK (3475)

READER SERVICE NO. 29



## Econco REBUILT POWER TUBES



Approximately One Half  
the Cost of New  
3,000 Hour Unconditional Guarantee  
Call for Our Price List

Econco 1318 Commerce Ave. Woodland, CA 95695  
Phone: 916-662-7553 Fax: 916-666-7760 Telex: 176756  
Toll Free: 800-532-6626 From Canada: 800-848-8841

READER SERVICE NO. 147

## Digital Dream System \$9,995.00!



Just \$9,995.00 for this dual digital audio Satellite control with Production system. You get two powerful 486SX-25 computers, VGA color monitors and 535 meg hard disk (9+ hours mono storage), LAN and DMX-4 audio switcher. Includes interface and control hardware. Nothing else is required! This pricing is good for a limited time.

- Great Sound: Premium apt-X™ audio card standard
- Simultaneous record/play for *time shift* PBR recording
- Separate Production room system with LAN net connect to Control for complete backup & safety.
- Satellite system handles all standard formats
- CD system option from \$1,500 uses Pioneer single or triple 6 packs or 300 disc jukeboxes
- Live assist included, ready for Traffic & Music interfaces
- Many options: External button boxes, more audio & I/O

### The Management

1-800-334-7823 1-817-625-9761 FAX: 817-634-9741  
P.O. Box 1-36457 Ft. Worth, TX. 76136  
1600+ Stations - Our 13th year

\* Extra charge for combined Satellite & CD systems. No holds or splits, larger hard drives available at extra cost.

READER SERVICE NO. 88

## WE REPRESENT THE FINEST MANUFACTURERS OF BROADCAST AND RECORDING STUDIO EQUIPMENT

### AUDIO BROADCAST GROUP INC.

A new beginning for an  
Industry standard!  
Now with 3 sales offices to  
more efficiently provide all your  
broadcast equipment needs.

For additional information on how we can serve you, please call today

<b>MAIN SALES OFFICE</b>	<b>SOUTHEASTERN SALES OFFICE</b>	<b>WESTERN SALES OFFICE</b>
2342 S. Division Avenue Grand Rapids, Michigan 49507	200 Fareway Drive, Suite 2 Smithfield, North Carolina 27577	P.O. Box 1638 Palmdale, California 93550
Phone: 800-999-9281 Fax: 616-452-1652	Phone: 800-369-7623 Fax: 919-934-8120	Phone: 800-858-9008 Fax: 800-273-3321



For over 32 years

**AUDIO  
BROADCAST  
GROUP**

READER SERVICE NO. 65

## MAX-Z II

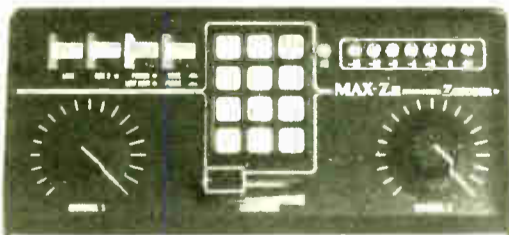

\$1,095 w/ case

The Zercom MAX-Z II is an abbreviated version of the famous Zercom MAX-Z Remote Broadcasting Telephone System. High quality audio handling is maintained in the two channels of audio input. Headroom, noise performance and distortion are comparable in quality to studio consoles.

Features of the 6 lb, 8"x9.5" unit include frequency response of 200Hz to 7KHz ± 0.5 db, 90Hz to 12KHz ± 1.5 db; noise floor of -70 dbm with 0 dbm line level input, -61 dbm (mic level input); and harmonic distortion of 0.35% or less and intermodulation distortion of 0.2% or less. Head room is 16 db above 0 VU.

### ZERCOM

Box 84, Merrifield, MN 56465 • 218-765-3151

READER SERVICE NO. 95

## Cellcast

REMOTE BROADCAST STUDIO

The CELLCAST RBS-400 1.8 offers complete portability and flexibility for remotes. Complete with a 4-channel mixer, frequency extender, cellular transceiver and landline capabilities, 600 ohm line out, and Vu meter. It is powered by 10 Ni-Cad rechargeable batteries, 12v adaptor, and AC power supply. 24 hour product support standard.

Call Bridget  
Taylor today  
for our  
\$195.00  
2 week trial at



**Phone: 918-272-8504**  
**FAX: 918-272-8452**

READER SERVICE NO. 118

## NEW IS BETTER THAN OLD!

PRISTINE'S QUARTERLY SOFTWARE  
UPDATES KEEP YOUR SYSTEM  
STATE OF THE ART AND  
PROTECT YOUR INVESTMENT

PRISTINE CD DIGITAL AUTOMATION SYSTEM  
including: 2 heavy duty 486/33/DX computers •  
8+ hours of Dolby AC-2 stereo hard disk audio  
• music scheduling system • traffic system  
interface • digital editing package • 8 Pioneer  
TM-3 CD Players • CD audio mixer & amp •  
installation & training • leasing available

*Pristine*  
**SYSTEMS**  
INCORPORATED

\$18,995

Distributed Nationally by  
PROFESSIONAL MANAGEMENT SERVICES, INC.  
803/370-2400 • FAX 803/370-2314  
INTERNATIONAL 310/670-7500 • FAX 310/670-0133

READER SERVICE NO. 26

**Sescom Inc.** 13601-2  
On display: Audio accessories for broadcasting, recording and live sound reinforcement.  
Contact: Franklin J. Miller  
2100 Ward Dr.  
Henderson, NV 89015-4249  
702-565-3400

**SG Communications Services Inc.** 16627  
Introducing: New line of small tower to meet the demands of the communications business. Complete turnkey site development service for domestic and international communication systems. HDTV stress analysis and investment planning studies. Installation and maintenance of lighting systems. Custom-designed inspection and maintenance programs. Planning and coordination of projects in compliance with governmental regulations.  
Contact: Dan Ferguson  
1100 Northmeadow Pkwy., Ste. 112  
Roswell, GA 30076  
404-475-0212

**Shively Labs** 4224  
On display: Side-mount and panel FM broadcast antennas. Multi-station combiners. Rigid transmission line. Pressurization equipment. Pattern work.  
Contact: Jonathan R. Clark  
19 Harrison Rd.  
Bridgton, ME 04009  
207-647-3327

**Shure Brothers Inc.** 11901  
Introducing: FP32A portable stereo mixer for EFP, ENG, film production and audio recording. FP22 headphone amplifier. SC Wireless Series of wireless microphone systems.  
Also: FP410 portable automatic mixer. EC Series and L Series wireless microphone systems. VP88 stereo microphone. Beta 87 condenser microphone.  
Contact: Davida Rochman  
222 Hartrey Ave.  
Evanston, IL 60202  
708-866-2200

**Siel Sistemi Elettronici S.R.L.** 6206-7  
Contact: Antonio Orizzonte  
Via Bari, 26  
20143 Milano, ITALY  
39-2-89150150

**Sigma Electronics Inc.** 16260  
On display: The Series 1000 for RGB.

**SONEX Acoustical Products Div.** 2103  
Introducing: Fabrix acoustical material, with fiber-free, semi-rigid melamine, and an asst. of deco fabric covers.  
Also: Full line of acoustical products.

**SMARTS Broadcast Systems** 5224-5  
Introducing: Line of Ultimation products, fully digital automation systems that store all audio on a bank of computer hard drives; includes new SMARTS Music Master music rotation system.  
Also: Line of SMARTCASTER automation and SMARTS office equipment.  
Contact: John Schad  
2102 Main  
Emmetsburg, IA 50536  
712-852-4047

**Sony Professional Media Products Group** 11711  
Introducing: HMPX Hi8 metal particle tape. HMEX Hi8 metal evaporated tape. DAE-D5000 digital audio workstation that uses PCM 9000 for storage. MXP-700 audio mixing console. HR-MP5 multi-effects processor.  
Also: BCT-D Series Digital Betacam cassettes. UVWT-MA Series Betacam SP cassettes. ProDAT Plus Series Digital Audio Tape cassettes. MD gear. Digital studio line. DATStation editor.

**Sound Ideas** 11703-4  
Introducing: Ambience II Series 7000 sound library. The Mix broadcast music library.  
Also: Warner Bros. animation sound effects library. the Hanna-Barbera SoundFX Library.

**Soundcraft** 15713  
Introducing: Series 10S live-on-air mixer. Series 30 live-on-air/production mixer. Spirit studio LC console.  
Also: LM-1 portable location mixer. BVE100 audio for video mixer. B100 bdct console. Vienna II production console.

**Studer Editech Corp.** 1213  
On display: Nagra-D four-channel self-contained professional digital audio recorder.  
Contact: Tom Jenny  
1865 Air Lane Dr., Ste. 12  
Nashville, TN 37210  
615-391-3399

**Studio Technologies Inc.** 13618  
Introducing: Studio Tools family of distribution amplifiers. Also: StudioComm series for digital audio workstations. IFB Plus System. AN-2 and Generation II stereo simulators. Mic-PreEminence microphone pre-amplifier.

**Superior Electric** 4914-5  
Introducing: Catalog WHR692 describing WHR Series and Catalog WHR692-S, which describes the series in Spanish.  
Also: WHR Series STABILINE automatic voltage regulators. STABILINE rack mount voltage regulator. UPSY Series STABILINE power supplies.  
Contact: Ted Gladis  
383 Middle St.  
Bristol, CT 06010  
203-585-4500

**Svetlana Electron Devices** 10262, 10362  
Introducing: The 3CX3000A7 zero bias triode.  
Contact: George M. W. Badger  
3000 Alpine Rd.  
Portola Valley, CA 94028  
415-233-0429

**Symetrix Inc.** 4622  
Introducing: Symetrix 420 stereo amplifier.  
Also: SX201 parametric EQ/preamp. SX202 mic preamp. SX204 headphone amp. SX208 stereo comp/limiter. 402 dual output delay. 421 AGC/leveler. 425 dual compressor/limiter/ expander. 501 peak-RMS compressor/limiter. 571 and 572 SPL computers. 601 digital voice processor.  
Contact: Sherri Swingle  
4211 24th Ave. W  
Seattle, WA 98199  
206-282-2555

**Systems Wireless Ltd.** 13636  
Introducing: Vega-Net, a network-based wireless control and monitoring system. Demo of the Lectrosonics DC1B computerized microphone level controller.  
Also: HME System 800 UHF wireless intercom system that interfaces to Clear-Com, RTS and other cabled systems. Vega's full line of wireless microphones and wireless IFB systems. Full line of Clear-Com party line and Matrix intercom systems.

**Tascam** 15669  
Contact: Bill Mohrhoff  
7733 Telegraph Rd.  
Montebello, CA 90640  
213-726-0303

**Tektronix Inc.** 17119  
Introducing: AM700 audio measurement set. ASW-100 Series audio switchers.

**Telex Communications Inc.** TBD  
Introducing: The FMR-450 UHF wireless receiver, the HT-450 UHF handheld mic transmitter, the WT-450 UHF all metal belt pack, the HT-200 handheld mic transmitter, the BP-1000 single channel beltpack and the BP-2000 two-channel beltpack.  
Also: Full line of headsets, headphones, wired and wireless mics, intercom systems and high speed audio tape duplicators. The RTS intercom line, including two-wire as well as digitally controlled four-wire matrix intercom systems.

**Telos Systems** 5200  
On display: Zephyr digital audio network transceiver. Telos 100 Delta digital hybrid. The Link. The ONE plus ONE dual hybrid. Call Screen Manager software for talk show production. ONE-x-Six talk show system.  
Contact: Danielle Cline  
2101 Superior Ave.  
Cleveland, OH 44114  
216-241-7225

**TFT Inc.** 1908  
Introducing: DSS92, a digital subcarrier system for television. EIS911 and 912 emergency information system manager and generator.  
Also: DMM92 digital modem and multiplexer for digital STL transmission. Modulation monitors/analyzers. Analog STLs. Remote pickup transmitters and receivers. Emergency Broadcast equipment.  
Contact: Darryl E. Parker  
3090 Oakmead Village Dr.  
Santa Clara, CA 95051  
408-727-7272

**Television Technology Corp.** 15708  
On display: FMS4000 4kW solid state FM transmitter. FMS100 100W solid state FM transmitter.

**TM Century** TBD  
Introducing: TM Mix and TM Country GoldDisc libraries. Slam Dunk production library.  
Also: GoldDisc CD library. HitDisc weekly compilation CDs. Ultimate Digital Studio II. Production libraries. Jingles on CD. TM Century television. PowerPlay music scheduling software. TM Comedy Network weekly CDs.  
Contact: Stuart McRae  
2002 Academy  
Dallas, TX 75234-9220  
800-299-2121 or 214-247-8850

**Tripp Communications Sales** 15380-1  
Contact: Ted Tripp  
P.O. Box 5267  
Walnut Creek, CA 94596  
510-256-6006

**UREI** 15713  
Introducing: Delay module for Platform.  
Also: LA series of compressor/limiters. Platform modular rack-mount signal processor.

**Utility Tower Co.** 2326-7  
On display: Samples of tower sections for AM, FM, TV, CATV, LPTV and microwave communications.

**Valentino Inc.** 12203-4  
Introducing: Production music and sound effects libraries in CD-ROM multimedia format for IBM Windows and Mac formats.  
Also: Production music library. Sound effects library.  
Contact: Thomas Valentino  
500 Executive Blvd.  
Elmsford, NY 10523  
914-347-7878

**Varian Associates** 16101  
Introducing: New service of remanufacturing power, grid tubes for radio transmission.  
Also: Power grid tubes for AM, FM and shortwave radio.

**Vega Wireless** 15716  
Introducing: VegaNet, a wireless microphone system with network capabilities. 600 Series UHF wireless microphone receiver.

**See  
The  
1st  
Digital  
Radio  
Station  
at  
NAB  
Booth  
2218**

**HARRIS  
ALLIED**

WHAT ELSE

do  
you  
want  
it  
to  
do?

The HPT Series from BEXT is everything you've heard it is: it can be an exciter, a transmitter, a translator and a booster in one high performance, fully featured package. From \$3,695 to \$3,985.

BEXT

1045 10th Ave. • San Diego, CA 92101  
619-239-8462 • FAX: 619-239-8474

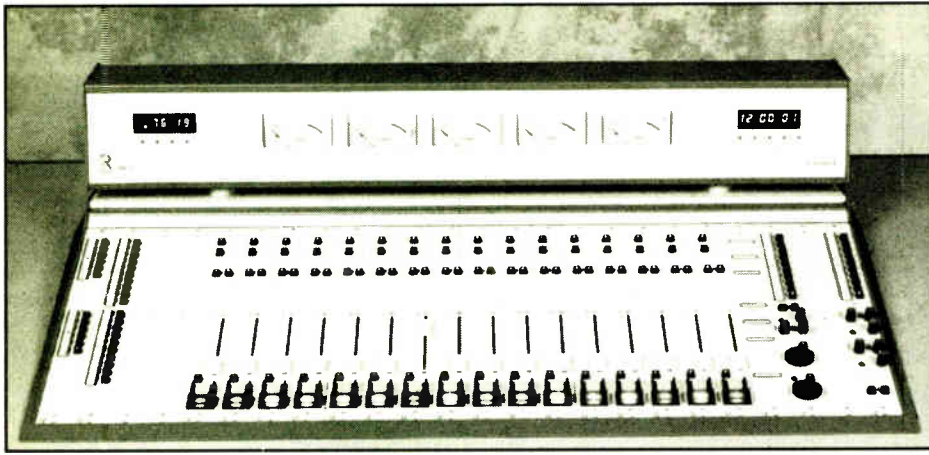

Ward Beck's MKII

**Wegener Communications Inc.** 5414  
On display: Digital audio SCPC transmission provided with Addressable Network Control System (ANCS).

**Wohler Technologies** 19539  
Introducing: Surround Sound monitor. Digital VTR (AES/EBU) audio monitor.

**Ward-Beck Systems** 12501  
Introducing: Renaissance radio control series. Also: M405P portable extended range VU meter. D8212 audio distribution amplifier system.  
Contact: Eugene L. Johnson  
841 Progress Ave.  
Scarborough, Ontario  
Canada M1H 2X4  
416-438-6550

**Will-Burt Co.** 19203  
On display: NightScan remote control elevated lighting system. Pneumatic telescoping masts.  
Contact: Steve Pinkley  
P.O. Box 900  
Orville, OH 44667  
216-682-7015

**Wheatstone** 5108  
On display: The Wheatstone A-6000 audio console.  
Contact: Ramon Esparolini  
6720 V.I.P. Parkway  
Syracuse, NY 13211  
315-455-7740

## ADVERTISER INDEX

This listing is provided for the convenience of our readers. Radio World assumes no liability for inaccuracy.

Reader No.	Advertiser	Page No.
62	AMP Services	158
55	Aphex	7
40-41	Arrakis	175
7	ATI	94
49	Audicord	62
2	Audioarts	102
60	Audio Broadcast Group	52
70	Audio Broadcast Group	65
28	Audiopak	104
3	Audio Precision	33
24	Audio Processing Technology	15
79	Audiotronics	101
68	Autogram	131
36	Belar	30
62	Benchmark	188
51	Bext	100
71	Bext	64
68	Broadcast Cartridge Service, Inc.	39
60	Broadcast Devices, Inc.	48
6	Broadcast Electronics	53
58	Broadcast Electronics	111
17	Broadcast Direct Marketing	202
60	Broadcast Tools	112
60	Broadcast Tools	1
62	Broadcast Tools	204
68	Broadcast Tools	190
25	BSW	149
4	Burk	119
21	California Digital Audio	166
36	CCA	57
38	CCS	121
70	Cellcast	118
46	Clark Wire & Cable	150,117
50	Computer Concepts	164
3	Comrex	189
68	Comrex	185
13	Continental	145
62	Cortana	142
24	CRL	81
51	Cutting Edge	168
57	Cutting Edge	139
44	Dataworld	108
8	Dawn	60
53	Delta Electronics	203
34	Denon	210
15	Dick Brescia	107
22	Dick Brescia	84
70	Econco	147
62	ESE	116
12	Eventide	137
10	Fidelipac	162
37	Fidelipac	69
66	Fidelipac	129
52	Gepco	152
54	Gorman Redlich	49
1	Harris Allied	22
14	Harris Allied	208/114
56	Harris Allied	—
63, 65, 71	Harris Allied	—
69	Hnat-Hindes	66
59	Inovonics	55
18	ITC	171
28	J.R. Nelson	218
62	J Squared Technical Services	181
69	Kintronc	179
54	Logitek	71
43	LPB	25
72	LPB	127
9	Mackie Design	77
39	Marti	169
52	Marti	46
60	Monroe Electronics	47
30	Murphy Studio Furniture	192
48	Myat	211
23	National Public Radio	123
64	Nautek	76
54	Omega Scientific	85
26	Orban	125
16	Otan	113
47	Pacific Recorders	159
38	Pioneer	216
70	Priority Leasing Corporation	144
35	Pristine Systems	26
39	Prophet Systems	20
68	QEI	154
27	Racom	78
11	Radio Programming Management	213
65	Re America	130
45	Re America	135
60	Roland	97
67	Russ Friend & Associates	161
60	Satellite Systems	10
32	S.C.M.S., Inc.	70
68	Scott Studios	110
68	Shalco	75
44	Shively Labs	6
61	Sierra Automated Systems	44
11	Superior Electric	17
30	Svetlana	87
63	SWR	141
62	Symatrix	156
70	Tapecaster Inc.	124
29	Tape Storage Systems	2
31	Telos	73
70	Telos	184
70	The Management	88
42	Third Story Recording	29
15	TTC	98
80	UPI	40
60	Wheatstone	195
70	Zephyrus Electronics, Ltd.	16
	Zercom	95

# YOU CAN RELY ON LPB®

Everyone knows the LPB Signature Series is the industry standard for rugged reliability. The LPB tradition of durable, reliable, easy-to-use consoles continues in our new linear fader consoles.



With over 3,000 units in operation worldwide, the LPB Signature III console represents a standard others are still unable to match. The Signature Series has proved its ability to perform on 6 continents, in settings ranging from metropolitan to jungle. With an incredible record of ruggedness and easy maintenance, it's no wonder over half of the Signature console owners have more than one. Features include 3 inputs per channel, two output buses and plug-in electronics. LPB Signature III consoles are available in 6, 8, 10, and 12 channel stereo and 6, 8, and 10, channel mono models.

The LPB 7000 Series takes the standards of the Signature III a step further, adding more features than any other console in its price range. With front panel switches rated for 5,000,000 operations, gold contacts, plug-in modular electronics and more, the LPB 7000 Series has the durability radio and TV stations worldwide expect from LPB. Features include two inputs per channel, three stereo output buses with one mono-mixdown standard and two more optional, user configurable muting and remote starts, and much more. Available in 12 and 18 channel stereo models.



It doesn't matter which LPB board you choose, you'll get a console you can count on 24 hours a day. One you'll keep for a long time. Ask any LPB console user - they're all around you.

# LPB®

28 Bacton Hill Road • Frazer, PA 19355 • (215) 644-1123 • Fax (215) 644-8651

Publisher.....Stevan B. Dana  
Associate Publisher.....Carmel King  
Marketing.....Consultant/Al Leon  
Marketing Assistant.....Annette Deutscher  
Production Director.....Kim Lowe  
Production Manager.....Julianne Stone  
Production.....Vicky Baron, Lisa Lyons, Lisa Mamo  
Ad Coordination Manager.....Simone Mullins  
Circulation Director.....Rebecca Seaborg  
Accounts Receivable.....Steve Berto

### Advertising Sales Representatives

U.S. East: Skip Tash  
703-998-7600 Fax: 703-998-2966  
U.S. West: Dale Tucker  
916-721-3410 Fax: 916-729-0810  
International: Stevan B. Dana  
+1-703-998-7600 Fax: +1-998-2966  
Europe: Dario Calabrese  
+39-2-753-0274 Fax: +39-2-753-2697  
Japan: Eiji Yoshikawa  
+81-3-3327-2688 Fax: +81-3-3327-3010

Free Subscriptions are available upon request to professional broadcasting and audiovisual equipment users. For address changes, send current and new address to RW a month in advance at P.O. Box 1214, Falls Church, VA 22041. Unsolicited manuscripts are welcomed for review; send to the attention of the appropriate editor.



# Radio World

## Broadcast Equipment Exchange

"Broadcast Equipment Exchange" accepts no responsibility for the condition of the equipment listed or for the specifics of transactions made between buyers and sellers.

### RADIO RESOURCES

CALL US TO RECEIVE YOUR COPY OF THE NEW TECHNICAL NECESSITIES CATALOG

**PRE-OWNED EQUIPMENT CURRENTLY AVAILABLE:**

- Harris THE-1 Exciter
- Gentner TC-100-RRT
- Belar RF Amp
- BE FM5B Transmitter
- Eventide Delay BD 931
- ITC Series 1 R/P Stereo
- Potomac FIM-41
- Wheatstone A-500 Console
- And Many Other Items

**PRE-OWNED EQUIPMENT ITEMS WE NEED:**

- AM/FM Transmitters
- Optimods
- Field Strength Meters
- STL & RPU Equipment
- Otari MX 5050 BII Reel to Reels
- Plus Many Other Items

**TEST EQUIPMENT AVAILABLE TO RENT:**

- Potomac Field Strength Meters
- Delta Impedance Bridge
- Delta Receiver/Generator
- Tektronix Spectrum Analyzer (for AM splatter measurements)

Call Steve or Chuck  
**1-800-54-RADIO**  
**1-410-783-4635 FAX**

Circle (24) On Reader Service Card

### ACOUSTICS

Want to Sell

**STUDIOFOAM**  
 SOUND ABSORBENT WEDGES  
 TESTS UP TO 40% BETTER THAN SONEX  
 \* COSTS LESS \* BETTER COLORS \* BETTER CUT \*

**SONOMATT**  
 4'x8'x2" Sheets • \$29.99 Ea. In Pans • NRC 70 • Ships UPS

**VENUS** 12" x 2" x 4" NRC 1.30 • Flat 10K-125KHz  
 Then They Really Kick In (125KHz NRC-  
 MASS TRAPS 1.53) • Charcoal Gray • 2 For Just \$150!

USA Foam - Box 20384 • Indianapolis, IN 46201 • (317) 251-2992  
**1-800-95-WEDGE**

Circle (96) On Reader Service Card

### AMPLIFIERS

Want to Sell

Crown DC 300A silver face stereo pwr amp, \$350; Hafler P-30 stereo pwr amp, \$375; McIntosh MC-60 tube pwr amp, \$400; Southwest Tech stereo pwr amp, \$95. D Lundy, Lundy Tape Duplicators, Cumberland Gap Pkwy, Heidrick KY 40949. 606-546-6650.

McIntosh C-22, MA-230, Scott, Dynaco. K Gutzke, 612-866-6183.

Perma-Power S-102 amp w/S1420 batt pack, mobile/portable PA unit, 12 W out, excel cond, \$100. R Sumner, CAVU Corp, 3322 Applegate Ct, Annandale VA 22003. 703-968-8894.

New 10 kW FM amp under \$24,000. Call for details. Bill Hoffman, 518-743-1601.

Dynaco stereo 120 solid state, rack mt \$229. Dynaco stereo 70 tube amp all new tubes! Dynaco PAT 4 preamps \$59. W Gunn 619-320-0728.

Jampro JMPC-10 10 bay circular FM antenna on 107.1, new cond, stored inside, \$9500/BO. B Zellmer, 303-353-6522.

### Want to Buy

**WANTED:**  
 Pultec EQ's; Fairchild, Teletronix, dbx, UREI, Sontec Limiters. Neumann, Telefunken, AKG and RCA mics. MacIntosh or Marantz Gear; Lang, Neve and API gear. Misc old tubes and guitars.

**DAN ALEXANDER AUDIO**  
 1340 Mission Street  
 San Francisco, CA 94103  
 (415) 252-7102  
 FAX: (415) 252-7524

RCA/Dielectric BCF-6B antenna, 6 bay tuned to 90.5, \$4000, (6) radomes, \$1500. A Clawson, WFFF, 1715 Michigan St, Sturgeon Bay WI 54235. 414-743-7443.

Windcharger 200, 100', on ground, BO. J Kesler, WOBZ, POB 220, Livingston KY 40445. 606-843-9999.

ERI FMH-10AC 10 bay antenna, CP tuned to 105.5, \$19,500. M Wodlinger, WIXI, 3337 Tamiami Trail N, Naples FL 33940. 813-262-1000.

Phelps Dodge CFM-3, 3 bays, tuned to 98.3 MHz, gd cond w/heaters, \$1500. D Heinen, KRSE, POB 127, Yakima WA 98907. 509-248-1390.

### ANTENNAS/TOWERS/CABLES

Want to Sell

Phelps Dodge CFM-LP3 3 bay FM on 92.1 MHz, removed 12/93, \$2500/BO; Cablewave HCC158-50J, 1-5/8" air coax, approx 260', \$800/BO. G Reinheimer, WYYD, POB 4108, Lynchburg VA 24502. 804-237-4700.

Andrew EW63A waveguide w/ends, (2) new rolls, 75' & 140' in boxes, BO/trade. M Kestler, KAWZ, 241 Main Ave W, Twin Falls ID 83303. 208-733-3133.

### FM - ANTENNAS

Designed and built for your frequency. Choose from 1 to 12 bays and five power levels. Financing available. Call Jimmie Joynt at S.W.R. **214-335-3425**

Andrews various 3" & 1 5/8" connectors, 100' of 3 1/8" Andrews line, (2) RF chokes Continental 814B + manual, BO; Continental ERI Rototiller tuned to 97.7, 3 bay, 1 5/8" lead, 1.5588 gain, BO/trade. B Hill, KACK FM, 106 S Jefferson, Mt Pleasant TX 75455. 903-577-9730.

**ICE KRACKERS, INC.**  
 Inexpensive permanent protection of guy wire anchor hardware from guy wire ice slides. Average cost \$400 for 400-foot tower. ICE KRACKERS sized by guy wire diameter. All sizes available.  
 273 Circle Drive, Springfield, IL 62703  
**(800) 747-8921 or (217) 529-8921**  
 Ask for Jim Newbanks

Andrew 5" air coax 500' on I-80 in Iowa, connectors incl, \$10000. R Henry, WPIO, 505 Josephine St, Titusville FL 32796. 407-267-3000.

MC1 61104 3 1/8" motorized coax switch, never arced, great shape, \$1000. C Hudak, WBZZ, 1715 Grandview Ave, Pittsburgh PA 15211. 412-381-8100.

Towers (5) 380', 24" & 30" face, complete w/lights, some addtl hardware, on ground, ready to ship. J McClish, WCRJ, POB 92251, Austin TX 78709. 800-856-5670.

Jampro 3-bay high gain antenna at 102.1, \$1500. E Seeger, WMXT, 2704 S Iby St, Florence SC 28505. 803-661-5000.

### ITC

REPAIR • REFURBISHMENT • UPGRADE

Remanufactured machines available for sale or rent.

Direct from the only qualified ITC Cart Machine Repair Center

- All work warranted for 1 year minimum
- Service contracts available

Call Rusty  
**(800) 447-0414**  
**(309) 828-1381**

International Tapetronics Corporation  
 2425 South Main Street  
 Bloomington, IL 61704

ERI 2CPLFM 2-bay w/radomes tuned to 91.5 MHz, \$2000. KC Hill, AECC, POB 2061, Bristol TN 37621. 615-878-6279.

Eventide digital delay, excl cond electronically, scratch on top cover when removed from equip rack. B Hill, KACK FM, 106 S Jefferson, Mt Pleasant TX 75455. 903-577-9730.

ERI 37CP5 5-bay FM antenna, tuned to 93.7 MHz, recently rebuilt, \$1500; Myat 3" rigid transmission line, 20' lengths, incl bullets, hangers, some elbows avail, 320' avail, \$150/section. C Hudak, WBZZ, 1715 Grandview Ave, Pittsburgh PA 15211. 412-381-8100.

Sine Systems Stereo Watchdog, rides stereo balance, phase flip, subs loss of left or right chnl, \$425/BO. D Evans, KALW, 2576 Harrison, San Francisco CA 94110. 415-695-5740.

ERI G5CPM tuned to 96.7, 180' Andrew HJ5-50 7/8" line. A Clawson, WFFF, 1715 Michigan St, Sturgeon Bay WI 54235. 414-743-7443.

Looking for Audio Bargains?  
**We BUY • SELL • TRADE**  
**QUALITY USED EQUIPMENT**  
**317-962-8596**

HARRIS ALLIED

4 or more bay antenna tuned to 90.1 MHz needed for educational FM upgrade. KC Hill, AECC, POB 2061, Bristol TN 37621. 615-878-6279.

UREI 537 33 band graphic equalizers (3), gd cond, will sell separate or together, \$250/ea or 3/\$600. Jeff, 703-297-1188.

3-bay antenna tuned to 90.7 MHz, no radomes. K Austin, KFXI, 1101 Hwy 81 N, Marlow OK 73055. 405-658-2556.

Wanted: used towers, beacons and side lights. Phone (901) 286-8100; FAX (901) 286-5600.

### AUDIO PRODUCTION

Want to Sell

Demeter 4 ch rack mt tube direct box NEW \$795. W Gunn 619-320-0728.

Digidesign Audiomedia I digital recdg & editing system, analog in & out, stereo w/Audiomedia Vol 2 software & deck I 4-trk automated mix software, manuals. J O'Leary, 1717 Euclid St NW, Washington DC 20009. 202-332-8377.

Eventide BD-941 bdct delay line w/3.6 or 12 second delay, \$850. R Chambers, 916-257-2121.

**Radio World Broadcast Equipment Exchange**

...A great place to advertise!

Call Simone at  
**1-800-336-3045**  
 for information

## HE HALL Electronics

1305-F Seminole Trail Charlottesville VA 22901

A Sample Of Bargains We Have In Stock:

	Rebuilt	CALL
ITC 3D mono cart player w/HF cards -	NEW	\$ 49
Sennheiser HD-440 II stereo headphones -	NEW	\$ 2,195
Eventide H-3000B harmonizer - (1 only)	NEW	\$ 419
Marantz PMD-500 motorized stereo cassette deck	Rebuilt	\$ 395
Valley 610 Stereo Compressor/Limiter	Rebuilt	\$ 1,995
Marti VHF RPU Package (RTP-30/CR-10)	NEW	\$ 995
Harris AM-90 AM MOD Monitor (current model)	Rebuilt	\$ 395
Harris CC-II Mono RP Cart Machine - Closeout -	Rebuilt	\$ 2,995
Otari MTR-10 Reel to Reel		

Call us for your Complete Digital Needs:

- Digital DJ by The Management
- Air Marshal by Fidelipac
- Custom computer systems for all your automation/accounting needs at very competitive prices!

Call us for the Best New & Completely Rebuilt Equipment! (804) 974-6466

Fax: (804) 974-6450

Circle (89) On Reader Service Card

### SINE SYSTEMS

Announcing New Better Voice

The RFC-2 provides transmitter power control, has alarm dial out for 6 numbers, and provides up to 64 channels of control and metering. The best & lowest cost 'dial-up' remote control available.



The DAI-1 easily handles EBS requirements for "walk away" operations. It also allows direct access to the air chain in addition to providing remote broadcasts.

Call for the best price!

### COAXIAL DYNAMICS, INC.

RF peak reading wattmeter. The 83000-A converts from average reading to peak reading, with the flip of a switch!

Great Price! 2 year warranty



SWR

Ideal for low power FM broadcast stations or translators that require circular polarization.

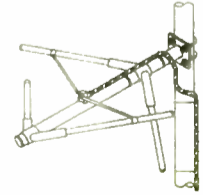

Model FMEC  
 88-108MHz, 500Watts

## AUDIO PRODUCTION...WTS

Ashly SG35E 4-chnl noise gates (4), \$225/ea. J Anderson, Regent Univ, 1000 Centerville Tpke, Vir Bch VA 23464. 804-523-7417.

Pultec HLF-3C filter, \$125. D Lundy, Lundy Tape Duplicators, Cumberland Gap Pkwy, Heidrick KY 40949. 606-546-6650.

Valley 400 mic processor, like new cond, \$400 plus shpg; Ashley PQ-26 stereo parametric six band EQ, excel cond, \$425 plus shpg; BBE 442 audio enhancer, excel cond, \$150 plus shpg. S Herring, Matt-Mark Audio Prod, 4709 N Cleveland, Kansas City MO 64117. 816-452-7260.

## CASSETTES • CARTRIDGES • REELS

## J &amp; I AUDIO/VIDEO

A wholesaler in the Radio and Television market. Now running SPECIALS on audio and video:  
**BASF CASSETTES-AMPEX R-Rs**  
**AUDIOPAK, FIDELIPAC & ITC CARTRIDGES**  
 For more information call Kris Elliot at 1-800-942-1711 or write to: J&I Audio/Video 20899 Kelvin Pl. Woodland Hills, CA 91367

## Circle (42) On Reader Service Card

Micro-Trak 7216 stereo audio DA, 2 in 12 out in 1-3/4" rack mount, individual output controls for ea output (4), \$150 ea. S West, KMXR, 1 Gaslight Sq, Corpus Christi TX 78404. 512-886-6153.

ADC 96 & 144 Pr TT patchbays, excel cond, 1 rack space, 3 rows of 48, top 2 rows normalled, \$149, 96 is 2 row normalled, \$129 (you remove old wiring) or we totally refurbish w/new front panel, ready to install, \$199-229. TT cords up to 10 per bay at \$9 ea, reg \$13.95, also 1/4" bays. Audio Village, 619-320-0728, or Fax 619-320-2454.

dbx 180A type I NR (3), \$35 ea; dbx 224X type II NR (2), \$25 ea; CRL CC300A composite controller, \$35; CRL SMC 600A stereo mod controller, \$30. M Everhart, KXYQ, 111 SW 5th #1550, Portland OR 97204. 503-226-6731.

## Want to Buy

Audio level control equipment. J Mitchell, CVPI, POB 1046, Alexander City AL 35010. 205-234-0426.

Fairchild 600 conac or 602 Conex high freq limiters. J Gangwer, 942 32nd St, Richmond CA 94804. 415-644-2363.

## AUTOMATION EQUIPMENT

## Want to Sell

Smartcaster 8K mono, will interface w/satellite, (2) 60 MEG hard drives, \$3900. B Hill, KACK FM, 106 S Jefferson, Mt Pleasant TX 75455. 903-577-9730.

SMC MSP-1 automation system, complete w/(4) Otari ARS-1000, (3) 350RSB Carousels, SMC 712 dual cart player, universal interface, all in 3 matching SMC custom deluxe racks, manuals, in operation, \$6000/BO. R Wynne, KFLS, POB 1450, Klamath Falls OR 97601. 503-882-4656.

Schafer Series 7000 w/(4) Audiofiles, (2) R-R, (3) racks, unknown cond, gd for parts, BO. G Reinmeimer, WYYD, POB 4108, Lynchburg VA 24502. 804-237-4700.

Harris 9001 automation w/(2) Otari ARS-1000, (2) IGM 24 Go-Carts, (2) single play ITC cart decks; also second system for spares or standby w/Brain, switcher, pwr supply, terminal, keyboard & manuals, \$4000/BO. R Wynne, KFLS, POB 1450, Klamath Falls OR 97601. 503-882-4656.

IGM-SW automation cntrlr, IGM update w/4 Go-Cart 24 interfaces, manuals & software, \$1800. E Duellman, WONT/WQTC, Box 1385, Manitowoc WI 54221. 414-682-0351.

SMC 452 bi-directional, stereo Carousels, \$800 ea. R May, KULF, 306 E Main, Brenham TX 77833. 409-836-9411.

Scully automated system, useful for non-commercial AM/FM, BO. J Kesler, WOBZ, POB 220, Livingston KY 40445. 606-843-9999.

Format Sentry FS12 C, 48 tray IGM Instacart, (4) ITC R-R plybcks, 1000 SL Tandy computer, DMP Tandy printer, DRS uninterruptible power supply, Spotmaster R/P machine with 25Hz tone alert & (2) 6' racks to mount, excellent condition, will sacrifice for what is owed on equipment, will consider selling all or part of equip. A Terry, 703-647-8493.

SMC DP-2 complete system. D Barron, KWJM, 113 N Main, Farmerville LA 71341. 318-368-3094.

SMC automation system, w/SPP 3060 stepper, AS-10 switcher, time clock, (2) 700 Series single play cart decks, (3) Carousels w/(3) RAC-50 random access controllers, (4) Scully 270 tape decks w/outboard tone sensors, all in (4) matching racks, \$1200. B Williams, KOOL 106.1, 918-455-9522.

Sentry Systems cntrlr/interface w/16 Pioneer PD TM3 CD plyrs, XT computer, complete AC CD library & Computer Concepts DCS, all under 1 yr old, \$26K or sep. M Rollings, Rollings Comm, POB 882, Chesterfield MO 63006. 314-458-5595.

## Want to Buy

Complete studio w/(2) R-R, (2) cassette, (2) CDs, mics, console, automation equipment, etc, must be in good condition, missionary station, \$3000 plus donation receipt for the difference. K Leatherwood, Believers Bdctg, POB 1776, Terrell TX 75160. 214-524-1956.

Conex 25 Hz tone gen. Howard, KDAP, Douglas AZ 85609. 602-364-3484.

Time announce carts. D Tabor, WLCK, Box 158, Scottsville KY 42164. 502-237-3149.

## CART MACHINES

## Want to Sell

Harris triple deck stereo cart machine, totally recon, looks/operates like new w/all connectors, \$900. G Jones, SW Mediacast, 110 Sierra Rd, Kerrville TX 78028. 210-367-4587.

Audi-Cord DL Series (3) stereo play only, \$3500 ea, DL/RS R/P, \$900. R May, KULF, 306 E Main, Brenham TX 77833. 409-836-9411.

Audi-Cord DL series stereo R/PB, \$700/BO. R Wynne, KFLS, POB 1450, Klamath Falls OR 97601. 503-882-4656.

## ITC Upgrade Cards

From \$199.00

▼ Premium Line Play

▼ Premium Line Record

▼ Delta Playback

Call for a FREE Demo

**AD** Audio Dynamics  
 (804) 978-2888

Audi-Cord DL stereo 2-tone R/P, \$1000; 4 playbacks, \$650/ea. C Binder, WZOS-FM, 38 E Bridge St, Oswego NY 13126. 315-342-9600.

ITC PD2 mono PR cart deck, mint cond, \$700. E Finley, Genesis 2000 Std, 4101 W Union Hills Dr, Glendale AZ 85308. 602-978-8092.

Rapid Q mono cart player, \$95. G Dunn, No Cal News, 5383 Willow Lake Ct, Byron CA 94514. 510-516-0299.

BE 5300C tripledeck, stereo, PB, mint less than 50 hrs, BO. R Kaufman, Pams Prods, POB 462247, Garland TX 75046. 214-271-7625, after 3PM CDT.

Spotmaster 500 R/P (2), 1 excellent condition, \$500; 1 good condition, \$300 both mono, lever type, \$700/both. K Stevens, In House Audio, 5354 Cortez Ct, Mobile AL 36609. 203-666-4232.



Great Prices on original equipment tape heads for ITC, BF, Fidelipac, Otari, Tascam & others!

Sparta 300 P mono cart mach w/1 kHz cue PB, home made rcd electronics, \$150/BO. R Perrine, Imagination Indust, 2475 State Rd Ste 22, Cuyahoga Falls OH 44223.

Fidelipac/Dynamex CTR-12 stereo-play w/all tones, never used on air, \$850. D Igou, KCHL, 8435 Twister Oaks, Garden Ridge TX 78266. 210-651-9049.

## Want to Buy

ITC PD-II, need one R/P unit, one PB for simple newsroom operation, nothing fancy, no junk. A Sutton, WBCU, POB 70, Union SC 29379. 803-427-2411.

ITC Delta stereo P/B machines. D Irwin, KSOL, 55 Green St, #200, San Francisco CA 94111. 415-616-5768.

ITC, BE, Fidelipac cart machines: single, triple, mono, stereo, play & record/play. Call M O'Drobink @ 619-758-0888.

## CASSETTE &amp; REEL-TO-REEL RECORDERS

## STUDER SERVICE SPECIALIST

Thousands Serviced • Unbeatable Rates  
 Precision Capstan Resurfacing  
**Audio Advantage**  
 Tel (615)742-3834 FAX (615)254-8826  
 PRICE-QUALITY-SERVICE  
 Let Us Prove It

## Want to Sell

Tascam 34B 4 trk R-R, all manuals, cables, roll-around stand, very little use, excel, \$650. A Selk, Selk Prod, 1391 Normandy Dr #1, Atlanta GA 30306. 404-876-8894.

Otari MX 5050, \$1800. R May, KULF, 306 E Main, Brenham TX 77833. 409-836-9411.

Telex 235 3:1 cassette duplicator, like new, \$650 plus shpg. S Russell, 60410 Klett Dr, Decatur MI 49045. 616-782-9258.

## REVOX PARTS/SERVICE

Cassette-CD-Open reel  
 Rebuilt B77s, \$900.00  
 Capstan resurfacing, ALL BRANDS.  
**JM TECHNICAL ARTS**  
 30 Music Sq. W. #156  
 Nashville, TN 37203 (615) 244-6892

Revox B-77 open reel recorder, 7.5-15 ips, 1/2 track, good condition, \$575; Sony PCM-F1 digital recording system, F1 digital processor modified with Apogee input filters & external sync input, \$1500/complete system, \$1000/F1 processor only. R Streicher, Pacific AV Enter, 545 Cloverleaf Way, Monrovia CA 91016. 818-359-8012.

Uher 4200 Report Monitor, R-R stereo 1/2 trk portable, 3 hds, 4 speeds, new in box, \$500. R Sumner, CAVU Corp, 3322 Applegate Ct, Annandale VA 22003. 703-968-8894.

Tascam 32 1/4" 2 trk, excel cond, low hrs, \$500. R Maycock, RMC Consulting, 10245 Haledon Ave., Downey, CA 90241. 310-861-7624

Otari ARS-1000 (2), mint condition, Best Offer. J Kesler, WOBZ, POB 220, Livingston KY 40445. 606-843-9999.

Otari ARS 1000 (2) gd cond, w/25 Hz, \$400/ea. B Hill, KACK FM, 106 S Jefferson, Mt Pleasant TX 75455. 903-577-9730.

## EMPLOYMENT

To place ads in this section, use the ActionGram form. To respond to box numbers write Radio World, PO Box 1214, Falls Church, VA 22041. Attn: \_\_\_\_\_

## POSITIONS WANTED

Agree experience isn't only years, tapes? Hire Janet 502-895-5888. FT announcing, programming aspirations. Computer literate, in radio since 1980 PT announcing, mktg exper, serious only.

Radio dynamo seeks news job at medium mkt station, call for tape. M Kunkle, 814-226-9259 or 412-744-3270.

Agree exper isn't only yrs, tapes? FT announcing, programming aspirations, computer literate, in radio since 1980 P/T announcing, mktg exper, serious only. Janet, 502-895-5888.

Custom Voice IDs, spots, breakers, promos, etc, 25 yr pro of Boston, NYC, Philly & DC. Write: JLC, Box 2733, Spring PA 19609.

Inside sales coordinator, 4 yrs exper, proven trk rcd, generate new business, past accounts, coordinate/schedule outside reps. Mark, Orange Co NY. 914-344-1118.

Creative air personality, producer & copy-writer seeks music intensive country station in midwest, 12 yrs exper. Tom, 319-568-2198.

Proven travel program personality writes, performs, produces ratings thru roof show, can handle callins, British accent. Phil, 408-866-8542.

Creative, fun radio is only a call away! Dedicated, exper air personality, recent morning gig w/prod skills, will relocate, AC/CHR/Oldies. Kevin, 609-863-1991.

Hands on Engineer with over 30 years of AM/FM/TV, MF/HF/UHF background, desires position with International SW bdctg facility, FCC Gen SBE Cert, IEEE, AE Degree. Lou, 904-383-8457.

Can do it all, experienced xmtr, studio & digital automation engineer seeking contract maintenance engineering work in north central Texas, FCC licensed/EET/certified. Dave, 214-410-1717.

Broadcast engineer with high power RF experience, instructor in training & safety skills, seeks career opportunity. Ed C, 207-732-5185.

Ready to go to work for your station, young prod man w/multi-media exper, willing to relocate, recent graduate. Brad, 405-329-5632.

20 year vet in radio announcing & some part time sales, seeks full time announcing in AR, OK, MO, KS, TX. Call after 5PM, 501-337-5249.

Arizona only, chief engineer, exper all phases of high pwr AM & FM, 20 yrs exper incl Top 50/100 mkts, dry warm climate, chief, group chief or contract. Send replies to: Radio World, POB 1214, Falls Church VA 22041. Attn: Box 94-01-26-01 RW.

Classic rockoholic looking for FT pos, on-air & prod, intemed at #1 classic rock station in nation, willing to relocate, temperate or mountlns. Eric, 405-329-1664.

Radio pro for htra, programming, mgmt, versatile. Roger, 615-235-6889.

Country music library comes with me, exper GM, PD & DJ in country music radio, I know country music. David, 407-981-0104.

Mama's Dead radio talk host David F Diamond is ready for new, major market. 901-761-5577.

Prod co seeking paid radio, TV narration assignments. R Suraci, Fine Art Prod, 67 Maple St, Newburgh NY 12550. 914-561-5866.

Over 20 yrs exper in radio mgnt news & engineering, mostly in small or med mkts, seeks mgnt news or engineering pos in MO, AR or West TN. Bill, 816-461-5834.

Soon-to-be bdctg grad w/on-air, prod & sales exper seeks FT pos in May, great skills & desire. Shawn, 812-886-9729.

Combo Chief Engineer, announcer, sales, production, Tampa Bay area or other good coastal Florida location. Bill, 813-844-3823.

Research specialist seeking paid assignments. R Suraci, Fine Art Prod, 67 Maple St, Newburgh NY 12550. 914-561-5866.

12 yr eng/prog/prod looking for exciting new pos in radio, exper at KITS, Live 105 in SF & KFAL classical in LA, will relocate. Bruce, 415-388-9005.

CE, NBN, FCC/Radar, CET, ISGCT cert seeks FT/PT pos or temp work TV/radio station, references avail upon request. M Rakoff, 114-41 Queens Blvd, Forest Hills NY 11375.

Exper Afro-Caribbean Christian broadcaster seeks announcer/prod or PD position with serious minded religious station in AK or SE region. Carlos, 305-674-1249.

Experienced jock, CHR background in NY market, great voice, quick wit, excellent board & production skills, will relocate, air check avail. Jim, 201-768-3709.

Former Christian grp GM avail, hands-on style, applications, acquisitions, engrg, sales, more. T Sauceman, 39297 Hwy 74, Gonzales LA. 504-647-8907.

Small mkt PD/announcer/news available, 8 years experience, top sound, dependable, hardworking, avai immed, will relocate. S Elliott, 904-757-6397.

If you master analog music tapes for radio stations & need more assistance, I have exper/equip. R Bass, 4100 O'Hare, Mesquite TX 75150-4454.

## HELP WANTED

Community radio, Cape Cod, Mass seeks general manager with heavy emphasis on development skills. Three years broadcast management experience, familiarity with all aspects of radio, proven fundraising experience. Salary: \$25,000 with health insurance & incentives.

Apply by March 1, 1994 to:  
**GM Search Committee**  
 WOMR, POB 975,  
 Provincetown MA 02657.  
 Call Mitch: 508-487-2619  
 for info packet.

## TOO MANY OPENINGS!

We have too many openings & not enough people to fill them. If you're serious about your career, we're just as serious about taking you to the next level! Hundreds of openings for air talent, news, night, prod & sales, also many engineering positions available in all aspects of broadcasting...all you do is subscribe. **No % of your pay, no contracts!** Besides our pub., we also have our BBS & Rapid Line (jobs by phone) up & running. Ask about our FREE referrals & resume bank. You'll be surprised at how inexpensive we are, check us out!

**BROADCAST EMPLOYMENT WEEKLY**  
 1-800-922-JOBS  
 1125 W Boone Ave., Naperville, IL 60563  
**BBS 1-208-467-4110**

## HELP WANTED

Coastal Southeast noncommercial FM in Progressive Format threatens to appear. Morning & afternoon slots open. Looking for low-key, high-knowledge sound. Send resume & tape to: DJ Search, 181 Edgemont Ave., Elmwood, CT 06110-1005

## Ass't Engineer

KVOO in Tulsa OK needs a FT ass't engineer. Exper in AM directional & FM w/subcarriers helpful. Detailed studio maint exper a must & knowledge of digital computers. Old stable company w/great benefits. Part of Midwest chain. EOE. Send resume to: Larry White, KVOO, POB 52548, Tulsa OK 74152. No calls please!

## Senior RF Engineer

Outstanding opportunity for motivated and highly qualified senior engineer. EE and PE desirable. Will perform and supervise FCC application and field engineering services. Broad theoretical and hands on skills in radio and TV transmitting facilities, cellular, microwave and land mobile systems. Excellent verbal and written communications essential. Willing to travel in US and abroad.

## Marketing

Individual with strong engineering marketing background to develop and support business in the wireless communications area. Background from cellular, paging, broadcasting or related fields. Excellent writing and presentation skills essential. Active participation in project planning and implementation. Strong creative role in new products and services. Willing to travel. International experience and Spanish language capability desirable.

Resume to: HR, LBA Box 8026, Greenville, NC 27835

## ABOUT OUR EMPLOYMENT SECTION

**HELP WANTED:** Any company or station can run "Help Wanted" ads for \$1.50/word or buy a display box for \$60/column inch. Payment must accompany insert, use your MasterCard or VISA; there will be no invoicing. Blind box numbers will be provided at an extra charge of \$10. Responses will be forwarded to listee, unopened, upon receipt. Call 800-336-3045 for details.

**POSITIONS WANTED:** Any individual can run a "Position Wanted" ad, FREE of charge (25 words max), and it will appear in the following 2 issues of Radio World. Contact information will be provided, but if a blind box number is required, there is a \$10 fee which must be paid with the listing (there will be no invoicing). Responses will be forwarded to the listee, unopened.

Mail to: **BROADCAST EQUIPMENT EXCHANGE**  
 PO Box 1214, Falls Church, VA 22041  
 Attn: Simone Mullins

To **ADVERTISE:** call 800-336-3045

### CASSETTES/R-R...WTS

**Ampex 440** (4) wrkg mono machines, many spare parts, \$300/ea. D Kannes, KTAR/KKLT, 301 W Osborn Rd, Phoenix AZ 85013. 602-274-6200.

**Otari MX 5050 MK III 2** trk, stereo, excel cond, \$1050; MCI JH 110A 2 trk 7.5-15-30 ips console mt, \$750; Scully 280-1 FT MT, \$350. D Lundy, Lundy Tape Duplicators, Cumberland Gap Pkwy, Heidrick KY 40949. 606-546-6650.

**Ampex AG440/350**, several units, PB only, great for parts, BO; ITC 770 stereo PG, gd cond, \$650. R LaFore, WSHH, 1459 Crane Ave, Pittsburgh PA 15220. 412-531-9500.

**Dictaphone 5600** logging reel machines & controller (2), BO. R LaFore, WSHH, 1459 Crane Ave, Pittsburgh PA 15220. 412-531-9500.

**Scully 280** 1/2 trk stereo w/motion sensing, in roll-around console, having trouble getting sufficient erase current to erase head, otherwise works fine, \$900. R Stopher, 3600 Kiki Ct, Louisville KY 40219. 502-969-1942.

**OTARI FACTORY DIRECT**

Accessories Clearance  
Call (415) 341-5900  
Fax (415) 341-7200

Otari Corp.  
378 Vintage Pk. Dr.  
Foster City, CA 94404

**Ampex MM1200** 8 trk remote, \$4500; Otari MTR10-2C stereo, \$3500; MCI Sony JH110B in console, \$1595; MCI Sony JH110A in console, gd cond \$1095; MCI JH110B mono, \$595; Ampex AG350 stereo, excel cond, \$495. J Price, 214-321-6576.

**Akai GX 40000** 1/4 trk, 3 head R-R (2), \$75 ea; Akai GX 9 3 motor 3 head cassette deck, \$50; Toshiba PC G30 2 motor 2 head cassette deck, \$30. G Dunn, No Cal News, 5383 Willow Lake Ct, Byron CA 94514. 510-516-0299.

**METROTECH  
DICTAPHONE  
LOGGERS**

PARTS AND  
SERVICE

---

**SEQUOIA  
ELECTRONICS**

4646 Houndshaven Way  
San Jose, CA 95111  
(408) 363-1646  
FAX (408) 363-0957

**Otari ARS-1000** (3) w/tone sensor boards in Gates rack, \$1000/all. B Williams, KOOL 106.1, 918-455-9522.

**Revox A77 MK1** original A77 case w/speakers, 10" reel adaptors, 3 3/4" - 7 1/2" quarter trk, almost new, \$395/BO. D Bisbee, 685 S Roys, Columbus OH 43204. 614-279-6163.

**Metrotech 525P R/R PB** deck, stores w/2 preamps, \$300/BO. R Perrine, Imagination Indust, 2475 State Rd Ste 22, Cuyahoga Falls OH 44223.

**Tascam 32-2**, 7-15 ips, excellent condition, \$550/BO; Ampex ATR100 4 speed 1/4" with extra cards & alignment tapes, \$4000. Z Nicall, Semendria Studio, 6404 Hollywood Blvd #410, Hollywood CA 90028. 213-464-2145.

### CLEAN PATCH BAYS NO DOWN TIME



**VERTIGO BURNISHERS AND INJECTORS RESTORE ORIGINAL PERFORMANCE TO YOUR PATCH BAYS**

**\$34.95 Ea.**  
**VERTIGO RECORDING SERVICES**  
12115 Magnolia Blvd. #116 818-907-5161  
North Hollywood, CA 91607 Fax 818-784-3763

**ITC 99B**, like new, only used in home, \$4200; (2) ITC SP units, 3 tones modified w/Straight Wire Audio cards & 99 PB heads, like new, \$700 ea. Dave, Capital Cities ABC, Detroit. 313-435-3932.

**Scully '100' recorders**, record/play amplifiers, 8, 16, 24 track heads. Sequoia Electronics, 4646 Houndshaven Way, San Jose CA 95111. 408-363-1646.

**Otari Mark II-IV 1/2"** 4-track, multi-track, mint, less than 50 hours, Best Offer. R Kaufman, Pams Productions, POB 462247 Garland TX 75046. 214-271-7625, after 3PM CDT.

**16 track 2"** \$3450, MCI JH110C-8 \$2800, 110C-8 play only \$500, ATR800 mono or Tascam 7300 or 2502 \$600 ea, MCI Locator III \$1195, Tascam 52 2 trk \$1200, Ampex AG350 excel \$50/ch. W Gunn 619-320-0728.

**Otari 5050 MK III-8** track, heads excellent, \$2450. Wayne Gunn 619-320-0728.

**Recordex 6** cassette rewriter \$100; Tascam 40-4 4 trk 10" in flight case w/free dbx \$750; MRL new short test tapes \$39 for 1/4" to \$199 for 2". W Gunn 619-320-0728.

#### Want to Buy

**Sony TCD-5M** stereo cassette recorder in bad to fair condition for parts/salvage. J O'Leary, 1717 Euclid St NW, Washington DC 20009. 202-332-8377.

**Any model splice** finder-eraser, in working cond. B Sims, KVSF, 1311 Calue Nava, Santa Fe NM 97505. 505-982-2666.

**Tascam 58 1/2"** 8 trk wanted to buy or trade for Otari 5050 MK III-8 or...? Wayne Gunn 619-320-0728.

**Ampex tube recorders** and mixers. W Gunn, 619-320-0728.

**Ampex ATR100** taperecorders for parts. Circuit cards, heads, motors, machine parts, or electronic parts. Call 818-907-5161.

**Spotmaster TP-60B** tape timers from cart tape winders (TP-1A or TP-1B). Mel Crosby, 408-363-1646.

### CD PLAYERS

#### Want to Sell

**Denon DN-950FA** in excel cond, \$750. R Michaels, KQFX, POB 7762, Amarillo TX 79114. 806-355-1044.

**Audlometrics AMCD5-1000A** multi-disk (100) CD players w/R232 control interface (2) avail, new optics, \$1000 ea. J Stromquist, WNCB, 2828 Piedmont Ave, Duluth MN 55811. 218-722-3017.

**Technics SL-P1200** (3) CD plyrs, all wrkg cond, \$800/ea. C Hudak, WBZZ, 1715 Grandview Ave, Pittsburgh PA 15211. 412-381-8100.

**Denon DN-950FA** CD cart machines (2), need some work, \$600/BO. C Pace, Evangel College, 417-865-2811 ext 7364.

**Studer A-727** (2), bdct quality, 5 yrs old, well maintained w/manual, \$450 ea/\$800 both. M Meyer, WWCK, 3217 Lapeer Rd, Flint MI 48503. 810-744-1570.

**Denon 950FA**, like new, \$975. R Nelson, KKRW, 10333 Richmond, Houston TX 77042. 713-780-0937.

### COMPUTERS

#### Want to Sell

**Tandy 6000HD** w/at least 1 floppy drive. Mel Crosby, 408-363-1646, FAX 408-363-0957.

### CONSOLES

#### Want to Sell

**Custom Wheatstone Broadcast Console** w/4-mic input channels, 18-line level input channels (44 line level sources), 3-stereo output busses, 1-mono output buss, cue buss, and separate speech & music processing possible through separate sub-mixing busses. Full Dorrough metering installed on 3-stereo and 1-mono output busses. Four channel telco hybrid with direct mixing buss. Redundant DC power supplies. Console was purchased for project which was not implemented & was used actively for less than 500 hours. Priced to sell...now! Call Ken at 801-269-1144.

Tascam M 208 8 chnl, 4 buss mixer, like new, \$500. R Maycock, RMC Consulting, 10245 Haledon Ave., Downey, CA 90241. 310 861-7624

**Teac 15**, 24 in mixing board, \$2500. HL Sewell, Oakridge Music, 2001 Elton Rd, Haltom City TX 76117. 817-838-8001.

**Ramko DC-8** mixer, needs work w/some parts, \$150. D Heinen, KRSE, POB 127, Yakima WA 98907. 509-248-1390.

**LPB S12** 5 pot 10 input stereo, excel cond, very clean, \$1295; LPB S13C 8 pot 24 input stereo in excel cond, gd clean working order, \$1895. J Travis, WCJK, POB 506, Bath NY 14810. 607-776-4151.

**Gates Dualux II**, refurb, new paint, \$1500. C Porter, WCAZ, POB 498, Carthage IL 62321. 217-357-3128.

**BE 450**, \$1500. R May, KULF, 306 E Main, Brenham TX 77833. 409-836-9411.

**Arrakle 500 SC** excl cond, 8 chnl stereo, will trade for studio or on air processing, \$1750. B Hill, KACK FM, 106 S Jefferson, Mt Pleasant TX 75455. 903-577-9730.

**Soundcraft Spirit 163** mixing console, \$1550; Quantum 12A mixing console, \$1300 complete; Fostex 2050 line mixer, \$100. R Streicher, Pacific A/V Enter, 545 Cloverleaf Way, Monrovia CA 91016. 818-359-8012.

**Dynamax** stereo 8 chnl for air or production, like new cond, \$3200/BO. Terri, GMN Inc, Box 2205, Cincinnati OH 45201. 606-572-9446.

**Audionics 110-A** 4-trk & 2-trk mixing console, 18 inputs, EQ modules, pwr sply, extra modules, manual, \$1200. D Kannes, KTAR/KKLT, 301 W Osborn Rd, Phoenix AZ 85013. 602-274-6200.

**Shure FP-31** 3-chnl mono mixer/case, used, gd cond, \$350. Raider Prod, 215-889-9565.

**Altec 352-A** 5 chnl mixer amp, \$125; Ampex MX-10 6 chnl stereo tube mixer, \$125. D Lundy, Lundy Tape Duplicators, Cumberland Gap Pkwy, Heidrick KY 40949. 606-546-6650.

**BE 5M150 Series** used as prod brd, gd cond w/manual, \$250. K Paul, WKXD, 259 S Willow, Cookeville TN 38501. 615-526-6860.

**Radio Shack disco mixer**, 3 mic, 2 line, 2 TT inputs, \$50. G Dunn, No Cal News, 5383 Willow Lake Ct, Byron CA 94514. 510-516-0299.

#### Want to Buy

**BE 5M-5250A** or 4M50A for simple newsroom operation, no junk. A Sutton, WBCU, POB 70, Union SC 29379. 803-427-2411.

**LPB Signature series** 10 or 12 chnl. J Frew, WYXC, 1410 Hwy 411 NE, Cartersville GA 30120. 404-382-1270.

**Sparta Electronics A-20B**, trying to rebuild console, need schematic, service info & parts source, will pay postage. T Wheeler, County Electronics, RR1 Box 215, Carlock IL 61725. 309-376-7721.

### DISCO-PRO SOUND EQUIP

#### Want to Sell

**UREI 811** Time Align studio monitor speakers, excel cond, \$800/pr. Z Nicall, Semendria Studio, 6404 Hollywood Blvd #410, Hollywood CA 90028. 213-646-2145.

**Sansui SE88** 10 band stereo EQ, \$30; Sansui RA1000 stereo reverb w/built in mic-line mixing, \$30. G Dunn, No Cal News, 5383 Willow Lake Ct, Byron CA 94514. 510-516-0299.

**Solar Black 102-450** 50 yds by 72" speaker, grill cloth, \$300/BO + shpg; McCauly 6284 12" 16 ohm (2) speakers, new, \$150/pr + shpg; Yamaha R1000 digital reverb, works, gd cond, \$100/BO + shpg. F Stadler, Fred Stadler Prod, 3912 Liberty, Westmont IL 60559. 708-960-4545.

#### Want to Buy

**dbx 902** (2), 903 (4), & 905 (2), not frame, just modules. R Streicher, Pacific A/V Enter, 545 Cloverleaf Way, Monrovia CA 91016. 818-359-8012.

**Roland DEP5** needed. S Russell, 60410 Klett Dr, Decatur MI 49045. 616-782-9258.

### FINANCIAL SERVICES

**EQUIPMENT FINANCING**

ON ALL  
RADIO EQUIPMENT

- Easy to qualify
- Fixed-rate, long-term leases
- Any new or used equipment
- 100% financing, no down payment
- No financials required under \$50,000
- Refinancing existing equipment

**ENF** EXCHANGE NATIONAL FUNDING

**Call Mark Wilson**  
(800) 275-0185

### LIMITERS

#### Want to Sell

**Dorrough Model 610** audio processors (lots of them for sale), audio accessories patch bay (numerous panels typically 20 x 6 rows per panel), distribution amplifiers, monitor switchers, etc. Priced for immediate sale! Call Ken at 801-269-1144.

**UREI BL-40** Modulimiter, SN 632, \$195. R Chambers, 916-257-2121.

**Optimod 8100A/ST** studio chassis only, gd cond, \$400. D Heinen, KRSE, POB 127, Yakima WA 98907. 509-248-1390.

**Orban 414A** dual chnl stereo compressor/limiter, \$425/BO; Aphex 700 studio dominator multi-band audio processor, \$600/BO. D Evans, KALW, 2576 Harrison, San Francisco CA 94110. 415-695-5740.

**Optimod 8100A**, \$4100. R Michaels, KQFX, POB 7762, Amarillo TX 79114. 806-355-1044.

**Optimod 8000A** (2), one works, one doesn't, \$1900/both. R Henry, WPIO, 505 Josephine St, Titusville FL 32796. 407-267-3000.

**CBS Labs Audimax III** (2), \$100/ea or \$175/both. C Binder, WZOS-FM, 38 E Bridge St, Oswego NY 13126. 315-342-9600.

**Orban Optimod 8000** in great cond, \$2000. D Barron, KWJM, 113 N Main, Farmerville LA 71341. 318-368-3094.

**CRL AGC400 & PMC 450**, \$50. C Porter, WCAZ, POB 498, Carthage IL 62321. 217-357-3128.

**Inovonics 1176 LN**, gd cond; Inovonics 222, gd cond. D Barron, KWJM, 113 N Main, Farmerville LA 71341. 318-368-3094.

**Altec 1591-A** compressor, \$175; Fairchild 67% dynamic de-esser, \$75; Fairchild 663 compressor, \$75. D Lundy, Lundy Tape Duplicators, Cumberland Gap Pkwy, Heidrick KY 40949. 606-546-6650.

#### Want to Buy

**Gates Sta Level** audio level amp, will consider other brand, up to \$50. E Lightman, WEDL, 550 Merchant St, Ambridge PA 15003.

**Volumax 4000A**, UREI LA-4, needed. Tom Scher, 716-634-2545 M-4PM EST.

**CBS Volumax 411** service/opertion manuals, will pay cost of reproduction & mailing or will buy outright. GP Brefini, GPs Mobile Jukebox, 12 Bailey St, Foxboro MA 02035. 508-543-4213.

**CBS Labs Audimax** wrkg or not, stereo or mono, also manual or copy for same. T Carroll, 212-967-4800, 9-7 EST.

**Optimod 8000A** for educ FM upgrade. KC Hill, AECC, POB 2061, Bristol TN 37621. 615-878-6279.

**Fairchild 670** or 660 tube compressor/limiter, Teletronics LA-2A tube compressor/limiter or UREI LA-3A solid state compressor/limiter, call after 3PM CST. 214-271-7625.

## PHONE: 703-998-7600 FAX: 703-998-2966



Call Simone Mullins, Classified Ad Manager, to reserve space in the next issue. Use your credit card to pay, we now accept VISA and MASTERCARD.

**Radio World**  
5827 Columbia Pike, 3rd Floor  
Falls Church, VA 22041

#### Select from these categories for best ad positioning:

Acoustics	Consoles	Software
Amplifiers	Disco-Pro Sound Equip.	Stations
Antennas & Towers & Cables	Financial Services	Stereo Generators
Audio Production (Other)	Leasing	Tapes, Carts & Reels
Brokers	Limiters	Tax Deductable Equipment
Business Opportunities	Microphones	Test Equipment
Cart Machines	Miscellaneous	Transmitter/Exciters
Cassette & R-R Recorders	Monitors	Tubes
CD Players	Receivers & Transceivers	Turntables
Computers	Remote & Microwave Equip.	Positions Wanted
	Satellite Equipment	Help Wanted

#### Classified Advertising Rates Effective January 1, 1994

	1x	3x	6x	12x
1-9 col inch (per inch)	\$60	58	54	49
10-19 col inch (per inch)	55	52	49	44
Distributor Directory	100	95	90	85
Professional Card	65	60	55	50
Classified Line Ad		\$1.50 per word		
Blind Box Ad		\$10 additional		

To compute ad costs: Multiply the number of ad inches (columns x inches) by the desired rate schedule for your per unit cost. Example: a 3" ad at the 1x rate is \$180, at the 3x rate \$174, at the 6x rate \$162, at the 12x rate \$147, etc.

## DISTRIBUTOR DIRECTORY

The following distributors serving the broadcast industry would be glad to help you with any of your requirements.

... Canada, the Caribbean, Shannon to Shanghai, the dynamite Fifty ...

RADIO! The beat goes on!

**CROUSE-KIMZEY OF ANNAPOLIS**

tops in broadcast equipment

1-800-955-6800

ask for Kathleen

**CORNELL-DUBILIER MICA CAPACITORS**

FROM STOCK

**JENNINGS VACUUM CAPACITORS**

FROM STOCK

**JENNINGS VACUUM RELAYS**

**SURCOM ASSOCIATES**

2215 Faraday Ave., Suite A  
Carlsbad, California 92008  
(619) 438-4420

## MICROPHONES

### Want to Sell

AKG C34 stereo mic w/remote, cable, Suspend mount, windscreen & carrying case, \$1450; (2) AKG 414B ULS matched pr, \$1600; (2) Nakamichi CM300 w/2 capsules & case, \$600. J Burke, Reels on Wheels, 2824 Sherwin, Chicago IL 60645. 312-338-1977.

RCA 77DX-44BX, chrome, excel cond, BO over \$800 for ea. RF Burns, RF Studios, 1326 High Meadow Dr, Garland TX 75040. 214-271-4386.

Electro Voice RE27ND's (2), new, still in case, \$425 ea/\$800 both. W Harris, WNPC, POB 189, Newport TX 37821. 615-623-8743.

AKG C422EB in excellent condition, \$1850; AKG D-140 dynamic cardioid mic, \$225/pair; HME System 82 diversity wireless mic system, complete, \$425. R Streicher, Pacific AV Entertainment, 545 Cloverleaf Way, Monrovia CA 91016. 818-359-8012.

HME-WM 252 wireless w/S58 mic, \$195. J Price, 214-321-6576.

Audio Technica 811 bidirectional mic, \$100; Gitzo 14' fishpole/internally wired with AT microphone mount, used, good condition, \$80. Raider Prod, 215-889-9565.

Audio Technica 813 mics, \$150 ea. R Suraci, Fine Art Prod, 67 Maple St, Newburgh NY 12550. 914-561-5866.

EV RE10 dynamic cardioid mics (10), \$85/ea. J Anderson, Regent Univ, 1000 Centerville Tpke, Vir Bch VA 23464. 804-523-7417.

Manley Labs CR3A, new, \$795 w/shockmount, windscreen & case, no risk trial in your studio. Also have used mics & everything else. Get our catalog! Liberal trade policy too. Audio Village, 619-320-0728.

### Want to Buy

Three studio mics, prefer RE-20's w/mounts for educ FM upgrade. KC Hill, AECC, POB 2061, Bristol TN 37621. 615-878-6279.

Need supplier of custom made microphone flags. HA Bridge, KCUL, Box 1326, Marshall TX 75671. 903-935-1410.

Neumanns, AKG, RCA, EV, Sennheiser etc, any cond, for parts, also wireless mics. J Price, 214-321-6576.

RCA 77DXs/44BXs ribbon, chrome/TV grey, good condition, BO. R Kaufman, Pams Productions, POB 462247, Garland TX 75046. 214-271-7625, after 3PM CDT.

Neumann U87s, KM84s, AKG 451s, EV RE20s, Sennheiser 421s. W Gunn 619-320-0728.

77-DX's, 44-BX's, WE KU-3A's On-Air lights, recording lights & audition lights. Top price paid. Fast response. Bill Bryant Mgmt, 2601 Hillsboro Rd, G12, Nashville TN 37212. 615-269-6131, FAX: 615-292-3434.

## MISCELLANEOUS

### Want to Sell

Strantron equipment racks, standard 19" wide, 70" high x 30" deep, includes locking rear doors. Color royal blue with light gray trim. Excellent condition, 3-years old. Also available corner rack connector units. Priced for immediate sale! Call Ken at 801-269-1144.

Time & Temperature TTA-1 PC based telephone service, 2 lines with forecast option & commercial rotation, on line now demo, like new, \$3000. B Wilson, WTND, 207 Glenburnie Dr, New Bern NC 28561. 919-514-2100 X124.

Rotron Blowers for Elcom, Harris, CCA, CSI, McMartin, rebuilt & new. Goodrich Enterprises Inc. 11435 Manderson St. Omaha, NE 68164 402 493 1886 FAX 402 493 6821

Choke 15 hy 5 kV 400 mA, not swinging, will trade an MC-60 amp & C-8 audio compensator by McIntosh, amp has bad output xfmr. Fred, 6922 Furness Ave, Oxon Hill MD 20745. 301-567-2012 (eves).

360 Systems AM161B, 16x16 digital patchbay w/XLR Elco breakout box, \$800. W Sarokin, Sarokin Films, 23 Rutland St, Mt Kisco NY 10549. 914-666-0233.

Peerless 458116-20 input transformers, 600 ohm input, 60 K ohm output (8), 8 pin octal base, \$15/ea. S Lawson, KAK Products, 928 Hyland Dr, Santa Rosa CA 95404. 707-528-4055.

Triad A-10-J input transformer (2), 150/600 ohm input, 60K ohm output, \$40/pr. S Lawson, KAK Products, 928 Hyland Dr, Santa Rosa CA 95404. 707-528-4055.

Altec 1579A equalized transistor amp for magnetic phono pickup, octal 8 pin base, \$25. S Lawson, KAK Products, 928 Hyland Dr, Santa Rosa CA 95404. 707-528-4055.

### AUDIO TRANSFORMERS



- LOW DISTORTION - 2% THD @ 30 Hz
- BROAD FREQUENCY RESPONSE 10 Hz to 20 kHz
- MAGNETIC SHIELDING 10:30 60 dB
- VARIOUS MECHANICAL CONFIGURATIONS
- 50 TYPES STOCKED FOR DELIVERY
- 20% DISCOUNT ON PREPAID ORDERS PLUS FREE SECOND DAY AIR

MODEL	IMPEDANCE (Ω)	MAX. PWR (W)	PRICE
MR 72	150000	150000	37.25
MR 80	150000	150000	38.75
MR 84	150000	150000	29.60
MR 85	150000	600	29.60

FREE CATALOG OF AUDIO ACCESSORIES  
USA & CANADA ORDERS (800) 634-3457 FAX ORDERS (800) 551-2749  
SESCOM, INC.  
2100 WARD DR  
HENDERSON, NV 89015 USA  
TECH LINE: (702) 565-3993 M-Th 9am to 4pm (PST)  
Prices will be adjusted by our software each 4th anniversary of a product's sale.

Circle (170) On Reader Service Card

Northern Technologies TCS-LAPE surge suppressor, 240 V, 3 phase Delta configuration, 3 yrs old, great cond, \$700 plus shpg. D Morgan, KJYE, 1360 E Sherwood Dr, Grand Jct CO 81501. 303-241-9230.

TRW adjust amp loads, 300 W rated, 8 ohms, \$50/pair. R Glen, WJGR, 1718 Shannadoah Rd, Wimauma FL 33598. 813-634-1940.

Magnatek 223-3212, Jefferson Electric dry transformers (2), input 240 V Delta, out 208 V WYE, \$700 each plus shipping. D Morgan, KJYE, 1360 E Sherwood Dr, Grand Jct CO 81501. 303-241-9230.

IBM Quietwriter 14 new ribbons, part #1299790, \$20/all; Apple Mac 825 kB internal drives, 3.5" floppy disc (3), \$10 ea. P Russell, Bowdoin College, Sills Hall, Brunswick ME 04011. 207-725-3066.

### Want to Buy

Cutting lathes, Neumann, Westrex, Gramplan, tube amps, 16" tables/arms, 45/78 records. K Gutzke, Custom Recording, 7134 15th Ave S, Minneapolis MN 55423. 612-866-6183.

Radio transformers by Chicago, UTC, Triad, Peerless, Freed, Sola, send list. J Gangwer, 942 32nd St, Richmond CA 94804. 415-644-2363.

Jazz record collections, 10" LP/12" LP be-bop, swing, dixie, highest prices paid. B Rose, Program Recdgs, 228 East 10th, NYNY 10003. 212-674-3060.

## MONITORS

### Want to Sell

Belar FM RF amp currently tuned to 107.1, \$400/BO. R Wynne, KFLS, POB 1450, Klamath Falls OR 97601. 503-882-4656.

Gorman Redlich EBS encode/decoder, hardly used with manual, money order/certified check, \$250 plus shpg. B Dickerson, WEAG, 1421 S Water St, Starke FL. 904-964-5001.

Belar AMM-2 AM mod mon, \$250. C Porter, WCAZ, POB 498, Carthage IL 62321. 217-357-3128.

Gates GTMM-88S stereo capable mod mon, tuned to 99.3 MHz, \$75. B Williams, KOOL 106.1, 918-455-9522.

### Want to Buy

Belar FMM-2 & FMS-2. M O'Drobinak, 619-758-0888.

FM mod & stereo monitors needed immed for new non-commercial 90.3 FM going on air in March, working/solid state only, inexpensive or donations, will pay shipping. M Sophos, WDFH, 21 Brookside Ln, Dobbs Ferry NY 10522. 914-693-3963, 4PM-midnight.

McMartin or Belar 67 kHz SCA mod mon. J Pearce, WKRS, 3250 Belvidere Rd, Waukegan IL 60085. 708-336-7900.

Phase monitor at least 5 twr positions. George, WNQM/WWCR, 1300 WWCR Ave, Nashville TN 37218. 615-255-1300.

McMartin (buy & sell) any model. C Goodrich, 11435 Manderson, Omaha NE 68164. 402-493-1886 or fax 402-493-6821.

## RECEIVERS & TRANSCEIVERS

### Want to Sell

Zenith TransOceanic AM SW port tube type, w/kg gd cond, \$50 + shpg. E Lightman, WEDL, 550 Merchant St, Ambridge PA 15003. 412-266-2802.

### GCR-201

25, 40 & 80 Amps, 17,000 Volts



Features:

1. Lowest priced RF contactor in the world.
2. Large microswitches; powerful solenoids.
3. 50% less moving parts than competition.

GELECO:  
Ph: (416) 421-5631  
Fax: (416) 421-3880

## SCA RECEIVERS—ALL TYPES

Reading Service / Ethnic / Data Professional / Table Will work to meet your receiver needs

DAYTON INDUSTRIAL CORP. (Manufacturer)  
2237 Industrial Boulevard  
Sarasota, FL 34234  
Tel: 813 351 4454 FAX: 6081

GE Exec II 35 W base station, desktop w/mic & PL UHF or VHF, \$125; GE 2 meter repeater for split site, UHF link, 25 W, \$150. P Russell, Bowdoin College, Sills Hall, Brunswick ME 04011. 207-725-3066.

## AM STEREO RECEIVERS

From \$34.95 Portable, Home, Auto RRADCO  
Phone/FAX 708-513-1386

Auto Labs parts avail, tuned to 1490 or 1340. G Erway, KKS, POB 40309, Santa Barbara CA 93140. 805-568-1444.

Professional SCA demod card with excellent crosstalk rejection, \$20; Superadio III with SCA, \$85, performance guaranteed. 1-800-944-0630.

### Want to Buy

McIntosh, Dynaco tuners, preamp, pwr amps, also need RCA-Tugsol 6550 tubes, Goldion/Genelex, etc. R Glen, WJGR, 1718 Shannadoah Rd, Wimauma FL 33598. 813-634-1940.

**Advertise!**  
Call 800-336-3045 for details

# SERVICES

### Get Legal!

Q: How are we going to comply with the new emission rules for AM stations without a splatter monitor or spectrum analyzer?  
A: For \$500, you can comply with the new \$73.44 spec. Call Tony Dinkel at Microwave Frequency Services. Services available in Southern/Central CA, AZ and NV. Service area will expand if demand dictates.  
**1-800-2-GET-LEGAL**  
or fax at 310-425-6299 both #s 24 hrs.

### Tower Sales & Erection

Turkey Site Development Installation & Maintenance AM/FM Broadcast, TV Microwave Systems, Antennas & Towers  
**TOWERCOMM**  
Communications Specialists  
6017 Triangle Dr Raleigh, NC 27613 (919) 781-3496  
Ben Wall President Gen. Contractor #25991 Fax (919) 781-6454

### REMOTE EQUIPMENT RENTALS

COMREX and GENTNER 1, 2 & 3-Line Extender Systems Now With The New GENTNER EFT-3100 MARTI VHF/UHF RPU Systems Switched-56 Systems Call or FAX Dwight Weller  
WELLER AUDIO-VISUAL ENGINEERING Baltimore, MD  
Phone: (410 or 800) 252-8351 FAX: (410) 252-4261

### LOCATION SERVICES IN THE UNITED KINGDOM

Planning remotes from the U.K.? we provide a comprehensive service  
• we organize venues for your shows  
• we provide temporary equipment  
• live links via ISDN/Switched 56  
• experienced radio engineers  
• we help you line-up guests  
Contact New York (212) 229-9118  
Good Morning from Great Britain Wired for Sound Ltd., London N15

### PC - SOFTWARE

AM FM TV Search Programs Contour Mapping-STL Paths RF HAZ-1990 POP Count FAA Tower-Draw Tower  
Doug Vernier Broadcast Consultant 1600 Picturesque Dr Cedar Falls, IA 50613  
**800-743-DOUG**

### EVANS ASSOCIATES

Consulting Communications Engineers  
TV • FM • AM • ITFS • Satellite FCC Applications, Design and Field Engineering  
Video/Data/Voice • Light Fiber & Microwave • Wide-Area Networks & STL's  
216 N. Green Bay Road Thiensville, WI 53092  
(414) 242-6000 • FAX (414) 242-6045  
Member AFCCCE

### W. LEE SIMMONS & ASSOC., INC.

BROADCAST TELECOMMUNICATIONS CONSULTANTS  
5 Gracefield Road Hilton Head Is., SC 29928  
1-800-277-5417  
803-785-4445  
FAX: 803-842-3371

North America RF & Audio  
**Mirkwood Engineering Services**  
Broadcast and Telecommunications Consultants  
Multidiscipline Engineering and Planning Firm including • Application & Allocation Services  
• Project, Engineering & Construction Management • Site Acquisition  
• Rural & Remote Site Installations  
• Field Service • Studio Design & Installation  
50 Park Ave. Claremont, NH 03743 (603) 542-6784

### MLJ

Moffet, Larson & Johnson, Inc. Consulting Telecommunications Engineers  
Two Skyline Place, Suite 800 5203 Leesburg Pike Falls Church VA 22041  
(703) 824-5660  
FAX: 703-824-5672  
Member AFCCCE

### GOODRICH enterprises, inc.

Parts and technical service for all MCMARTIN TRANSMITTERS, CONSOLES, EXCITERS, RECEIVERS, TRANSMITTER AND INDUSTRIAL TUBES.  
11435 Manderson St. Omaha, Nebraska 68184 U.S.A.  
PH: 010-1-402-493-1886 FAX: 010-1-402-493-6821

### T. Z. Sawyer Technical Consultants

AM-FM-TV-LPTV

- FCC Applications & Exhibits
- Frequency Studies
- Experimental Authorizations
- Class Upgrades
- AM Directional Antennas
- LPTV Applications
- High Power Antenna Arrays
- Station Inspections
- Site Selection Assistance
- STL Applications
- Antenna Measurements
- LMA/Duopoly Studies

**1-800-255-2632**  
FAX: (301) 913-5799 • 6204 Highland Dr. • Chevy Chase, MD 20815

### MULLANEY ENGINEERING, INC.

Consulting Engineers  
• Design & Optimization of AM Directional Arrays  
• Analysis for New Allocation, Site Relocation, and Upgrades  
AM-FM TV-LPTV Wireless Cable (MDS/MMDs/ITFS/OFS)  
• Environmental Radiation Analysis  
• Field Work  
• Expert Testimony  
9049 Shady Grove Court Gaithersburg, MD 20877  
Phone: (301) 921-0115 Fax: (301) 590-9757

### Consulting Communications Engineers

- FCC Data Bases
- FCC Applications and Field Engineering
- Frequency Searches and Coordination
- AM-FM-CATV-ITFS-LPTV

**OWL ENGINEERING, INC.**  
1306 W. County Road, F, St. Paul, MN 55112 (612) 631-1338 Member AFCCCE

Contact Radio World Newspaper for availabilities  
P.O. Box 1214 Falls Church VA 22041  
**1-800-336-3045**



## REMOTE & MICROWAVE EQUIPMENT

### Want to Sell

Marti STL 8 & STL 10 type approved on 951.5 & 947.125 both in gd cond, STL10/\$2000, STL8/\$1500. J Black, KSEN, 830 Orfield Ave, Shelby MT 59474. 406-434-5241.

Marti STL-10 stereo (2) xmtrs (2) rcvrs on 950.375 & 950.625, type approved under new rules, \$3000/both. J Gallagher, WBEC, 211 Jason St, Pittsfield MA 01201. 413-499-3333.

## COMREX RENTALS

1, 2 and 3-Line Extenders Switched 56 Systems  
Call Steve Kirsch for details  
Silver Lake Audio  
(516) 623-6114 FAX: 377-4423

TFT STL units (2) receivers, (2) transmitters, on pair on 450.98 & other on 450.01, both work great. Jeff, 703-297-1188.

QEI Cat Link, needs repair, not in service, \$6000/BO. D Fielder, WVLT, 638 Landis Ave, Vineland NJ. 609-692-8888.

Moseley MRC-1600 telco boards, \$40. S Swanson, KBNL, Box 440029, Laredo TX 78044. 210-724-9211.

MCI RSU-10 STL rcvr switcher, automatically selects backup rcvr if main rcvr fails, \$25; GE Master II VHF mobile 2-way radios, 100 W RF out or 170.150, \$100 ea. M Everhart, KXYQ, 111 SW 5th #11550, Portland OR 97204. 503-226-6731.

## RENTALS RENTALS RENTALS

### COMREX 3-line extender

Frank Grundstein 215-642-0978  
Audio/Video Consultants

BE synchronous booster reference generator, \$1000/BO; Moseley TPR-2 transfer panel for (2) Moseley TBL or STL receivers, \$500; Moseley TPT-2 transfer panel for (2) Moseley TRL or STL transmitters, \$500; Moseley PCL 606/C 950 composite STL system, \$6500. D Irwin, KSOL, 55 Green St, #200, San Francisco CA 94111. 415-616-5768.

Moseley TRC 15 AW remote control in very good condition, \$425. E Duellman, WOMT/WQTC, Box 1385, Manitowoc WI 54221. 414-682-0351.

Moseley MRC1600 (2) studio units, transmitter unit, telco & subcarrier cards included, \$2000. C Porter, WCAZ, POB 498, Carthage IL 62321. 217-357-3128.

Marti RMC-15 16-chnl digital remote cntrl, excl cond w/manuals, \$450. D Igou, KCHL, 8435 Twister Oaks, Garden Ridge TX 78266. 210-651-9049.

Gentner SPH-3A telephone interface system, excel cond w/manual, \$325. R Sumner, CAVU Corp, 3322 Applegate Ct, Annandale VA 22003. 703-968-8894.

### Want to Buy

TFT 8300 receiver unit. P Lotsof, KAVV, Box 18899, Tucson AZ 85731. 602-290-9797.

Harris 9161 remote control, mainframe, CEPs, electr memory modules & high speed comm modules. B Lockhart, KXXY, 101 NE 28th, Oklahoma City OK 73105. 405-528-5543.

Mark 4' grid dish. M Grubbs, NTI, POB 1047, Luling TX 78648. 210-875-2555.

STL, transmitter, receiver, antenna etc for missionary station in Africa, must be in excellent condition, \$1000 plus donation receipt for the difference. K Leatherwood, Believers Broadcasting, POB 1776, Terrell TX 75160. 214-524-1956.

Moseley 505 rcvr & xmtr, pef on 946.00 Mhz, open. C Cooper, WHLC, POB 1889, Highlands NC 28741. 704-526-1045.

Giant Boom Box, good condition, with A/C, trailer..contact Chris Mac, 207-774-4561. Portland Radio, 420 Westem Ave., South Portland, Maine 04106.

## SATELLITE EQUIPMENT

### Want to Sell

Scientific Atlanta 15 kHz DATS cards (2), \$750 ea or \$1500/both. S Tefft, WWSC, 217 Dix Ave, Glens Falls NY 12801. 518-793-4444.

Universal SCPC-100 audio receiver, front panel tuning, 50 channel memory, receiver C & Ku band, new, \$425 plus shipping. D Littleton, WAZF, POB 47, Yazoo City MS 39194. 601-746-2372.

## OuterSpace Experts!

We SELL \*TRADE \*BUY  
SATELLITE EQUIPMENT  
317-962-8596



Adcom 7550 excl cond, BO or trade. B Hill, KACK FM, 106 S Jefferson, Mt Pleasant TX 75455. 903-577-9730.

Wegener 1601-50 mainframe, 1624, 1645, 1646, 1683-08, 1606-01, 1605-03 cards, BO. R LaFore, WSHH, 1459 Crane Ave, Pittsburgh PA 15220. 412-531-9500.

Scientific Atlanta 10' sat dish, excel cond, complete, \$1000. J Alsip, KSCQ, Box 1351, SiLoer City NM 88062. 505-538-3390.

Scientific Atlanta AD7450 SCPC rcvr w/new block down converter, rcvr is 1 yr old w/manual, \$1500 plus shpg. K Austin, KFXI, 1101 Hwy 81 N, Marlow OK 73055. 405-658-2556.



Ariel  
Shipping Now!  
LNB System  
Dart 384  
Compatible  
New 7.5/15 KHz  
Dats Card

24 Hour  
Phone / Fax  
Technical Support  
All Networks  
& Receivers

Satellite Systems  
(719) 634-6319  
(Fax) 635-8151

Scientific Atlanta 7300/7325 DAT-32 rcvr, includes 7.5 audio card, still under-warranty, BO. Write to: Radio World, POB 1214, Falls Church VA 22041. Attn: Box #94-03-02RW.

Scientific Atlanta 7300/7325 DAT 32 terminal system w/all crystals, 7.5 kHz and Sedat decoder card. Excellent condition, \$3750. Call Richard at 404-482-9706.

## SOFTWARE/ DATABASES

### Want to Sell

PC SOFTWARE for Broadcasters. Traffic, Billing, & Accounting. Powerful, inexpensive. Works with automated, satellite or live operations. INTERFACES with popular DIGITAL AUTOMATION SYSTEMS. Try it for 90 days, no obligation.

Absolute Broadcast Automation  
Naples, Florida (813) 643-3689

U.S. RADIO STATION DATABASE: stand-alone program containing 11,700+ stations. Many searches, prints mailing labels. MAC/IBM (specify disk size). Visa/MC \$99.95/yr. (+quarterly updates):

1-800-626-2360 ext. 300  
BBH Software, Inc.

### Circle (19) On Reader Service Card

## STATIONS

5 kW AM DA/3 kW FM WC3 upgrade pending, Cuba MO. K Kuenzie, KSLQ, 511 W 5th, Washington MO 63090. 314-239-0209.

1 kW AM FT in South-Central Virginia single-station town, fully equipped w/3 yr old Nautel xmtr, \$50,000 cash/BO, real estate for lease or sale. G Jones, WODI, 1230 Radio Rd, Brookneal VA 24528. 804-376-5534.

Two stations, AM & FM, good cash flow, gd equip, gd locations, gd weather, wom out owner/operator. Write to: Radio World, POB 1214, Falls Church VA 22041. Attn Box#: 94-03-01RW.

Central West Virginia 25 kW FM, 1 kW AM combo, \$300,000, cash sale. Jim 304-765-7373.

FT AM 1000 W nite, rebuilt from ground up in '92/93, 70 miles N of Houston, presently oldies/talk/rush. BO. J Standefer, KYLR, 1018 12th, Huntsville TX 77340. 409-293-1400.

WVKV in Charleston/Huntington, WV area, 5 kW AM day-directional, \$125,000 cash sale w/o real estate, real estate avail for lease or purchase. Jim, 304-765-7373.

### Want to Buy

Educational non-profit organization seeks dark or troubled FM or AM station. 800-357-4226.

## STEREO GENERATORS

### Want to Sell

Moseley SCG-3T, stereo generator, gd cond, \$350. D Heinen, KRSE, POB 127, Yakima WA 98907. 509-248-1390.

Harris MS-15R stereo gen w/extender card for repairs, alignment, \$125. M Everhart, KXYQ, 111 SW 5th #11550, Portland OR 97204. 503-226-6731.

## TAPES/CARTS/REELS & CD's

### A&D Cart Rebuilding

Do Bad Carts Have Your Temperature Rising?

Let A&D clean, load & pack your carts. They'll be serviced within 10 working days! Guaranteed!

3706 Void Ct. 715-835-7347  
Eau Claire WI 54701 Fax: 715-835-1151

### Want to Sell

Carts, 1500, all kinds & length, all or part, we pay shpg, \$.50/ea. J Bacon, KTAN Radio, POB 2770, Sierra Vista AZ 85636. 602-458-4313.

10" reels (450), Bonneville Ultra format for production use, \$5/ea or \$2000/all. B Hill, KACK FM, 106 S Jefferson, Mt Pleasant TX 75455. 903-577-9730.

Radio sales training tapes, 16 VHS tapes covering 30 topics, excellent, \$2500. R Trumbo, KNLF, 800-397-4146.

AOR prod facility deleting classic library, all on 7" reels, \$300. D Pulwers, Dave's Price Audio, 310 N Howard St #103, Alexandria VA 22304. 703-751-9346.

A/C Gold Disc Library, approx 1400 songs w/complete list in original binder, BO. 800-728-5097.

Hundreds of reels of 1/4", 0.5 mil tape on 10.5" plastic grey & smoked reels, perfect for long form talk show recording for storage or documentation, \$1.25 per reel; 51+, \$1; also have hundreds of 5" reels in boxes, \$0.35 ea. B Williams, KOOL 106.1, 918-455-9522.

Ampex 407 mastering tape, 10.5" reels, 1/4" x 3600', new in box, \$10/reel, \$90/box of 10; 3M/Scotch #20 1/2" x 1000', 2.5 mil uncoated white paper on 7" reel, \$4/reel, \$3/reel/quantity. R Sumner, CAVU Corp, 3322 Applegate Ct, Annandale VA 22003. 703-968-8894.

SONY		MAXELL		TDK		FUJI	
DAT 120	7.49	2111-90	1.89	1-120HS	1.89	400-274	11.49
DAT 120 md	9.99	KL11-590	2.29	1-120EHC	2.49	SVHST120	7.89
1-120V	1.99	KL11-5100	2.69	SA-90	1.79	DR190	7.99
1-120V	2.39	DAT 120	7.99	SAX 90	2.19	JVC	
1-750HG	3.99	1120HG	2.99	HI-8 120	5.99	DAT 120	6.99
400-274	11.99	BM-120	3.49	DAT 180	11.99	SVHST120	6.99

M-F 8-5 VISA, MC, DISC. 220 SPRING ST. BUTLER, PA 16003  
OVER 400 DIFFERENT BRANDS & SAME DAY SHIPPING

Karsky's rewind loop carts. Also sell reconditioned carts. Service guaranteed. Call 605-348-9928.

### Want to Buy

Pre-recorded open reel tapes, 2-track, all categories, labels & artists. P Chance, Imperial Analog, 925 Clinton St, Philadelphia PA 19107. 215-574-8147.

45 rpm record library's, all types, hits, promo, etc. D Schmidt, Midatlantic Radio, POB 11502, Wilmington DE 19850. 302-323-0338.

## MARATHON PRODUCTS COMPANY

### Audio Cartridge Rebuilding Division

Rebuilding/reloading, like new, all brands, any length up to & including 3.5 minutes, \$1.95 ea. FOB out plant, 48 hrs delivery. (New rate effective 9/1/93)

### New NAB Marathon cartridges prices on request.

35 Years professional experience!  
Lifetime member AES R.D. MYERS Sr.  
Manufacturers of Audio Devices, Continuous Tape Mag.

69 Sandersdale Rd. Charlton, MA 01507  
1-508-248-3157 or 1-508-853-0988

### Circle (83) On Reader Service Card

Reels, 10.5" & boxes (30), \$35; 5" reels & boxes, new (125), \$45. L Houck, Rollin Recog, 210 Allgelt, San Antonio TX 78201. 210-736-5483.

Pams Jingles ref tapes, 1951-1976/BO. R Kaufman, Pams Prods, POB 462247, Garland TX 75046. 214-271-7625.

Hot AC music library, mid 60's to 1991, Scotch Cart II & Mastercart Gold, over 1500 songs labeled & timed, computerized list of inventory. G Osborn, WLKI, Box 999, Angola IN 46703. 219-665-9554.

Easy listening, instrumental, music library on reel, disc or cart. G Hammond, Broadcast Specialties, 1308 Goffstown Rd, Manchester NH 03102. 603-669-1605.

Live music on disc, rare shows of top rock acts, Beatles, N Young, Clapton, etc, also like to trade DAT only. R Barth, RB Prod, 3113 Ivy Chase Way, Atlanta GA 30342. 404-333-7200.

Fidelipac/Audiopak Mastercart II gold or AA-4 light blue in 2:30 through 4:00 lengths, must be in very good condition, call after 3PM CST. 214-271-7625.

## TAX DEDUCTIBLE

### Want to Sell

New non-comm has its CP, need all types of studio equip, CD & cart machines, consoles, TTs, EBS, mics, etc 501(c)3. J Wong, KOOP-FM, POB 49340, Austin TX 78765. 512-472-5667.

Christian mission needs studio equip, stereo gen, exciter, 175' twr, 600' 1 5/8" or 3" coax for FM, will pay shpg & PU. L Harper, Western Indian Ministries, POB F, Window Rock AZ 86515. 505-371-5587.

Non-profit 501C-3 needs console, cart machines, R/R, SCA rcvrs & automation equip. J Hayes, CVM, 1101 NW 43 Pl, Des Moines IA 50313. 515-244-2848.

Campus radio station needs cart machines, R & R/P, amps, cassette/reel decks & low pwr RF equip, prefer FM. E Welch, Toccoa Falls College, POB 800836, Toccoa Falls GA 30598. 706-886-6831 X5269.

Ed radio 501C-3 needs studio, prod equip, lw pwr xmtrs, shpg & receipt provided. Dr Newcomb, 216-693-4125 or 216-548-2053.

Church wants to bdct services, need any equip you can part with, will pay transportation cost & or shpg, will provide a tax deduction letter. S Mongeau, Emmanuel Baptist Church, 14 Mammoth Rd, Hooksett NH 03106. 603-627-3585.

Peerless Panorama TV camera dolly, Mole/Rich port mic boom, equip must go to a 501 (C) (3) organization, fed tax exempt. K Van Prooyen Sr, Sight Seer Inc, Grand Rapids MI 49505. 616-363-8838.

## TEST EQUIPMENT

### Want to Sell

Potomac Instruments AT-51 audio test set, complete w/IX-51 transformers, cables, books, mint cond, \$5000. J Seaman, 301-540-2089.

Nicolet Scientific 4A computing spectrum analyzer, \$100. B Dickerson, WEAG, 1421 S Water St, Starke FL. 904-964-5001.

## This is One Crate Opening You Can't Afford to Miss!



If a new transmitter is in your plans...

Plan now to see the 'Next Generation' of FM transmitters

We'll uncrate the Transmitter of the Future

at NAB Booth #5408

## Building FM's Future... Today!



"The Transmitter People"

Energy-Onix

752 Warren Street  
Hudson NY 12534

518-828-1690  
FAX: 518-828-8476

### Circle (201) On Reader Service Card

**TEST EQUIPMENT...WTS**

HP 5245L microwave freq counter w/(2) plug-in freq converters 5253B & 5255A, other converters avail thru surplus sources, \$800. J Seaman, 301-540-2089.

Potomac AA51, distortion analyzer, new in carton w/book, \$1500; Hewlett-Packard HP-334A, gd cond, \$500. C Porter, WCAZ, POB 498, Carthage IL 62321. 217-357-3128.

Hewlett-Packard audio oscillator in gd cond, works fine, large older oscillator, \$50 plus shpg. D Morgan, KJYE, 1360 E Sherwood Dr, Grand Jct CO 81501. 303-241-9230.

HP 33A dist analyzer w/manual, \$595; Waveform 520-A RMS/DBM sensitive volt meter -60 dB to +50 dB, \$100; Ithaco 4302 dual 24 dB/octave hi-lo-pass filter 1/10 to 1 MHz, \$295. J Price 214-321-6576.

Tektronix 529, mod 188D waveform monitor, multi-standard version w/PAL frame selector, excel cond, \$525; Tektronix 520A NTSC vectorscope, measures amplitude & phase of color video signal, excel cond w/manual, \$1495; Tektronix 454A portable 150 MHz dual trace oscilloscope, calibrated sweep delay, excel cond w/manual, \$495. R Sumner, CAVU Corp, 3322 Applegate Ct, Annandale VA 22003. 703-968-8894.

BIRD 3128 wattmeter alarm/RF power monitor, up to 10 kW, 450 kHz to 2300 MHz, mint cond w/manual, \$350. R Sumner, CAVU Corp, 3322 Applegate Ct, Annandale VA 22003. 703-968-8894.

HP 334A 5 Hz to 600 Hz, auto nulling, 0.1% distortion, AM detector covers 550 kHz to 65 MHz, excellent condition w/manual, \$795; Bruel & Kjaer 2033 high res FFT sound & vibration analyzer, 0-20 kHz, 11 baseband ranges, amplitude of 40 dB, 80 dB & linear, excel cond w/manual, \$3995. R Sumner, CAVU Corp, 3322 Applegate Ct, Annandale VA 22003. 703-968-8894.

Technics SL-1290 MK2 (2), \$275 ea. G Dunn, No Cal News, 5383 Willow Lake Ct, Byron CA 94514. 510-516-0299.

Leader LSG-17 100 kHz to 450 MHz signal generator, excellent condition, \$85/BO; B & K 520 transistor checker/test in circuit or out with leads, \$125/BO. R Glenn, WJGR, 1718 Shannadoah Rd, Wimauma FL 33598. 813-634-1940.

BIRD 3171 high speed Wattmeter RF monitoring system with out line section, \$50; Tektronix 7603 oscilloscope main-frame & power supply, \$50. M Hendrickson, Hedberg Broadcasting, POB 249, Blue Earth MN 56013. 507-526-4044.

**Want to Buy**

Pink & white noise gen, battery operated preferred. M Cohen, Acoustic Consulting, POB 80145, Lincoln NE 68501. 402-476-8427.

**TRANSMITTERS**

**Want to Sell**

Harris THE-1 FM exciter, like new cond, \$3000. J Gallagher, WBEC, 211 Jason St, Pittsfield MA 01201. 413-499-3333.

AEL 1978 25K 25,000 W FM xmtr, very clean in excellent condition, \$13,000; QEI Q30000 1989 30,000 W QEI 30000 FM xmtr in excellent condition, \$28,500; CSI 3 kW in excellent condition, \$12,900. R Michaels, KQFX, POB 7762, Amarillo TX 79114. 806-355-1044.

**DEMOED EQUIPMENT**  
BEXT Inc. has a few demoed exciters, amplifiers and STL's for sale. All demoed systems are sold first come first served and have the same 2 year warranty as BEXT's new equipment. For information:  
**619-239-8462**

Gates Harris FM5C complete with manuals, good condition, no exciter, \$3800/BO. M Kestler, KAWZ, 241 Main Ave W, Twin Falls ID 83303. 208-733-3133.

Harris MS-15 exciter, just removed from service & in excel cond, \$2500. C Murray, KMGE. 503-484-9400.

RCA BTF-5B 5 kW FM on 92.1 MHz, removed 12/93, no exciter, \$3500/BO. G Reinmeimer, WYYD, POB 4108, Lynchburg VA 24502. 804-237-4700.

ITA FM-15000B, 15000 W power amp, 1000 W in, 10000-15000 W out, Best Offer. A Weiner, WHVW, 507 Violet Ave, Hyde Park NY 12538. 914-471-9500.

**FM - TRANSMITTERS**

Factory new not used. Why buy a used Transmitter when you can own a new FM Transmitter for about the same cost? Call JIMMIE JOYNT at 214-335-3425.

Collins 21-E 5 kW AM tuned to 550 kHz, vgc, still in use, \$5000 POB Puerto Rico. A Gimenez, WPAB, Box 7243, Ponce PR 00732. 809-840-5550.

RCA BTE-15A 15 W exciter, just removed from service, composite input cable, crystal for 96.7, manual, \$800/BO + s & h. C Binder, WZOS-FM, 38 E Bridge St, Oswego NY 13126. 315-342-9600.

Harris BC500H 1110 kHz 500 W, 250 W, can go to 1 kW as is, \$1500. C Porter, WCAZ, POB 498, Carthage IL 62321. 217-357-3128.

RCA BTA-5T tuned to 620 kHz, used as main '63 to '80, used as standby '80 to '93, gd cond, \$5000. D Kannes, KTAR/KKLT, 301 W Osborn Rd, Phoenix AZ 85013. 602-274-6200.

**Exciters: McMartin B-910** tuned and calibrated to your frequency, guaranteed. Mono, stereo, SCA, Goodrich Ent. Inc. 11435 Manderson St, Omaha, NE 68164. 402-493-1886 FAX: 402-493-6821

LPB T-X222 carrier-current AM xmtrs (6) at 600-620 kHz, oper freq, range from \$250 to \$400/ea. C Pace, Evangel College, 417-865-2811 ext 7364.

CCA 3000 kW DC, 1972 in excel cond w/Harris MSL5 exciter, \$8500. I Griffin, WJDB, POB 219, Thomasville AL 36784. 205-636-4438.

Energy Onix 5.5 kW 3 yrs old, on air for 3 yrs w/no problems, upgraded to 50 kW, \$12500 or w/QEI exciter, \$15K. E Seeger, WMXT, 2704 S Irby St, Florence SC 28505. 803-661-5000.

Collins 830F-1A 250 W w/spare tubes & manual, recently removed from svc, \$1500 plus shpg. K Austin, KFXI, 1101 Hwy 81 N, Marlow OK 73055. 405-658-2556.

Harris MW1A tuned to 1340, excel cond, \$7000. J Alsip, KSCQ, Box 1351, Siloer City NM 88062. 505-538-3390.

McMartin BA-1K, excl cond, tuned to 1450 kHz, kept in AC's room. R Vega, WOCN, 305-759-7280.

Gates BC-2T 1 kW AM tuned to 1470, spare tubes, gd cond. D Barron, KWJM, 113 N Main, Farmerville LA 71341. 318-368-3094.

Harris MW-1A solid state 1 kW AM, excellent condition, on air 1410 kHz, spares, \$8500. 816-628-5959.

LPB 100P tuned to 1460, 100 W or less, like new in excl cond, \$3000. R Swan, WROY/WROL, 101 N Church, Carmel IL 62621. 618-382-4161.

Full Class A FM package with mix of new & used. Harris FM-2.5H3 transmitter, 8000A Optimod, ERI antenna, coax, studio, etc. Call 816-628-5959.

Spare parts for CCA AM50,000D, incl HV transformer, mod. transformer, mod. reactor, HV filter choke, tube sockets and more. Call Transcom Corporation 800-441-8454 or 215-884-0888.

**Want to Buy**

Modulation reactors for 1 kW AM xmtr; Collins 20V or 20V2 AM xmtr in gd cond, Buffalo NY area. T Scher, 716-634-2545. 10A-4PM EST.

CSI 10 or 20 kW or 25 kW. R Michaels, KQFX, POB 7762, Amarillo TX 79114. 806-355-1044.

Best 20 W translator. A Clawson, WFFF, 1715 Michigan St, Sturgeon Bay WI 54235. 414-743-7443.

Harris BC5H audio driver for BC5H. G Patschke, KIJN, Box 458, Farwell TX 79325. 806-481-3318.

2.5 kW to 25 kW FM for educ FM upgrade. KC Hill, AECC, POB 2061, Bristol TN 37621. 615-878-6279.

CCA 3000 D (3) or similar CCA FM xmtr, prefer snl phase, open. C Cooper, WHLC, POB 1889, Highlands NC 28741. 704-526-1045.

Nautel 1 kW AM xmtr. J Frew, WYXC, 1410 Hwy 411 NE, Cartersville GA 30120. 404-382-1270.

5 kW FM with exciter in excellent cond, on 93.0, missionary station in Africa, \$5000 plus donation receipt for difference. K Leatherwood, Believers Bldg, POB 1776, Terrell TX 75160. 214-524-1956.

McMartin AM/FM transmitter, any model, exciter or stereo modules. Goodrich Enterprises, 11435 Manderson, Omaha NE 68164. 402-493-1886.

**TUBES**

**Want to Sell**

**D and C Electronics Co.**  
**Lowest Price on Tubes including:**  
4-1000A/3-1000Z/  
8B77/4CX250B/833A  
4-500/5-500/4-400/  
4CX 3500/5CX1500  
and much more!  
Factory Warranty!  
**1-800-881-2374**  
**(904) 688-2374**  
Se habla Español  
FAX: (904) 683-9595

**ECONCO**  
Quality Rebuilt Tubes  
Approximately 1/2 the Cost of New  
Call for Our Price List  
**800-532-6626**  
**916-662-7553**  
**FAX 916-666-7760**  
Grde (212) On Reader Service Card

**REBUILT ELECTRON TUBES**  
Partial List: 6623, 23791, TH150, 6425F, 5604, 6696, 6697, 5681, 5682, 5671, 7804, 3CX10,000H3, 3CX20,000H3, 4CX5000A, 4CX35,000C  
Worn out power tubes purchased  
**Vacuum Tube Industries, Inc.**  
**1-800-528-5014**  
**508-584-4500 X75**

4CX250B, 4-400, 833, 813, 5CX1500, 4-1000, all types, full warr EIMAC, Amperex, RCA. Westgate 800-213-4563.

**For the Best Price**  
& 24 Hr service on transmitting tubes call 402 493 1886 day or night. FAX 402 493 6821.

**Svetlana**  
ELECTRON DEVICES  
**Quality\* Power Tubes**  
4X150A 4CX15,000A  
4CX250B 4CX15,000J  
4CX250BC 5CX1500A  
4CX250R 5CX1500B  
4CX350A 8560AS  
• Watch this list grow.  
• Manufactured in Russia's largest power tube factory.  
• Generous\* warranty based on high quality.  
• Honest prices based on quality at low cost.  
• Shipment from USA stock. See Us At NAB Booth 10262

**Broadcasters**  
Call: 800-239-6900  
FAX: 205-880-8077  
OEMs, Distributors, Volume Purchasers  
Call: 415-233-0429  
FAX: 415-233-0439

**Want to Buy**  
RCA 8021 transmitting tubes. A Weiner, WHVW, 507 Violet Ave, Hyde Park NY 12538. 914-471-9500.

VACUUM POWER TUBE REBUILDERS SINCE 1940  
Freeland Products, Inc.  
*"If you don't need TO SAVE MONEY we can't help you."*  
However, if saving money interests you...  
WE CAN REBUILD YOUR DUDS (used tubes) for about 1/2 the cost of new tubes!  
Call TODAY 1-800-624-7626 For a FREE Information Packet  
WE BUY MANY TYPES OF USED TUBES

**WANTED!**  
**Electron Tubes**  
All Kinds & Quantities  
Metal Case Caps  
Black Beauties  
*Hurluff Enterprises*  
**CHARLIE DRIPPS**  
4331 MAXSON RD.  
EL MONTE, CA 91732  
(618) 444-7079 • (800) 334-8223  
FAX (618) 444-6863

**TURNTABLES**  
**Want to Sell**  
JVC 44-DD-5 quadrophonic disc demodulator, low hours, \$50. D Pulwers, Dave's Price Audio, 310 N Howard St #103, Alexandria VA 22304. 703-751-9346.

Technics SL 1200 with tonearm & amp, good shape, \$295. G Erway, KKSB, POB 40309, Santa Barbara CA 93140. 805-568-1444.

Technics SL 1200 MKII with cartridge & road case, good working condition, \$350/Best Offer + shipping. F Stadler, Fred Stadler Production, 3912 Liberty, Westmont IL 60559. 708-960-4545.

**Want to Buy**  
Stereo cartridges, arms and other Fairchild products. D Bisbee, 685 S Rlys, Columbus OH 43204. 614-279-6163.

**Advertising Space is AVAILABLE!**  
call  
**800-336-3045**

**TRANSCOM CORP.**  
*Serving the Broadcast Industry Since 1978*  
Fine Used AM & FM Transmitters and Also New Equipment  
For the best deals on Celwave products, Andrew cable and Shively antennas.

1 kW FM 1978 Collins 831C2	1 kW AM 1974 Harris BC1H1
2.5 kW FM 1978 CCA 2500R	1 kW AM 1978 Harris MW1A
3 kW FM 1975 CCA 3000D	1 kW AM 1988 Harris SX1A
3 kW FM 1982 Elcom Bauer 603B	5 kW AM 1968 CCA AM5000D
3 kW FM 1974 Harris FM3H	5 kW AM 1979 Continental 315F
5 kW FM 1979 CCA FM5000E	5 kW AM 1968 Harris BC5H
5 kW FM 1968 Harris FM5H	5 kW AM 1977 RCA BTA 5L
5 kW FM 1987 Harris FM5K	10 kW AM 1983 Harris BC10H

1077 Rydal Road #101  
Rydal PA 19046  
**800-441-8454 • 215-884-0888 • FAX No. 215-884-0738**

**PETER DAHL CO.**  
*Save \$\$*  
Heavy Duty Replacement Transformers, DC Filter chokes and capacitors for AM & FM transmitters manufactured by: AEL, CCA, CSI, COLLINS, CONTEL, CONTINENTAL, BAUER, GATES, GE, HARRIS, ITA, McMARTIN, RAYTHEON, RCA, SINGER, SINTRONIX, WILKINSON.  
Many other models also available.  
FAST Delivery and FREE Technical Support.  
—Write For Free List—  
5869 WAYCROSS AVENUE, EL PASO, TEXAS 79924  
(915) 751-2300 FAX: (915) 751-0768





Andy & Debbie Montgomery and Capt'n. Pat Adams, the morning team at KIX-106 in Memphis, Tennessee.

# We Make a Good Team!

KIX-106 is the number one country music radio station in the Memphis area. When they decided to remodel and expand their studios, the most carefully researched item on the equipment list was a new console for their on-air studio.

So they purchased the Auditronics 800 Series console.

Doug Gossett, their engineer, said some really great stuff about it, but we didn't want to get technical. Let's just say the specs are definitely superior.

However, Andy Montgomery, one-third of the KIX-106 morning team, said some really good stuff too... "Our entire studio is designed around the Auditronics 800. You might say that the 800 and, of course, Debbie are at the center of everything (Debbie's my wife, so I had to say that). It's reliable and it's sturdy. Have you ever spilled a cup of coffee or a soda on your console and everything shuts down? I don't recommend it, but so far this hasn't been a problem for the 800. It's so versatile. It does everything I need and it always works. That sure makes my job a lot easier. Debbie, Cap'n Pat, the 800 and I make a good team!"

"It's hectic on our morning show and we get lots of phone calls, especially Debbie. This new telephone mix minus system makes them so much easier to handle."

"There are always the three of us on the air in the morning, but it's not unusual to have 5 or 6 people in the studio and on the air at the same time ... plus the music, the commercials and the phone calls. And we still haven't begun to max out the console. It's so reliable that I don't think Doug has had to make even a minor adjustment or anything since we started using it."

If you want to find out what Doug and other users had to say about the Auditronics 800 console, call your favorite Auditronics dealer or Auditronics today.

*The Sound Of Perfection*

**AUDITRONICS**

3750 Old Getwell Road, Memphis, TN 38118  
901-362-1350, FAX: 901-365-8629

# Every City Has One.



**A Number One Station.**

The A-6000 On-Air Console is for you.

 **Wheatstone<sup>®</sup> Corporation**

7305 Performance Drive, Syracuse, NY. 13212  
(tel 315-452-5000 / fax 315-452-0160)