

Two File For Digital Radio

by Alan Carter and Benn Kobb

Washington DC Two separate proposals for direct broadcast satellite radio—each taking a different approach—that would launch US radio into a new digital era were announced 18 May and filed within days of each other at the FCC.

Satellite CD Radio of Washington, DC, filed a petition 18 May to establish a new, digital, "CD-quality" radio service between 1460-1530 MHz, now used for flight test operations. The service would be provided by satellite, with terrestrial

repeaters and in part by a new terrestrial radio service, whose licensees would be current AM and FM broadcasters.

"Gateway" ground station

The second proposal is from Radio Satellite Corp. (RSC) of Pasadena, CA, that was to be filed 22 May for a "gateway" ground station for satellite access to provide audio and ancillary data services.

Both systems offer an alternative to the digital audio broadcasting (DAB) Eureka system developed by the European Broadcasting Union.

Unlike Satellite CD Radio, RSC does not propose to launch a dedicated satellite or obtain spectrum allocation.

RSC would lease capacity on a satellite to be launched in 1993 by the American Mobile Satellite Corp. (AMSC) of Washington, DC. This satellite will be devoted primarily to two-way voice and data communication with air, sea and land vehicles.

Designed to operate in the already-

allocated 1.6 GHz "L-band," the AMSC "bird" will be one of the most powerful communication spacecraft put into orbit. The spacecraft's high power 1 MW (60 dBW) would enable small, inexpensive antennas and receivers to be used on the ground.

RSC also would not be CD quality initially, according to company organizer Gary Noreen, but could be added later

(continued on page 7)

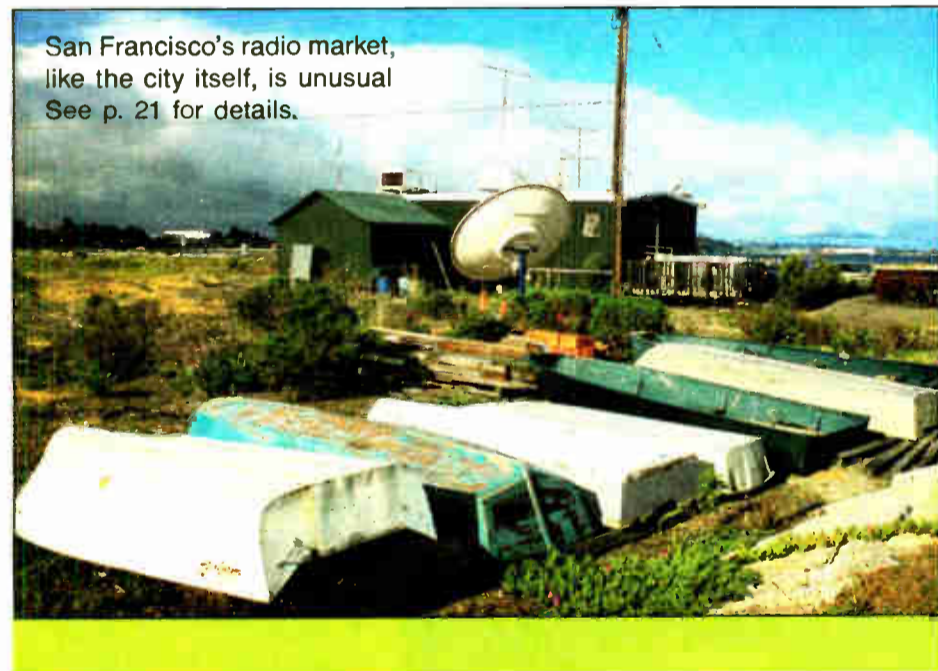

San Francisco's radio market, like the city itself, is unusual. See p. 21 for details.

Engineers Meet To Fight Digital Threat

by Alan Carter and Judith Gross

Washington DC Several leading radio engineering executives have met in an *ad hoc* group to address the "competitive threat" of digital audio broadcasting (DAB) to terrestrial FM.

"Our once premiere service, created to bring the audience quality entertainment, is now a fourth or fifth class citizen," Acting Chairman Paul Donahue, Gannett Radio engineering VP, said. "We'd better figure out what we're doing. We are going to address the competitive

threat that digital audio resources pose to FM."

Donahue maintained that FM as it is broadcast today cannot provide the quality that listeners are growing to expect with compact discs and even cassettes. He also blamed receiver manufacturers.

"When receiver manufacturers take the steps they are currently taking to reduce multipath—which is FM's worst problem—they degrade the FM service," Donahue said. "So we face not only competition from other sources, but an

(continued on page 10)

NRSC Test Proposed

by John Gatski

Denver CO Efforts of the National Radio Systems Committee (NRSC) FM Composite Spectrum Studies Working Group to develop a test plan for determining whether processing degrades FM receiver performance have drawn critical response from some members.

All particular disagreements with the initial test proposal were tabled at a May meeting in Denver and will be addressed at the group's next meeting, tentatively scheduled for late June in San Francisco, according to NAB Staff Engineer and NRSC coordinator Stan Salek.

The test procedure, submitted by Bob Orban of Orban Associates, is being proposed to assess the effect of "aggressive" processing on receiver signals. It entails determining the "undesired-to-desired RF protection ratios," according to the

test outline.

The test would involve subjecting a modulated carrier with an interfering adjacent channel carrier and determining the RF levels of the undesired and desired carriers.

Based on Orban's proposal, the test would require at least three receivers of various bandwidth limits (mean, wide and narrow); three methods to measure the peak deviation of the carrier and two loudness meters to gauge perceived interference level.

The test also would require a source for the interfering signal, that would approximate "real world" modulation, according to the proposal.

Prior to the May meeting, Bill Lovell, engineering VP for Bonneville International, wrote a letter outlining his concerns about the test, that was read at

(continued on page 3)

SIMPLY BETTER



TRY IT — SATISFACTION GUARANTEED

MAXIMUM PERFORMANCE and Type AA-4 COMPATIBILITY

TRUER HIGHS TOUGHER SHELL
LESS SHEDDING LOW ABRASION

CALL YOUR FIDELIPAC DEALER FOR SPECIAL INTRODUCTORY PRICING

Fidelipac Corporation • PO Box 808 • Moorestown, NJ 08057 USA • Tel: 609-235-3900 • Fax: 609-235-7779

Circle 36 On Reader Service Card

Groups Still Oppose FM DA Use

Antennas Are "Technically Unsound" And Inadequate, According to Filings

by Charles Taylor

Washington DC Five broadcasting organizations have voiced continuing opposition to changes instituted by the FCC in 1988 that allow short-spaced FM stations to use directional antennas.

The groups—the Association

of Broadcast Engineering Standards (ABES); engineering consultants du Treil, Lundin and Rackley; Greater Media Inc.; Mullaney Engineering; and the NAB—filed with the Commission in mid-May, charging that FM directional antennas are "technically unsound" and do an inadequate job of preventing

interference among closely spaced FMs.

The document repeats a stand taken by the groups in an April 1989 petition for reconsideration. They noted in the May filing that the Commission has yet to act on their request.

Technically unsatisfactory

"We are very concerned that (without) Commission review of this consensus document (rules) would result that are still technically unsatisfactory or unneces-

sarily burdensome," they wrote.

"Because the FM industry and the Commission would

and to FM reception by the public, it is very important to attempt resolution."

. . . the groups urged the Commission to readopt distance separation standards . . .

need to live with these rules for many years, and because under existing rules, there is posed so great a risk to FM service areas

Specifically, in its 1988 ruling, the Commission allowed FM allocation applicants to request a transmitter site that would be minimally short-spaced to the facilities of co- and adjacent-channel FMs.

As a result, licensees can employ reduction in power, terrain features, directional antennas, or some combination, to protect existing stations from the short-spaced transmitter sites.

Suspend protection rules

In respective April 1989 filings, each of the groups urged the Commission to readopt distance separation standards for allocation and assignment of FM stations; reinstate case-by-case consideration of special waivers for distance separation requirements; suspend contour protection rules adopted in late 1988; and revise FM antenna installation, filing and maintenance requirements.

In the recent filing, they also requested the FCC to stop accepting construction permit applications as of 1 June and to grant applicants before the deadline a conditional approval, pending outcome of a review of FM directional antenna rules.

We Re-invented the Wheel AND IT'S SQUARE!

Naturally, with all of Wheatstone's experience at building and interfacing consoles, it was inevitable that we would take on the design and manufacture of suitable furniture for our audio installations. First we listened to engineers and their requests, then we went to work. The result is a significant improvement over previous designs.

Consider the advantages of double-sided equipment cabinets with fully interchangeable door panels, with each side able to accommodate 19 inches of rackmount equipment. Consider the convenience of hinged twin drop-down punchblock panels for easy installation and maintenance. Consider the advantage of hard chrome plated steel mounting rails that eliminate the stripping problems associated with lesser aluminum designs. Simply consider the strength we've achieved with full inch and a half thick side panels and hybrid inch and a half thick countertops.

We have re-invented cabinet technology. We've wedded the latest precision NC metal componentry to hybrid plywood high density, high resin pressure-laminated substrates. Our construction and bonding techniques have been optimized to eliminate stress related laminate problems. We've handled wire management: there are generous pathways between each enclosure, as well as an integral channel punchblock housing under the console counter to keep everything neat, concealed and away from unauthorized hands. And, since cabinet faces can accept either equipment or door panels, systems can easily be configured to fit virtually any room. Doors can even be placed on cabinets intended for future electronics installation.

This cabinetry is very clever, unbelievably strong, and (of course) square—precisely. It has that Wheatstone major market look. So contact Wheatstone for furniture, consoles, or prewires.

INDEX

FCC, FAA Work to Find Solutions	
by Lex Felker	24
Digital Interfacing for Control	
by Ed Montgomery	26
Effects Boxes Add Spice to Spots	
by Bruce Bartlett	27
Convening Radio's Roundtable	
by Dee McVicker	28
West Coast Pioneers And a Radio Veteran	
by George Riggins	33
Unmodulated Measurements	
by Harold Hallikainen	34
Spring Cleaning at the Station	
by Barry Mishkind	36
How to Stop Singing Circuits	
by John Shepler	37
Facing Facts About Contracting	
by Tim McCartney	39
An AES/EBU Interface Resource	
by Mel Lambert	40
Occupied Bandwidth: Early Data	
by Eric Small	45

Wheatstone Corporation

6780 V.I.P. Parkway, Syracuse, NY 13211

TEL 315-455-7740/FAX 315-454-8104

Circle 15 On Reader Service Card

NRSC Receiver Test Talk Tabled

(continued from page 1)
the meeting.

Loveless stated in the letter that the test may be beyond the scope of the NRSC and the results could be interpreted in a way that may result in more stations crowding the FM band.

"I am concerned that NRSC is proposing to use incorrect and unconventional techniques to measure FM receiver protection ratios. NRSC must provide a proven correct and clear documented track back to CCIR standards, methods and data," Loveless stated in his letter.

Basis for more stations?

Loveless and Eric Small, a group member and Modulation Sciences' VP of engineering, said they believe that protection ratios, based on receiver measurements, could provide numbers which could support adding more stations, possibly causing more interference.

A lot of questions need to be addressed before a test proposal can be finalized, such as whether processing is a denigrating factor or if interference is caused by the station allocation scheme under FCC Docket 80-90, they said.

"We're not sure if there is even a problem," Small said.

Even if the Orban test proposal purpose is adequately addressed, critics are convinced the protection ratios will not produce valid findings.

Protection ratios are the function of the

receiver and provide more of a "broad brush" approach to trying to answer the processing question, which could do more harm than good, test opponents argue.

A better way to approach whether processing affects receiver performance would be to measure occupied bandwidth, Loveless said.

Small agreed. "Occupied bandwidth is a nice deterministic measurement and we know what the occupied bandwidth is under the allocation scheme. So why don't we just measure occupied bandwidth?" he asked.

Orban said the concern about the test results being used as ammunition for opening up space for more FM stations is unwarranted.

"I don't see how anyone is going to go to the Commission and try to get more stations with this," Orban said. "The point of this is doing research." Orban concurred with his critics about the uncertainty of whether processing causes interference, but said that is why the test research is being done in the first place.

Car receiver manufacturers consider the issue important enough to perhaps narrow the IF bandwidth in receivers because of broadcaster modulation practices, Orban maintained.

As for protection ratios vs. occupied bandwidth, Orban said his proposal makes more sense.

"I think they are the only realistic

measurements because they are the only ones that realistically relate to perceived first adjacent channel interference," Orban said.

Although not mentioned in the test outline, Orban pointed out that occupied bandwidth measurements also will be done during the test and the results will be compared.

Differs from CCIR

Even if the protection ratios can be used as the evaluating criteria, Orban's test procedures are substantially different from protection ratio testing recommended by CCIR, the world broadcast standards-making body, according to Loveless and Small.

Among the differences is Orban's proposed use of a stereo interfering signal rather than a mono signal, which the CCIR recommends.

Another area that differs from the CCIR recommendation is Orban's suggested use of a CBS Loudness Meter rather than a psophometer loudness meter for measuring perceptual loudness.

Orban said the CBS Loudness Meter uses a more sophisticated algorithm for approximating perceptual loudness, but Small disagreed.

Small noted that a psophometer is the CCIR-recommended loudness meter and the CBS meter is based on a design that was never put into production.

Because of concern raised at the com-

posite work group meeting, suggestions were made to use both loudness meters, according to Salek.

But the differing results from using two meters could open the results to different interpretations, Small said.

Orban said his proposal is not that different from CCIR protection ratios measurement procedures other than using a stereophonic modulating signal for the interference and the choice of loudness meters.

The use of stereo signal approximates real world modulation and would reflect more accurately broadcast conditions in the US, Orban explained.

And, he added, the CBS Loudness Meter is adequate for the test.

Go ahead anyway

Despite criticism that the test is beyond the scope of the composite working group, Small believes there is a danger it might be approved anyway because of the NAB's commitment to get results from the group.

"There is a tendency for these type of groups to be self-perpetuating," he said.

In defense of the project, Salek said the Orban plan is only a "framework" test proposal and can be modified prior to any approval action.

Salek also said the processing test results could be forwarded to CCIR for consideration when the standards-making body periodically updates its standards and recommendations.

Procedurally, Salek said the NRSC has not yet worked out whether the test proposal needs a unanimous vote by members for approval.

Your Prescription Has Just Been Filled.



Orban's Rx Adaptive Enhancement Processor provides three functions to restore openness, sparkle, and life to recorded materials. Harmonic restoration recreates desirable even order harmonics; spectral restoration adds high frequency "air and shimmer" to dull, flat signals; and the single ended noise reduction further improves your source material.

The powerful Rx is indispensable for transferring records to tape with better-than-new sound, or for pulling production tracks out of the mud. Contact your Bradley professional today for details.



8101 CESSNA AVENUE • GAITHERSBURG, MARYLAND 20879-4177
TOLL FREE: 800-732-7665 • MD & DC: 301-948-0650 • FAX: 301-330-7198

Where Service and Engineering Make the Difference

Circle 50 On Reader Service Card

ADVANCED TECHNOLOGY...

Broadcast Electronics' FM 20B 20 KW FM Transmitter

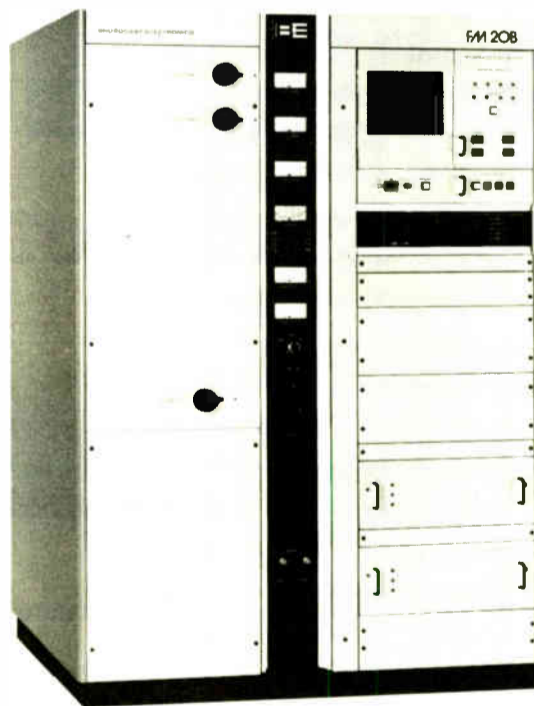

- Digital quality transmission.
- New world standard FX 50 Exciter.
- Highest overall efficiency available.
- Typical THD and IMD 0.009%, 90 dB FM S/N.
- Built in synchronous AM noise test port.
- Patented folded half-wave cavity eliminates plate blocking capacitor and sliding contacts.
- Self Contained solid state broadband IPA in slide out drawer.
- Emergency 450 watt RF patching.
- Automatic Power control that maintains constant output power with proportional VSWR foldback protection.
- Optional self-diagnostic system (MVDS).
- Optional MVDS based remote control.

For information on the FM 20B Transmitter and on Broadcast Electronics' NEW FX 50 Exciter, call Bill Harland or Russ Erickson at 217-224-9600.



4100 N. 24th ST., P.O. BOX 3606, QUINCY, IL 62305, (217) 224-9600, TELEX: 250142, FAX: (217) 224-9607

Circle 92 On Reader Service Card

Giving Chicken Little Her Due

by Judith Gross

Falls Church VA It never occurred to me until recently, but suppose Chicken Little had a point?

Not so much that the sky really is falling, but that there is something out there getting closer, gathering momentum that if stations don't pay attention to pretty soon promises to change the playing field—and the rules of the



game—when nobody's looking.

You don't have to be a genius to see what happened to AM. That's not to say that there aren't still plenty of good, thriving AM stations out there serving their listeners and raking in the ad revenues.

But the technology changed and tastes changed. Stereo and high fidelity raised listeners expectations. A lot of AMs didn't see the handwriting on the wall. Now AM listening is down to 23% and the FCC is writing (yeah, they're still working on it, the longest homework assignment in the history of the industry!) a new set of rules to help AM stations cope.

And what about FM? Can stations afford to sit back and rest on the knowledge that the band offers stereo and higher fidelity than AM, especially

when CD players are everywhere, DAT is gonna get here sooner or later and now (drum roll please) the digital satellite systems have taken the first step.

Two, count 'em, two filings at the FCC have proposed satellite audio services. Canada is going to test out a digital system this summer. And in Europe they're spending millions.

It's no wonder some top engineering execs recently got together to start the ball rolling to meet the challenges of a digital world. They're waiting to see now if they'll get NAB support. Maybe they need it, and maybe there needs to be a committee like this one way or the other.

Will special interest groups and silent agendas try to get their digs in? You bet. Will the political forces try to dominate the discussions? Absolutely. But is the threat from a digital future going to disappear? No way. So let's get real.

As for AM, maybe stations on the oldest radio band are starting to feel a little left out. Can they get on the digital bandwagon? Well, it's doubtful that technically an AM station could realistically benefit from all that's being tossed about these days.

But how about when it comes time to make those allocations of the new digital stations? AM could certainly be given a preference then. So stations should be guarding their interests closely here, too. In the rush to offer immediate band-aids for AM today, stations shouldn't compromise their options on the future.

I think we could quiet Chicken Little down a bit if we started to face all this now, instead of waiting for dis-

aster to sneak up on us. The future is here.

☆☆☆

Meanwhile, as the NRSC deadline (June 30) fast approaches, I hope all you AMs have your processing in place. It'll be a lot easier to prove you comply that way, when the FCC comes calling.

Out in LA Sandra Woodruff and her Chapter 47 SBE buddies wanted to let me know awhile back about their subcommittee on NRSC. The group is encouraging all AMs to meet the deadline by going NRSC, hoping to educate con-

Pittsburgh?

I mean, OK, they got a couple of rivers and a baseball team, and industry and all. But why would the FCC choose Pittsburgh as the place where everybody's got to file their feeable applications?

They say it's cheaper, but since a lot of attorneys doing such filings are based in DC, I wonder. They even sent this picture of communications attorney Frederick Polner of the Pittsburgh firm of Rothman Gordon handing the first FCC filing to Wanda Wynn of the Mellon Bank.

Polner started his career with the FCC, he said. "It's nice to see the FCC recognize that the practice of communications law can thrive outside the Washington DC beltway." Gee, I can't wait until they move the filings to Sheboygan.

☆☆☆

The LA radio scene, by the way, seems to have quieted down a bit, with none of the "Big Dogs" (KKBT and Pirate KQLZ) getting the ratings they had hoped for, heavy processing or no.

Don't know if the

listeners are trying to tell them anything, but I was a bit curious about a picture of a Pirate billboard sent to me awhile back. It showed a cartoon pig in place of the well-known Scott Shannon mug.

What is it with pigs? We heard about the Power Pig in Tampa, and now this. Are pigs supposed to be hip these days? Am I missing something hot here? Pirate says they are the "Party Pigs." OK. That's one party I think I'll skip.

Heard a juicy tidbit? Spill your guts to Earwaves by faxing JG at 703-998-2966, writing to PO Box 1214, Falls Church VA 22041, or calling 703-998-7600. Who knows, you could win a coveted RW mug.

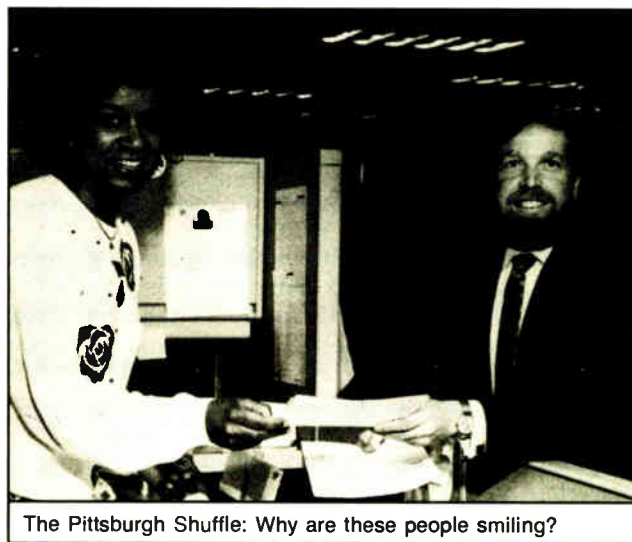

The Pittsburgh Shuffle: Why are these people smiling?

sumers about improved fidelity and get them to buy the new IQ NRSC radios and help other groups do the same.

The group is also doing a study to see which stations have implemented NRSC (both processing and transmission), what stations might be doing other than the 75 μ sec preemphasis and which are stereo.

Then they're going to compare their info with ADI stats to see how many listeners benefit. Pretty nifty. Sandra, by the way, is chairing the NRSC committee for the chapter. I'll check back with her and tell you more when I hear it.

I just got to ask it, because nobody else really has, but why, of all places,

4TH OF JULY FIREWORKS SALE
FREE DYNAMAX CART MACHINES
Call your Fidelipac Dealer today

WMMS Goes All Out for On-Air Reliability

Brian Emery, Chief Engineer of WMMS, knows how important it is to stay on the air in a competitive market like Cleveland.

That's why Brian trusts his two FM transmitters (and his reputation) to his Burk TC-8 Remote Control System.

Many people think of our little 8-channel system as ideal for limited budgets. And it is, too. The TC-8 is still just \$2,495.

But the TC-8 packs a surprising amount of value into that tiny price. Especially when being on the air all the time counts.



TC-8 Remote Control System

WMMS, always technically progressive, was one of the first stations to choose a TC-8 back in 1985.

Later, they added a new FM transmitter. What to use for remote control? The Burk TC-8, of course.

Brian's formula is simple: If it's not reliable, it costs you money. He also has another motivation to stay on the air. His corporate headquarters are on the same floor.

Burk Technology builds remote control equipment you can depend on. Our systems are backed by a two year warranty and our same day repair service. Call us for a copy of our latest product catalog.

Burk Technology, Inc.
7 Lomar Drive
Pepperell, MA 01463
(508) 433-8877

BURK
TECHNOLOGY

Call TOLL FREE
1-800 255-8090

Better Tests Needed

by David Maxson

Cambridge MA Regarding the 25 April articles on FM station modulation measurements, I'd like to comment on how inaccurate these measurements really are. As Chief Engineer of WCRB and principal of Broadcast Signal Lab, I've had ample opportunity to measure FM deviation in both laboratory and field conditions.

It is easy from the circuit design point of view to look at FM as simply sweeping a frequency up and down with an audio source. When it comes to measurement though, you can't very well measure the instantaneous frequency of the carrier every cycle. Even Hewlett Packard's new "modulation domain" analyzer cannot handle the complexities of 75 kHz deviated FM broadcast signals with the precision we would want.

So instead, we measure using methods that compare a calibration from a standard to the signal under test. Each time we "transfer" a calibration to another instrument we add error and uncertainty. Let's look at the process the FCC uses to measure a frequency modulated station:

First, establish a 75 kHz deviated reference with a signal generator and a spectrum analyzer. Using a Bessel null, you can generate a very precisely modulated signal. In the example given, a 31,187.62 Hz signal frequency modulates a carrier being observed on a spectrum analyzer.

The modulation is adjusted until the appropriate dip occurs on the analyzer. This is the only truly rigorous part of the entire measurement process. You are actually looking at the test signal while it is still RF and establishing a dip based on a purely mathematical relationship.

GUEST EDITORIAL

If the modulating signal is off by 1 Hz, the resulting error is only 0.0032% from 100% modulation. That's only the calibrating signal's accuracy.

Now disconnect the spectrum analyzer and connect a "high quality receiver" such as the mil. spec. rigs in the FCC vans. The RF connection is a short jumper between a reliable source and load.

Take the "flat" composite output and put it into a storage oscilloscope. The top of the trace represents the voltage produced by the receiver when subjected to an RF source deviated exactly 75 kHz by a single modulating tone.

Finally, disconnect the laboratory source and connect a roof antenna (or transmission line tap at the transmitter) to the receiver. Make sure there are no standing waves, or multipath of any significance.

We performed an on-air Bessel null once with a spectrum analyzer on the transmission line tap and another at a good receiving location miles away. The null did not occur at the same time on each analyzer! The difference between the two was nearly 2% modulation.

We tried to be sure the cables, sources, loads and levels were all appropriate for the measurements. Although we did not determine the cause of the discrepancy, this illustrates that there is uncertainty introduced when trying to observe a signal outside of laboratory conditions.

Let's assume that the RF signal into the test rig is untainted and goes through a precision demodulator in the receiver. How flat is it? How about plus or minus a tenth of a dB 10 Hz to 100 kHz? That translates to $\pm 1.16\%$ modulation, or a worst-case error of 2.32% modulation from the top to the bottom of the response curve. (In addition to measuring the flatness of these receivers, has anyone ever tested them for overshoot under broadcast modulation conditions?)

Now observe this composite signal on a storage oscilloscope. If you are reading off the screen you probably have the voltage corresponding to the 75 kHz
(continued on page 16)

Radio World

Vol 14, No 11 June 13, 1990

Editor, Judith Gross

Associate Editor, Alex Zavistovich

News Editor, Alan Carter

Reporters, Charles Taylor, John Gatski

Benn Kobb, Frank Beacham/L.A.

Editorial Assistant, Marissa Friedman

Technical Advisor, Tom McGinley

Production Director, Kim Lowe

Ginger Bamford, Lisa Roach, Bill Spencer
Ad Production Coordinator, Jeanne Pearson

Publisher, Stevan B. Dana

Associate Publishers, Arthur Constantine
Carmel King

Ad Coordination Manager, Simone Leiser

Circulation Manager, Tiana Hickman

Accounts Receivable, Valerie Mason

Advertising Sales Representatives:

East & Midwest, Art Constantine

800-336-3045, Fax: 703-998-2966

West Coast, Pat Macsata

415-786-2198, Fax: 415-786-2754



Radio World (ISSN: 0274-8541) is published semimonthly (except February, which has 3 issues) by Industrial Marketing Advisory Services, Inc., 5827 Columbia Pike, Suite 310, Falls Church, VA 22041. Phone: 703-998-7600, Fax: 703-998-2966. Second-class postage rates is paid at Falls Church VA 22041 and additional mailing offices. POSTMASTER: Send 3579 forms and address changes to Radio World, P.O. Box 1214, Falls Church VA 22041. Copyright 1990 by Industrial Marketing Advisory Services, Inc. All rights reserved.

Free subscriptions are available upon request to professional broadcasting and audiovisual equipment users. For address changes, send current and new address to RW a month in advance at the above address. Unsolicited manuscripts are welcomed for review; send to the attention of the appropriate editor.

Next Issue
Radio World
June 27, 1990

The beginnings of an *ad hoc* group by FM engineers concerned about increasing competition from digital audio is a good first step in planning for the future.

While many questions need to be addressed and the agenda may change before any definite directions emerge, the FM industry is at least recognizing the need to address changes in technology before those changes harm the service the way a failure to keep AM competitive has hurt that band.

Stations today face not only competition from digital entertainment such as CDs but are at the mercy of receiver manufacturers who narrow the IF bandwidth to address interference issues in an increasingly crowded spectrum.

Meanwhile Europe is well on its way to implementing digital transmission while Canada is poised to being testing a system this summer.

A Good First Step

And with two recent filings at the FCC by companies interested in providing direct satellite audio service in this country, the threat is more immediate than many engineers and managers would like to think.

Whether the informal committee becomes a sanctioned industry group or merely continues to meet

according to mutual interests it's important that a forum to air a wide diversity of views be maintained.

These views need to include all facets of the industry, political, economic as well as technical, and consider AM as well as FM interests.

And by subjecting these discussions to industry scrutiny, the threat of special interests or manipulation of private agendas can be minimized.

The twin goals of educating the industry and exploring new technologies—especially terrestrial digital methods—are ones which can help generate support and allow the industry to speak with a single voice.

And an early start to such discussions now insures that when action is necessary, it can be taken in a timely manner.

—RW

READERS FORUM

If you have comments for *Radio World*, call us at 800-336-3045 or send a letter to Readers' Forum (Radio World, Box 1214, Falls Church VA 22041 or MCI Mailbox #302-7776). All letters received become the property of Radio World, to be used at our discretion and as space permits.

The truth about WNEW

Dear RW:

While packing for Easter vacation, I took along the just-arrived *Radio World* for 11 April—wouldn't miss it.

However, I noticed an error that is often repeated. This time it showed up in George Riggins' *Old Timer* column, and was about New York's WNEW.

He has the generally-accepted story of Ed Wynn's involvement as the source of the "EW" in the call sign (some people claim just one letter). But in Nightingale Gordon's history of the station, *WNEW—Where The Melody Lingers On*, he gives quite another version:

"Ed Wynn's initials are often said to be the source of WNEW's call letters. But retired engineer John Zarpaylic offers this first-hand account: One Sunday morning I had to drive Mr. Blow (an ad exec) and Richard O'Dea (owner of station WODA) to the new location in Carlstadt where they were building the transmitter. And the discussion was, what are we going to call this? Milton Blow said, 'We haven't had a station built in this area since 1928. I think the best call letters we could have are WNEW, which says new. New in the metropolitan area. The newest thing in radio.'"

Now, as I write this, it is much later, because I have just read almost the entire book again. For perhaps the second dozenth time. I'm the manager of a radio station here, but WNEW is The Station for me.

Tom Carten, Manager
WRKC-FM
Wilkes-Barre, PA

Interference or fatigue?

Dear RW,

After reading the *Delco Balks at NRSC "IQ" Certified Radio* article in the 9 May, 1990 *RW*, I am reminded again that the sad state of affairs many AM broadcasters find themselves in is due almost entirely to receiver manufacturers attempting to "protect" their consumers (our listeners) from interference.

I'm sure Delco, Motorola, Denon, et al must have extensive market research data that indicates consumers don't want interference. However, after having initiated and studied numerous passive listener research projects in several markets, I have never seen one listener complain of "interference" (or "static" or "noise" or "other voices" or whatever).

On the other hand, many studies show that lack of fidelity and dynamic range causes "listener fatigue." This shows up on the most important piece of research broadcasters deal with—the ratings—as shorter "time spent listening."

I would be interested in what forms and amounts of research the receiver manufacturers have conducted to determine that their consumers want to be protected from interference.

I am currently working for a chain that has a Class A FM station. Talk about co- and adjacent channel interference! Even so, I am certain that we would never accept a trade-off of fidelity for greater interference-free range.

Pete Owen, OM
WKEU
Griffin, GA

Erratum

NAB Science and Technology Senior VP Michael Rau was inaccurately quoted in the 9 May issue in an article on WAEB multipath testing when commenting on the role of the National Radio Systems Committee (NRSC) in standards setting.

His correct statement is, "The NRSC is a standards committee, it is not a research committee."

Radio World regrets the error.

BROADCAST EQUIPMENT

ITC Builds It Allied Sells It

The next cart machine you buy may just be the last cart machine you'll ever buy.

The ITC Series 1 will be pulling tape for you until the miracle we all expect takes place.



Introducing the Series 1. The first new machine of the new decade. It's lean, mean & strictly business.

The new Series 1 is designed with all the features you need at a realistic price. Pound the buttons. Flip the switches, jam a cart in and yank it out a few hundred thousand times. The new Series 1 has been built to take anything you can dish out, 24 hours a day, 365 days a year.



WINNER AND STILL CHAMPION

So before you mortgage your program director or settle for something of less value than ITC, check out the new Series 1 today.

You won't need an excuse to buy one. Features and price

prove its value and its worth.

ITC sells more cart machines than anyone else. Allied sells more ITC than anyone else.

Call us. Let's make it a Win, Win, Win situation.

 **HARRIS**
ALLIED
BROADCAST EQUIPMENT

800-622-0022

Proposals Detail Digital Services

(continued from page 1)

on additional AMSC satellites. RSC would broadcast 10 digital audio channels throughout the US using 1 MHz of spectrum.

100 new channels

Under Satellite CD Radio's proposal, nearly every broadcast licensee will be able to operate in a local, 34-channel capacity. At the same time, the company maintained, a new, 66-channel CD-quality satellite radio service will be made possible as well, resulting in the provision of 100 new broadcast channels.

Satellite CD President Peter Dolan explained that the company would contract with stations interested in purchasing transponder space. Satellite Radio CD would connect stations' program studios to an uplink center proposed for Montrose, CO, via "some high quality" transmission line that would "most

In the petition for rulemaking, Satellite CD Radio described itself as a system operator/licensee that would "merely act to provide an antenna farm in the sky for use by broadcasters." It would sell channels to third parties and exercise no control over content.

But the filing stated that Satellite CD Radio would decide which program providers should be given access to its channels.

In a move to expedite the proceeding through the FCC, Satellite CD Radio suggested the matter be resolved by February 1991 so the proposed spectrum usage could be adopted by the 1992 WARC.

Optimistic for FCC

"We're quite hopeful that we will receive a favorable FCC ruling on this," Dolan said. "We will be providing the first CD quality radio broadcasting service. It

technology to manufacturers of satellite mobile radios. These special "Radio Satellite Microchips" will contain most of the baseband processing needed to receive the satellite.

"We're taking advantage of dramatic increases in chip capability to consolidate most of the processing required by these sophisticated radios into a single, mass-produced low-cost chip," Noreen said.

He said he expects the satellite radios to cost about \$100 more than conventional AM/FM radios. Development of the Radio Satellite Microchip would cost \$3-5 million.

In addition to audio programming, the radios will be capable of navigation and alphanumeric message service. Two-way communication will be available via an optional transmitter. The company plans for these radios to be available through retail electronic outlets by the Christmas 1993 sales season.

Localism or diversity?

At the NAB, Science and Technology Senior VP Michael Rau suggested the filings were an "attempt to show a need" for DBS radio.

"Historically, a radio satellite service is contrary to locally based, free, advertiser-supported broadcasting," Rau said.

The NAB Board of Directors is expected to issue a policy statement on digital audio broadcasting (DAB) after its 19-22 June meeting in Washington, Rau said. He declined to elaborate on that stand.

Noreen, in what he called NAB's opposition to satellite broadcasting, said, "The kind of programming we're looking for is a diverse set of formats, suited to the traveling public as well as listeners in rural areas. Talk programming is preferred, but we will provide music programming too," he said.

While on the staff of NASA's Jet Propulsion Laboratory, Noreen designed communication systems for interplane-

tary space missions.

In 1983 Noreen organized Transit Communications Inc. (TCI). This firm was one of the original 12 competing US mobile satellite license applicants, which the FCC directed to join together in a consortium.

TCI is one of eight stockholders of that consortium, which became AMSC. Other AMSC stockholders include LIN Broadcasting, Hughes Communications, McCaw Communication Companies, MTel, and Millicom Inc.

For more information from Satellite CD Radio, call 202-408-0080; contact Radio Satellite Corp. at 818-564-9333.

"We're quite hopeful that we will receive a favorable FCC ruling on this. We will be providing the first CD quality radio broadcasting service."

likely" be fiber optic, he said. The filings referred to ISDN/optic fiber.

Dolan also said, as noted in an abstract of the company's petition for rulemaking and application provided by Dolan, that consumer automobile and home receivers are being developed by Stanford Telecom of Santa Clara, CA, that would receive over-the-air AM and FM, and the new CD radio. (The filing at the FCC had not been processed for public viewing at press time.)

Satellite CD Radio said the project would cost \$330 million.

Satellite CD Radio is 50% owned by Marcor, a DC communications consulting business owned by Martin A. Rothblatt who has stock in Geostar Corp., a licensee in the Radiodetermination Satellite Service.

The other 50% of Satellite CD Radio is owned by New Era Corp., a Maryland corporation in technology development that is 100% held by Jean-Jacques Portrel, a French citizen.

Two-satellite system

According to the technical filings, Satellite CD Radio would consist of two operational satellites, a multiplicity of terrestrial repeaters primarily serving permanent urban areas, and an earth station that provides feeder links to the satellites and performs tracking, telemetry and control of the spacecraft.

The two satellites of 6000 W are expected to be built by Ford, General Electric and Hughes. They would be launched by such companies as General Dynamics, Martin Marietta or McDonnell Douglas. Satellite CD Radio noted in a prepared statement.

Satellite CD Radio proposed that the system use Dolby AC-2 compression encoding for both satellite and terrestrial. The encoding system compresses 720 kB/s of CD quality stereo audio into 128 kB/s, according to the filing.

is within the FCC mandate to promote an advanced type of broadcasting service. We are certainly within that mandate."

Radio Satellite Corp. proposes to resell the satellite capacity to broadcast, paging and mobile communications companies. The broadcast services could be advertising or subscription supported and the ancillary services would be provided to resellers. The digital architecture of the system permits encryption.

RSC plans to license ASIC (application-specific integrated circuit)



WITH THE Emph'asizer™ AUDIO PROCESSOR

- DJ Personality Processor
- Phone Line EQ and Noise Suppressor
- Production Tape Processor
- Room Equalizer and Gated Mike Control
- Gated Recovery Compressor
- Unobtrusive Background Noise Gate
- Four Parametric Equalizers
- Mike and Line Level Inputs and Outputs

Free Detailed Brochure Available



AUDIO TECHNOLOGIES INCORPORATED
328 Maple Avenue, Horsham, PA 19044 • (215) 443-0330

Circle 117 On Reader Service Card

World Radio History



Puts your signal in it's place!

If you need a quality antenna, you need: **JAMPRO ANTENNAS, INC.** The really experienced one for over 30 years.

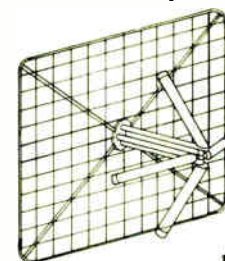

JAHD CP Arrowhead Screen Dipole

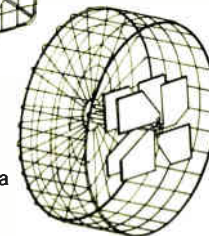

JSDP CP Spiral Broadband Antenna



JBBP FM Antenna Balanced Excitation

JAMPRO is the world leader in custom-designed, directional, CP antennas.

- With over 1600 of our penetrators delivered, more stations have penetrated their market.
 - Our custom-made directional antennas are operating world wide.
 - Full-scale antenna measurements on **JAMPRO's** all-year, all-weather test range.
 - We custom-make tower structures to duplicate your's, for optimum results.
 - Ask about **JAMPRO's** low-power educational packages.
- Give us your requirements and see how fast we produce.

JAMPRO Antennas, Inc.

6939 Power Inn Road
Sacramento, CA 95828
(916) 383-1177 • Telex: 377321
FAX (916) 383-1182

Circle 105 On Reader Service Card

FCC Seeks To Prevent Abuses

by Alan Carter

Washington DC Taking its cue from broadcasters, the FCC has dropped a proposed lottery for new radio and TV allocations and started proceedings to further revise the comparative hearing process.

The rulings

In dropping the lottery proceeding under docket MM 89-15, the FCC noted that it was concerned that any potential gains in efficiency by a lottery would be outweighed by the "possible reduction in quality of broadcasting licensees and service to the public."

Commissioners also adopted several proposals designed to deter abuse of process.

It will now be illegal to receive or make payments in excess of expenses

in exchange for withdrawing or refraining from filing a threatened petition to deny.

The FCC further said it will review on

proposals are intended to expedite the initiation of new service, as well as to reduce the potential for abuse of the application process.

The Commission said the public interest is served by its decisions to limit settlements to competing applications . . .

a case-by-case basis all citizens' agreements reached in consideration for withdrawing petitions to deny or threats to file petitions to ensure that they reflect public interest.

The Commission also proposed reinstating limits on the amount of payments that would be permitted to settle comparative new hearings. These

The FCC took the action 10 May on a unanimous vote at a regular monthly meeting.

No lottery support

Across the board, commenters opposed the lottery system. Those against the action included the NAB, the Federal Communications Bar Association, the

Black Media Coalition and the Community Broadcasters Association, a trade group representing low power television that has a lottery.

Opposition generally focused on a lack of true broadcast interest and localism in a lottery process.

Among the proceedings the FCC opened in revising comparative renewal is a proposal to shorten the hearing process and the time for related appeals.

In other action, the Commission also expanded the scope of an applicants' criminal record it will consider in granting a license. Now, all felony convictions, not just misconduct directly related to any relationship with the FCC, and misdemeanors, will play a role.

In a final action, the FCC rejected an appeal by a group on previous comparative reform under docket MM 81-742.

The Commission said the public interest is served by its decisions to limit settlements to competing applications; eliminate the Cameron doctrine that permitted competing applicants to use the transmitter site of the incumbent, and cease the enforcement of programming commitments made in citizens' agreements between renewal applicants and citizens' groups.

Austerity For NAB

by Charles Taylor

Washington DC The NAB Executive Committee's decision to hold the association's 1990-1991 budget steady at \$15.7 million will have little effect on current Science & Technology work but will delay plans for some new projects.

NAB officials, who met 8 May, attributed the no-growth budget to a general downturn in the nation's economy, according to an NAB spokesperson.

For Science & Technology, the new budget means less participation in the International Radio Consultative Committee (CCIR) and eliminates proposed testing of Improved Definition Television, said Senior VP Michael Rau.

Other departmental effects include a decrease in the travel budget. "We won't have as much flexibility to travel to state associations and SBE (Society of Broadcast Engineers) as guest speakers," Rau said.

While the cuts will prevent Science & Technology from moving ahead with some projects, Rau said the department is accustomed to working within its means.

"NAB is a non-profit association and cannot spend more than we take in, so whatever the income levels are is what our income is held to," he said. "We would like to develop revenue sources in order to increase industry services, so that we can keep dues as low as possible to our membership."

In other business, NAB staff presented reports on radio issues including AM improvements, FM translators, allocation policies, AM directional antennas and digital audio broadcasting (DAB). The NAB Board is expected to release its position on DAB in a policy statement to come out of a full board meeting scheduled the third week of June.

TURBO CHARGE

Your Optimod™ 8100 with CALIFORNIA DIGITAL DIGIMOD 2000™

DIGIMOD 2000™ A 3 circuit card package transforms a standard OPTIMOD 8100™ into a multi band, digitally controlled processor, delivering maximum, competitive processing when using compact disc and R-Dat.

Call your favorite dealer for price and availability.

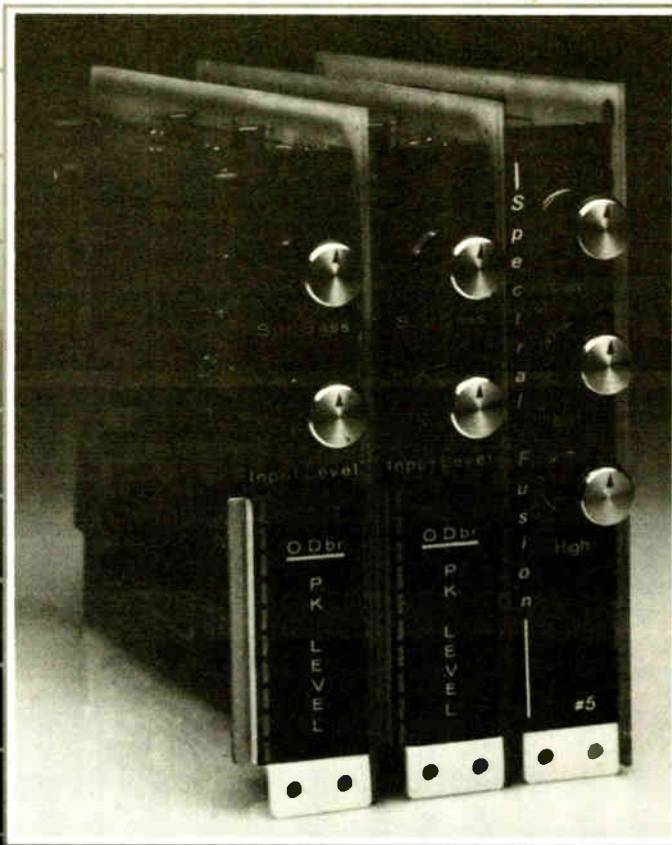

California Digital
Audio Systems

DEALER LIST:

- BROADCASTERS GENERAL STORE:**
Ocala, FL (904) 622-9058
Marietta, GA (404) 425-0630
Carol Stream, IL (708) 231-7120
Arlington, TX (817) 275-1380
- BROADCAST EQUIPMENT SALES:**
Jackson, MS (601) 857-8573

DISTRIBUTED BY: Family Marketing Group
DEALER INQUIRIES INVITED...904-622-2779

THE ONLY BLUE



THAT'S TRUE.

When broadcasters worldwide need performance they can depend on, they reach for one cart. The original blue one—The genuine Audiopak broadcast cartridge. They know every batch of “workhorse” A-2s, “stereo” AA-3s or “digital-ready” AA-4s will deliver true quality + superior performance, cart after cart after cart.

Making carts you can count on. That's what has made us #1 in the US and around the world. And we intend to keep right on doing precisely that. To make it easy for you to recognize *genuine* Audiopak carts, we're introducing a new Quality Assurance seal

and molding our name into the top cover. Of course, the real proof of our commitment to quality is the consistent performance and long-term durability we build into every Audiopak cart. So if reliability and unsurpassed audio performance are important to you, insist on the one cart that's true blue for more stations than any other—Audiopak.

audiopak®

P.O. Box 3100 • Winchester, VA 22601
Tel: (800) 522-CART or (703) 667-8125
Fax: (703) 667-6379

FCC Plans Ahead for WARC '92

by Alan Carter

Washington DC The FCC is well underway in planning for the US position at the ITU 1992 World Administrative Radio Conference (WARC), which Chairman Al Sikes has said will set the stage for telecommunications in the 21st Century.

In addition to a notice of inquiry, the FCC 92-WARC Advisory Committee recently organized informal working groups through which the committee will prepare recommendations for the Commission.

"This is the broadest based WARC

since 1979," said FCC International Communications Director Walda Roseman. "There is a broad range of interest."

HFB, UHF and SHF

The preliminary agenda includes the high frequency band, the UHF band and the super high frequency (SHF) band, which is 10 GHz and above for space services including direct broadcast satellite, she explained.

The agenda will be finalized when the ITU administrative counsel meets 11-22 June in Geneva. "This is a critical benchmark for WARC," Roseman said.

Sikes has called the upcoming world conference that will be held in Spain the "21st Century WARC," Roseman said. US planning for the session will set the framework for the US and others in telecommunications for the 21st Century, according to Sikes, she noted.

Broadcast participation is sought through the working groups of the advisory committee, which is co-chaired by Commissioner Sherrie Marshall and Frank Urbany of Bell South.

Those committees and chairpersons are: IWG1, high frequency from 3-30 MHz, Bob Raish of Fletcher, Heald and Hildreth; IWG2, UHF from .5-3 GHz, Ben Fisher of Fisher, Wayland Cooper and Leader; IWG3, SHF from 11-35 GHz, Donald Jansky of Jansky Barmat Telecommunications; IWG4, technical committee considering frequency sharing, Burt Halprin of Verner, Liipfert, Bernhard, McPherson and Hand, and IWG5, procedures, Leslie Taylor of Leslie Taylor Associates.

Report schedule

The first interim report from the advisory committee to the FCC is due 30 June, with a follow-up on 31 January 1991 and the final report due 30 April 1991. The next advisory committee meeting is 27 June.

Roseman said the FCC is moving on a second front with a notice of inquiry.

Among those who commented, the NAB cautioned federal regulators against

crowding the marketplace with new communications services, arguing that they threaten to interfere with or displace local radio and television signals already in use today.

The NAB questioned whether the US broadcast spectrum could support the additional allocation of spectrum space. These new offerings could include mobile services and a proposed satellite

Sikes has called the upcoming world conference that will be held in Spain the "21st Century WARC," Roseman said.

broadcasting service in the 500-3000 MHz range, as well as high definition television broadcasting by satellite.

At a third level, Roseman said the FCC is participating in the Interagency Radio Advisory Committee (IRAC) that monitors government frequency. The FCC and Commerce Department are coordinating efforts on these issues.

For information from the FCC on WARC preparations, contact the International Communications Office at 202-632-0935 or the Office of Engineering and Technology at 202-632-7060.

Varian Repositionings

by Alan Carter

Palo Alto CA Continental Electronics and TVT Limited are on the sales block along with several non-broadcast divisions, parent company Varian Associates announced in mid-May.

The sales are part of a companywide "repositioning" to focus on the component aspects of its operations rather than systems, according to Varian.

Varian also announced it will eliminate approximately 600 corporate jobs, 20% of its work force, in addition to those with the divisions for sale. Varian employment will drop from approximately 12,000 to less than 10,000.

Varian has been in negotiations for "a couple of months" with buyers for Continental and TVT, a spokeswoman confirmed. She said she could not identify the interested companies.

While Varian's announcement did not indicate what it would do with Continental and TVT if they were not sold by the designated 29 September deadline, the spokeswoman said such a situation developing is not expected. "I don't think anyone has really considered that

because it is such a highly unlikely happening," she said.

Continental and TVT are operating "business as usual," the spokeswoman said. Varian classified the two companies as "discontinued operations" in a written statement, but she clarified the expression as common accounting terminology.

Continental Domestic Sales Director Walt Rice also said Continental has not closed its doors as some would suggest. "We are conducting business as usual. We are booking orders daily."

Varian Chairman and Chief Executive J. Tracy O'Rourke said the divestiture will allow Varian to take a one-time, pre-tax charge of \$74 million against third quarter results and report a loss for the period ending 29 June.

The operations to be sold represent annual sales of about \$200 million and employ about 1600.

Varian said it will retain "core businesses" that are electron devices, analytical instruments, semiconductor process equipment, and medical therapy equipment.

For information from Continental, contact Walt Rice at 214-381-7161.

Digital Group Meets

(continued from page 1)

FM service which is degraded in a way we have no control over."

Engineers who have met include CBS Radio Technical Operations Director Tony Masiello; Susquehanna Senior VP Charlie Morgan; ABC Radio Satellite Systems Director Robert Donnelly; communications attorney Robert Mazer of Nixon Hargrave, Devans & Doyle; EZ Communications DE Bud Aiello; Infinity's WJFK CE Dan Ryson; and National Public Radio Engineering and Operations Director Don Lockett and Senior Engineer Mike Starling.

Donahue said that the group has the support of the FM industry's major players and is concerning itself only with FM issues.

The group held two meetings in May after being informally organized at NAB '90.

Donahue said the group has asked the NAB through Science and Technology Senior VP Michael Rau for its position on digital broadcasting and the group's efforts. A response is expected after the NAB Board meeting to be held in June.

"We invited the NAB to participate because we want to speak with one voice and not waste our efforts. We've given the NAB an opportunity to state its position. Before we move much further we need NAB's position."

Donahue said the committee hopes to stress the need for FM stations to become more informed in an increasingly competitive environment.

"If the public is saying with their buying dollars that they want higher quality and we're not delivering the quality they want, then we are violating a public trust."

POWER...

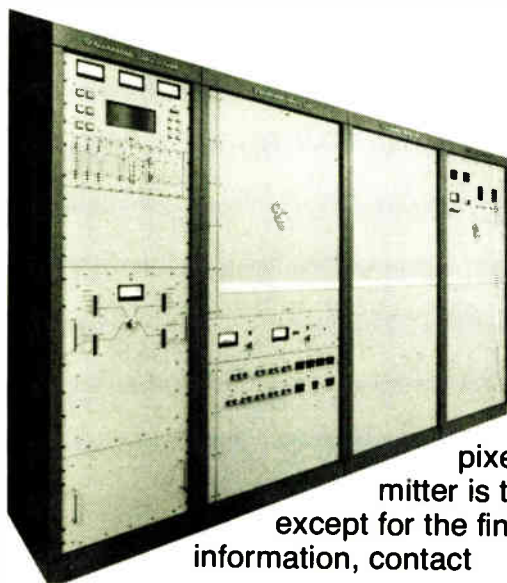

60,000 WATTS

The 817A has a single output of 60kW and is totally self contained. An internal viewing screen provides seven screens on a pixel display. This transmitter is totally solid-state except for the final PA tube. For more information, contact

varian®

continental electronics division

P.O. BOX 270879 DALLAS, TEXAS 75227 (214) 381-7161 FAX NUMBER (214) 381-4949



JNS - CD Quality Switchers

Two families of audio routing switchers - 8300 & 9000

- ALL with CD level performance
- from 1 x 10 to 60 x 60
- with level metering
- with relay crosspoints
- optional machine control
- from LED indicator switches through PC/computer control

8310
10 stereo in
1 stereo out
\$895.00!!



8310

J.N.S. Electronics, Inc. 408/729-3838 FAX 408/926-1003

P.O. Box 32550, San Jose, CA 95152

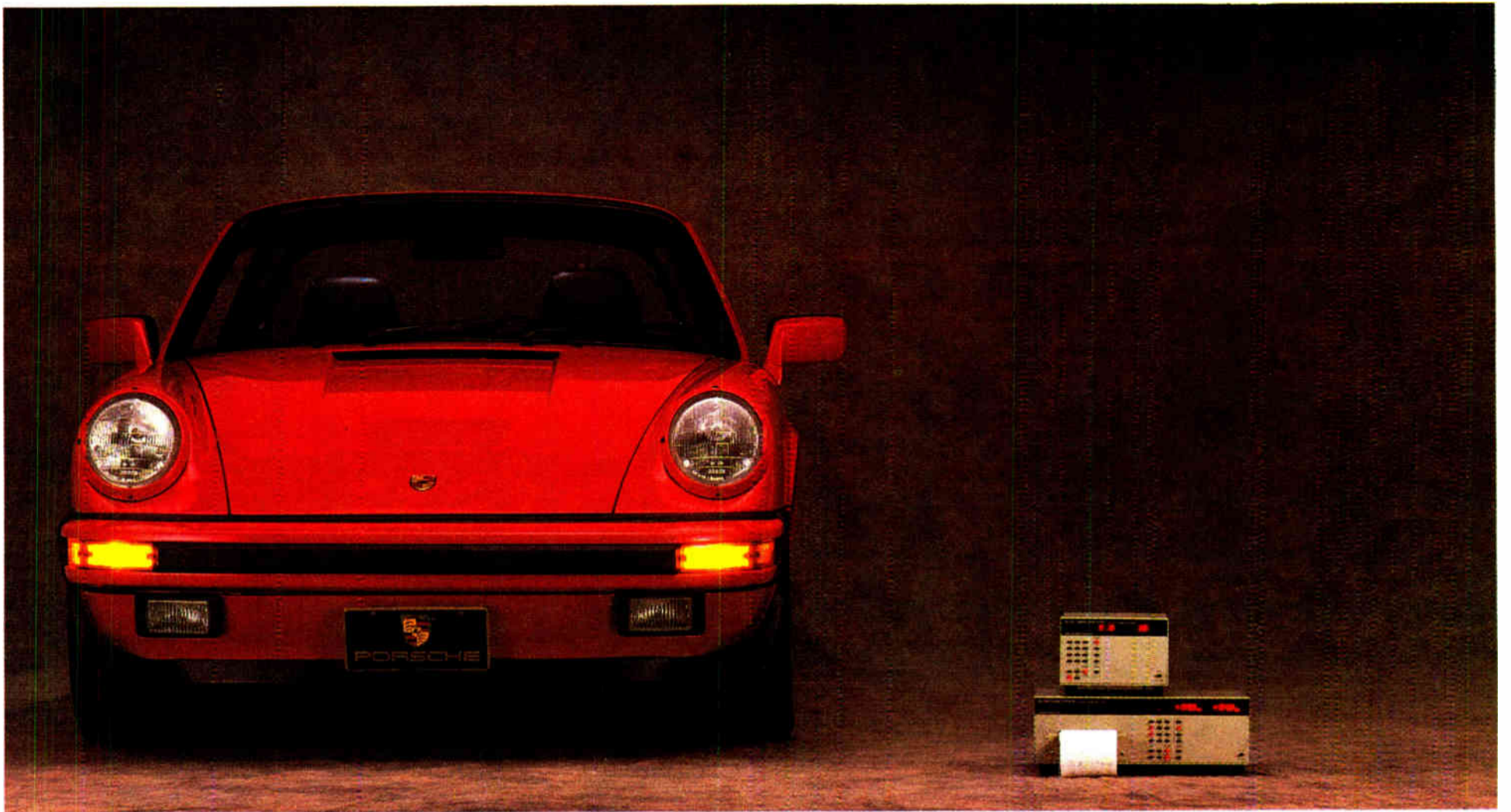

Fast.

Very Fast.

On your left, the Porsche 911 Targa Carrera, one of the fastest production cars in the world. It goes from 0-60 in just 6.1 seconds. *Fast.*

On your right, the revolutionary Schmid SIAT, the world's fastest, most precise audio network testing system. It features technology so advanced, you can check 10 critical parameters of your audio broadcasts, including noise, harmonic distortion, frequency/phase response, channel transposition and more, all at the push of a button.

Even more impressive, you can test *any* transmission network, from the simplest to the most complex, all from a single location. All in an amazing 5 seconds flat. *Very fast!*

No more time-consuming manual tests. No more annoying tone tests. No more service interruptions. Instead, faultless audio transmissions that will leave your viewers and listeners coming back for more.

Save time. Save money. All while revving up your audio performance. For more information and a *free* copy of our SIAT video presentation, call toll-free 1-800-955-9570 or mail the coupon today.

RW

Yes! Please send me the SIAT video at no cost or obligation.

Please call with additional information.

Name _____

Title _____

Company _____

City/State/Zip _____

Country _____

Phone _____, Fax _____

Mail to: Schmid Telecommunication, 15 West 26 Street, 12th fl., New York, NY 10010

U.S. Sales Office: Holzberg Inc. □ P.O. Box 323 □ Sea Bright, NJ 07760
Tel: 201-530-8555 Fax: 201-842-7552

Canadian Sales Office: M.S.C. Electronics Ltd. □ 147 West Beaver Creek Road
Richmond Hill, Ontario □ L4B 1C6 Canada □ Tel: 416-731-9500 Fax: 416-731-5195

Headquarters: Schmid Telecommunication □ Rieterstrasse 6 CH-8002 Zurich
Switzerland □ Tel: 011 41 1 206-1111 Fax: 011 41 1 201-2372

SZ Schmid
Telecommunication

TAKING IT TO THE STREETS

Programming Crossroads-Radio programming is now at a crossroads with stations using sound alike formats to attract target demographics. How your station gets its next advertising dollar may depend on how you handle remote broadcasts. Remotes will give you an edge on the competition, involve your listeners and give you station recognition.

The Premium Vehicle- You need a premium vehicle to broadcast the cleanest sound. Your next remote doesn't have to be an audio compromise. Deliver studio quality sound with the **new Moseley Remote Programming Link 4000**.

Quiet Ride- The **RPL 4010 Transmitter** delivers up to 20 watts in a package that's lightweight, portable and field programmable.

You can drive to your remote with confidence that the **RPL 4020 Receiver** will operate in high RF environments virtually immune from adjacent channel interference.

Cruise Controls-

You and your air talent will enjoy the easy set-up of the RPL 4000 featuring a built-in 3-channel audio mixer for mic and line inputs, 2:1 internal noise reduction, two frequency operation, wide/narrow bandwidth and extensive metering and diagnostics. The RPL 4000 is also fully compatible with existing RPUs.

Service and Support-

As with all Moseley products, the RPL 4000 carries a 2 year warranty and 24 hour technical support.

The RPL 4000 puts you in the driver's seat. So what are you waiting for. Get your economical **Moseley RPL 4000** and take it to the street!

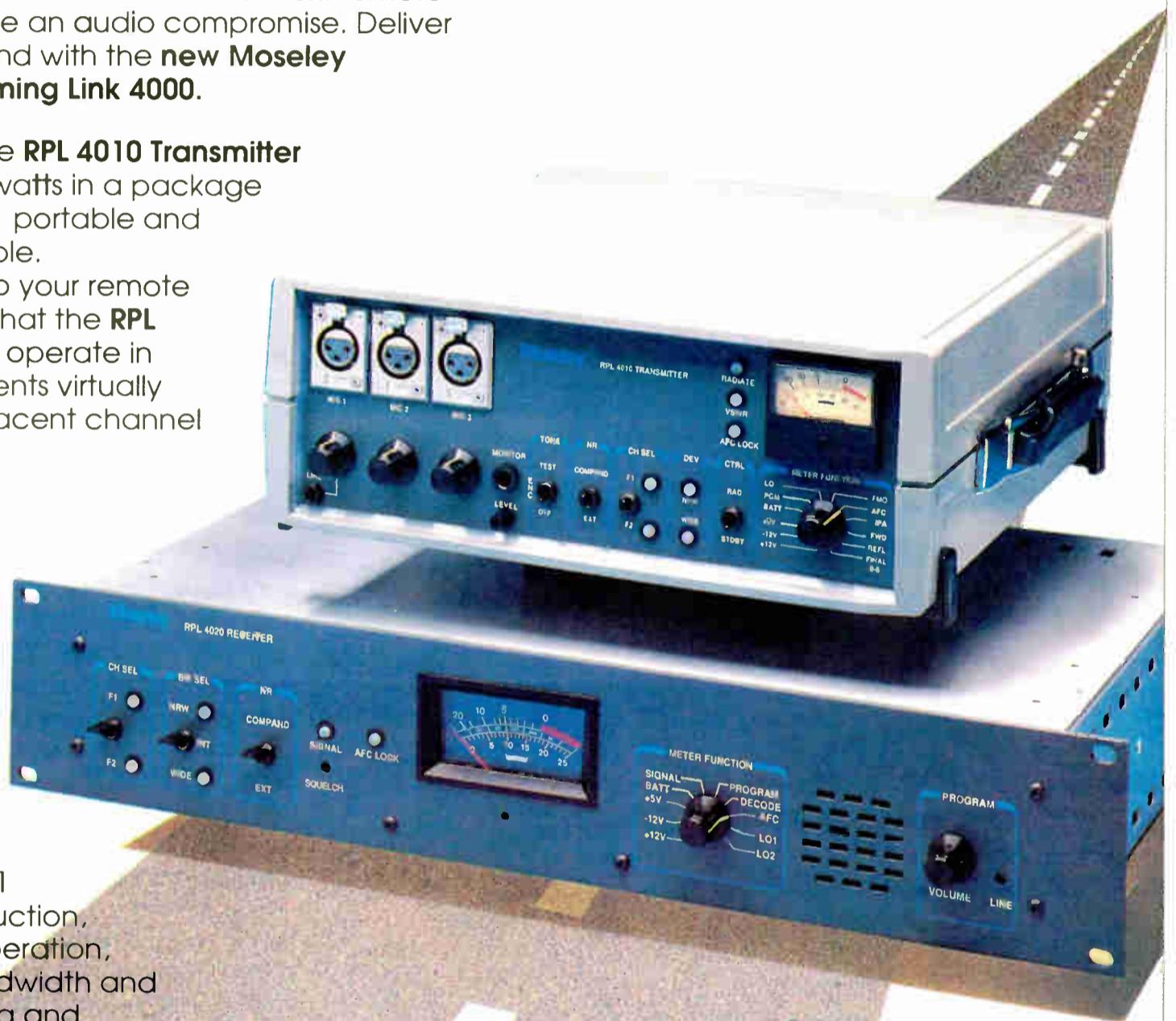

Destined to be a classic, the RPL 4000 is available NOW from your favorite Moseley dealer!

Moseley

The Trusted Name in Communications

Moseley
Associates
Incorporated

111 Castilian Drive
Santa Barbara, CA USA
93117-3093

a
GRC Int'l
Company

Phone 805 968 9621
Telex 658448
FAX: 805 685 9638

Circle 13 On Reader Service Card

World Radio History

VOA Phase 2 Done

by Charles Taylor

Washington DC The Voice of America (VOA) has completed the second phase of its long-awaited 19 broadcast studio renovation project, bringing to completion a

Rinaldo Lauds FCC

John Gatski

Washington DC One of radio's key congressional allies has praised recent FCC attempts to help the ailing AM band with a proposed rulemaking that would open up the expanded band and mandate AM stereo.

Rep. Matthew Rinaldo (R-NJ) of the House Telecommunications and Finance Subcommittee told *Radio World* that the FCC's action is a reflection of FCC Chairman Al Sikes' commitment to AM.

"I'm pleased that Al Sikes has made the viability of AM radio a top priority," Rinaldo said.

Rinaldo, the ranking Republican on the House Telecommunications and Finance Subcommittee, has been trying to bring about AM improvements through the legislative process.

Last year, he introduced the Radio Quality Improvements bill (HR-2714). The legislation would mandate the FCC to seek technical relief for the crowded, interference-ridden AM band.

The bill also would require receiver manufacturers to add AM stereo to FM-stereo equipped receivers, limit FM translators and move stations to the expanded band (1605 kHz to 1705 kHz) while allowing them to continue broadcasting on their existing frequency for five years.

The FCC's recent proposed rulemaking also addresses several of these concerns. They include moving interfering AMs to the expanded band, offering incentives for or possibly requiring stations to broadcast in AM stereo without designating a standard, abolishing AM simulcast on FM and changing protection ratios.

With the introduction of the AM bill last year, it became obvious that concern about the AM band extended into Congress, according to Rinaldo.

But he said, it does not matter who initiates a plan along as action is taken to help AM.

"My chief concern is that local AM service is improved and interference is reduced," Rinaldo said.

Although the bill and the FCC action addresses similar AM issues, Rinaldo said they take different approaches in some areas.

"Wherever they (FCC) fall short, we are going to put it in our bill," Rinaldo said.

In its final form, HR-2714 should be a "consensus" bill that will be supported by Congress, broadcasters and the FCC, he added.

Also, the AM technical bill is likely to contain an amendment to codify the FCC's April 1990 regulations that changes the comparative renewal process to prevent third party payoffs, according to Rinaldo.

contract more than 15 months overdue.

Phase 2 included the complete modernization of 10 broadcast studios, including custom-designed multi-bus stereo mixing consoles, bus mix-minus systems, open reel analog tape recorders, cart decks and a state-of-the-art IFB/monitoring system.

Gary Marco, president of the National Federation of Federal Employees Local 1418, VOA's technical union, confirmed that the project's contractor had completed work on the studios.

"We've got our guys in there now with the goal of making them ready for production and studio work," Marco said.

Completion of the 10 studios wraps up a \$6.63 million contract that has been plagued by delays and unforeseen troubles since it was signed three years ago. The project's first phase of nine broadcast studios was completed last spring, nearly a year behind schedule.

Problems encountered in the first phase ranged from the discovery of wires that were leaking hazardous PCBs to the removal of asbestos. Equipment delays also kept Phase 1 from timely completion.



Xu Kai-lan (left) and Michael Yan tape a Voice of America program for VOA's China branch.

Studios in Phase 2 are scheduled to begin operation by the end of May, according to VOA.

An interview with "Orbie," the Orban Dalmatian.

HOME: San Francisco, California

PROFESSION: Orban Products spokes-dog.
(Eat your heart out Spuds!)

AGE: 35 (that's 5 in human years).

QUOTE: "Orban has a passion for quality that is exceptional among companies today."

PROFILE: Reliable, versatile and technically outstanding (like Orban products).

ON ORBAN: "Orban maintains the highest technical standards and delivers the most thoughtfully engineered audio processors on the market. Reliable products, purpose-built and backed by great customer service. That's dogged perfection!"

FAVORITE PRODUCTS: "Compressor/Limiters, De-Essers, Stereo Synthesizers, Parametric Equalizers, Spatial Enhancers, Programmable Processors and of course, the OPTIMOD. The entire line is unsurpassed in quality."

FAVORITE SONG: "You Ain't Nothing but a Sound Dog."



a division of AKG Acoustics, Inc.
1525 Alvarado Street
San Leandro, CA 94577 USA
Tel: (1)415/351-3500
FAX: (1)415/351-0500

LISTEN TO THE DIFFERENCE.

Compressor/Limiters, De-Essers, Stereo Synthesizers, Parametric Equalizers, Transmission Processors



Circle 122 On Reader Service Card

RADIO PRODUCTION 1990.

Total creative control,
starting at less than \$6,500*.

Interface easily to analog
and to all major digital formats.

Fast learning curve to
high creative output.
Difficult editing tasks
made quick and easy.

Time expansion and
compression—without
pitch change

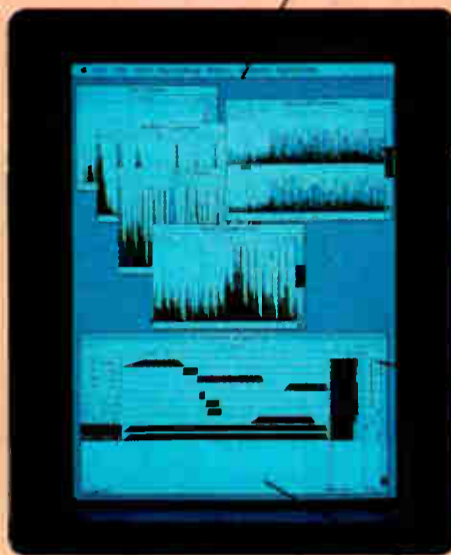
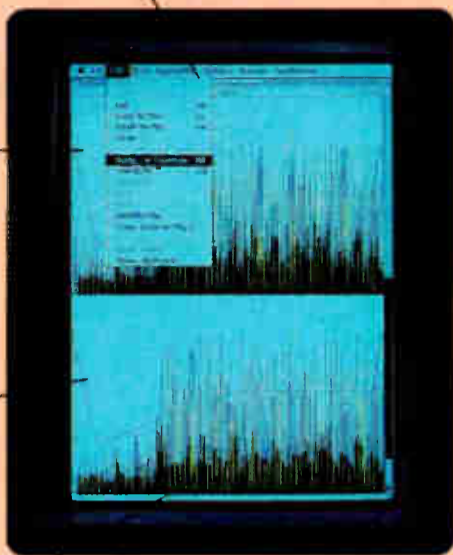

"Duck" a background
track beneath a voice-
over. Fade-out/fade-in,
with complete accuracy.

Storage capacity from 10
minutes to 6 hours of
stereo digital audio.

Superlative audio quality.
Multiple mixes and
multiple generations—
without degradation.

Easily expandable and
upgradable—now
and in the future.

STUDER DYAXIS. DIGITAL AUDIO HARD DISK FOR RADIO. YOUR LOW COST WAY TO BEAT UP ON THE COMPETITION.

Ratings wars—the push to get
advertisers—the crunch on operating
costs... You always need to move faster
and be better than the competition.

The station offering quick turn-
around and the ability to produce more
complex, sophisticated and creative
spots, jingles, promos and programs is
likely to be the winner. With Dyaxis,
you can *be* that winner. Your adver-
tisers love you. Your listeners love
you. And your competition hates you.

The Studer Dyaxis is the most

powerful and cost effective hard disk
digital recording/editing system
available, starting under \$6,500*—*proof*
that digital audio for radio doesn't have
to be expensive.

No ad can tell you all that Dyaxis
will mean to production at your station.
So call us at **800-366-4900** for our
12-page Dyaxis color brochure and
read about your exciting future in
digital audio editing with Dyaxis.

Now, *see* what you *hear*. On Dyaxis.
From Studer, a name you can trust.

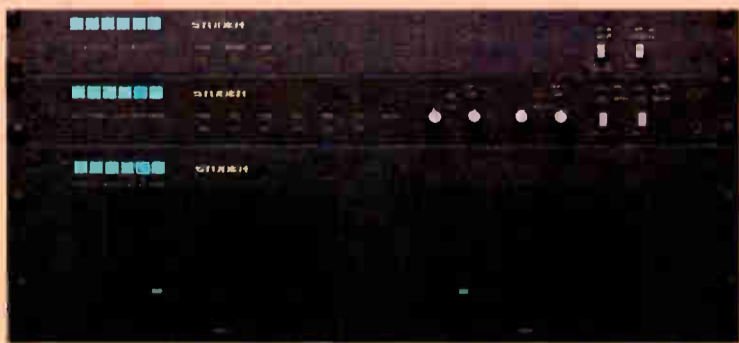

*Price not including Apple Macintosh computer.

STUDER REVOX

Studer Revox America, Inc.
1425 Elm Hill Pike • Nashville, TN 37210 • (615) 254-5651
New York (212) 255-4462 • Los Angeles (818) 780-4234
Studer Revox Canada Ltd., Toronto (416) 423-2831

NOW AVAILABLE
MacMix™ version 2.3
and
Excellerator/DSP Card

Circle 57 On Reader Service Card

World Radio History

Audio Cards for IBM

by Frank Beacham

Albuquerque NM The IBM personal computer sitting on your desk now has the capability to become the centerpiece for an automated digital radio station, according to an announcement here by Ariel Corp. of Highland Park, NJ.

Two new circuit cards were shown at the International Conference for Acoustics, Speech and Signal Processing (ICASSP) that turn IBM-compatible desktop computers into complete audio post production workstations and digital routing devices for DAT audio recorders, CD players and storage disks.

The PC-56D card, priced at \$895, allows any PC to perform functions such as digital audio recording, filtering, compression/decompression, multiplexing, mixing, transferring sounds to disk and recreating original or modified sounds, speech or data.

The DAT-56 card, priced at \$1995, interfaces a PC to DAT decks, CD players and other professional audio equipment using the AES/EBU digital interface standard.

Hard disk recording

The card includes a SCSI interface that permits the recording of digital sound to standard hard disk drives and comes with DSPnet, intelligent networking software that allows the connection of multiple cards circumventing the need to use the host PC bus.

DAT-56 can also interconnect to digital audio products that transmit by both electrical and fiber optic mediums.

"With properly configured software, PC-based systems can use the new cards to create anything from a small post production studio to a full blown digital radio station with the IBM PC as central audio mixing console and automated controller," said Tony Agnello, president of Ariel Corp.

"DSPnet allows you to synchronize across multiple two-channel DAT-56 boards so you can create a multi-channel recording/editing system. All of your mixing is done digitally with 24 bits of precision," Agnello said.

Up to seven 600 megabyte hard SCSI hard disk drives may be used for audio storage, allowing a system to hold about seven hours of audio programming on random access disks.

Motorola processor

Both circuit cards utilize the Motorola 56001 digital signal processor, which creates the ability for PCs to transmit, store, manipulate and recreate compact disc quality sound.

Both boards connect to Ariel's recently introduced digital microphone, which captures stereo analog signals and then digitally encodes them for the PC to analyze, modify or store on computer disk.

"With our digital microphone and DSP boards, PCs become multimedia systems, digital recording studios, speech recognition development systems, scientific and data acquisition instruments," Agnello said.

"Our aim is to provide a hardware bridge; upgrading the installed base of conventional PCs to a new performance level which contains features and abilities found only on the most expensive, most innovative computer platforms."

Ariel, Agnello said, also offers equip-

ment developers complete software development tools such as assemblers, debuggers and example programs.

He emphasized Ariel is not developing end user software for the new DSP cards, but is aiding companies who do so.

Agnello, one of the inventors of the Eventide Harmonizer and other digital processing products, said both of the new circuit cards were to be available for delivery 1 May.

For information contact Les Listwa at Ariel Corp., 201-249-2900.

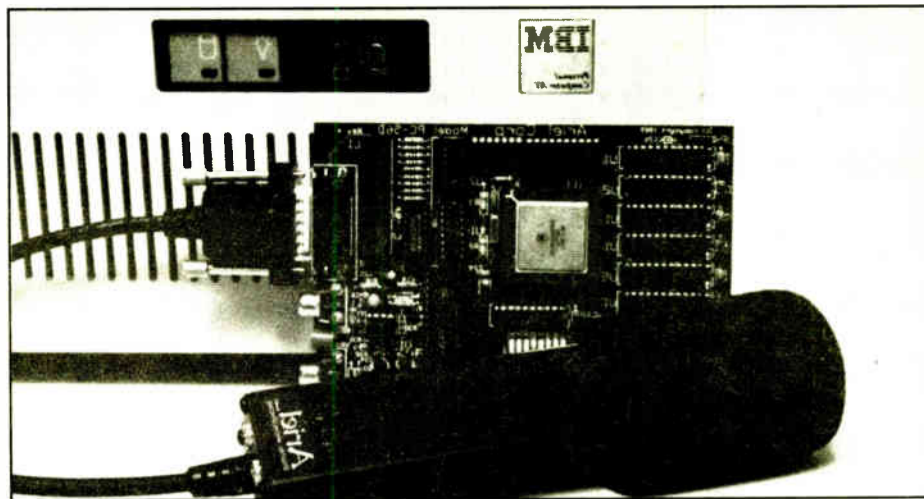

Ariel's PC-56D and digital mic can now bring speech and stereo audio features to IBM PCs.

Digital Frequency Extension

The only way to squeeze more sound out of the telephone line is to squeeze more sound into it.

The telephone bandwidth, 300 to 3300 Hz, is its biggest limitation. Anything below 300 Hz is lost forever. The result: your remotes sound like they're broadcast from inside a 55 gallon drum. But now there is a solution.



THANKS TO GENTNER, I'M ON-AIR FAST AND SOUNDING GREAT!

How We Squeeze More Sound Into The Phone.

It's called Frequency Extension, though it would be more accurate to think of it as Frequency Recovery. Basically, before the signal goes down the phone line, we digitally up-shift the signal 250 Hz. This "squeezes" the low frequency information, normally lost, into the phone line. When the signal gets to the station, we digitally down-shift the signal 250 Hz to recover the low frequency information. What reaches your listener is a fuller, richer, more natural sound.

At Gentner, You Don't Just Get A Box, You Get A Choice.

In the studio, you options start with the EFT-100, a low cost unit designed to be used with your existing hybrid and our new SPH-5E, a combination frequency extender and full-featured on-air telephone hybrid. The SPH-5E gives you the superior audio quality associated with frequency

extension plus, at the touch of a button, the added benefits of a telephone hybrid.

For frequency extension from the field, the EFT-900 and EFT-1000 expand on the capabilities of the EFT-100. With internal mic and headset amplifiers and telephone couplers, you will haul less into the field and get on-air much faster. The EFT-1000 even includes auto-answer and auto-setup functions.

All Gentner extenders include filtering to reduce hum, built-in noise reduction and special processing of the high frequencies. Best yet, Gentner extenders are full duplex devices allowing true two-way communication. You get cues back to the broadcast site without compromising the effectiveness of your remote system or juggling unnecessary hardware.

Would You Believe Broadcast Quality Audio From Telephone Lines?

That's right, we said broadcast quality. The newest addition to our growing line of frequency extenders, the EFT-3000, gives you enviable frequency response of 50 Hz to 7.5 kHz over three standard (dial up) telephone lines. The EFT-3000 is broadcasting's first and only three-line digital frequency extender. And, it's a breeze to operate. Just plug in the phone lines and speed dial the station from the DTMF pad on the front panel. Then punch the Auto-Setup button. The EFT-3000 tweaks all three lines and you're on the air. You even get inputs for two mics and two headsets so you can do two person remotes without all the extra gear.

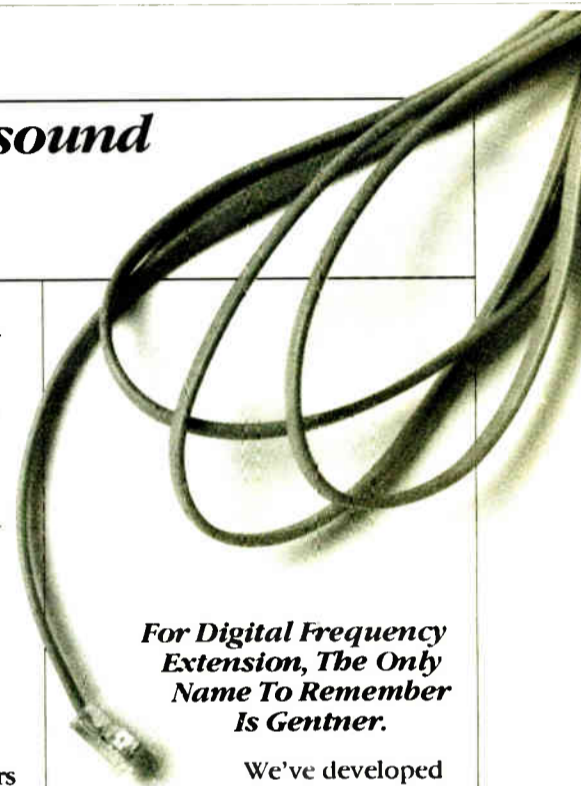

For Digital Frequency Extension, The Only Name To Remember Is Gentner.

We've developed the widest range of frequency extenders so you can easily squeeze just the right product into your system and your budget. For additional specs and the name of your Gentner dealer, squeeze a couple of minutes out of your busy schedule right now, and give us a call.



THIS THING SPEED DIALS, SETS LEVEL AND EQ AND MAKES ME SOUND LIKE I'M IN THE STUDIO!

GENTNER

Gentner Electronics Corporation
1825 Research Way
Salt Lake City, UT 84119
(801) 975-7200
Fax: (801) 977-0087

"Call me, I'm interested." Circle 59.

"Send me literature." Circle 140.

VOA Hits Environmental Snag

by Charles Taylor

Negev Desert ISRAEL Construction of a radio transmitting station here that the Voice of America (VOA) intends to use for the broadcast of programming in at least 20 languages has been stalled by environmentalists who claim the project would create more trouble than it is worth.

The \$270 million station, a joint project with the US Board for International Broadcasting (BIB), has been in the planning for more than five years.

The agency would use the transmitting station to deliver programming to

Soviet Central Asia, East Africa and South Asia, according to VOA spokesman Michael Schoenfeld. VOA would employ six of 16 transmitters and 22 of the 37 antennas at the station. Peak height of the antennas is 558'.

"This station really is a vital part of our worldwide modernization programs," Schoenfeld said.

Birds and plants affected

Opposition was raised in late February when the Society for the Protection of Nature in Israel said at a Congressional hearing that the project is in the pathway of the major bird flyway con-

necting Europe and Asia with Africa and also threatens thousands of desert plants, according to published reports.

The organization also claimed that the project would emit RF waves that might interfere with the guidance systems of planes flying from a nearby Israeli air force training base.

"I would like to see you stand up and scrap this undertaking that will disturb the environment and the quality of life," said Yoav Sagi, chairman of the society.

Most claims refuted

Pat Sowick, a spokesperson with the BIB, said that most of the environmental claims brought up by the group are refuted in a \$2 million environmental impact study conducted in the early stages of the project's planning.

(continued on page 18)

Accuracy in Measurement

(continued from page 5)

deviated test signal about 3/4 of the way up the screen, representing about 1 kHz deviation per tenth of a division. How thick is the trace? 500 Hz to 1 kHz thick? The equivalent of 1% modulation?

How flat is the scope's response? How flat is the display? What about parallax error between the time you set the reference to a line on the screen and the time you sit down to "observe" the overmodulating station?

You can bypass the errors related to display and observation by using a digital oscilloscope. Have the scope calculate the difference between the reference and some maximum value you have chosen on the screen. With, say, a thousand vertical points of resolution, you have the equivalent of about one tenth of a percent modulation per step. (Plus or minus at least one step, of course. This is digital.)

What point do you pick to measure? Pick the apparent top of the accumulated traces (on a storage scope) or something which looks like a typical maximum level (on a digital scope). On most well-engineered stations this will be at a pretty clear level on the screen, with occasional higher excursions. But is that value the level of the peaks of frequent recurrence or the cutoff level of nearly all the peaks regardless of duration and frequency of occurrence?

There is nothing on the screen to characterize the duration of those peaks for you. You use your eye to perform a statistical

analysis. With a little practice, you can judge it pretty well, but it's not empirical!

What this discussion points to is the fact that there is room for error and uncertainty when trying to measure an FM broadcast station's modulation.

The FCC's method of measurement is not as precise or accurate as it might seem. At the very least, if the FCC is going to use this method of enforcement it should do the following:

1. Properly identify the uncertainties in its measurements and include them in their reporting (e.g., 103%, $\pm 5\%$).
2. Announce one acceptable, rigorous, repeatable method for all to use to measure modulation. Define what a peak is in the context of that measurement method.
3. Establish an official range which is enforcement-neutral to allow room for the combined errors of the broadcaster and the FCC (say, through one dB over your applicable modulation limit). Balance this with a penalty for any modulation which the FCC measures even one percentage point above the neutral range. Then, any station which tries to take advantage of the enforcement-neutral range does so at its own peril.

Better yet, since the purpose of enforcing modulation standards is to prevent harmful interference, let's switch to using occupied bandwidth as the primary enforcement tool.

■ ■ ■

David Maxson can be reached at Broadcast Signal Lab at 617-864-4298.

GET IT RIGHT
GET IT FROM ALLIED

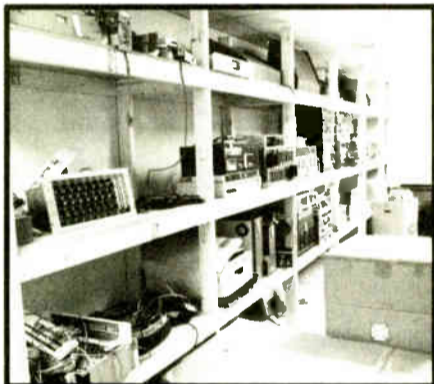

Our Shelves Are Filling Up Again—Thanks To Your Response

Now for you bargain hunters and stations who want to upgrade equipment on a restricted budget—we've got lots of 'goodies' available. You'll probably see this ad before our quarterly flier is off the press—so call our veteran gurus (Jim and Chuck) pronto and check out our stock and great bargain prices. Do some 'horse trading' with these guys—they're push-overs!

We accept TRADE-INS on buys of new equipment. We SELL USED and NEW broadcast equipment (demos, over-

stock, scratch & dents, etc.). We also selectively BUY used radio equipment of various vintages. Call or FAX today to get the items you want and need. This stuff won't be around long enough to collect dust.

HARRIS ALLIED
EQUIPMENT EXCHANGE

FAX 317-966-6321

317-962-1471

635 SOUTH E ST. • P.O. BOX 1487 • RICHMOND, IN 47374

©HARRIS/ALLIED 1990

If Your Program Automation Can't Do This For You Call Us

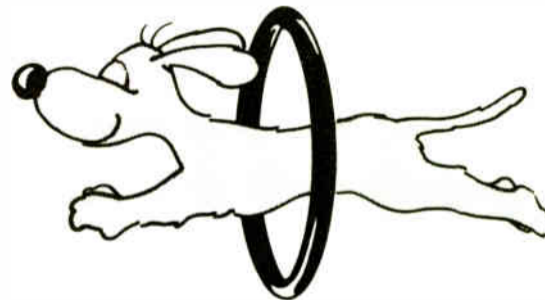

Unrivaled Performance

AN INTERNATIONAL BROADCASTER needed to run 16 systems from a single control center. IGM jumped at the challenge, and delivered.

A MAJOR NETWORK wanted to feed commercials to multiple time zones, simultaneously. IGM sat up, listened, and delivered again.

A SMALL STATION needed a complete walk-away system so it could concentrate all of its labor into sales. It heard IGM speak, "We can do it," and IGM delivered yet again.

Complete Systems

WE ENGINEER AND ASSEMBLE our own circuit boards and machine all of the mechanical components.

WE BALANCE THE PIECES, QC them from beginning to end, and test the final product rigorously before it ever leaves our Bellingham, Washington facility. But it doesn't stop there.

WE'RE LOYAL TO OUR CUSTOMERS, long after the sale. We support our equipment, no matter how long you own it.

35 Years In Automation - Creator of Instacart™ & GoCart™

IGM COMMUNICATIONS
(206) 733-4567

The best warranty in the business!

4041 Home Road
Bellingham, WA
98226
FAX:
(206) 734-7939

"Call me, I'm interested." Circle 17.

"Send me literature." Circle 114.

Circle 129 On Reader Service Card

RADIOMIXER.[®] For everyone who thought a PR&E console was out of reach.

You've tried, but your console budget just can't accommodate a Pacific Recorders BMX—not this time. So you're probably thinking about settling for a copy, even though it won't have the standard-setting features, performance and long-term reliability that have made our BMX consoles so successful.

Fortunately, you don't have to settle. Radiomixer is genuine PR&E. All the way from its high quality components to its efficient BMX-style layout, comprehensive telephone mix system and unique Off Line Mix Matrix. Yet its manufacturer-direct price is no higher than the "clones."

How did the PR&E engineering team build a less expensive console without lowering our standards? Let's start with what we didn't do:

We didn't compromise on quality. Radiomixer uses the highest caliber components throughout, including our standard professional-spec meters, faders, and switches. Plus the best-sounding VCA technology in the industry. To keep Radiomixer's cost down, we've limited the number of different module types and mainframe sizes, and simplified the construction of the card frame, mainframe and modules.

The final result? In less than a year, Radiomixer has quietly become one of our most popular consoles. In fact, it's now one of the best-selling boards in broadcasting. Our color brochure will tell you more of the reasons why, and help you configure a Radiomixer for your particular application. To get your copy, call PR&E direct at 619-438-3911.



PACIFIC RECORDERS & ENGINEERING CORPORATION
2070 Las Palmas Drive • Carlsbad, CA 92009 • Tel 619-438-3911 • Fax 619-438-9277



© 1990 Pacific Recorders
& Engineering Corporation

Circle 110 On Reader Service Card

SF Radio Trailblazer Reminisces

At only 40, Bonnie Simmons already can be called a pioneer in San Francisco radio. She was at the vanguard of the progressive FM sound that was uniquely San Francisco radio, as program director and DJ at KSAN-FM from 1969 to 1978.

Recently a compilation of KSAN programming with legendary disc jockey Tom Donahue was released on compact disc. Simmons, who later worked at other Bay area stations, has left broadcasting.

Today, she plays records without a playlist at Slim's, Boz Scaggs's San Francisco nightclub. *Radio World* Los Angeles correspondent Frank Beacham recently talked with her there.

RW: What was so special about KSAN and San Francisco radio during the late '60s and '70s?

Simmons: There was an alternative lifestyle at the time that you could program to because you were part of it and understood it. When I was on the air at KSAN, I knew exactly who I was talking to.

Hardly any of us had any radio experience, with the exception of (Tom) Donahue who hired all of us. We came into it through a love of music and a love of radio that was never schooled.

We broke a lot of the rules that a lot of people seem to think are important and I think that was part of our charm. We had no sense that we were making history. We were just a bunch of hippies

having the best time of our lives and somebody was paying us.

RW: I've been told that radio programmers from all over the country used to come to San Francisco, check into a hotel room and record KSAN and other stations with new formats in the market.

Simmons: They did, but what they never understood is there was no format. (Laughter). It was a radio station with 35,000 record albums. They were within 30 feet of you while you were on the air and nobody ever knew what they were going to play from one record to the next.

We played rock'n'roll, gospel, R&B ... we played blues country.

RW: When did radio begin to change in San Francisco?

Simmons: In the late 1970s. Part of it is that radio is real estate rather than anything that has any heart to it any longer. Stations are so expensive that the people who can afford to buy them are not going to take a chance for the love of radio.

Radio today does not allow the passion of the people on the air to come through. You are so restricted in everything you do. For the most part, every record is picked for you. Every liner card is written for you. Every nuance is planned.

KSAN wasn't just a music station. It had an extraordinary public affairs department. It had an award-winning

news department. The jocks were all people who were out on the street. They went to shows. They knew what was going on in town. These are not commodities that are easy to come by.

RW: How do you feel about today's stations in the San Francisco market?

Simmons: I talk to a lot of listeners. People climb up the ladder here at Slim's

and talk to me about radio. I've never had anybody climb up the ladder and say, "Ain't radio great?"

Everybody complains about it. I believe, especially in the Bay area, there is a huge disenfranchised radio listening audience that no longer listens. KFOG and KRQR supply them nothing. They don't play new records. That infuriates me.

With the exception of KMEL, which is an urban station—they do a mindblowingly good job. That is a great urban station. Then, you can listen to Live 105 and hear the modern European stuff.

(continued on page 21)

VOA Plans Are Stalled

(continued from page 16)

"It's complex and there's certainly disagreement about it, but while there's a lot of emotional testimony that came from people from Israel and the United States, they still have yet to produce evidence of any real danger," Sowick said. "There are shortwave transmitter facilities all over the world, and there really has not been any link with any ill effects on plants or animals as a result.

"My interpretation is that perhaps they're giving it the last hurrah here to defeat it. It appears imminent at this point," she added.

The issue of interference with the Israeli air force training base is not covered in the study, according to Sowick, because it was not raised until after completion of the report.

To date, the plot of land for the transmitting station has been partially

cleared, however, a final contract for construction is pending resolution of the conflicts with the Israeli National Board for Planning and Building.

Language services restored

Meanwhile, on another front, VOA got good news from its parent agency, the United States Information Agency (USIA), when Director Bruce Gelb told VOA officials 2 March that funding has been restored to continue its language services division.

The 2 March announcement came two weeks before the division, which provides worldwide programming in numerous languages, was slated to shut down because of federal budget cuts.

The division is budgeted at \$3 million a year.

For information, contact VOA public affairs at 202-485-7050.

Heart Monitor.

No matter how you look at it, the heartbeat of your TV station depends on a healthy transmission line. If a problem develops, how would you ever know until it's too late?

Now there's a way to check your line thoroughly and accurately before a simple problem becomes a major malfunction. It's the PRH-1 High Power Pulse Reflectometer from Delta Electronics.

The rugged PRH-1 puts out a low current, 5,000 volt variable pulse that overcomes the obstacles of long transmission lines, with no risk of damage. What you end up with is a series of echoes from the pulse displayed on your oscilloscope screen which represent your transmission line. The shape of the echoes determines the nature of any problem.

The PRH-1 operates like a champ in high RF fields, withstanding interference without any visible degradation of

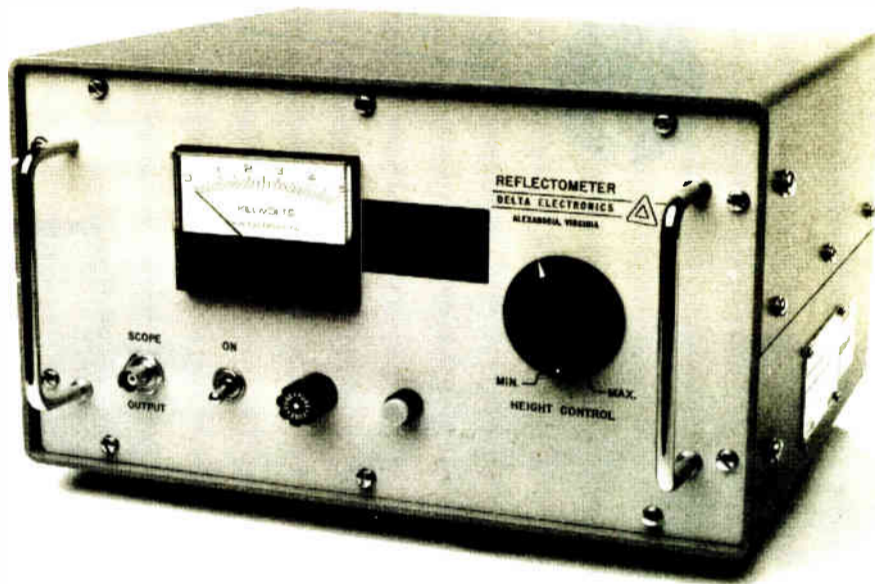

pulse echoes. This makes the PRH-1 ideally suited for crowded antenna farms and community antennas, unlike traditional time domain reflectometers. Its ability to measure AM and FM lines as well make the PRH-1 a sound investment.

What you don't know about your transmission line can hurt you. Considering the consequences you'll suffer being knocked off the air, shouldn't you consider buying the PRH-1 as your top priority?

To see actual PRH-1 test results, call or write today. Delta Electronics, Inc., 5730 General Washington Drive, P.O. Box 11268, Alexandria, VA 22312. Telephone: (703) 354-3350, FAX: (703) 354-0216, Telex: 90-1963.

The Above Standard
Industry Standard.

DELTA ELECTRONICS



©1989 Delta Electronics, Inc.



Robert Lankton, Chief Engineer
WDUV/WBRD in Bradenton, Florida

“Features and specs sold us on Auditronics 200 consoles.”

“Their performance and reliability keep us sold.”

“We wanted a console flexible enough to use in master control, production and news. We shopped for features and specs, but we also looked for ease-of-use and reliability. We got just what we wanted in our four Auditronics 200s.”

Features

“I insisted on outboard power supplies and no monitor amps in the console for noise reasons. I was impressed with Auditronics’ VCA technology, which at the time was not available elsewhere. We wanted the self-contained clock and timer. We needed the switching logic to interface between the A and B inputs, (a neat concept most other consoles don’t offer). And we needed a lot of extra line inputs to support our satellite feeds. We needed a first-rate telephone interface. Auditronics beat its competitor hands-down on this. And, of course, modular design was a must for serviceability. We got it all in the Auditronics 200.”

Specifications

“We go for the widest dynamic range we can get because much of our programming originates on CD. So the 200’s 3dB better S/N is really important. Everything on the Auditronics 200 tests out better than the specs they publish, and you can’t ask for more than that.”

Ease of Operation

“I found the 200 logically laid out and very easy to train our people to use. The jocks like them and can easily under-

stand them, which is very important to management.”

Reliability

“We’re just ecstatic about the Auditronics consoles. They’ve run 24-hours, 7-days since turn-on without a failure. What’s more, they’ve held their specs, which I check every month to audiophile standards.”

“Would I buy Auditronics again?”

“At WDUV/WBRD everybody is happy with both the Auditronics consoles and the support we’ve received from the company. We look forward to doing business with them again.” If you’d like to know more about why Rob Lankton swears by Auditronics consoles, call 1-800-638-0977 or contact



auditronics, inc.

3750 Old Getwell Road, Memphis, TN 38118
901-362-1350

Who's Setting The Pace For FM Transmitter Technology?

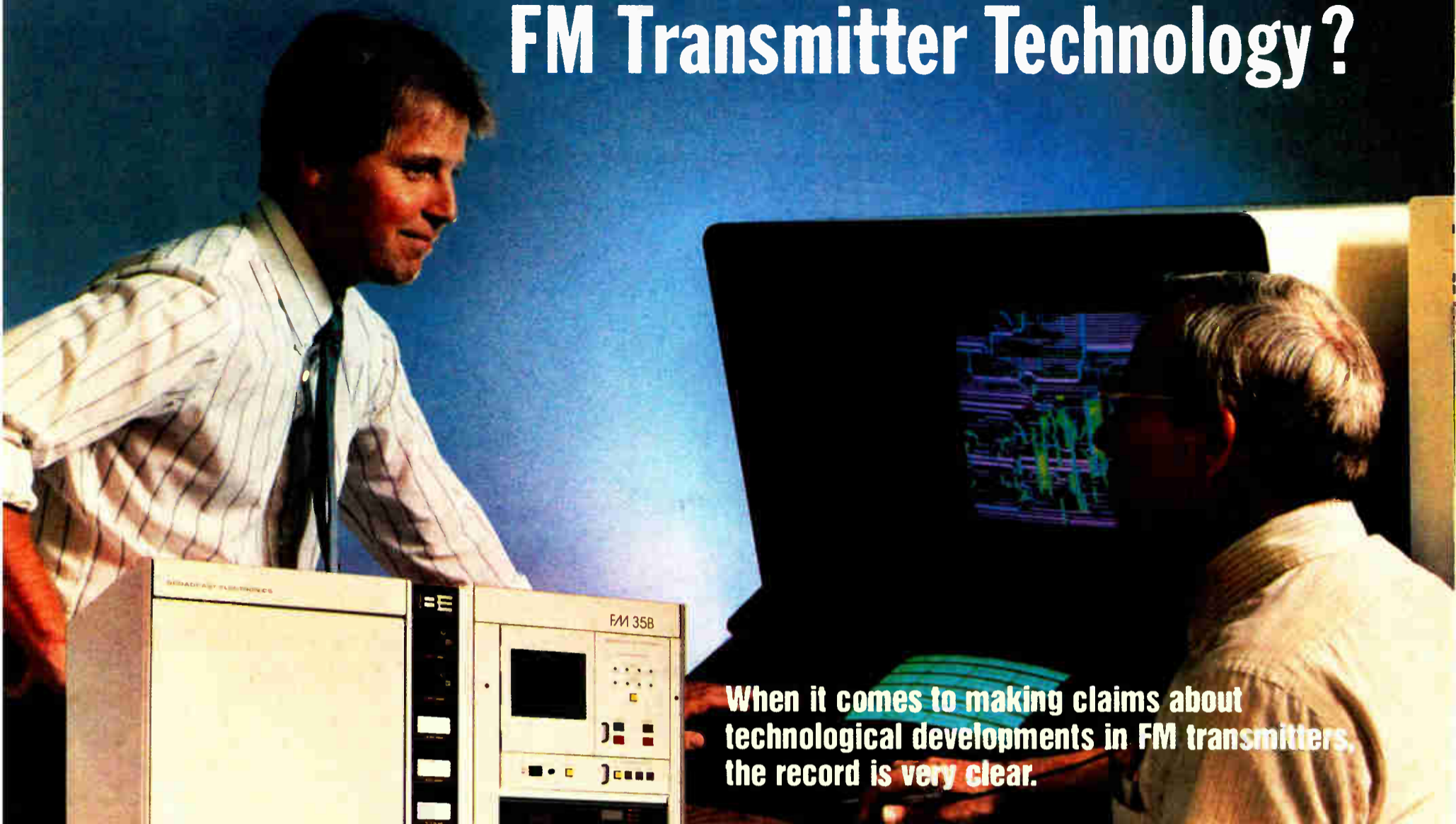

When it comes to making claims about technological developments in FM transmitters, the record is very clear.

Broadcast Electronics:

First to introduce a Proportional VSWR Foldback System.

First to introduce "PWM Automatic Power Control" with "Soft Start".

First to offer a built-in synchronous AM test port.

First to design a single tube high power 30kW FM Transmitter.

First to introduce a single tube 10kW FM Transmitter with a 4CX7500A tube.

First to introduce a single tube 3.5kW FM Transmitter with a 4CX3500A tube.

First to introduce a Microprocessor Video Diagnostic System.

First to offer built-in, PC based, transmitter remote control.

First to offer a standard synchronous FM booster option.

And, Broadcast Electronics again sets the world standard for FM Exciters with the new FX 50 which stands alone in audio performance with 93 dB S/N and .003% THD and IMD.

State of the Art Leadership

Stereo technology, only B.E. designs it all - AM, FM and TV stereo generators.

Broadcast Electronics is the only major FM transmitter manufacturer who designs and manufactures its own solid state intermediate power amplifier (IPA).

All products are backed by B.E.'s 24 hour parts and service and a strict quality assurance program.

The result of this commitment to state-of-the-art innovation is a complete line of RF products, designed to provide you with years of reliable service. Certainly it's clear who **is** setting the standards for FM transmitter technology!

Patented Innovations

Broadcast Electronics has the largest and most skilled engineering staff dedicated to the radio broadcast equipment industry. Significant FM transmitter design patents awarded to B.E.:

- Folded Half-wave Output Cavity, patented 1982.
- Internal Second Harmonic Suppressor, patented 1982.
- Broadband Input Impedance Matching Circuit, patented 1985.

Put our engineering expertise to work for you. Call (217) 224-9600 for the Broadcast Electronics Representative in your area.

BE [®] **BROADCAST
ELECTRONICS INC.**

4100 N. 24th ST., P.O. BOX 3606, QUINCY, IL 62305-3606 U.S.A., PHONE (217) 224-9600, TELEX 250142, FAX (217) 224-9607

Circle 146 On Reader Service Card

World Radio History

Analyzing the Frisco Market

by Frank Beacham

San Francisco CA San Francisco has long been one of America's strongest AM markets because of its mountainous terrain.

"There are some hills here close to 2000 feet tall," said Kevin Mostyn, engineer for KYA-FM and KSFO-AM. "Any FM signal that gets to the other side of the hills is usually weak and noisy."

Partially for this reason AM news/talk stations have long dominated the ratings in the nine-county market surrounding the San Francisco Bay. KGO-AM slipped nearly a point in the winter Arbitron ratings but still held onto the number one position in the market.

People needed radio

"Both the news and talk stations (KGO-AM and KCBS-AM) had a terrific fall book and I think we could attribute a little of that to the 17 October earthquake and to the newsworthy events in Eastern Europe," said Sue Ream, radio specialist at Lewis, Browand & Associates, a San Francisco advertising agency.

Currently the fourth largest radio market in the US, San Francisco is among the most competitive. The market has 61 radio stations, more per listener than Los Angeles or New York.

But the 1980s sales boom of radio stations now appears to be over. "A num-

ber of station sales have fallen through in recent months," Ream said. "I think everybody has pretty much paid the premium price here and are now trying to hang on."

"These debts to service have really gotten out of hand. We've topped out every-



"The Lobster" brings in the morning prime time audience for CBS-owned top rock station KRQR. He's been on Bay area stations since 1971.

The Glory Days of FM

(continued from page 18)

But there isn't a radio station here that plays anything interesting as far as mainstream rock'n'roll new records. And when they do play a new record, they are so insecure about it they have to herald it by announcing it as: "KFOG New Music!"

RW: If you were to program a station today, would you do it again like KSAN?

Simmons: I am not positive that were I given the opportunity to actually do a radio station that I would not have some restrictions. Because I would. Without any restriction, if you come in there and you are having a bad day ... you don't

have anything to save you.

You also have a tendency to get quite self-indulgent. One of KSAN's main problems in the late 70s when things started to sort of go awry, was that we all had become kind of bored with what was going on musically in the mid-'70s and we all latched onto New Wave.

We became so enthralled with what was going on as far as new music that we over-played it. It was overkill on everything. We moved away from our basis that we had for years.

You have to have some control but I think that the format should be something that helps the disc jockeys shine rather than turn them into automatons.

where. And, of course, the junk bond market has failed and there isn't going to be that junk bond money to help pay the bills."

Due to improved consumer receivers, cable television systems which carry radio broadcasts and a recent FCC ruling allowing increased power for on-channel

MARKET UPDATE

boosters, FM has finally emerged as a major force in the market.

"This is a hotbed for on-channel FM boosters," said engineer Dennis Gooch at KABL-AM/FM. "About a year ago we put the biggest booster on in the country. It's 10,000 W and it added a million people to our FM audience."

In July 1987, the FCC allowed broadcasters to increase booster power to 20% of their maximum permissible effective radiated power (ERP).

The old rule limited stations to a 10 W maximum power limit. Gooch said about 15 San Francisco stations have boosters operational or planned. He said they help fill in the gaps where FM signals are lost due to rugged terrain.

"FM is now doing pretty well here," Mostyn said. "But you can't deny that it's often hard to get an FM station. If we are able to fill in the gaps with boosters it will improve the situation considerably. Right now the problem is getting a usable signal to areas behind these mountains."

Loudness not a problem

No serious modulation war exists in the Bay area airwaves, several engineers agreed.

"There is always a modulation battle with the youth-oriented formats,"

(continued on page 23)

The Stations we equip in Baltimore or Dallas, New York or Los Angeles all have something in common.



CHECK US OUT
Major market players love our major market products.
Henry ties it all together.

BROADCAST SERVICES CO.

Rt 3, Box 45E, Four Oaks, NC 27524
800/525-1037

GREAT NEWS.

Getting the story accurately is the top priority of every news person. Sony's professional portable DAT recorder gets the story digitally—no hiss, no noise. Just pure sound—to get more on the story call 1-800-635-SONY.



TCD-D10 PRO

- Light weight: 4 lb., 7 oz.
- Measures only 10" X 2½" X 7⅞"
- Continuous operation of 1.5 hours on one rechargeable battery
- Index during recording
- Day, date and time recorded and displayed
- Easy-to-read large back-lit LCD multi-function display
- Supplied with wired remote/handgrip control

SONY

Sony Communications Products Company
1600 Queen Anne Rd., Teaneck, NJ 07666
© 1989 Sony Corporation of America
Sony is a registered trademark of Sony

PROFESSIONAL AUDIO

Bay Broadcasters Under Fire

by Frank Beacham

San Francisco CA Bay area broadcasters have come under fire from the FCC, a Congressional delegation and the deaf community for their handling of emergency broadcast information during the 17 October earthquake.

A major snafu involving the Emergency Broadcast System (EBS) and the failure of Bay area television stations to use visual displays for hearing-impaired viewers has prompted anger and consternation from the broadcasters who say they are taking an unfair rap.

However, when the dust settles, California is expected to have the nation's first new digital enhanced EBS system that will help resolve many of the problems. And the FCC is preparing a public notice advising TV broadcasters of their responsibilities during emergencies, **Radio World** has learned.

KNBR Radio, common program control station #1 has the responsibility of activating the EBS system in San Francisco.

But the stations failed to follow procedures and activated the system without legitimate cause in the aftermath of the earthquake, said Jim Gabbert, State EBS Coordinator, president of the California Broadcasters Association and owner of KOFY-TV here.

"What happened was KNBR (station CE) went running off and activated the system because a fireman called him," said Gabbert. "A fireman from a fire station called KNBR. The message was:

'Off duty firemen report to work.'"

Gabbert said under the Bay area emergency plan filed with the FCC the Alameda County Office of Emergency Services (OES) is the clearing house that has authority to call for activation of the EBS system. In this case, he said, no legitimate OES order was given to activate the EBS system.

"The engineer did not follow the plan which was supposed to come out of the Alameda County OES and he went like a chicken with his head cut off and there

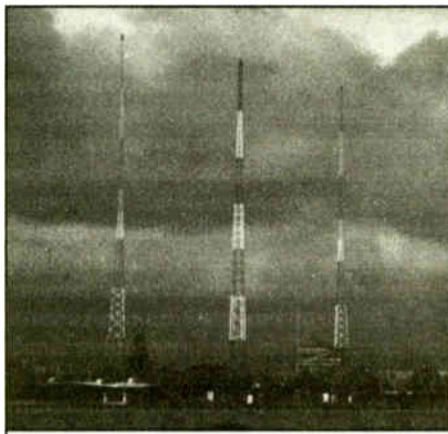

KDIA's triple AM antenna towers overlook the Oakland Bay Bridge and the bay. The top of the tower on the left is bent due to earthquake damage.

was no message," Gabbert said. KNBR Engineering Manager Bill Ruck refused to give his side of the story to **Radio World**.

Ruck said, "I will not talk with anybody who has talked with Jim Gabbert.

Jim Gabbert is full of misinformation, lies and innuendo." Though the EBS system was never officially activated after the earthquake, Gabbert said it would not have worked even if it had been.

Gabbert called the EBS system a relic from World War II days. He said the current system is full of holes ranging from the technical reliability of the control stations in a disaster to disc jockeys not hearing the audible messages over EBS receivers when alone on a station air shift.

As a result of the earthquake, Gabbert and the California Broadcasters Association have proposed an all-digital enhanced EBS system to alert California radio and television stations via a state-owned emergency microwave network.

The system would allow emergency authorities to trigger receivers in all stations simultaneously and send emergency data via hard copy to printers at radio stations and by printer and visual crawl to television stations.

The new digital system would use California's existing emergency microwave network and the initial phase would cost about \$100,000 to cover the San Francisco, Los Angeles and San Diego markets.

Each station would have to spend about \$500 to purchase a receiver and printer to acquire the data. The new system would not replace existing EBS receivers, which would function as usual.

In a related matter, FCC Chairman Alfred Sikes, responding to the California Congressional delegation, has accused Bay area TV broadcasters of failing to follow FCC rules because of their failure to use visual presentations to convey emergency information after the earthquake.

Stemming from a complaint by the California Association of the Deaf to Bay area Congressman Pete Stark, the delegation petitioned Sikes to take action to

MARKET UPDATE

insure that information be provided the hearing-impaired in future emergencies.

Sikes responded that he was "distressed to learn that some (CA) televi-

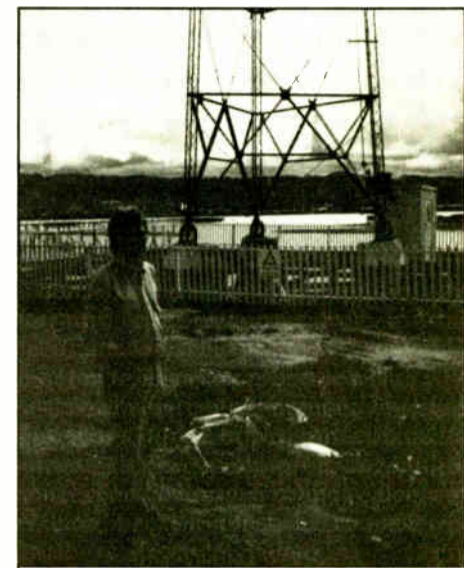

KABL engineer Dennis Gooch at the base of the AM tower on the San Francisco Bay.

sion stations did not comply with the Commission's rules." Sikes said he had directed Commission staff to promptly issue a public notice reminding all US television stations of requirement.

The response from California broadcasters was outrage. "This is politically motivated. The FCC chairman made a political decision because he got a letter from members of Congress," said Vic Biondi, executive director of the California Broadcasters Association, who maintained that the EBS rules are not clear.

But Bill Hassinger, Asst. Chief of the Mass Media Bureau of the FCC, said the San Francisco stations clearly violated the rule. "The stations must tell the deaf what is going on during an emergency," Hassinger said.

CRL SPOTLIGHT



**Audio Noise Problems?
...Your solution is a dynafex®
noise reduction system.**



Ever wished for a simple, yet effective way to remove audio noise? Our dynafex® system is a unique combination of downward expansion and dynamic audio filtering providing up to 30 dB of noise reduction. To use, set the threshold that you want dynafex® to start working at—then listen to how quiet things get. Plus, because dynafex® is a single ended system, it will remove noise from sources that companded systems cannot. Thought of some noisy applications?

We offer two models: Our DX-1 (mono) is for mic. or line level sources, and features extended threshold range. Our DX-2 (stereo/2 channel) is for line level applications. Find out how much noise dynafex® will make you miss. Call or write for more information. Our units are also available on a two week trial.

dynafex® is a registered trademark of CRL, Inc.



Circuit Research Labs, Inc.
2522 West Geneva Drive
Tempe, Arizona 85282-3192 U.S.A.
(800) 535-7648 (602) 438-0888 FAX (602) 438-8227
Bulletin Board System (602) 438-0459

Circle 138 On Reader Service Card

**Serving the broadcasting industry
for over 40 years!**

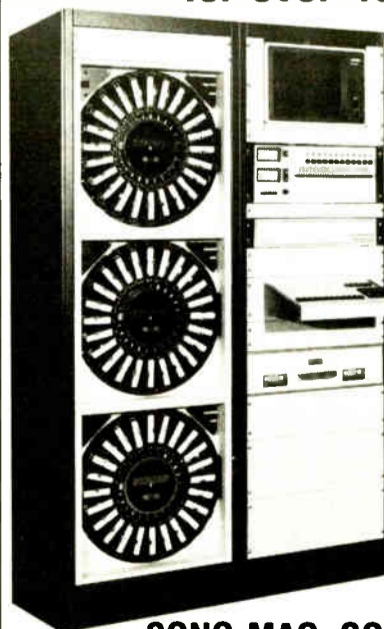

- Satellite Programming Systems
- Music Systems
- Live Assist Programming
- Cart Recorders/Players
- Carousels®
- SMC/Otari ARS-1000 Players
- Otari Production Recorders
- CD Live Assist Systems
- Audi-Cord Recorders/Players

SONO-MAG CORPORATION

1833 Hovey Ave., Normal, IL 61761-4394
Phone 309-452-5313 FAX 309-452-2521

Circle 89 On Reader Service Card

Golden Gate Radio

(continued from page 21)

Mostyn said, "but it's not nearly as severe as LA or New York. There are some people on the air with what some would call pretty trashed audio."

Gooch laughed at the question of a modulation war. "It's not as gruesome as other places. Some stations do screw around with it but it makes them sound horrible and they lose confidence and go back to the old ways. I don't hear a lot of super-processing here."

On the AM side, it's estimated that more than two-thirds of AM stations

with big band music.

Also showing strong ratings were KABL (AM/FM simulcast) with soft contemporary and KRQR-FM with classic rock. The city also strongly supports two classical stations and KSAN, now with a country format.

Difference of opinion

Even if business is good for San Francisco stations, not all agree that Bay area listeners are as well served as in the past.

Bonnie Simmons, former program director and disc jockey at the freewheeling progressive KSAN-FM from 1969 to 1978 and a protege of legendary Bay area disc jockey Tom Donahue, feels the narrowly targeted, research-driven formats of today have left a large disenfranchised radio audience in San Francisco. (See separate story.)

Dawn Tognoli, executive director of the Northern California Broadcasters Association,

disagrees with the notion that Bay areas stations have lost their pioneering heritage.

"There's still experimentation in this market," Tognoli said. "Personally I don't think music is as innovative right now as it was but we always hit little flat spots. Today's formats are very well defined and that's why they work so well."



Engineer Paul Pravettoni at the board on KRQR's morning show with "The Lobster."

now comply with the NRSC standards and five stations broadcast in AM stereo (four Motorola, one Kahn).

So who are the current winners in the Bay area market? Arbitron shows KMEL-FM at No. 2 with a strong youth-oriented urban format; KOIT-FM at No. 3 with soft contemporary; KCBS-AM at No. 4 with news/talk and KFRC-AM at No. 5

Wanted

Dead or Alive!



M30B
Transmitter

\$250 Reward



MR-30
Receiver

\$150 Reward

Marti is offering the highest trade in ever for these two desperadoes on RPT-30 transmitters and CR-10 receivers.

Now is your opportunity to upgrade your Marti before the fall sports season starts.

Call Marti for details.
(817) 645-9163

Offer good on trade for RPT-30 or CR-10, 1 for 1 trade on transmitters and receivers. Offer expires July 31, 1990

Circle 25 On Reader Service Card

NRSC Compliance...

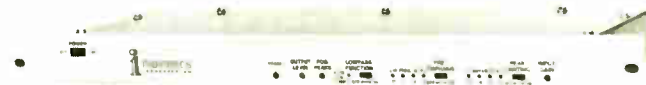

INOVONICS 222-00



CRL SPF 300



RADIO DESIGN LABS



Easy As...BSW

Complying with the June 30th FCC requirement for NRSC-1 doesn't have to be a nightmare. At least not with BSW. We can provide the information and equipment you need to comply easily, at a price to fit your budget. A few of the NRSC compliance options available through BSW include the Inovonics Model 222-00 NRSC audio processor that offers full compliance and defeatable peak limiting, the CRL SPF-300 AM pre-emphasis/filter, or a complete NRSC package from Radio Design Labs that includes filter, pre and de-emphasis and a guide to NRSC compliance. BSW will work with you to choose the proper product for your requirements and offer the best delivery and after-sale support in the industry. Call toll-free 1-800-426-8434.

BSW

BROADCAST SUPPLY WEST

America's Full-Time Broadcast Supplier

1-800-426-8434

ORDERS • INFORMATION • SPECIFICATIONS
BSW • 7012 27th Street W • Tacoma, WA 98466 • FAX 206-565-8114

Circle 2 On Reader Service Card

FCC, FAA Work to Find Solutions

by Lex Felker

Washington DC As many broadcasters have already found out through personal experience, it can be an extremely difficult and time-consuming matter to get a no-hazard determination out of the FAA these days.

The bulk of the difficulties is related to the aviation agency's desire to prevent electromagnetic interference (EMI) to aeronautical communications and navigation services.

FM applicants are most affected by the FAA's EMI scrutiny because of the adjacency of the FM broadcast band to the 108-136 MHz aeronautical allocation, but no radio service is immune. Even applicants for UHF TV and amateur radio stations have experienced difficulty in obtaining FAA clearance.

This month, we'll take a look at where things stand, what changes can be expected and what applicants can do to improve their chances of receiving FAA clearance.

Background

Although the problems have become apparent only recently, the FAA has actually been examining EMI effects of proposed broadcast facilities for several years. Initially, the process employed so-called "Venn diagrams"—charts indicating protection zones and station signal contours. Possible interference areas were indicated by overlaps between signal and protection regions.

FAA and FCC staff disagreed as to the validity of the assumptions used in developing these diagrams, but relatively few construction permits were denied solely because of FAA EMI concerns.

Frequently, the FCC would condition a CP grant upon no actual interference to aviation communication and navigation services.

A couple of years ago, the FAA began to use a computer model, developed under contract by Ohio University, to analyze the EMI potential of proposed radio facilities. Although the source code for the model was not immediately available, it became apparent that the model had some flaws in it, and scores of FM applications were bounced by the FAA.

The problem became so serious during my tenure as Mass Media Bureau Chief that my staff drafted a Notice of Proposed Rule Making to propose new aeronautical EMI standards to replace those employed in the FAA computer model.

The draft Notice was never sent to the Commission for consideration, however. Instead, at the suggestion of the Chairman, coordination between senior FAA and FCC staff members was begun.

Things are looking up

The interagency coordination was just beginning when Dennis Patrick and other senior FCC (and FAA) officials left their government posts. Under Chairman Al Sikes, the coordination effort has been stepped up, however.

Senior officials from both agencies

have met several times to present their respective concerns, and neither side is completely faultless. The FCC is concerned both with the lack of openness with which the FAA is developing its EMI standards and procedures and with many of the assumptions and algorithms employed in the FAA's computer model.

tematic method of accurately accounting for interference.

The FAA has apparently indicated a willingness to make reasonable modifications to its computer model—including, significantly, a more accurate propagation algorithm.

Hopefully, the FCC will take the initiative to supply the FAA with reliable facility data and other relevant information in a form that the FAA can use to quickly and accurately reach air hazard determinations.

The FCC is concerned with the lack of openness with which the FAA is developing its EMI standards and procedures . . .

The FAA, on the other hand, would seem to have a legitimate gripe that the Commission has neither consulted with it on numerous rule changes that introduce potential EMI concerns nor provided the data needed to more accurately predict the presence of interference.

In addition to these higher level meetings, mid-level staff members from both agencies are convening monthly in an effort to reach agreement on specific CP applications.

For the FCC, however, the development of this information could be resource-intensive. Unfortunately, considering the austere budget climate, the number of other attractive projects competing for scarce resources and the priority Commission management has placed (correctly, in my view) on processing applications quickly, the Commission may not be able to provide this information anytime soon.

Hence, it looks like the FAA problem is going to be with us for some time to come. In the meantime, there are some steps applicants that have been bounced by the FAA—and their consulting engineers—can take that may ameliorate their situation.

What applicants can do

Importantly, the computer model employed by the FAA is being made available to the engineering community through the AFCCE (Association of Federal Communications Consulting Engineers). Therefore, applicants who have been rejected by the FAA can use this software to "check" the FAA's work.

The first step is to get a copy of the "analysis" performed by the FAA. This document will list all of the stations used in predicting the EMI effects and it should be examined to ensure that all of the stations the FAA factored into the EMI analysis are actually on the air.

The analysis can also be refined to account for actual conditions (e.g., antenna patterns) which might make the difference in the air hazard determination. Engineering consultants should also be able to show rejected applicants a variety of other ways of refining the analysis to avoid an EMI problem.

Applicants who choose to object to the FAA's initial determination based on their own analysis must do so quickly, however. The FAA only keeps its files open for 30 days and any appeal or objection should be filed within this 30 day period.

All in all, the prospects seem good for the FAA and the FCC to eventually develop a procedure for analyzing the EMI potential of broadcast facilities that meets the aviation community's safety concerns and treats broadcasters fairly.

In the meantime, there are procedures broadcasters can use which, while time-consuming, can frequently result in FAA approval of a new or modified facility.

■ ■ ■

Lex Felker is a technical/engineering consultant with the law firm of Wiley, Rein & Fielding, Washington DC, and former FCC Mass Media Bureau Chief. He can be reached at 202-429-7000.

FELKER'S FORUM

The typical case considered in these meetings involves the use of inaccurate data by the FAA or a misunderstanding of the circumstances which may result from grant of a particular application. The latter case can arise in upgrade situations where changes for several different facilities are contingent upon one another.

Where are things headed?

One thing seems clear: Because of the potential for EMI, the FAA is going to continue to involve itself in the authorization of broadcast facilities (and those of other radio services).

As helpful as the monthly problem-solving meetings between FAA and FCC staff may be, this *ad hoc* procedure is no substitute for the establishment of a sys-

Oh-Oh!

Call
CORTANA

The Affordable Lightning Prevention System

- Charge dissipation with 1/8" type 304, sharpened stainless steel rods
- Won't bend from ice/severe weather
- Provide a continuous low-resistance discharge path for static electricity

Write for a Free Brochure.

P. O. Box 2548, Farmington, N. M. 87499
Call (505) 325-5336

Circle 81 On Reader Service Card

RF SPECIALTIES GROUP

LEADERS IN RF SYSTEMS FROM COAST TO COAST

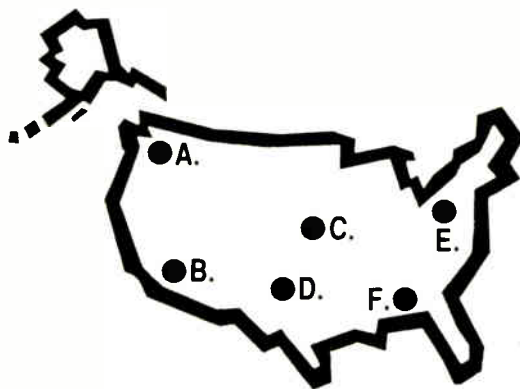

FOR ALL YOUR BROADCAST EQUIPMENT NEEDS, CALL THE SPECIALIST NEAR YOU

SYSTEM DESIGN
COMPETITIVE PRICING

RF Specialties Group

A. RF Specialties of Washington, Inc.
19237 Aurora Avenue N.
Seattle, WA 98133
Phone (206) 546-6546
FAX (206) 546-2633
John Schneider &
James Kaplan

B. RF Specialties of California
3463 State Street, Suite 229
Santa Barbara, CA 93105
Phone (805) 682-9429
FAX (805) 682-5170
Sam Lane

C. RF Specialties of Missouri
R.R. #2, Box 152H
Kearney, MO 64060
Phone (816) 635-5959
FAX (816) 635-4508
Chris Kreger

D. RF Specialties of Texas
P.O. Box 7630
Amarillo, TX 79114
Phone (806) 372-4518
FAX (806) 373-8036
Don Jones & Tim Hawks

E. RF Specialties of Pennsylvania, Inc.
121 Conneaut Drive
Pittsburgh, PA 15239
Phone (412) 733-1994
FAX (412) 327-9336
Tom Monahan

F. RF Specialties of Florida
P.O. Box 397
Niceville, FL 32578
Phone (904) 678-8943
FAX (904) 729-2744
Bill Turney

Each Office is Independently Owned and Operated

Circle 111 On Reader Service Card

Radio's Top Ten!

Many of our customers understand that this is more than a hollow boast. They know that when a manufacturer offers them a broad choice of products, it means money in their pockets.

How? Simple. You can select *exactly* the right equipment for your specific application.

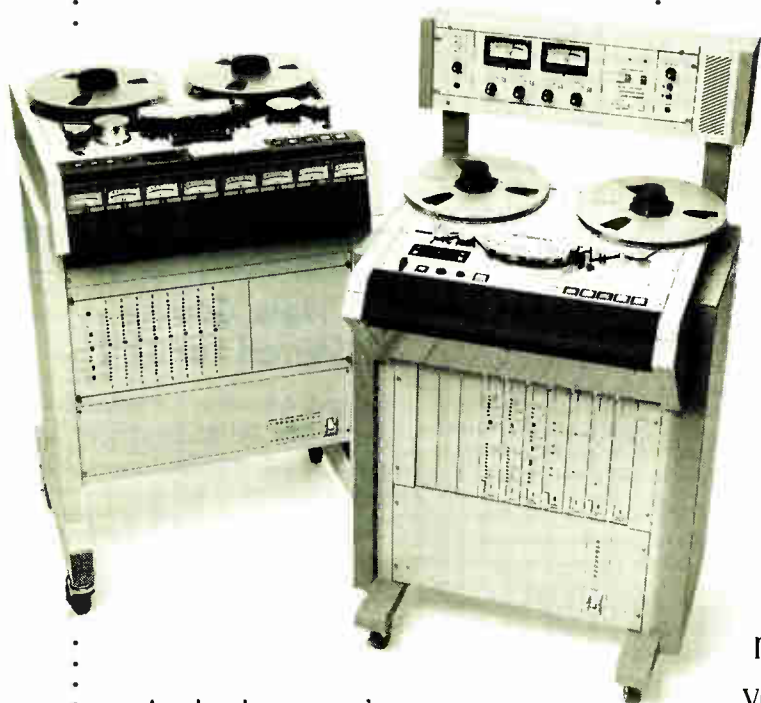

And when you're not forced to make compromises in features or performance, your station not only sounds better to your listeners, it is also much more efficient in its day-to-day operation.

Otari has machines for news editing, on-air, and production with features to fit any application or budget.

To make a point, let's say you are in the market for a multitrack.

You can choose from our top of the line MTR-10 that gives you all the features you'll ever need, or our BQ11, MKIII/4, MKIII/8, or the MX-70 with 8 or 16 tracks.

Need a 2-track?

How about our famous "workhorse" MX5050 BII, or the MKIII/2, or the MX-55NM with gapless, seamless, punch-in, punch-out and HX-Pro*.

And don't forget the MX-50, perhaps the most affordable professional 2-track on the market.

We also offer three models of our CTM-10 cart machine. And if yours is an automated radio station,



our ARS-1000 reproducer is the most popular machine in the world.

You could say we have a *broad cast* for broadcast. But as we've pointed out, it can mean a lot more to you than just a phrase.

Call your nearest Otari dealer today, or call Otari at (415) 341-5900 for more information.

OTARI



* HX-Pro is a trademark of Dolby Laboratories Licensing Corporation

Digital Interfacing for Control

This is the eleventh in a 12-part series called An Introduction to Digital Electronics. Northern Virginia Community College will offer 1.3 CEUs (continuing education units) to registered students who successfully complete the course and an examination mailed at its conclusion.

Successful completion of the course and the final exam will also earn 1.3 professional credits toward recertification under the maintenance of certification provisions of the SBE Certification Program. To register, contact the Director of Continuing Education, Annandale Campus, 8333 Little River Turnpike, Annandale, VA 22003, or call 703-323-3159. The fee for the course is \$20.

by Ed Montgomery

Part XI of XII

Annandale VA Most digital devices do not carry enough power to control or operate electrical or mechanical equipment. Digital circuitry must be interfaced in a manner that will permit the devices to control much larger currents and voltages.

The purpose of interfacing is to control a very large amount of power with a very small amount. This can be done electrically, mechanically using hydraulics or with a combination of electric and mechanical systems.

Some examples of interfacing equipment would be traffic signal timing

devices controlling miles of streets, electromechanical systems controlling the movement of light rail cars or aircraft controls. Transmitter remote controls also employ these systems.

In order to view these systems from an introductory level, consider the control of a motor or a switch using a digital microprocessor. The microprocessor could be sensing minute changes in light or temperature and, at a certain level, turn on a relay.

The small changes in current produced in the microprocessor would not be enough to energize a relay, however. Some basic transistor theory must be employed to make this system practical.

Transistorized solution

The microprocessor may not be able to energize a relay, but it can produce enough current to forward-bias a transistor. The transistor has the ability to conduct the current to activate the relay. Figure 1 is an illustration of what this circuit might look like.

The sensing voltage is generated in the microprocessor and established across R_1 . This will produce the current necessary to bias Q_1 , causing it to conduct. A high amount of current will then flow through the relay coil causing the contacts to close. The relay contacts can handle an even higher amount of current and voltage.

The purpose of D_1 is to protect Q_1 . When the sensor in the microprocessor sends Q_1 into cut-off, the magnetic field around the relay coil collapses. A "back-emf" or self-induced reverse voltage is created that could send a pulse of current through Q_1 , destroying its junction.

D_1 is placed in such a manner that it will become forward-biased with the pulse of reverse energy only shunting it within the relay protecting the transistor.

Numerous circuits are available. One place to start looking at interfacing is Radio Shack, which has published a family of handbooks describing how to design your own projects.

On the road and in the air

Today's automobile uses a microprocessor to monitor numerous constantly changing functions. The au-

appropriate changes to improve combustion, timing, cruise control or warn you of doors not closed or seat belts not connected. They can also be used to prevent brakes from locking in emergency applications.

Microprocessors are used in flight management in today's aircraft. A microprocessor controls several subsystems that actually fly the plane.

On planes outfitted in such a way, a passenger would be unable to detect whether a pilot or the computer was flying the aircraft. An airplane with a flight management computer allows the pilot to act in the capacity of a flight manager overseeing the data the computer is displaying. The system is presently in service on Boeing 757s and 767s.

■ ■ ■

Ed Montgomery currently is an electronics teacher at Thomas A. Edison High School in Fairfax County. He has taught broadcast engineering at Northern Virginia Community College and worked as broadcast engineer for several radio stations.

Figure 1.

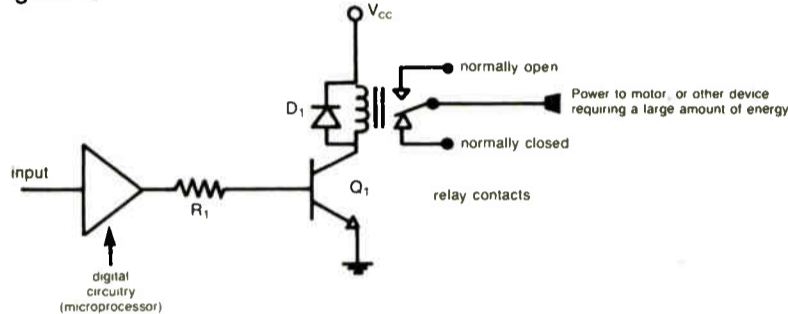

tomobile microprocessor contains a ROM or Read Only Memory. The ROM is programmed with data gathered by the manufacturer describing how the engine and related electrical system is to operate.

In the future these ROMs may be replaced with EEROMs (Electrically Erasable Read Only Memories). This will allow the microprocessor to be updated rather than replaced when the manufacturer wishes to change an operating parameter.

The ROM is interfaced with several sensors throughout the car that measure fuel mixture timing, temperature, etc. The microprocessor senses this data several times a second, compares it with the data stored in the ROM and makes

New Course Slated for Fall

Starting with the 12 September issue of RW Ed Montgomery will begin a new 12-part course on Amplifiers.

The course will cover various classes of amplifiers, designs and related terminology and will cover RF and audio.

As with past courses, students may register for credit at North Virginia Community College or for SBE accreditation. Watch future issues of RW for details.

WHO SAYS YOU CAN'T TAKE IT WITH YOU?

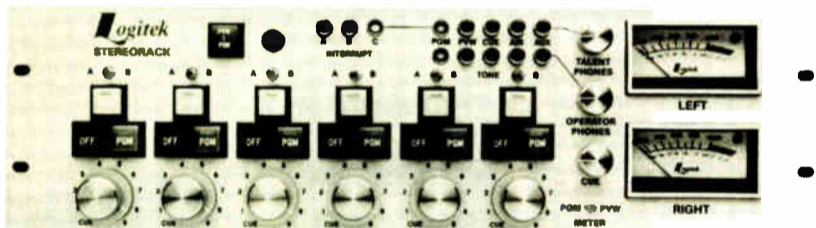

The Logitek Stereorack

Taking studio sound out of the studio used to be difficult. Not any longer! All you need is the Logitek Stereorack.

Our Stereorack console is a complete stereo studio console in a 19" rack-mountable package. And when we say complete, we mean complete!

The Stereorack has 6 balanced stereo input channels selectable from 11 stereo sources or a built-in tone generator.

Each input channel can feed either or both fully metered stereo output channels and their built-in 1 x 4 stereo distribution amps.

Any of the input sources can be pre-routed through 1 of 7 built-in mic preamps for maximum flexibility.

Separate headphone feeds are provided for the operator and for 3 talent positions. And the built-in talent cueing system will make history of complicated outboard IFB setups.

When it comes to audio performance, the Stereorack takes a back seat to nobody. And, if your audio needs are monaural, we offer these same great features in our mono version -- the Auditorack.



When it has to work right!

Call 800-231-5870 for your nearest Logitek Dealer. (Alaska, Hawaii, Canada : 713-782-4592)

Bring 'em back alive with MARTI

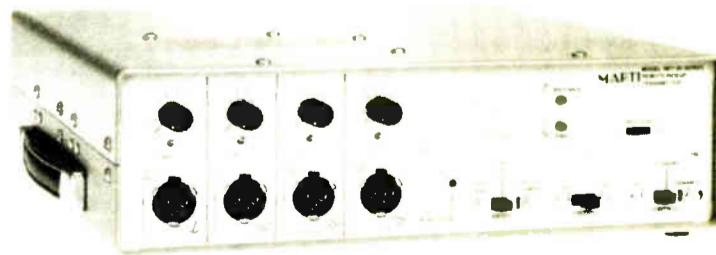

We've been bringing back live remotes for over 30 years.

Go with the undisputed leader!

MARTI

The performance-value leader in Broadcast Equipment. Marti Electronics, Inc., P.O. Box 661, Cleburne, Texas 76033-0661 (817) 645-9163 TELEX 8794835 "Marti CLBN" FAX (817) 641-3869

Effects Boxes Add Spice to Spots

by Bruce Bartlett

Elkhart IN Want more pizzazz in your station's IDs and spots? Try the new special effects boxes, such as the Eventide Harmonizer®, Marshall Electronic Time Modulator, or Quantec Realtime Signal Processor. You won't believe what these devices can do to the human voice.

Chances are you've already heard one of these on the radio: The announcer sounds like Darth Vader.

Basically, these devices sample a sound—record it digitally—into memory chips. Once recorded, this digital data can be manipulated to provide a wide variety of sonic effects.

Pitch change and time compression

A recorded voice can be played back at a different pitch without changing its duration. You can lower the announcer's voice to sound like a monster, giving your station an image of power. Raise the pitch, and you've got a Martian.

LINE OUT

How does this effect work? In the Marshall Electronic Time Modulator, the incoming signal is recorded into memory and read back out after a short delay. If this delay is varied, the pitch shifts at the instant the delay changes, then returns to normal.

The Time Modulator creates a constant pitch change by varying the delay in repetitive sweeps every 20 milliseconds. This results in a Doppler shift that varies the pitch.

Some devices generate three different pitches simultaneously. These can be layered or mixed together, so that you hear three pitches at once. Turn your announcer into a three-voiced mutant.

Or, you can change the duration without changing the pitch—a function called "time compression." If you need a 30 second spot, but your production times out at 32 seconds, simply enter those two times into the device. You'll hear the same spot fit into a 30 second slot (without any pitch change). A 57 second PSA can be stretched to 60 seconds, and so on.

Pre-recorded and other effects

Some devices, such as the Eventide H3000B Ultra-Harmonizer for broadcast post production, have pre-recorded sound effects available at the touch of a button. Need a helicopter for a traffic report? Or a siren or doorbell? They're in there, plus many others.

Most units have echo and reverberation. Echo is a discrete repetition of a sound (hello . . . hello . . . hello), while reverberation is a continuous decay of sound (HELLOO-Oo-o . . .).

Reverberation is the sound you hear just after you clap your hands in an empty gym or cathedral. Physically, reverberation is a series of diminishing echoes, too closely spaced in time to be resolved by the ear, randomly timed.

By using the various reverb programs in the effects device, you can put an announcer in any sort of space: a bathroom, concert hall or canyon.

Some stations put reverb on the DJ all

Some devices generate three different pitches simultaneously . . . Turn your announcer into a three-voiced mutant.

the time. The extended decay time that results increases the average modulation level. Of course, whether or not you use this effect is an artistic decision; your listeners may tire of it.

Gated reverb is reverberation that cuts off suddenly after a short time. You hear it on many Top 40 records on the snare drum (that "Phil Collins" drum sound is a good example).

Another effect is stereo panning. Sound images swim around, left to right and back again. The phased, spacious sounds produced by variable interchannel delays and phase shifts are impossible to describe.

Flanging, vibrato, stutter

Flanging or combing is unusual, too. A signal is combined with its delayed repetition, with the delay varied or swept between 0 and 20 milliseconds. This causes a series of phase cancellations—notches in the frequency spectrum—that shift up and down in fre-

(continued on page 29)

it
ITC tape cartridge machines

DENON
Denon CD cartridge machines

TFT INC
TFT modulation monitors

STUDER EDITECH
Digital audio production systems

modulation sciences, inc.
modminders

These companies have just selected Audio.



AUDIO
broadcast group inc.

They like our expertise. They like our 30 year reputation for excellent service. They like the way we do business.
So will you. For prices, availabilities, catalogs or more information:

Call us today!
1-800-999-9281

Audio Broadcast Group, Inc.
2342 S. Division Avenue,
Grand Rapids, MI 49507-3087
Phone (616) 452-1596

Convening Radio's Roundtable

by Dee McVicker

Washington DC Call it Watergate all over again, but recently UPI Radio Network has been tapping into the backroom conversations of three political heavyweights. And it's not parlor room chit-chat either. We're talking laundered money, congressional scandals and even White House jibes.

The backroom banter of heavyweight political journalists Jack Anderson, Helen Thomas and Pye Chamberlayne would leave even Watergate's "Deep Throat" speechless. But, thanks to the devices of broadcasting, it is just the kind of insightful conversation that makes UPI Radio Network's new show what it is—straight from the wire.

The new show, called *UPI Roundtable*, is perhaps the strongest editorial to come across the wires of UPI. The setting, however, is hardly a ponderous round oak table where three legendary journalists sit elbow-to-elbow to exchange their views on the week's hot political issues.

Instead, they table their viewpoints on a 5 kHz broadcast loop that runs from a UPI studio to three remote locations—including the White House.

Helen Thomas, as long-time UPI White House bureau chief correspondent, presides over an elaborate studio situated in the First Family's residence. From this full-function studio, with all the broadcast trimmings necessary to keep pace with political news, Thomas

and, across the Potomac, UPI's senior political correspondent Pye Chamberlayne gets his political digs in from his home in Alexandria, VA.

Chamberlayne set up shop in his home after a broken leg made it all but impossible for him to report to UPI every day. The phone company personnel, commented UPI Radio Network's Chief Engineer Sam Brown, were more than a little stymied with Chamberlayne's home studio setup. "(They) found it awfully amusing to be installing a broadcast loop in the basement (of a home)," remarked Brown.



Syndicated columnist Jack Anderson has a studio in his office.

joins her counterparts in a half hour of enlightening conversation.

Meanwhile, across town, syndicated newspaper columnist Jack Anderson joins the conversation from his office stu-

OFFBEAT RADIO

Of the hundred or so communication lines coming and going through UPI Radio Network, the most noted is the talkback loop that joins the three in their half-hour show.

The Wash Talkback line, as Brown refers to it, makes the circuit from the White House to the US House and Senate and is directly tied to both Thomas' White House studio and Anderson's office studio.

Normally, Chamberlayne feeds his correspondence to UPI through a talkback line appropriately referred to as the Pye Talkback line. But for *Roundtable*, Chamberlayne taps into the Wash Talkback line through a telephone coupler from his home studio.

Although the three cross wires every week in *UPI Roundtable*, rarely do they cross paths. The trio's most recent elbow-to-elbow discussion was over lunch when they discussed the details of launching the program, which began airing in September.

What followed were some of the most intriguing conversations to take place over the airwaves. Even renowned jour-

nalist Helen Thomas, who has spent more years reporting the news than commenting on it, has been known to speak freely of presidents and White House blunders. In fact, she often has reservations about the nation's policymakers and has no problem saying so.

That Thomas holds no great affinity for some of the officials she has covered as a reporter was news to Jack Anderson, who has known Thomas most of his career.

"She (Helen) has been brought up all her life—all her news career—not to inject herself into the story. Now she does it, and she does it almost as if you've shut the doors and nobody's listening," said Anderson.

On the other hand, Anderson, as an outspoken Pulitzer Prize winner with a lot on his mind, rarely has had to restrain himself from expression—political



Helen Thomas offers insights from a studio booth in the White House.

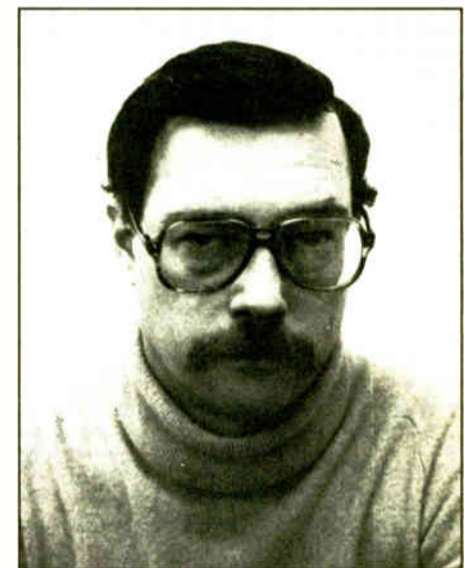

Pye Chamberlayne hosts UPI's Roundtable from his basement.

or otherwise. Known for his candor and wit, Anderson is self-described as "always popping off" with his opinions. This, he said, comes more naturally for him than his two counterparts.

The master of ceremonies, as Anderson calls show host Pye Chamberlayne, adds another flavor to the broadcast. Chamberlayne, who has covered just about every political beat since the mid-'60s, has been revealing a talent recently for being a bit on the off-beat side.

"Pye has a habit of bringing up some absolutely off-the-wall, bizarre subject and asking Helen and Jack for their opinion," commented Producer Ken Robinson. These side-news vignettes usually trail a fervent discussion of one world news event or another, and they usually come off as tongue-in-cheek.

For instance, on the heels of an ardent

(continued on page 36)

It's Not Just A Phase We're Going Through.

The tremendous success of the Tannoy PBM series of reference monitors is by no means coincidental. Since the introduction of the world renowned NFM-8 nearfield monitor, much time and effort has been spent on discerning the needs of the mixing engineer and the applied requirements of "playback monitors". The PBM Line exemplifies this commitment to excellence in reference studio monitoring. These compact loudspeakers sport robust poly cone mid-bass transducers utilizing efficient long-throw, high power voice coils. The low frequencies are carefully controlled by optimally tuned ports located on the rear of the loudspeakers. Hi frequencies are provided by Hi Power ferro fluid cooled polyamide dome tweeters which extend H.F. bandwidth beyond 20KHZ. The driver accompaniment is knitted

together by means of a precision hardwired crossover unit, utilizing robust low loss components, and heavy-duty input terminals which will accept standard 3/4" spaced banana plugs and the majority of high quality, specialist audio cables. Transducers and crossover assemblies are neatly housed in a stylish, high density, particle wrap cabinet, specially designed to minimize unwanted cabinet resonance, and high frequency reflection. In summarizing, we have left the best feature of all for last "price versus performance."

TANNOY
Professional Products



TEC AWARD WINNER

TANNOY

Tannoy North America, Inc. 300 Gage Ave., Unit 1, Kitchener, Ont., Canada, N2M 2C8
Telephone (519) 745-1158 Telex 069-55328 Fax (519) 745-2384

Circle 14 On Reader Service Card

DATAWORLD MAPS

DO YOU KNOW YOUR MARKET? YOUR COMPETITION DOES!

DATAWORLD MAPS CAN

- Depict your coverage!
- Market orient your sales people!
- Target your ethnic/demographic markets!
- Identify marginal signal areas!
- Plot any special requirements!

MAP OPTIONS

- SHADOWING (TERRAIN SHIELDING)
- POPULATION DENSITY
- CONTOUR COVERAGE
- SPECIALS

dataworld
A Service of DW, Inc.

Fax (301) 656-5341
(301) 652-8822 (800) 368-5754

Circle 143 On Reader Service Card

Put Pizzazz in Your Spots With Special Effects Units

(continued from page 27)

quency. The result is a swishing, filtered sound, like a jet plane passing overhead.

Vibrato is a wavering in pitch, or frequency modulation, of the input signal. Filtering is available in highpass, lowpass or bandpass—say, for a CB radio effect.

When a unit is programmed to act as a vocoder, it accepts signals from a musical instrument as well as a speaking voice. What comes out is a talking guitar, singing organ or whatever. That is, the speech modulates the tone produced by the musical instrument.

Another popular effect is stuttering, in which a sample p-p-p-plays repeatedly. (Sampling was discussed in detail in previous columns).

The enhancer effect "highpass-filters" the signal and adds even-order harmonic distortion. The distorted signal is mixed at a low level with the clean signal. This creates a brighter, more treble sound by the addition of harmonics.

Several of these effects can be combined. You might add panning to flanging and reverb. You can either call up and combine these effects yourself or use the preset combinations stored in the effects device.

Controlling the effects

Most units include an LCD window that displays information such as the program name and parameter presets. It also displays the specific function that a "soft key" will perform. A soft key is a button whose function depends on what part of the program you're in.

You can enter control data either by a continuous knob or with a data-entry keypad. For example, you might work on the parameters of a reverberation program. Change the reverb decay time, the delay before reverb starts, the wet/dry ratio, and so on. ("Wet" means the reverberated signal; "dry" means the original non-reverberated signal.)

Some units can be controlled by MIDI, which lets you remote-control the device or automate its operation with a sequencer computer program.

One device has been specially designed to work with a personal computer: the Quantec QRS/XL. This programmable digital signal processor comes with a wide range of top-quality effects, such as room simulation and digital filtering. It can operate as a standalone unit or can be controlled by your personal computer.

If you want to manipulate the

When a unit is programmed to act as a vocoder, it accepts signals from a musical instrument as well as a speaking voice.



The
STL/TSL
for the
90s is
here now.
And not a
moment
too soon.

- Two Way Multi-Channel Communications
- Transparent Digital Audio
- Multiple Signal Path Options

XL parameters or design new effects programs, you'll need a PC running software such as Marshall Electronic's XLC Controller. You can define your own effects programs on your computer screen, then store them in RAM or on disk.

One program shipped with the XL-A library might be especially useful for broadcasters. Called "Air," it makes an audio program sound louder and punchier with no level increase on a VU meter.

Quantec has set up a network by which users can communicate via modem. They can ac-

cess recent software and updates, get technical assistance or exchange programs.

As we've seen, there are loads of special effects available to intrigue your listeners. You can choose either the convenience and speed of factory presets or the flexibility of parameter control. Whatever your choice, special effects can help your station stand out sonically.

■ ■ ■
Bruce Bartlett is a microphone project engineer and technical writer with Crown International. He can be reached at 219-294-8000.

It's time for a new kind of STL. Drastic cost increases are just one sign that the phone company is tired of balanced equalized lines and is ready to pull the Class A plug. Meanwhile, microwave spectrum is scarce—in some areas, channels are unavailable.

QEI's new CAT\Link Composite Audio Transmission Link is the *digital* STL alternative. It transmits composite and other signals over a single telco T1 data line*. T1 service costs less than Class A, and it's so reliable that the big banks use it for their vital financial data.

CAT\Link encodes the fully processed *composite* signal and decodes it at your transmitter, so you can run the stereo generator and processing at the studio. At the same time, CAT\Link configurations can send and receive SCAs, control channels, voice communications, RS232 data, AM audio, transmitter readings, and satellite or remote programs.

With CAT\Link, you always get full stereo separation: There are none of the phase or amplitude fluctuations that plague dual-channel STLs. Dynamic range is up to 84 dB, and your processed composite signal can use virtually all of it. So the only thing you'll hear is clear, clean, undistorted audio.

Worried about replacing Class A lines, getting a microwave channel, or sight-line infringement? Call QEI toll-free at 800-334-9154 for full info on CAT\Link, the bidirectional, digital, *easy-wired* STL. And turn the weak link in your signal chain into one of the strongest.

* CAT\Link will also drive over a mile of twisted pair wire, nearly two miles of fiber optic cable, or a 23 GHz STL.

Quality • Engineering • Innovation
P.O. Box D • One Airport Drive
Williamstown, New Jersey 08094
24 Hr. Service Hotline 609-728-2020 • Fax 609-629-1751



Circle 43 On Reader Service Card

NEW NEW NEW

SERIES CONSOLES

S – \$6,499 /18 CHANNELS – \$8,893

FEATURES

- Totally Modular Console-Input modules, Output modules, Option modules
 - Ease of Service
 - Ease of Installation
 - Ease of Expansion
- Three Mainframe Sizes-8 channels, 18 channels, 28 channels
 - Full Metering
 - Timer on All models
 - Talkback to "2" studios
- Ultrahigh Quality Construction and design
 - Penny and Giles 3000 Series slide faders
 - VCA's
 - ITT Schadow switches
 - Gold connectors-IC's socketed-regulated power supply
- 3 Stereo Output Buses
- 2 Internal Mix-minus Buses for 'Telephone'
- Option Modules-D.A.'s, Mono Mixes, Remote Selectors, Etc.
- Comprehensive Logic system
 - Start and stop sources by isolated internal reed relays
 - Remote channel On and Off control with Tally lamps for turrets
 - Flashing OFF switches for cart machine status
 - Three muting buses for Control room and two studios
 - Timer reset selectable on each module
 - Monitor DIM function during cue and talkback



224-2248



arrakis
SYSTEMS, INC.

**NEW
NEW
NEW
NEW
NEW**

NEW NEW NEW

DIGITAL AUDIO HARD DISK RECORDING HAS BECOME...



CHILD'S PLAY.

Finally, a hard disk digital audio recorder that's simple, fast, and affordable. No computer monitor, keyboard or mouse, just an easy to use two-track digital recorder providing up to 60 minutes of CD quality stereo audio. The DR-2™ automatically chases or generates SMPTE timecode depending on the application. Control the DR-2 directly from your editor,

or stand alone with the optional remote which features familiar tape recorder controls. Access sound instantly with the touch of a button. Non-destructive digital editing features allow you to throw away the razor blades and work faster with greater creativity. Install the DR-2, and make digital your domain, today.

AlphaAudio 
Automation Systems

 **HARRIS
ALLIED**
BROADCAST EQUIPMENT
800-622-0022

West Coast Pioneers And a Radio Veteran

by George Riggins

Long Beach CA Recent comments about early stations and on-air dates brought a response from WPAX of Thomasville, GA. Len Robinson, General Manager, called to pass along some rather interesting information about the early days of WPAX. The phone call was followed with copies of the original station license.



The license was dated 24 December, 1922 and was for a period of 3 months, to expire on 24 March, 1923. The provisions of the license stated: "Limited to Commercial, Class 'A,' broadcasting entertainment and like matter. One commercial second class operator or higher required. This station is licensed for the specific service shown, on the wave lengths indicated, no other service permitted."

"The hours of operation specified below may be changed or a division of time may be required, whenever in the opinion of the Secretary of Commerce, such action is necessary."

West Coast pioneers

Ed Janney (who retired from KOY, Phoenix, AZ shortly after Jack William went from being the station GM to being the governor of Arizona) sent three vintage magazines. Two are from the late fall of 1925 and the other one is the first issue of the RCA "Broadcast News."

On the west coast, one of the early entries to the radio broadcast industry was the McClatchy publishing empire. The McClatchy group of papers included the *Sacramento Bee*, the *Fresno Bee*, the *Bakersfield Bee* and a Reno newspaper.

The first notation of a station owned by the McClatchy interests was in 1926 when the company was listed as the owner of KMJ, Fresno. KMJ was put on the air by San Joaquin Valley Light and Power Co. in 1923 or earlier. With no listings in my library of the intervening years, an exact date of transfer of KMJ from the power company to McClatchy ownership cannot be stated.

By 1929, there were two stations listed as being associated with McClatchy owned newspapers: KMJ, Fresno and KFBK, Sacramento. KMJ's listed frequency was 1200 kc with 100 W; KFBK was listed at 1310 kc, also with 100 W.

By 1931 the group had increased to three stations with the addition of KOH, The Bee, Reno, NV. KOH had an assigned frequency of 1380 kc with power set at 500 watts. KMJ and KFBK were at the same frequency and power as listed for 1929.

Changes in frequency, power

Between 1931 and 1936, both frequency changes and power changes took place. KMJ moved from 1210 to 580 and increased power from 100 watts to 500 watts. KFBK went from 100 watts to 500

watts and moved to 1490 kc. There were no changes at KOH, Reno.

Two stations were added between 1926 and 1937: KWG, Stockton, and KERO, Bakersfield. The Stockton station was one of the earliest pioneers of the area, having gone on the air 7 December, 1921 under the ownership of Portable Wireless Telephone Co., 823.8 kc, 50 watts.

The 1941 *Broadcasting Yearbook* credits the McClatchy interest with owning a total of five stations in California and Nevada. The CA stations were: KMJ, KWG, KERN and KFBK. The Nevada station was KOH, Reno. The major changes that took place between 1938 and 1941 were the changes in frequency dictated by the Havana Treaty.

KERN changed from 1380 to 1410, KFBK moved from 1490 to 1530 and KWG went from 1200 to 1230. Power at all of the stations remained the same until after WW II. The only change that took place between 1941 and 1946 was the upping of power at KWG to 500 watts.

More words from Smith

When we left off with Al Smith last month, he had made comments about getting hooked on radio after seeing his first receiver, an Atwater Kent with three knobs for tuning. He also described the power supply, a 6 V storage battery and the two B batteries for the plates.

OT: Which stations could you hear in your part of Nebraska?

Al: In those days there were many low powered broadcast stations with powers of 100 W or less. I remember hearing KDKA in Pittsburgh, PA; KFKX in Hastings, NE; WHG in Kansas City and WOAW in Omaha. These were higher powered stations. Also we heard WSB in Atlanta and a high powered station in Havana, Cuba. I lived near Fairbury, in south-central Nebraska.

OT: When did you get into radio?

Al: While in high school in Fairbury, NE I met a radio ham. I used to eat my lunch and visit with him at the ham station of an older brother. In 1930 I started an NRI (National Radio Institute) course while working in a drug store. I also started servicing radio sets—nearly all battery operated.

In 1933 I obtained my amateur conditional radio license with the call W9PEX; it later became W0PEX, my present call. I started studying in earnest to obtain a First Class Radiotelephone License, which I obtained in 1934. I thought that

(continued on page 35)

CANCOMM
Supplier of Broadcast Products

The FM Booster Specialist



Call Eric Lane
(408) 354-4468

Circle 19 On Reader Service Card

59 YEARS AGO

Studio Walled By Glass Wool

For the past four months workmen have been busy redesigning, reconstructing and redecorating the studios of KHJ, in the Don Lee Building, Los Angeles.

This work is now completed. The entire second floor, comprising 20,000 square feet, has been given over to the studios and executive offices of the station. Three separate sound-proof studios have been constructed, consisting of one large studio capable of accommodating a 200-piece symphony orchestra, and two smaller studios. Each of these rooms has been sound-proofed to an efficiency of better than ninety-five percent. Each has its own monitoring room and separate broadcasting equipment control units.

These three studios serve to materially increase the broadcasting flexibility of KHJ. It is now possible for the station to broadcast a program locally, release a program to the Don Lee Coast network and conduct a rehearsal simultaneously.

Because of the thick partitions, filled with glass wool, it is impossible for any sound to escape from any of the studios. The walls have all been acoustically treated.

Reprinted from *Radio World* July 18, 1931. Editor's note: The *RW* of old, printed for a time in the 1920s and 1930s and today's *RW* are unrelated except in name.

Canada Court Rules On Air

Washington

The Supreme Court of Canada has held that control of radio broadcasting is a duty of the Dominion Government rather than of the individual provincial legislatures, according to advice received by the Department of Commerce from Acting Commercial Attache, Oliver B. North, at Ottawa.

The decision, which was rendered by a 3-to-2 vote of the court, is not final, since either side may appeal to the Privy Council.

The decision was rendered after lengthy hearings on the contending argument for provincial or Dominion control of radio broadcasting. The case started in connection with the refusal to grant a broadcasting license to a station which was to put on the air a program sponsored by the Quebec provincial government.

The court's decision is in line with the legal conception of broadcasting in the United States, i.e., interstate commerce. Comment was made on the closeness of the vote, paralleling the 3-to-2 vote in the recent decision by the Federal Radio Commission in the Clause 9 case.

CCA

Evolution.

CCA has delivered more than 3,000 Broadcast Transmitters over the past 25 years. For 25 years our designs have been refined and improved. The result is the Evolution of the world's most perfected, most tested, most reliable, Radio Transmitter.

- * Grounded Grid Triode
- * Longest Tube Life
- * Auto Power Control
- * VSWR Power Foldback
- * Single Phase Optional

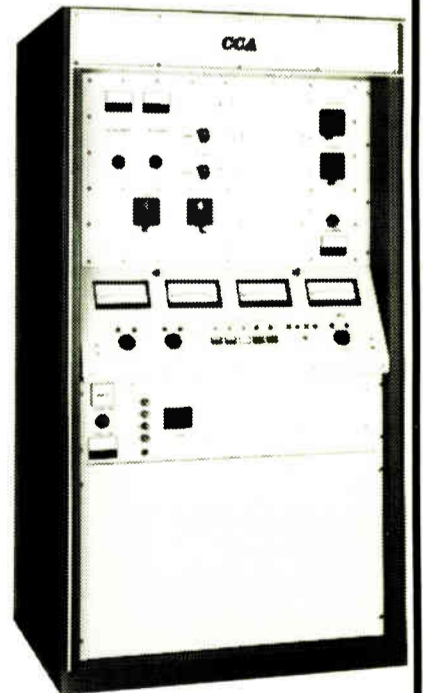

CCA Electronics, Inc.

P.O. Box 426

Fairburn, GA 30213

(404)964-3530 FAX (404)964-2222

Circle 120 On Reader Service Card

Unmodulated Measurements

by Harold Hallikainen

San Luis Obispo CA I recently received a call from a station that had just gone through an FCC inspection. The remote antenna ammeter had been calibrated so it read the unmodulated

If the meter is affected by modulation (although to what degree is not specified), the meter must be read without modulation. Trying to get a pause in modulation past the programming department can be difficult (many don't even want to run the legally required ID!).

So, the trick is to get an antenna (or common point) sample that is not affected by modulation.

Measuring antenna current

Until recently, the most common way of measuring antenna current was to use a thermocouple ammeter. In constructing a station ten or fifteen years ago, I found that the "brand new" thermocouple ammeters agreed at 60 Hz, but when

curately over a wide frequency range.

Since thermocouple ammeters are based on the amount of heat generated by the current to be measured, it is a true measure of the "heating value" of the current or the RMS value.

INSIGHT ON RULES

If we 100% modulate a 1 kW transmitter with a sine wave, it'll (ideally) take 500 W of audio. We still have the 1 kW of DC (100% efficient RF amplifier here). So, we have 1500 W going in, and we indeed have 1500 W coming out.

Of that, 1 kW is in the carrier and 250 W in each sideband. An RMS ammeter (such as a thermocouple) will accurately indicate this 50% increase in power by reading about 23% higher than it does without modulation.

The RMS current (square root of the mean of the squares of the currents at all times) increases with modulation, but the average current (actually, the absolute value of the average, since the average of a symmetrical AC waveform is 0) remains the same.

If we look at how a plate modulated transmitter works (whether it is transformer coupled audio or PDM), we end up with an AC waveform (the audio) in series with a DC plate voltage. The DC component of the voltage applied to the final amplifier remains unchanged with modulation. As such, the DC component of a rectified antenna current should also be unaffected by modulation.

Carrier amplitude regulation

Ideally, the carrier amplitude (the RF signal less the sidebands) remains constant under modulation. Our total amplitude varies with modulation, but that is due to the sum of the carrier and the sidebands.

We can recover the carrier amplitude by rectifying the RF. We end up with a DC voltage representing the carrier amplitude and an AC voltage representing the modulation.

If we run this signal through a low pass filter, we can remove the AC component, leaving a DC voltage that is proportional to the carrier level, which is the same with or without modulation. Using such a "diode meter" should give us an indication of unmodulated antenna current even when modulation is present.

However, things are seldom ideal. Most transmitters have "carrier amplitude shift" (less than perfect carrier amplitude regulation). Standard plate modulated transmitters share the same high voltage power supply for the modulators (typically class B) and the RF amplifier.

As more audio is required, the load on the power supply is increased (as is typical of class B amplifiers), decreasing the power supply voltage and decreasing the carrier level.

Other factors can also contribute to carrier shift. As the final RF amplifier tubes age, the RF output amplitude may not be directly proportional to the applied voltage, causing a "soft clip" of the positive peak of the RF.

Lack of symmetry and broadbanding of the RF load on the transmitter may also contribute to carrier shift. Recent measurements (made at 1 AM this morning!) showed that with modulation, the indicated common point current (using a diode meter) decreased 3.3% and the plate voltage decreased 1.5%.

So, it appears that plate voltage regulation contributes to carrier shift, but is not the sole contributor. This 3.3% decrease in indicated common point current would require us to read common point current without modulation to comply with the remote ammeter accuracy requirements.

Section 73.40(a)(5) (deleted in 1986) required transmitters to have less than 5% carrier shift when modulated 100% with a 400 Hz tone. This allowed 5% shift would still require us to read antenna current without modulation, since it is more than the allowed 2%.

A commonly used RF ammeter is the Delta TCA (torroidal current ammeter) series. This diode ammeter is ideally unaffected by AC amplitude modulation. However, it does accurately reflect variations in carrier amplitude, causing it to be unstable in most stations.

From measurements, I determined the
(continued on next page)

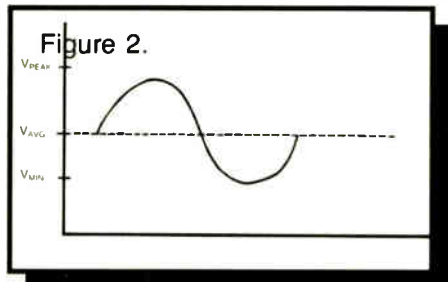
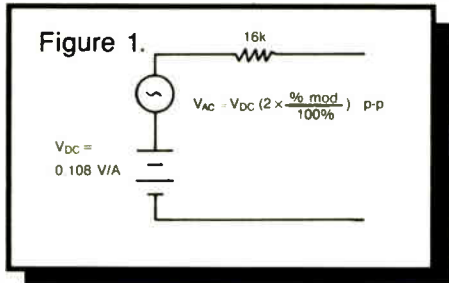

antenna current when the station was modulated (which is its normal condition).

However, when the transmitter was not modulated, the remote antenna ammeter read high. The FCC check of remote ammeter calibration was done without modulation, causing the remote meter to be outside the 2% tolerance allowed by 73.57(d)(2).

Rule 73.1820(a) requires that all parameters whose indications are affected by modulation must be read without modulation (for logging in the station log). The FCC inspector said that calibrating the remote ammeter "up" to compensate for the downward indication due to modulation was not acceptable.

run at 1 MHz, they read substantially high, causing us to get an indicated transmitter efficiency of slightly over 100%.

As such, I don't trust thermocouple ammeters, which should indicate ac-

FM Harmonic Low Pass Filters

500 - 50,000 Watts

Delivery: 30 Days (Faster For Your Emergencies)



Model #	Watts
6612	6,000
6516	15,000
7772	30,000
7455	50,000

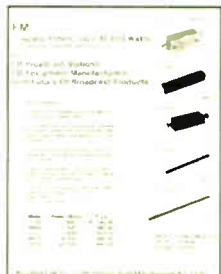

Full Details In Bulletin #14!

Also, request BTV/87 which describes TV/FM/MMDS Broadcast Filters & Combiners for service radio bands.



Bulletin #14

Catalog BTV/87

Need A Special Filter? Call Us Today!

"We make Filters In A Hurry For Customers In Trouble!"

Microwave Filter Company, Inc.

6743 Kinne St. • E. Syracuse, NY 13057

Toll Free(US/Can.): 1-800-448-1666 • Collect(NY/AK/HI): 315-437-3953
FAX: 315-463-1467 • Telex: 249-613

Live! . . . in concert!

ALL the Time

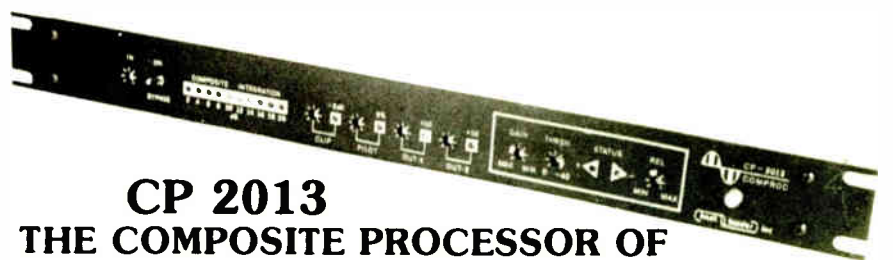

CP 2013

THE COMPOSITE PROCESSOR OF THE FUTURE HERE TODAY

- ★ Low second harmonic clipper — flat to 420KHz!
- ★ Separation exceeding 60 dB
- ★ Ultra smooth, fast acting AGC, builds stereo image without the grunge!
- ★ 1½ dB louder than any other composite clipper
- ★ Multiple outputs plus remote control

AVOID THE RUSH — CALL NOW

hnat hinders inc

42 Elaine Street • R.R. 1 • Thompson, Connecticut 06277 • (203) 935-9066 • (203) 935-9242

Meter Measurement Minus Modulation

(continued from previous page)

Thevenin equivalent of the sample output of a Delta TCA20EXR to be as shown in Figure 1. Into an open circuit, it will provide 0.108 volts DC for each ampere of RF current (V_{DC}). In addition, it provides an AC voltage that is proportional to the DC voltage and the amount of modulation. Finally, based on measurements with the output loaded, it appears to have a 16k source impedance.

Carrier shift compensation

A common approach to trying to get rid of the "meter bouncing" is to put a big capacitor across it. Unfortunately, this doesn't get rid of the bounce, it just slows it down. The "big capacitor" and the internal resistance of the TVA form a low pass filter ($F_h = 1/(2\pi R \times C)$).

This removes the AC component of the TCA output, but the DC component still changes with modulation level, since the actual carrier amplitude is changing. What is needed is a way to boost the meter reading during modulation and drop it back down during lack of modulation.

Figure 2 shows the output voltage waveform of the TCA with modulation. If we run this through a low pass filter, we get V_{AVG} (the average DC voltage).

If, instead, we were to run this through a series diode followed by a shunt capacitor, the capacitor would charge to the peak voltage, which varies in the same direction as modulation.

Figure 3 shows a combination of a low pass filter and a peak detector. During periods of no modulation, no current flows through R_1 , leaving R_2 , D_1 and D_2 out of the circuit.

With modulation, if the wiper of R_2 is towards D_1 , the output voltage will increase (the capacitor charge path has a lower resistance than the discharge path, tending to increase the capacitor voltage towards V_{PEAK}).

If the wiper of R_2 is towards D_2 , the output voltage will decrease with modulation.

The trick is to adjust R_2 towards D_1 such that the increase in output due to modulation just cancels the decrease in output due to carrier shift.

In my testing, I found (using a DVM) that the output of the TCA would drop from 0.950 volts (no modulation) to a voltage varying between 0.936 and 0.942 with typical program modulation. This was about a 1.2% decrease in indication due to modulation.

With the circuit of Figure 3, I again measured the no modulation sample (0.950), allowing several minutes for it to stabilize. With modulation, I was able to get 0.844 to 0.998 volts, depending upon the adjustment of R_2 . Then, with normal programming, R_2 was adjusted to yield the 0.950 volts that was present with no modulation.

Over a wide variety of programming (talk and music), the output varied about 0.1%. In my testing, I ended up with 8.1k to D_1 and 83.2k to D_2 .

Final notes

Note that we're using germanium diodes for D_1 and D_2 . I tried silicon, but the "knee" voltage drop was too much, making R_2 have a minimal effect.

Also note that these measurements were all made with the output "unloaded" (driving an 10 M input resistance DVM). As the load resistance is decreased, I'd expect the output voltage to drop and for R_2 to have less control.

You may want to follow this circuit with an op-amp voltage follower if you're driving a low resistance remote control input (less than 1 M).

Thanks to the caller who inspired me to work on this. I've known about the AC component of the TCA output for years, and the carrier shift problems, but never followed up on it. I'll look forward to your comments.

■■■

Harold Hallikainen is president of Hallikainen & Friends, a broadcast equipment design, manufacture, sales and installation firm. He can be reached at 805-541-0200.

Figure 3.

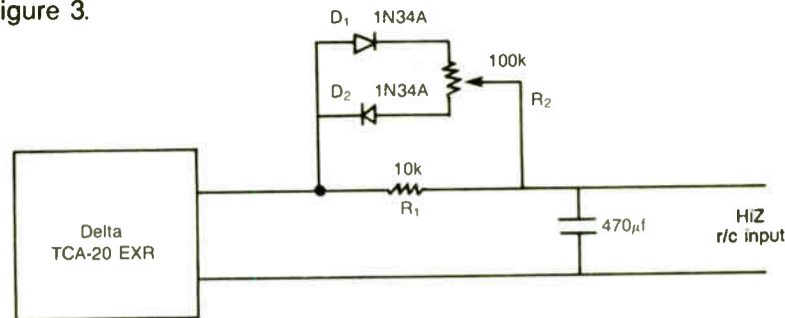

Radio's Early Days

(continued from page 33)

I was on top of the world and was going to go out and make big money as a radio operator.

OT: How easy was it to get into radio at that time?

AI: The Depression was on. I finally got work after sending out applications to about every radio station in the Midwest, saying I would fill in for vacations, illness, whenever they needed someone for a few days, a week, a month, whatever the case may have been.

After a year or so, I put on my application that I had experience on nearly every type of broadcast equipment.

OT: Where was your first job?

AI: One of my first jobs was at the Omaha Police Department. That didn't last long once some radio people found that I was not an Omaha citizen. I worked at Dodge City, KS, Kearney, NE and finally back to Omaha for KICK in Carter Lake for several months until they (KICK) were purchased by WOC in Davenport, so WOC could get the KICK frequency assignment.

OT: Why did WOC want KICK?

AI: WOC and KICK were operating on the same frequency with the same program—not a success due to the fact that they could not synchronize frequencies closely enough. I remember delivering the frequency monitor to Davenport for WOC. KICK was composite—homemade equipment, except for the frequency monitor. That is all WOC wanted. I got \$50 for delivering (the monitor). I

had hoped to obtain a job at WOC. I did not get the job, but another operator from KICK did.

OT: What did you do between broadcasting jobs?

AI: During these times of temporary employment, I serviced radios back home. Some people would wait for me to return. They thought that if I could work at broadcast stations, I should be a good serviceman.

OT: What kind of service did these early receiving sets require?

AI: My main service work was converting battery radios to low drain tubes so that a large storage battery was no longer required, eliminating the problem of battery charging.

OT: What type of programs were being broadcast?

AI: This was the time of the big network shows which continued until the advent of network TV: Jack Benny, Amos and Andy, Fred Allen, George Burns & Gracie Allen. We had daytime soap operas such as *Oxydol's Own Ma Perkins*.

We will continue with Al Smith next issue, as well as highlighting another newspaper/radio station common ownership from the formative years.

■■■

George Riggins has experience in radio and electronics dating back to the 1930s. He is also a licensed ham operator and has had his own broadcast sales and service company, Riggins Electronic Sales, for over 20 years. He can be reached at 213-598-7007.



Grab the Comrex and run...

Would you believe—a live talk show, broadcast from the back seat of an on-duty police cruiser... from a nude bar... or from the scene of a street crime? These are just some of the ways WNWS Talk

"Spontaneity is the best marketing tool you can use!"

Lorri Sheffield, PD, WNWS Miami
A Jefferson Pilot Station

Radio PD Lorri Sheffield puts her listeners directly in the middle of issues they care about.

At a moment's notice, WNWS puts its talk show talent where the action is. How? With cellphones and Comrex frequency extenders. The cellphone gives them immediate connection between the studio and the story—and the Comrex turns the telephone sound into broadcast quality.

"While other stations may do a quick 60 second bit at station breaks, we put a whole crew of producers and news people on the scene and cover it live during our talk show," says Sheffield. "There's strong emotional appeal. And we get right to the core!"

There's no need to depend on expensive dedicated phone lines or overcrowded RF links. The WNWS team can just grab the gear and go—doing the creative en route. And transmit great sounding audio from virtually anywhere.

Call today to hear what Comrex can do for your programming.



COMREX

Specialists in Remote Broadcast Audio Transmission

Comrex Corporation
65 Nonset Path, Acton, MA 01720
1-800-237-1776 / (508) 263-1800 / Fax: (508) 635-0401

Spring Cleaning at the Station

by Barry Mishkind

Tucson AZ Once again, it's time to take our annual look around the station to examine the condition of the plant. Yes, spring has sprung over most of the nation (what do you mean, there's still white stuff on the ground where you are?), and that's the traditional time to see how your facility has weathered the winter.

Of course, it's not just weather damage we are looking to find. Taking full advantage of the situation, many engineers decide to do a complete check-out, seeking things that need attention and devising new projects to improve operations.

You might even decide to call it your traditional spring cleaning project. This kind of project can take many forms, depending on how much time and/or assistance you may have.

Some use a checklist that the station engineering department prepares to do a complete and thorough inspection of every piece of equipment.

Another checklist might be of points of compliance with all FCC Rules. It might cover everything from EPMs to checking DJ permits.

At the same time, why not collect suggestions from the staff on what new items they would like installed or changed in equipment location. On the other hand, you may just want to walk around, electronically "kicking the tires," so to speak.

Start at the end

Perhaps the best place to start is at the transmitter site. When was the last time you opened up and cleaned out that old beauty standing out there by the tower?

If it was just a quick peek to change tubes during an emergency, you owe a mercy visit to clean out the dust, cobwebs and critters.

Of course, in your area, maybe rust is more a problem than dust. While you're in there, check the wiring in and out of the transmitter and rack for any signs of needed maintenance.

At any rate, grab the vacuum, the oil can and a rag. A little oil in the right places, a quick tune-up and a tightening here or there all make for a happy transmitter. And a happy transmitter stays on the air and makes you happy too!

Even if your transmitter readings are logged regularly, make a special effort to read *all* the meters of *both* transmitters as you tweak the tuning.

ECLECTIC ENGINEER

Don't forget a quick check to ensure the STL and TSL signal strengths have not deteriorated. That can save a lot of trouble later.

The building itself may be in need of attention. You might want to check the roof periodically, to ensure that wind, for example, has not shifted material, or caused cracks around the air vents from the transmitter.

(The last thing you'd want is to open the back of the transmitter and find that water and dust have been getting into it. Even worse is finding this out immediately after the transmitter has failed!)

The air conditioning system also deserves attention. Not just the filters, but the whole unit. Any good AC system

keeps its cool even as temperatures climb.

This helps prevent transmitter failure and also extends the lives of those expensive tubes hiding behind the PA cavity door. Let's go out now, and get some fresh air.

Outside are those highly important piles of steel, without which you wouldn't have much coverage at all. So, it's important to regularly check the an-

tenna and tower for weather damage.

Not only can the elements bend or twist antennas (especially STL and TSL antennas), the guy wires deserve attention too, perhaps even a tensioning.

Checking the tower

Look around and ask: What of rust or other deterioration of the guy anchors, tower base insulators, etc.? Are the ball gaps in good condition?

It's even a good idea to check for weep-holes on the tower that may have become blocked and thus allow water to sit

(continued on page 40)

Roundtable Roundup

(continued from page 28)

discussion regarding Lithuania, Pye piped up with: "Helen, there seems to be a huge setback for the American Secretary of Agriculture this week: broccoli."

Chamberlayne, of course, was referring to the tonnage of broccoli sent to President Bush recently after he announced his disdain for the vegetable.

Most of the half-hour show, though, deals with breaking news stories and the stories behind those stories. Discussions are unscripted, free-wheeling and very impromptu.

"What happens," said Anderson, "is two minutes before we go on, Pye tells us what the subject matter should be." When the mics open, caution is thrown to the wind as the trio assert their opinions, sometimes from opposing sides of the fence.

Sounding off over the wire

With all three mics live, each routed to a different pot on UPI's studio console, these hotbed discussions can keep Robinson quite busy.

At the board, Robinson or a stand-in producer rides gain on all three and occasionally interrupts the feed for a public service announcement. Commented one stand-in, "Your hands are definitely busy while you're running the board for that show!"

Seldom are all three in agreement on any one subject. One hotbed subject, at least for Anderson and Thomas, is the Middle East. "Helen tends to be more pro-Arab than I think I am. I'm more pro-Israel than she is; (we've) had some clashes," said Anderson.

Occasionally, whoever is sounding off gets a heavy dose of cross-fire from the other two. Recalled Anderson of one incident that still has him hopping mad, "Pye actually sounded as if the crack-down (in China's Beijing) contributed to the stability and policy of George Bush!"

This also raised the ire of Thomas, who, according to Anderson, "really (put) him in his place that time, and I certainly joined in."

Since the show is taped, however, the final word always rests with the producer. Sometimes, said Robinson, he has to step in with a heavy hand—usually holding a tape splicer.

Marshalling the trio from an actual elbow-to-elbow roundtable, he maintained, would definitely be a challenge and another story entirely.

But then again, maybe bringing in three such diverse opinions on three distinct audio sends is one way to keep the peace for listeners.

Dee McVicker is a free-lance writer and regular contributor to RW. To inquire about her writing service, call 602-899-8916.

An airplane crashes. And you have the exclusive. Instantly.

Has this type of plane had problems before? Who manufactured the engine? What are the pilot's qualifications? What's the airport manager's phone number?

These answers can be found quickly and accurately with the *Aviation Compendium*™. This comprehensive collection of the latest official FAA and Transport Canada information is designed to work on your IBM, compatible or Macintosh® personal computer. Now you can have immediate access to over 25 million facts on the people, planes, places and problems of civil aviation. *Aviation Compendium* is available as a single copy or by subscription, and is updated monthly.

For more information, call 1 800 FOR-INFO. Or write, Flightline Electronic Publishing, Inc., 506 Kettlehouse Pond, Wayne, PA 19087.

25 million facts at your fingertips.



Aviation
Compendium

Circle 85 On Reader Service Card



BELAR
STEREO MONITOR

You
can measure...
with the best monitor and the most accurate test set.

The FMM-2/FMS-2 series monitors provide an even greater degree of precision measurement than ever before... **You can measure** S/N below 90 dB, **You can measure** crosstalk below 85 dB, **You can measure** separations of better than 70 dB, **You can measure** frequency response to better than 0.25 dB, **You can measure** distortions to lower than 0.01%, and much more... Our uncluttered panels and autoranging voltmeters make these measurements a dream.



BELAR CALL ARNO MEYER (215) 687-5550
ELECTRONICS LABORATORY, INC.
LANCASTER AVENUE AT DORSET, DEVON, PENNSYLVANIA 19333

Call or write for more information on Belar AM, FM, Stereo, SCA and TV monitors.

Circle 9 On Reader Service Card

How to Stop Singing Circuits

by John Shepler

Rockford IL Ringing is a natural feature of musical instruments. It's the resonance that gives instruments their voice. It is also a byproduct of the inherent resonance of many electronic circuits.

What is ringing?

Ringing is the natural waveform of a sharply excited resonant circuit. Hit a bell with a hammer and it rings. Hit a tank circuit with an impulse and it rings, too. As far as nature is concerned, they are the same phenomenon.

Figure 1 shows what happens when a tuned circuit is hit by a sharp waveform.

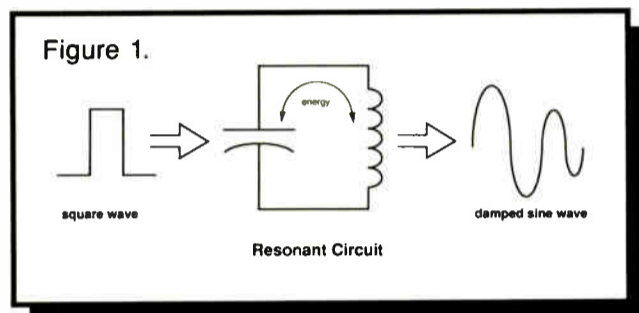

The energy is exchanged back and forth by the reactive elements, with a little being lost in circuit resistance on each cycle.

Eventually it is all gone. Hook a scope across the coil or capacitor, apply a pulse, and you see a dampened sine wave. This is exactly what you expect from big tank circuits, like those found in transmitters.

In fact, transmitters won't work without their resonant circuits. These tuned circuits are also essential in receivers, filters and music synthesizers.

Unfortunately, most other circuits exhibit this resonant behavior, whether you want them to or not. It's just a matter of how much and at what frequency.

In high performance audio circuits, especially those related to modulation, ringing is not that easy to control or dispense with.

Ringing and modulation

So what's all the excitement about ringing in audio circuits? If modulation was only measured with meters, nobody would care. However, modulation is measured with peak flashers and ringing causes peaks.

Look at Figure 2. The ideal signal is the square wave that goes into your audio board and comes out of the modulation monitor looking exactly the same.

What really comes out of the monitor is the other waveform, the messy one. Something has been added to the top of the square wave.

If you look closely, it is that same dampened waveform that was shown in Figure 1. Somewhere along the line, a sharp audio waveform excited a resonant circuit and added ringing to the pure square wave.

The big concern is that the leading edge of the square wave has grown in amplitude. The ringing waveform is added to the top of the square. This is

called overshoot.

If the gain of your modulator was adjusted so the top of the square was 100% modulation, you would now have more than 100%. The peak light would be blinking.

Q-TIPS

To turn off the light you have to turn down the modulation so the top of the peak is back to 100%. The difference between the top of the square wave and the top of the ringing peak is lost modulation.

Actually, the ringing has other ugly effects, too. The overshoot is accompanied by an undershoot that takes away even more of your "brick wall" modulation.

Moreover, the change in the ideal waveform shape means new frequency components have been added to the signal. These new frequencies add distortion to the signal.

Where to find ringing circuits

Where to find ringing circuits

Just about any circuit will ring under some adverse condition. Here are some culprits that have been found to cause

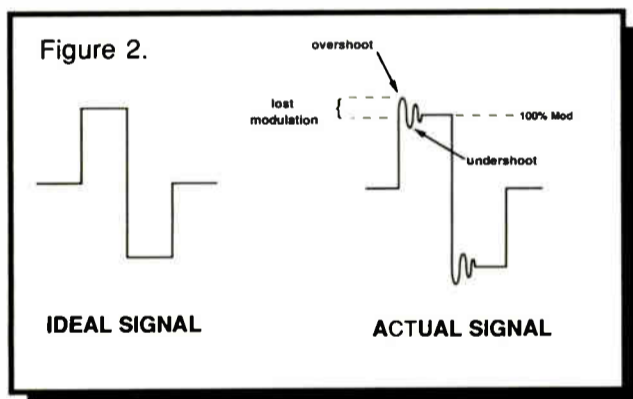

ringing problems resulting in over-modulation:

Input transformers. Transformers are likely candidates because of their high inductance from many turns of small diameter wire.

Add some stray capacitance and you have a resonant circuit. Yes, audio input transformers can be built to minimize ringing effects. Are you sure the ones on your transmitter are that variety?

Even if most of your equipment has balanced solid state drivers, one transformer in the line is enough to ruin a beautiful waveform.

LC filters. The classic example is the 15 kHz low pass filters that were common in stereo generators a dozen years ago. These have been largely replaced by solid state components in new designs.

If you have an older stereo generator, suspect the low pass filters of lowering your modulation.

Long wires. A long audio line is like a reservoir. It stores energy in its distributed inductance and capacitance. Telephone lines are even worse, because the phone company adds loading coils to smooth out the response.

Waveforms don't come out the other end of long lines completely intact. That's why final limiting needs to be done at the transmitter.

STLs. OK, so no wire in your plant is over 10' and an STL relays the signal from studio to transmitter. Any filters or transformers on the input or output of the STL (transmitter or receiver) can still ring.

Electronic filters. Just because it's made of opamps doesn't mean it won't ring. There is a popular circuit called a gyrator that is used in equalizers. It has resistors, caps and opamps, but acts like a coil. Looks can be deceiving.

Unstable circuits. An amplifier on the ragged edge of stability can pop in and out of oscillation when struck by sharp waveforms.

Maybe you have a bad component or a marginal design. If it's in the exciter or transmitter you've got trouble.

Modulation components. They don't call those old AM behemoths "big iron" for nothing. The modulation transformers and chokes love to sing on their own.

Many processors now give you compensating circuits to tune out some of these effects. Otherwise, make sure your audio waveforms are filtered to reduce the sharp edges before they get to the transmitter.

To find ringers, inject a square wave

at various points in your system and monitor with a scope. Make sure you are looking at those critical leading edges where the overshoot occurs.

You want your entire system to pass the high energy waveforms, but the most important areas to check are related to the transmitter site.

What to do about ringers

You may have to replace older equipment with newer designs. Perhaps a new final limiter is all you need to maintain a solid modulation level.

A composite clipper at the output of the stereo generator will chop off ringing from previous circuits. Despite their bad rep from abuse, a clipper may be all you need.

Newer modulation monitors—like the ModMinder from Modulation Sciences, which passes short duration transients—may allow you to raise modulation levels and ignore ringing circuits. It's worth a try.

Don't forget that even good equipment can go bad and start ringing. A little probing with the scope could save thousands in new purchases. Happy hunting!

■ ■ ■

John Shepler is an engineering manager, broadcast consultant, writer and regular RW columnist. He can be reached at 815-654-0145.

The affordable GENTNER

VRC-2000

lets you be
in control
anywhere,
anytime.

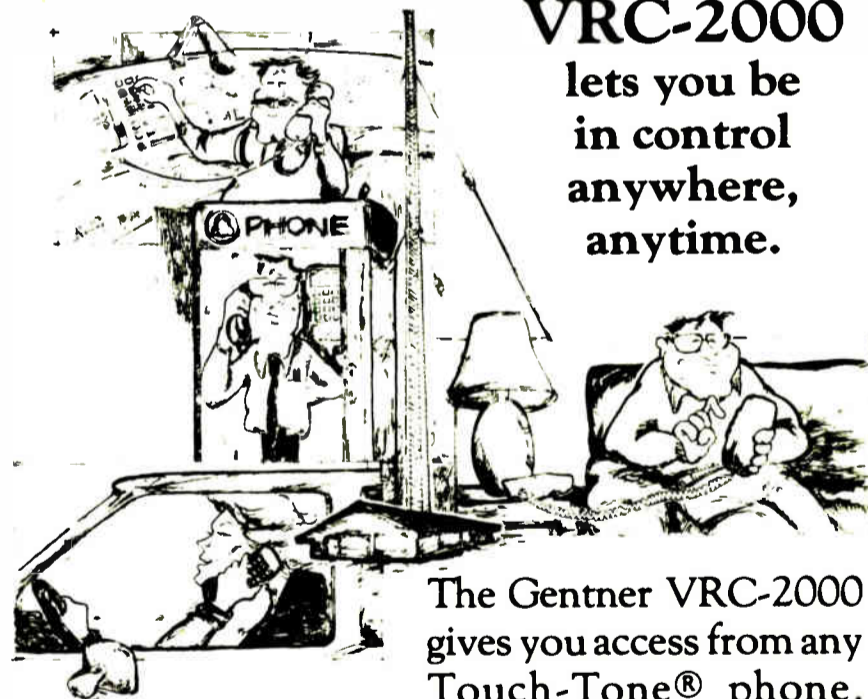

The Gentner VRC-2000
gives you access from any
Touch-Tone® phone.

Automatic, alarm reporting is also featured. It's
like having someone at the transmitter 24 hours a
day. Call Northeast for all the details!

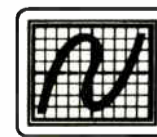

NORTHEAST BROADCAST LAB, INC.

Serving The Broadcast Industry Since 1961

Main Office P.O. Box 1179 S. Glens Falls, NY 12803 Tel: 518-793-2181 Fax: 518-793-7423	Mid-Atlantic P.O. Box 565 Southampton, PA 18966 Tel: 215-322-2227 Fax: 215-953-0523	New England P.O. Box 406 Auburn, NH 03032 Tel: 603-483-1002 Fax: 603-483-2352	Southwest P.O. Box 867717 Plano, TX 75086 Tel: 214-612-2053 Fax: 214-612-2145
---	--	--	--

Circle 55 On Reader Service Card

**GET IT
RIGHT**
GET IT FROM **ALLIED**

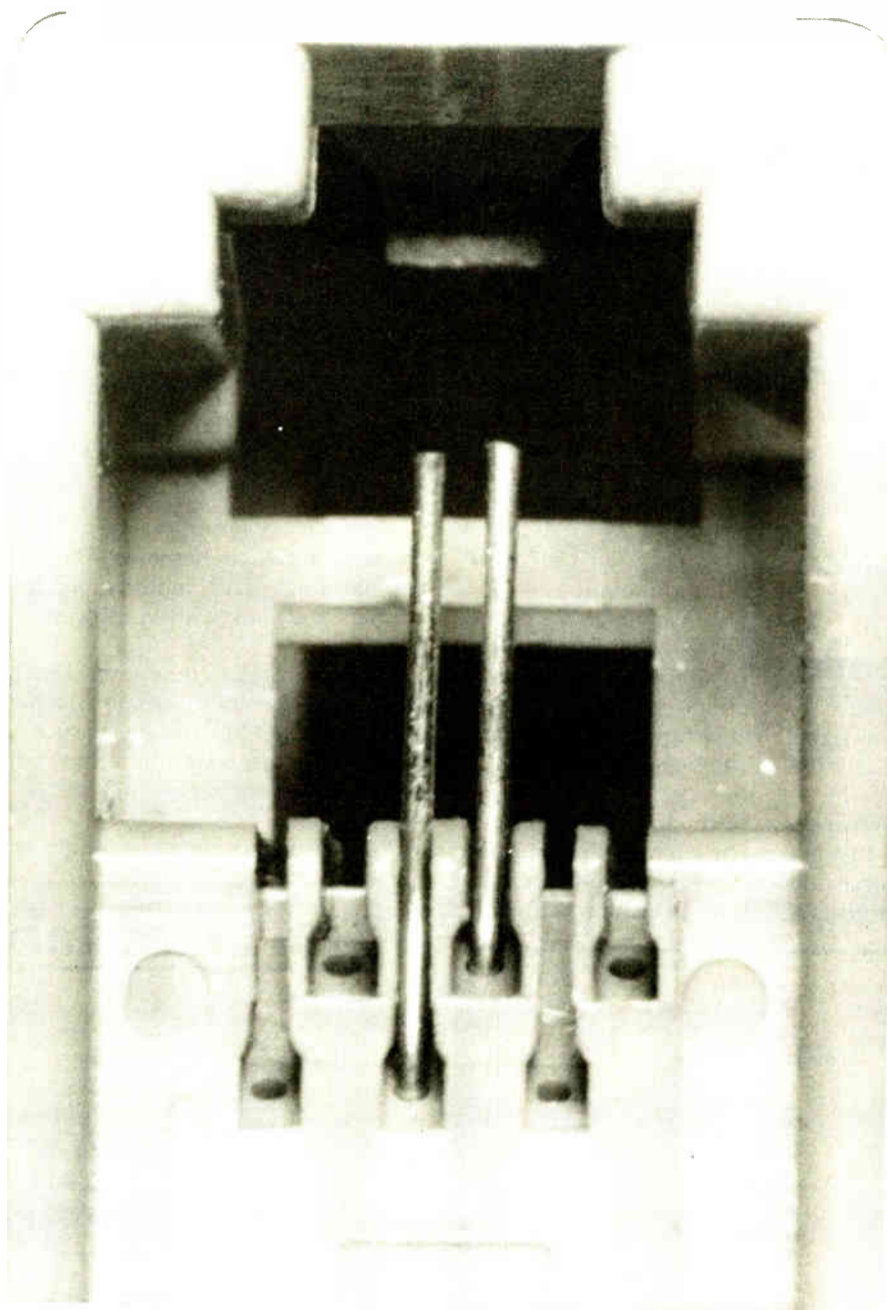

**Now
the
right
phone
system**

**goes
right
where
you
need it.**

No matter where you need access to your on-air phone system, Gentner's new Telemix 2000 delivers. Custom control panels to match most consoles and studio furniture are available at no extra cost. Now the phone fits any place you need it.

Telemix 2000's advanced design lets you do more with your phones, and do it all more easily. Hands-free, one-button operation lets talent record calls on-air or off-air, talk to callers on or off the air, conference calls together—all without taking off the headphones or leaving the mic.

With all this, the best thing about Telemix 2000 may be the way it sounds. Gentner's technology delivers the cleanest, clearest telephone sound ever.

If you broadcast talk shows, news, sports, remotes and call-ins, Harris Allied has the right phone system for you—Gentner's Telemix 2000. And to help you get the right Telemix 2000 for your station, we've put together an informative white paper, "Getting the most out of your phone system with today's technology." Call your Harris Allied representative today for your copy.



**HARRIS
ALLIED**
BROADCAST EQUIPMENT

800-622-0022

CANADA 800-268-6817

STUDIO EQUIPMENT • HARRIS RF PRODUCTS • SATELLITE GEAR • TRADE-INS • TURNKEY SYSTEMS

© 1990 HARRIS/ALLIED

"Literature Only" Circle 141

World Radio History

"Call me, I'm interested" Circle 10

Facing Facts About Contracting

by Tim McCartney

Bemidji MN As the industry shifts from full-time to contract engineering, I've begun to hear increasing reports of problems and concerns. After talking with engineers from several markets, I've noticed the emergence of a few common themes.

One such theme points to an uneven demand for radio engineers. Another pits contract engineers against their full-time, employed counterparts. The third and most volatile is about getting paid.

Uneven demand

The general demand for radio engineers is spotty. In some locations, a shrinking engineering job market contributes to excess supply of competent engineers. In others, positions are left unfilled for lack of the proper expertise sought at the wages offered. And, in still others, the status quo remains, but is threatened as engineers face retirement.

Many contract engineers face competition from employed engineers working on the side. Even though these full-timers typically feel overworked, they are nonetheless unlikely to decline outside offers. Thus, contract engineers often find themselves vying for leftovers.

In one major market, four or five contract engineers keep their prices down in order to remain competitive with each other and with moonlighting fulltime engineers. In one medium market, competition among 30 radio stations means that any money from the local booming economy fails to stop at engineering desks.

In that market, the three full-time radio engineers join TV engineers in absorbing some of the available contract work. The balance is largely handled by a busy contractor who bills about \$30,000 per year.

But others run into problems when attempting radio contracting.

One full-time radio engineer, laid off following an ownership change, now works in TV engineering. He greatly enjoys regular hours and reduced on-call responsibilities.

In another case, in a small but growing market, three local contract engineers handle the business, but earn most of their incomes from other sources. Again, the full-time TV engineers obtain some of the available contract work.

Payment versus ethics

It's no secret that for several years now, managers of both radio and TV stations have been reducing engineering budgets in order to save money. In so doing, normally-followed ethical practices can sometimes be ignored.

Take, for example, the GM who requires his full-time engineer to bear the cost of driving to the transmitter sites, one of which is located 20 miles away. Conveniently ignored is the company mileage reimbursement policy, routinely granted to other staff members. The GM manipulates the otherwise content engineer by carefully sidetracking any discussion on the topic.

Or, consider the contract engineer who is not expected to charge for certain services. The GM believes that pay is restricted to hands-on repair of equipment

and related studying of schematics, not for time spent discussing engineering plans with him.

By far, the most often heard complaint regards the difficulty of getting paid in due time—or at all. Thus, the matter of timely payment for services rendered is a major issue for the growing numbers of contractors.

Survival strategies

Engineers are coping with the changing environment in various ways. As mentioned, some contract engineers are leaving the field while others remain in anticipation of an improved future. Some believe that several years of neglect will soon produce a period of equipment backlash, in which demand for engineering services will rebound.

There appear to be few personal relations problems between contractors and moonlighting full-timers. In some cases, however, this competition has served to decrease the rates that contractors can charge customers.

Engineers generally reserve their outrage for problems connected with collecting money owed. This is one area in which each engineer has clear choices to make.

John Cummuta, in his 26 July, 1989 RW article "Collecting on Payment Owed," argues that "you definitely want the reputation of being hardnosed about getting your money." He suggests providing "perks" for early payment, such as discounts.

Another method exists for contractors who work regularly for fiscally-delinquent managers. Should needed equipment fail, the unpaid engineer has an ideal opportunity to collect past-due bills in full as well as to obtain advance payment before resuming maintenance. Certainly, there is an appropriate point at which services must be terminated.

Yet another approach is to freely trade information. The payment record of cur-

rent and prospective management is, by necessity, appropriate for regular discussion among engineers. Also germane is early news about station ownership changes. Even though this dialogue must remain informal for legal reasons, it should nonetheless occur.

One experienced TV engineer, saddled with a six-year-old \$1800 debt from a local radio manager, sums it up by saying, "don't let them get too deeply into your pocket."

One giant step . . .

Perhaps the most encouraging news about receiving payment for work done comes from the contract engineer who was not only exhausted from chasing equipment problems, but also from time wasted trying to collect on past-due bills.

It may have been that fatigue bred inspiration when he informed his customers that payment would be required in advance. Clearly, he must be doing an excellent job, because he still has the same roster of clients.

Such a stance is not necessary for customers who are reliable. Once a manager has wandered away from this category, however, payment in advance becomes the only reasonable approach. Also, if a station sale is imminent, advance payment may be deemed necessary.

Unethical business activities can be viewed as a direct threat to contract engineers' survival. Individual survival depends on the degree to which the challenge is met.

Be on the alert for short-term profiteers who believe that they will be personally rewarded by shortchanging others. Such a manager may elect to pocket those dollars rightfully belonging to the engineer.

In hopes of improving the climate for contractors, let me suggest a few prompt payment principles:

- Owners and managers are considered pay-reliable (PR) until proven pay-unreliable (PU).
- The PR record of management is freely shared among engineers.
- Time spent collecting payments is fair billing to a PU-manager.
- Engineers ought not to allow debts to become excessive.
- All services are withheld from customers with debts owed longer than 30 days.
- Payment is required in advance for customers achieving PU status.

In locales where demand is soft or competition stiff, contractors may be skeptical about following such guidelines for fear of losing business. Thus, some engineers will be tempted to take risks in hopes of eventually getting paid. Clearly, each contractor must individually arrive at such critical decisions.

■ ■ ■

Tim McCartney is a contract engineer in Bemidji, MN. He is an SBE Senior AM/FM Broadcast Engineer, a former radio station engineering director and general manager, and has a master's degree in human resources management. He can be reached at 218-751-1680.

MB-2
FIELD NEWS BRIDGE



DESIGNED FOR PRESS CONFERENCES

IMPORTANT USER FEATURES :

80dB BETWEEN OUTPUTS
LOOPING & SUMMING JACKS
HEADPHONE AMPLIFIER
VU METER
AC / BATTERY OPERATION
RUGGED . DEPENDABLE

INPUTS:

2 MICROPHONES TRANSFORMER
1 LINE BALANCED

OUTPUTS:

12-XLR MALES TRANSFORMER
12-MINI PHONES BALANCED

SEND FOR FREE CATALOG



SESCOM INC.
2100 WARD DR.
HENDERSON NV 89015 U.S.A.
702-565-3400, 800-634-3457, FAX 702-565-4828

Circle 18 On Reader Service Card

World Radio History



CRL SPOTLIGHT

**Converting to the
NRSC Standard?**

**Want to Improve Coverage
of Your Station?**



CRL's AM2 audio processing system is a COST EFFECTIVE way to convert your station to the NRSC standard, and in many cases improve your coverage as well. The two unit system consists of a two-band AGC unit with our dynafex® single ended noise reduction circuitry (AGC-400) followed by our tri-band peak modulation controller (PMC-450). Split studio and transmitter sites? Use the AGC unit at the studio and the limiter at the transmitter! An adjustable presence band boost lets you augment vocal clarity and punch. A patented overshoot corrected low-pass filter ensures maximum modulation control. Low frequency tilt correction circuits plus adjustable asymmetry levels assure compatibility with all transmitter types. Suggested retail price is only \$3195. Our TWO WEEK TRIAL PROGRAM will prove to you how sound of an investment the AM2 mono system is. Call or write us NOW for details.



CRL Systems
2522 West Geneva Drive
Tempe, Arizona 85282 U.S.A.
(800) 535-7648 (602) 438-0888
TELEX: 350464

Circle 6 On Reader Service Card

An AES/EBU Interface Resource

by Mel Lambert

Studio City CA Just under a year ago within these hallowed pages, I discussed in some detail the differences between the "professional" AES/EBU digital interface, and the "consumer-grade" S/P DIF-compatible I/O (now, more usually, and generically, referred to as "IEC Type II")

During the past year I have also described possible interface problems that might be encountered during the routine use of AES/EBU ports between hardware separated by more than a few feet, or in situations where intermediary patch panels and tag blocks might com-

promise the 3.072 megabit per second data streams.

Against this background, I recently came across a new publication that I would recommend highly to anyone

DIGITAL DOMAIN

who is experiencing problems with utilizing AES/EBU interfaces, or who simply wants to be brought up to speed with current developments.

During September last year the Brit-

ish section of the Audio Engineering Society organized a fascinating gathering in London, entitled (appropriately enough) "The AES/EBU Interface Conference." The conference's book of proceedings, which runs to 150 pages, including appropriate schematics and block diagrams, has just been published here by the AES. (Call 212-661-2355 for information and availability.)

A dedicated conference

The two-day conference was divided into two sections. The first day was devoted to standards and circuit design, while the second day's sessions covered using the interface and future developments.

There are enough good discussions within these conference proceedings to make them essential reading even if you think that you are reasonably well versed in the intricacies of digital I/Os. For example, a succinct overview by John Emmett, of Thames Television, probes the important differences between the professional AES/EBU interface and its consumer cousin, including the Channel Status Data Format.

Of significant practical value is a very thorough treatment by Neil Gilchrist of the BBC Research Center, which considers various methods of sending coordinating signals between program sources and destinations in the auxiliary section of the AES/EBU format.

As Gilchrist reports, CCIR Studio Group 10 has adopted this technique as a standard; basically, the four aux bits

(continued on page 42)

Springtime Tradition

(continued from page 36)

inside the tower legs, attacking the metal from the inside.

(If you are new to the station, here's a tip: Check to see the weepholes are at the *bottom* of each section. Occasionally tower sections are installed wrong way up!)

Additionally, check out the tower fence and gate. Are they really secure? At this point, the local flora have yet to fully reassert themselves, so it's usually a lot easier to clear those areas before they get filled by grass or weeds.

And, since the towers just stand there year after year (we hope), what about the tower paint and lighting? How far away can you clearly see your tower?

If the tower is not clearly visible to approaching aircraft due to fading or peeling, you can be liable for a fine, not to mention the potential legal liability in case of a crash.

In fact, the FCC now makes this a priority check item during inspections. Also meriting attention is the photocell system. Is it turning the tower lights on early enough at dusk?

Meanwhile, back at the ranch . . .

Just like at the transmitter site, the exterior of the studio building deserves a full inspection, as do the various STL, RPU, satellite and other antennas.

Inside the studio may be the easiest part of your inspection, as you may have been indoors all winter, fixing everything in sight, making sure all the wiring is in phase for stereo.

On the other hand, how long has it been since your last mock FCC inspection? Start with the FCC checklist. Is your paperwork trail sufficient to prove that your operation is legal?

Permits posted? Operator's manual current? Public file up to date? Often only the station engineer really knows what is required.

That creates an excellent opportunity to show the GM your value in these days of escalating fines. As at the transmitter, don't forget the air conditioning system and air filters.

While overheated DJs do not fail like transmitters, they do become rather crabby when their overload relays trip; it's easier to work with them if the studio is comfortable.

It's obvious that regular maintenance is essential for heavily used gear, such as in the control room. If you haven't al-

ready set up a schedule, do so now.

A stack of 5x8 index cards can hold schedules or a maintenance history of each item in the station. If you have a computer, that can be a big aid in keeping track.

Horrors!

Sometimes, it seems that when you open the console, or look under the cabinet, an ugly mass is discovered there looking like nothing so much as a vat of dried spaghetti covered with grey paint.

Some stations do a root canal on their wiring and find that eliminating excess wire can significantly reduce hums, buzzes and RF in the station audio chain.

Even if you are a careful technician, how is your documentation? Have you made sure the wiring diagrams for the station are up to date?

Look at it this way: You'll likely want a vacation some day. Whoever stands by for you will appreciate accurate wiring records.

After you've determined that all the studio equipment is working well, is aligned to an actual standard and the nicotine has been scraped from the control room windows, etc., you may want to poll the disc jockeys to see what can be done to make control room operation easier.

Perhaps moving a source from one pot to another will help, maybe adding a new remote button. In any event, knowing what the staff thinks about the operation will help you in planning a better, more functional facility.

As you go by the control room, be generous: pass out some cotton swabs and cleaner to the staff. They may even get used!

Obviously, it's impossible to mention here everything that may need attention. So, look around your facility, talk to other engineers and create a maintenance program that works for you.

List the points that you've found valuable in helping keep your facility running at optimum efficiency. The main thing is to follow through with whatever repairs or adjustments are needed.

You'll be rewarded with months of smooth, solid operation.

■ ■ ■

Barry Mishkind, aka RW's "Eclectic Engineer," is a consultant and contract engineer in Tucson. He can be reached at 602-296-3797.

GET IT RIGHT
GET IT FROM ALLIED

We Can Design Your System From The Ground Up.

No job is too small or too large—stateside or overseas. Call the broadcast professionals at Harris Allied Systems.

P. O. BOX 4290 • QUINCY, IL 62305-4290

©HARRIS/ALLIED 1990

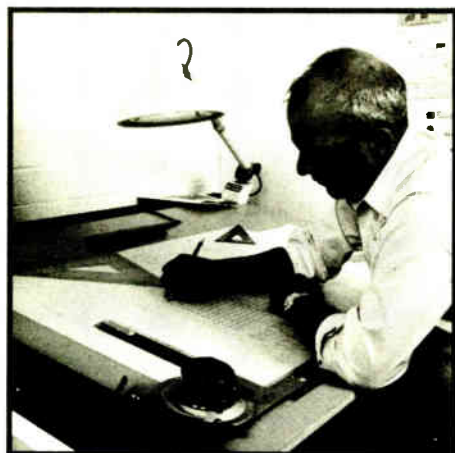

HARRIS ALLIED SYSTEMS

217-222-8290

\$233.00
per
MONTH



Price shown based on console purchase price of \$8995.00 and 60 month lease • First and last payments are due on signing • \$1 buy-out option • No financial statements or personal guarantees are required, if you have been in business for at least 2 years • 48 hour loan turn-around guaranteed • Simple, one page loan application • No processing or filing fees • Other terms and payment plans are available • Terms and rates subject to change without notice

RADIO SYSTEMS INC.

110 High Hill Road • P.O. Box 458 • Bridgeport, NJ 08014-0458 • 609/467-8000 • 800/523-2133 • FAX 609/467-3044

Circle 75 On Reader Service Card

World Radio History

Staying Abreast of AES/EBU

(continued from page 40)

per subframe are used to provide voice communications and/or cueing. The 192 kbits/second would provide a 12-bit word length at a sampling frequency of 16 kHz for voice quality cue and reverse-feed coordination channels of just under 7 kHz bandwidth—more than adequate for the majority of communication applications envisioned for the interface.

Channel Status discussions

Several papers presented at the AES Conference discussed the importance of ensuring stable clock and synchronization sources; others focused on applica-

tions of Channel Status bits.

Serge de Jaham, of Digitec, France, provided a detailed description of two new A-to-D and D-to-A converters that allow CS data to be encoded/decoded as part of the AES/EBU digital bitstream.

Acknowledging that the Channel Status can be used to carry various data to identify system configurations, source/destination labels, timecode, etc. within the 96 kbits per second, de Jaham described several ways in which this useful information might be entered into a PC and added to the digitized audio data.

A companion paper by Alain Komly, of Telediffusion de France, described a new packet-based technique for adding Program Labels to the digital bitstream, such information being carried within the User Channel.

Two basic types of labels are being proposed: Static Data and Dynamic Data.

Typical applications of Static Data might include the labeling of program material, copyright sources, accompanying text—possibly introductory cues and/or related script materials—plus other low-priority messages.

Dynamic Data might include editing information (edit-decision lists and the like), plus CD subcodes, TeleText and signal-processing data. (One proposal is that the User Channel be used to carry dynamic companding information.)

Cornucopia of applications

While more work needs to be done in this area, there is certainly a cornucopia of applications to which such data, once standardized, could be put.

Paul Evans of Thames Television described his company's experience with carrying AES/EBU-format signals around a large broadcast facility, and also the necessary evils of large distribution matrices to route signals between production areas.

Of particular importance, he stressed, was the use of buffer amplifiers or simi-

lar devices on longer cable runs, or where differing characteristic impedances are cascaded. These units would restore signal level and could also be set to relock the digital data via a phased-locked crystal oscillator.

An extremely useful paper by Richard C. Cabot, of Audio Precision, entitled "Measuring AES/EBU Interfaces," described techniques for checking the electrical and electronic performance of digital I/Os, including the ports and the cables used to interconnect them.

As Cabot points out, the AES/EBU standard calls for a transmitter output impedance of 110 ohms, and a receiver input impedance of 240 ohms. This inherent impedance mismatch, allied with the fact that the RS422 electrical specification limits the recommended cable length to 145' (best case!), drastically reduces the ability of a digital output to drive long lines.

The up side

But it's not all bad news, he offers. Cabot has successfully run an AES/EBU interface over 320' of conventional microphone cable with zero errors, although this ability does depend on the interface design.

Accessories for the Audio Precision System One test set now allow error rates of an AES/EBU interface to be measured using one of three different waveforms: constant, but sweepable, hex or decimal values; a walking-bit pattern; and a pseudo-random number sequence.

Tim Shelton of the BBC Research Department turned to the thorny subject of synchronizing various digital bitstreams within a multiple-room or multi-machine production environment. Shelton provided an invaluable overview of the primary considerations, as well as the effects of clock instability and jitter on sonic performance.

On a similar tack, Phil Wilton, of Sony Broadcast & Communications, described the proposed MADi (Multichannel Au-

dio Digital Interface) format, which provides a data capacity of 56, 24-bit AES/EBU-compatible channels via a coax or fiber-optic conductor.

MADi represents a major savings in cabling and system complexity when a large studio production area needs to be linked birectionally to a master control room, for example, or a workstation is connected to a companion multichannel recording system.

Companding techniques

One of the conference's final papers came from Christer Grewin, of the Swedish National Radio Company. Titled "A Format for Contribution of Digital Studio Quality Sound Signals," it provides a unique overview of the various companding techniques currently being considered by European Broadcasters to carry digital signals over long distances.

Grewin identified three current techniques using 32 kHz sampling frequencies—A-Law, an instantaneous 14-bit to 1-bit companion system; NICAM, a near instantaneous 14-to-10 companding system with a 1 ms companding block; and DS1, a floating-point companding system that involves 16-to-14 conversion with 2 ms companding blocks. He argued that for compatibility with 48 kHz AES/EBU-format signals, the European Broadcasting Union is currently considering the use of an H1 channel (1,920 or 1,536 kbits/second).

His paper detailed the various transcoding and error correction schemes available to ensure compatibility with 16/20/24-bit AES/EBU data bitstreams.

I would advise anyone seriously interested in current and future applications of the AES/EBU Digital Interface within the broadcast environment to secure a copy of this report from the AES. You will thank me later, I can assure you.

■ ■ ■

Mel Lambert has been intimately involved with the production and broadcast industries on both sides of the Atlantic for the past dozen years. Now principal of Media & Marketing, a consulting service for the professional audio industry, he can be reached at 818-753-9510.

Where's that phone number?

Find it fast in the new 1990 Radio World Annual

Your Source For ...

Manufacturer, Supplier, NAB and FCC Phone Listings

As Well As ...

Product Information, Company Profiles, Buyers Guide Reprints, RW's 1989 Editorial Index, Reference Material, and More ...



Don't have one? Get it Fast! Send \$14.95 for each Annual to:

RW 1990 Annual
P.O. Box 1214
Falls Church, VA 22041

▲ DELINEATING THE NEW STANDARD ▲

Modular Flexibility
Custom Fit

MURPHY
STUDIO FURNITURE

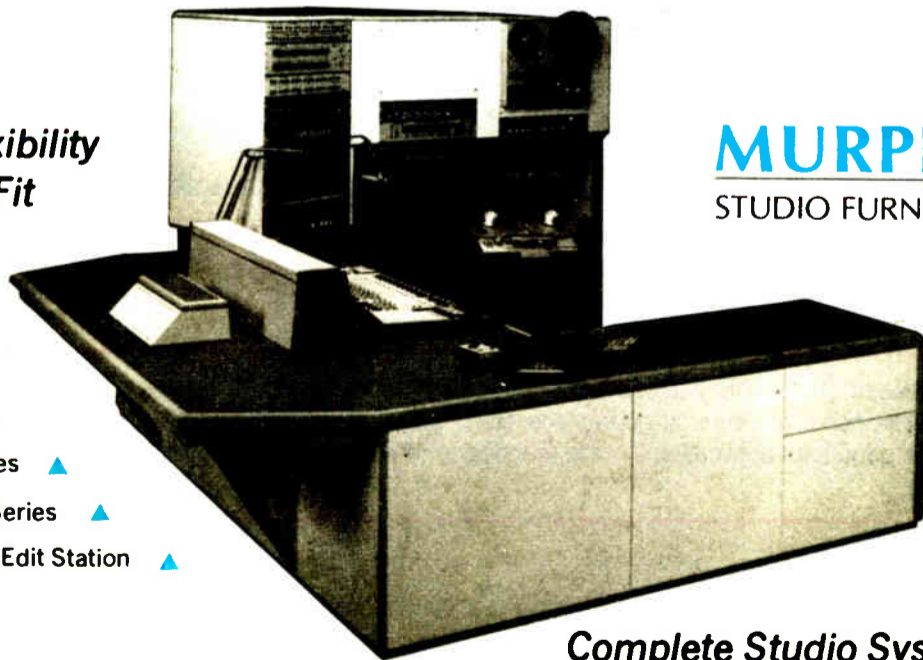

- ▲ Elite Series ▲
- ▲ Premier Series ▲
- ▲ Classic Series ▲
- ▲ Dub/Edit Station ▲

Complete Studio Systems
From \$1899

OUR ELEGANT STUDIO FURNITURE IS DESIGNED TO MEET YOUR EXACT NEEDS

▲ 4153 N. BONITA STREET ▲ SPRING VALLEY, CA 92077 ▲ TEL (619) 698-4658 ▲ FAX (619) 698-1268 ▲

Circle 33 On Reader Service Card

How the newest AM transmitters earned one of the oldest names in radio.

Introducing the Gates Line of 1, 2.5 & 5 kW Solid State AM Transmitters.

Gates. It's more than a name — it's a tradition of quality and value. To earn that name, these affordable new transmitters had to meet the highest industry standards in five key areas:

Value

- Overall efficiency of up to 72% cuts power costs.
- Multimeter plus PA voltage, PA current, and forward/reflected power meters standard.
- Output tuning included as standard.
- Remote inputs compatible with both TTL and relay-type remote systems.

Durability

- No tube failures, time-consuming adjustments or replacement costs.
- Modular construction with easily accessible socketed MOSFETs.
- "Chimney design" air handling keeps transmitter clean and dust-free.
- 100% solid state "soft-failure" power amplifiers.

Simplicity

- Six independently adjustable power levels accommodate virtually all PSA/PSSA requirements.

GATES

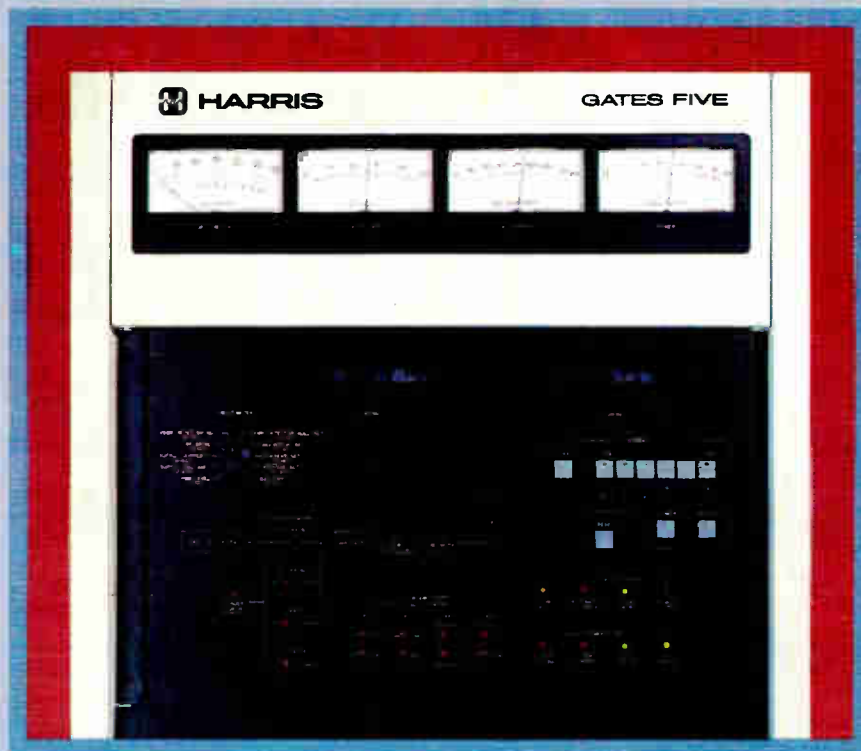

- Color Stat™ front panel with signal flow block diagram and red Fault LEDs shows transmitter status at a glance.
- Rugged, dependable discrete logic controller.

Reliability

- Automatic overload power cutback keeps the transmitter

on the air at the highest safe power level.

- Bandpass output network has proven its lightning survival capabilities in the field.
- Automatic instant AC restart.
- Battery backed-up controller memory.

Performance

- Patented Polyphase Pulse Duration Modulation technology.
- Unsurpassed reach with 130% positive peak capability.
- Minimal distortion, overshoot and ringing for crisp, "ear grabbing" sound.

Original circa-1946 Gates transmitters are still on the air to remind us that value, durability, simplicity, reliability, and performance are as important right now as they ever were. So if you want an affordable solid state transmitter with all the "old-fashioned" advantages, call Harris today for more information on the newest AM transmit-

ters — and how they earned the proudest name in radio.



Harris Broadcast Division
Marketing Department
P.O. Box 4290, Quincy, IL USA 62305-4290
Tel (217) 222-8200 Ext. 3408
Fax (217) 222-7041

© 1990 Harris Corporation

Circle 61 On Reader Service Card

World Radio History

WHY YOU SHOULD PAY MORE FOR LESS.

**New Name-
Same Great Cart!**
The ITC Cart II Cartridge, formerly ScotchCart® II

Less phase jitter caused by poorly tracking tape, because the naturally lubricated concave guides gently position the tape and allow the cartridge machine to perform critical guidance.

Less tape noise and signal loss with our 100% laser-inspected, high output, low noise tape which delivers better frequency response and keeps signal-to-noise ratio high, harmonic distortion low.

Less wow and flutter or stop cue overshoot, because there's no rotating hub to wear out, warp or rattle.

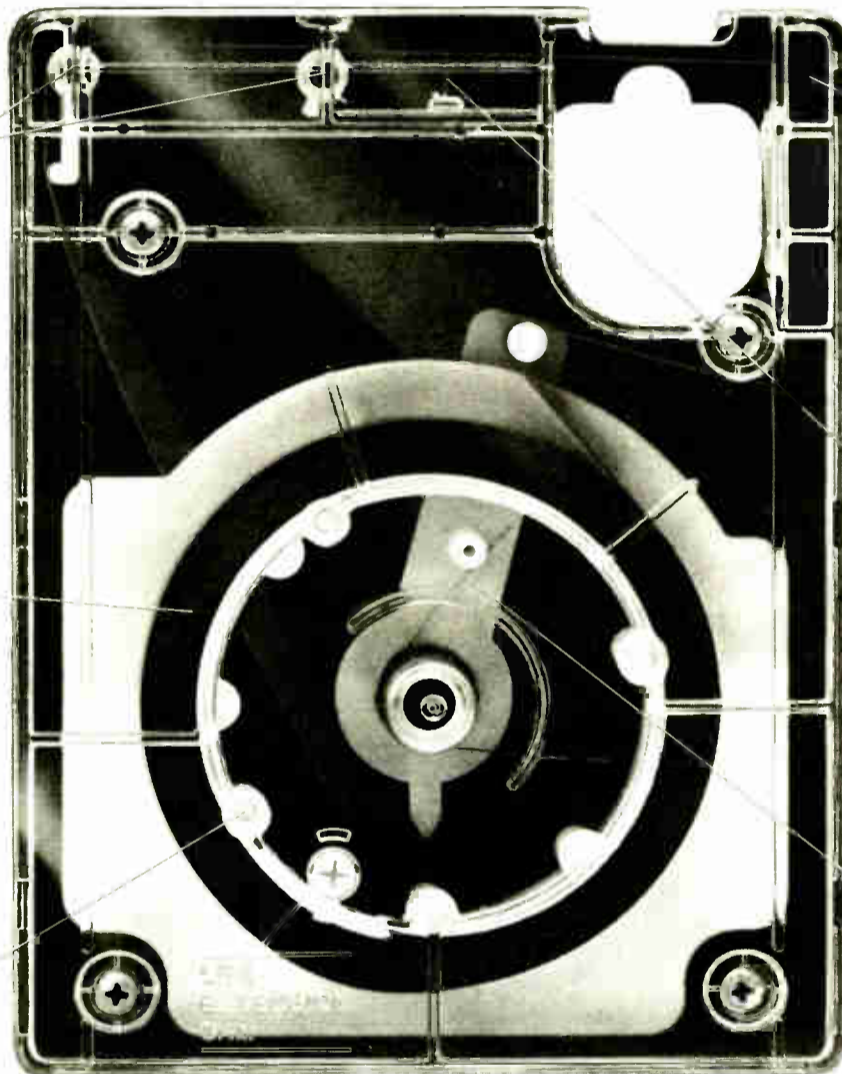

Less chance of the cartridge cracking or breaking, because the tough polycarbonate cover withstands repeated use and abuse.

Less head wear, tape steering and modulation noise, because there aren't any pressure pads to add friction.

Less chance of tape destruction, because our patented dynamic tension control system ensures proper tape-to-head contact, and provides constant tension to control looping and prevent twisting.

The ITC Cart II Cartridge, formerly ScotchCart® II

With broadcast cartridges, like everything else, you get what you pay for. With ITC Cart II cartridges, you get a revolutionary design that delivers trouble-free operation, superb sound quality and a life expectancy that's second to none.

We have renamed the cartridge due to trademark considerations, but only the name has changed, the cartridge and tape are the

same. New name, same great cartridge and performance.

For a complete listing of ITC Cart II dealers, call ITC toll-free at 800-447-0414 (in Illinois, call collect 309-828-1381.) Or write to ITC at P.O. Box 241, Bloomington, IL 61702-0241.

Because a cheaper cartridge may be more trouble than you can afford.

ScotchCart® II is a registered trademark of 3M

Circle 46 On Reader Service Card

World Radio History



Occupied Bandwidth: Early Data

by Eric Small

Brooklyn NY Recently there has been a great deal of interest in the bandwidth of program-modulated FM broadcast signals.

The main concerns have been the interference potential of different kinds of audio processing and the way various methods of measuring bandwidth fit into the regulatory scheme.

Because several of its products have an

The critical question is how to measure the bandwidth containing 99.0% of the power of a signal while it is being modulated by real stereophonic program material.

It is a common misconception that a spectrum analyzer can provide useful information about occupied bandwidth.

A conventional (scanning type) spectrum analyzer is useless for determining the occupied bandwidth of a program modulated FM broadcast signal because

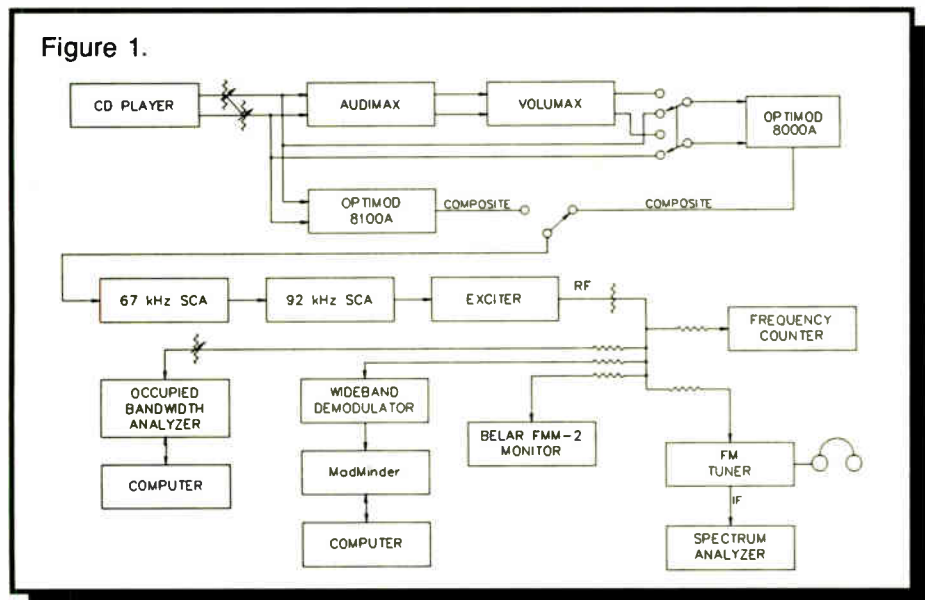

impact on bandwidth, Modulation Sciences, Inc. recently began a research project to investigate occupied bandwidth by doing controlled studies of the effect of varying program content, signal processing and SCA presence.

The work is far from complete; however, because the data is of current interest, these preliminary results are be-

all it can do reliably is to determine the occupied bandwidth of a carrier modulated by a sine tone.

Several other fundamental problems exist with using a spectrum analyzer for measuring the occupied bandwidth of a high deviation, complex and non-periodic modulated signal such as a stereo FM broadcast signal.

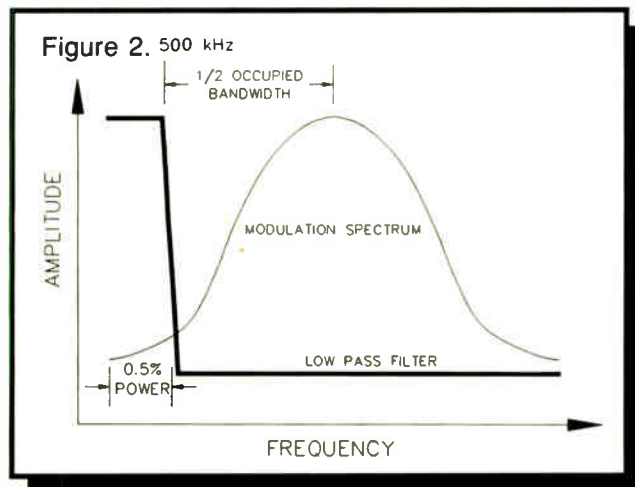

ing made available to the industry in the most rapid manner possible.

The data presented here was created in strict adherence to CCIR recommendations and, where applicable, to International Radio Regulations (IRR).

The United States is signatory to the International Telecommunications Union treaties, whose definitions were made a part of FCC Rules in Volume 2 of Title 47 of the Code of Federal Regulations.

The key parameter in determining the potential of a signal to cause interference is its occupied bandwidth. Great confusion has surrounded the definition of occupied bandwidth.

Fortunately, both the FCC and IRR are specific here, providing a precise definition: the occupied bandwidth of a randomly frequency modulated signal is that bandwidth containing 99.0% of the power.

1. Because a spectrum analyzer scans a narrow filter across the band, it is likely to miss infrequent or non-periodic peaks.

2. If the bandwidth of a spectrum analyzer is made wide enough to avoid the problems described above, the resolution is typically so reduced as to add unacceptable error to the results.

3. The storage or peak-hold feature of various analyzers are not characterized with respect to measuring occupied bandwidth of dynamic signals.

The final value displayed depends on the storage technique employed by the particular analyzer. Often the characteristics of storage or peak-hold function are not even part of the published specifications of the instrument.

In the author's experience, errors from this source can be as great as $\pm 50\%$ of the correct value.

4. The detector in commercially available spectrum analyzers is a peak voltage type, not a power detector. Both the FCC and IRR define occupied bandwidth in terms of power.

A true RMS detector (either calculated or thermal) is necessary. As far as I know, there are no commercially available spectrum analyzers with RMS detectors.

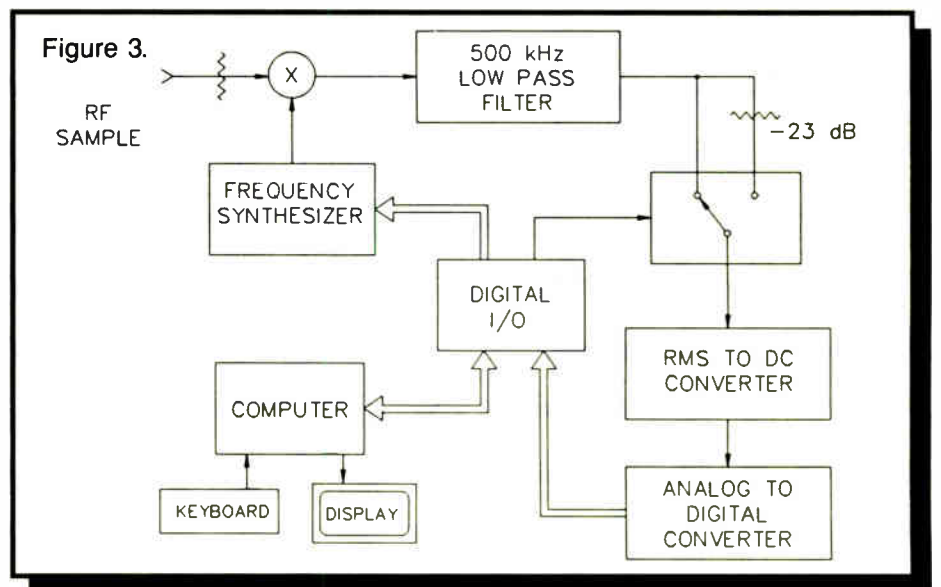

Another issue that often arises in discussions of the interference-causing potential of signals is the validity of using protection ratio measurements.

Protection ratio data is a necessary ingredient in any new or modified table of allocations. However, by their nature, protection ratio measurements are highly statistical with large standard deviations.

The effort involved in using protection ratio data to reach defensible conclusions about small changes in interference would be enormous.

First, a statistically significant number of different receivers would need to be acquired. They would then have to be characterized using the protection ratios on which our current table of allocations are based.

In addition, any deviation from strict adherence to CCIR standards for doing protection ratio measurements would need to be validated against CCIR procedure, potentially a very time-consuming process.

It is important to remember that many years of effort have gone into creating and validating the CCIR procedures and

they cannot be lightly dismissed without raising serious doubts about the value of the new work.

Finally, protection ratio measurements are never defined in the FCC Rules, let alone discussed, in contrast to occupied bandwidth, which is carefully defined in Part 2 and then comes up in almost every other Part of Title 47 (The FCC Rules).

Recently, CCIR published a major revision of its *Handbook for Monitoring Stations* which devotes an entire chapter to bandwidth measurement.

A technique for automatic measurement of the occupied bandwidth of an arbitrarily modulated signal is presented at the block diagram level.

This is the design Modulation Sciences followed in building an Occupied Bandwidth Analyzer. Figure 1 illustrates the principle of operation of the Occupied Bandwidth Analyzer.

The RF sample is heterodyned to approximately 500 kHz by a computer-programmed frequency synthesizer. The modulated signal then passes through a very sharp cutoff 500 kHz lowpass filter.

(continued on page 48)

fm TRANSMITTERS FROM CONTINENTAL

- COMPACT AND EFFICIENT
- SOLID-STATE DRIVER
- EXCLUSIVE SOFT START™
- AUTOMATIC POWER CONTROL
- TOTALLY SELF CONTAINED
- TRANSTAT™ READY

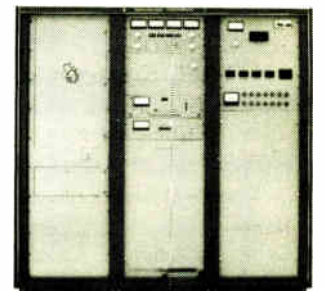

varian®

continental electronics division



P.O. Box 270879 Dallas, Texas 75227 • (214) 381-7161 FAX: (214) 381-4949

2061

Circle 125 On Reader Service Card

MARKETPLACE

Send us your new product info. Be sure to include a black and white photo. Send all submissions to Radio World Marketplace, P.O. Box 1214, Falls Church, VA 22041

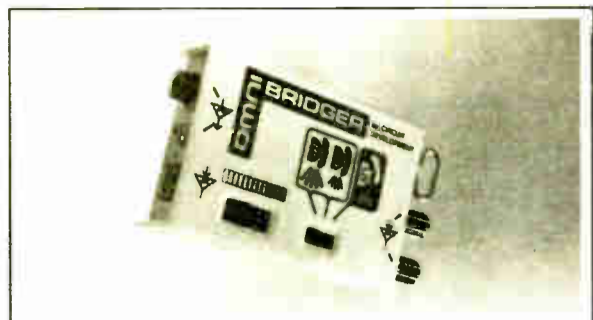

Headset amplifier

The Omnibrider headset amplifier from Circuit Development Co., Inc. is a line level bridging device.

The Omnibrider allows the user to bridge telephone or other high level balanced circuits for cue monitor or maintenance purposes.

The Omnibrider has low distortion, high input impedance, high level low impedance output and wide bandwidth characteristics as well.

For information, call **Charles Sanfilippo at Circuit Development Co., Inc:** 718-768-4555 or circle Reader Service 70.

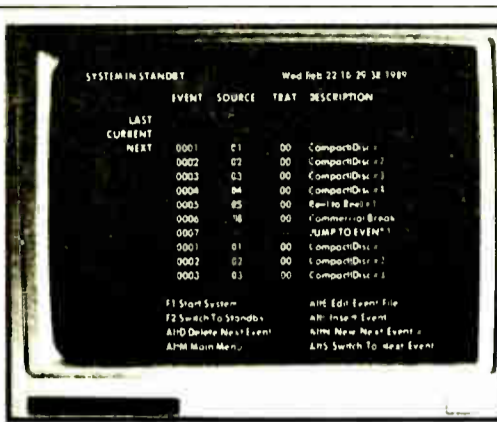

Station controller

Kingdom Technology introduces The Station Controller which provides flexibility for live assist or fully automated programming.

The Station Controller features relays to control the devices and input circuits from the devices for monitoring various external conditions.

For information, call **David Benoit at Kingdom Technology:** 904-664-6492 or circle Reader Service 26.



Furniture system

The Express Group Series 6000 is a modular furniture system that is designed with vents to maximize passive air flow for efficient cooling.

The 6000 positions 14" of rack space in two bays directly in front of the user.

It can accommodate 6 cart machines. Each module is designed with access panels and quarter-turn panels.

For information, call **Bob Burns at The Express Group:** 619-298-2834 or circle Reader Service 133.



Digital audio terminal

Corporate Computer Systems Audio Products Division has introduced its Micro64 digital audio terminal.

The Micro64 digitizes audio information and interfaces it to the digital telephone network.

It allows broadcasters to deliver 7.5 kHz audio over a single 64-kbit/s digital phone circuit.

64x oversampling in the A-D converter and 8x oversampling in the output D-A converter helps to produce a clear signal.

For information, call **David Lin at Corporate Computer Systems:** 201-946-3800 or circle Reader Service 97.



Station monitor

The CIA-1 from Russco Electronics is an automatic monitoring device which allows the user to monitor the commercial airtime of other stations.

For information, call **Russell Friend at Russco Electronics:** 209-291-5591 or circle Reader Service 56.



Clamping knobs

The Beta and Omega Series clamping knobs from Rogan Corp. are sold with either threaded inserts or threaded studs, and are available in lengths ranging from 1.12" to 3.50".

They are available with molded domes, flat tops or decorative inlays.

For information, call **Don Pelletier at Rogan Corp.:** 800-423-1543 or circle Reader Service 78.

SUBSCRIPTION/READER SERVICE FORM

Radio World

June 13, 1990 Issue Use until September 12, 1990

FREE Subscription/Renewal Card

I would like to receive or continue receiving Radio World FREE each month. YES NO

Signature _____ Date _____

Please print and include all information:

Name _____ Title _____

Company/Station _____

Address _____

City _____ State _____ ZIP _____

Business Telephone () _____

Please circle only one entry for each category:

- I. Type of Firm**
- D. Combination AM/FM station
 - A. Commercial AM station
 - B. Commercial FM station
 - C. Educational FM station
 - E. Network/group owner
 - F. Recording studio
 - G. TV station/teleprod facility
 - H. Consultant/ind engineer
 - I. Mfg. distributor or dealer
 - J. Other _____

- II. Job Function**
- A. Ownership
 - B. General management
 - C. Engineering
 - D. Programming/production
 - E. News operations
 - F. Other (specify) _____

- III. Purchasing Authority**
- 1. Recommend
 - 2. Specify
 - 3. Approve

Reader Service

Please first fill out contact information at left. Then check each advertisement for corresponding number and circle below. NOTE: Circle no more than 15 numbers, otherwise card will not be processed.

- 001 023 045 067 089 111 133
- 002 024 046 068 090 112 134
- 003 025 047 069 091 113 135
- 004 026 048 070 092 114 136
- 005 027 049 071 093 115 137
- 006 028 050 072 094 116 138
- 007 029 051 073 095 117 139
- 008 030 052 074 096 118 140
- 009 031 053 075 097 119 141
- 010 032 054 076 098 120 142
- 011 033 055 077 099 121 143
- 012 034 056 078 100 122 144
- 013 035 057 079 101 123 145
- 014 036 058 080 102 124 146
- 015 037 059 081 103 125 147
- 016 038 060 082 104 126 148
- 017 039 061 083 105 127 149
- 018 040 062 084 106 128 150
- 019 041 063 085 107 129 151
- 020 042 064 086 108 130 152
- 021 043 065 087 109 131 153
- 022 044 066 088 110 132 154

ADVERTISER INDEX

This listing is provided solely for the convenience of our readers. Radio World assumes no liability for inaccuracy.

Page No.	Advertiser	Reader Service No.	Page No.	Advertiser	Reader Service No.	Page No.	Advertiser	Reader Service No.
49	A/G/Orban	63	33	CCA Electronics	120	12	Moseley	13
06	Allied Broadcast/ITC	11 & 102	35	Comrex	73	42	Murphy Studio Furniture	33
16	Allied Broadcast	17 & 114	48	Conex	77	37	Northeast Broadcast Labs	55
32	Allied Broadcast/Alpha Audio	29 & 100	10	Continental Electronics	27	13	Orban	122
38	Allied Broadcast/Gentner	141 & 10	45	Continental Electronics	125	25	Otari Corp.	124
40	Allied Broadcast	148 & 71	24	Cortana	81	17	Pacific Recorders & Engineering	110
48	Allied Broadcast	51 & 4	22	CRL	138	58	Peter Dahl Co.	30
30-31	Arrakis Systems	27	28	Dataworld	143	29	QE	43
7	ATI	117	18	Delta	37 & 90	41	Radio Systems	75
27	Audio Broadcast Group	94	1	Fidelipac	36	24	RF Specialties	111
9	Audiopak	152	36	Flightline	85	11	Schmid Telecommunications	82
19	Audiotronics	34	50	Full Compass	65	39	Sescom	18
36	Belar	9	15	Gentner	59 & 140	22	Sono-Mag	89
3	Bradley Broadcast	50	43	Harris	61	21	Sony	-
3	Broadcast Electronics	92	34	Hnat Hindes	108	14	Studer Revox	57
20	Broadcast Electronics	146	16	IGM	129	47	Studer Revox	40
21	Broadcast Services	5	44	ITC	46	28	Tannoy	14
8	Broadcasters General Store	41	10	J.N.S.	54	57	Transcom	127
23	BSW	2	7	Jampro	105	2	Wheatstone	15
4	Burk Technology	31	26	Logitek	67	59	Wheatstone	80
33	Cancomm	19	23	Marti Electronics	25	60	Wheatstone	101

Advertising Sales Representatives:

East Coast, Art Constantine: 800-336-3045 Fax: 703-998-2966
 Midwest, Art Constantine: 800-336-3045 Fax: 703-998-2966
 West Coast, Pat Macsata: 415-786-2198 Fax: 415-786-2754

C270

C274

C278



\$3,995

2-TRACK

With Center Track
Time Code \$5,995

\$4,995

4-TRACK

\$5,995

8-TRACK

REVOX OPEN REEL RECORDERS. HIGHER QUALITY. LOWER PRICES.

THE C270 SERIES This exciting new line of recorders provides you with all the traditional Studer Revox benefits—mechanical precision, electronic sophistication, supreme sound quality and superior support—adding up to state-of-the-art analog recording technology. The C270 is available in 2, 4 and 8-track versions with or without remote/autolocator.

BEST BUY Compare the “street” price and performance of any C270 Series machine with the competition, and you’ll find there is no competition. The die-cast deck plate and head block, the precision mechanics and a host of powerful features tell you any C270 Series machine will last as long as you need a reel-to-reel in this emerging era of digital workstations. And in the digital future, you’ll need analog recorders that will sound good—for a long time. That’s why your last reel-to-reel should be a Studer Revox.

TIME CODE . . . OR NOT The C270 2-track version offers optional center track time code for effortless synchronization to picture or sound. The C274 4-track and C278 8-track are both equally adaptable to production or post. The optional remote/autolocator stores 18 start/stop addresses and provides full transport and channel remote control to fit into any professional studio environment.

LOGGING TOO For station logging applications, special super low speed versions of the C274 and C278 are available with built-in time/date code generator and reader with search capabilities, providing up to 25 hours of continuous audio on one reel of tape.

Call your Studer Revox Professional Products Dealer—or Studer Revox direct—to discuss all the details. Or simply call **800-366-4900** to receive our C270 series color booklet.

C270 Remote/Autolocator



STUDER REVOX

Studer Revox America, Inc. • 1425 Elm Hill Pike • Nashville, TN 37210 • (615) 254-5651
New York (212) 255-4462 • Los Angeles (818) 780-4234
Studer Revox Canada Ltd., Toronto (416) 423-2831
Circle 40 On Reader Service Card

© 1990 Studer Revox America, Inc.

World Radio History

Occupied Bandwidth Method

(continued from page 45)

The output of the filter drives a true RMS detector. Under control of a computer, the frequency of the synthesizer is slewed until 0.5% of the total signal power is within the passband of the low-pass filter.

Figure 2 shows the relationship of the signal to the filter passband. The cutoff point of the filter marks the edge of occupied bandwidth.

The processing and source material for these tests produced a symmetrical power distribution about the carrier, as would most material. One band edge marker therefore accurately describes

these signals.

Since some processing schemes or distortion could cause asymmetrical modulation, the local oscillator can be tuned to the other side of the signal under test and the opposite sidebands may be tested to determine the symmetry of the occupied bandwidth.

The entire device may be calibrated by switching in the 23 dB attenuator following the filter.

The heterodyne frequency is shifted so the entire signal is within the passband of the filter. This will pass the whole signal into the detector.

Since 23 dB of attenuation is a power ra-

tio of 0.5%, a reference level is set that is independent of the linearity of the detector.

Although the design and validation of the occupied bandwidth meter will be the subject of a separate paper, it is worth touching on some aspects of the validation here.

Low frequency modulation is in many ways a worst case test. The occupied bandwidth of several low frequency modulating sine waves was calculated using Bessel functions to determine the sideband structure.

Then a power summation of sidebands was done until the sum equaled

Data Presentation Data is presented for two selections: Steely Dan *Black Friday* and Shostakovich *Symphony #5*, except for the Orban XT, which was not measured with the Shostakovich. Each selection was subjected to increasingly greater processing, both with and without SCA.

The bar charts included show the results of the test. There is a graph for each response time with a great deal more data plotted than is displayed on the bar charts. Several more music selections were used.

Several conclusions can be drawn from the data.

First, under no conditions of processing or SCA usage does any signal come anywhere near filling its allocated bandwidth. Significantly, this conclusion agrees well with a study done by Tell and Nelson in 1976 employing entirely differently methodology.

Secondly, changing the peak flasher response time from 200 to 900 μ seconds will cause only a statistically insignificant increase in occupied bandwidth for heavily processed signals, while unprocessed signals will make more efficient use of the spectrum.

For any given peak flasher response time and program material, lighter processing will result in less occupied bandwidth than heavier processing.

And finally, the correlation between peak deviation and occupied bandwidth increases as the peak flasher response time is increased from 200 to 900 μ seconds.

These are the initial results of occupied bandwidth tests. There will be more data available as the measurements continue.

There are a number of footnotes and

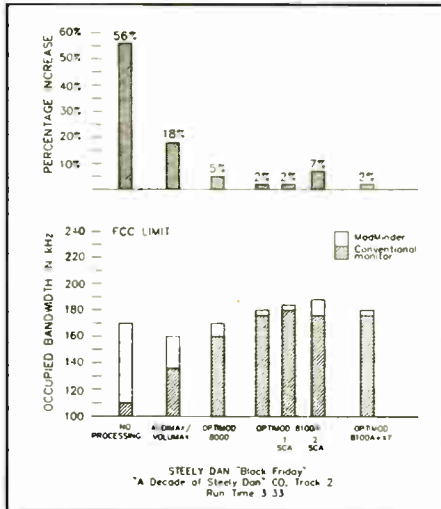

0.5% of the total signal power. The frequency offset from the carrier to this 0.5% power point is one-half the occupied bandwidth.

The same signal modulated an FM exciter and its occupied bandwidth was measured using the instrument described above. In most cases the measured data agreed with the calculated data to within 3 percent.

The setup used to gather the data presented here is shown in Figure 3.

The diagram is self-explanatory except to note that the Orban Associates 8000A is switched into "proof" mode to operate as a stereo generator only when fed from the Audimax and Volumax.

Modulation levels were set when using the Belar FMM-2 monitor by adjusting the modulation so that between 1 and 3 peak indications per minute were noted during the test selection.

A similar procedure was followed when the level was set using the Mod-Minder. The Peak Threshold was set to the desired modulation.

The modulation level was then adjusted for from 1 to 3 occurrences per rolling minute. The highest peak modulation was recorded as well as the over-modulation count.

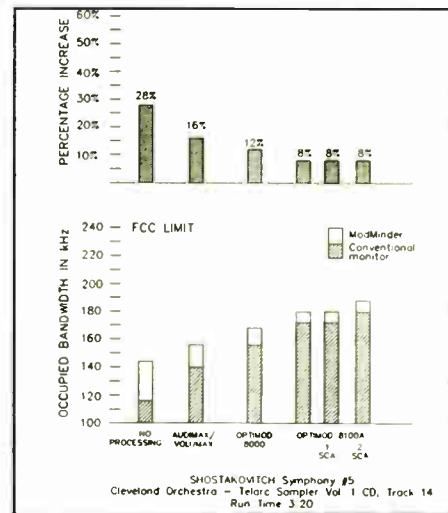

references relevant to the information presented here which space considerations prevent me from including. They are included in my full paper.

For a copy of the full paper call Modulation Sciences at 800-826-2603.

Eric Small is VP Engineering of Modulation Associates.

GET IT RIGHT
GET IT FROM ALLIED

Market Share Generator

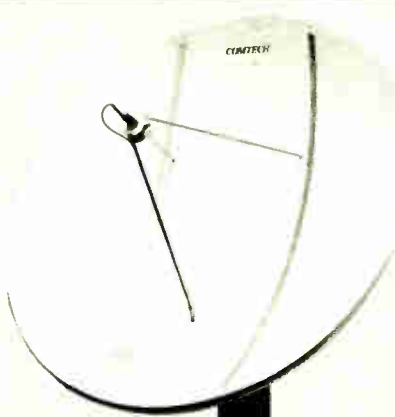

COMTECH
3.8 Meter
Antenna



MICRODYNE
1100-FFC-X1 RDC(L)
SCPC Satellite Downlink Receiver



MICRODYNE
1100 PCDR-5
SCPC Demodulator

Leading stations all over the nation are adding market share by providing the information and entertainment their audience wants. With over 75 radio networks available via satellite, programs are available to boost your market share. Most sports-nets, state news-nets, and agri-nets are available through SCPC audio satellite.

Microdyne SCPC downconverters are the industry standard—none better for less. Microdyne PCDR-5 demodulators are feature-

loaded...more standard features than others offer as options! To complete the package, Allied recommends the Comtech 3.8M high performance satellite antennas.

Improving market share... audio satellite from Allied satellite. The best is at Allied, the rest gets what's left.



HARRIS ALLIED
SATELLITE EQUIPMENT

317-962-8596

3712 NATIONAL RO. WEST • P.O. BOX 1487 • RICHMOND, IN 47375

©HARRIS/ALLIED 1990



AS-101 Audio Switcher

10 stereo in
1 stereo out

- Illuminated and legendable control buttons
- Instant or overlap switching
- Front panel accessible level controls
- Options include: RS-232 interface, remote control, relay-follow-switch outputs
- Network proven quality and reliability!

P.O. Box 1342 Bellingham, WA 98227
(206) 734-4323 (206) 676-4822 (FAX)

Conex Electro-Systems, Inc

"Call me, I'm interested." Circle 51.

"Send me literature." Circle 4.

Circle 77 On Reader Service Card

HE SAID,  "You can write almost anything you want about this machine and put my name under it." SO WE DID.

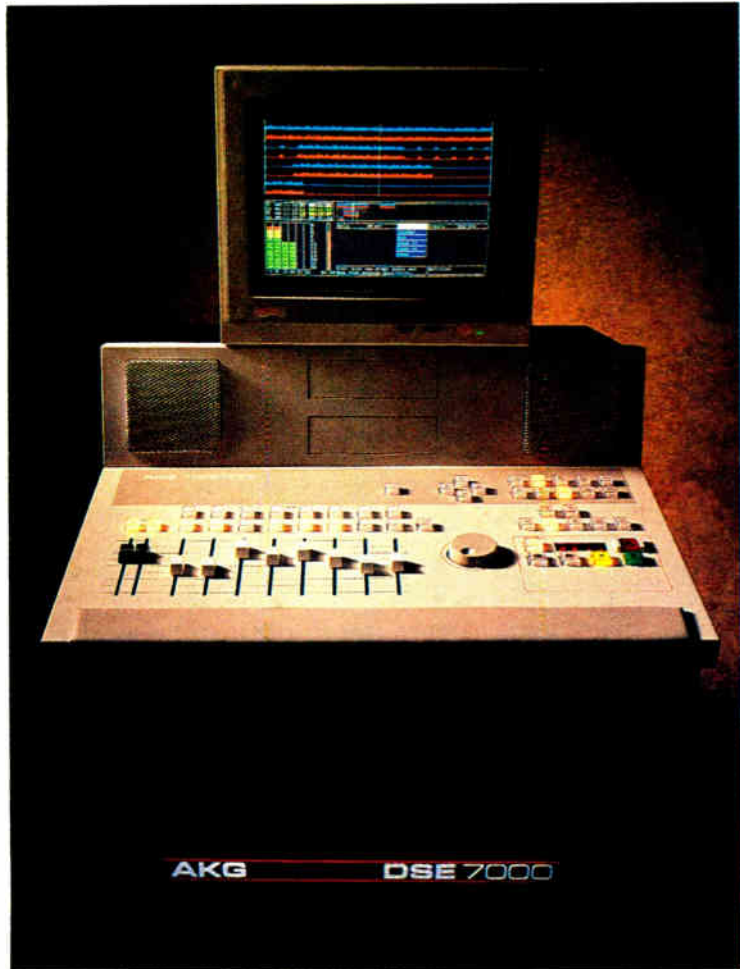

THE DIGITAL SOUND EDITOR. STATIONS FROM BOSTON TO SAN DIEGO ARE MAKING IT THE HOTTEST BOX IN RADIO.

Dan McCoy was the first production director in radio to use the DSE 7000, and he saw it revolutionize the way production is done at WZOU-FM,  one of the top stations in Boston. A spot that used to take an hour to produce now takes 20 minutes. Without tape. Without razors. Without a single dB of generation loss. Even agency dubs now go right to the DSE for levels, sound enhancement



and tags; then onto carts. Creativity has exploded, too. With the DSE's instant UNDO feature, the fear of trying new things is gone. You simply try another take, assemble a different edit, or test a new effect. If you don't like the results, UNDO it instantly. No wonder WZOU has designed their production facility around the DSE.  And no wonder Dan McCoy calls this machine "the most impressive thing that's ever happened to radio." His words, not ours.



1525 ALVARADO STREET, SAN LEANDRO, CALIFORNIA 94577, USA. (415) 351-3500. FAX: (415) 351-0500



DSE 7000 • THE NEW SPEED OF SOUND



Broadcast Equipment Exchange®

"Broadcast Equipment Exchange" accepts no responsibility for the condition of the equipment listed or for the specifics of transactions made between buyers and sellers.

AMPLIFIERS

Want to Sell

Ampro TP-5 TT preamps (2), (3) Sparta Tep 35, (2) Shure M64, all worked when removed from service. \$50/ea/BO. M Black, Hobart William Smith College, Geneva NY 14456. 315-781-3456.

Nakamichi 620 audiophile pwr amp 100 Wchln, mint cond, w/circuit documentation, \$350. K Heyne, 415-664-0163.

Crown PSA-2 500 W stereo power amp, rack mgnt, excel cond, \$650/BO. W Laughlin, 753 Ruth Ln, Hurst TX 76053.

Crown IC-150 pro stereo preamp, rack mountable, excel cond, \$125. W Laughlin, 753 Ruth Ln, Hurst TX 76053.

Macintosh MC40 mono tube amps (2), excel cond, \$1000/BO. J Zelinger, 4401 Sunset Blvd, Los Angeles CA 90027. 213-667-9310.

Dynakit Stereo 70 gd tubes \$100/BO or swap for MKIII w/70 V out or MKIV; also PAS preamp, \$35/BO or swap. K Smith, Box 579, Gorham ME 04038. 207-854-3079.

Opamp Labs 360 BM mic preamps (8) plus additional line amps & mono amps, \$25/ea/BO. J Zelinger, 4401 Sunset Blvd, Los Angeles CA 90027. 213-667-9310.

LEL DA-8 dist amp, never used, \$125; Gates Courier 70 2-chnl remote amp w/AC pwr supply, needs work; Gates Attache 70 3-chnl remote amp w/AC pwr supply, needs work. L Wilson, 409 Hillaire, Hopkinsville KY 42240. 502-866-1678.

Amps including Hafner DH500, Macintosh 250, API 705, Yamaha M40, SCS 2350, Soundcraftsman A2801 & Sunn Concert, call for details & prices. E Boucher, EAB Recdg, POB 958, Lewiston ME 04243. 207-786-3476.

Scott 121-C preamp, mono, mint cond, minor input modification, \$75. B Leslie, Pro Recording Svcs, 13709 Maple Leaf Dr, Cleveland OH 44125. 216-662-1435.

Telex MC Series record amps (2), mono. M Young, WJON, St Cloud MN. 612-251-4422.

McIntosh MC-2500, sealed, BO; MC-240 (2), \$1175; MC-40 (4), MC-225 (2), \$575 ea. R Katz, Allegro Snd, 15015 Ventura, Sherman Oaks CA 91403. 818-377-5264.

Crest P3500 power amp, 400 Wch at 4 ohms, 2 spaces, \$675. R McMillen, 3235 SE 39th, Portland OR 97202. 503-239-6070.

Crown power amps DC-300 (2), \$450; DC-300 II (2), \$490; PS-400 (2), \$650, all in excel cond. P Mobley, 300 Main St, Brookings SD 57006. 605-697-5326.

Bogen 30 W stereo tube type integrated amp, vgc, no case, \$75. M Saady, First City Recd, 141-60 84 Rd, 3E, Briarwood NY 11435. 718-846-2062.

Want to Buy

Tube amps, all models preamps & amps by Marantz, D DeForest, 7441 Wayne Ave 10-D, Miami Bch FL 33141.

Tube amps & remote mixers incl RCA OP-6, OP-7, BN-2 BA series, 80 series, etc. W Davies, 5548 Elmer Ave, N Hollywood CA 91601. 818-761-9831.

RCA, WE & Altec tube amps, mixers, mic's, turntables & recorders. R VanDyke, 2 Squires Ave, E Quogue NY 11942. 516-728-1327.

WE, Marantz, Fairchild, Westrex, etc, amps, preamps, signal processors w/vacuum tube electr. D deForrest, 7441 Wayne, Ste 10-0, Miami Bch FL 33141. 305-866-5401.

Scully '100' recorders, record/play amplifiers, 8, 16, 24 track heads. Sequoia Electronics, 1131 Virginia Ave, Campbell CA 95008. 408-866-8434.

ANTENNAS & TOWERS

Want to Sell

ERI FMC-10 recently removed, 10 bay on 101.1 MHz, BO. M Cooney, 610 N Kiwanis, Sioux Falls SD 57104. 605-336-2706.

Phelps Dodge 3 bay at 105.5 MHz w/radomes, \$1300. R Martin, Box 5668, Colorado Springs CO 80931. 719-392-4219.

Phelps Dodge CFM LP-2 2 bay FM 94.5, complete, ready to ship; dummy load 50 kW RCA type 6000 & coax reducer, 3 1/8 to 4 1/16 w/gas pass & blocking rings, BO. L VanDam, WUPQ, Newberry Ave, Newberry MI 49868. 906-293-8522.

Rigid line 3 1/8", 440', 20' sections, some hangers & 90° sections, \$4000. C Haynes, 1850 Lynch, Jackson MS 39203. 601-948-1515.

LeBlanc & Dick tower 1329', 7' face, designed for 2 TV & 5 FM ant's w/comm level at 1100' that will support 12 bays, wind load 65lbs/ft² 2 RS 222 specs includes EEG high intensity strobes & red lighting, right light contactor & strobe status controller included, BO. M Fields, 6760 Corporate Dr #340, Colorado Springs CO 80919. 719-548-1528.

Rohn 14" face, 200', on ground, \$500; Jampro JLPC 3 bay 98.3, \$600; Andrews 1 5/8" air dielectric, 200', \$800. D Crisp, Box 1280, Sealord DE 19973. 302-629-6636.

Hughes & Phillips T1-2035 3500 W isolation transformer, 115/230 V primary, 117/120 V secondary, \$900. N Winter, 210 W Cota, Shelton WA 98584. 206-473-3462.

Cablewave FCC15850J air dielectric cable, 320' of 1 5/8", in gd cond, have connectors to sell w/cable, on spool & in easily accessible location for pick up, \$800/FOB. D Rozek, 475 South Ave, Beacon NY 12508. 914-831-8000.

FM ANTENNAS

1 BAY	\$1,500
2 BAY	2,300
3 BAY	3,150
4 BAY	4,000

MORE BAYS AVAILABLE
All warranted, tuned
and tested

ARMSTRONG TRANSMITTER CORP.
5046 Smoral Road (315) 488-1269
Syracuse, NY FAX (315) 488-1365

Shively 4-bay w/radomes, tuned to 103.1, 3 yrs old, perfect cond, \$1400/BO. T Cranford, FM97, POB 1465, Grand Island NE 68802. 308-381-3697.

Celwave LP FM 3 bay antenna, in service, ready for sale, tuned to 92.1 MHz, BO. K Diebel, 1207 Louisa, Rayville LA 71269. 318-728-4915.

Jampro JSCP antenna bays (5), no heaters, gd cond, orig 105.9 MHz, also inter-bay line avail, \$1000 ea/BO. G Ogonowski, 213-465-3171.

FM antenna, 500', 12 bay wide-icers, 98.7 MHz, 4 bay FM, 95.1 MHz. J Stevens, WLAU, 601-649-1840.

Custom made 900 MHz & 450 MHz STL's, all yagi's new & used. J Woodell, 1412 Mohave, Parker AZ 85341. 602-669-2483.

Shively 6810 10 bay, high power, tuned to 101.1 MHz, 2.5 yrs old, vgc, \$10,000/BO. A Baxa, WAVV, 11800 Tamiami Tr E, Naples FL 33962. 813-775-9288.

Scala HDCA-10EB yagi antennas, 75 ohm, 104.1 & 106.9 MHz. D Leinen, Independent Resources, POB 23498, Oklahoma City OK 73213. 405-728-2525.

Phelps Dodge CP 2 2 bay CP, 100.9 MHz, gd cond, \$1000. A McCarthy, KUIC, Fax: 707-446-0122.

Cablewave HCC 158 1-5/8" coax, 75', no connectors, \$8/foot. R Biever, KDOM, 1450 N Highway 60, Windom MN 56101. 507-831-3908.

RCA 10 bay tuned to 92.9, approx 900' of 4" coax, both on ground ready to ship, will sell separately, \$12,000/BO. M O'Brien, KTGL, 3201 Pioneers Blvd Ste 208, Lincoln NE 68502. 402-483-6814.

Phelps Dodge CP-1000-4 4-bay, circular, 102.3, all connectors, just removed, freq change. T Donnelly, KRJH, 111 N Main, Hallettsville TX 77964. 512-798-4333.

Cablewave 750' 5" heliax, spooled. D Bischoff, KKCW, 12655 SW Center, Beaverton OR 97005. 503-643-5103.

Rohn 65G 300', 3 yrs old, guys, bolts, beacon, side lights, on ground in 20' sections ready for shipping, \$12,000. M Blakemore, WCVP, Peachtree Central, Murphy NC 28906. 704-837-2218.

Rohn 65G 90' in 4-20' sections & one 10', complete w/guy wire, insulators, bolts, anchors, will sell or trade for self-supporting tower. C Freinwald, KBSG, 1739 Minor, Seattle WA 98101. 206-343-9700.

Jampro 7 bay FM, JLPC-71063 MHz, pwr gain 3.65, documentation, 200' of 1-5/8" Prodelin Spiruline w/EIA connectors, \$4900/all. B Dickerson, WEAG, Starke FL 32091. 904-964-5001.

Comark 4-bay horizontal, tuned to educ band, gain 3.8, power input up to 1 kW, gd cond, \$1800. R Franklin, Super Snd Sids, 211 Virginia, Norristown PA 19401. 215-277-7112.

Magnum 24" x 150' w/guys & (3) fiberglass insulators, BO. S Hess, KDUC, 29000 Radio Rd, Barstow CA. 619-256-2121.

Phelps Dodge 3 bay CP FM tuned to 99.3 MHz, \$1200 plus shpg; Jampro single bay CP FM, tuned to 99.3 MHz, \$400 plus shpg. B Downs, KISX, Box 131869, Tyler TX 75713. 214-593-4444.

CAPACITORS OVERNIGHT

- Power Supply computer grade: up to 450VDC
- Transmitting - MICA Sangamo, Cornell-Dubilier
- Oil Filled Non-PCB Oval, Rectangular

Relays - Filters - Transistors
Any Parts starting with 1N or 2N

1-800-323-0460

FAX 1-802-425-3644
Kellner Electronics, Inc.
Charlotte, VT 05445

Hellax, 6" elliptical waveguide in various lengths, 100' lengths, some up to 200', BO. K Diebel, KTJC, 1207 Louisa, Rayville LA 71269. 318-728-4915.

Phelps-Dodge 3-bay Class A, 107.1 MHz, gd cond, \$1500; Heliax 1-5/8" approx 90' w/flange connectors. B King, KLBW, 500 Leland, Austin TX 78704. 512-832-4061.

ERI/Harris FMH&E 6-bay high pwr FM Rototiller tuned to 94.9 MHz, \$6000. W Boller, WGIL, 154 E Simmons, Galesburg IL 61401. 309-342-5131.

ERI FMC-3E 3 bays on 95.9, working when removed for pwr increase, \$1000. R LaFore, WQPW, POB 1327, Valdosta GA 31603. 912-244-8642.

ERI 4 bay CP FM wideicers, rebuilt recently by ERI on 95.3, for sale due to upgrade, \$2500. E Moody, KJEM, 216 N Main, Bentonville AR 72712. 501-273-9039.

ERI G4CPH-10, 10 bay CP tuned to 96.1 MHz; Jampro Penetrator 10 bay CP tuned to 93.1 MHz, both in gd cond & avail now in Eugene OR, call for price on both systems. C Murray, KMGE, 503-484-9400 or R Sparks Scott, KSND, 503-686-9125.

Antenna 92.1, exciter, Optimod 8100A, 1-5/8" coax, Schafer 903E, 5 kW trans & other equip for new KITE FM in Kerrville TX. R Whitlock, 512-792-4560.

Scala CA-4V 2-bay w/(2) CA-2 antennas & matching harness for vertical polarization spacing, tuned low-band group, original 92.1 MHz, 50 ohms ea bay, 50 ohms harness input, gd cond, \$450/complete. TX Valley Translator, 6903 Spring Garden, San Antonio TX 78249. 512-696-5615.

Andrew 7/8" foam LFD5-50A, 175'/\$450, 275'/\$750; Andrew 1/2" foam LFD4-50A, 300'/\$300, 330'/\$325. E Burkhardt, WLEE, 121 Wyck, Ste 300, Richmond VA 23225. 804-232-0300.

Phelps Dodge ECFM-2 w/radomes 92.1, BO; Phelps Dodge ECFM-2 94.3, BO; Phelps Dodge ECFM-2 98.3, BO. Howells Audio, POB 6184, Kingman AZ 86402. 602-753-4915.

Gates/ERI Cycloid 3-bay, circularly-polarized w/input & interbay sections & de-icers, tuned to 95.3 MHz, BO. F Weller, KVNU, POB 267, Logan UT 84321. 801-752-5141.

Scala FMO-4 4-bay, plus pwr divider & coax cables, \$550. S Lawson, KAK Prod, 928 Hyland, Santa Rosa CA 95404. 707-528-4055.

RCA TFU 30J Pylon antennas, one for ch 19, one for ch 46, both are down & ready to go, \$25,000 ea or will consider exchange for production equipment or up & running used 60K on ch 19; need TBCs, VTRs & more powerful xmtr, are small market Christian UHF TV station. J McFarland, WLCN, 27 Grapevine, Madisonville KY 42331. 502-821-5433.

1 5/8" line 90 degree elbow, w/EIA flanges, \$75. N Beaty, 2116 Osman Lane, Greenfield IN 46140. 317-326-3620.

Harris/ERI FML-3E 3 bay CP FM on 99.3 MHz; 370' Andrew HJ7-50A 1-5/8" transmission line, both less than 3 yrs old, avail in June. T Stine, KTXI, 106 Farrar, Cape Girardeau MO 63701. 314-335-9099.

Swap 500' of Rohn 45 tower for 500' of Rohn 80 tower or other tower that will stack 500' high. BO, will pay cash for difference. K Diebel, KTJC, 1207 Louise St, Rayville LA 71269.

Want to Buy

Tower, 350' & CP FM high pwr antenna on 93.3 or near by freq. E Moody, KJEM, 216 N Main, Bentonville AR 72712. 501-273-9039.

Class A 3-bay on 98.9 plus or 2 chnl; also need a 10 kW FM xmtr in gd cond w/ 6-bay antenna on 98.9 MHz. J Maxton, KGGF, POB 1087, Coffeyville KS 67337. 316-251-3800.

Self-supporting tower, 100'; ERI 2-bay rototiller, low pwr antenna. E Sutton, WOKI, 1900 Winston, Knoxville TN 37919. 615-531-2000.

High power circular 8 bay FM antenna at or near 107.7 MHz, also 3" line & fittings. T Smith, KXXM, Box 340, Pendleton OR 97801. 503-276-1511.

Rigid transmission line, 400' of 3.125". J Coursole, WGGQ, 414-324-4441.

2 or 3 Bay tuneable to 96.3, radomes. L Maierhofer, 101 Armory Blvd, Lewisburg PA 17837. 717-523-3271.

Coaxial switch, 4 port 1-5/8" EIA flange, needs to be automatic type in gd working order; also need any type 87R 1-5/8" flange or equiv. JP Connor, WSBY, Salisbury MD 21801. 301-742-5191.

24" face, 400' tower, also need coax. E Moody, KJEM, 216 N Main, Bentonville AR 72712. 501-273-9039.

Air-dielectric cable, (2) 200' sections of 1-5/8", 500' of 7/8" used Heliax or other low loss cable. K Diebel, KTJC, 1207 Louise St, Rayville LA 71269.

AUDIO PRODUCTION

Want to Sell

Lexicon 1200 mono, audio time compressor/expander, excel cond, \$700/BO. J Zelinger, 4401 Sunset Blvd, Los Angeles CA 90027. 213-667-9310.

AKG BX 20E reverb w/remote, excel cond w/swap 2nd unit for pts, custom modified for smoother decay, \$250. K Heyne, 415-664-0163.

Tascam PE-40 4 band, 4 chnl parametric EQ unused, \$250. D Lerner, 115 W 23rd, New York NY 10011. 212-463-0795.

Low power AM medium wave radio station complete w/McMartin audio console; (2) Spotmaster PB cart machines; Ampex tape reproducer; Shure mic mixer; TT's, mics, speakers and much more, all equip is ready for broadcast service, buyer must supply own shipping & handling (negotiable), all equipment must be sold by June 1990, \$9000 negotiable. A Krasowski, 1196 Tivoli Dr, Deltona FL 32725. 407-860-1219.

Do you have an upcoming remote? We now have available for rental:
2-LINE COMREX
WIRELESS MIC • PORTABLE DAT
plus much more, at reasonable rates!
Silver Lake Audio
2590 Hillside Ct, Baldwin, NY 11510
(516) 623-6114

Ramko DA280 10x8 dist amp in rack mount w/pwr supply, \$400/BO. J Zelinger, 4401 Sunset Blvd, Los Angeles CA 90027. 213-667-9310.

Harris ME-1 modulation enhancer, rack mount w/manual, \$125. L LeBlanc, WKXL, POB 675, Concord NH 03301. 603-225-5521.

Orban 111B stereo reverb, brand new, BO. R Sundell, POB 734, Upland CA 91786. 714-985-0701.

Rane ME-15 stereo 2/3 octave graphic EQ, new cond, \$250. M Osborne, WKSQ, POB 9494, Ellsworth ME 04605. 207-667-7573.

Outboard processing equip including dbx 187, Yamaha R1000, Eventide PS-101, Quad-B N8-120, Orban 111B, Deltagraph EQ-10, Furman LC3, Immedia BB23B, Altec A322C, Gates SA-398 & Eventide 1745, call for details & prices. E Boucher, EAB Recdg, POB 958, Lewiston ME 04243. 207-786-3476.

NORTRONICS Replacement Tape Heads

Test Tapes, Degaussers, Gauges
Cleaners, Swabs, Lapping Films
Splice Bars/Tabs, Demagnetizers

SEQUOIA ELECTRONICS

1131 Virginia Ave
Campbell CA 95008
(408) 866-8434

ART DR1 digital reverb w/remote, MIDI. S Wytas, 165 Linden, New Britain CT 06051. 203-224-1811.

Eventide H-949 harmonizer, changes pitch & has prod effects built-in, \$2250. W Waldron, KSOS, Layton Hills Mall, Layton UT 84041. 801-546-1722.

Shure M63 EQ, filter, \$50. M Maciejewski, WMUS, 3565 Green St, Muskegon MI 49441. 616-744-1671.

Various pieces of equip including ITC RP R/P cart machine; (2) 47" equip racks; 5 element Yagi antenna; (3) Switchcraft 96 jack patch panels; SMC 521 PB cart; MCI JH-110 & (3) Ampex AG600B R-R's; (5) RCA BFC antenna bays w/radomes; Heath GC1000 most accurate clock; (2) Marti RPT1/150K xmtrs; Scala PR-450U paraflector. M Young, WJON, St Cloud MN. 612-251-4422.

Dolby 361 A NR (2), \$450/ea plus shipping. M Holwin, Anamnesia Studios, 49 S Oxford, Brooklyn NY 11217. 718-852-7630.

Shure M610 graphic mic EQ, \$75. M Maciejewski, WMUS, 3565 Green St, Muskegon MI 49441. 616-744-1671.

Orban 674A stereo para-graphic EQ, \$575. M Maciejewski, WMUS, 3565 Green St, Muskegon MI 49441. 616-744-1671.

Audio Digital TC 2 DDL digital delay/effects, 18K bandwidth, 2.25 second extended memory, 2 outputs, \$575/BO; Dolby 361 A type NR SR ready, \$1475/pr; Scamp mini rack, studio outboard gear w/F300S expander/gate, S01 compressor, S04 parametric EQ, S23 stereo autopanner, Arvil case, pwr supply, TT patch-bay, \$800/BO. R McMillen, 3235 SE 39th, Portland OR 97202. 503-239-6070.

Sony PCM 701, \$1000; Lexicon 200, \$2000; Scully 280B, \$1300; Shure EQ's & room analyzers. D Kocher, DLK Snd Sid, 1901 Hanover, Allentown PA 18103. 215-432-0520.

UREI 575A 1/3 octave mono, \$350; AKG 1291E1 stereo echo, \$300; Inovonics 375 mono electronics, \$200; ITC 854 mono electronics, \$150; ESE 112LS slaves, \$40/ea. E Burkhardt, WLEE, 121 Wyck, Ste 300, Richmond VA 23225. 804-232-0300.

CAPTURE IT ALL!

Introducing the new Shure VP88 Stereo Condenser Microphone that provides broadcast quality stereo from remote locations at a surprisingly affordable price. It's made for the field...rugged...durable... easy to use...made to capture it all!



FREE T-SHIRT: 1-800-356-5844

Free T-shirt with every Shure microphone and mixer purchased.

HURRY! QUANTITIES LIMITED.

Prices Too Low To Print. Call us on it.



Where You Find the True Meaning of Discount

Consultation 608-271-1100 • 5618 Odana Rd. • Madison, WI 53719

Used, Demo, Returns, Trade-in, Overstock, Scratch and Dent— Limited Quantity, First Come, First Served
Terms: Payment with Order

AKG D1200E MIC	\$125
AKG D190ES MIC	85
ATI P1000-1 PREAMP	295
ATI DA2016 DIST AMP	975
BARCUS BARRY 202a PROCESSOR	295
BENCHMARK DA 101 DIST AMP	250
BENCHMARK mda101 DIST AMP	275
CRL SGC-800 STEREO LIMITER	1400
EV SENTRY 100A SPEAKERS	195

EV PL10 MIC	150
EV PL20 MIC	354
EV RE15 MIC	225

JBL 4312 SPEAKER	225
JBL 4401 SPEAKER	115
LUXO COPY STAND	55

MARSHALL TELETYPE	100
MICROTRAK 10P	95
MICROTRAK TELEFILE	125
MOD SCI CP-803 COMP PROC	1025
MOD SCI SCA 186 SCA GEN	2800

MOD SCI MODMINDER	2155
MOSELEY ISL-3A ISOCOUPLER	275
OMNIMOUNT 101-SWA	37

OTARI MK9000 MIXER	9000
OTARI CTM 10 CARTRIDGE PLAYER	1850
OTARI CB109 REMOTE CONTROL	1225

OTARI MK9000 TAPE PLAYER	800
RADIO SYSTEMS DA-8 AMP	275
REVOX B77 TAPE RECORDER	1895
REVOX PR99 R/R ROLL AROUND STAND	350

RUSSCO STUDIO PRO TT	325
SANSUI CDX701 CD	410
SANSUI CDX711 CD	695
SHURE SM7 MIC	350
SHURE 588 DEMO MIC	144

SONY PCM200 DAT RECORDER	6000
SONY CD5 PROII CASSETTE RECORDER	650
SONY TCD-D10PRO PORTABLE DAT RECORDER	2200
SONY C48 MIC	700
STRAIGHT WIRE AUDIO DA CARDS 195.10 PWR SUPPLY	40
TAPCO 4400A REVERB	125

TASCAM 1424 CASSETTE RECORDER	500
TECHNICS SP 15 TT	490
TECHNICS SP10MKII TT	795
TECHNICS SLP 550 CD	195
TECHNICS SLP1200 CD	935
TECHNICS SLP 1000 CD	1000
TECHNICS SLP 800 CD	800
TECHNICS SLP 600 CD	400

TECHNICS 600W SPEAKER	800
TECHNICS 600W CD PLAYER	350
TECHNICS SL1200MKII TT	340
TELETYPE WIRELESS MIC EMP-2	600
TELEX PH75 HEADSET	85
UREI SR1 RACK MOUNT	20

SONY CD5 PROII CASSETTE RECORDER	650
SONY TCD-D10PRO PORTABLE DAT RECORDER	2200
SONY C48 MIC	700
STRAIGHT WIRE AUDIO DA CARDS 195.10 PWR SUPPLY	40
TAPCO 4400A REVERB	125

TASCAM 1424 CASSETTE RECORDER	500
TECHNICS SP 15 TT	490
TECHNICS SP10MKII TT	795
TECHNICS SLP 550 CD	195
TECHNICS SLP1200 CD	935
TECHNICS SLP 1000 CD	1000
TECHNICS SLP 800 CD	800
TECHNICS SLP 600 CD	400

TECHNICS 600W SPEAKER	800
TECHNICS 600W CD PLAYER	350
TECHNICS SL1200MKII TT	340
TELETYPE WIRELESS MIC EMP-2	600
TELEX PH75 HEADSET	85
UREI SR1 RACK MOUNT	20

SONY CD5 PROII CASSETTE RECORDER	650
SONY TCD-D10PRO PORTABLE DAT RECORDER	2200
SONY C48 MIC	700
STRAIGHT WIRE AUDIO DA CARDS 195.10 PWR SUPPLY	40
TAPCO 4400A REVERB	125

TASCAM 1424 CASSETTE RECORDER	500
TECHNICS SP 15 TT	490
TECHNICS SP10MKII TT	795
TECHNICS SLP 550 CD	195
TECHNICS SLP1200 CD	935
TECHNICS SLP 1000 CD	1000
TECHNICS SLP 800 CD	800
TECHNICS SLP 600 CD	400

TECHNICS 600W SPEAKER	800
TECHNICS 600W CD PLAYER	350
TECHNICS SL1200MKII TT	340
TELETYPE WIRELESS MIC EMP-2	600
TELEX PH75 HEADSET	85
UREI SR1 RACK MOUNT	20

SONY CD5 PROII CASSETTE RECORDER	650
SONY TCD-D10PRO PORTABLE DAT RECORDER	2200
SONY C48 MIC	700
STRAIGHT WIRE AUDIO DA CARDS 195.10 PWR SUPPLY	40
TAPCO 4400A REVERB	125

TASCAM 1424 CASSETTE RECORDER	500
TECHNICS SP 15 TT	490
TECHNICS SP10MKII TT	795
TECHNICS SLP 550 CD	195
TECHNICS SLP1200 CD	935
TECHNICS SLP 1000 CD	1000
TECHNICS SLP 800 CD	800
TECHNICS SLP 600 CD	400

TECHNICS 600W SPEAKER	800
TECHNICS 600W CD PLAYER	350
TECHNICS SL1200MKII TT	340
TELETYPE WIRELESS MIC EMP-2	600
TELEX PH75 HEADSET	85
UREI SR1 RACK MOUNT	20

SONY CD5 PROII CASSETTE RECORDER	650
SONY TCD-D10PRO PORTABLE DAT RECORDER	2200
SONY C48 MIC	700
STRAIGHT WIRE AUDIO DA CARDS 195.10 PWR SUPPLY	40
TAPCO 4400A REVERB	125

TASCAM 1424 CASSETTE RECORDER	500
TECHNICS SP 15 TT	490
TECHNICS SP10MKII TT	795
TECHNICS SLP 550 CD	195
TECHNICS SLP1200 CD	935
TECHNICS SLP 1000 CD	1000
TECHNICS SLP 800 CD	800
TECHNICS SLP 600 CD	400

TECHNICS 600W SPEAKER	800
TECHNICS 600W CD PLAYER	350
TECHNICS SL1200MKII TT	340
TELETYPE WIRELESS MIC EMP-2	600
TELEX PH75 HEADSET	85
UREI SR1 RACK MOUNT	20

SONY CD5 PROII CASSETTE RECORDER	650
SONY TCD-D10PRO PORTABLE DAT RECORDER	2200
SONY C48 MIC	700
STRAIGHT WIRE AUDIO DA CARDS 195.10 PWR SUPPLY	40
TAPCO 4400A REVERB	125

TASCAM 1424 CASSETTE RECORDER	500
TECHNICS SP 15 TT	490
TECHNICS SP10MKII TT	795
TECHNICS SLP 550 CD	195
TECHNICS SLP1200 CD	935
TECHNICS SLP 1000 CD	1000
TECHNICS SLP 800 CD	800
TECHNICS SLP 600 CD	400

TECHNICS 600W SPEAKER	800
TECHNICS 600W CD PLAYER	350
TECHNICS SL1200MKII TT	340
TELETYPE WIRELESS MIC EMP-2	600
TELEX PH75 HEADSET	85
UREI SR1 RACK MOUNT	20

SONY CD5 PROII CASSETTE RECORDER	650
SONY TCD-D10PRO PORTABLE DAT RECORDER	2200
SONY C48 MIC	700
STRAIGHT WIRE AUDIO DA CARDS 195.10 PWR SUPPLY	40
TAPCO 4400A REVERB	125

TASCAM 1424 CASSETTE RECORDER	500
TECHNICS SP 15 TT	490
TECHNICS SP10MKII TT	795
TECHNICS SLP 550 CD	195
TECHNICS SLP1200 CD	935
TECHNICS SLP 1000 CD	1000
TECHNICS SLP 800 CD	800
TECHNICS SLP 600 CD	400

TECHNICS 600W SPEAKER	800
TECHNICS 600W CD PLAYER	350
TECHNICS SL1200MKII TT	340
TELETYPE WIRELESS MIC EMP-2	600
TELEX PH75 HEADSET	85
UREI SR1 RACK MOUNT	20

SONY CD5 PROII CASSETTE RECORDER	650
SONY TCD-D10PRO PORTABLE DAT RECORDER	2200
SONY C48 MIC	700
STRAIGHT WIRE AUDIO DA CARDS 195.10 PWR SUPPLY	40
TAPCO 4400A REVERB	125

TASCAM 1424 CASSETTE RECORDER	500
TECHNICS SP 15 TT	490
TECHNICS SP10MKII TT	795
TECHNICS SLP 550 CD	195
TECHNICS SLP1200 CD	935
TECHNICS SLP 1000 CD	1000
TECHNICS SLP 800 CD	800
TECHNICS SLP 600 CD	400

TECHNICS 600W SPEAKER	800
TECHNICS 600W CD PLAYER	350
TECHNICS SL1200MKII TT	340
TELETYPE WIRELESS MIC EMP-2	600
TELEX PH75 HEADSET	85
UREI SR1 RACK MOUNT	20

SONY CD5 PROII CASSETTE RECORDER	650
SONY TCD-D10PRO PORTABLE DAT RECORDER	2200
SONY C48 MIC	700
STRAIGHT WIRE AUDIO DA CARDS 195.10 PWR SUPPLY	40
TAPCO 4400A REVERB	125

TASCAM 1424 CASSETTE RECORDER	500
TECHNICS SP 15 TT	490
TECHNICS SP10MKII TT	795
TECHNICS SLP 550 CD	195
TECHNICS SLP1200 CD	935
TECHNICS SLP 1000 CD	1000
TECHNICS SLP 800 CD	800
TECHNICS SLP 600 CD	400

Want to Buy

WE/RCA speakers, amps, mixers, mics, TT's, on-air lights, equip magazines, catalogs, manuals & any tube equip. R Van Dyke, Caffrey House, Squires Ave, E Quogue NY 11942. 516-728-1327.

WANTED DEAD OR ALIVE! PULTEC EQ'S

Fairchild & Teletronix Limiters; Neumann, Telefunken, AKG, RCA, & Schoeps microphones. Tube McIntosh or Marantz amps & pre-amps. Sontec, ITI, & Lang EQs. Neve or API equipment. Boxes of old tubes; Urei, Orban, United Audio, DBX, & other outboard gear. Ampex ATR102s or 104s. Parts for MCI JH110/114 recorders. Altec 604s/crossovers/Tannoy speakers. JBL 2231; Altec 288h drivers; Misc. equipment of all types.

Please Call:
 Dan Alexander Audio
 2944 San Pablo Ave.
 Berkeley, CA 94702
 1-(415) 644-2363
 FAX: 1-415-644-1848

Digital delay unit for talk format or combo digital delay & production unit. A Roycroft, POB 1602, Hilo HI 96720. 808-935-6858.

Marshall Electronics AR-300 tape eliminator all analog tape delay simulator. A Greystory, 3003 20th, San Francisco CA 94110. 415-285-1953.

AUTOMATION EQUIP

Want to Sell

IGM Basic A automation system, all or part, Audicord network delay, (5) Revox PR-99 PB's, (4) 24 cart Carousels, (3) Audicord cart PB's, logging, BO. C Gustafson, 590 W Maple, Kalamazoo MI 49008. 616-345-2101.

IGM EC Controller w/IGM 48 tray Instacart, gd cond, \$7000. B Croghan, KCEE/KWFM, POB 5886, Tucson AZ 85703. 602-623-7556.

Gates 25 Hz tone detector & R-R controller (3), \$75/ea. E Moody, 216 N Main, Bentonville AR GA 72712. 501-273-9039.

Harris System 90 brain, switcher & (2) IGM 42 tray Go-Carts, will sell together or in parts, BO. R LaFore, Box 1327, Valdosta GA 31603.

Wegener 1601 mainframe inc all audio, tone decoding & receive translating cards for SMN Starstation affiliates; Harris 6529 sat video rcvr, \$1300/BO. H Bundrick, 1115 Washington, Natchitoches LA 71457. 318-352-9696.

Cetec/Schafer 903E 19 sources & 4 random access sources & RAS manual control, program console, pwr supply & rack, missing memory otherwise complete, \$2000/BO. B Glenn, 11 S Benton, Kennewick WA 99336. 509-586-4165.

BE 1600S stereo sequencer, 16 event w/books; (2) SMC TACime announce control, BO. L VanDam, WUPQ, Newberry Ave, Newberry MI 49868. 906-293-8522.

Sono Mag DP-2, DS-20 (6) 350 stereo Carousels, (4) AR1000 Otari R-R, DS 20 switcher, DP2 brain w/upgrade card in gd cond, \$14,000. P Swint, 2620 Dogwood, Joplin MO 64801. 417-624-1310.

Sono-Mag SMC RP-1000 brain, DS-20 switcher, PDC-3A timer flag unit, pwr supply, TS-25 tone snesor, (4) Otari ARS-1000, (4) BE auto rewinds, (4) SMC 350-RSB Carousels, (3) racks w/doors, manuals, spare parts, \$14,000. D Denton, 405 E Norman, Montgomery City MO 63361. 314-564-2275.

Gates KSP10 & RA10 automation programmer, sub programmer, clock, source cards & cables, gd for parts, \$500. E Moody, 216 N Main, Bentonville AK 72712. 501-273-9039.

BE Control 16 totally computerized system w/network join, 4 reels (2), Otari fixed carts, (3) Carousels, remote start, gd cond, \$12000/BO. A Sulton, POB 1380, Moultrie GA 31776. 912-985-0960.

Sono-Mag RAS Pro, (4) 350RSB Carousels, racks, power supply, remote control, audio switcher, memory, clock, extender cards, spares for all, complete books, \$7K. D Duns-moor, KRRZ, 216 S Bdwy, Minot ND 58702. 701-852-4646.

IGM dual 25 Hz tone detector. H Kneller, 813-639-1112.

SMC DPI-C automation system complete, includes: (4) 350 RSB Carousels, (4) SMC/Otari R-R PB decks, SMC dual cart, single play deck, (4) matching equip racks, logging w/X-tel printer, digital programmer w/brain & remote encoder w/monitor, all manuals, D Kulbel, POB 886, Carroll, IA 51401. 712-792-4321.

ATC fade start unit w/manual, \$20; Gates ATC time announce control mdi TA w/manual, \$15; ATC 55A silence sensor w/manual, \$35. J Faasel, W64BG, 13549 Morse Rd, Pataskala OH 43062. 614-927-2592.

Sono-Mag Carousel, worked when removed from service, \$600/BO. A Lane, WEHB, POB 2892, Grand Rapids MI 49501. 616-451-9904.

Colorado Magnetics NS-200-B Transtar network switcher, mint cond, w/fanout board & instruction manual, \$600. N Allebaugh, WICE, 100 John St, Cumberland RI 02864. 401-725-9000.

Schafer 8000 automation controller, minicomputer w/CRT terminal, loggers, 3 rack cabinets, complete extra system for backup, \$1500/both plus spare parts; SMC Carousels if purchased w/Schafer 8000 (4), \$500 ea. G Gaskey, KWHQ, 261 Main, Ste 6, Weed CA 96094. 916-926-5946.

IGM 90 Cart 42 tray, \$1200/BO. R Maxwell, 114 S 4th St, Yakima WA 98901. 509-457-8115.

IGM 78 tray Go-Cart stereo bi-directional, BO. Howells Audio, POB 6184, Kingman AZ 86402. 602-753-5352.

SMC ESP2 w/remote controller, (4) Carousel 350's & (4) reels, \$7000/BO. J Flynt, WSGY, 200 John Howard Way, Tifton GA 31794. 912-382-1101.

SMC 352 RS Carousels (6), \$800 ea/BO plus shpg. B Downs, KISX, Box 131869, Tyler TX 75713. 214-593-4444.

SMC 12 chnl (2) rack automation w/(2) bi-directional Carousels, set up for satellite automation & complete w/DAS-12 audio switcher; MSP keyboard; (2) 721 twin carts; (2) 452 bi-directional Carousels; MSP 12 programmer; monitor, excel cond, 18 mos old, \$23,000/BO. J Hansen, KKSr, POB 699, St Cloud MN 56302. 612-253-9600.

Schafer 903 w/(3) Carousels, dual cart machine, network card for satellite, plus extras, \$6000. Tom, 509-522-9412.

Satellite automation unit, complete in roll around rack, w/(3) Carousels, 1000 event Sat-master programmer, wired into 19" rack 84" high, in use now, \$7500/BO. B Tolby, WMKO, Box 1129, Millen GA 30442. 912-982-5695.

Harris SC-90 brain/switcher, (2) IGM Go-Carts, (4) ITC 750 R-R decks, all in gd cond, BO. R LaFore, WQPW, POB 1327, Valdosta GA 31603. 912-244-8642.

Cetec/Schafer 902 1/2 2000 event; 3 Revox A-77, 2 Audiophile 2A; 3 equip racks, printer w/all cables, I/O cards & spare pts, avail in July, \$7800. B Spitzer, POB 460, Rapid City SD 57701. 605-343-6161.

SMC ESP-2 w/(4) Carousels, (2) SMC single play cart decks & (9) Otari reel PB units w/25 Hz sensors, \$31K. M Ball, KWKL, POB 650, Wichita KS 67201. 316-265-1065.

Broadcast Products 2000 event automation system w/all cables & spares, \$500/BO. R Maxwell, 114 S 4th St, Yakima WA 98901. 509-457-8115.

IGM Stereo Instacart 48 tray, \$4000/BO. R Maxwell, 114 S 4th St, Yakima WA 98901. 509-457-8115.

SMC 20 chnl (2) rack automation unit w/(3) 350 Carousels, twin cart unit & set up for satellite automation including DP-1 Brain, \$4500/BO. J Hansen, KKSr, POB 699, St Cloud MN 56302. 612-253-9600.

IGM Instacarts, one mono & one stereo, both 48 trays, \$300/both; Otari ARS-1000 R-R reproducer, near mint, w/25 Hz sensor, \$1000; Schafer Blue equip rack, \$100; IGM 12 tray Instacart, \$750. G Gaskey, KWHQ, 261 Main, Ste 6, Weed CA 96094. 916-926-5946.

Schafer 7000 Level 2 sys w/3 stereo Audiophiles & 2 add'l input cards, CRT terminal, logger, 3 racks, \$9000. V Argo, POB 2277, Missoula MT 59606. 406-728-5000.

BE SAT 16 w/4 racks, 2000 event memory, Go-Cart, (3) Carousels, (2) Instacarts, (2) monitor racks, keyboard, printer, used w/SMN. G Magill, WHPA, POB 464, Hollidaysburg PA 16648. 814-695-4441.

Harris 9002 automation system, 2 CRT terminals, racks, (4) Otari ARS-1000 R-R's, (2) IGM Go-Cart 24, spare parts, fully loaded, super clean, \$7500. G Gaskey, KWHQ, 261 Main, Ste 6, Weed CA 96094. 916-926-5946.

SMC Carousels (2) 250's, (1) 350, \$800/BO. R Maxwell, 114 S 4th St, Yakima WA 98901. 509-457-8115.

Otari ARS-1000 DC (4), \$800/ea, Persons programmer 3A, \$425, Conex CG-25 25 Hz tone generator, \$200, entire package for \$3500. S Sphegner, WCFY, 108 Beck Ln, Lafayette IN 4

CART MACH. . . WT B
ITC PB & record. S Jeffries, Hwy 14 East, Mankato MN 56001. 507-345-4537.

Erase/splice finder should be in gd cond, will consider unit in repair. B O'Connor, 4001 Brandywine St NW, Washington DC 20016. 202-364-3982.

ITC-SP & RP, must be in gd cond. E Stanley, Standey Bldg, Box 161X, Jeffersonville NY 12748. 914-482-3158.

CASSETTE & REEL-TO-REEL RECORDERS

Want to Sell

Scully 270 reproducers (2) stereo, gd cond, \$200/BO; Scully 270 reproducers (2), stereo, gd for parts, BO; Magnecord 1024 stereo (2), \$150ea/BO. R Fess, POB 250, Macomb IL 61455. 309-833-5561.

Revox PR-99 2 speed PD, excel cond, BO. K Diebel, 1207 Louisa, Rayville LA 71269. 318-728-4915.

Automation starter set ITC 770 PB (4), gd cond, \$700 ea or \$2400/all; ITC 770 R/PB w/custom rack, gd cond, \$1700, or all for \$4000. J Torsitano, KNIS, 6363 Hwy 50 E, Carson City NV 89701. 702-883-5647.

Sony PCM-F1 2 trk digital processor, 14 & 16 bit, A/C pwr supply, batteries, Kiwi case, excel cond, \$1500. S Rosenthal, 3145 Geary Blvd Ste 344, San Francisco CA 94118. 415-584-5614.

Otari MX-5050 B II (2), \$2000ea; Otari MX505 BQ, \$3000. C Monk, 1301 Atlantic, Atlantic City NJ 08401. 609-344-2020.

Ampex AG-440B 1" 8 trk multitrack, roll-around console, gd cond, BO. R Kaufman, POB 462247, Garland TX 75046. 214-271-7625.

3M M79 4 trk, 1/2" ATR, excel cond, w/resolver, \$750/BO. J Zelinger, 4401 Sunset Blvd, Los Angeles CA 90027. 213-667-9310.

ITC deck stereo 3 yrs old, gd cond, \$1350. J Arzuaga, POB 980, Quebradillas PR 00742. 609-895-2725.

Inovonics 375 (3) R/P elect, solid state for Ampex recorders, \$150ea/BO. J Zelinger, 4401 Sunset Blvd, Los Angeles CA 90027. 213-667-9310.

Fostex Model 80 8 trk, 7" R-R, 15 ips Dolby C, gd cond, \$1200. S Wytas, 165 Linden, New Britain CT 06051. 203-224-1811.

Scully 280 automation PB's, gd cond (2), \$750/both. B Watson, 1551 E Amar Rd, W Covina CA 91792. 714-949-6249.

Nagra IV-S sync pilot tone, 7" reel case, leather case, A/C pwr pack, handle, strap, excel cond, \$4800; Nagra QGB 10 1/2" reel adapter, excel cond, \$750. S Rosenthal, 3145 Geary Blvd Ste 344, San Francisco CA 94118. 415-584-5614.

Ruslang R-R roll around wood consoles (3), \$150ea. R Shroyer, 215 N 4th St, Yakima WA 98907.

Ampex 440C w/servo, 1/2 trk, roll around cabinet, vgc, \$1500. S Rosenthal, 3145 Geary Blvd Ste 344, San Francisco CA 94118. 415-584-5614.

Otari ARS 1000, (2) P/B decks, very little use, \$1200. A Baxa, WAVV, 11800 Tamiami Tr E., Naples FL 33962. 813-775-9266.

Ampex ATR-700 10", 2 trk, 7 1/2", 15 ips, \$995. B Mountjoy, POB 1240, Elizabethton TN 37644. 615-543-5349.

MCI JH-110 4 trk stereo w/remote gd cond (2), \$4000/ea or \$7000/both. B Watson, 1551 E Amar Rd, W Covina CA 91792. 714-949-6249.

Marantz C0207LP like new, 3 heads, \$165/BO. R Zimmer, 3055 N Tyndall, Tucson AZ 85719. 602-623-2933.

Ampex 602 FT gd cond, \$200. D Ibel, 2600 N Highway, Spencer IA 51301. 712-262-1240.

Fostex 4030/4035 external synch for any R-R w/remote, mint cond, \$1000. S Wytas, 165 Linden, New Britain CT 06051. 203-224-1811.

Ampex AG 350-2 PB elect, 3 3/4" - 7 1/2" speeds, \$350 inc shpg & manual, tube PB fully functional. G Meloon, 28 W Scribner, DuBois PA 15801. 814-371-1330.

Tascam 32, 2 trk 7 1/2-15 ips in excel cond, some head wear, \$500. R Smith, 3407 W Olive #108, Burbank CA 91505. 818-367-6335.

DEMO UNIT

Otari MX-5050 BQ2,
4 trk, 1/4" R-R,
current model, \$2295.
804-974-6466

Nagra IV LE FT portable, 7.50 ips w/crystal sync & resolver, case, ATN pwr supply & manual, recently overhauled, \$2800/BO. R Barwig, Barwig Recording, 5254 W Agatite, Chicago IL 60630. 312-283-2820.

Sony PCM-2500A, PCM-2500B R-DAT, used very little, \$5000/BO. T Noordyk, WSHN, POB 190, Fremont MI 49412. 616-924-4700.

Studer A80 operation/service-parts manual for 1/4 to 2" versions, \$60 pls shpg. R Cannata, Cantrax Recorders, 2119 Fidler, Long Beach CA 90815. 213-498-6492.

Pioneer 1020L 3 3/4" - 7 1/2" ips, 1/4" 2 chnl lots of 10" reels of tape included, w/editing supplies, \$400. B Ford, POB 1052, El Granada CA 94018. 415-726-4786.

Tape recorders including Otari MX7800, Teac 3340S, Scully 280, Revox A77, Hitachi D-E10, Nakamichi 550 & Sony TC124, call for details & prices. E Boucher, EAB Recdg, POB 958, Lewiston ME 04243. 207-786-3476.

Tapesonic stereo 2 trk 10.5 reels, 3 speed, \$350; Crown 5X844 4 chnl R/P, 3 speed, mint cond, \$700; Teac A4010S (2) 1/4 trk stereo, au-to reverse, gd cond, \$200 ea or \$350/both; Telex 1422 2 trk stereo plus 1/4 head for PB (2), \$350/both. J Parsons, 10375 Cannas, No Huntingdon PA 15642. 412-863-9590.

Scully 270 (4), PB only, \$300 ea. E Moody, KJEM, 216 N Main, Bentonville AR 72712. 501-273-9039.

Telex CD2M & CD2S slave unit, 2 mos old, like new, duplicates 5 tapes at a time, \$1700. R Meadows, Southeastern Sports Prod, 1203 Seaton Ste 117, Durham NC 27713. 919-544-1366.

Tascam FP 70 ft SW for 3440 & 40 Series machines, \$25; Tascam 44-460B extender service board, new, \$20. R Cannata, Cantrax Recorders, 2119 Fidler, Long Beach CA 90815. 213-498-6492.

Presto 800/908 7.5-15 ips professional plus rack, pick up in NYC, \$1000. B Rose, Program Rec, 228 E 10th, NY NY 10003. 212-674-3060.

Pioneer 1020L 3.75-7.50 ips, 1/4" 2 chnl, lots of 10" reels of tape included along w/editing supplies, \$400. B Ford, Turbo Sound, POB 1052, El Granada CA 94018. 415-726-4786.

Sony PCM 701 ES, 14/16 bit, 2 chnl processor, turns any VHS/Beta recorder into a 2 chnl digital audio recorder, \$1400/BO. B Ford, Turbo Sound, POB 1052, El Granada CA 94018. 415-726-4786.

Ampex AG-350 FT in console, 7.50 & 15 ips, gd heads, service manual, vgc, \$600/BO. R Barwig, Barwig Recording, 5254 W Agatite, Chicago IL 60630. 312-283-2820.

Fostex 4030/4035 audio-for-video synchronizer, mint cond, \$1000/BO. S Wytas, 165 Linden, New Britain CT 06051. 203-224-1811.

Otari MX 5050 BII, less than 1 yr old, perfect cond, complete w/llt back sides, buyer pays freight, \$2200; Otari MX 5050 4 trk 1/4" older unit but in great cond, heads like new, left brake needs slight adjustment, complete w/dbx NR, pre-wired, buyer pays freight, \$2200. B Hanson, Reel Trax Prod, 209 E El Cortez, Columbia MO 65203. 314-449-8433.

Telex 3 plus 1 high speed portable cassette duplicator, duplicates 3 cassettes at a time, \$450. R Meadows, Southeastern Sports Prod, 1203 Seaton Ste 117, Durham NC 27713. 919-544-1366.

Century 21 Auto Seque for CD players, like new cond, works great, \$3250; Revox PR-99 PB units (2) w/25 Hz tone detectors, \$900 ea. W Waldron, KSOS, Layton Hills Mall, Layton UT 84041. 801-546-1722.

Duplicators including comp Kuba cassette duplication system, Recordex DUP II, Pentagon C4322 7 Wollensak 2770AV, call for details & prices. E Boucher, EAB Recdg, POB 958, Lewiston ME 04243. 207-786-3476.

Ampex 351-2 2-trk, mint cond, one has original tube elect, other has Inovonics, both in roll-around, one walnut, one plywood. R Nelson, Tropical Bldg, 14093 SW 142 St, Miami FL 33186. 305-238-5024.

Pioneer RT1020L 2 speed 10.5" 1/4 trk w/4 trk PB head, w/\$200 in tape, some unopened, gd cond, recently tweaked, \$400. B Ford, Spunk Prod, POB 1052, El Granada CA 94018. 415-726-4786.

TEAC 90-16 16 trk in excel cond, \$7000/BO. B Kaplan, POB 644, St Cloud FL 56302. 612-253-9600.

Ampex 440B (4) mono, complete, (2) roll around units, BO. J Stanford, WYLD, 2228 Gravier, New Orleans LA 70119. 504-822-1945.

Otari ARS1000 7.5/15 ips w/none detect, clean & complete, \$900/BO. B Webster, WLIT, 150 N Michigan, Chicago IL 60601. 312-329-9002.

Otari MX-5050B-II-2 tape decks w/stands (2), well maintained, very low hrs, \$2250/ea plus shpg. D Glasser, Airshow Inc, 7021 Woodland, Springfield VA 22151. 703-642-9035.

Ampex 350 full trk transports w/Inovonics solid state R/P electronics & floor cabinets (2), \$500/ea. G Liebisch, POB 29521, Raleigh NC 27626. 919-876-0674.

Revox PR 99's (2) reproduce only; automation controller, all used only a few months, excel cond, BO. K Diebel, KTCJ, 1207-1/2 Louisa, Rayville LA 71269. 318-728-4915.

Crown & Ampex CR tube decks (2); (2) Ampex AG-500 solid state; Ampex 350 stereo tube, \$200 ea. C Elmajian, Tri-Core, 27503 Five Mile Rd, Livonia MI 48154. 313-427-8784.

Otari 5050 B II 2, rack mounted, \$1775; Panasonic SV 250 mini DAT, 1 yr old, low hrs, perfect cond, \$1800. R McMillen, 3235 SE 39th, Portland OR 97202. 503-239-6070.

Teac X-300 1/4 trk, 3 motor transport, 3 head, mic/line mix, record mute, tape/source monitor select, new cond, \$625. B McCue, WEXL, 317 E Eleven Mile, Royal Oak MI 48067. 313-544-2200.

Ampex 350 mono R/P w/Inovonics solid state rack mount, \$500. A Baker, 804 E 38th, Indianapolis IN 46205. 317-925-7371.

Studer Revox port case for A77 w/moon spkrs & pwr amps, excel cond, \$275/BO. R Katz, Allegro Snd, 15015 Ventura, Sherman Oaks CA 91403. 818-377-5264.

Studer Revox HS-77 Mk IV special fact order FT mono, 15/75 ips, only 10 hrs use, wood case, mint cond, \$575/BO. R Katz, Allegro Snd, 15015 Ventura, Sherman Oaks CA 91403. 818-377-5264.

Otari ARS 1000 (2) in excel cond, \$1500/both. M McAnally, WEKC, Williamsburg KY 40769. 606-549-3000.

Otari MX5050 MK III 2 trk w/roll around stand, manual & remote, less than 60 hrs use, mint cond, C.O.D. pick-up only, \$1400. G Finerman, Fintronics, 18 W Maple, Suffern NY 10901. 914-357-5419.

**CLEAN PATCH BAYS
NO DOWN TIME**



VERTIGO BURNISHERS AND INJECTORS RESTORE ORIGINAL PERFORMANCE TO YOUR PATCH BAYS
\$34.95 Ea. Please write for additional information and to see how easy.

VERTIGO RECORDING SERVICES
12115 Magnolia Blvd. #116 818-907-5161
North Hollywood, CA 91607 Fax 818-784-3763



Fostex 250 porta studio replacement motor, \$50 or trade for Revox A77 remote. E O'Brien, Imperial Sound, RR 31 Box 405, Terre Haute IN 47803. 812-877-2663.

Ampex 440-B R/P in Russlang cabinet, gd cond, \$375. J Lee, BCI, 2139 10th Ave N, Lake Worth FL 33461. 407-547-0600.

3M M79 12" 4 trk in excel cond w/synch resolver, \$750. G Zelinger, KCET, 4401 Sunset Blvd, Los Angeles CA 90027. 213-667-9310.

Revox A-77 3.75-7.5 ips, has record amps (3), \$700/ea plus shpg. B Downs, KISX, Box 131869, Tyler TX 75713. 214-593-4444.

Tascam 44 4 trk 1/4", excel cond, \$650. C.O.D. pick-up. G Finerman, Fintronics, 18 W Maple, Suffern NY 10901. 914-357-5419.

Ampex 440-C R/P, mono, Ampex elect, recently removed from srvs, gd cond, \$650. B Norman, KFLI, 3200 N Willow Creek, Prescott AZ 86301. 602-776-3785.

Teac Synacset 124, \$200 plus \$10/UPS. N Mishan, POB 335, Lynbrook NY 11563. 516-582-1338.

Studer 250 porta studio replacement motor, \$50 or trade for Revox A77 remote. E O'Brien, Imperial Sound, RR 31 Box 405, Terre Haute IN 47803. 812-877-2663.

Ampex 440-B R/P in Russlang cabinet, gd cond, \$375. J Lee, BCI, 2139 10th Ave N, Lake Worth FL 33461. 407-547-0600.

3M M79 12" 4 trk in excel cond w/synch resolver, \$750. G Zelinger, KCET, 4401 Sunset Blvd, Los Angeles CA 90027. 213-667-9310.

Revox A-77 3.75-7.5 ips, has record amps (3), \$700/ea plus shpg. B Downs, KISX, Box 131869, Tyler TX 75713. 214-593-4444.

Tascam 44 4 trk 1/4", excel cond, \$650. C.O.D. pick-up. G Finerman, Fintronics, 18 W Maple, Suffern NY 10901. 914-357-5419.

Ampex 440-C R/P, mono, Ampex elect, recently removed from srvs, gd cond, \$650. B Norman, KFLI, 3200 N Willow Creek, Prescott AZ 86301. 602-776-3785.

Teac Synacset 124, \$200 plus \$10/UPS. N Mishan, POB 335, Lynbrook NY 11563. 516-582-1338.

Ampex and Scully Spare Parts, Accessories, Motor Remanufacturing.

VIF INTERNATIONAL
PO Box 1555
Mtn View CA
94042

Direct order line (800) 848-4428
in area code 408
dial 739-9740
Telex 62922869 ESL UD
FAX: 1-408-739-0809

Pioneer RT1020L 2 speed 10.5" 1/4 trk w/4 trk PB head, w/\$200 in tape, some unopened, gd cond, recently tweaked, \$400. B Ford, Spunk Prod, POB 1052, El Granada CA 94018. 415-726-4786.

TEAC 90-16 16 trk in excel cond, \$7000/BO. B Kaplan, POB 644, St Cloud FL 56302. 612-253-9600.

Ampex 440B (4) mono, complete, (2) roll around units, BO. J Stanford, WYLD, 2228 Gravier, New Orleans LA 70119. 504-822-1945.

Otari ARS1000 7.5/15 ips w/none detect, clean & complete, \$900/BO. B Webster, WLIT, 150 N Michigan, Chicago IL 60601. 312-329-9002.

Otari MX-5050B-II-2 tape decks w/stands (2), well maintained, very low hrs, \$2250/ea plus shpg. D Glasser, Airshow Inc, 7021 Woodland, Springfield VA 22151. 703-642-9035.

Ampex 350 full trk transports w/Inovonics solid state R/P electronics & floor cabinets (2), \$500/ea. G Liebisch, POB 29521, Raleigh NC 27626. 919-876-0674.

Revox PR 99's (2) reproduce only; automation controller, all used only a few months, excel cond, BO. K Diebel, KTCJ, 1207-1/2 Louisa, Rayville LA 71269. 318-728-4915.

Crown & Ampex CR tube decks (2); (2) Ampex AG-500 solid state; Ampex 350 stereo tube, \$200 ea. C Elmajian, Tri-Core, 27503 Five Mile Rd, Livonia MI 48154. 313-427-8784.

Otari 5050 B II 2, rack mounted, \$1775; Panasonic SV 250 mini DAT, 1 yr old, low hrs, perfect cond, \$1800. R McMillen, 3235 SE 39th, Portland OR 97202. 503-239-6070.

Teac X-300 1/4 trk, 3 motor transport, 3 head, mic/line mix, record mute, tape/source monitor select, new cond, \$625. B McCue, WEXL, 317 E Eleven Mile, Royal Oak MI 48067. 313-544-2200.

Ampex 350 mono R/P w/Inovonics solid state rack mount, \$500. A Baker, 804 E 38th, Indianapolis IN 46205. 317-925-7371.

Studer Revox port case for A77 w/moon spkrs & pwr amps, excel cond, \$275/BO. R Katz, Allegro Snd, 15015 Ventura, Sherman Oaks CA 91403. 818-377-5264.

Studer Revox HS-77 Mk IV special fact order FT mono, 15/75 ips, only 10 hrs use, wood case, mint cond, \$575/BO. R Katz, Allegro Snd, 15015 Ventura, Sherman Oaks CA 91403. 818-377-5264.

Otari ARS 1000 (2) in excel cond, \$1500/both. M McAnally, WEKC, Williamsburg KY 40769. 606-549-3000.

Otari MX5050 MK III 2 trk w/roll around stand, manual & remote, less than 60 hrs use, mint cond, C.O.D. pick-up only, \$1400. G Finerman, Fintronics, 18 W Maple, Suffern NY 10901. 914-357-5419.

Scully 270S (5) used very little, BO for one or all. L Maierhofer, 101 Armory Blvd, Lewisburg PA 17837. 717-523-3271.

Ampex AG 350 mono R/R w/solid state electronics rack mount, \$800. A Baker, 804 E 38th, Indianapolis IN 46205. 317-925-7371.

Studer A80 1" 8 trk, 7.5/15 ips, 1100 hrs use, \$8000. 212-645-6319 & leave message or B Mason at 212-242-2100.

Scully 280B 4 trk half inch, gd cond, \$995/trade. G Liebisch, POB 29521, Raleigh NC 27626. 919-876-0674.

Scully 255 reproducer 1/2 trk stereo, BO. Howells Audio, POB 6184, Kingman AZ 86402. 602-753-4915.

Revox A77 (2), one rack mount, one not, \$350/ea or \$500/both. E Moody, KJEM, 216 N Main, Bentonville AR 72712. 501-273-9039.

Ampex 440 deck w/Schaler stereo solid state PB elect, \$250; Teac/Tascam 32-3 2 trk, stereo, dual capstan recorders, factory rack mounts, (4), virtual new cond, \$750 ea. G Gaskey, KWHQ, 261 Main, Ste 6, Weed CA 96094. 916-926-5946.

Otari MX-5050 Mark III-8 8 trk w/ext control input, excel cond. L Runge, WOI-TV, Communications Bldg, Ames IA 50011. 515-294-3880.

Revox A77 top-shape factory rebuilds. All wearable parts brand new, all formats. \$500-\$800, send needs, practical maintenance, manual, \$25. J Clark, JM Tech Arts, POB 8156, Hermitage TN 37076.

Want to Buy

Teac/Tascam 3340/80-8 remote controls; foot or console top operation. J McCallum, 3311 E Bruce Randolph Ave, Denver CO 80205. 303-388-8548.

2-chnl electronics for Scully 280B R-R. R McDonald, 5231 Horton, Mission KS 66202. 913-722-2677.

Technics RS1500 or 1520 must be in gd cond. S Pai, 1100 Rancho Conejo Blvd, Newbury Pk CA 91320. 605-373-7777.

Nakamichi 480 2 head, non-monitoring version preferred. J Lauria, 1153 38th, Brooklyn NY 11218. 718-633-3010.

Ampex AG500 for parts. D Ibel, KICD, 2600 N Highway Blvd, Spencer IA 51301. 712-262-1240.

ITC 750 PB-only decks for standby use, parts (2). K Brown, Box 608, Riverton WY 82501. 307-856-2922.

ITC 850 service manual. K Scheffel, 9 Cougar Rd, Edwardsville IL 62025. 618-692-9798.

Ampex MR-70 working 2 trk in original cond. D deForrest, 7441 Wayne 10-D, Miami Beach FL 33141. 305-866-5401.

CONSOLES...WTS

Wheatstone Audioarts 8X recording pro console, factory patch bay, excel cond, \$11,500. D Kocher, DLK Snd Std, 1901 Hanover, Allentown PA 18103. 215-432-0520.

Sound Workshop Logex 8 20 chnl board w/complete EQ controls, console desk w/heavy metal stand, \$2500. D Coffman, WSOR, 940 Tarpon, Ft Myers FL 33916. 813-334-1393.

Gates II consoles (2); (4) Ampex 440 C recorders; (2) Metrotec 500 PB & one for parts; QRK TT w/arm & control; (2) UMC/Beau cart machine; UMC/Beau R/P, large quantity of spare parts for all this equip, \$1150/all, FOB Ft Pierce. F Sherwood, WDKC, POB 1330, Ft Pierce FL 34954. 407-464-1330 or Fax: 407-464-8578.

Bi-Amp 1642 16 chnl, 4 sub masters, 2 masters, parametric EQ, stereo pans, phantom mic pwr, rack mountable, pwr supply, flight case, \$850. B Hurley, Audio Chicago, 100 E Ohio Ste 618, Chicago IL 60611. 312-467-0170.

BE 4550 4 chnl stereo refurbished & ready to go, \$455. R Bronte, WWNT, POB 1828, Dothan AL 36302. 205-792-2161.

Ampro AC 85 8 chnl stereo dual, \$1800; BE 150A 8 chnl, new, \$1750. J Phillips, WZOM, 408 1/2 Clinton St, Defiance OH 43512. 419-784-1059.

Broadcast Electronics 4 BEM 50 4 channel console, BO, J Sidote, POB 949, Welch WV 24801. 304-436-2131.

Quantum QM-8, 8 inputs, 4 busses, quad & stereo mon, etc, excel cond, \$775/BO; Speck 16 inputs, 8 busses, etc, excel cond, \$775/BO; Snake, 16 phantom-pwr inputs w/exc ps, 250' Belden 19-pair cable w/mil connectors & stainless-steel strain reliefs, etc, excel cond, \$750/BO. R Katz, Allegro Snd, 15015 Ventura, Sherman Oaks CA 91403. 818-377-5264.

Teac/Tascam 2, slide pot, 6 chnl, \$150. G Gaskey, KWHO, 261 Main, Ste 6, Weed CA 96094. 916-926-5946.

Gately 16x8 w/EQ 4 effects buss, quad monitoring Canon connector for line & Mic inputs & Canon connectors for outputs, \$2800. A Baker, 804 E 38th, Indianapolis IN 46205. 317-925-7371.

CCA FM-AM 10 chnl radio studio board, \$150. Roger, Master Promotions, 5792 E Edison, Tucson AZ 85712. 602-886-1853.

Harris Stereo 5 3 mic inputs & multiple line level inputs, gd cond, BO. R LaFore, WQPW, POB 1327, Valdosta GA 31603. 912-244-8642.

CCA/QRK Futura Six slide pots fair to good, still in service, BO. L Maierhofer, 101 Armory Blvd, Lewisburg PA 17837. 717-523-3271.

Want to Buy

Gates Executive complete. D Ibel, 2600 N Highway, Spencer IA 51301. 712-262-1240.

Audiotronics 110, still need one mic input module w/EQ, Mdl 110-IME for Audiotronics 110 Grandson. D Payne, WZPL, 317-637-8000.

Manual for RCA BC-6B Console, need block diagram & schematics for renovation. N Priest, 212-924-3119.

RCA & WE tube consoles, mixers, amps, TT's, speakers, mics, on-air lights, literature. R Van Dyke, Caffrey House, Squires Ave, E Quogue NY 11942. 516-728-9835.

Sparta Centurian II stereo mixer modules, write w/price per module, will consider mixers which need work. D Proctor, WCPE, POB 828, Wake Forest NC 27587.

Literature, manual, schematic for RCA console BC-2B, 1952 mdl. B Leslie, Pro Recording Svcs, 13709 Maple Leaf Dr, Cleveland OH 44125. 216-662-1435.

Howe 10,000 parts, cards, faders, new or used. A McCarthy, KUIC, Fax: 707-446-0122.

Gates Dualux II power supply. D Ibel, KICD, 2600 N Highway Blvd, Spencer IA 51301. 712-262-1240.

Harris Stereo 80, 994-6867-002 manual or copy. J Meredith, WYTH, Box 635, Madison GA 30650.

DISCO & SOUND EQUIPMENT

Want to Sell

Klipsch La Scala speakers, horn, road cases, fiberglass finish, excel cond, BO. R Kaufman, POB 462247, Garland TX 75046. 214-271-7625.

Ampex-by-JBL unmounted 12ohm speakers (2) for Ampex 620, 620-F, 622 speaker-amps, ex cond, \$60/ea. J Newman, 401-848-7133.

Sony SB-200 echo adaptor, \$30; Lafayette DNR-50 Dolby stereo unit, \$50; Pioneer SR 202W stereo spring reverber unit, \$50; Shure M888 stereo mic mixer, \$100, all in gd cond w/manuals. P Zeleniuch, Tapes Inc, 5733 S Park, Parma OH 44134. 216-886-6679. Alt 5PM.

DOD/Digitech 831-C graphic EQ, 31 band, as-new cond, \$175. B Leslie, Pro Recording Svcs, 13709 Maple Leaf Dr, Cleveland OH 44125. 216-662-1435.

Alembic 2 ch guitar preamps (2), Hiwatt L100R & Music Man 210, call for details & prices. E Boucher, EAB Recdg, POB 958, Lewiston ME 04243. 207-786-3476.

Roland TR-626 digital drum machine, programmable, mono/stereo/individual outputs, like new, \$250. M Osborne, WKSO, POB 9494, Ellsworth ME 04605. 207-667-7573.

JBL 4502, JBL C50SM & Earth B12HC, call for details & prices. E Boucher, EAB Recdg, POB 958, Lewiston ME 04243. 207-786-3476.

Guitars including ESP strat copy, Famer electric, Applause AA14-1 & Fender F230 acoustic 6-string, Royce banjo, call for details & prices. E Boucher, EAB Recdg, POB 958, Lewiston ME 04243. 207-786-3476.

Keyboards including Arp string ensemble, Hammond C3, Hohner D6 clavinet, Fender Rhodes piano & Dubreq stylophone, call for details & prices. E Boucher, EAB Recdg, POB 958, Lewiston ME 04243. 207-786-3476.

Klipsch MCM-1900 3-way, \$1800/BO. J Flannery, 8395-A Shallowcreek Rd, Liverpool NY 13090. 915-622-9199.

JBL 4695, 4622 & 2445J 3 way Cabaret series PA system, excel cond, \$2400. P Moble, 300 Main St, Brookings SD 57006. 605-697-5326.

Peterson strobe tuner mdl 400, new cond, \$250; Yamaha electronic piano mdl CP30, new cond, \$795, formerly Gosseltrax recdg std, out of business. Twila Stoller, 2320 Eade, Ft Wayne IN 46805. 219-484-7390.

Fostex 765 studio reference monitors, like new, \$225/pr. K Thomas, Rebel Recdg, POB 207, Atlantic Bch FL 32233. 904-388-7711.

dbx Boom Box subharmonic synth, regenerates super low bass, \$125; JBL K140 15" speakers (2), \$225. R McMillen, 3235 SE 39th, Portland OR 97202. 503-239-6070.

Community Light & Sound RS440 (1 pr) 4-way speakers w/Community VB790 bass bins, in Anvil cases, excel cond, \$1600. J Kreines, 5330 Kennedy Ave, Millbrook AL 36054. 205-285-6179.

JBL 4311B loudspeaker. R McDonald, 5231 Horton, Mission KS 66202. 913-722-2677.

WE & RCA speakers & tube equipment, disc recorders & reproducers & blank recording discs, catalogs, manuals, 16" transcriptions. R VanDyke, 2 Squires Ave, E. Quogue NY 11942. 516-728-1327.

LIMITERS

Want to Sell

Orban 8000A Optimod rebuilt, tune up & upgrade, \$1750. L VanDam, WUPU, Newberry Ave, Newberry MI 49868. 906-293-8522.

Orban/Optimod FM 8100 wking when removed, \$2500. L Seizle, Box K, Greeley CO 80631. 303-356-1310.

Spectra Sonic C compilimiter, excel cond; \$250/BO. J Zeinger, 4401 Sunset Blvd, Los Angeles CA 90027. 213-667-9310.

Optimod 8000A.

Good condition. \$1750.
414-482-2638

CBS 4110 FM Volumax gd cond, recent cal to factory specs. \$300. G Ogonowski, 213-465-3171.

Collins 26V-I compressor limiter, gd cond, BO. M Black, Hobart William Smith College, Geneva NY 14456. 315-781-3456.

Volumax, Gates, Spotmaster all kinds of old processing, call for info. S King, 1703 Avondale, Amarillo TX 79111. 806-355-9777.

RCA BA6A tube compressors (2). R Robinson, 203-269-4465.

Orban 9100A Optimod perfect cond, \$1800/BO; Orban 9000A Optimod, like new, \$1500/BO. J Swett, 4025 Lugano Way, Flagstaff AZ 86004. 602-526-1975.

CBS Audimax III mono AGC; CBS Volumax FM 410 mono peak limiter; Harris MSP-90 AGC, stereo wide band; Harris MSP-90 Tri Band AGC, stereo; dual MSP-90 AM peak limiter, (2) mono units in one chassis. H Kneller, 813-639-1112.

Optimod 8000A worked perfect when removed from service 2/90, \$1700. M Cooney, 610 N Kiwanis, Sioux Falls SD 57104. 605-336-2706.

Orban 8100ST studio chassis for Optimod 8100 dual STL configuration, gd cond, \$400. M Maciejewski, WMUS, 3565 Green St, Muskegon MI 49441. 616-744-1671.

Volumax 400 peak controller, AM, \$100; Audimax III automatic level controller, AM, \$100; FM Volumax 411 stereo peak controller, FM, \$125. L Wilson, 409 Hillaire, Hopkinsville KY 42240. 502-886-1678.

CRL SGC800 AGC w/Dynaflex NR, excel cond, \$1250. M Maciejewski, WMUS, 3565 Green St, Muskegon MI 49441. 616-744-1671.

CRL SMP 850 stereo limiter, current mdl, excel cond, \$1250. M Maciejewski, WMUS, 3565 Green St, Muskegon MI 49441. 616-744-1671.

Optimod 8000A, BO. Howells Audio, POB 6184, Kingman AZ 86402. 602-753-4915.

McMartin audio processor & McMartin stereo gen, \$250 ea or \$400/both. G Gaskey, KWHO, 261 Main, Ste 6, Weed CA 96094. 916-926-5946.

CRL SEP-400B/PMC-300A, excel cond, both only 3-1/2 yrs old, \$1100. T Stine, KGIR, 106 Farrar, Cape Girardeau MO 63701. 314-335-9099.

Harris/Gates AGC-994-6629-002 & M6631 Solid Statesman mono AGC & Solid Statesman mono FM limiter, both working when removed, w/manuals, \$400/BO. J Durall, WJNZ, POB 494, Greencastle IN 46135. 317-653-9717.

Dual UREI LA-4 limiters in rack mount, \$300. G Liebisch, POB 29521, Raleigh NC 27626. 919-876-0674.

Modulation Sciences CP-803 Composite Clipper, \$500/trade. G Liebisch, POB 29521, Raleigh NC 27626. 919-876-0674.

Spectra Sonics Compilimiter, mono compressor/limiter, gd for dialogue, \$150. G Zeinger, KCET, 4401 Sunset Blvd, Los Angeles CA 90027. 213-667-9310.

UREI BL-40, \$295; Comex bleepmate 675, \$499; Lake patch bay, \$79. C Dube, WSPR, POB 1270, Springfield MA 01102. 413-732-4182.

CBS Audimax 4450, BO; CRL APP-300, BO; (2) CBS Volumax 411, BO. Howells Audio, POB 6184, Kingman AZ 86402. 602-753-4915.

Aphex Type II aural exciter, BO. J Stanford, WYLD, 2228 Gravier, New Orleans LA 70119. 504-822-1945.

RCA BA-147 FM mono limiter, \$200. G Liebisch, POB 29521, Raleigh NC 27626. 919-876-0674.

Texar/Gentner Audio Prism latest Model w/PR-1, new cond, never rack mounted, \$1300. R Hull, 918-254-0464.

Want to Buy

Orban/Optimod 8100A in gd cond. M Cooney, 610 N Kiwanis, Sioux Falls SD 57104. 605-336-2706.

UREI LA-3A or LA-4 production compressor/limiters. R Kaufman, POB 462247, Garland TX 75046. 214-271-7625.

dbx 163X compressor/limiter. B Tidwell, POB 338, Valdosta GA 31603. 912-244-5180.

CRL SEP400 or SEP800. M Maciejewski, WMUS, 3565 Green St, Muskegon MI 49441. 616-744-1671.

Altec 436 A, B, C, cheap. J Ganguer, 415-644-2363.

Texar Audio Prisms wanted pair plus RCF-5 audio card for Orban 8100-A. J Bahr, 154 Guajalaca St, Crown Hills, Rio Piedras PR 00924.

MICROPHONES

Want to Sell

Neumann U-67 vintage tube mic, excel cond, BO. R Kaufman, POB 462247, Garland TX 75046. 214-271-7625.

RCA 77DX vintage ribbon mic, excel cond, BO. R Kaufman, POB 462247, Garland TX 75046. 214-271-7625.

Electro-Voice RE-20 gd cond, \$100/BO. J Swett, 4025 Lugano Way, Flagstaff AZ 86004. 602-526-1975.

Neumann U87, one pair, excel cond, \$1000 ea. G Heimman, 914-266-4141.

Fostex M22RP MS stereo studio mic, excel cond w/aluminum carrying case, \$400. Don, 3142 Market Place, Bloomington IN 47403. 812-339-4446.

RCA 77DX, needs repair, \$25. L Wilson, 409 Hillaire, Hopkinsville KY 42240. 502-886-1678.

EV RE-20, never used, \$250. R Meadows, Southeastern Sports Prod, 1203 Seaton Ste 117, Durham NC 27713. 919-544-1366.

Beyer M-160 double ribbon mic in perfect cond, \$180. J Wayne, Silverdisc Prod, 405 Tarrytown Rd, Ste 444, White Plains NY 10607. 914-591-5240.

Schoeps CMC-55U (2) Colette Series 48V condenser mics w/switchable cardioid/omni, matched stereo pair w/addl MK8 figure-8 capsule & suspensions for M-S recording, mint cond, \$2650. J Wayne, Silverdisc Prod, 405 Tarrytown Rd, Ste 444, White Plains NY 10607. 914-591-5240.

EV 1957 collectors edition 667 w/adjustable EQ preamp system, gold plated head & fittings, custom cables & mahogany case, documentation, new cond, \$395. D Miller, Airborne Audio Prod, 11647 W 83rd Terr, Lenexa KS 66214. 913-492-8822.

RCA 44-A velocity bi-directional diamond shaped ribbon mic, a classic, yoke & shock mount intact, \$550. R Franklin, Super Snd Stds, 211 Virginia, Norristown PA 19401. 215-277-7112.

Telefunken tube CM-61, very rare, uses std plug-in tube, mint cond w/custom ps, BO. R Katz, Allegro Snd, 15015 Ventura, Sherman Oaks CA 91403. 818-377-5264.

Bruel & Kjaer 4007 high intensity, omni mic, phantom power, never used, still in wood box, ruler flat, \$750/firm. B Ford, Spunk Prod, Box 1052, El Granada CA 94018. 415-726-4786.

Neumann KM-88, rare 3-pattern w/nickel capsule, hot-setup percussion mic, mint cond w/orig case, \$875/BO; Neumann KM-86 3-pattern, mint cond, \$675/BO. R Katz, Allegro Snd, 15015 Ventura, Sherman Oaks CA 91403. 818-377-5264.

RCA ribbon mics including (1) 44-BX; (1) 77-D; KU3A10,0001; BK-11; BK-5; SK-46; WE639A, will trade for other high quality condenser, dynamic, ribbon mics & audio equip. Tracy Eaves, 615-821-6099 (evenings).

Want to Buy

RCA 44's, 77's & other ribbons, working or not, WE 639 etc. W Davies, 5548 Elmer Ave, N Hollywood CA 91601. 818-781-9831.

RCA 44BX or 77's vintage ribbon mics, BO. R Kaufman, POB 462247, Garland TX 75046. 214-271-7625.

DISTRIBUTOR DIRECTORY

The following distributors serving the broadcast industry would be glad to help you with any of your requirements.

SPENCER
Broadcast & Communications
AUDIO—VIDEO—RF
Where Service is #1
Now in our 11th year
CALL 602-242-2211
FAX 843-2860

FCC's Engineering
FM and TV Data Bases
for your P.C.
Call today to request a free sample.
Communications Data Services
6105 E. Arlington Blvd.
Falls Church VA 22044
(703) 534-0034

CASSETTES - CARTS - REELS
J & I AUDIO/VIDEO
A wholesaler in the Radio and Television market.
Now running SPECIALS on audio and video:
BASF CASSETTES - AMPLEX R-R's AUDIOPAK, FIDELIPAC & 3M CARTS
For more information call person-to-person collect: **Kris Elliot at 818-992-4288** or write to: **J&I Audio/Video 20899 Kelvin Pl., Woodland Hills, CA 91367**

CORNELL-DUBILIER MICA CAPACITORS
FROM STOCK
JENNINGS VACUUM CAPACITORS
FROM STOCK
JENNINGS VACUUM RELAYS
SURCOM ASSOCIATES, INC.
2215 Faraday Ave., Suite A
Carlsbad, California 92008
(619) 438-4420

RIGGINS ELECTRONIC SALES
GEORGE RIGGINS WA6DZR
3272 EAST WILLOW ST.
LONG BEACH, CA 90806
(213) 598-7007

THE SOURCE
CALL US FOR ALL YOUR NEW EQUIPMENT NEEDS
Toll free: 800-HOT-AMFM (800-468-2636)
305-651-5752
FAX: 305-654-1386
186 20 N.E. 2nd Ave.
Miami FL 33179
ELECTREX COMPANY

... country, top 40, news, urban, talk, jazz, the classics, mixed bag ...
RADIO! The beat goes on!
CROUSE-KIMZEY OF ANNAPOLIS
tops in broadcast equipment
1-800-955-6800
ask for Kathleen

THIS SPACE AVAILABLE
Call Simone Leaser at
1-703-998-7600

AUDIO
broadcast group inc.
SPRING SPECIALS* -DEMOS-OVERSTOCK-ETC.

EV Sentry 100A Speaker	195.00
Modulation Sciences FM-ModMinder	2030.00
Aphex 700 Dominator Stereo	850.00
Aphex 250 Aural Exciter	650.00
Gentner SPH-4 Hybrid	670.00
Gentner EFT-1000A Frequency Extender	1,090.00
Gentner 48DRTSRABFB Patch Bays	515.00
Marti SCG-10 Subcarrier Generator	556.00
Marti SCD-10 Subcorrier Demodulator	556.00
Vega Ranger I 'Lavalier' Wireless Microphone System	740.00
Tascam CD-701 CD Player	1,360.00
Tascam RC-701 Remote Recorder	770.00
Studer A-721 Cassette Tape Recorder	2,100.00
Studer A-727 CD Player	1,520.00
dbx 164 Compressor	350.00
Yamaha GQ1031B EQ	225.00
Soundcraft 2008/VE 8 Channel Console	3,600.00
Soundcraft VSA24 Serial Interface for Consoles	1,500.00
B/E PT90RPS Cart Machine Stereo Rec/Play	3,500.00
Fidelipac CTR-124 Cart Machine	3,600.00
Micro-Trak Sport IV Remote Mixer	650.00
Telex Copyette 1 + 3 Duplicator	790.00
EV Sentry 500 Speaker	350.00

*Check with order.
*Limited to inventory on hand.
1-800-999-9281

Paradyne DCX-825 12 chnl cable data mod w/manual, excel cond, w/2 external Bell type line drives, \$1500/BO. B Shafter, 2923 S Western, Marion IN 46953. 317-668-5461.

Broadcasting Yearbooks 1950's thru 1985. BO. A Wilkerson, POB 340, Lenoir City TN 37771. 615-986-7536.

Gates ACC-2 chassis, less pwr supply & speaker amps; Heath AR-15. H Kneller, 813-639-1112.

Nortronics 2 trk 9202 PB heads (3), new, \$35ea; Nortronics 2 trk 9200 head in mount, new, \$35. R Shroyer, 215 N 4th St, Yakima WA 98907.

Complete 5 kW radio station all equip must go, cart machines, TT's, furniture, monitoring equip, xmir, etc. J Swett, 4025 Lugano Way, Flagstaff AZ 86004. 602-526-1975.

IMS computers, (2) terminals, hard drive, floppy drive. Datacount software installed, \$4995. B Dunnington, WZYP, POB 389, Athens AL 35611.

Nidec NAH-1202F

CONSULTANTS

EVANS ASSOCIATES
Consulting Communications Engineers

FCC Applications, Design & Field Engineering
Broadcast Engineering Software

216 N. Green Bay Rd.
Thiensville, WI 53092

(414) 242-6000
Member AFCCCE

W. LEE SIMMONS & ASSOC., INC.

BROADCAST TELECOMMUNICATIONS CONSULTANTS

1036 William Hilton Pkwy
Ste 200F
Hilton Head Is., SC 29928

(803) 785-4445

SOFTWARE
FM CHANNEL SEARCH

FM Database pool
MSDOS
EGA Graphics-Color
Broadcast Technical Consulting

V Doug Vernier
Broadcast Consultant
1600 Picturesque Drive
Cedar Falls, IA 50613
319-266-8402

MAGRILL ENGINEERING
Radio Engineering Consultants

FCC Applications - Upgrades
Pre-purchase evaluations
Station planning & Design
Turnkey systems - Field service

Experienced, Economical & Fast

(904) 591-3005

Barry Magrill P.O. Box 1010
President Fairfield, FL
Member IEEE 32634

Consulting Communications Engineers

- FCC Data Bases
- FCC Applications and Field Engineering
- Frequency Searches and Coordination
- AM-FM-CATV-ITFS-LPTV

OWL ENGINEERING, INC.

1306 W. County Road. F,
St. Paul, MN 55112
(612)631-1338 "Member AFCCCE"

Studio & Transmitter Site Designs

Turnkey Installations
F.C.C. Applications
Automation
Field Service, R.F. & Audio
Superior Audio Imagery
Nationwide Service

Bill Elliott, Consultant
48 Imperial Avenue
Pittsfield, MA 01201
413-442-1283

Huntsville Antenna Engineering

There is hope for AM radio!
AM station unipole antennas with circular polarization & beam tilt.
Broadband your present AM tower Series R shunt fed.

205-353-9232 205-353-6747

Kenneth Casey
Consulting Radio Engineer

This Space Available

Call Simone Leiser at
1-703-998-7600

RADIO SYSTEMS ENGINEERING

FCC Applications • Design
• Installation • Field Service
Experienced & Affordable

4289 Roanridge
Las Vegas, Nevada 89120

24 Hr: **(702) 454-2085**
FAX: 702-458-2787

new station construction field service AM directionals

RON KROB
broadcast technical consultant

4910 Four Star Court
Fort Collins, CO 80524 303 484 2704

Moffet, Larson & Johnson, Inc.
Consulting Telecommunications Engineers

Two Skyline Place
5203 Leesburg Pike # 800
Falls Church VA 22041
703-824-5660
800-523-3117
Member AFCCCE

TENCO TOWER

Lic. No. 357096
Installation & Maintenance of Broadcast & Communications Towers & Antennas

Donald J. Tenna
9723 Folsom Blvd. Suite A
Sacramento, CA, U.S.A. 95827
(916) 362-6846 (916) 638-8833
FAX: (916) 638-8858

SONEX-SOURCE

58 NONOTOCK ST.
NORTHAMPTON, MA. 01060

'Your Source for Sonex Acoustical Foam'

WIN RIDABOCK
(413) 584-7944

MISCELLANEOUS . . . WTS

Vikron PB heads (3) for Audi-Cord series E cart machines, new, stereo, \$75ea; mono (2), \$35ea; Dummy (3), \$5ea. R Shroyer, 215 N 4th St, Yakima WA 98907.

Extel teleprinters (2), (4) boxes spooled paper, both excel cond, BO. R Fess, POB 250, Macomb IL 61455. 309-833-5561.

Onan 40 kW 3-phase diesel generator for emergency operation, \$4500. Smokey, KMMC, 1703 Allendale, Amarillo TX 79106. 806-355-9777.

Equipment inventory including Commodore 64 w/monitor & FSD-1 floppy disk drive, \$150/BO; stereo monitor amp, gd cond, 30 W tube type, \$75; Gra-Lab photo electric timer, \$25; part of Gatesway manual & schematics, BO; Miratel Conelrad covr, BO. M Johnson, KGAL, POB 749, Albany OR 47321. 503-451-5425.

Elgar HIT-H7.5 7.5 kW isolation transformer, perfect cond, 120/240 V, \$2600/firm. A Reis, TNL Resources, 308 Eastgate Court, New Lenox IL 60451. 815-485-7388.

Trompeter original gold J13-75 patch jacks, PN2BE-75 paralleling, PNS3/625 & PNS4/625, TPC-9-75. O Berliner, SounDesign, Box 921, Beverly Hills CA 90213. 213-276-2726.

Misc equip inventory including several hundred feet of RG-8U coaxial cable on reel (2), new, \$50/reel; Gates 14425 audio transformer, BO; 4000' of #10 bare copper wire, 1000' rolls, \$125/roll. M Johnson, KGAL, POB 749, Albany OR 47321. 503-451-5425.

Hammond REFK19035-24 rack cabinets (2) w/locking solid front door & louvered rear door w/lock, dual squirrel cage blowers w/filter for clean cabinet pressurization, Hammond RAVB-290 blowers, 35" vertical panel space & threaded rails in racks, gd cond, \$350/ea. TX Valley Translator, 6903 Spring Garden, San Antonio TX 78249. 512-696-5615.

60kW DIESEL GENERATOR
Complete with 225AMP Transfer Switch

Engine — 6V71 Detroit Diesel — Rebuilt Generator — LSA44M2 Leroy Somer — New Transfer Switch — Westinghouse — New Complete — Ready for Standby Operation Connect fuel and seven wires

\$340.00 per month for 60 months
(Subject to local taxes)

Call us for your generator needs. **Norac**

U.S. and Canada Maine
1-800-366-3912 (207) 657-3579 1-800-526-6722

ADC 2X 48 point 1/4" front patch bays, one normald, one reg, \$25 ea. R Cannata, Cantrax Audio Recdg, 2119 Fidler, Long Beach CA 90015. 213-490-6492.

Wilkinson SIA3 240V, 3 phase surge protector, mint cond, \$1800. G Gilbreath, KNPR, 5151 Boulder Hwy, Las Vegas NV 89122. 702-454-2085.

PJ7 ADC stereo patch cords (4), \$20. L Wilson, 409 Hillaire, Hopkinsville KY 42240. 502-886-1678.

Executone Equity telephone system, 20 phones & parts, \$1000. A McCarthy, KUIJ, Fax: 707-446-0122.

Audio Engineering audio magazines, various issues 1947-1960. B Leslie, Pro Recording Svcs, 13709 Maple Leaf Dr, Cleveland OH 44125. 216-662-1435.

Closing/Liquidating AM station: all studio inventory, production room inventory, xmrtower equip inventory and lots of misc equip inventory must go, call for all the details & prices. J Clinton, WMLC, 601-268-7892.

Tascam FP 70 FT SW for 3440 & 40 series machines, \$25. R Cannata, 2119 Fidler Ave, Long Beach CA 90815. 213-498-6492.

Pro-Co cable, 500', 40 pair indiv shielded, \$1250. M Maciejewski, WMUS, 3565 Green St, Muskegon MI 49441. 616-744-1671.

Tascam 44-480B extender service board, new, \$20. R Cannata, 2119 Fidler Ave, Long Beach CA 90815. 213-498-6492.

ADC 48 point patch bays, brass 1/4 jack's balanced & 1 is normald, gd cond, \$25/ea. R Cannata, 2119 Fidler Ave, Long Beach CA 90815. 213-498-6492.

Jingles that sing K-95 FM & 3-40,000 bumper stickers that say I LOVE K95FM, BO. E Moody, KJEM, 216 N Main, Bentonville AR 72712. 501-273-9039.

Tellabs 4008 equalizer modules (2) w/Tel-lab 1911 single card housing & transformers, \$100/ea. N Beaty, 2116 Osman Lane, Greenfield IN 46140. 317-326-3620.

AT&T Comkey 416 telephone system, one base unit, 2 extension units, 2 incoming lines & 1 intercom path, expandable to 5 lines w/icom & total of 16 stations, w/cables, punch terminal & box, \$321.27 or trade for Tascam 32 reel motors. H Hart, Media Prod, 9440 Montego, Shreveport LA 71118. 318-687-8745.

Radio Systems TM-2R new, in original boxes, studio timers, \$125/ea. K Thomas, Rebel Recdgs, POB 207, ATL Bch FL 32233. 904-388-7711.

Alden Electronics C2000R weather radar, 16 pgs of memory, telephone access to site, full color graphics, composite video or RGB interface to monitor. W Rossini, WLQR, 125 S Superior, Toledo OH 43602. 419-244-8321.

Data Signal MTI-700 modular telephone interface, BO; (3) RCA Tactec programmable trunking mobile telephone radios, BO; 3M fax machine, BO. Howells Audio, POB 6184, Kingman AZ 86402. 602-753-4915.

Standard rack cabinets (3) 6' military spec, \$75/all. G Gaskey, KWHD, 261 Main, Ste 6, Weed CA 96094. 916-926-5946.

Gramplan disc cutter heads 1D feedback; lead screws for 6N presto cutter; patch bays 24 inputs, patch cords; manuals for Ampex/Pultec/Altec etc.; 40 new tubes & resistors left; Sencore transistor & diode tester; Ed-ital blocks 1/4" & 1" for tape splicing; Davon 600 ohms attenuators (silent); other items. Mr Oliver, 212-874-7660 in afternoons.

Let the Government finance your new or existing small business. Grants/loans to \$500,000. Free recorded message: 707-449-8600. (MN8).

Presto 6N cutter lead screws; Capps disc cutting needles, new; heating stylus ampere boxes w/VU meter & control; Meissner mixer, 5 inputs battery operated; Canon plugs, 3-prong, male & female; Harmon-Kardon DPR7 mixers, new; Lafayette sine wave audio generator. Mr. Oliver, 212-874-7660 in afternoons.

Want to Buy

Bdct software, non-engineering, bdct related that runs on Radio Shack MdI III/4 computers. E Ford, KBPK, 321 E Chapman, Fullerton CA 92634. 714-992-7418.

Ross 31M or 15S either 31 band mono or 15 bands stereo model. S Pai, 1100 Rancho Conejo Blvd, Newbury Pk CA 91320. 805-373-7777.

Schematic for Integral Systems pwr amp or at least numbers for the output transistors. P Rebmann, WEZY, 813-682-3143.

Vintage equipment manuals, catalogs & related literature, especially want Fairchild, Langevin, Altec, etc & RCA broadcast equipment books. B Leslie, Pro Recording Svcs, 13709 Maple Leaf Dr, Cleveland OH 44125. 216-662-1435.

ARRL Radio Amateur handbook, 1948 edition, gd cond, will consider 1947 & or 1949. N Allebaugh, WICE, 100 John St, Cumberland RI 02864. 401-725-9000.

Manuals to convert Pioneer multi-play home units CD players to interface w/automation equip for music source of automated radio stations. 703-935-4541 (days); 703-935-9230 (aft 7PM EST).

Telos 100 System, complete system which would include (3) Telos digital hybrids & switch console. H Reinders, WWDB, 5558 Hallie, Chippawa Falls WI 54729. 715-723-1037.

Manuals/catalogs for RCA, Dumont, GE sales. A Weiner, 14 Prospect, Yonkers NY 10705. 914-423-6638.

Maxitel 82 or any model telephone mixing unit remote bdct system. S Hess, KDUC, 29000 Radio Rd, Barstow CA. 619-256-2121.

WE any mdl amps, mixers, speakers, literature, Altec amps, speakers, top \$ pd for WE amps. D deForrest, 7441 Wayne 10-D, Miami Beach FL 33141. 305-866-5401.

DISPLAY YOUR CONSULTANT'S CARD HERE AND BE SEEN BY OVER 21,000 READERS

Call Simone Leiser at 800-336-3045

SERVICES

BRENTLINGER BROADCAST ENGINEERING, INC.

Charles Jayson Brentlinger
President

COMPUTERIZED REPORTS
ALLOCATION STUDIES • AM • FM
AM DIRECTIONALS • AUDIO • STL
SATELLITE COMMUNICATIONS

4338 East Acoma Drive
Phoenix, Arizona 85032
(602)867-0181

HARMON'S TOWER SERVICE, INC.

Maintenance, Painting,
Antenna & Equipment
Installation,
Winch Services

435 B Broadway
Columbus, GA. 31901
(404) 327-1074

ENGINEERING SERVICES

REGISTERED PROFESSIONAL
ENGINEERING STAFF

• STRUCTURAL • CIVIL • MECHANICAL •
Tower and Antenna Support Systems Analysis,
Inspection, Modification, and Appraisals.

division of
CENTRAL TOWER INC.
P.O. Box 530, Newburgh, IN. 47630
Phone: 812-853-0595

BROADCAST COMPUTER DATABASE BBS

300 to 19200 Baud
N-8-1
Multi-Node System
(713) 937-9097

FCC Information
On-Line Call Sign Search
On-Line Engineering Formulas
Messages, Conferences, Files, Doors

BROADCASTING & ELECTRONIC SERVICES LABS

PO BOX 178
NEWTON, UT 84327
801-563-3088

BROADCAST EQUIPMENT
REFURBISHED & REPAIRED
AUDIO, VIDEO, RF, DIGITAL
15 YRS EXPERIENCE

TOWER SERVICES
Light Replacement
Routine Maintenance
Ground Systems
Painting
20 years Experience

John Nix
PO Box 13244 Salem, OR 97309
503-581-4056
1-800-321-4056

SPECIALIZING IN ERECTION,
REPAIRING, PAINTING
AND MAINTENANCE
RADIO, TWO-WAY, TV, TOWERS
AND FLAG POLES

A STEEPLEJACK CO.
PAINTING AND STEEPLEJACK
CONTRACTORS

FULLY INSURED FOR YOUR PROTECTION

OOON HIGHLLEY 3722 ROMA
713-462-6105 HOUSTON, TEXAS 77080

MIRKWOOD ENGINEERING

Rural & Remote Site
Field Engineering

50 Park Ave.
Claremont, NH 03743

603/542-6784

PARAMOUNT COMMUNICATION SYSTEMS

INSTALLATION AND SERVICE OF BROADCAST
ANTENNA SYSTEMS/TOWER MAINTENANCE & ERECTION

WESTMONT, NJ (609) 869-0222

BSG Phone or Fax
(919) 968-4200

Broadcast Support
Group, Inc.

109 Conner Drive
Wilshire III, Suite 105
Chapel Hill, NC 27514

AM/FM, Studio,
Transmitter Installations

R.F. Systems

Installation Checkout
Optimization

Donald "Donny" Millar
President

916-644-7055
5874 Rose Court
Pollock Pines, CA 95726

Contact Radio World Newspaper for availabilities.

P.O. Box 1214 • Falls Church VA • 22041

REMOTE & MICRO . . . WTS

Moseley MRC-1600
digital remote control,
\$1995.
804-974-6466

Moseley MRC-1600, like new, latest software, \$3700. C Leavens, 412-241-2985.

Moseley PCL 505 STL stereo system, w/manual, excel cond. J Arzuaga, POB 960, Quebradillas PR 00742. 809-895-4198.

Moseley PCL-505C STL system on 947.00 MHz, \$3750. C Leavens, 412-241-2985.

Gates RDC-10 remote control unit in gd cond, spare Gates RDC-10 for parts, w/plenty documentation, \$250/both. N Beatty, 2116 Osman Lane, Greenfield IN 46140. 317-326-3620.

MCI remote control 9 chnl digital, 450 MHz xmt, studio-line, SCA cards, 1/2 price; Moseley RPU 161.67 & 166.25 xmt & rcvr, BO, J Phillips, W20M, 408 1/2 Clinton St, Defiance OH 43512. 419-784-1059.

Want to Buy

Cheap older non-type accepted STL transmitters & receivers in the 950 MHz range for ham radio public service project donations accepted. B Croghan, KCEE/KWFM, POB 5886, Tucson AZ 85703. 602-623-7556.

Pre 1985 STL 900-950 MHz to donate to missionary radio network which doesn't need FCC Rule 74.550 conformance. L Amstutz, 4526 Arlington, Fort Wayne IN 46807. 219-429-8366.

Satellite receiver for Transtar's Niche 29 format. B Hearst, WMCH, POB 688, Clarion PA 16218. 814-226-8600.

Television satellite uplink, C-band or K-band, fixed or mobile, incl exciter, HPA, dish, etc. Ugly George Satellite TV, 314 W 52nd St, NNYN 10019. 212-677-2200.

STL electronics, dishes, hardware & Mari RPU xmt's, receivers, antenna, repeaters on 161 & 450 bands. L Maierhofer, 101 Armory Blvd, Lewisburg PA 17837. 717-523-3271.

Marti RPT 2540, BR10/150 RPU remote pick-up xmt & rcvr on 161 MHz. S Hess, KDUC, 29000 Radio Rd, Barstow CA. 619-256-2121.

Marti remote equipment 160 or 450 band rcvr & tran. S Jeffries, Hwy 14 East, Mankato MN 56001. 507-345-4537.

Marti RPT 30 or RPT 15 15 W or greater, must be in 455 MHz band, solid state, balanced input. K Scheffel, 9 Cougar Rd, Edwardsville IL 62025. 618-692-9798.

STATIONS

Want to Sell

AM station 10,000 W in Orlando FL market, original owner of 25 yrs is retiring, modern plant, 16 acres valuable land, masonry studio-xmt bldg, twice the pwr of other Orlando AMs, priced to sell w/or who real estate. E Allmon, Box 555519, Orlando FL 32855. 407-425-0623.

Need interested buyer for 5000 W AM, we are bidding for the FM side of an AM/FM simulcast station, we may pay AM plus FM price to get the FM only, you could walk off with the AM (license, studio, four towers, Xmitter, buildings & land) for practically nothing! While we marry up two traditional competitors, you can step in and steal the remaining AM for a song and give us a run for our money! Serious inquiries only to: Radio World, POB 1214, Falls Church VA 22041. 90-04-02 RW.

AM 1 kW, FT, ND single station market, includes nice studio/transmitter property near town, established by owner in 1970. R Hobbs, 2009 Cromwell, Nashville TN 37215. 615-373-2351.

AM/FM combo 5000 W, AM non-directional, 6000 W FM non-directional, Southeastern NC low down payment, owner financing avail, \$585K. Wayne, 919-965-4906 (nights).

First time opportunity, owner/operator, 1000 W, 24 hr clear channel AM 540 in Central Utah, \$200K cash, \$225K terms, serious responses only. M Halloran, POB 636, Delta UT 84624.

LPTV CP's & troubled stations, buy, trade or joint venture, send details w/price & terms or call. J Worrall, 4618 Gabriel Dr, New Orleans LA 70127. 504-241-6634.

FM 100,000W station in Utah, for more info: Fax 1-801-673-1546.

FM CP, class C3, 25 KW ERP, Pine Bluff AR, \$55,000 or sell percentage. M Gottesman, Box 1957, Pine Bluff AR 71613-1957.

Class A soon to be C3 in Pacific Northwest, signal in large market, for info call Larry at 404-460-6159.

AM & or FM radio station in Central Arkansas, good area, excellent potential. Ask for Vivian, 501-470-1525 or 501-568-5448.

AM/FM combo in mountain area, 580 kHz, 2.3 kW day, 310 W night, ND, Class A FM, C1 applied for, 17 acres, 2 story building, positive cash flow, owner financing avail, would consider aircraft in trade, \$260K/BO. Tracy, 605-745-3797 (evenings).

Sell your radio station. Pay no commission. Save thousands of dollars. Confidential notification of buyers nationwide. Call Broadcast Marketing Service, 205-734-4888 for details today.

Want to Buy

Seeking existing AM or CP in eastern or central North Carolina. L Afferbach, CTC Media, 5550 Sterrett Pl, Columbia MD 21044. 301-621-5045.

LPTV CP's & troubled stations, buy or trade or joint venture, send details w/price & terms. J Worrall, 537 Ridgewood, Louisville KY 40207. 502-896-4513.

FM or AM/FM, gd terms, financially qualified, in NY, PA, Ohio, MD or IL or KY. E Stanley, Standey Bldg, Box 161X, Jeffersonville IN 47348. 914-482-3158.

STEREO GENERATORS

Want to Sell

Modulation Sciences DSCA-188 data Sidekick SCA gen, 92 & 62 kHz. D Leinen, Independent Resources, POB 23498, Oklahoma City OK 73213. 405-728-2525.

Moseley SCG-8 subcarrier gen w/67 & 92 kHz cards, near new, \$500/BO. K Browth, Box 608, Riverton WY 82501. 307-856-2922.

Want to Buy

CCA FM 10DS stereo generator. T Barnes, KRIL, 2735 E 8th Ste 45, Odessa TX 79761. 915-332-6870.

SWITCHERS (VIDEO)

Want to Sell

Panasonic WJ 540 P 6-input B/W switcher w/2 25" multipin cables, \$200. D Hurd, Box 853 Station A, Searcy AR 72143. 501-279-4658.

Vital VIX-114-4A 3-M/E switcher w/all options & spare parts, built-in blackburst & color background, \$3500. D Brichetto, 4700 Coster, Knoxville TN 37912. 615-688-3151.

CEL Model P169V 4x8 routing switcher, local or remote control, full instructions, mint cond, \$1475. Chief Engr, Vidcom Consultants, 412-327-1333.

CoHu 9501 w/manual & broadcast sync generator model TSG3000 GL, \$1000. D Garcia, 69 Pine, Waterbury CT 06710. 203-574-4857.

3M 1174 w/4 busses, mix to wipe, direct buss, take bar, ext, int keys, \$850. R Jensen, Telecable Corp, 5812 21st, Racine WI 53406. 414-632-3131.

Want to Buy

Bdct school needs non-working Vital 114 switcher &/or Vital Squeezezoom for parts to keep existing system running, partial systems OK, can give tax receipt if donated. B Hodges, OSV Journalism Bdctg, 206 Paul Miller, Stillwater OK 74078. 405-744-8273.

TAPES, CARTS & REELS

Want to Sell

Capitol AA-4 music lengths 3 to 6 min, like new, \$2.25ea. R Thomson, 1167 W Javelina, Mesa AZ 85202. 602-897-9300.

Audiopak A-2 carts (250), new & almost new, 40's & 70's. G Jablonski, WHMI, POB 887, Howell MI 48844. 517-546-0860.

Fuji T30 1/2" videotapes, approx 400, ea w/blk hard-cover case, \$3.45 ea. D Murray, Murray Video Prod, 1918 Sloan, Latrobe PA 15650. 412-539-0465.

A&D
Cartridge Rebuilding
Service
We clean, load & pack. Serviced within 10 work days! Work guaranteed!
3380 Blakely Ave., Eau Claire, WI 54701
(715) 835-7347

Tascam 32, 7.5-15 ips stereo up to 10" reels, very little use, \$1200 pls shpg (firm). B Coleman Jr, WIST, POB 460, Lobelville TN 37097. 615-593-2978.

Ampex 642 1 mil tape, 100 reels, bulk erased, plastic reels, in boxes, \$5/reel. T Moore, WBCO, POB 789, Bucyrus OH 44820. 419-468-2326.

Audiopak AA-4 hundreds of music lengths, like new, \$2.25/ea. R Thomson, 1167 W Javelina, Mesa AZ 85202. 602-897-9300.

Ampex 406 10 1/2" metal reels (10), new in sealed factory shpg carton, \$100 + UPS. G Jones, POB 229, Uvalde TX 78802. 512-278-1545.

MARATHON PRODUCTS COMPANY
Audio Cartridge Rebuilding Division

Rebuilding/reloading, like new, all brands, any length up to & including 2.5 minutes,
\$1.50 ea. FOB our plant, 48 hrs delivery.

New NAB Marathon cartridges prices on request.
35 Years professional experience!
Lifetime member AES R.D.MYERS Sr.
Manufacturers of Audio Devices, Continuous Tape Mag.

69 Sandersdale Rd.,
Charlton, MA 01507
1-508-248-3157 or 1-508-853-0988

Audiopak AA-2, AA-3 & AA-4, like new, 70 sec lengths & music lengths, BO. R Thomson, KDKR, 1167 W Javelina, Mesa AZ. 602-897-9300.

Want to Buy

2 & 4 trk open reel pre-recorded music tapes 50's, 60's, 70's vintage. R McDonald, 5231 Horton, Mission KS 66202. 913-722-2677.

Audiopak A-2's suitable for reloading. E Ford, KBPk, 321 E Chapman, Fullerton CA 92634. 714-992-7418.

Vintage 7" tape cards & reels, tape not important, Scotch, Audiotape, Irish, Soundcraft, etc. Boxes must be clean & usable, prefer Pre-1960. Especially wanted are audio tape colored reels from 1950's. B Leslie, Pro Recording Svcs, 13709 Maple Leaf Dr, Cleveland OH 44125. 216-662-1435.

TAX DEDUCT EQUIP

Bdct audio eng student in need of old retired audio & test equip. T Backer, 102 E Smith, Herkimer NY 13350. 866-9956.

College station seeks cart machines, TT's, mics & consoles & R-R's for on-air & production. K Fuik, WLHA, Holt Commons, Madison WI 53706. 608-262-1206.

Front line Christian TV station on US-Mexico border needs all types of video/audio equip. S Frahm, KSCE, 614 E Yandell, El Paso TX 79902. 915-542-0038.

Educational station seeks donation of automation equip for training program, will pick up & provide tax letter, need Brain, racks & accessories, repairable's OK. H Espravnik, WYCP, 1360 Nashville Pk, Gallatin TN 37066. 615-451-1640.

VHF/UHF/HF/CB amateur & comm equip desired, also packet controllers, remote based antennas/tower, etc. J Bondon, 10318 Missouri, Los Angeles CA 90025. 213-338-7356.

Need mics, cart machines & consoles. C Riddle, World For Christ Radio, 6046 Greenway Ct, Manassas VA 22111. 703-670-7764.

UPS/Battery back-up generators needed by university amateur radio club, willing to pay shipping for working/useable gear. J Bondon, 10318 Missouri, Los Angeles CA 90025. 213-338-7356.

Alabama A&M Univ seeks donation of radio equip for starting a non-commercial FM station, will issue tax deductible receipt. C Haygood, POB 324, Normal AL 35762. 205-851-5227.

Monte Vista Christian School, would appreciate any donations of used TV broadcast equipment. T Quinn, 408-475-0423.

Eng student desiring donation of old bdct equip (anything) in repairable cond, will pay all shipping charges, EE student at Purdue. C Gill, POB 371, Indianapolis IN 46206. 317-923-2800.

TEST EQUIPMENT

Want to Sell

Potomac RMP-19(204) remote meter panel for AM-19 phase monitor, mint cond, \$400. N Winter, 210 W Cota, Shelton WA 98584. 206-473-3462.

Leader LAS-550 test set; Tek 1503 time domain reflectometer; Leader LBO-15 scope; Hitachi 7 MHz battery powered scope; HP 5383 225 MHz freq counter; HP 5384 freq counter; Telewave wattmeters (4); Potomac Instruments FIM-41 field intensity meter; Delta 5 amp meter & transformer; Loitech TS-1 (4); Bird power analyst & 3" flanged line section w/5 elements. Fine Tuning Assoc., 804-873-6832.

Simpson 458 oscilloscope old but in perfect shape w/manual, BO. R Fess, POB 250, Macomb IL 61455. 309-833-5561.

Tek 453 50 MHz oscilloscope w/book & probes, \$300; Cushman CE-24A freq selective voltmeter, \$1975/BO. R Nelson, Tropical Bdct, 14903 SW 142 St, Miami FL 33186. 305-238-5024.

Leader LDM 171, highly accurate, AC voltmeter/dist analyzer, brand new cond, less than 4 hrs use w/manual, \$695. G Finerman, Fintronics, 18 W Maple, Suffern NY 10901. 914-357-5419.

Senior Voltohmmist RCA w/AC-DC-ohms probe WC98C, \$100/BO; Precision 660 tube & transistor tester, \$50/BO; Heathkit IM-4160 FM deviation meter w/NiCad batteries & charger, \$50; Heathkit 10-30 5" oscilloscope, needs work, CRT gd, \$35; Heathkit IB-1103 freq counter, needs work, BO; Heathkit IM-21 ACVTVM, \$35. L Wilson, 409 Hillaire, Hopkinsville KY 42240. 502-886-1678.

Sencore VA-62, NT64, VC-63, PR-57, all like new, \$2500. L Clinton, KARN, POB 4189, Little Rock AR 72214. 501-661-7500.

Potomac FIM-21, \$1800; Potomac AM-19 4 tower, \$2300; Delta RG-3, \$2900; (2) ITC 3 deck mono w/tones, \$500-700; Belar AMM-1, \$450; Belar AMM-3, \$550; GR 1931A mod mon, \$400. E Burkhardt, WLEE, 121 Wyck, Ste 300, Richmond VA 23225. 804-232-0300. 526-1975.

TEST EQUIPMENT

Why Buy When You Can Rent?
POTOMAC, DELTA, BIRD.
Other Equipment Available
Call For Rates and Availability

RADIO RESOURCES
1-800-54-RADIO
1-800-547-2346
301-859-1500

Potomac AT-51 test set, barely used. Includes carrying case & many accessories, \$3500; Nems Clark 120E AM field strength meter, \$650. RF Specialties, 206-546-6546.

Want to Buy

Motorola R2001 or R2400 communications system analyzer. C Hoffman, 251 174th St #404, Miami Bch FL 33160.

Motorola R2001 or R2400 communications system analyzer. C Hoffman, 251-174 St, Ste 404, Miami Beach FL 33160.

Bird 4712 in-line wattmeter, 5 kW element, 1 5/8" line. L Maierhofer, 101 Armory Blvd, Lewisburg PA 17837. 717-523-3271.

GR Telephone CG-3 service instructions/schematic for counter-generator, buy or pay for copy. M Kaplan, Puget Snd, Naval Shipyard, Bremerton WA 98314. 206-476-7419.

McCurdy 14023 extended range audio meter, will consider other devices. J Beahn, 4001 Brandywine St NW, Washington DC 20016. 202-364-3868.

Used field intensity meter; Nems Clark 120 series or RCA WX series; Potomac FIM-21 or 41; used Delta Electronics Operating Impedance Bridge, OIB-1 or OIB-3. N Beatty, 2116 Osman Lane, Greenfield IN 46140. 317-326-3820.

Yamaha DX-27 synthesizer, FM pro model, programmable, MIDI compatible, excel cond, \$375. M Osborne WKSQ, POB 9494, Ellsworth ME 04605. 207-667-7573.

TRANSMITTERS

Want to Sell

Sparta 680 solid state exciter on 96.7 MHz, used one time, excel cond, \$1200. K Diebel, 1207 Louisa, Rayville LA 71269. 318-728-4915.

McMartin BF 25 kW FM, BO. J Stanford, 2228 Gravier, New Orleans LA 70119. 504-822-1945.

LEASING AVAILABLE
ON USED
TRANSMITTERS
AMERICAN BROADCAST
FINANCIAL CORPORATION
414-482-2638

Collins 831 D-1 FM 3 kW, excel cond, w/all access & tubes, \$6000. P Cahill, POB 400, Wanchese NC 27981. 919-473-3434.

RCA BTA-5T 5 kW AM, gd cond, BO. J Swett, 4025 Lugano Way, Flagstaff AZ 86004. 602-526-1975.

Collins 830F 10 kW FM on 98.5, BO. J Stanford, 2228 Gravier, New Orleans LA 70119. 504-822-1945.

Collins 3102-2 FM Exciter excel cond w/STL interface & extender, will tune to freq, \$2000. G Ogonowski, 213-465-3171.

Collins 820 D-1 AM, 1 kW, gd cond, inc all access & tubes, \$4000. P Cahill, POB 400, Wanchese NC 27981. 919-473-3434.

QEI 675 FM bdct exciter w/changeable freq & companion stereo gen, \$1695/both. B Mounjoy, POB 1240, Elizabethton TN 37644. 615-543-5649.

FM TRANSMITTERS

5kw 1968 RCA BTF- 5B
\$5000
5kw 1980 Sintronics SI-F-5
\$5000
10kw 1971 CCA 10000D
\$10,500
Optimod 8000A & STL's
also available
PMA Marketing
414-482-2638

Will trade 5 kW FM xmt for 2 to 3 kW FM xmt. J Strongquist, 2816 Haghers, Duluth MN 55811. 218-722-3017.

Harris FM 10H clean, working, w/w BX 15 exciter, BO/may trade. A Branch, Box 1979, Decatur GA 30031. 404-325-7847.

RCA BTA-521 on 1010 kHz; Collins 21E; Bird Wattwatcher, excel cond, \$10,000. S King, 1703 Avondale, Amarillo TX 79111. 806-355-9777.

Up To \$500
REWARD

For information leading to the purchase of used AM/FM Transmitters

- \$500 for most 20-30kW FM
- \$250 for late model FM's 5-20kW
- \$100 for any FM over 1kW & any AM newer than 1975

ARMSTRONG TRANSMITTER CORP.
5046 Smoral Road (315) 488-1269
Syracuse, NY FAX (315) 488-1365

RCA BTA-56, 15 yrs old, supr cond, stable ampliphase, 5 kW AM, \$10,000; Collins 21-E 5 kW AM, \$4500. Smokey, KMMK, 1703 Alondale, Amarillo TX 79106. 806-355-9777.

CCA FM 10 DS power supply; CCA FM 10 DS equip rack for exciter & power supply. T Barnes, KRIL, 2735 E 8th, Ste 45, Odessa TX 79761. 915-332-6870.

Collins 831 1 kW FM, hybrid exciter, 4 tubes, excel cond, w/manuals, \$7500. W Waldron, KSOS, Layton Hills Mall, Layton UT 84041. 601-546-1722.

Bauer 607A 1 kW w/660 exciter, needs work, complete gd spare xmt, BO. K Kushnir, Empire Comm, 2120 Bluebell Dr, Santa Rosa CA 95403. 707-545-8300.

CCA FM40E exciter, freq programmable, \$1600. M Maciejewski, WMUS, 3565 Green St, Muskegon MI 49441. 616-744-1671.

Rockwell Intl 528-0629-001 400 MHz RF amp, new, 60 W, uses 4631-S tube, less pwr supply but otherwise complete, \$50. J Cunningham, KEOR, Rt 2 Box 113B, Stonewall OK 74871. 405-265-4496.

Harris MS-15 exciter, \$2500; TTC X exciter, new, \$4500; TTC FM-300J solid state 300 W FM, new, \$7500; Sintronic 10 W solid state FM exciter, \$850. G Gaskey, KWHO, 261 Main, Ste 6, Weed CA 96094. 916-926-5946.

Harris FM3.5K exciter, on air, excel cond, one spare tube, spare semiconductor parts kits, SOLA constant voltage transformer built-in. J Beatty, WOKZ, 1070 Market Tower, 10 W Market St, Indianapolis IN 46204. 317-236-1040.

Versa-Count V-322 FM translator, 10 W output, tuned for 99.5 MHz input, 92.1 MHz output, AM code identifier built-in, uses F connector on receive input & N female on RF output, gd cond, \$1800. TX Valley Translator, 6903 Spring Garden Dr, San Antonio TX 78249. 512-696-5615.

Harris MW5A 10 yr old AM xmt, new spare final, mint cond, tuned to 1420 kHz, \$21000. H Connellan, WACT Radio, 3900 11th Ave, Tuscaloosa AL 35402. 205-349-3

TRANSMITTERS . . . WTS

Energy-Onix 25 kW excel cond avail in 90 days, 25 kW only 2 yrs use; Energy Onix FM xmt tuned to 100.7, ready to sell at a good price, new final tube included. J Bahr, 154 Guajalaca St Crown Hills, Rio Piedras PR 00924.

Bird Termaline 8745-677 20 kW water cooled dummy load w/3 1/8" EIA flange, \$750. G Liebisch, POB 29521, Raleigh NC 27626. 919-876-0674.

TTC XL-102 FM translators, BO; CSI 100 W amp, BO. Howells Audio, POB 6184, Kingman AZ 86402. 602-753-4915.

Collins 830-D 1000 W, in service w/spare parts, stereo gen to be replaced this month due to pwr increase, \$4500. J Anderson, WKCU, 2192 Hwy 72 East, Corinth MS 38834. 601-286-8451.

CCA FM-10D 10 W FM complete w/pwr supply, metering & instruction book, worked when removed, \$1000. R Franklin, Super Snd Slds, 211 Virginia, Norristown PA 19401. 215-277-7112.

Energy-Onix MK 15 FM, 15000 W, single phase pwr, 2 yrs old w/CSI EX 20F exciter tuned to your freq, \$20,000/BO. P Moore, KXFX, POB 2158, Santa Rosa CA 95405. 707-523-1369.



High performance at affordable prices.

- New front panel programmable composite STL's.
- New directly programmable FM composite receivers
- New options for synchronous boosters and translators
- New FM exciters, transmitters, amplifiers: 2W to 30kW
- Same old price, quality service and reliability

Bext, Inc.
739 Fifth Avenue.
San Diego, CA 92101
619-239-8462

Telex 229882 Fax 619-239-8474

RCA 10 kW BTA-10H PCB free, completely rewired, \$11,000. C Stone, 234 E Meadow, Eden NC 27288. 919-623-9966.

Harris MW-1 1 kW AM in excel cond, on 1300 kHz. M Ripley, KOZE, POB 936, Lewiston ID 83501. 208-743-2502.

Sintronc SI-F-5 5 kW FM w/10 W Sintronc exciter, used 5 yrs, exciter gd, xmt PA cavity needs work, on 103.5 MHz, you ship, BO. G Savoldi, WCOL, 195 E Broad, Columbus OH 43215. 614-221-7811.



ARMSTRONG TRANSMITTER

FINEST REBUILT TRANSMITTERS

We're the leading re-manufacturer of transmitters worldwide.

Transmitters are available:

- Tuned & Tested on YOUR Frequency
- Guaranteed and Installed
- Completely Re-manufactured
- Expedited Service available

Trade-Ins gladly accepted - WE DELIVER!
See your choice in transmitters WORKING in our huge new showroom BEFORE you take it home!

NO ONE ELSE OFFERS YOU THIS!
SEE & TEST IT ALL YOU WANT!

ARMSTRONG TRANSMITTER CORP.
5046 Smoral Road (315) 488-1269
Syracuse, NY FAX (315) 488-1365



Elcom Bauer 605C 5 kW FM, one tube, single phase, brand new, minor shipping damage, \$27,000/BO. V Michael, WHTO, 575A Montgomery Pike, S Williamsport PA 17701. 717-323-8200.

RCA 50 kW BTA-50H excel condition, PCB free, \$16,500. C Stone, 234 E Meadow, Eden NC 27288. 919-623-9966.

Bext Demos, sale, full warranty: 20W exciter & 500W amplifier. Bext, 619-239-8462, Fax: 619-239-8474.

LPB TX2-20, LA 2-20 complete carrier current system w/20W xmt, 20W linear amp, includes limiter board, T-8 power line interface, manuals, 600kHz, excel cond, \$900/BO. T Wood, 404-791-3782.

Want to Buy

250-1 kW amp to go w/TE3 exciter, 93.1 MHz, old but in gd cond. K Browall, Box 808, River-ton WY 82501. 307-856-2922.

Modulation transformer 300 to 1000 W, prefer multimatch type similar to CVM-5. C Iannace, 239 St John's Ave, Yonkers NY 10704. 914-476-2172.

AM transmitter 500 to 1000 W, will take old Gates, Collins, RCA. C Iannace, 239 St John's Ave, Yonkers NY 10704. 914-476-2172.

For standby 1 to 2.5 kW FM. B Stuart, 3015 Johnsonville Rd, Susanville CA 96130. 916-257-2121.

Translator any 10 W. J Strongquist, 2816 Haghers, Duluth MN 55811. 218-722-3017.

RCA BTE-10C schematic &/or service manual for exciter. J Woddell, 1412 Mohave, Parker AZ 85341. 602-669-2483.
FM 20 or 25 kW. E Moody, KUJEM, 216 N Main, Bentonville AR 72712. 501-273-9039.

TOP DOLLAR

For Your Old Transmitter, STL or Exciter!
Call for a quote
We arrange quick dismantling & removal
PCB's? No Problem Call Us.

ARMSTRONG TRANSMITTER CORP.
5046 Smoral Rd
Syracuse, NY
(315) 488-1269
FAX (315) 488-1365

RCA BTA 1S or similar AM xmt, for mission-ary radio station, gd cond. L Amstutz, 4526 Arlington, Fort Wayne IN 46807. 219-429-8366.

FM xmt, 250 W or less or FM RF amp w/100 W output, exciter/stereo gen not needed. M Ross, Box 550369-101, Dallas TX 75355. 214-348-2618.

AM, 2.5 kW in gd cond, will consider 5 kW. A Terry, WODY, Box 545, Bassett VA 24055. 703-629-5900.

FOR SALE

Harris FM-3, 5K w/MX-15 Exciter & SCA Gen & many spares, like new, 3-yr old. 1060' 6-1/8" Andrew rigid line, vgc, \$420/Section
ER1 antenna, 2-Bay. 200-Series Rototiller, like new.
Moseley STL PCL-606/C, excel.; 325' coax, 1-5/8" air line, like new.
Moseley MRC-1600 remote control, new w/full warranty.

PRICED TO SELL
(816)-635-5959

Any 40-200 W VHF or 1-2 kW UHF xmts, top prices, finders fees. J Worrall, 4618 Gabriel Dr, New Orleans LA 70127. 504-241-8634.

Harris/Collins 5 kW AM, must be in gd cond. R Merrill, WZKY, POB 2639, Gulfport MS 39505. 601-832-5111.

FM 3-5 kW, grounded grid, McMartin or CCA preferred. E Sutton, WOKI, 1900 Winston, Knoxville TN 37919. 615-531-2000.

Wanted late model 1 kW UHF LPTV xmt, close to VHS channel 43. J Bahr, 154 Guajalaca St Crown Hills, Rio Piedras PR 00924.

FM 500-1000 W w/wo exciter, stereo solid state preferred. L Maierhofer, 101 Armory Blvd, Lewisburg PA 17837. 717-523-3271.

WANTED

AM and FM Transmitters, all powers. Finders fee for locators. DON'T take the chance of not being paid, sell to the oldest broadcast supply house in Latin America.

GUARANTEE RADIO SUPPLY CO.
1314 Iturbide
LAREDO, TX 78040
(512) 722-3233
(512) 727-8458 (fax)

Spare parts for Gates BC-1T xmt & parts for Rust model OC and IC remote control units. Jim or Dale, WXEE, 304-436-4191.

3K or 6K xmt for Class A station, STL link, remote control, other related equipment. A Stevenson, 312-975-9682.

RCA BTA-1R or equiv AM 1 kW xmt. L Afflerbach, CTC Media, 5550 Sterrett Pl, Columbia MD 21044. 301-621-5045.

McMartin AM/FM xmt, any model, exciter or stereo modules. Goodrich Ent., 11435 Manderson, Omaha NE 68164. 402-493-1886.

McMartin older B-910 FM exciter. C Goodrich, 11435 Manderson, Omaha NE 68164. 402-493-1886.

TUBES

Want to Sell

Tubes, 1000's have receiving & amp number your looking for, some transmitter tubes too, \$2/most. A Branch, Box 1979, Decatur GA 30031. 404-325-7847.

Eimac 4CX1000A, new in box, \$500/BO. K Kushnir, Empire Comm, 2120 Bluebell Dr, Santa Rosa CA 95403. 707-545-8300.

Eimac 4-500 A's for AM McMartin xmt, 1000 hrs, \$150 per tube; tube transformer for 4-500 A tubes in McMartin 1 kW AM, new. T Noordyk, WSHN, POB 190, Fremont MI 49412. 616-924-4700.

ECONCO

Quality Rebuilt Tubes

Approximately 1/2 the Cost of New

Call for Our Price List
800-532-6626
916-662-7553
FAX 916-666-7760

Various inventory of electron tubes including (2) 813; 845; OD3; (2) IR5; (4) IT4; 885; (3) 6J7; 5R4; (5) 5AR4; (2) 5V4; (2) 6J5 & many more, \$2/ea. M Johnson, KGAL, POB 749, Albany OR 47321. 503-451-5425.

SUPER-GEN

This high-performance FM Stereo Generator has select-able pre-emphasis, overshoot-controlled lowpass filters, digital pilot/subcarrier syn-thesis and built-in overmod protection. CBS/NAB's "FMX" system is available as a plug-in option.

Inovonics
SANTA CRUZ, CA (408) 458-0552

Penta Labs Super Premium output tubes w/in-creased plate dissipation, new w/war, individually tested, KT88, \$18; EL34, \$9, quantity discounts avail. R Katz, Allegro Snd, 15015 Ventura, Cherman Oaks CA 91403. 818-377-5264.

ELECTRON TUBES

Partial List: 6623, 23791, TH150, 6425F, 5604, 6696, 6697, 5681, 5682, 5671, 7804, 3CX10, 000H3, 3CX20, 000H3, 4CX5000A, 4CX35, 000C

Vacuum Tube Industries, Inc.
1-800-528-5014

3CX1500A7, 4CX5000A, 6146B, 4CX2508, 4CX3000A & more. We carry large inventory all major brands, Eimac, Ampere, RCA, etc. Call Stew 1-800-842-1489.

Want to Buy

TUBE REBUILDING

FREELAND PRODUCTS

Since 1940
SAVE ABOUT 50%
-We buy dud tubes-

800-624-7626
504-893-1243
FAX 504-892-7323

REBUILT ELECTRON TUBES

Partial List: 6623, 23791, TH150, 6425F, 5604, 6696, 6697, 5681, 5682, 5671, 7804, 3CX10, 000H3, 3CX20, 000H3, 4CX5000A, 4CX35, 000C

Vacuum Tube Industries, Inc.
1-800-528-5014

Information on a 5736 power tube, maximum ratings, pin out, etc. D Kerl, WHHI, 3319 W Bellline Hwy, Madison WI 53713. 608-273-6919.

We buy electron tubes.
Contact us if you have any for sale.

PATH

507 Superior Ave.
Newport Beach CA 92663
714-722-6733

Tubes wanted, 6072/6072A, no RCA, need 1000 pieces. R Katz, Allegro Snd, 15015 Ventura, Sherman Oaks CA 91403. 818-377-5264.

TURNTABLES

Want to Sell

Technics SL1200 MK2 (2) less than 2 yrs old, gd cond, incl Audio-Technics cartridges, \$250/ea, \$400/both. G Elliot, POB 2288, Huntington WV 25701. 304-525-7788.

QRK 12" TT's (2) w/new motors, Rec-O-Kut arms, Ramko preamps, \$100/ea; complete, (2) Technics SP-10 Mk II TT's w/EPA-500 tonearms & Ramko preamps, w/walnut finished double insulated sandboxes, \$700/ea. J Swett, 4025 Lugano Way, Flagstaff AZ 86004. 602-526-1975.

Stanton 310B stereo phono preamp, brand new, BO. R Sundell, POB 734, Upland CA 91786. 714-985-0701.

Russco Studio Pro Model 1B (2) both w/Micro-Trak tone arms, \$200/ea. plus shpng. M Hagens, 1705 N Queensbury, Mesa AZ 85201. 602-962-7130.

Record recording amp for Presto cutter. A Weiner, 14 Prospect Dr, Yonkers NY 10705. 914-423-6638.

Sharp DX-100, Philips 212 & CCA CCA12-72. E Boucher, EAB Recdg, POB 958, Lewiston ME 04243. 207-786-3476.

Stanton 681EE calibration standard cartridge/stylus & (3) new D6800EE replacement stylus assemblies, new cond, \$75. D Zimmer, 3055 N Tyndall Ave, Tucson AZ 85719. 602-623-2933.

Technics SL-1200MK2 (2) stereo TT's w/needles/carts, perfect cond, \$600/both. B Coleman, POB 460, Lobelville TN 37097. 615-593-2978.

Gates 16" TT w/16" Micro-Track tone-arm, BO. J Sidote, POB 949, Welch WV 24801. 304-436-2131.

Want to Buy

RCA, Presto, etc. 16" disc recorders, & recording blanks any size, recording needles any type, pre-recorded discs. W Davies, 5548 Elmer Ave, N Hollywood CA 91601. 818-761-9831.

WE, RCA, others, arm pickups, TT's, recorders, amps, blank recording discs, literature, 16" transcriptions. R Van Dyke, Caffrey House, Squires Ave, E Quogue NY 11942. 516-728-9835.

Presto 6N cutter. A Weiner, 14 Prospect, Yonkers NY 10705. 914-423-6638.

TV FILM EQUIP

Want to Sell

Spindler-Sauppe S-32B used on multiplex-er, w/lens, mounting plate & manual, \$500/BO. P Wagenschein, Baylor University Division Telecom, 1218 S Third BU Box 7368, Waco TX 76798. 817-755-1511.

16mm interlock system, B&H mag/optical projector, (2) 16mm mag R/P, Selsyn drive system & racks, \$1500/BO. R Barwig, Barwig Recording, 5254 W Agatite, Chicago IL 60630. 312-283-2820.

B&H JAN 614 EVMS lightweight pedestal mount 16mm magnetic & optical sound tele-cine projector, complete w/manuals, vgc, \$425. G Ormrod, GFO Prod, 432 East X St, Turmwater WA 98801. 206-352-8028.

Want to Buy

35mm telecine projector east coast area. A Weiner, 14 Prospect, Yonkers NY 10705. 914-423-6638.

VIDEO PROD EQUIP

Want to Sell

Sony DR-10 intercom headsets, excel cond, TRS Connector, \$60/ea. D Haggadone, 1039 Jenne St, Grand Ledge MI 48837. 517-627-4537.

JVC CP-5000U 3 1/4" video player with RF out-put, \$595. B Hines, RD 1 Box 413A, Export PA 15632.

Otari EC-201 hand held time code reader, \$250. P Cibley, 138 E 38th, New York NY 10016. 212-986-2219.

TRANSCOM CORP.

Fine Used AM & FM Transmitters and Also New Equipment

For the best deals on Celwave products, Andrew cable, Shively & Comark antennas.

1983	Harris FM 2.5K
1980	Harris FM 20 K
1976	RCA BTF 20E1
1978	Collins 5 kW AM Power Rock, 828 E-1
1984	McMartin BF 3.5 K
1976	CCA AM 50,000D, 50 kW AM
1974	Harris BC 1H1
1972	Harris BC 10H, 10kW AM

201 Old York Rd.
York Plaza Ste 207
Jenkintown PA 19046
215-884-0888
FAX No. 215-884-0738

PETER DAHL CO.

Save \$\$

Heavy Duty Replacement Transformers, DC Filter chokes and capacitors for AM & FM transmitters manufactured by: AEL, CCA, CSI, COLLINS, CONTEL, CONTINENTAL, BAUER, GATES, GE, HARRIS, ITA, McMARTIN, RAYTHEON, RCA, SINGER, SINTRONIX, WILKINSON. Many other models also available.

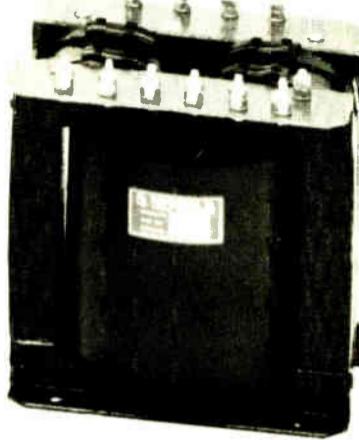

FAST Delivery and FREE Technical Support.



5869 WAYCROSS AVENUE EL PASO, TEXAS 79924
(915) 751-2300 TELEX: 76-3861 PWDCO
FAX: (915) 751-0768

Circle 30 On Reader Service Card

VIDEO PROD EQUIP . . . WTS

Quanta Microgen MG-100B SIO, 256 colors, 50 page memory, 9 speed rolls & crawls, RS-232 I/O port, character edging & much more, \$1595. B Hines, IPS, RD 1 Box 413A, Export PA 15632. 412-468-4115.

Quanta Microgen MG-100B title generator, 256 colors, 9 speed rolls/crawls, 50 page memory, auto page sequencing, character editing, line by line color, RS-232 I/O port for computer hook-up, excel cond, \$995. B Hines, RD 1 Box 413A, Export PA 15632. 412-468-4115.

Sony VCR-4 telecine adapter, high resolution uniplexer for film to video transfer, gd cond, \$50; Froehlich 190-300 stereo video control center-interconnect, (3) VCR's & (4) audio sources, lighted passive switches, audio volume control, \$75. W Watrous, 739 S Orange, Sarasota FL 34236. 813-366-3316.

Sony VO5850, VO5800, ECS 90, BVU-800, BVW15. M Mehalko, 201-361-1917.

Sony SL-HF300, Panasonic BT-S1300 & MIT 2000. E Boucher, EAB Recdg, POB 958, Lewiston ME 04243. 207-786-3476.

Sony AVC-3260DX B&W w/monitor viewfinder, \$100; JVC RM86U control trk editor/controller, \$850; Videotek KV1365 12" color video monitor, w/blue gun, \$250, plus shipping for each. M Holwin, Anamnesia Studios, 49 S Oxford, Brooklyn NY 11217. 718-852-7630.

3M 5110 & 5120 downstream keyer w/borders, outlines & matte generators for matte fills, BO. G Spiller, BES Teleproductions, 6829 E Altmore, Richmond VA 23225. 804-276-5110.

Sony FCG-700 frame code generator, new in box, \$1000; JVC LP-101 digital audio proc, \$1000. R Lawrence, Moonshadow Video, 4280 Reston, Roseburg OR 97470. 503-679-8966.

Sony PVM-8221, new 8" super fine pitch high resolution monitor, \$400. P Russell, Bowdoin College, Sills Hall, Brunswick ME 04011. 207-725-3066.

Laird/ICM VC 2000P video processor, \$800. D Hurd, Box 853 Station A, Searcy AR 72143. 501-279-4658.

Sony EVS-700V 8mm video/audio cassette recorders, gd cond. B Weiss, KJLA, 3435 Broadway, Kansas City MO 64111. 816-753-7707.

Custom Design remote studio. w/(2) JVC 110 cameras, control units, multi-core cable, Panasonic switcher, (3) B&W monitors, Shure mixer & much, \$10,000. M Bacon, 216-467-3037.

Quanta Microgen-100B-SIO video titler w/258 colors, 50 pg memory, 9 speed rolls, crawls, RS-232 I/O port, character edging & more, like new, \$1195/BO. B Hines, Rd 1 Box 413A, Export PA 15632.

VTA Wiz color correction computer for Bosch FDL-60 B2 telecine, BO; Nagra/Ampex VPR-5 1" portable VTR, new \$13,000; Stuart 8" floppy drive for Boxx/Alpha audio system, never used, \$2000. D Schlegel, SSI, 7155 Santa Monica, Los Angeles CA 90046. 213-874-9344.

Panasonic AG-A750 editing controller w/cables & instructions, mint cond, used 5 hrs, \$575. Chief Engr, Vidcom Consultants. 412-327-1333.

CBS 5500A color corrector, chroma keyer 7000, image enhancer 8000 MK III, plus 5500 sensor, BO. J Phillips, WZOM, 408 1/2 Clinton St, Defiance OH 43512. 419-784-1059.

Convergence Model CI-90 time code reader & burn in unit, excel cond, \$382. Chief Engr, Vidcom Consultants. 412-327-1333.

Zenith video projector w/10" motorized screen, Panasonic WV-F2 remote camera, \$5500. B Hull, WDX, POB 741, Mt A-ry NC 27030. 919-786-4675.

Panasonic Model WJ-810 time/date generator plus stop watch function, excel cond, \$250. Chief Engr, Vidcom Consultants. 412-327-1333.

Chyron IIIB w/all avail fonts, many discs, gd cond, in service, \$2000/BO. T Turk, Travis Turk Prod, 518 Macie Ct, Madison TN 37115. 615-255-7787.

VIDEO TAPE RECORDERS

Want to Sell

JVC CR4400U 3/4 port recorders (4) w/access, \$800 ea/BO; (3) Sony RM-430 edit controllers, \$500/BO; JVC BR-6400L VHS recorder, \$1500/BO. T Quinn, Monte Vista Sid, 208 Cherry, Capitola CA 95010. 408-475-0423.

Ampex 1" VPR-20 w/AC power supply, battery charger, case, \$16000. N Lindquist, POB 14920, Columbus OH 43214. 614-888-4788.

JVC CR-4700U 3/4" portable recorder w/AAP47U AC pwr supply/charger, (3) NiCads, custom case, (20) KCS-20 tapes, excel cond, \$1895. B Hines, IPS, RD 1 Box 413A, Export PA 15632. 412-468-4115.

Sony VO-2610 U-matic gd cond, \$600. A Alegria, 1380 Valley Forge, Lansdale PA 19446. 215-368-4444.

WORLDWIDE DIGITAL CONVERSION
ALL FORMATS
BROADCAST QUALITY
Pal Multi-dupe/Hi-Band/1"

TK VIDEO 12300 Coppola Drive
Potomac, MD 20854 301-782-2786

JVC 3/4" CR-6060U w/remote control, \$600. N Lindquist, POB 14920, Columbus OH 43214. 614-888-4788.

JVC editing system excel cond, low hrs, w/6650U player, 8650 recorder & RM 86U edit controller, cables & (2) NEC 12" color monitors, \$4250/BO. D Haggadone, 1039 Jenne St, Grand Ledge MI 48837. 517-627-4537.

RCA HR-Z, Panasonic AU-200, M-Format, bcdt quality, portable & editor, both excel cond, w/TBC, \$3500. D Lahey, 17094 McGuffie, Salinas CA 93907. 408-863-5192.

JVC CR6600 3/4" R/P, BC p/us shipping, M Holwin, Anamnesia Studios, 49 S Oxford, Brooklyn NY 11217. 718-852-7630.

Sony AV 3600 1/2" B/W R/R (2), \$200. D Hurd, Box 853 Station A, Searcy AR 72143. 501-279-4658.

Panasonic AG-6400 hi-fi VHS portable deck, (3) new batteries, charger, hard case, \$1600; Panasonic AG-1950 stereo hi-fi VHS edit system w/AG-95 edit controller, \$1600 or all for \$3000. R Lawrence, Moonshadow Video, 4280 Reston, Roseburg OR 97470. 503-679-8966.

Sony EV-S700U 8mm, PCM digital audio, low hrs, \$500. M Maciejewski, WMUS, 3565 Green St, Muskegon MI 49441. 616-744-1671.

Sony VO-2610 3/4" R/P, audio dub, excel cond, \$550; Sony VO-2600 3/4" R/P, audio dub, \$550. R Jensen, Racine Telecabin Corp, 5812 21st, Racine WI 53406. 414-632-3131.

Sony VO6800 remote 3/4" w/Porta Brace case, excel cond, \$1800. M Bacon, 216-467-3037.

Panasonic NV 3020 1/2" R/R (3), \$300. D Hurd, Box 853 Station A, Searcy AR 72143. 501-279-4658.

JVC 4400-LJ 3/4" portable deck, like new; (2) Sony 2860 3/4" decks w/RM-400 edit controller; (2) Sony SLO-323 Beta I industrial decks; RCA TR-22HB quad w/headwheel panel, 80. G Spiller, BES Teleproductions, 6829 E Altmore, Richmond VA 23225. 804-276-5110.

JVC CR-850U (3) 3/4" broadcast recorders w/address t-k time code, have time code readers for machines but not in machines, \$6000/ea. A Baker, 804 E 38th St, Indianapolis IN 46205. 317-925-7371.

Sony VO-2610 3/4" R/P, audio dub, excel cond, BNC I/O, still adj, \$550. R Jensen, 5812 21st St, Racine WI 53406. 414-632-3131.

Sony BVU-110, gd cond, \$1000 ea: BV J-50, gd cond, \$600/ea; BK-112 time code generators, \$400/ea; blank tapes, all formats; Beta breakaway cables. Ugly George Satellite TV, 314 W 52nd St, Nyny 10019. 212-677-2200.

JVC CR6600U 3/4" recorder, feeder deck for JVC edit system, low hrs, nice shape, new drum, \$950. J Kreines, 5330 Kennedy Ave, Millbrook AL 36054. 205-285-6179.

Sony VO-2600 3/4" R/P, audio dub, excel cond, \$550. R Jensen, 5812 21st St, Racine WI 53406. 414-632-3131.

Sony VO-2610 3/4" R/P, w/RF pack \$500; Panasonic NV9100A 3/4" player, \$350; (2) Sony VO-2600 3/4" R/P, \$450/ea, plus \$25 shipping for ea item. N Mishaan, POB 335 Lynbrook NY 11563. 516-582-1338.

Want to Buy

Panasonic NV-9600 edit source deck. J Andrist, Box 273, Omak WA 98841. 509-826-3340.

RCA TR-4, Ampex VR-2000 to pick-up, East Coast area please. A Weiner, 14 Prospect Dr, Yonkers NY 10705. 914-423-6638.

Panasonic AG-7400A S-VHS portable; JVC BR5-410U dockable S-VHS recorder; S-VHS A Series editing system; 16:1 lens for JVC BY-110 camera w/rear controls. R Lawrence, Moonshadow Video, 4280 Reston, Roseburg OR 97470. 503-679-8966.

ACTION-GRAM

Equipment Listings

Radio World's Broadcast Equipment Exchange provides a FREE listing service for all broadcast and pro-sound end users. Simply send your listings to us, following the example below. Please indicate in which category you would like your listing to appear. Mail your listings to the address below. Thank you.

Please print and include all information:

Contact Name: _____

Title _____

Company/Station _____

Address: _____

City _____ State _____ Zip _____

Phone Number: _____

Brokers, dealers, manufacturers and other organizations who are not legitimate end users can participate in the Broadcast Equipment Exchange on a **paid** basis. Listings are available on a \$25/25 word basis. Call 1-800-336-3045 for details and complete display rates.

I would like to receive or continue receiving **Radio World** FREE each month. YES NO

Signature _____ Date _____

Please circle only one entry for each category:

I. Type of Firm

- D. Combination AM/FM station
- A. Commercial AM station
- B. Commercial FM station
- C. Educational FM station
- E. Network/group owner
- F. Recording studio
- G. TV station/teleprod facility
- H. Consultant/ind engineer
- I. Mfg, distributor or dealer
- J. Other _____

II. Job Function

- A. Ownership
- B. General management
- C. Engineering
- D. Programming/production
- E. News operations
- F. Other _____

WTS: WTB: Category: _____

Make: _____ Model #: _____

Brief Description: _____

Price: _____

WTS: WTB: Category: _____

Make: _____ Model #: _____

Brief Description: _____

Price: _____

WTS: WTB: Category: _____

Make: _____ Model #: _____

Brief Description: _____

Price: _____

Broadcast Equipment Exchange

703-998-7600 PO Box 1214 • Falls Church VA • 22041 FAX: 703-998-2966

WE SURPRISED OURSELVES!

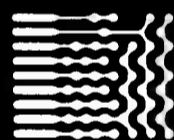

AUDIOARTS[®] A-50 RADIO CONSOLE!

We wanted to know if it really was possible to build a high quality low-cost radio console. We found the answer to be quite exciting! We've come out with the A-50 console and even given it its own trade name: AUDIOARTS. This console comes complete with machine control functions; individually programmable channel logic; program, audition and telephone outputs; control room and studio monitors; as well as headphone and cue power amplifiers. It's also designed so you can expand or add accessory modules as your needs grow.

The A-50 is cost effective through clever engineering and the latest advances in electronic assembly procedures. It was developed by the same design team that creates our other high end equipment. Its performance is light years beyond the competition.

Imagine the benefit that our major market experience can bring to your station. Take advantage of Wheatstone's expertise and reputation. Call us today for immediate action!

 Wheatstone[®] Corporation

6720 V.I.P. Parkway, Syracuse, NY 13211 (TEL 315-455-7740 /FAX 315-454-8104)

Circle 80 On Reader Service Card

World Radio History



Many of the headaches associated with building a new studio were eliminated with the WHEATSTONE pre-wire package. Set up and wiring of WAZU was a breeze. The furniture is solid and good looking, quick and easy to assemble—many hours were saved. Our jocks love the easy straight-forward layout of the new A-500 air console... and, after a quick and easy production room installation, little time was needed teaching the staff how to use the new multi-track studio; operators familiar with an on-air console adapt themselves easily to the SP-6 stereo console and the easy ways to insert special effects and audio processing—operation is so simple!"

John Soller, chief engineer at WAZU

Radio is Starting to Experience a Shortage: *Technical Experts*

Let our experts supply your prewired studio, consoles, studio furniture and audio system engineering. We'll help with your design, then build, wire, test and document your whole studio furniture installation—all at our factory. This takes a *major* load off your technical people and ensures project completion on time.

When Osborn Communications decided to upgrade member station WAZU in Dayton, Ohio, they chose WHEATSTONE for the job. With 12 rooms of Wheatstone consoles already installed, the Osborn people are well qualified to vouch for our commitment to client satisfaction.

Draw on our experience and reputation. Get a great looking studio with cutting edge performance. Contact WHEATSTONE—the experts!

 Wheatstone® Corporation

6720 V.I.P. Parkway, Syracuse, NY 13211 (TEL 315-455-7740 / FAX 315-454-8104)

Circle 101 On Reader Service Card

World Radio History